

MultiMeters | Clamp Meters | Thermometers | Airflow Meters
Light Meters | Sound Meters | Water Quality Testers | Thermal Imagers
Tachometers | Humidity & Moisture Meters

GENERAL
CATALOG37



YOUR SOURCE FOR
THE BEST
TEST &
MEASUREMENT
TOOLS ▶



A reputation built on the industry's best meters

Having been a part of Extech for over 25 years, I am amazed at the extraordinary growth Extech has experienced. We've achieved that by constantly striving to be the best in everything we do as a company.

Working with our trusted partners and distributors, Extech has defined a new category of test and measurement equipment: the best meters at the best value on the market. Extech tools deliver innovation, quality, rugged design, and precision measurements—with an unbeatable selection for every budget.

When Extech was acquired by FLIR Systems in late 2007, we became a part of a legendary company, the global leader in infrared cameras. Extech's test and measurement tools are a natural complement to FLIR's infrared cameras, offering you the Complete Solution: Find it with FLIR, Solve it with Extech.

Looking at back-to-back years of record growth, we thank our many, many customers around the world that discovered the best meters at the best value and said "Make Mine an Extech!". This catalog is filled with more innovative new products than ever, with exclusive features and functions no one else offers. You expect the best, now experience the Extech Advantage!

Arpineh Mullaney

*Vice President of Sales & Marketing
Extech Instruments Corp.,
a wholly owned subsidiary of FLIR Systems, Inc.*

Expect the



Discover the Company

Designed by Customers, Engineered by Extech

Extech engineers design innovative new products that combine features and functions our customers ask for, and no one else offers.

Best Equipped Inventory

Extech's warehouses deliver fast turnaround to the industry's best distributors, ensuring you get your meter fast.

Experience the Best Customer Support

We work hard to offer our customers a range of support options to ensure that we can respond effectively to your technical product questions, service concerns, and calibration needs. Live assistance is a phone call or email away.

Find Extech Around the World

Extech products are available world-wide through FLIR Systems and our trusted network of stocking distributors. Visit distributor.extech.com to find one near you.



Best

Experience the **Extech** Advantage



behind the Best Meters at the Best Value

U.S.-based Customer Support

Questions about your Extech meter's operation? Need service? Call us. Extech's helpful, US-based support teams strive to help you quickly and efficiently.

Customer Support

- support@extech.com
- 781-890-7440 x200

Comprehensive Calibration Services

For many professionals, calibration is as important as the meter. Our in-house calibration lab is focused on making your meter reliably accurate and conforming to NIST Certification standards.

Repair and Calibration

- repair@extech.com
- 781-890-7440 x210

Extech.com: Best Ranked Website

Extech's easy-to-use and information-packed website was ranked the top test and measurement website by Industrial Equipment News. See for yourself.



Our award-winning website is just one of the ways in which we provide exceptional support to our customers



Bestimonials



Extech Clamp Meters

"For alternative energy objects at SolarFest in Vermont, we used Extech's EX623 5-in-1 clamp meter to help get the most out of battery life. Being able to monitor AC and DC current with one tool is invaluable."

Bart B., Energy Efficiency Consultant

Experience the **Extech**
Advantage

The Source
for all your test and
Measurement needs

Leading the Way in Future Market Trends

Frost & Sullivan, a leading market research firm, forecasted “combinational testers” to be a key trend in the future of the test and measurement industry.

Frost & Sullivan Test & Measurement Briefing, February, 2009

Best Meters, Best Value



Extech MultiMeters

“I get into some very high voltage and Extech Instruments are dependable, especially if you’re putting your life on it. And, since I’m 58 years old, I especially like the large digital readout!”

Mike S., HVAC Professional, Shelton Mechanical



Extech Thermometers

“In emergency disaster and medical care situations, our Extech Type K thermometer was indispensable for safely storing and using vaccines, medications and food kept in our coolers”

John S, M.D., Grace Ministry



Discover Why Extech is the Brand Professionals Trust

Best Products

Extech garners more product awards than other test equipment manufacturers and is recognized worldwide by industry publications and professional trade organizations. More and more HVAC, electrical, industrial, environmental, water quality and MRO professionals made the switch and said “Make mine an Extech.”

Best Selection

No other test equipment manufacturer offers the breadth and depth of 15 product categories. You can count on Extech for all your test and measurement needs, and recommend Extech with confidence. Plus, Extech maintains stock availability around the world to ensure orders are fulfilled quickly and completely.

Best Value

Extech products are designed to deliver precision, durability, high quality, and affordability—a combination no other brand can match. Trade professionals are being pressed to do more with fewer budget dollars. Extech products ensure maximum functionality and no compromises—for less.

Best Service

When you buy an Extech, you’re getting a product from a company that stands behind its products. We are committed to delivering the most responsive US-based customer support to answer your technical questions and resolve your repair and return issues expediently.

MultiMeters, Clamp Meters, Thermometers, Humidity & Sound Meters, Water Quality Testers,

Introducing the Industry's **Best New Products**



Moisture Meter with built-in IR Thermometer



5-in-1 Clamp Meter



Wireless Circuit Detector for mid-run wires



Non-contact Current Tester

The Best Tools to Help You Go Green and Save Some Green

Only Extech offers such a wide range of test equipment to deliver high-accuracy readings of all key indicators to measure energy efficiency. Here are some of the ways professionals are using Extech tools to save energy and lower asset expenses:

- Evaluate motor efficiency
- Detect building envelope losses
- Troubleshoot HVAC/R airflow, humidity, and temperature issues
- Analyze power

- Monitor water quality in on-site treatment plants
- Identify electrical connections prone to failure
- Confirm moisture remediation is sufficient

Investing in high-efficiency equipment upgrades in your facility guarantees higher savings in the long run. Some organizations are focusing on ensuring existing equipment is running as efficiently as possible, optimized for energy savings and longevity. Either way, Extech tools enable proper predictive maintenance and accurate diagnostics to go green and save green.

*Airflow Meters, Light Meters,
Tachometers, Moisture Meters*



Wireless
Inspection
Camera

**Experience the *Extech*
Advantage[®]**



Fast Responding IR Thermometer



CO₂ Monitor



Industrial CAT IV MultiMeter + IR Thermometer

**Known for innovation
around the world**

Award after award, Extech meters have come to be recognized around the world and across industries as the market's best meters at the best value.



EXTECH[®]
INSTRUMENTS
A FLIR COMPANY

*Innovation-driven
Technology*

Designed with the end-user in mind
Unrivaled Selection

DMM
FEATURES

Make yours an Extech MultiMeter!

Use this selection guide to pick the right MultiMeter for your application. Choose from meters with CAT IV safety rating, multimeters with datalogging capability, models with PC interface, specialty multimeters with built-in InfraRed thermometers, and rugged waterproof industrial grade multimeters.



Model	EX570	EX540	MP510	MP530	EX520	EX530
Page	10	11	19		13	13
Key Features	<ul style="list-style-type: none"> Built-in non-contact IR Thermometer w/ Laser Splashproof and Dust Proof (IP64)) 	<ul style="list-style-type: none"> Wireless USB interface transmits readings to a PC Datalog up to 9,999 data points 	<ul style="list-style-type: none"> PC interface High Performance 		<ul style="list-style-type: none"> Waterproof Drop proof to 6 feet Large backlit LCD with bargraph 	
Features						
Basic Accuracy (VDC)	0.06%	0.06%	0.08%	0.08%	0.09%	0.06%
Display Counts	40,000	40,000	5000	5000	6000	40,000
True RMS	•	•		•	•	•
Temperature (Type K)	•	•		•	•	•
Temperature (IR)	•					
Capacitance	•	•	•	•	•	•
Frequency	•	•	•	•	•	•
Battery Test						
Duty Cycle	•	•			•	•
Autoranging	•	•	•	•	•	•
Backlit Display	•	•	•	•	•	•
Relative	•	•		•	•	•
Min/Max	•	•		•	•	•
Input Alert						
Category Rating	CAT IV 600V	CAT IV 600V	CAT IV 600V	CAT IV 600V	CAT IV 600V	CAT IV 600V

CATEGORY SAFETY RATINGS

CAT IV



Electrical devices connected to raw voltage distribution lines and/or located outdoors

CAT III



Fixed electrical devices located inside the building and protected by fuse box circuitry

CAT II



Devices connected to outlets that are at least 30ft away from CAT III or 60ft away from CAT IV sources

Built-in IR Thermometer 

EX400 Series



True RMS 

EX400 Series



Built-in NCV 

EX300 Series



Large Display Compact meter 

MN Series



										Model
EX470		EX411	EX430	EX310	EX320	EX330	MN15A	MN16A		
15		15		17			22		Page	
<ul style="list-style-type: none"> Built-in non-contact IR Thermometer w/ Laser 		<ul style="list-style-type: none"> True RMS 		<ul style="list-style-type: none"> Built-in non-contact AC Voltage Detector (NCV) Compact size 			<ul style="list-style-type: none"> Oversized LCD display Compact size 			
										Features
0.3%		0.3%	0.3%	0.5%	0.5%	0.5%	0.5%	0.5%	Basic Accuracy (VDC)	
4000		2000	4000	2000	2000	4000	2000	4000	Display Counts	
•		•	•						True RMS	
•		•	•				•	•	Temperature (Type K)	
•							•	•	Temperature (IR)	
•							•	•	Capacitance	
•							•	•	Frequency	
•				•				•	Battery Test	
•							•	•	Duty Cycle	
•							•	•	Autoranging	
•		•	•						Backlit Display	
•									•	Relative
Max only		Max only		Max only		Max only			Min/Max	
•		•	•						Input Alert	
CAT III 600V		CAT III 600V	CAT III 600V	CAT III 600V	CAT III 600V	CAT III 600V	CAT III 600V	CAT III 600V	Category Rating	

EX570 CAT IV Industrial MultiMeter + IR Thermometer

Built-in InfraRed Thermometer quickly identify overheating motors or locate hot spots on electrical panels and HVAC vents without contact

**BEST
IN CLASS**
NEW

Features:

- Patented built-in non-contact IR Thermometer design with laser pointer for locating hot spots
- True RMS CAT III-1000V, CAT IV-600V rated with 0.06% basic DCV accuracy
- Diode open circuit voltage of 2.8V DC
- Heavy duty Double molded, water resistant package
- Large backlit 40,000 count LCD with 40-segment bargraph
- Memory for storage and recall of three measurements
- 1000V input protection on all functions
- Type K thermocouple contact temperature measurements
- Features include Hold, Relative and Peak Hold
- Min, Max and Average recording
- Auto power off with disable feature
- Capacitance, Frequency, Diode and Continuity functions
- Complete with double molded test leads, magnetic hanging strap, Type K bead wire probe (-22 to 572°F/-30 to 300°C), and 9V battery



Built-in IR Thermometer quickly identifies hot spots on electrical panels.



Measuring the internal temperature on a 3-phase transformer installation



CAT IV application measuring voltage on a 480V 3-phase transformer



CAT IV

Patented

Specifications	
Functions	
Display Counts	40,000 count
Basic Accuracy	0.06%
DC/AC Voltage	0.01mV to 1000VDC/ 0.1mV to 1000VAC
DC/AC Current	0.01µA to 20A
Resistance	0.01Ω to 40MΩ
Capacitance	0.001nF to 10,000µF
Frequency	0.0001Hz to 40MHz
Temperature (Type K)	-50 to 1382°F (-45 to 750°C)
IR Temperature	-22 to 1022°F (-30 to 550°C)
Field of View	30:1 ratio
Duty Cycle	0.01 to 99.99%
Diode (2.8V)/Continuity	Yes
ETL/CE approved	Yes
Warranty	3 years
Dimensions	7.25x3.25x2.25" (184x83x57mm)
Weight	12.3oz (349g)

Ordering

EX570CAT IV Industrial MultiMeter + IR Thermometer

TL810Electrical Test Lead Kit (see p. 42)

EX570-NISTL* ..EX570 with Limited NIST Certificate

(*Limited NIST - Product certified to all functions except IR Thermometer)

EX540 MultiMeter/Datalogger with Wireless PC Interface **NEW**

CAT IV True RMS MultiMeter datalogs up to 9,999 readings with wireless USB interface capability to transmit readings to your PC in real time

Features:

- Real time datalogging or wireless data transmission directly to your PC (30ft/10m)
- True RMS measurements for accurate AC Voltage and Current measurements
- Diode open circuit voltage of 2.8V DC
- Double molded construction for waterproof (IP67) protection
- CAT IV-600V safety rating for industrial applications
- 1000V input protection on all functions
- Dual sensitivity frequency functions
- Large backlit triple LCD display
- Diode open circuit voltage of 2.8V DC
- Auto power off with disable feature
- Complete with double molded test leads, magnetic hanging strap, Type K bead wire temperature probe (-22 to 572°F/-30 to 300°C), remote receiver with USB cable, Windows® compatible software, 9V battery and carrying case



WIRELESS Transmitter



Continuous wireless data transmission from meter to your PC in real time



Drop-proof to 6 feet (1.8m). Meter is built tough with double molded housing.



Waterproof IP67 for the most extreme operating conditions.



Specifications	Functions	
	Display Counts	40,000 count
	Basic Accuracy	0.06%
	DC/AC Voltage	0.01mV to 1000VDC; 0.01mV to 1000VAC
	DC/AC Current	0.01A to 20A
	Resistance	0.01Ω to 40MΩ
	Capacitance	0.001nF to 40mF
	Frequency (electrical)	40Hz to 400Hz
	Frequency (electronic)	0.001Hz to 100MHz
	Temperature	-50 to 1382°F (-45 to 750°C)
	Duty Cycle	0.1 to 99.90%
	Diode (2.8V)/Continuity	Yes
	CE approved	Yes
	Dimensions	7.25x3.25x2.25"(184x83x57mm)
Weight	12.3oz (349g)	

Ordering

EX540True RMS MultiMeter/Datalogger with Wireless PC Interface (914MHz)

EX542True RMS MultiMeter/Datalogger with Wireless PC Interface (433MHz)

EX540-NIST.....EX540 with NIST Certificate

EX542-NIST.....EX542 with NIST Certificate

(NOTE: USA, Mexico, and Canada use 914MHz model and majority of other countries use 433MHz model)

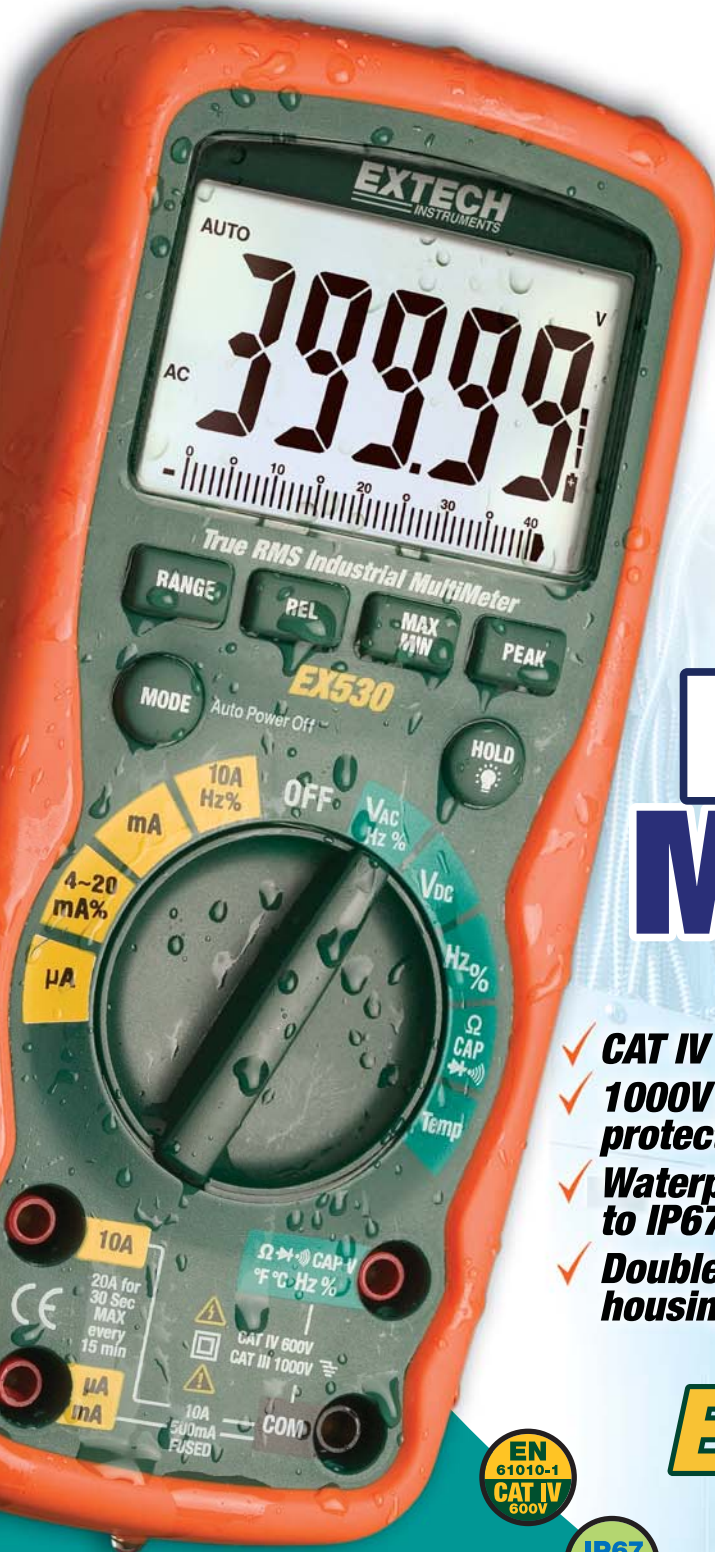

Waterproof IP67*
for the most extreme
operating conditions.



Drop-proof*
to 6 feet (1.8m). Meter is
built tough with double
molded housing.

Waterproof Industrial grade MultiMeters Built Tough!

- ✓ **CAT IV**
- ✓ **1000V input protection**
- ✓ **Waterproof to IP67**
- ✓ **Double molded housing**



EX500
Series
MultiMeters



Experience the **Extech**
Advantage

EX500 Series Heavy Duty Industrial MultiMeters



Waterproof (IP67) rugged double molded design for heavy duty use

Common Features:

- 1000V input protection on all functions
- Dual sensitivity frequency functions
- Diode open circuit voltage of 2.8V DC
- Auto power off with disable feature
- CAT IV-600V, CAT III-1000V
- Dimensions: 7.25x3.25x2.25" (184x83x57mm); Weight: 12.3oz (349g)
- Complete with double molded test leads, magnetic hanging strap, carrying case, one 9V battery, and Type K bead wire temperature probe (-22 to 572°F/-30 to 300°C) — not included with EX503

EX503 and True RMS EX505

- 4,000 count large backlit LCD
- 0.5% accuracy
- Data hold, Relative, and 10A max current

True RMS EX520

- 6000 count large backlit LCD with bargraph
- 0.09% accuracy
- Min/Max, Relative, Data Hold, 20A max current

True RMS EX530

- 40,000 count—highest resolution
- 0.06% accuracy
- Min/Max/Relative/Data Hold
- 20A max current
- bargraph
- Peak Hold



EX500 SERIES



Functions	EX503	EX505	EX520	EX530
Averaging/True RMS	Averaging	True RMS	True RMS	True RMS
Basic Accuracy	0.5%	0.5%	0.09%	0.06%
DC/AC Voltage	0.1mV to 1000VDC 0.1mV to 1000VAC	0.1mV to 1000VDC 0.1mV to 1000VAC	0.1mV to 1000VDC 1mV to 1000VAC	0.01mV to 1000VDC 0.01mV to 1000VAC
DC/AC Current	0.1µA to 10A	0.1µA to 10A	0.1µA to 20A	0.01µA to 20A
Resistance	0.1Ω to 40MΩ	0.1Ω to 40MΩ	0.1Ω to 60MΩ	0.01Ω to 40MΩ
Capacitance	0.01nF to 100µF	0.01nF to 100µF	0.01nF to 1000µF	0.001nF to 40mF
Frequency (electrical)	5Hz to 1kHz	5Hz to 1kHz	10Hz to 400Hz	40Hz to 400Hz
Frequency (electronic)	0.001Hz to 10MHz	0.001Hz to 10MHz	0.001Hz to 40MHz	0.001Hz to 100MHz
Temperature (Type K)	—	-4 to 1382°F (-20 to 750°C)	-50 to 1382°F (-45 to 750°C)	-50 to 1382°F (-45 to 750°C)
Duty Cycle	0.1 to 99.9%	0.1 to 99.9%	0.1 to 99.9%	0.1 to 99.90%
Diode (2.8V)/Continuity	Yes	Yes	Yes	Yes
UL/ETL/CE/FCC	UL/CE	UL/CE	UL/CE	UL/CE
Waterproof	IP67	IP67	IP67	IP67
Drop proof	6ft (1.8m)	6ft (1.8m)	6ft (1.8m)	6ft (1.8m)
Warranty	3 Years	3 Years	3 Years	3 Years



NIST Certified Meters

Our in-house calibration lab certifies Extech products to NIST standards. Meters with NIST certificates come complete with data. Our laboratory conforms to MIL STD 45662, ISO 17025, Guide 25, and ANSI/NCSL Z540-1-1994.

- EX503-NIST...EX503 with NIST Certification
- EX505-NIST...EX505 with NIST Certification
- EX520-NIST...EX520 with NIST Certification
- EX530-NIST...EX530 with NIST Certification

Accessories

- TL810Electrical Test Lead Kit (see p. 42)
- TP200Type K Clamp Probe (212°F/100°C)
- HG500Magnetic Hanging Strap

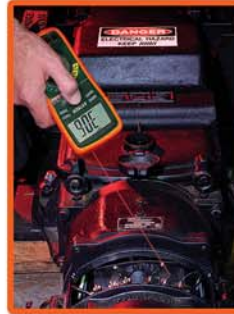
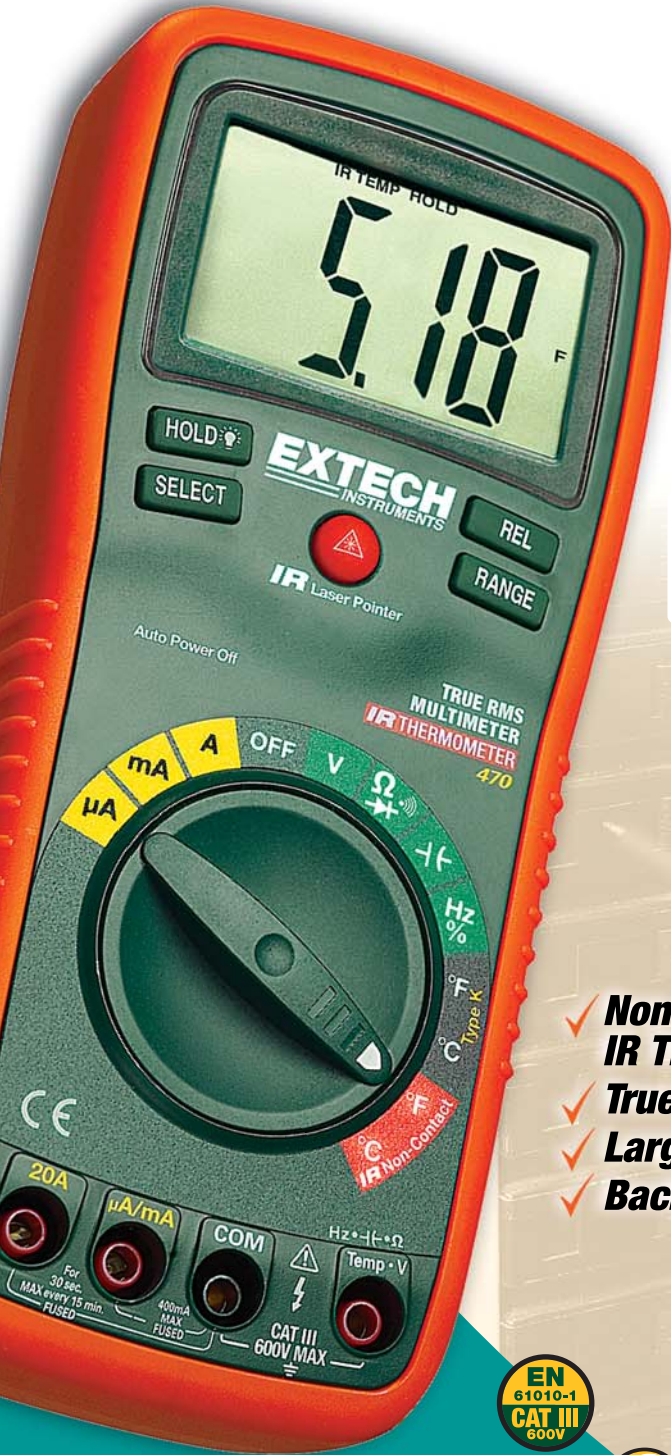

Built-in InfraRed Thermometer
Quickly identify overheating motors or locate hot spots on electrical panels and HVAC vents without contact.

True RMS
Only a True RMS meter can give you accurate readings of distorted waveforms

MultiMeters with Built-in InfraRed^{*} thermometer

- ✓ **Non-Contact IR Thermometer**
- ✓ **True RMS**
- ✓ **Large 1" Digits**
- ✓ **Backlighting**



EX400
Series
MultiMeters

*EX470 model only



Experience the Extech Advantage

EX400 Series Professional MultiMeters

Featuring models with built-in non-contact InfraRed Thermometer

Common Features:

- Large backlit LCD display with easy-to-read 1" digits
- Type K thermometer built-in for temperature measurements
- Low current capability: measure down to 0.1µA
- Input fuse protection and mis-connection warnings
- Dims: 7.4x3.2x2" (187x81x50mm)
Wt: 0.75lbs (342g)
- Complete with CAT III test leads, multi-position tilt stand and velcro strap for hanging, protective holster with test lead holder, Type K bead wire temperature probe (-22 to 572°F/-30 to 300°C), and 9V battery

Models EX410/EX411

- True RMS (EX411)
- Manual Ranging

Models EX420/EX430

- True RMS (EX430)
- Autoranging
- Capacitance
- Frequency

Model EX470

- Patented built-in non-contact IR Thermometer design with laser pointer
- True RMS
- Autoranging
- Capacitance
- Frequency
- Relative function

BUILT IN IR
Thermometer
Patented



EX400 SERIES



Functions	EX410	EX411	EX420	EX430	EX470
Averaging/True RMS	Averaging	True RMS	Averaging	True RMS	True RMS
Basic Accuracy (VDC)	±0.5%	±0.3%	±0.3%	±0.3%	±0.3%
AC Voltage	1mV to 750V	1mV to 750V	0.1mV to 750V	0.1mV to 750V	0.1mV to 750V
DC Voltage	0.1mV to 1000V	0.1mV to 1000V	0.1mV to 1000V	0.1mV to 1000V	0.1mV to 1000V
AC Current	0.1mA to 20A	0.1mA to 20A	0.1µA to 20A	0.1µA to 20A	0.1µA to 20A
DC Current	0.1µA to 20A	0.1µA to 20A	0.1µA to 20A	0.1µA to 20A	0.1µA to 20A
Resistance	0.1Ω to 20MΩ	0.1Ω to 20MΩ	0.1Ω to 40MΩ	0.1Ω to 40MΩ	0.1Ω to 40MΩ
Capacitance	—	—	0.01nF to 100µF	0.01nF to 100µF	0.01nF to 100µF
Frequency	—	—	0.001Hz to 10MHz	0.001Hz to 10MHz	0.001Hz to 10MHz
Temperature (IR)	—	—	—	—	-58 to 518°F (-50 to 270°C)
Temperature (Type K)	-4 to 1382°F (-20 to 750°C)	-4 to 1382°F (-20 to 750°C)	-4 to 1382°F (-20 to 750°C)	-4 to 1382°F (-20 to 750°C)	-4 to 1382°F (-20 to 750°C)
Duty Cycle	—	—	0.1% to 99.9%	0.1% to 99.9%	0.1% to 99.9%
Continuity / Diode	Yes	Yes	Yes	Yes	Yes
Category Rating	CAT III-600V CAT II-1000V	CAT III-600V CAT II-1000V	CAT III-600V CAT II-1000V	CAT III-600V CAT II-1000V	CAT III-600V CAT II-1000V
Warranty	1 year	1 year	1 year	3 years	3 years



NIST Certified Meters

Our in-house calibration lab certifies Extech products to NIST standards. Meters with NIST certificates come complete with data. Our laboratory conforms to MIL STD 45662, ISO 17025, Guide 25, and ANSI/NCCL Z540-1-1994.

- EX410-NISTEX410 MultiMeter w/NIST Cert
- EX411-NISTEX411 MultiMeter w/NIST Cert
- EX420-NISTEX420 MultiMeter w/NIST Cert
- EX430-NISTEX430 MultiMeter w/NIST Cert
- EX470-NIST*...EX470 MultiMeter w/NIST Cert

* Product certified to all functions except IR Thermometer

Accessories (see pg. 42-43)

- CA500Case with shoulder strap & side pockets
- TP873Replacement Bead wire Temperature Probe (-22 to 572°F/-30 to 300°C)
- HG500Magnetic Hanging Strap



CA500: Durable case with compartments for meter and test leads

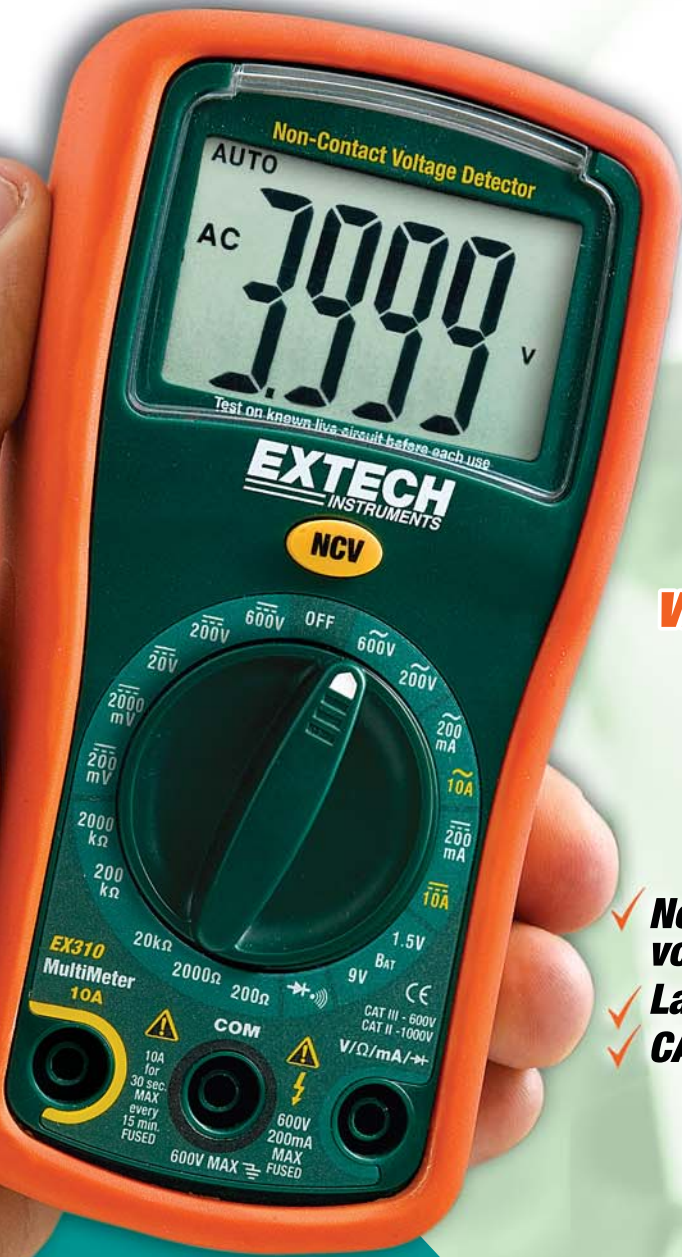

Autoranging
Automatically selects the optimum measurement range for accurate readings



Integrated Non-contact Voltage Detector
Quickly check for the presence of live wires *before* testing



Temperature function
Makes this multimeter a multi-function tester

MultiMeters with Built-in NCV Detector

- ✓ **Non-contact voltage detector**
- ✓ **Large 1" Digits**
- ✓ **CAT III-600V**

EX300
Series
MultiMeters



Experience the **Extech** Advantage

EX300 Series Mini Digital MultiMeters + Voltage Detector

Combination MultiMeter with non-contact AC Voltage Detector

Common Features:

- 0.5% basic accuracy
- Built-in non-contact AC Voltage Detector with red LED indicator and audible beeper
- Low battery indicator
- Large 1" digits makes display easy to read
- Dimensions: 5.7x2.9x1.6" (147x76x42mm); Weight: 9oz (260g)
- Complete with stand, test leads, protective holster, batteries, Type K bead wire temperature probe (-22 to 572°F/-30 to 300°C) (EX330 only)

Model EX310

- Manual Ranging
- Battery test 1.5V and 9V

Model EX320

- Autoranging
- Max Hold: captures highest reading
- Data Hold: freezes the display
- Auto Power Off: conserves battery life

Model EX330

- Autoranging
- Data Hold: freezes the display
- Auto Power Off: conserves battery life
- Type K Temperature °F/°C switchable
- Capacitance
- Frequency



EX300 SERIES



Model	EX310	EX320	EX330
Display Counts	2000 counts	2000 counts	4000 counts
Basic Accuracy	0.5%	0.5%	0.5%
Non-Contact Voltage Detector	100 to 600VAC	100 to 600VAC	100 to 600VAC
DC/AC Voltage	0.1mV to 600VDC 0.1V to 600VAC	0.1mV to 600VDC 0.1mV to 600VAC	0.1mV to 600VDC 0.1mV to 600VAC
DC/AC Current	0.1mA to 10A	0.1µA to 10A	0.1µA to 10A
Resistance	0.1Ω to 2000kΩ	0.1Ω to 20MΩ	0.1Ω to 40MΩ
Capacitance	—	—	0.001nF to 200µF
Frequency	—	—	0.001Hz to 10MHz
Temperature	—	—	-4 to 1382°F (-20 to 750°C)
Duty Cycle	—	—	0.1 to 99.9%
Diode/Continuity	Yes	Yes	Yes
Category Rating	CAT III-600V, CAT II-1000V	CAT III-600V, CAT II-1000V	CAT III-600V, CAT II-1000V
Battery Type	9V	2xAAA	2xAAA
Warranty	1 Year	1 Year	1 Year

NIST Certified Meters

Our in-house calibration lab certifies Extech products to NIST standards. Meters with NIST certificates come complete with data. Our laboratory conforms to MIL STD 45662, ISO 17025, Guide 25, and ANSI/NCSL Z540-1-1994.

- EX310-NISTEX310 MultiMeter w/NIST Cert
- EX320-NISTEX320 MultiMeter w/NIST Cert
- EX330-NISTEX330 MultiMeter w/NIST Cert

Accessories (see pg. 42-43)

- 409996Vinyl pouch carrying case
- TP873Replacement Bead wire Temperature Probe (-22 to 572°F/-30 to 300°C)
- TL803Replacement Test Leads





Precision MultiMeters

Choose the MultiMaster® CAT IV Series for high precision and repeatability and the MultiPro® Series for accuracy and functionality. All the meters have CAT IV safety rating and include PC interface.

Featuring Model MM570



- ▶ **CAT IV**
Highest safety rating, overload and fuse protected for industrial applications
- ▶ **Precision to 0.02%**
Highest accuracy in a handheld meter
- ▶ **500,000 Counts**
Highest resolution in a handheld meter
- ▶ **Splash-proof Housing**
Use the meter in even the harshest conditions
- ▶ **PC Interface**
Capture and analyze data



Accessories (See p.42-43 for Test Leads and Cases)



TL810: Electrical Test Lead Kit



TL805: Double Injected Test Leads



CA899: Soft Vinyl Pouch Case with Shoulder Strap



Optional PC Software

Accessories:

Software

SW800...MultiPro® Software Diskette and RS-232 Cable
SW810...MultiMaster® Software Diskette and Serial Cable

Test Leads, Probes, and Fuses

TL805...Spare set of CAT IV - 600V Test Leads
TL807...Set of Alligator Clips (2pk) for TL805
TL810...Electrical Test Lead Kit (see photo above)
TP873...Spare Bead Wire Temperature Probe (-22 to 572°F/-30 to 300°C)
FS880...Spare Fuse (2pk) for MP and MM560
FS881...Spare Fuse (2pk) for MM570

Carrying Case

CA899...Vinyl Pouch Case with Shoulder Strap

Order Meter with NIST Certificate*

All Extech meters come factory calibrated. For an additional charge, Extech will supply your meter with a Certificate of Calibration Traceable to N.I.S.T. with Data at multiple points.

To order meter with NIST:

- MP510-NIST
- MP530-NIST
- MM560-NIST
- MM570-NIST

*Only products listed are available with NIST Certificate. Meter must be ordered with NIST Certificate at time of purchase.

Specifications

- Model
- Display counts
- Averaging/True RMS
- DC/AC Voltage
- Basic DCV accuracy
- DC/AC Current
- Resistance
- Capacitance
- Frequency
- Temperature
- AC Bandwidth
- Category rating
- CE/UL Listed
- Dimensions/Weight
- Warranty



MP510/MP530 MultiPro® Series

High performance, True RMS (MP530) multimeters with RS-232 PC Interface

- ✓ MP530 with True RMS AC Voltage & Current, and Temperature functions plus Relative, Min, Max, Max-Min, Peak Hold and Zoom
- 0.08% basic DCV accuracy
- Auto power off with disable
- Hold and low resistance auto lead zero
- Optional SW800 PC software and cable sold separately
- Complete with built-in stand, test leads, protective holster, 9V battery, and Type K bead wire temperature probe (-22 to 572°F/-30 to 300°C) for MP530



MM560/MM570 MultiMaster® Series

50,000/500,000 count, high accuracy, wide bandwidth True RMS multimeters

- ✓ 0.02% (MM570) and 0.03% (MM560) basic DCV accuracy
- ✓ 50,000 count display with 500,000 counts for DCV and Hz
- ✓ True RMS combination AC+DC function
- ✓ Highest res. (1μV, 0.01μA, 0.0001Hz, 0.01Ω)
- Auto power off with disable
- ✓ **MM570** with dual input Type K Thermometer, higher True RMS ACV bandwidth (up to 100kHz) and 1000V input protection on all functions
- ✓ 4 to 20mA, displayed as 0 to 100% for process current measurements
- Optional SW810 (p. 18) PC software and cable
- Complete with stand, test leads, holster, 9V battery, and Type K probe (-22 to 572°F/-30 to 300°C) for MM570

MP510

5,000 count backlit
Averaging
0.01mV to 1000V
±0.08%rdg
0.1μA to 20A
0.01Ω to 50MΩ
0.01nF to 9999μF
10Hz to 125kHz
—
40Hz to 20kHz
CAT IV-600V
Yes
7.32x3.42x1.39" (186x87x35.5mm)/ 0.75lb (340g)
✓3 years

MP530

5,000 count backlit
✓True RMS
0.01mV to 1000V
±0.08%rdg
0.1μA to 20A
0.01Ω to 50MΩ
0.01nF to 9999μF
10Hz to 125kHz
-58 to 1832°F
-50 to 1000°C
40Hz to 20kHz
CAT IV-600V
Yes
7.32x3.42x1.39" (186x87x35.5mm)/ 0.75lb (340g)
✓3 years

MM560

50,000/500,000 count backlit
✓True RMS
0.001mV to 1000V
±0.03%rdg
0.01μA to 20A
0.01Ω to 50MΩ
0.01nF to 9999μF
5Hz to 200kHz (Line)/5Hz to 2MHz (Logic)
—
20Hz to 20kHz
CAT IV-600V
Yes
7.32x3.42x1.39" (186x87x35.5mm)/0.75lb (340g)
✓3 years

MM570

50,000/500,000 count backlit
✓True RMS
0.001mV to 1000V
±0.02%rdg
0.01μA to 20A
0.01Ω to 50MΩ
0.01nF to 9999μF
5Hz to 200kHz (Line)/5Hz to 2MHz (Logic)
-58 to 1832°F
-50 to 1000°C
20Hz to 100kHz
CAT IV-600V
Yes
7.32x3.42x1.39" (186x87x35.5mm)/0.75lb (340g)
✓3 years

MS420/MS460 20MHz and 60MHz 2-Channel Digital Oscilloscopes **NEW**

3.8" (96mm) color LCD display makes viewing multiple waveforms easy

Features:

- MS420 — 20MHz bandwidth
MS460 — 60MHz bandwidth
- Auto-set function optimizes the position, range, timebase, and triggering to assure a stable display of virtually any waveform
- Peak Detect function for 50ns glitch capture XY Mode
- Five Automatic Measurements: Frequency, Duty Cycle, Average, Peak to Peak, RMS
- Waveform Math: Add, Subtract, Multiply, and Divide
- Average Mode for smoothing waveforms
- Persistence Mode for observing dynamic signals
- Store and recall up to 4 waveform screens and setups
- USB interface and PC software for transferring waveforms and data

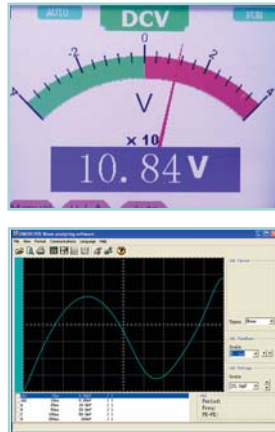

Complete with two 1X/10X oscilloscope probes, test leads, Windows® 95/98/NT/2000/ME/XP compatible USB software and cable, capacitor measuring module, adjustment screwdriver, AC adaptor/charger, and hard carrying case

Software PC screens display analog bargraph and graphical waveform

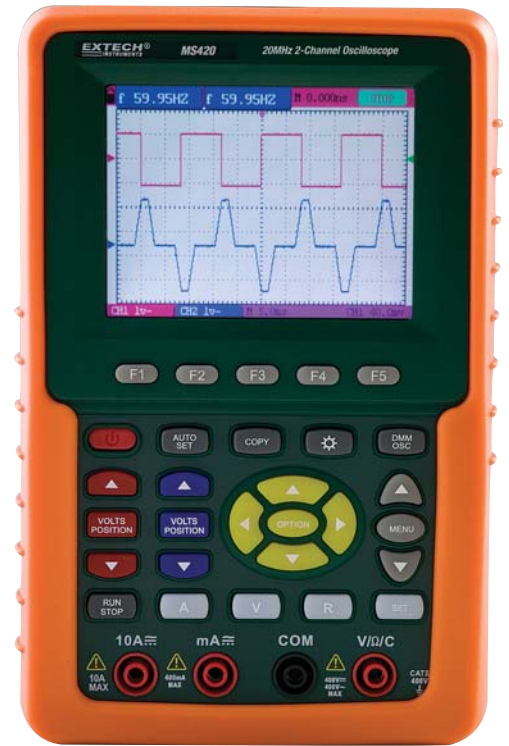

Specifications	
Oscilloscope Functions	
Display Size	3.8" (96mm) color LCD; 320 x 240 pixels
Bandwidth	20MHz (MS420); 60MHz (MS460)
Real time sample rate	100MS/s (MS420); 250MS/s (MS460)
Risetime	17.5ns
Channels	2
Record Length	6K points per channel
Glitch Capture	50ns
Vertical Sensitivity	5mV to 5V/div
Vertical Resolution	8 bits
Timebase Range	5ns to 5s/div
Sample Mode	Sample, Average, Peak Detect
Trigger Modes	Free Run, Single Shot, Edge, Video
Trigger Source	CH1, CH2
Trigger Coupling	AC, DC
Input impedance	1M Ω /20pF
Max Input Voltage	400V (peak)
Cursor Measurement	Voltage and time
True RMS MultiMeter Functions	
AC/DC Voltage	400mV, 4V, 40V, 400V
AC/DC Current	40mA, 300mA, 20A
Resistance	400 Ω , 4k Ω , 40k Ω , 400k Ω , 40M Ω
Capacitance	51.2nF to 100 μ F
Diode and Continuity	Yes
PC Interface	USB cable
Power Supply	6 hours Li-ion rechargeable battery; AC Adaptor/charger
CE	Yes
Warranty	1 year
Dimensions/Weight	7x4.4x1.6" (180x113x40mm) 24.3oz (690g)



Dual trace testing or troubleshooting of printed circuit boards and electronic assemblies

Ordering

- MS420.....20MHz Dual Channel MultiScope®
- MS460.....60MHz Dual Channel MultiScope®

381295A 5MHz Dual Channel MultiScope®

With 25MS/s dual channel sampling time (50MS/s single channel)

Features:

- Easy to use menu driven operation
- Internal or External Triggering
- Auto or Manual setup for horizontal and vertical scaling
- Roll mode for slow repetition waveforms
- Single shot mode
- Store and Recall up to 16 waveforms and setups
- 132 x 128 pixel Super-Twist two level backlit display
- PC interface with USB cable and software for transferring waveforms and data
- Data Hold and Low Battery indication
- MultiMeter functions include AC/DC Voltage, Resistance, Continuity, Frequency, RPM, Pulse Width, and % Duty Cycle



Windows® 95/98/NT/2000/ME/XP compatible software included.

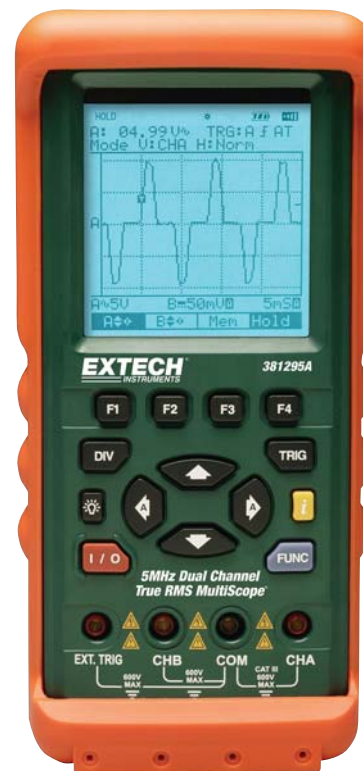

Specifications	
Oscilloscope Functions	
Bandwidth	5MHz
Max. Sample Rate	50MS/s (single channel); 25MS/s (dual channel)
Record Length	512 single shot; 256 all other modes
Sample Mode	Single shot, Roll, Normal
Max Vertical Sensitivity/Voltage	50mV/600VDC on AC
Trigger Modes	Auto, Normal, Single: AC or DC
Trigger Source	Channel A, Channel B, External
Timebase	1µS to 5S
MultiMeter Functions	
DC Voltage	0.1mV to 1000V (0.3% basic accuracy)
AC Voltage (TRMS)	0.1mV to 750V (50-20kHz bandwidth)
Resistance	0.001kΩ to 5MΩ
Frequency	0.01Hz to 5MHz
RPM	0 to 9999
Pulse Width	2µs to 500ms
Duty Cycle	25% to 75%
PC Interface	mini-plug to USB connection
Power	Li-Ion Battery/120V 60Hz adaptor/charger
Warranty	1 year warranty
Dimensions/Wt	7.7x3.5x1.6" (195x90x40mm)/ 16.2oz (260g)



Complete with meter, 4 test leads with alligator clips, protective holster, Li-Ion battery pack, Universal AC adaptor/ charger, USB cable, software, and case

Ordering

381295A5MHz Dual Channel MultiScope®

MC108 Digital Mini Microscope NEW

Compact device with TFT color display enlarges, measures and captures images up to 108x

Features:

- Capture images of objects as small as to 0.01mm with built in scale to measure dimensions of the object being enlarged
- 1.8" (46mm) TFT color LCD plus 2MB memory displays up to 60 320x240 JPEG images
- 7x to 108x magnification range
 - Optical Zoom: 7x to 27x
 - Digital Zoom: 4x
- Four white LEDs with adjustable brightness for object illumination
- 5 Image Effect modes: Normal, Gray, Inverse, Emboss, and Dual Window View
- Dual Window View simultaneously displays the magnified image next to the original image
- Real-time imaging on your PC screen via USB interface and included software
- Ideal for QC, Circuit board inspections, Printed materials, and Education
- Dims: 4.7 x 2.2 x 1" (120 x 56 x 25mm); Wt: 2.5oz (70g) without batteries
- Complete with stand, three AAA Ni-MH rechargeable batteries, 100 to 240VAC (50/60Hz) adaptor/charger, Windows® compatible software with mini USB cable, cleaning cloth, and wrist strap

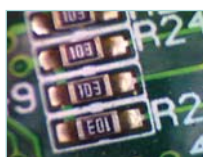

PC board inspection

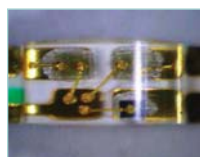

Soldering check

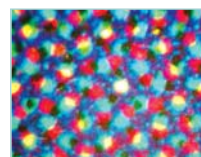

Analysis of printing



Dual window view simultaneously displays magnified image next to the original image

Ordering

MC108.....Mini Microscope

MN15A/MN16A Digital Mini MultiMeters

Compact Autoranging or Manual ranging multimeters

Features:

- Large easy to read digital display
- Type K temperature
- Complete with 9V battery (MN15A) or 2 AAA batteries (MN16A), Type K bead wire probe (-22 to 572°F/-30 to 300°C), and test leads

MN15A (Manual Ranging)

- 1.5V and 9V Battery tests under load

MN16A (Autoranging)

- Advanced functions include AC Current, Capacitance, and Frequency
- Auto power off with disable feature



Troubleshoot electronic and electrical equipment



MN15A

MN16A

Function	MN15A (Manual Ranging)	MN16A (Autoranging)	Basic Accuracy	
			MN15A	MN16A
DC Voltage	600V (0.1mV)	600V (0.1mV)	±0.5%	±0.5%
AC Voltage	600V (0.1V)	600V (0.1mV)	±1.2%	±1.2%
DC Current	10A (0.1mA)	10A (0.1µA)	±1.5%	±1.2%
AC Current	—	10A (0.1µA)	—	±1.5%
Resistance	20MΩ (0.1Ω)	40MΩ (0.1Ω)	±0.8%	±1.2%
Capacitance	—	100µF (0.001nF)	—	±3.0%
Frequency	—	10MHz (0.001Hz)	—	±1.0%
Temperature	-4 to 1400°F (-20 to 750°C)	-4 to 1400°F (-20 to 750°C)	±(3%rdg + 8 digits)	
Battery Test	9V & 1.5V Batteries	—		
Category rating	CAT III-600V	CAT III-600V		
Dims/ Wt	5.43x2.83x1.5" (138x72x38mm)/ 5.4oz (153g)			
CE/ETL/Warranty	CE/ETL/1 year	CE/ETL/1 year		

Specifications

Ordering

MN15A.....Manual Ranging MiniTec® MultiMeter with Temperature

MN16A.....Autoranging MiniTec® MultiMeter with Temperature

TP873.....Spare Type K Bead Wire Temperature Probe

(-22 to 572°F/-30 to 300°C)

409992.....Vinyl pouch carrying case

MN25/MN26T MiniTec® Digital MultiMeters

Rugged pocket design with 8 to 11 Functions

Features:

- CAT II-600V, CE & UL Listed
- Overload protection and indication
- 1.5V and 9V Battery tests under load
- 10A fuse protection
- Includes protective holster with stand, 9V battery and test leads

MN25 (Manual Ranging/ 8 Functions)

- 1.5V and 9V Battery tests under load

- 10A fuse protection

- Includes protective holster with stand, 9V battery and test leads

MN26T (Autoranging/ 11 Functions)

- Relative zero, Data Hold, Range Hold, Auto power off

- Includes holster with stand, Type K bead wire probe (-22 to 572°F/-30 to 300°C), two 1.5V AAA batteries, and test leads



Model MN26T displays AC Voltage of an outlet receptacle using autoranging function.



MN25

MN26T

Function	MN25 (Manual Ranging)	MN26T (Autoranging)	Basic Accuracy (MN25/MN26T)	
	Display Count	2000 count	4000 count	
DC Voltage	600V (0.1mV)	600V (0.1mV)	±0.5%	±1.0%
AC Voltage	600V (0.1V)	600V (0.1mV)	±1.5%	±1.5%
DC Current	10A (1µA)	10A (0.1µA)	±1.2%	±1.5%
AC Current	10A (1µA)	10A (0.1µA)	±1.8%	±1.8%
Resistance	2MΩ (0.1Ω)	40MΩ (0.1Ω)	±0.8%	±1.2%
Capacitance	—	200µF (0.001nF)	—	±3.5%
Frequency	—	10MHz (0.001Hz)	—	±1.5%
Temperature	—	0 to 1400°F (1°) 0 to 760°C (1°)	—	±3.0%
Duty Cycle	—	0.1% to 99.9% (0.1%)	—	±1.2%
Diode/Continuity	Yes	Yes		
Warranty	1 year			
Dimensions/Wt	4.8x2.4x1.6" (122x61x40mm)/ 9.17oz (260g)			

Specifications

Ordering

MN25.....Manual Ranging MiniTec® Digital MultiMeter

MN26T.....Autoranging MiniTec® Digital MultiMeter

TP873.....Spare Type K Bead Wire Temperature Probe

(-22 to 572°F/-30 to 300°C)

409992.....Vinyl pouch carrying case

DM220 CAT IV Pocket MultiMeter + NCV

Autoranging DMM with Non-Contact Voltage Detector and Built-in Flashlight

Features:

- Large 4000 count LCD display
- Non-Contact Voltage detection identifies live circuits
- Diode Test, Continuity, and Duty Cycle
- Rugged double molded housing
- Auto power off
- Built-in flashlight
- CE approved; CAT IV-600V, CAT III-1000V; 1 year warranty
- Complete with test leads and two AAA batteries



Built-in Non-Contact Voltage Detector. Red LED bar lights when live wire detected.



Function	Range	Max. Resolution	Basic Accuracy (%rdg)
DC/AC Voltage	600V	0.1mVDC/1mVAC	±0.5%DC/±1.2% AC
DC/AC Current	200mA	0.1µA	±2.0%DC/±2.5%AC
NC Voltage	100 to 600VAC		
Resistance	40MΩ	0.1Ω	±0.8%
Frequency	10kHz	0.001Hz	±2.0%
Capacitance	200µF	0.001nF	±5.0%
Dims/Wt	4.72x2.2x1.6" (120x55x40mm)/ 5.12oz (145g)		

Ordering

DM220Mini Pocket MultiMeter + NCV
409992Vinyl pouch case

DM110 Mini Pocket MultiMeter

Autoranging with 10 functions including Frequency, Capacitance, and Duty Cycle

Features:

- Large 4000 count LCD display
- Auto power off with disable feature
- Relative and Data Hold functions
- Built-in storage compartment for integrated test leads
- Over-range and low battery indication
- Designed to IEC1010, CAT II - 600V
- UL/CE approved; 1 year warranty
- Complete with test leads, protective holster, one CR2032 button battery and pouch case



Includes holster and pouch carrying case for added protection



Function	Range	Max. Resolution	Basic Accuracy (%rdg)
AC/DC Voltage	500V	1mV	AC: ±2.3%; DC: ±1.3%
AC/DC Current	400mA	0.01mA	AC: ±2.5%; DC: ±2.0%
Resistance	400 to 40MΩ	0.1Ω	±2.0%
Capacitance	100µF	0.001nF	±3.0%
Frequency	5Hz to 10MHz	0.001Hz	±2%
Duty Cycle	0.1% to 99.9%	0.1%	±1.2%
Diode/Continuity	Yes		
Dimensions/Wt	4.25 x 2.2 x 0.5" (108 x 56 x 11.5mm)/ 1.7oz (50g)		

Ordering

DM110Mini Pocket MultiMeter

381676 Pen DMM with Non-Contact Voltage Detector

Autoranging multimeter with rotary dial

Features:

- Non-Contact Voltage detection with visible and audible alarm
- Autoranging with Data Hold, Range Hold, and Maximum Hold features
- Overload and low battery indication
- Auto power off to conserve battery life
- Meets IEC1010-1; CAT III-600V, CE approved, 1 year warranty
- Complete with test lead with alligator clips, two 1.5V AAA batteries, and case



Function	Range	Max. Resolution	Basic Accuracy (%rdg)
Non-Contact Voltage	50 to 600VAC		
DC Voltage	200mV, 2, 20, 200, 600V	0.1mV	±0.7%
AC Voltage	200mV, 2, 20, 200, 600V	0.1mV	±0.8%
Resistance (Ω)	200, 2k, 20k, 200k, 2M, 20M	0.1Ω	±0.8%
Diode Test	1mA @ 1.5V approx		
Continuity Test	Audible beep <50 ohms		
Dims/Wt	8.2x1.5x1.1" (208x38x29mm)/ 3.9oz (110g)		

Ordering

381676Pen DMM w/ Non-Contact Voltage Detector



Built-in Non-Contact Voltage Detector automatically detects a live wire when the red LED is lit

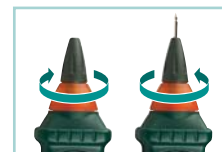

Retractable tip measuring DC/AC Voltage or for safe storage

TK430 Electrical Test Kit

Meets plant maintenance, HVAC or electrical technician's needs

Features:

- Assembled to provide all the electrical testing needs for installation and repair of electrical systems, HVAC equipment and large appliances
- Kit contains an EX430 True RMS autoranging digital multimeter, MA200 400A clamp meter, 40130 Non-Contact voltage detector plus test leads and temperature probe
- Supplied in a soft carrying case that provides protection and organization for the meters and accessories
- Dimensions: 9.5x6.8x2.8" (241x173x71mm); Weight: 2.6lbs (1.2kg)

Special Value Kit

Model EX430

Autoranging True RMS MultiMeter with 11 functions including Capacitance, Frequency and Temperature. (see p. 15)

Model MA200

400A Clamp Meter with basic AC Current and 1mA resolution. (see p. 34)

Model 40130

Non-Contact Voltage Detector detects AC Voltage from 100VAC to 600VAC without touching the source. (see p. 40)



Ordering

TK430Electrical Test Kit
480172AC Line Splitter

TK430-IR Industrial Troubleshooting Kit with IR

Meets plant maintenance, HVAC or electrical technician's needs

Features:

- Assembled to provide all the electrical testing needs for installation and repair of electrical systems, HVAC equipment and large appliances
- Non-contact InfraRed thermometer allows for quick surface temperature measurement
- Kit contains an EX430 True RMS autoranging digital multimeter, MA200 400A clamp meter, 42510 Mini IR Thermometer, 40130 Non-Contact voltage detector plus test leads and temperature probe
- Supplied in a heavy duty hard carrying case that provides protection and organization for the meters and accessories
- Dimensions: 14.5x11x4.5" (368x280x114mm); Weight: 4.5lbs (2kg)

Special Value Kit

Model EX430

Autoranging True RMS MultiMeter with 11 functions including Capacitance, Frequency and Temperature. (see p. 15)

Model MA200

400A Clamp Meter with basic AC Current and 1mA resolution. (see p. 34)

Model 42510

Wide range mini IR Thermometer measures -58 to 1000°F (-50 to 538°C). Built-in laser identifies target area; 8:1 distance to target ratio



Ordering

TK430-IR...Electrical Test Kit with IR

EX505-K Heavy Duty Industrial MultiMeter Kit **NEW**

CAT IV MultiMeter and AC Voltage Detector With 8 piece test lead kit

Features:

- Kit includes EX505 True RMS waterproof (IP67)/drop-proof MultiMeter, DV25 Dual Range Non-contact AC Voltage Detector + Flashlight, TL808 8-piece Professional Test Lead Kit, plus professional double-molded test leads, Type K thermocouple bead probe with banana input adaptor, and magnetic hanging strap
- Supplied in a soft carrying case that provides protection and organization for the meters and accessories
- Dimensions: 9.8x8x2" (248x203x51mm); Weight: 1.2lbs (544g)



TL808 Test Lead Kit included

Special Value Kit

Model EX505

Industrial grade, CAT IV-600V, 4000 count display, waterproof (IP67), CE/UL listed, drop-proof, rugged multimeter with True RMS functions. (see p. 13)

Model DV25

Dual Range Non-contact voltage detector (24 to 1000VAC/100 to 1000VAC) + Flashlight with Audible/ Visual indication, and double-

molded housing
CAT IV-1000V, CE/UL (see p. 41)

Model TL808

8-Piece Professional Test Lead Kit with CAT III-1000V rating

Ordering

EX505-K.....Heavy Duty Industrial MultiMeter Kit

MA620-K Industrial DMM/Clamp Meter Test Kit **NEW**

CAT IV MultiMeter and True RMS Clamp Meter with integrated AC Voltage Detector

Features:

- Kit contains EX505 rugged, waterproof multimeter with 11 functions, MA620 600A True RMS AC Clamp-on MultiMeter with built-in non-contact AC Voltage Detector, test leads and Type K thermocouple bead probe with banana input adaptor, and magnetic hanging strap
- Supplied in a soft carrying case that provides protection and organization for the meters and accessories
- Dimensions: 9.8x8x2" (248x203x54mm); Weight: 1.5lbs (680g)



Special Value Kit

Model EX505

Industrial grade, CAT IV-600V, 4000 count display, waterproof (IP67), CE/UL listed, drop-proof, rugged multimeter with True RMS functions. (see p. 13)

Model MA620

600A True RMS 6000 count AC Clamp-on MultiMeter with built-in non-contact AC Voltage Detector, test leads and temperature probe; CE/ETL approved (see p. 35)

Ordering

MA620-K.....Industrial DMM/Clamp Meter Test Kit



ALSO See Page 48 for Extech's Phase Rotation/ Clamp Meter Test Kit MA640-KIT

True RMS Clamp Meter with multimeter functions, 3-phase rotation tester, and CAT IV AC Voltage Detector. Ideal kit for plant maintenance.

CLAMP
FEATURES

Make yours an Extech Clamp Meter!

Choose the features and performance that best suit your needs: basic accuracy, maximum current, AC or DC and True RMS. Functions to consider are Non-contact temperature, Type K temperature, capacitance and μ A current. Features include inrush current, peak hold and auto power off.



Model	EX820	EX830	EX840	EX710	EX720	EX730	EX622	EX623	EX612	EX613
Page Number	31			33			29		29	
Key Features	<ul style="list-style-type: none"> Built-in non-contact InfraRed Thermometer Double molded housing Capacitance, Temperature, Peak Hold 			<ul style="list-style-type: none"> Inrush, Capacitance and Temperature AC, AC True RMS or AC/DC True RMS models 			<ul style="list-style-type: none"> Built-in non-contact InfraRed Thermometer Dual Type K inputs DC μA current Built-in NCV 		<ul style="list-style-type: none"> Dual Type K Thermocouple inputs DC μA current Built-in NCV 	
Features										
AC Current	1000A	1000A	1000A	800A	800A	800A	400A	400A	400A	400A
Counts	4000	4000	4000	4000	4000	4000	4000	4000	4000	4000
True RMS	•	•	•		•	•	•	•	•	•
Jaw Opening	1.7"			1.2"			1.4"		1.4"	
Basic ACA Accuracy	$\pm 2.5\%$	$\pm 2.5\%$	$\pm 2.5\%$	$\pm 2.8\%$	$\pm 2.5\%$	$\pm 2.5\%$	$\pm 1.5\%$		$\pm 1.5\%$	
DC Current		•	•		•			•		•
AC/DC Voltage	•	•	•	•	•	•	•	•	•	•
Resistance	•	•	•	•	•	•	•	•	•	•
Capacitance	•	•	•	•	•	•	•	•	•	•
Frequency	•	•	•	•	•	•	•	•	•	•
Temperature (Type K)	•	•	•		•	•	Dual Input	Dual Input	Dual Input	Dual Input
Temperature (IR)	•	•	•				•	•		
Diode	•	•	•	•	•	•	•	•	•	•
Continuity	•	•	•	•	•	•	•	•	•	•
Auto Power Off	•	•	•	•	•	•	•	•	•	•
Backlit Display	•	•	•	•	•	•	•	•	•	•
Min/Max	•	•	•				Max only		Max only	
Zero		•	•			•		•		•
Data Hold	•	•	•	•	•	•	•	•	•	•
Peak	•	•	•	•	•	•	•	•	•	•
Category Rating	CAT III 600V	CAT III 600V	CAT IV 600V	CAT III 600V	CAT III 600V	CAT III 600V	CAT III 600V	CAT III 600V	CAT III 600V	CAT III 600V

KEY FEATURES



BUILT-IN VOLTAGE DETECTOR

NCV Detector

Non-contact voltage detector quickly identifies the presence of voltage on live wires









Thermocouple Input

Instruments with single or dual thermocouple input for differential temperature measurement



BUILT-IN IR Thermometer

Non-contact InfraRed surface temperature measurement

 Best Value			Compact Size			 MA100 Series		 Mini Clamps			
											Model
MA410	MA620	MA640	MA200	MA220	MA250	MA120	MA150	380942	380941	380947	Model
35			34	34	35	38		36	37	37	Page Number
<ul style="list-style-type: none"> Built-in NCV Autoranging with MultiMeter functions AC or AC/DC models 			<ul style="list-style-type: none"> AC Current or AC/DC Current model Built-in NCV (MA250) 			<ul style="list-style-type: none"> Compact size Built-in AC Voltage Detector + flashlight 		<ul style="list-style-type: none"> Highest resolution and accuracy at low currents Compact size 			Key Features
400A	600A	600A	400A	400A	200A	400A	200A	30A	200A	400A	AC Current
4000	6000	6000	2000	4000	4000	2000	4000		4000		Counts
											True RMS
1.2"	1.5"	1.5"	0.9"	0.9"	1.2"	0.7"		0.9"			Jaw Opening
±2.5%	±2.8%	±2.8%	±2.5%	±3.0%	±2.5%	±3.0%	±3.0%	±1.5%	±1.0%	±1.5%	Basic ACA Accuracy
											DC Current
											AC/DC Voltage
											Resistance
											Capacitance
											Frequency
											Temperature (Type K)
											Temperature (IR)
											Diode
											Continuity
											Auto Power Off
											Backlit Display
											Min/Max
											Zero
											Data Hold
											Peak Category Rating
CAT III	CAT III	CAT III	CAT III	CAT III	CAT III	CAT II	CAT II	CAT III			
600V	600V	600V	600V	600V	600V	600V	600V	300V			



Dual Type-K Inputs
for taking differential temperature readings needed for superheat measurements.



Built-in IR Thermometer
for quick and safe non-contact temperature measurements — find hot spots fast!



Integrated Non-contact Voltage Detector
for quickly checking for the presence of live wires before testing.

All-in-one Clamps



NEW
EX600
Series
Clamp Meters

Checking AC Superheat

- ✓ **Differential Temperature**
- ✓ **Built-in IR Thermometer**
- ✓ **Built-in NCV Detector**
- ✓ **MicroAmp (μ A) Function for use in flame rod testing**

Experience the **Extech** Advantage



Patented

EX600 Series 400A Clamp Meters + Dual Type K Inputs + IR Thermometer

Dual thermocouple inputs for differential temperature measurement plus built-in IR Thermometer and Non-contact Voltage Detector

Common Features:

- True RMS measurements for accurate AC Voltage and Current measurements
- Dual type K thermocouple input with Differential Temperature function (T1, T2, T1-T2)
- Built-in non-contact Voltage detector with LED alert
- DC μ A multimeter function for HVAC flame rod Current measurements
- Diode open circuit voltage of 2.8V DC
- Data Hold plus fast Peak Hold of current surges during motor startup
- Measures motor capacitors to 40,000 μ F
- 1.25" (32mm) jaw opening for conductors up to 500MCM

- Rugged double molded housing
- Auto power off with audible alert and disable function
- Autoranging with manual override
- Dimensions: 9x3.1x1.9" (229x80x49mm); Weight: 10.7oz (303g)
- Complete with CAT III-600V, double molded test leads, 9V battery, two Type K bead wire probes (-22 to 572°F/-30 to 300°C), and carrying case

EX622 and EX623 Additional Feature

- Patented built-in non-contact IR Thermometer design with laser pointer for locating hot spots
- 8 to 1 distance to target ratio



Dual LCD displays:

- ACV+Hz
- ACA+Hz
- Hz+Duty Cycle,
- T1 and T2,
- T1-T2 and T1
- T1-T2 and T2

BUILT IN IR
Thermometer
Patented

EX600 SERIES



Model	EX612	EX613	EX622	EX623
AC Current	400.0A	400.0A	400.0A	400.0A
DC Current	—	✓ 400.0A	—	✓ 400.0A
Max resolution	10mA	10mA	10mA	10mA
Basic ACA accuracy	±1.5%	±1.5%	±1.5%	±1.5%
AC/DC Voltage (Max Res.)	600V (0.1mV)/600V (0.01mV)	600V (0.1mV)/600V (0.01mV)	600V (0.1mV)/600V (0.01mV)	600V (0.1mV)/600V (0.01mV)
DC μ A Current	4000 μ A (0.01 μ A)	4000 μ A (0.01 μ A)	4000 μ A (0.01 μ A)	4000 μ A (0.01 μ A)
Resistance (Max Res.)	40.000M Ω (0.01 Ω)	40.000M Ω (0.01 Ω)	40.000M Ω (0.01 Ω)	40.000M Ω (0.01 Ω)
Capacitance (Max Res.)	40mF (0.01nF)	40mF (0.01nF)	40mF (0.01nF)	40mF (0.01nF)
Frequency (Max Res.)	40MHz (0.001Hz)	40MHz (0.001Hz)	40MHz (0.001Hz)	40MHz (0.001Hz)
Temperature	-58 to 1832°F	-58 to 1832°F	-58 to 1832°F	-58 to 1832°F
(Type K-dual input)	(-50 to 1000°C)	(-50 to 1000°C)	(-50 to 1000°C)	(-50 to 1000°C)
Temperature (IR)	—	—	✓ -58 to 518°F (-50 to 270°C)	✓ -58 to 518°F (-50 to 270°C)
Diode (2.8V)/ Continuity	Yes	Yes	Yes	Yes
Duty Cycle	0.5 to 99.0%	0.5 to 99.0%	0.5 to 99.0%	0.5 to 99.0%
ETL/CE/Category Rating	ETL/CE/CAT III-600V	ETL/CE/CAT III-600V	ETL/CE/CAT III-600V	ETL/CE/CAT III-600V
Warranty	1 year	1 year	1 year	1 year

NIST Certified Meters

Our in-house calibration lab certifies Extech products to NIST standards. Meters with NIST certificates come complete with data. Our laboratory conforms to MIL STD 45662, ISO 17025, Guide 25, and ANSI/NCSL Z540-1-1994.

- EX612-NISTEX612 with NIST Certificate
- EX613-NISTEX613 with NIST Certificate
- EX622-NISTL*EX622 with NIST Certificate
- EX623-NISTL*EX623 with NIST Certificate

* Product certified to all functions except IR Thermometer

Accessories

- TP200Type K Pipe Clamp Probe (212°F/100°C)
- TP400Type K Pipe Clamp Probe (450°F/232°C)



TP200 Type K Pipe Clamp Probe for hands-free superheat/sub-cooling temperature measurement (max. 212°F/100°C) without the use of tape or Velcro®. TP400 model measures up to 450°F/232°C.





Double Molded Clamp Meters + IR Thermometer

Introducing Extech's Series of ergonomically designed Clamp Meters with rugged double molded housings. 1000A measuring capabilities plus True RMS, built-in InfraRed Thermometer, plus model with CAT IV safety rating.

Featuring Model EX840

▶ CAT IV Safety Rating

Assures maximum safety and functionality in hazardous industrial applications

▶ Non-Contact IR Thermometer

Built-in IR Thermometer with laser pointer to detect hot spots on motors and on electrical devices

▶ Double Molded Housing

Rugged housing is ergonomically designed and has better grip

▶ True RMS

Accurate AC Voltage and Current measurement regardless of waveforms



EX800 Series Patented

Professional Test Lead Set



BUILT IN IR
Thermometer



EX810 1000A AC Clamp Meter + IR Thermometer

Average responding AC clamp-on multimeter with built-in non-contact InfraRed Thermometer

- Patented built-in non-contact IR Thermometer design with laser pointer for locating hot spots
- Diode open circuit voltage of 2.8V DC
- Peak hold captures inrush currents and transients
- Features include Data Hold and Min/Max
- Auto Power off
- Complete with test leads, 9V battery, and case

Accessories:

TP873.....Replacement Bead wire Temperature probe (-22 to 572°F/-30 to 300°C)

TL803.....Replacement Test Leads

TL810.....Electrical Test Lead Kit

Order Meter with NIST Certificate*

All Extech meters come factory calibrated. For an additional charge, Extech will supply your meter complete with a Certificate of Calibration Traceable to N.I.S.T. with Data at multiple points.

To order meter with NIST:

- EX810-NISTL
- EX820-NISTL
- EX830-NISTL
- EX840-NISTL

*Only products listed are available with NIST Certificate. Meter must be ordered with NIST Certificate at time of purchase.

NISTL - Product certified to all functions except IR Thermometer

Specifications

Model	EX810
True RMS/Averaging	Averaging
Display counts	4000 count backlit LCD
Jaw size/Cable size	1.7" (43mm); 750MCM
AC Current	1000A
DC Current	—
Max resolution	0.1A
Basic ACA Accuracy (% rdg)	±2.8% (AC)
AC/DC Voltage (Max Res.)	600V (0.1mV)
Resistance (Max Res.)	40MΩ (0.1Ω)
Capacitance (Max Res.)	40mF (0.001nF)
Frequency (Max Res.)	4kHz (1Hz)
Temperature (Type K)	—
Temperature (IR)	-58 to 518°F (-50 to 270°C)
Diode (2.8V)/ Continuity	Yes
Category Rating	CAT III-600V
CE/UL	CE/UL
Dimensions/Weight	10.6x4.3x2" (270x110x50mm)/ 13.6oz (386g)
Warranty	1 year



EX820 1000A True RMS AC Clamp Meter + IR Thermometer

True RMS AC clamp-on multimeter gives you accurate readings of non-sinusoidal waveforms

- True RMS AC Voltage and Current measurements provide accurate readings regardless of waveforms
- Patented built-in non-contact IR Thermometer design with laser pointer for locating hot spots
- Diode open circuit voltage of 2.8V DC
- Peak hold captures inrush currents and transients
- Data Hold, Min/Max, and Auto Power off
- Complete with test leads, 9V battery, Type K probe (-22 to 572°F/-30 to 300°C), and case



EX830 1000A True RMS AC/DC Clamp Meter + IR Thermometer

True RMS AC clamp-on multimeter and DC Current function

- DC Current function to 1000A
- True RMS AC Voltage and Current measurements provide accurate readings regardless of waveforms
- Patented built-in non-contact IR Thermometer design with laser pointer for locating hot spots
- Diode open circuit voltage of 2.8V DC
- Peak hold captures inrush currents and transients
- Data Hold, Min/Max, and Auto Power off
- Complete with test leads, 9V battery, Type K probe (-22 to 572°F/-30 to 300°C), and case



BEST IN CLASS
NEW **CAT IV**



Includes 8-piece Professional Test Lead Set

EX840 CAT IV 1000A True RMS AC/DC Clamp Meter + IR Thermometer

CAT IV 600V approval rating assures maximum safety and functionality

- AC/DC Voltage measurement to 1000V and AC/DC Current to 1000A
- True RMS AC Voltage and Current measurements provide accurate readings regardless of waveforms
- Patented built-in non-contact IR Thermometer design with laser pointer
- Diode open circuit voltage of 2.8V DC
- Peak Hold, Data Hold, Min/Max, and Auto Power off
- Complete with CAT IV test leads, 9V battery, Professional test lead set, Type K probe (-22 to 572°F/-30 to 300°C), and case

EX820
True RMS
4000 count backlit LCD
1.7" (43mm); 750MCM
1000A
—
0.1A
±2.5% (AC)
600V (0.1mV)
40MΩ (0.1Ω)
40mF (0.001nF)
4kHz (1Hz)
-4 to 1400°F / -20 to 760°C
-58 to 518°F (-50 to 270°C)
Yes
CAT III-600V
CE/UL
10.6x4.3x2" (270x110x50mm)/ 13.6oz (386g)
1 year

EX830
True RMS
4000 count backlit LCD
1.7" (43mm); 750MCM
1000A
1000A
0.1A
±2.5% (AC); ±2.5% (DC)
600V (0.1mV)
40MΩ (0.1Ω)
40mF (0.001nF)
4kHz (1Hz)
-4 to 1400°F / -20 to 760°C
-58 to 518°F (-50 to 270°C)
Yes
CAT III-600V
CE/UL
10.6x4.3x2" (270x110x50mm)/ 13.6oz (386g)
1 year

EX840
True RMS
4000 count backlit LCD
1.7" (43mm); 750MCM
1000A
1000A
0.1A
±2.5% (AC); ±2.5% (DC)
1000V (0.1mV)
40MΩ (0.1Ω)
40mF (0.001nF)
4kHz (1Hz)
-4 to 1400°F / -20 to 760°C
-58 to 518°F (-50 to 270°C)
Yes
CAT IV-600V; CAT III-1000V
CE
10.6x4.3x2" (270x110x50mm)/ 13.6oz (386g)
3 years



Double Molded Clamp Meters

EX700 Series 800A Clamp Meters with rugged double molded housings, are ergonomically designed for one-hand operation and comfort. Select True RMS or averaging, DC Current, and Type K Temperature.

Featuring Model **EX730**

▶ True RMS

Accurate AC Voltage and Current measurement regardless of waveforms

▶ Fast Peak Hold

Captures inrush currents and transients

▶ Double Molded Housing

Rugged housing is ergonomically designed and has better grip

▶ High Temperature

Measures up to 1400°F (760°C) for wide range of applications



800A Full featured professional AC/DC Clamp Meter



480172 – AC Line Splitter fits clamp jaw size 0.75" (19mm) and above. It enables user of a clamp meter to measure AC Current on a 2-wire or 3-wire power cord to 15A (see p. 35 for details)

Accessories:

- 480172**.....AC Line Splitter (see p. 35)
- TL803**.....Replacement Test Leads
- TP873**.....Replacement Bead wire Temperature probe (-22 to 572°F/-30 to 300°C)

Order Meter with NIST Certificate*

All Extech meters come factory calibrated. For an additional charge, Extech will supply your meter complete with a Certificate of Calibration Traceable to N.I.S.T. with Data at multiple points. **To order meter with NIST:**

- EX710-NIST
- EX720-NIST
- EX730-NIST

*Only products listed are available with NIST Certificate. Meter must be ordered with NIST Certificate at time of purchase.

Specifications

Model
True RMS/Averaging
Display counts
Jaw size/Cable size
AC Current
DC Current
Max resolution
Basic ACA Accuracy (% rdg)
AC/DC Voltage (Max Res.)
Resistance (Max Res.)
Capacitance (Max Res.)
Frequency (Max Res.)
Temperature (Type K)
Category Rating
CE/UL
Dimensions/Weight
Warranty



EX710 800A AC Clamp Meter

Ergonomically designed in rugged double molded housing

- Data Hold and Auto power off
- Peak Hold for inrush currents
- AC/DC Voltage, Resistance, Capacitance, and Frequency
- Complete with test leads, 9V battery, and belt holster



EX720 800A True RMS AC Clamp Meter with Type K Temperature

True RMS clamp meter with Type K surface Temperature measurements

- ✓ True RMS
- ✓ Type K thermocouple temperature measures to 1400°F/760°C
- Data Hold and Auto power off
- Peak Hold for inrush currents
- AC/DC Voltage, Resistance, Capacitance, and Frequency
- Complete with test leads, 9V battery, Type K bead wire probe (-22 to 572°F/-30 to 300°C), and belt holster



EX730 800A True RMS AC/DC Clamp Meter with Type K Temperature

True RMS AC/DC Current clamp meter with Type K surface Temperature measurements

- ✓ DC Current with Zero function
- ✓ True RMS
- ✓ Type K thermocouple temperature measures to 1400°F/760°C
- Data Hold and Auto power off
- Peak Hold for inrush currents
- AC/DC Voltage, Resistance, Capacitance, and Frequency
- Complete with test leads, 9V battery, Type K bead wire probe (-22 to 572°F/-30 to 300°C), and belt holster

EX710

Averaging

4000 count backlit LCD
1.2" (30mm); 500MCM
40.00A, 400.0A, 800A

0.01A (AC)
±2.8%

600V (0.1mV)
40MΩ (0.1Ω)
40mF (0.001nF)
4kHz (1Hz)

CAT III-600V

CE/UL

9x3.1x1.9" (229x80x49mm) / 10.7oz (303g)
1 year

EX720

✓ True RMS

4000 count backlit LCD
1.2" (30mm); 500MCM
40.00A, 400.0A, 800A

0.01A (AC)
±2.5%

600V (0.1mV)
40MΩ (0.1Ω)
40mF (0.001nF)
4kHz (1Hz)

-4 to 1400°F / -20 to 760°C

CAT III-600V

CE/UL

9x3.1x1.9" (229x80x49mm) / 10.7oz (303g)
1 year

EX730

✓ True RMS

4000 count backlit LCD
1.2" (30mm); 500MCM
40.00A, 400.0A, 800A

✓ 40.00A, 400.0A, 800A
0.01A AC/0.1A DC
±2.8% (AC); ±2.5% (DC)

600V (0.1mV)
40MΩ (0.1Ω)
40mF (0.001nF)
4kHz (1Hz)

-4 to 1400°F / -20 to 760°C (EX720 and EX730 only)

CAT III-600V

CE/UL

9x3.1x1.9" (229x80x49mm) / 10.7oz (303g)
1 year



Clamp Meters

Extech's Clamp meters provide solutions to all your electrical needs from general AC electrical work to specialty projects that requires a built-in voltage detector function.

Featuring Model MA640

▶ AC/DC Measurements

For general purpose use

▶ Temperature

To measure operating temperature of motors and other electrical devices

▶ Capacitance

For checking motor starting capacitors

▶ Non-contact Voltage Detector

Built-in function offers convenient live voltage detection



Convenient built-in Non-contact Voltage Detector quickly detects presence of live wires before testing



Accessories

- 480172 ...AC Line Splitter
- TP873Bead wire probe (-22 to 572°F/-30 to 300°C)
- TL803Replacement Test Leads

Order Meter with NIST Certificate*

All Extech meters come factory calibrated. For an additional charge, Extech will supply your meter complete with a Certificate of Calibration Traceable to N.I.S.T. with Data at multiple points. **To order meter with NIST:**

- AM300-NIST
- MA200-NIST
- MA220-NIST
- MA250-NIST
- MA410-NIST
- MA620-NIST
- MA640-NIST

*Only products listed are available with NIST Certificate. Meter must be ordered with NIST Certificate at time of purchase.

Specifications

Model	AM300	MA200	MA220
Averaging/True RMS	Averaging	Averaging	Averaging
Display counts	Analog	2000 count LCD	4000 count LCD
Jaw size/Cable size	1.5" (38mm) 500MCM	0.9" (23mm); 300MCM	0.9" (23mm); 300MCM
AC Current	6,15, 60, 150, 300A (AC scale)	2,000A, 20,00A, 200.0, 400A	2,000A, 20,00A, 200.0, 400A
DC Current	—	—	2,000A, 20,00A, 200.0, 400A
Max resolution	—	0.001A (AC)	0.01A (AC); 0.01A (DC)
Basic ACA Accuracy (% rdg)	±3.0%FS	±2.5%	±3%
AC Voltage (Max Res.)	300V, 600V	600V (0.1mV)	600V (0.1mV)
DC Voltage (Max Res.)	75V	600V (0.1mV)	600V (0.1mV)
Resistance (Max Res.)	2kΩ	20MΩ (0.1Ω)	40MΩ (0.1Ω)
Capacitance (Max Res.)	—	—	100μF (0.01nF)
Frequency (Max Res.)	50 to 400Hz (ACA)	—	150kHz (0.001Hz)
Temperature	—	—	-58 to 1832°F (-50 to 1000°C)
Duty Cycle	—	—	0.5% to 99.0%
Diode/Continuity	—	Yes	Yes
Data Hold	Pointer Lock	Yes	Yes
Min/Max	—	Max	—
UL/ETL/CE/Category Rating	CE/CAT II-600V	UL/CE/CAT III-600V	UL/CE/CAT III-600V
Dimensions/Weight	9x2.8x1.5" (230x72x37mm)/14.5oz (416g)	7.9x2x1.4" (200x50x35mm)/7oz (200g)	7.9x2x1.4" (200x50x35mm)/7oz (200g)
Warranty	1 year	1 year	1 year



AM300 300A AC Analog Clamp Meter

Rotary Scale with Pointer Lock freezes the reading on the display

- Single function/range switch for easy one hand operation
- Jaw opens to 1.5" (38mm)
- AC/DC Voltage and Resistance measurement
- Pointer Lock function freezes the reading
- Zero adjust
- Complete with test leads, 1.5V battery and carrying case



MA200/MA220 400A Clamp Meters

Basic AC Current Meter or AC/DC model with 11 functions

- AC Current measurement
- Compact size allows measurements in tight locations
- Auto power off

MA220 Additional Features

- DC Current Measurement
- One touch "Auto Zero"
- Capacitance, Frequency, Temperature and Duty Cycle
- Complete with test leads, case and two AAA batteries. MA220 also comes with a Type K bead wire probe (-22 to 572°F/-30 to 300°C)



NEW

MA250 200A AC Clamp Meter + NCV

20A and 200A Current ranges plus built-in non-contact Voltage detector with LED alert

- 1.2" (30mm) jaw size for conductors up to 350MCM
- Relative Mode for Capacitance Zero, and Offset Adjustment
- Data Hold and MIN/MAX
- Auto Power Off
- Complete with test leads, Type K bead wire probe (-22 to 572°F/ -30 to 300°C), two AAA batteries, and carrying case



NEW

MA410 400A AC Clamp Meter + NCV

40A and 400A Current ranges plus built-in non-contact Voltage detector with LED alert

- 1.2" (30mm) jaw size for conductors up to 350MCM
- Relative Mode for Capacitance Zero, and Offset Adjustment
- Data Hold and MIN/MAX
- Auto Power Off
- Complete with test leads, Type K bead wire probe (-22 to 572°F/ -30 to 300°C), two AAA batteries, and carrying case



NEW

MA620/MA640 600A True RMS Clamps + NCV

True RMS for accurate readings of non-sinusoidal waveforms

- MA640 includes DC Current and Voltage functions
- 1.5" (40mm) jaw size for conductors up to 500MCM
- Backlit LCD with bargraph
- Relative Mode for Capacitance Zero and Offset Adjustment
- Data Hold, MIN/MAX, and Auto Power Off
- Complete with test leads, Type K bead wire probe (-22 to 572°F/ -30 to 300°C), 9V battery and carrying case

480172 AC Line Splitter



UL US LISTED

- Enables users of a clamp meter to measure AC current on a 2-wire or 3-wire power cord to 15A
- Fits clamp jaw size 0.75" (19mm) and above
- Provides easy and safe measurements of current without the need to separate the conductors
- Plugging the power connector into the Line Splitter separates the hot/live conductor from the neutral (and ground)
- Also features voltage check function
- Dimensions: 5.25x2x1" (133x51x25mm), Weight: 5.8oz (164.4g)

MA250	MA410	MA620	MA640	Model
Averaging	Averaging	True RMS	True RMS	Averaging/True RMS
4000 count LCD	4000 count LCD	6000 count LCD (backlit)	6000 count LCD (backlit)	Display counts
1.2" (30mm); 350MCM	1.2" (30mm); 350MCM	1.5" (40mm); 750MCM	1.5" (40mm); 750MCM	Jaw size/Cable size
20A, 200A	40A, 400A	60A, 600A	60A, 600A	AC Current
—	—	—	60A, 600A	DC Current
0.01A (AC)	0.01A (AC)	0.01A (AC); 0.01A (DC) for MA640	0.01A (AC); 0.01A (DC) for MA640	Max. resolution
±2.5%	±2.5%	±2.8%	±2.8%	Basic ACA Accuracy (% rdg)
600V (0.1mV)	600V (0.1mV)	600V (1mV)	600V (1mV)	AC Voltage (Max. Res.)
—	—	—	600V (1mV)	DC Voltage (Max. Res.)
40.00MΩ (0.1Ω)	40.00MΩ (0.1Ω)	60MΩ (0.1Ω)	60MΩ (0.1Ω)	Resistance (Max. Res.)
100μF (0.01nF)	100μF (0.01nF)	4000.0μF (0.01nF)	4000.0μF (0.01nF)	Capacitance (Max. Res.)
10kHz (1Hz)	10kHz (1Hz)	10kHz (0.001Hz)	10kHz (0.001Hz)	Frequency (Max. Res.)
-4 to 1400°F	-4 to 1400°F	-4 to 1400°F	-4 to 1400°F	Temperature
(-20 to 760°C)	(-20 to 760°C)	(-20 to 760°C)	(-20 to 760°C)	
0.1 to 99.9%	0.1 to 99.9%	0.1 to 99.9%	0.1 to 99.9%	Duty Cycle
Yes	Yes	Yes	Yes	Diode/Continuity
Yes	Yes	Yes	Yes	Data Hold
Min/Max	Min/Max	Min/Max	Min/Max	Min/Max
CE/CAT III-600V	ETL/CE/CAT III-600V	ETL/CE/CAT III-600V	ETL/CE/CAT III-600V	ETL/CE/Category Rating
7.9x2.6x1.5" (200x66x37mm)/ 7.2oz (205g)	7.9x2.6x1.5" (200x66x37mm)/ 7.2oz (205g)	9.1x3x1.5" (232x77x39mm)/ 9.6oz (271g)	9.1x3x1.5" (232x77x39mm)/ 9.6oz (271g)	Dimensions/Weight
1 year	1 year	1 year	1 year	Warranty



Mini Clamp Meters

Extech's Mini Clamp Meters, with their high resolution, are the ideal tools for accurately measuring very low AC & DC currents. Smaller in size than traditional clamp meters, they easily fit into tight spaces.

Featuring Model 380950

▶ High Resolution

0.001A (1mA) for low current applications

▶ AC/DC Current Measurements

For general purpose use

▶ Mini Jaw Size

0.5" (12mm) to fit into tight spaces

▶ DC Zero

Quick one touch DC zero



Extech Mini Clamp Meters designed with compact jaw size to fit into tight spaces. Models with High resolution and MultiMeter functions available.



Mini jaw size conveniently reaches into narrow spaces for taking Current and Voltage measurements

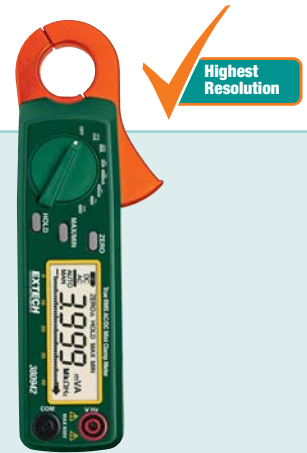

380942 30A Mini True RMS AC/DC Clamp to 0.1mA Resolution

Highest resolution and accuracy at low currents

- Low AC/DC Current measurements with high resolution to 0.1mA AC and 1mA DC
- Fast 40 segment bargraph
- One touch Auto Zero for DC Current measurements
- Auto power off with disable feature
- Complete with test leads, wrist strap, 2 AA batteries and case

Specifications

Model	380942
Averaging/True RMS	✓ True RMS
Display counts	4000 count LCD
Jaw size/ Cable size	0.9" (23mm); 4/0 AWG
AC Current	400mA, 4A, 30A
DC Current	4A, 30A
Max resolution	AC: 0.1mA, DC: 0.001A
Basic AC/DC Accuracy	±1.5%
AC/DC Voltage (Max. Res.)	AC: 400V (0.1V)/ DC: 400V (1V)
Resistance (Max Res.)	—
Frequency (Max Res.)	—
Continuity	—
Data Hold	Yes
Min/Max/Peak	Min/Max
Category Rating	CAT III-300V
UL/CE	UL/CE
Dimensions	7x1.8x1.3" (178x45x32mm)
Weight	8oz (225g)
Warranty	1 year

Accessories (See page 35 for details)

480172AC Line Splitter

Order Meter with NIST Certificate*

All Extech meters come factory calibrated. For an additional charge, Extech will supply your meter complete with a Certificate of Calibration Traceable to N.I.S.T. with Data at multiple points.

To order meter with NIST:

380942-NIST
380950-NIST
380941-NIST
380947-NIST

*Only products listed are available with NIST Certificate. Meter must be ordered with NIST Certificate at time of purchase.



380950 80A Mini AC/DC Clamp Meter

Small jaw size (0.5"/12mm) fits into tight spaces

- 1mA resolution
- Voltage, Resistance, Frequency and Duty Cycle measurement
- Auto power off
- CAT III-600V
- Complete with test leads, carrying case and 9V battery



380941 200A AC/DC Mini Clamp Meter

High resolution mini clamp with Voltage, Frequency, and Resistance

- High resolution to 10mA AC/DC
- Fast 40 segment bargraph
- One touch Auto Zero for DC Current measurements
- Complete with test leads, wrist strap, 2 AA batteries and carrying case



380947 400A True RMS AC/DC Mini Clamp Meter

True RMS mini-clamp with high 1mA AC current resolution

- Non-contact Frequency measurements to 10kHz through the clamp jaws
- Fast 40 segment bargraph
- One touch Auto Zero
- Complete with wrist strap, 2 AA batteries and carrying case

380950	380941	380947
Averaging	Averaging	✓ True RMS
4000 count LCD	4000 count LCD	4000 count LCD
0.5" (12mm); 3/0 AWG	0.9" (23mm); 4/0 AWG	0.9" (23mm); 4/0 AWG
4.000A, 80.0A	AC: 40A, 200A	4A, 40A
4A, 80A	DC: 40A, 200A	40A, 400A
1mA	0.01A AC/DC	AC: 0.001A, DC: 0.01A
±2.5%	±1.0%	AC: ±1.5%, DC: ±1.0%
600V (0.1mV)	400V (0.1V)	—
40MΩ (0.1Ω)	400Ω (0.1Ω)	—
10MHz (0.001Hz)	10kHz (0.01Hz)	10kHz (0.01Hz)
Yes	Yes	—
Yes	Yes	Yes
Max	Min/Max	Min/Max
CAT III-600V	CAT III-300V	CAT III-300V
CE	UL/CE	UL/CE
8.2x2.7x1.4" (210x70x37mm)	7x1.75x1.25" (178x45x32mm)	7x1.8x1.3" (178x45x32mm)
7oz (200g)	8oz (225g)	8oz (225g)
1 year	1 year	1 year



Specialty Clamp Meters

Our selection of clamp meters includes features such as True Power and Phase Indication that make these meters powerful and versatile troubleshooting tools.

Featuring Model 382400

▶ 3000A AC Current

High Current measurements

▶ Fast Peak Hold (30μs)

Captures inrush currents and transients

▶ True RMS

Accurate AC Voltage and Current measurement regardless of waveforms

▶ 24" (61cm) Flexible Probe

Easily wraps around bus bars and cable bundles



382400 includes 24" (61cm) flexible clamp

Order Meter with NIST Certificate*

All Extech meters come factory calibrated. For an additional charge, Extech will supply your meter with a Certificate of Calibration Traceable to N.I.S.T. with Data at multiple points. To order meter with NIST:
MA120-NIST
MA150-NIST
380976-NIST
380926-NIST
382400-NIST

*Only products listed are available with NIST Certificate. Meter must be ordered with NIST Certificate at time of purchase.



Non-contact Voltage detection via clamp tip

MA120 200A AC/DC Mini Clamp Meter+ Voltage Detector

Clamp meter with built-in AC Voltage detector + flashlight

- Non-contact AC Voltage detector via clamp tip
- Built-in white LED flashlight
- Auto power off
- Data Hold
- Complete with pouch case and two AAA batteries



Non-contact Voltage detection via clamp tip

MA150 200A AC Mini Clamp Meter+ Voltage Detector

Clamp meter with built-in AC Voltage detector + flashlight

- 600V AC/DC Voltage
- Resistance measurement
- Diode and Continuity test
- 200A AC Current
- Non-contact AC Voltage detector via clamp tip
- Built-in white LED flashlight
- Auto power off
- MAX Hold
- Complete with pouch case and two AAA batteries

Specifications

Model	MA120	MA150
True RMS/Averaging	Averaging	Averaging
Display counts	2000 count Backlit LCD	2000 count LCD
Jaw size/Cable size	0.7" (18mm); 300MCM	0.7" (18mm); 300MCM
AC Current	200A	200A
DC Current	200A	—
Max resolution	0.1A	0.1A
Basic ACA Accuracy (% rdg)	±3%	±3%
AC Voltage (Max Res.)	Non-contact	Non-contact/600V (0.1mV)
DC Voltage (Max Res.)	—	600V (0.1mV)
Resistance (Max Res.)	—	20MΩ (0.1Ω)
Capacitance (Max Res.)	—	—
Frequency (Max Res.)	1kHz (0.01Hz)	—
Temperature	—	—
Diode/Continuity	—	Yes
Data Hold	Yes	—
Min/Max/Peak	—	Max
Category Rating	CAT III-300V	CAT III-300V
UL/CE	CE	CE
Dimensions	6.5x2.6x1.3" (164x65x32mm)	6.5x2.6x1.3" (164x65x32mm)
Weight	6.2oz (176g)	6.2oz (176g)
Warranty	1 year	1 year



380976 1-Phase and 3-Phase 1000A AC Power Clamp Meter

Functions include Power, Current, Insulation Resistance, and Temperature (Type K)

- True Power, Apparent Power and Reactive Power, plus Horsepower, Power factor, and Phase Angle with Lead/Lag indicator (see p. 61 for details)
- AC+DC μ A Current with 10nA resolution for flame rod tests
- Auto power off with disable
- Complete with test leads, Type K bead wire probe (-58 to 482°F/-50 to 250°C), case, and 9V battery



380926 2000A AC/DC Clamp Meter

Full range MultiMeter functions with high resolution to 0.1 μ A/0.1mV and CAT IV-600V Safety Rating

- AC/DC Current via clamp with 0.1A resolution
- Large 2.36" jaw size fits 750MCM conductor size
- Data Hold
- Push button Zero adjust improves DC accuracy
- Complete with built-in stand, test leads and 9V battery



382400 3000A AC Flexible Clamp Meter

Flexible probe easily wraps around bus bars and cable bundles

- AC Voltage to 600V
- Fast Peak capture (30 μ s)
- Selectable frequency (50/60Hz)
- Max/Min
- Simultaneously displays Frequency with Current or Voltage
- Auto power off with disable feature
- Complete with 24" (61cm) flexible current probe, carrying case, and 2 AA batteries

380976	380926	382400	Model
✓ True RMS	✓ True RMS	✓ True RMS	True RMS/Averaging
9999 count LCD	5000 count Backlit LCD	4000 count LCD	Display counts
1.6" (40mm); 500MCM	2.36" (60mm); 750MCM	Flexible	Jaw size/ Cable size
100.0A, 1000.0A	400.0A, 2000A (Clamp); 400mA (DMM)	300.0A, 1000.0A, 3000A	AC Current
—	400.0A, 2000A (Clamp); 400mA (DMM)	—	DC Current
0.010A (Clamp); 0.01 μ A (DMM)	0.1A (Clamp); 0.1 μ A (DMM)	0.1A	Max. resolution
\pm 2% (Clamp), \pm 1% (DMM)	\pm 2%	\pm 1%	Basic ACA Accuracy (% rdg)
600V (0.1mV)	1000V (1mV)	600V (0.1V)	AC Voltage (Max Res.)
600V (0.1mV)	1000V (0.1mV)	—	DC Voltage (Max Res.)
100M Ω (0.1 Ω)	40M Ω (0.1 Ω)	—	Resistance (Max Res.)
7000 μ F (1nF)	50 μ F (10pF)	—	Capacitance (Max Res.)
1kHz (0.1Hz)	100kHz (0.001Hz)	45 to 65Hz (0.1Hz)	Frequency (Max Res.)
-58 to 1000°F (-50 to 900°C)	—	—	Temperature
Yes	Yes	—	Diode/Continuity
Yes	Yes	Yes	Data Hold
Min/Max	—	Yes	Min/Max/Peak
CAT III-600V	CAT IV-600V	CAT III-600V	Category Rating
UL/CE	CE	CE	UL/CE
9x3x1.6" (228x76x39mm)	10x2.9x1.5" (255x73x38mm)	5.1x3.1x1.7" (130x80x43mm)	Dimensions
16.4oz (465g)	14oz (380g)	15oz (430g)	Weight
1 year	1 year	1 year	Warranty



401050 AC/DC Voltage Detector

Non-contact and Contact detection of AC Voltage

- Contact AC Voltage from 70 to 250 VAC
- Non-contact AC Voltage from 70 to 600VAC
- Contact DC/Polarity Check from 1.5 to 36VDC
- Continuity Check from 0 to 5MΩ
- Self Test insures proper battery installation and battery life
- 1 year warranty; CE approved
- Dims: 5.6x0.6x0.6" (142.2x15.2x15.2mm)
Weight: 0.7oz (19.8g)
- Complete with two button batteries



40130 AC Voltage Detector

Non-contact detection of AC Voltage up to 600VAC

- Detects AC Voltage from 100V to 600V
- For use on 50/60Hz circuits
- Tip fits into outlets or against wire insulation
- Flashing red LED light and push button ON/OFF Audible beeper indicator
- Locate breaks in power cables
- CAT III-600V; CE approved, UL listed
- Dims: 6x0.75x1" (152x19x25mm)
Wt: 2oz (57g)
- Complete with pocket clip and two AAA batteries; 1 year warranty



DV20/DV24 AC Voltage Detectors+Flashlight

Rugged double molded housing

- Suitable for outlets or against wire insulation testing
- For use on 50/60Hz circuits
- Built-in bright flashlight
- CE approved, UL listed
- Dims: 6.25x1" (159x25mm)
Wt: 1.5oz (42g)
- Complete with two AAA batteries; 1 year warranty
- **Model DV20** - CAT III-600V; 100V to 600V AC Voltage
- **Model DV24** - CAT IV-1000V; 50V to 1000V AC Voltage



DV50 Telescoping AC Voltage Detector **NEW**

Detecting live AC Voltage with convenient telescoping probe for easy reach

- Non-Contact Detection of AC Voltage (5VAC to 1000VAC) helps locate potentially dangerous manhole covers and breaks in overhead lighting
- For 50/60Hz circuits
- Red and Green LED indicators and switch-controlled ON/OFF Audible beeper
- Sensitivity adjustment
- CAT IV-600V; CE approved
- Dims: 7.7x2.4x1.2" (195x62x30mm)
Wt: 5.2oz (148g)
- Complete with two LR44 button batteries



DA50 Telescoping AC Current Detector **NEW**

Telescoping probe offers convenient way in non-contact AC current detection

- Non-Contact Detection of AC Current (200mA to 1000A) through shielded wires, conduit, and metal circuit breaker
- For 50/60Hz circuits
- Red and Green LED indicators and switch-controlled ON/OFF Audible beeper
- Sensitivity adjustment
- CAT IV-600V; CE approved
- Dims: 7.7x2.4x1.2" (195x62x30mm)
Wt: 5.2oz (148g)
- Complete with two LR44 button batteries



DA30 Non-Contact Current Detector

Locates current in hidden wires and cables up to 1000A

- Detects AC Current (200mA to 1000A) through shielded wires, conduit, and metal circuit breaker or junction boxes
- Sensitivity adjustment
- Audible and visible indication
- CAT III-600V; CE approved; UL listed
- Dims: 5.7x1.1x1" (145x28x25mm)
Weight: 1.6oz (45g)
- Complete with pocket clip and four LR44 button batteries; 1 year warranty

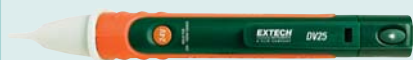

DV25 Dual Range AC Voltage Detector + Flashlight **NEW**

Two selectable ranges for low and high non-contact AC Voltage detection

- Two ranges: 24 to 1000VAC and 100 to 1000VAC
- For use on 50/60Hz circuits
- Tip fits into outlets or against wire insulation testing
- Audible and Visual voltage indication
- Built-in bright flashlight
- Compact size with pocket clip
- CAT IV-1000V; CE approved, UL listed
- Dims: 6.25 x 1" (159 x 25mm)
Wt: 1.48oz (42g)
- Complete with two AAA batteries



DV30 Adjustable AC Voltage Detector

Non-contact detection of AC Voltage to 12VAC with Sensitivity adjust

- Detects AC Voltage from 12V to 600V
- Sensitivity adjustment increases or reduces sensor trigger threshold
- Audible and visible voltage indication
- Self test function
- CAT III-600V; CE approved, UL listed
- Dims: 6.1x1.1x1" (155x28x25mm)
Wt: 1.5oz (42g)
- Complete with pocket clip and four LR44 button batteries; 1 year warranty



BUILT IN IR
Thermometer

Patent Pending

DV40 AC Voltage Detector + IR Thermometer **NEW**

Non-contact Voltage detector that measures non-contact temperature

- Detects AC Voltage from 50V to 1000V
- Built-in InfraRed Thermometer measures from -20 to 445°F (-30 to 230°C) with 0.1° resolution; 1:1 field of view; Fixed 0.95 emissivity covers
- Tip fits into outlets or against wire insulation
- Low battery indicator; Auto power off
- CAT III-1000V; CE approved, ETL listed
- Dims: 6.25x1" (159x25mm);
Wt: 1.48oz (42g)
- Complete with pocket clip and three LR44 batteries



DVA30 Non-Contact AC Voltage and Current Detector

Detects and pinpoints wide range Voltage and Current with Sensitivity adjust

- ✓ The only two-in-one AC Current (200mA to 1000A) and AC Voltage (12V to 600V) detector designed for electrical testing
- Loud audible and bright visible current and voltage detect indicators
- CAT III-600V; CE approved, UL listed
- Dims: 7.6x1.2x0.9" (192x31x24mm)
Weight: 2.1oz (60g)
- Complete with four LR44 button batteries and pocket clip; 1 year warranty

VT10 Multi-function Voltage Tester

Voltage, Continuity and Phase Tester with Flashlight;

- LED AC/DC voltage indication:
AC: 24, 48, 120, 208, 240, 277, 480, 600
DC: 6, 12, 24, 36, 48, 110, 220, 400
- Polarity detection with LEDs for positive and negative DC; Continuity beeper; low impedance; Double molded housing
- ✓ Phase rotation test for motors
- ✓ IEC1010-1 CAT IV 600V and CAT III 1000V safety rating, CE approved
- Dims: 9.4x3x1.6" (240x78x40mm)
Wt: 8.4oz (237g)
- Complete with 2 AAA batteries, protective cap, and pouch case; 1 year warranty



VT30 Digital Voltage Tester with Bargraph

Voltage, Continuity and Phase Tester with Flashlight and backlit digital display with bargraph

- ✓ Large backlit LCD displays AC Voltage (0 to 480V) and DC Voltage (0 to 690V)
- Polarity detection with LEDs for positive and negative DC; Continuity beeper; low impedance; Double molded housing
- ✓ Phase rotation test for motors
- ✓ IEC1010-1 CAT IV 600V and CAT III 1000V safety rating, CE approved
- Dims: 9.4x3x1.6" (240x78x40mm)
Wt: 8.4oz (237g)
- Complete with 2 AAA batteries, protective cap, and pouch case; 1 year warranty





TL810 Electrical Test Lead Kit

Double Insulated with CAT III-1000V Rating for your protection. Our 8 piece electrical test lead kit includes:

- Two 40" (1m) PVC lead extensions (1000V rating) with shrouded banana plugs on both ends
- Two very sharp, extra long 0.3" (7mm) stainless steel tipped plug-on test probes
- Two stainless steel flat tip test probes (0.6"/15mm long)
- Two plunger activated retractable jaw clips with a wide 0.75" (19mm) jaw opening



TL809 Electronic Test Lead Kit

Ideally suited for the testing of digital Circuitry, this 8-piece kit includes:

- Two 42" (1m) PVC lead extensions with shrouded banana plugs at both ends. CAT III-1000V rating, UL listed
- Two modular 4" (102mm) Heavy Duty test probe handles with 0.16" (4mm) banana plug tip, CAT III-1000V, UL listed
- Two plunger mini-hooks
- Two alligator clips with removable insulators
- Includes 3 compartment sealable nylon pouch to organize/protect your test leads



TL806/7 Alligator Clips

Choose the size of alligator clips for added convenience to your test leads

- **TL806** — Extra large, double insulated, CAT III-1000V clips mate with banana plug patch cords. Jaw opens to 0.8" (20mm) with sharp teeth for piercing insulated wire. IEC1010 compliant. Optional accessory to TL810 or TL809
- **TL807** — Alligator clips with insulated rubber boot fit onto test leads, CAT III-1000V. Compatible with TL805 (bottom left). **TL807C** fits TL803 leads

TL806Extra Large Alligator Clips
TL807Insulated Alligator Clips
TL807C..Insulated Alligator Clips



TL805 Double Injected Test Leads

Non-slip comfort grip

- Professional grade test leads. Double coated PVC lead wire with white inner layer to easily identify damaged leads. Heavy duty chromium plated brass tips. Shrouded, non-twist banana plugs for reduced socket wear. "Superflex" molded strain reliefs for improved cable flexibility. "D" shaped finger guards allow easy access to narrowly spaced test points. Compatible with most multimeters. 10A capacity. CAT IV-600V, CAT III-1000V rating.
- Optional accessory — Insulated Alligator Clip (TL807), shown above



TL803 Standard Test Leads

Protective tip covers provide safety storage

- Standard replacement test leads. Shrouded banana connectors, molded strain reliefs. Compatible with most multimeters. 10A capacity. CAT III-1000V rating. UL listed.
- Optional accessory — Insulated Alligator Clip (TL807C) shown above



TP870/3/5 Bead Wire Type K Temperature Probes

Use with a multimeter that has Type K temperature functions

- TP870** ..Bead wire with Type K connector (-40 to 482°F/-40 to 250°C)
- TP873** ..Bead wire with Type K connector and with banana adaptor (-22 to 572°F/-30 to 300°C)
- TP875** ..High Temperature bead wire probe w/Type K connector & banana adaptor; (-58 to 1000°F/-50 to 538°C)

(See p. 80 for Penetration/Surface Temperature Probes)

CA200 200A AC Clamp-on Adaptor

AC Current measurements,
no battery required

- 0.62" (16mm) clamp jaw
- 1mV AC output per Amp
- ±2% basic accuracy
- CAT II-600V, CAT III-300V; CE approved
- Dims: 4.3x1.9x1.3" (111x50x33mm)
Weight: 4.5 oz (129g)
- Complete with built-in 5.3ft (163cm) cable with banana plugs; one year warranty

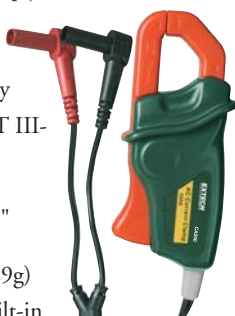

CA250 400A AC/DC Current Clamp Adaptor + NCV **NEW**

Built-in non-contact AC voltage detector

- 1.2" (30mm) clamp jaw
- Measures AC/DC Current in two ranges: 0 to 40A (10mV per Amp output) and 0 to 400A (1mV per Amp output)
- ±2.5% basic accuracy, CAT III-600V; CE approved
- DC zero adjust
- Optional CA250-NIST available
- Dims: 5.8x2.3x1.3" (146x60x32mm)
Weight: 8oz (226g)
- Complete with built-in 3.8ft (1.1m) cable with banana plugs and two AAA batteries; one year warranty



Carrying Cases

Protect and store your multimeters and accessories in a soft vinyl carrying case

- 409992Small carrying case
6.25x4.5x1" (159x114x25mm)
- 409996Medium carrying case
7.8x5.3x1.6" (197x133x41mm)
- 409997Large carrying case
9.5x7x2" (243x178x51mm)
- CA899Large case w/ shoulder strap 10x5x3" (254x127x76mm)
- CA500Case w/shoulder strap, side pockets 7.4x3.5x2.5" (188x89x64mm)
- CA900Wide carrying case for DMM Kits 9.8x8x2" (248x203x51mm)

CA500 dimensions do not include side pockets



409992

409996



409997

CA899



CA500

CA900

TP200 Type K Pipe Clamp Temperature Probe

Hands-free superheat/sub-cooling
temperature measurement without the
use of tape or Velcro®

- Spring-loaded jaw for secure grip on pipes; 0.25" (6.35mm) to 1.5" (38mm) diameter
- For use with any Thermometer or MultiMeter with a Type K input
- Measurement range: -4 to 200°F (-20 to 93°C)
- Basic accuracy of ±5%FS
- Complete with attached 36" (0.9m) cable and Type K connector



TP400 Type K High Temperature Pipe Clamp Probe **NEW**

Hands-free temperature measurement to
450°F without the use of tape or Velcro®

- Spring-loaded jaw for secure grip on pipes from 0.25" (6.35mm) to 1.5" (38mm) diameter
- For use with any Thermometer or MultiMeter with a Type K input
- Measurement range: -4 to 450°F (-20 to 232°C)
- Basic accuracy: ±3.6°F (1.8°C)
- Complete with attached 36" (0.9m) cable and Type K connector





TL841 Test Lead Kit

16-piece kit with multiple test lead tip configuration

- Test Lead Set with Straight Probes, CAT III-1000V, 16A
- Alligator Clip Set, 5A, CAT III-300V
- TL743 Slim Reach Test Probe Set
- Spade Lugs, 0.16" (4mm) opening, 30VAC/60VDC, 5A
- Test Leads, Right Angle and Straight End, CAT III-1000V, 16A
- Test Leads with Hook Tip, Pincer Tip, and Couplers
- Conveniently stored in a pouch case

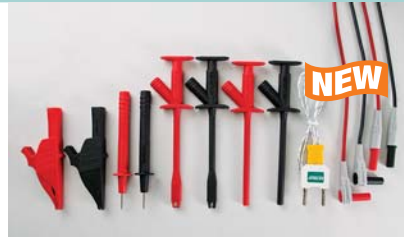

TL833 Industrial Test Lead Set

12-piece kit with CAT III-1000V rating

- TL726 Double Molded Silicone Test Leads
- TL740 Industrial Plunger Style Test Clips
- TL741 Heavy Duty Plunger Style Hook Clip Set
- TL708 Large Alligator Clip Set
- TL743 Slim Reach Test Probe Set
- TP873 Type K Bead Probe with Banana Adaptor
- Conveniently stored in a pouch case



TL831 Master Electrical Test Lead Kit

10-piece kit industrial grade test leads

- TL726 Double Molded Silicone Test Leads
- TL747 Electronic Sharp Test Probe Set
- TL741 Heavy Duty Plunger Style Hook Clip Set
- TL742 Heavy Duty Plunger Style Pincer Grip Set
- TL740 Industrial Plunger Style Test Clips
- TL708 Large Alligator Clip Set
- Conveniently stored in a pouch case



TL741 Heavy Duty Plunger Style Hook Clips

Spring loaded clip ideal for gripping component lead or wire

- 1000V, 10A
- 0.08" (2mm) gripping diameter
- 5.5" (140mm) overall length
- CAT IV-600V/3A max; CAT III-1000V



TL742 Heavy Duty Plunger Style Pincer Grip Set

Insulated, flexible silicon shaft with good heat resistance

- 1000V, 4A
- 0.2" (5mm) jaw opening
- 6" (152mm) overall length
- CAT IV-600V; CAT III-1000V



TL743 Slim Reach Test Probe Set

Sharp point for piercing insulation

- 1000V, 16A
- 0.7" (18mm) long tip with sharp 0.08" (2mm) diameter
- 4.5" (115mm) overall length
- CAT IV-600V/10A max; CAT III-1000V
- Includes protective cap



TL726 Double Molded Silicone Test Lead Set

Right angle and straight end flexible leads with shrouded banana plugs

- 63" (1.6m) long
- Protective collar and insulated sleeve
- 1000V, 10A
- CAT IV-600V; CAT III-1000V



TL708

TL709

TL708/TL709 Alligator Clip Sets

Toothed jaws for solid gripping of fine wires

TL708 Heavy Duty Large Alligator Clips

- 1000V, 6A, CAT IV-600V; CAT III-1000V
- 1" (26mm) jaw length; 1.6" (40mm) jaw opening; 4.2" (107mm) overall length

TL709 Medium Alligator Clips

- 1000V, 16A, CAT III-1000V
- 1.4" (37mm) jaw length; 0.4" (10mm) opening; 3.9" (98mm) overall length



TL740 Industrial Plunger Style Test Clip Set

Spring loaded clip with steel jaws

- 1000V, 10A
- 0.6" (15mm) jaw opening
- 6.1" (155mm) overall length
- CAT III-1000V



TL744 Flat Blade Test Probe Set

Designed to fit outlet receptacles

- 1000V, 10A
- 0.7" (17mm) long x 0.1" (2.5mm) flat tip
- 4.9" (124mm) overall length
- CAT IV-600V; CAT III-1000V



TL747 Electronic Sharp Test Probe Set

For use on high density components and boards and for piercing insulation

- 1000V, 10A max
- 0.35" (9mm) long tip with sharp 0.08" (2mm) diameter
- 4" (102mm) overall length
- CAT III-1000V



TL748 Spring Loaded Hook Tip Probes

Ideal for gripping a component lead or fine wire

- 1000V, 5A max
- 0.04" (1mm) gripping diameter
- 4.7" (120mm) overall length
- CAT IV-600V; CAT III-1000V

RT30/RT32 Wireless Remote AC Circuit Identifier **NEW**

Virtual electrician's helper remotely identifies and confirms correct circuit for mid-run wiring

WIRELESS
Transmitter



Features:

- Simplify mid-run wiring jobs by easily identifying the correct circuit powering the cable to be spliced or repaired
- The innovative RT30 combines non-contact voltage detection with wireless signals to monitor and remotely report the presence of voltage on a wire
- Clamped onto a live wire, the transmitter signals the user at the breaker panel with LED and audible alerts on the receiver (up to 100m range); The alerts stop when the correct circuit breaker is switched and work can then be performed safely
- Eliminates the need for an assistant or back-and-forth trips to confirm the correct circuit is powered down
- The RT30's clamp-style probe accessory is ideal for wires that are hard to isolate or reach
- Plus, easily identify lighting and outlet circuits with the built-in light sensor and the AC Outlet Extender accessory
- Includes transmitter, receiver, remote clamp-style probe, AC outlet extender, 4 "AAA" batteries and pouch case

FC Patent Pending

Ordering:

RT30Wireless AC Circuit Identifier (914MHz)

RT32Wireless AC Circuit Identifier (869MHz)

(NOTE: USA, Mexico, and Canada use 914MHz model and majority of other countries use 869MHz model)

Finding a Live Circuit by Detecting Voltage

The RT30 can be directly clamped on installed building wiring and will detect the voltage applied to the wiring. When voltage is present, the Voltage/Light LED on the Transmitter and Receiver will illuminate and an audible tone will be heard. When the voltage is removed (i.e. by opening the circuit breaker or splice), the Voltage/Light LED will go out and the audible tone will stop.

Finding a Live Circuit by Detecting Light

If access to circuit wiring is limited, the RT30 can also detect room lighting changes. Using the built-in light sensor, the Transmitter can be set to detect when lighting is on or off. When a

light is on, the Voltage/Light LED and audible tone is also on. When the light goes out (i.e. opening the circuit breaker or splice), the Voltage/Light LED will go out and the audible tone will stop.

1. Clamp the transmitter directly onto installed wiring to detect voltage.
2. The receiver alerts the user at the breaker panel with a voltage-present LED indicator and audible beep. Alerts cease when the right circuit breaker is switched off or a junction splice is opened in the circuit.
3. The compact, clamp-style probe accessory can be used on wires that are hard to

isolate or reach, or where the RT30 transmitter cannot fit.



CB10 Circuit Breaker Finder

3-in-1 tester to locate fuses, test receptacles and GFCI circuits

Features:

- Simply plug the GFCI Transmitter into an outlet and trace for the correct breaker at the electrical box
- Transmitter & Receiver snap together for storage
- UL Listed and CE Approved; 1yr warranty
- Dims/Wt: Receiver: 6.4x2.2x1.5" (162x55x38mm)/ 4oz (113g); Transmitter: 3.25x1.75x1" (83x44x25mm)/1.6oz (45g)
- Complete with one Receiver, one GFCI Transmitter, and 9V battery for the Receiver

GFCI Transmitter

- Tests GFCI circuits
- LED indication of 2 test conditions and 5 wiring faults
- Tests Reversed/Open Connections
- Lights indicate circuit condition



Adjustable sensitivity for pinpointing the correct breaker

Ordering

CB10Circuit Breaker Finder



CT40 16-Line Cable Identifier/Tester Kit

Troubleshoot electrical/electronic circuits and identify up to 16 local or installed lines

NEW

Features:

- CAT III-600V MultiMeter with 7 functions
- Transmitter/Receiver enables one person to remotely identify up to 16 wires
- Wire voltage check from 5 to 16VDC
- Data Hold, Max Hold, and Auto power off
- Low battery indicator (transmitter and receiver)
- Complete with 16-line Transmitter, MultiMeter/ Receiver, two 9V batteries, 2 AAA batteries, and case



Function	
MultiMeter	
Basic Accuracy	1.0% DCV
DC/AC Voltage	0.1mV to 600VDC/ 1mV to 600VAC
DC/AC Current	0.1µA to 200mA
Resistance	0.1Ω to 20MΩ
Diode/Continuity	Yes
Transmitter/Receiver	
Display	Two blue LED lamps (Transmitter) Two digit red LED display (Receiver)
Test Leads	17 alligator clips -16 red, 1 black (Transmitter) 2 alligator clips - 1 red, 1 black (Receiver)
Cable resistance	10kΩ max
CE/Warranty	CE approved/ 1 year warranty
Dimensions/Wt	6.3x2.9x1.7"(162x74.5x44mm)/ 10.8oz (308g)

Ordering

CT40.....16-Line Cable Identifier/Tester Kit

CT20 Continuity Tester Pro

One person operation for wire and cable testing; both local and remote

Features:

- Provides positive continuity checks with bright flashing LED and loud pulsating beeper
- Identify wire pairs and cables remotely using external probe
- Wire verification distance up to 10,000ft (3000m); cable size of 26AWG minimum
- Flashing remote probe - two lead, bi-color (red/ green) LED probe allows a single user to identify up to three wires or cables at a time for correct labeling with only one trip to the other end location
- Dims: 3.6x2.2x1.14" (90x57x29mm); Wt: 9.2oz (260g)
- Includes Remote probe with bi-color LED for wire identification highlight

Applications:

- Great for Electricians and Helpers, Cable TV and Audio System Installers, Alarm Technicians, HVAC Installers, and Auto Repair Technicians

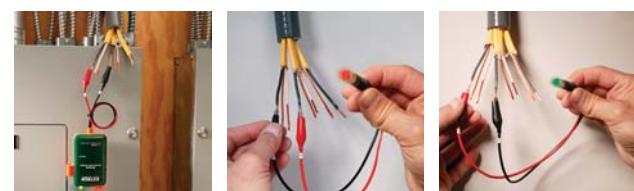

Use for local continuity or for remote wiring identification.

RED LED means wiring is reversed.

GREEN LED means wiring is properly identified



Patent pending

Complete with remote probe, test leads with alligator clips, 9V battery and pouch; CE Approved; 1 year warranty

Ordering

CT20.....Continuity Tester Pro

CT100 Network Cable Tester

Continuity Tester for twisted pair cables and F Type coaxial cables

Features:

- Tests cable lengths from 3-600ft (0.9-183m); Dims/Wt: 3.25x2x1.25" (83x51x32mm)/3.6oz (102g)
- Complete with 2 AAA batteries.
- Twisted Pair Features**
- Tests EIA/TIA568A and 568B and 10Base-T
- Tests for shorts, opens, miswires and reversals

- Shield detection tests shield integrity
- Tests installed wiring and jumper cables; shielded or unshielded twisted pair cable; Cat 5e, Cat 5, Cat 4, and Cat 3

CATV Features

- "F" connector for troubleshooting CATV coaxial installations



Ordering:

CT100Network Cable Tester
409992.....Vinyl pouch carrying case

40180 Tone Generator and Amplifier Probe Kit

Heavy duty kit with audible tone easily identifies wires or cables

Features:

- Insulated inductive probe prevents shorting conductors
- Tests wire trace, continuity test, clear/busy/ringing line test and tip/ring identification
- Alligator clips for non-terminated cables and modular connectors for direct connections to telephone and internet wiring
- Built-in speaker with sensitivity control

- Dimensions: Probe - 9x2.3x1" (228x57x25mm); generator - 2.5x2.5x1.5" (64x64x38mm) Weight: 0.6lbs (272g)
- CE approved; One year warranty
- Complete with Amplifier probe and Tone Generator with alligator clips and modular RJ11 phone and RJ45 digital connector cables, 9V batteries and case



Trace phone/data wiring

Ordering

40180Tone Generator and Amplifier Probe Kit

TG30 Wire Tracer/Tone Generator Kit

Trace communications and coaxial cables

Features:

- Non-Contact probe audibly identifies selected wire or cable
- Easily trace wires from source to termination
- Adjustable sensitivity control improves wire identification and eliminates false detection
- Continuity test — audible/visible indication
- Dims/Wt: Probe - 5.8x1.1x1.1" / 1.1oz (147x28x28mm) / (30g); Generator - 2.6 x 4.1x0.9" / 4.2oz (67x103x23mm) / (120g)

- Complete with Tone probe and Tone generator with RJ11 and RJ45 phone connector plus adaptor with F type coaxial connector and pair of alligator clips, four LR44 batteries, 9V battery and carrying case

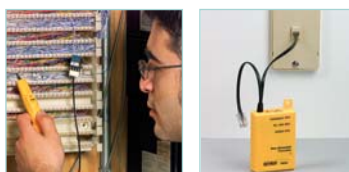

Transmitter injects traceable signal into cables, checks telephone lines, and performs continuity checks



Ordering

TG30Wire Tracer/Tone Generator Kit

FO600 Series FiberMeter Test Kits

Certification test kits include optical power meter and Light Source

Features:

- Fiber certification with high accuracy and resolution for both multimode and single mode applications
- Stores up to 1000 measurements and physical fiber characteristics for up to four sites
- View, re-measure, print or delete stored data
- Use Windows® compatible software to download data and print professional certification reports
- Loss Wizard™ calculates the maximum allowable optical loss according to EIA/TIA standards; provides Pass/Fail certification
- Includes FiberMeter, 1.25mm adaptor for LC and MU type connectors, Light Source(s), software, DB9 serial cable, CD-ROM based manual, NIST Certificate of calibration, two 9V batteries, alcohol wipes, 2 patch cords with bulkheads in a hardened travel case (4 patch cords and bulkheads in dual source kits). Select kit part number based on the light source required; (1 year warranty)

Ordering

FO600M-KITMultimode 850 & 1300nm (ST)
 FO600ST2-KIT .Multimode 850 & 1300nm (ST) & Single Mode 1310+ 1550nm (ST)
 FO600FC2-KIT .Multimode 850 & 1300nm (ST) & Single Mode 1310+ 1550nm (FC)
 FO600SC2-KIT .Multimode 850 & 1300nm (ST) & Single Mode 1310+ 1550nm (SC)
 PCSTSTMultimode Patch Cable ST/ST
 PCSTST-SMSingle Mode Patch Cable ST/ST



Visit www.extech.com for more information on Fiber Optic Meters

LE/LS Series LED and Laser Light Sources

Affordable LED and Laser Light Sources provide high stability; NIST Traceable Certificate included

Features:

- Typical one hour drift of only 0.05dBm
 - Dimensions: 4.9x2.8x1.3"(125x70x33mm)
Weight: 5oz(154g)
 - Light Sources come complete with NIST Traceable Certificate, protective rubber holster, 9V battery, and case with belt clip; (1 year warranty)
- LED Multimode Light Sources (40hrs):**
- 850nm or combination 850nm and 1300nm light source
 - Standard ST, FC or SC connector
 - -20dBm output @ 25°C with 0.1dB accuracy
- Laser Single mode Light Sources (600hrs):**
- 1310nm or both 1310 and 1550nm output into FC, SC or ST connectors
 - Provide 50dB measurement range when used with FiberMeter or MicroMeter
 - 2nm Spectral Width
 - -10dBm output power into single mode fiber; 0.1dB accuracy

Ordering:

LE200ST850nm LED Light Source, ST connector
 LE220ST850nm & 1300nm LED Light Source, ST connector
 LS300FC1310nm Laser Light Source, FC connector
 LS300SC1310nm Laser Light Source, SC connector
 LS300ST1310nm Laser Light Source, ST connector
 LS320FC1310 and 1550nm Laser Light Source, FC connector
 LS320SC1310 and 1550nm Laser Light Source, SC connector
 LS320ST1310 and 1550nm Laser Light Source, ST connector



Visit www.extech.com for more information on Fiber Optic Meters

480846 8GHz RF EMF Strength Meter

Highest frequency radiation measurement in the 10MHz to 8GHz frequency range

Features:

- For electromagnetic field strength measurement including mobile phone base station antenna radiation, RF power measurement for transmitters, wireless LAN (Wi-Fi) detection/installation, wireless communication applications (CW, TDMA, GSM, DECT) and microwave leakage
- Non-directional (isotropic) measurement with three-channel (triaxial) measurement probe
- Max Hold and Average functions
- Manual store/recall up to 99 sets
- Level exceed audible alarm with user selectable threshold
- Complete with 9V battery and carrying case

Specifications	Sensor Type	Electric field
	Frequency range	10MHz to 8GHz
	Directional Characteristic	Isotropic, 3-dimensional
	Measurement Ranges	20mV/m to 108.0 V/m
		53µA/m to 286.4mA/m
		1µW/m ² to 30.93 W/m ²
		0µW/cm ² to 3.093 mW/cm ²
		Adjustable threshold with On/Off
	Audible Alarm	Adjustable threshold with On/Off
	Memory	Manual save/recall of 99 sets
Dimensions/Weight	2.6x2.4x9.7" (67x60x247xmm)/ 8.8oz (250g)	
Warranty	1 year	

Ordering:

480846RF EMF Strength Meter (8.0GHz)

NEW



480836 3.5GHz RF EMF Strength Meter

High frequency radiation measurement in the 50MHz to 3.5GHz frequency range

Features:

- For electromagnetic field strength measurement of mobile phones, cell phone and base stations, microwave leakage
- Non-directional (isotropic) measurement with three-channel (triaxial) measurement probe
- User selectable alarm threshold
- Max Hold and Average functions
- Complete with 9V battery and carrying case

Specifications	Sensor Type	Electric field
	Frequency range	50MHz to 3.5GHz
	Directional Characteristic	Isotropic, 3-dimensional
	Measurement Ranges	20mV/m to 108 V/m
		53µA/m to 286mA/m
		1µW/m ² to 30.93mW/m ²
		0µW/cm ² to 3.093mW/cm ²
		Adjustable threshold with On/Off
	Audible Alarm	Adjustable threshold with On/Off
	Memory	Manual save/recall of 99 sets
Dimensions/Weight	2.4x2.4x9.3" (60x60x237mm)/ 7.1oz (200g)	
Warranty	1 year	

Ordering:

480836RF EMF Strength Meter (3.5GHz)



480826 Triple Axis EMF Tester

Three axis (X,Y, Z) electromagnetic field measurement

Features:

- Three axis (X, Y, Z direction) electromagnetic field measurement
- Designed to provide user a quick, reliable and easy way to measure EMF radiation levels around power lines, electrical appliances and industrial devices
- Wide ranges (3 ranges of µTesla or mGauss)
- Calibrated to measure EMF radiation at wide bandwidths from 30Hz to 300Hz
- Big digit LCD display with Data hold
- Easy to use remote probe
- Complete with sensor with 3ft (930mm) cable, 9V battery, and hard carrying case

Specifications	Function	Range	Max. Resolution	Basic Accuracy			
				µTesla	20µTesla	0.01µTesla	±4%
					200µTesla	0.1µTesla	±5%
	mGauss	2000µTesla	1µTesla	±10%			
		200mGauss	0.1mGauss	±4%			
		2,000mGauss	1mGauss	±5%			
		20,000mGauss	10mGauss	±10%			
	Number of Axis	3-axis X, Y, Z direction					
	Bandwidth	30Hz to 300Hz					
	Sampling Time	Approx. 0.4 second					
Power Current	Approx. DC 2.7mA						
Dimensions	2.6x1.2x 7.6" (68x30x195mm)						

Ordering:

480826Triple Axis EMF Meter



480823 EMF/ELF Meter

Measure electromagnetic field radiation levels from fans, electrical appliances, wiring, and power lines

Features:

- Large 1/2" LCD (1999 count) display of Electromagnetic Field (EMF) level in milliGauss or microTesla
- Accurate measurements to 4% over a measuring range of 0.1 to 199.9mGauss (0.01 to 19.99µTesla)
- ELF frequency bandwidth of 30 to 300Hz Single axis - sampling 2.5 times per second
- CE approved, one year warranty
- Dims: 5.2x2.8x1"(132x71x25mm); Weight: 6oz (170g)
- Complete with 9V battery



Ordering:

480823Electromagnetic Field Meter
409992Soft pouch carrying case

380193 Passive Component LCR Meter

Measures Inductance, Capacitance, and Resistance with secondary parameter (Q,D,R)

Features:

- Simultaneous 20,000/10,000 count backlit display of the primary parameter (L, C or R) with the secondary parameter of Q (quality), D (dissipation) or R (resistance)
- Set Hi/Lo limits using absolute values or percentage limits
- Parallel or Series equivalent circuit
- Max/Min/Avg; Auto power off with disable
- Automatic blown fuse indication
- Built-in test fixture or use external test leads
- Open and Short Zero removes unwanted stray impedances from the measurement
- Relative mode, zero, or supplied reference

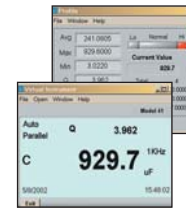

Built-in RS-232 with Windows® 95/98/NT/2000/XP compatible software.



Complete with test leads with alligator clip, 9V battery, software, cable, and protective holster; CE approved, 1yr warranty

Function	Range	Basic Accuracy
Inductance	2000.0µH, 20.000mH, 200.00mH, 2000.0mH	±(0.7%rdg+Lux/10000+5d)
	20.000H, 200.00H, 2000.0H, 10000H	(DF<0.5)
Capacitance	2000.0pF, 20.000nF, 200.00nF,	±(0.7%rdg+5d)
	2000.0nF, 20.000µF, 200.00µF, 2000.0µF	(DF<0.1)
Resistance	20.000Ω, 200.00Ω, 2.0000kΩ, 20.000kΩ, 200.00kΩ, 2.0000MΩ, 20.000MΩ,	±(0.5%rdg+8d)
DF (with C)	0 to 0.9999	±(0.7%rdg+100/ Cx+5d)
Q	0 to 9999	±(1.2%rdg+100/ Lux+5d)
Test Freq.	120Hz and 1kHz	
Dims/Wt	7.56x3.58x2.1" (19.2x9.1x5.25cm) / 12.87oz (365g)	

Ordering:

380193.....Passive Component LCR Meter
153117.....117VAC adaptor
153220.....230VAC adaptor

RC100 Passive Component R/C SMD Tweezer Tester

Fast, precise identification and measurement of surface mount components

Features:

- 4000 count LCD displays Resistance, Capacitance, and Diode Test
- Relative mode for zero or user supplied reference
- Auto power off, overrange and low battery indicators
- Complete with two AG13 batteries and slide cover for storage



One-handed operation for SMD component sorting or inspection

Function	Range	Resolution	Basic Accuracy
Resistance	400, 4k, 40k, 400k, 4M, 40MΩ	0.1	±(1.2% of rdg + 3d)
Capacitance	4nF, 40nF, 400nF, 4µF, 40µF, 200µF	1pF	±(3.0% of rdg + 5d)
Diode Test	1mA @ 1.5V approx		
Dimensions	7.1x1.4x0.8" (181x35x20mm)		
Weight	2.3oz (65g)		

Ordering:

RC100Passive Component R/C SMD Tweezer Tester

480400/480403 Motor Rotation and 3-Phase Testers

Check 3-phase sequence and motor rotation

Features:

- Tests phase orientation of 3-Phase power sources
- Indicates phase orientation (clockwise or counter-clockwise) and whether each of the 3-Phases is live
- Easy to open alligator clips with wide jaws
- Durable double molded housing
- Complete with cable and 3 large color-coded alligator clips, case, and 9V battery (for 480403)

480400 3-Phase Tester

- Multi-line LCD Displays; No battery required

480403 Motor Rotation and 3-Phase Tester

- LEDs display motor rotation and phase status
- Indicates rotation direction of motor
- Determine rotation of a motor without contact
- Ensures motor is not damaged from incorrect wiring



Function	480400	480403
Phase Sequence	Yes	Yes
Voltage	40 to 600V	40 to 600V
Frequency	15 to 400Hz	2 to 400Hz
Motor Rotation	—	Yes
CE/Category Rating	CE, CAT III-600V	
Dimensions	5.1x2.7x1.25" (130x69x32mm)/ 4.5oz (130g)	

Ordering:

- 4804003-Phase Rotation Tester
480403Motor Rotation and 3-Phase Tester

MA640-K Phase Rotation/ **NEW** Clamp Meter Test Kit

Ideal kit for plant maintenance — True RMS Clamp Meter with multimeter functions, 3-phase rotation tester, and CAT IV AC Voltage Detector

Features:

- Model MA640 — 600A True RMS 6000 count AC/DC Clamp-on MultiMeter with built-in non-contact AC Voltage Detector (see p. 35 for specifications)
- Model 480400 — 3-Phase Rotation Tester with multi-line LCD display, durable double-molded housing, and easy-to-open wide-jaw alligator clips (see above page for specifications)
- Model DV25 — Dual Range AC Voltage Detector (24 to 1000VAC/100 to 1000VAC) + Flashlight with Audible/ Visual indication, double-molded housing, and CAT IV-1000V safety rating (see p. 41 for specifications)
- Set of double molded professional test leads
- Type K thermocouple bead probe and Type K to Banana Input Adaptor
- Supplied in a heavy duty carrying case that provides protection and organization for the meters whenever they are needed
- Dimensions: 9.8x8x2" (248x203x54mm); Weight: 1.3lbs (590g)



Ordering:

- MA640-KPhase Rotation/Clamp Meter Test Kit

DL150 True RMS AC Voltage/Current Datalogger **NEW**

Datalog up to 100,000 readings with user programmable sample rate from 1 second to 24 hours

Features:

- Measure True RMS AC Voltage (600V) or Current (200A)
- Readings can be downloaded to your PC via the USB interface and analyzed using the included software or exported to a spreadsheet
- High/Low user-settable alarms
- LCD displays time/date, current readings, Min/Max, and if alarm settings have been exceeded
- Normal, Peak and Capture (user-specified trigger level) recording modes
- Auto Power off and battery check
- Complete with current clamp, test leads, alligator clips, USB cable, Windows® compatible software, AC adaptor, and 3.6V Lithium battery

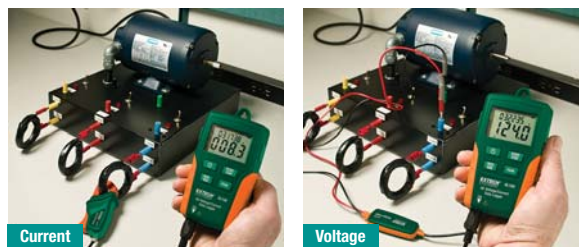

Datalog up to 100,000 True RMS Current or Voltage readings. Captured readings can be downloaded to your PC, using the included USB cable and software, for further analysis. Readings can also be exported into a spreadsheet for creating charts and graphs.



Datalogger and accessories are conveniently packaged in a protective hard carrying case



Specifications

Function	Range	Resolution	Basic Accuracy
AC Current	2 to 200A	0.1A	±(2% rdg ± 1A)
AC Voltage	6 to 600V	0.1V	±(1.5% rdg ± 1V)
Memory	100,000 points		
Sampling Rate	1 second to 24 hours		
PC Interface	USB includes software		
Power	3.6V Lithium battery		
Dimensions	4.5 x 2.5 x 1.3" (114 x 63 x 34mm)		
Weight	8.7oz (248g)		

Ordering: (Available Q4 2009)

DL150True RMS AC Voltage/Current Datalogger (110V)

DL152True RMS AC Voltage/Current Datalogger (220V)

DT100 Ultrasonic Distance Meter

Laser pointer identifies target area and improves aim

Features:

- Measures from 1'8" to 50' (0.5 to 15m)
- Takes the sum of consecutive length measurements
- Automatically calculates Area and Volume
- Store/Recall up to 3 readings
- Built-in white LED flashlight
- Visual and audible error alarms
- Low battery indicator; Auto power off
- Complete with 9V battery

Function	
Measurement Range	1'8" to 50' (0.5 to 15m)
Accuracy	±(0.3% reading + 3 digits)
Resolution	0.1" (0.01m)
Length Add calculation	99'11" (99.99m)
Area calculation	999.99 sq. ft. (999.99m²)
Volume calculation	999.99 cu. ft. (999.99m³)
Dims/Wt	5.4x2.4x1.7" (136x61.5x44mm)
Weight	4.1oz (117g)

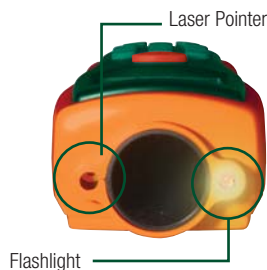

Ordering

DT100.....Ultrasonic Distance Meter

382357 Clamp-On Ground Resistance Tester

Enables non-contact measurements of ground conductors without need for auxiliary ground spikes

Features:

- Autoranging ground resistance and True RMS AC Leakage current measurements
- Programmable datalogging with 116 readings
- Programmable Hi/Lo alarm
- 0.9" (23mm) Jaw size for large ground rods
- Simplifies ground resistance measurements on multiple point ground systems
- Auto power off
- Verification resistors confirm accuracy
- Automatic Self Calibration when powered on
- 9999 Count LCD display with Data Hold
- Electrical Noise Detection feature prevents inaccurate readings
- CAT III-300V, CAT II-600V; CE
- One year warranty
- Complete with 9V battery, Resistance check plate, and durable metal storage case

Function	Range	Max. Resolution	Basic Accuracy (%rdg+digits)
Ground Resistance	0.03 to 1500Ω	0.002Ω	±1.5%
AC Leakage Current (Trms)	1mA	0.001mA	±2.5%
AC Current (Trms)	0.2mA to 30.00A	0.01A	±2.0%
Resistance Test Frequency	1.667kHz		
Continuity	Beep if less than 40Ω (approximately)		
Operating Temperature	4° to 122°F (-20 to 50°C)		
Dimensions/Weight	10.2x4.4x1.9" (258x110x47mm) / 1.5lbs (700g) (meter only)		



Verify resistance of cellular and communication tower ground grids



Ordering

382357Clamp-On Ground Resistance Tester
382357-NIST ...382357 with NIST Certificate

382152 Earth Ground Resistance Tester Kit

Includes all hardware necessary to measure earth ground in 3 ranges from 0.01Ω to 2000Ω

Features:

- 3-1/2 Digit (1999 count) multifunction LCD with Data Hold
- Measures Earth Resistance in three ranges, Test Current/Frequency and AC Earth Voltage/Frequency
- Auto power off, 3 minute Timer
- Overload Protection
- Open circuit, overrange and low battery indications

Function	Range	Resolution	Basic Accuracy
Earth Ground Resistance	20Ω, 200Ω, 2000Ω	0.01Ω, 0.1Ω, 1Ω	±2%rdg
Test Current (Freq.)	2mA (800Hz)		
AC Earth Voltage (Freq.)	0 to 200VAC (40 to 500Hz)	0.1V	±1%rdg
CE/Category rating	CE approved/ CAT III-600V		
Warranty	1 year		
Dimensions/Weight	6.4x3.9x2" (163x100x50mm)/2.2lbs (800g) (meter only)		



Check resistance between earth and grounding rod. Complete with test leads, auxiliary earth bars, heavy duty case, and six 1.5V AA batteries



Ordering

382152Digital Earth Ground Resistance Tester
382152-NIST ...382152 with NIST Certificate
382153Replacement Earth Bars (2pk)
382154Replacement Set of Test Leads

382252 Earth Ground Resistance Tester Kit **NEW**

Includes all hardware necessary to measure earth ground in 3 ranges from 20 to 2000Ω

Features:

- Large dual display with backlight
- Test Hold function and Automatic Zero adjustment
- AC/DC Voltage, Resistance, and Continuity
- Auto Power off, Overrange and low battery indication

Function	Range	Resolution	Basic Accuracy
Earth Ground Resistance ranges	20Ω/ 200Ω/2000Ω	0.01Ω/ 0.1Ω/1Ω	±(2%rdg+2d)
Test Current (Freq.)	<2.5mA (820Hz)		
AC Earth Voltage (Freq.)	0 to 200VAC (50 to 400Hz)		±(3%rdg+3d)
DC Voltage	0 to 1000V	0.1V	±(0.8%rdg+3d)
Resistance	0 to 200kΩ		±(1%rdg+2d)
Continuity	40Ω		
CE/Category rating	CE approved/ CAT III-1000V		
Warranty	1 year		
Dimensions/ Weight	7.9x3.6x2" (200x92x50mm)/ 1.5lbs (700g) (meter only)		



Complete with test leads, two auxiliary earth bars, carrying case, rubber holster and six 1.5V AA batteries



Ordering

382252Earth Ground Resistance Tester Kit
382252-NIST ...382252 with NIST Certificate
382253Replacement Earth Bars (2pk)
382254Replacement Set of Test Leads

380580 Battery Powered Milliohm Meter

High accuracy, high resolution portable Milliohm Meter for field use

Features:

- Four terminal Kelvin measurements
- Over-temperature and over-voltage protection
- 5 ranges with 100 $\mu\Omega$ max resolution
- Large 2000 count LCD display
- Auto-Hold and Auto power off
- Invalid test indicators prevent inaccurate measurements
- Built-in water resistant case with shoulder strap

Specifications

Function	Range	Resolution	Current	Basic accuracy
Resistance	200.0m Ω	0.1m Ω	100mA	$\pm 0.5\%$
	2000m Ω	1m Ω	100mA	$\pm 0.5\%$
	20.00 Ω	0.01 Ω	10mA	$\pm 0.5\%$
	200.0 Ω	0.1 Ω	10mA	$\pm 0.5\%$
	2000 Ω	1 Ω	1mA	$\pm 0.5\%$
Power	8 AA batteries			
Dimensions	9.8x7.5x4.3" (250x190x110mm)			
Weight	3.3lbs (1.5kg)			

Complete with 8AA batteries, and 2 sets of test leads (4 wire with 4 alligator clips and 4 wire with 2 Kelvin alligator clips)

Ordering:

- 380580Battery Powered Milliohm Meter
 380580-NIST ..380580 with NIST Certificate
 380565Test Leads w/Kelvin clips for 380580



380560 High Resolution Milliohm Meter

Benchtop meter provides resolution down to 0.01m Ω

Features:

- 7 ranges for wide low resistance measurements
- High resolution to 0.01m Ω
- 1999 count display with 0.8" digits
- Automatic zero
- Built-in comparator for Hi/Lo/Go resistance testing or selection
- 5V test voltage
- One year warranty

Specifications

Function	Range	Resolution	Current	Accuracy (%rdg)
Resistance	20m Ω	0.01m Ω	1A	$\pm 0.2\%$
	200m Ω	0.1m Ω	1A	$\pm 0.2\%$
	2 Ω	0.001 Ω	100mA	$\pm 0.2\%$
	20 Ω	0.01 Ω	10mA	$\pm 0.2\%$
	200 Ω	0.1 Ω	1mA	$\pm 0.2\%$
	2k Ω	0.001k Ω	100 μ A	$\pm 0.2\%$
	20k Ω	0.1k Ω	10 μ A	$\pm 0.2\%$
Power	110VAC, 60Hz or 220VAC 50Hz			
Dims/Wt	11x8.3x3.5" (280x210x90mm)/ 4.85lb (2.2kg)			

Ordering:

- 380560Precision Milliohm Meter, 110VAC
 380560-NIST ..380560 with NIST Certificate
 380562Precision Milliohm Meter, 220VAC
 380562-NIST ..380562 with NIST Certificate
 380465Spare Kelvin Clip Test Lead Set



Complete with 4-wire cables with Kelvin clip connectors and power cord

380460 Precision Milliohm Meter

Portable Milliohm meter provides resolution to 0.1m Ω

Features:

- High accuracy and performance for low resistance measurements
- Large 0.7" (18mm) LCD 1999 count
- Manual zero display adjust
- Overrange indication
- Compact, durable field service housing with protective cover
- CE; 1 year warranty

Specifications

Function	Range	Resolution	Max. Voltage	Accuracy (%rdg)
Resistance	200m Ω	0.1m Ω	3.8VDC	$\pm 0.75\%$
	2000m Ω	1m Ω	3.4VDC	$\pm 0.75\%$
	200 Ω	100m Ω	3.2VDC	$\pm 0.75\%$
	2k Ω	1 Ω	3.2VDC	$\pm 0.75\%$
Power	110VAC, 60Hz or 220VAC, 50Hz			
Dims/Wt	6.3x2.8x3.4" (160x120x85mm)/ 1.5lb (680g)			

Ordering

- 380460Precision Milliohm Meter, 110VAC
 380460-NIST ..380460 with NIST Certificate
 380462Precision Milliohm Meter, 220VAC
 380462-NIST ..380462 with NIST Certificate
 380465Spare Kelvin Clip Test Lead Set



Complete with 4-wire cables with Kelvin clip connectors and power cord



Insulation Testers / Megohmmeters

Extech offers a full range of insulation testers with functions and features required for all high resistance testing applications.

Featuring Model 380260

▶ Three Test Voltages

Run tests at 250, 500 or 1000V

▶ Continuous Lock Feature

For hands-free operation

▶ Automatic Discharge

To remove high voltage from device under test



Measures the insulation resistance of motors.

380260 includes heavy duty test leads, alligator clip, hanging strap, hard case, and batteries



NEW

380320 Analog High Voltage Megohmmeter

Three Insulation Test Ranges with Live Circuit Warning that displays the actual AC voltage measurement

- Three test voltages 250V, 500V, and 1000V
- Insulation Resistance to 400MΩ
- Lock Power On feature for extended test times
- Fuse protected and automatic discharge circuit
- Measures continuity to 3Ω, Resistance to 500Ω, and AC Voltage to 600V
- 1.3mA short circuit current
- Complete with test leads, 6 x AA batteries, and hard carrying case

Accessories

380379 ...High Voltage Test Leads (for 380353)

Order Meter with NIST Certificate*

All Extech meters come factory calibrated. For an additional charge, Extech will supply your meter complete with a Certificate of Calibration Traceable to N.I.S.T. with Data at multiple points. **To order meter with NIST:**

380360-NIST
380260-NIST

*Only products listed are available with NIST Certificate. Meter must be ordered with NIST Certificate at time of purchase.

Specifications

Model	380320
Insulation Resistance	100MΩ, 200MΩ, 400MΩ
Max Resolution	—
Basic Accuracy	±5% of scale
Insulation Test Voltages	250V, 500V, 1000V
AC Voltage Test	Yes
Low Resistance Test	Yes
Power source	8 x AA batteries
Dimensions	7.9x3.6x2" (200x92x50mm)
Weight	1.2lbs (546g) includes batteries
CE	Yes
Category Rating	CAT III-600V
Warranty	1 year



380353 Analog High Voltage Megohmmeter

1000V analog tester with self storage case

- Three test voltages 250V, 500V, and 1000V
- Insulation Resistance to 400MΩ
- Fuse protected and automatic discharge circuit
- Test Lock for extended time tests
- 2mA short circuit current
- AC Voltage measurements to 600V
- Low resistance test
- Live Power and Power Applied indicator lamps
- Optional 380379 High Voltage test leads
- Complete with built-in carrying case with cover and carry strap, test leads, alligator clips, and 8 x AA batteries



Neckstrap for convenient operation

380360 Digital Megohmmeter

1000V digital tester with automatic 3 minute test

- Three test voltages of 250V, 500V and 1000V
- Insulation Resistance to 2000MΩ
- Safety Power Lock enables “hands free” operation for 3 minute test
- Automatic discharge when safety “Press to Test” button is released
- Auto power off and Data Hold
- Large 0.65" (17mm) LCD display
- Automatic zero adjustment
- Continuity measurements to 200Ω and Voltage to 600VAC
- Complete with 6 x AA batteries, heavy duty 2.5ft (0.8m) test leads, alligator clip, large probe, and case with neckstrap



380260 Handheld Megohmmeter

1000V digital tester with large dual backlit display

- ✓ Double molded housing for added durability
- ✓ Dual display of Insulation Resistance and Test Voltage
- ✓ Backlit super large display
- 250V, 500V, and 1000V test voltages
- Insulation Resistance to 2000MΩ
- Auto power off
- Lo Ω function for testing connections
- Lock Power On Function for hands-free operation
- Data Hold
- Complete with heavy duty test leads, alligator clip, hanging strap, protective carrying case, and 6 x AA batteries

380353	380360	380260
100MΩ, 200MΩ, 400MΩ	200MΩ, 2000MΩ	200MΩ, 2000MΩ
—	0.1MΩ	0.1MΩ
±5% of scale	±3%rdg	±3%rdg
250V, 500V, 1000V	250V, 500V, 1000V	250V, 500V, 1000V
Yes	Yes	Yes
Yes	Yes	Yes
8 x AA batteries	6 x AA batteries	6 x AA batteries
6.7x6.5x3.7" (170x165x92mm)	3.8x6.3x2.3" (97x160x58mm)	7.8x3.6x1.9" (200x92x50mm)
34oz (970g) includes batteries	13oz (369g)	24.6oz (700g)
Yes	Yes	Yes
CAT III-600V	CAT III-600V	CAT III-600V
1 year	1 year	1 year



High Voltage Insulation Testers

Extech's advanced capability Insulation Resistance testers include features for datalogging measurement results and for high voltage material analysis.

Featuring Model 380395

▶ High Voltage to 5kV

With 500V increments for insulation analysis

▶ Advanced Functions

Polarization Index, Dielectric Absorption, and Peak functions

▶ High Resistance to 60GΩ

For insulation materials testing

▶ CAT IV Rating and Double Molded Housing

Rugged housing for industrial application use



Ideal for motor insulation test

Order Meter with NIST Certificate*

All Extech meters come factory calibrated. For an additional charge, Extech will supply your meter complete with a Certificate of Calibration Traceable to N.I.S.T. with Data at multiple points. **To order meter with NIST:**
380366-NIST

*Only products listed are available with NIST Certificate. Meter must be ordered with NIST Certificate at time of purchase.

380395 includes heavy duty color coded test lead, alligator clip leads, AC Adaptor, and hard case



Specifications

Model
Insulation Resistance
Max Resolution
Basic Accuracy
Insulation Test Voltages
AC Voltage Test
Low Resistance Test
Power source
CE
Category Rating
Dimensions
Weight
Warranty



380363 Digital Insulation Tester

Autoranging insulation measurements to 10GΩ plus manual datalogging stores up to 9 data sets

- 250V, 500V and 1000V test voltages
- Large LCD display with analog bargraph
- Low Resistance function for testing connections
- Automatic discharge of capacitive voltage charges
- AC/DC voltage measurement up to 999V
- Auto power off
- Manual data record and read function (9 sets)
- Live circuit display warning and beeper
- Complete with carrying case, test leads, and 6 x AA batteries



380366 Insulation Tester + Datalogger

Autoranging insulation measurements to 4000MΩ with 1mA test current

- Datalogging function stores up to 16,000 readings with single store or a programmable rate of 1 to 65,000 seconds per sample
- 250V, 500V and 1000V test voltages
- Large dual 4000 count backlit LCD and fast 50 segment analog display
- Data Hold, Test Lock, Audible Continuity, Auto Sleep and Low Resistance functions
- Measure up to 600V AC
- RS-232 PC interface with Windows® 95/98/NT/2000/ME/ XP compatible software
- Open circuit, overrange and low battery indications
- Complete with built-in carrying case with cover, test leads, alligator clips, RS-232 PC cable, software, neckstrap, and 8 x AA batteries



NEW

380395 Digital High Voltage Insulation Tester

High test Voltages up to 5kV with Insulation Resistance to 60GΩ

- Test Voltages of 500V, 1000V, 2500V, and 5000V
- Large 6000 count display with bargraph and backlight
- Polarization Index (PI) measurement
- Dielectric Absorption Ratio measurement
- 1 to 15 minute Timer function for Insulation Resistance measurements
- AC/DC Voltage from 0 to 600V with MAX/Min, Peak and Relative functions
- Autoranging and timer measurement function
- Indication of output voltage and discharge voltage
- Auto-discharge function and voltage output warning function
- Auto Power off and battery check
- Complete with test leads, 8 x C batteries, AC adaptor, and heavy duty carrying case

380363	380366	380395 (120VAC)	380396 (220VAC)
4MΩ, 40MΩ, 400MΩ, 4000MΩ, 10GΩ	4MΩ, 40MΩ, 400MΩ, 4000MΩ	6MΩ, 60MΩ, 600MΩ, 6GΩ, 60GΩ	6MΩ, 60MΩ, 600MΩ, 6GΩ, 60GΩ
1kΩ	1kΩ	1kΩ	1kΩ
±3%	±3%	±2.5%	±2.5%
250V, 500V, 1000V	250V, 500V, 1000V	500V, 1000V, 2500V, 5000V	500V, 1000V, 2500V, 5000V
999VAC	600VAC	600VAC	600VAC
0 to 40Ω	0 to 400Ω	0 to 600Ω	0 to 600Ω
6 x AA batteries	8 x AA batteries	8 x C batteries	8 x C batteries
Yes	Yes	Yes	Yes
CAT III-1000V	CAT III-600V	CAT IV-600V	CAT IV-600V
9.3x4.6x2.1" (235x116x54mm)	7.9x5.5x3.7" (200x140x95mm)	7.8x5.8x3.4" (198x148x86mm)	7.8x5.8x3.4" (198x148x86mm)
1.15lbs (520g)	1.8lbs (900g)	3.2lbs (1438g)	3.2lbs (1438g)
1 Year	1 year	1 year	1 year



True RMS Power Clamp Meters

Power Clamp Meters have added functions to determine power. Ideal for energy efficiency studies, power factor correction and evaluation of distribution systems.

Featuring Model 380976

▶ Wide Power Ranges

Measure power of large appliances to industrial machinery

▶ Single & Three Phase

Automatic calculation of three phase power from consecutive single phase readings

▶ μ A Current

With 10nA resolution for flame rod tests

▶ Dual Display

View two parameters at the same time



Measure True Power (W), Apparent Power (VA) and Reactive Power (VAR) on single-phase and 3-phase systems

Order Meter with NIST Certificate*

All Extech meters come factory calibrated. For an additional charge, Extech will supply your meter complete with a Certificate of Calibration Traceable to N.I.S.T. with Data at multiple points. **To order meter with NIST:**

380940-NIST
380976-NIST
382068-NIST
382075-NIST

*Only products listed are available with NIST Certificate. Meter must be ordered with NIST Certificate at time of purchase.



380940 400A AC/DC Power Clamp Meter

Measures True Power, Current, and Voltage

- Large LCD with 40 segment analog bargraph
- Data Hold, Max/Min recall, Auto Zero (DC current), plus low battery indication
- Auto power off
- Complete with test leads, 2 AA batteries, and carrying case

Specifications

Model	380940
Display counts	4000 count LCD
Jaw size/Cable size	0.9" (23mm); 350MCM
True RMS	Yes
True Power (max res.)	40kW, 240kW AC/DC (10W)
Basic Accuracy (ACA)	$\pm 1.5\%$ rdg
Apparent Power	—
Reactive Power	—
Power Factor	—
Phase Angle (ϕ)	—
Peak Capture	—
AC/DC Current (max res.)	400.0A AC/DC (0.1A)
μ A AC+DC Current (max res.)	—
AC/DC Voltage (max res.)	600VAC/400VDC (1AC/0.1VDC)
Resistance (max res.)	—
Capacitance (max res.)	—
Frequency (max res.)	100Hz to 1MHz (0.01Hz)
Temperature (max. res.)	—
CE/UL/Category rating	CE, CAT II-600V
Dimensions/Weight	7.2X2.5X1.4" (183X64X36mm)/ 6.7oz (190g)
Warranty	1 year



380976 Single Phase and 3-Phase 1000A AC Power Clamp

Measurements include Power (kW), Current (μA), Insulation Resistance (MΩ) and Temperature (°C/°F)

- Measures 1φ/3φ True Power, Apparent Power and Reactive Power, plus Horsepower, Power factor, and Phase Angle with Lead/Lag indicator
- AC+DC μA Current with 10nA resolution for flame rod tests
- Auto Detect AC/DC Voltage measurements with simultaneous Frequency display
- Auto power off with disable feature
- Complete with test leads, Type K bead wire probe (-4 to 482°F/-20 to 250°C), carrying case, and 9V battery



382068 1000A AC/DC Clamp-on Power Datalogger Kit

Datalogs up to 4000 readings

- 1000A Clamp measures 1φ or 3φ power to 600kW
- Dual display of kW+PF, kVA+PF, V+A, A+Hz or V+Hz
- Data Hold and Auto power off
- 25 point memory
- Full function display on large 4-digit LCD with fast 40 seg. bargraph, Peak Hold, and MIN/MAX
- Complete with Clamp-on Meter, 9V battery, alligator clips, test leads, Datalogger/RS-232 module, PC software with cable, and case



382075 2000A AC/DC 3-Phase Clamp Power Analyzer

Measures, computes, and displays 3-Phase Power on Balanced or Unbalanced Loads

- Display Lead/Lag Current/Voltage phase shift in degrees
- Store/recall last 5 readings
- DC Current Auto-Zero
- Dual displays: kW+PF, kVA+kVAR, phase-angle+Hz, Volts+Hz, or Amps+Hz
- Advanced Relative and Min/Max functions
- Data Hold
- Complete with test leads, carrying case, and 9V battery

380976	382068	382075
10,000 count LCD	9999 count LCD	4000 count LCD
1.6" (40mm); 500MCM	1.8" (46mm); 1000MCM	2.2" (55mm); 1000MCM
Yes	Yes	Yes
600kW (10W)	600kW (0.01kW)	1200kW (0.01kW)
±2%rdg	±1.5%rdg	±1.5%rdg
600kVA (10VA)	600kVA (0.01kVA)	1200kVA (0.01kVA)
600kVAR (10VAR)	—	1200kVAR (0.01kVAR)
Yes	Yes	Yes
-65 to +60°	—	-90° to +90° (0.1°)
—	1000A/600V	—
100.00A, 1000.0A AC (10mA)	1000.0A AC/DC (0.1A)	2000A AC/DC (0.1A)
1000μA Trms (0.01μA)	—	—
600V (0.1mV)	600V (0.1V)	600V (0.1V)
1000kΩ, 100MΩ (0.1Ω)	10kΩ (1Ω)	—
7000μF (0.001μF)	—	—
40Hz to 1kHz (0.1Hz)	5kHz (0.1Hz)	40 to 400kHz (0.1Hz)
-58 to 1000°F or -50 to 900°C (0.1°)	—	—
CE, UL, CAT III-600V	CE, CAT III-600V	CE, UL, CAT III-600V
9x3x1.6" (228x76x39mm)/16.4oz (465g)	10.2x3.7x1.8" (260x93x45mm)/15.9oz (450g)	10.7x4.8x1.8" (271x122x46mm)/24.7oz (700g)
1 year	1 year	1 year

Extech's Advanced Power Analyzers can optimize your plant energy efficiency potential and drive down electrical costs:

- Simplify troubleshooting and analysis of electrical demand trends throughout your plant.
- Reveal peak-demand periods, power factor inefficiency, voltage fluctuations, under or over utilized and imbalanced motors
- Identify equipment inefficiencies and electrical conditions that may cause plant shutdowns
- Rapidly pays for itself through substantial energy savings and promotes a power system that is well managed and a cost efficient part of a facility

382100 1200A 3-Phase Power Analyzer/Datalogger **NEW**

Saves data on SD card in Excel® format for easy PC analysis

Numerical display (sun readable) plus SD card data storage

Features:

- Large, dot-matrix, sun readable, numerical, backlit LCD
- Full system analysis with up to 35 parameters
 - V(phase-to-phase), V(phase-to-ground)
 - A(phase-to-ground)
 - KW(phase)/ KVA(phase)/ KVAR(phase)/ PF(phase)
 - KW(system)/ KVA(system)/ KVAR(system)/ PF(system)
 - KWH(system)/ KVAH(system)/ KVARH(system)/ PFH(system)
 - Phase angle
- High accuracy auto ranging current clamps (0.2A to 1200.0A)
- Log up to 60,000 reading on a removable SD memory card in Microsoft Excel® format
- 600.0 VAC input with CATIII 600V safety rating
- Adjustable Current Transformer (CT) and Voltage Transformer (VT) Ratio, for high power distribution systems.
- Wide sampling rate range (2 seconds to 2 hours)
- Easy to use on-screen menu
- Easy to grab rugged over molded housing

Applications

- AC Power Quality Evaluation
- Motor/Generator Installation
- Energy Audits



Complete with 3 current clamps, 4 voltage leads with alligator clips, 8 AA batteries, SD memory card, Universal AC adaptor (100 to 240V), and case

Function	Range	Basic Accuracy
AC Voltage (True rms)	600.0V	±0.5%rdg
AC Current	1200A	±0.5%rdg
Active Power (MW)	9.999MW	±1.0%rdg
Apparent Power (MVA)	9.999MVA	±1.0%rdg
Reactive Power (MVAR)	9.999MVAR	±1.0%rdg
Power Factor	0.00 to 1.00	±0.04
Frequency	45Hz to 65Hz	±0.1Hz
Phase Angel	-180.0° to +180.0°	±1°
Active Power Energy (MWh)	0.0kWh to 9.999MWh	±2.0%rdg
Apparent Power Energy (MVAh)	0.0kVAh to 9.999MVAh	±2.0%rdg
Reactive Power Energy (MVARh)	0.0kVARh to 9.999MVARh	±2.0%rdg
Datalogging	60,000 reading (2GB SD memory card)	
CE/CAT rating	CE/CAT III-600V	
Warranty	1 year	
Dimensions	8.9 x 2.5 x 1.3" (225 x 125 x 64mm)	
Weight	Meter: 2.3lbs (1049g); Clamp: 1.2lbs (522g)	

Specifications

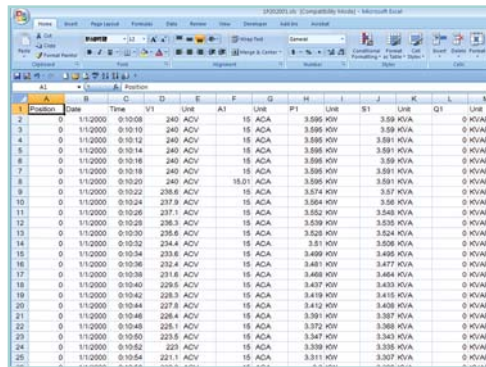

Transfer data from meter to PC using Excel® software and datalogged readings from the SD memory card (included)



Backlit LCD displays numerical values

SD memory card included

Ordering

382100 1200A 3-Phase Power Analyzer/Datalogger

Accessories

382000 Voltage Test Leads with Alligator Clips (4 leads)

382095 1000A 3-Phase Graphical Power & Harmonics Analyzer

Graphical display for analysis of measured data

Features:

- Large, dot-matrix, Graphical, backlit LCD
- Full system analysis with up to 35 parameters
 - V(phase-to-phase), V(phase-to-ground)
 - A(phase-to-ground)
 - KW(phase)/ KVA(phase)/ KVAR(phase)/ PF(phase)
 - KW(system)/ KVA(system)/ KVAR(system)/ PF(system)
 - KWH(system)/ KVAH(system)/ KVARH(system)/ PFH(system)
 - Maximum Demand (MDkW, MW, kVA, MVA)
 - Unbalance factor (VUR, IUR)
 - Phase angle
- On-screen Harmonics display (1-99th order)
- High accuracy manual ranging current clamps (10.0A, 100.0A, 1000.0A)
- Display of Waveform with Peak Values (1024 samples/period)
- 600.0 VAC input with CAT III-600V safety rating
- Full system graphical phase diagram
- Adjustable Current Transformer (CT) and Voltage Transformer (VT) Ratio, for high power distribution systems
- Log up to 52,428 reading (1P2W) on internal non-volatile memory
- Capture 28 Transient events (Dips, Swells and Outages)
- Wide sampling rate range (2 seconds to 2 hours)
- Optically isolated USB interface with software
- Easy to use on-screen menu



Complete with (3) 1000A current clamps, 4 voltage leads with alligator clips, 8 AA batteries, AC adaptor, software, PC interface USB cable, and carrying case

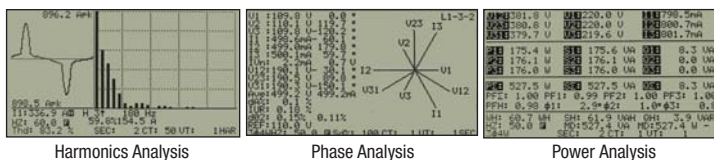

Applications

- AC Power Quality Evaluation
- Harmonics Analysis
- Motor/Generator Installation
- Energy Audits

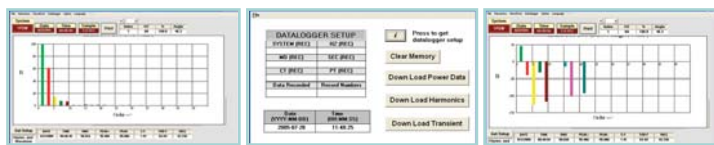

Software Harmonics Analysis

Software included to download, store data and display on a PC

Software Harmonics Phase Analysis

Function	Range	Basic Accuracy
AC Voltage (True RMS)	600V	±0.5%rdg
AC Current (True RMS)	100A, 1000A, *3000A	±0.5%rdg
Active Power (kW)	9.999MW	±1%rdg
Apparent Power (kVA)	9999kVA	VA=Vrms x Arms
Reactive Power (kVAR)	9999kVAR	VAR= sqrt (VA ² -W ²)
Power Factor	0.0 to +1.00	±1.5%rdg
Frequency	45-65Hz	0.1Hz
Phase	-180.0°~ 0°~ +180.0°	±1°
Harmonics	1 to 99	±2%
Crest Factor	1.00 to 99.99	±5%
Peak AC Voltage accuracy	±(5%rdg+30d)	
Peak AC Current accuracy	±(5%rdg+30d)	
Active Power Energy (kWh)	0mWh to 999,999kWh	
Reactive Power Energy (kVARh)	0.0kVARh to 1000MWh	
Datalogging	52428 records (1P2W)/17476 records (3P4W)	
Warranty/CE/CAT rating	1 year/ CE approved/ CAT III-600V	
Dimensions	Meter: 10.1 x 6.1 x 2.3" (257 x 155 x 57mm) Clamp: 2.2" (55mm), 2.5" x 1.0" (64x24mm) busbar	
Weight	Meter: 2.5 lbs (1160g); Clamp: 1.3 lbs (600g)	

Specifications



*Optional 3000A Flexible Current Clamp Probes 24" (610mm) long for wrapping



Optional 100A Current Clamp Probes (Model 382097) with 1.2" (30mm) jaw size around busbars (Model 382098)

Ordering

- 382095 ...1000A 3-Phase Power & Harmonics Analyzer (120V)
- 382096 ...1000A 3-Phase Power & Harmonics Analyzer (220V)

Accessories

- 382000 ...Voltage Test Leads with Alligator Clips (4 leads)
- 382097 ...100A Current Clamp Probes (Set of 3)
- 382098 ...3000A, Flexible Current Probes (Set of 3)

382090 1000A 3-Phase Power Analyzer/Datalogger

Four clamps with simultaneous display on single phase, 3-phase/3-wire or 3-phase/4-wire systems

Features:

- Large backlighting LCD displays 10 parameters simultaneously (kW, kVAR, kVA, PF plus the voltage and current of the 3 phases)
- Auto datalogs up to 20,000 sets of readings and manually logs up to 99 sets
- Clamp-on True RMS power measurements with software for Harmonics analysis
- Programmable Start/Stop datalogging times
- Up to four current probes can be connected to the analyzer

- Measures Current, Voltage, Frequency, and Phase sequence
- PC interface with Windows® 95/98/NT/ 2000/ME/XP compatible software for single and three phase voltage/current Waveform display & Harmonic analysis
- Auto power off with disable feature



Complete with 4 current clamps, 4 voltage leads with alligator clips, 8 AA batteries, AC adaptor, software, PC interface cable, and case

Function	Range	Basic Accuracy
AC Voltage (True rms)	999.9V	±0.5%rdg
AC Current	250.0, 500.0, 1000.0A	±1%rdg
Active Power (kW)	999.9kW	±1.5%rdg
Apparent Power (kVA)	999.9kVA	±1.5%rdg
Reactive Power (kVAR)	999.9kVAR	±1.5%rdg
Power Factor	-1.000 to +1.000	±3%rdg
Frequency	60Hz to 100Hz	±0.5%rdg
Phase	+90.0° - 0° - -90.0°	±3°
Active Power Energy (kWh)	0.0kWh to 119.3MWh	±1.5%rdg
Apparent Power Energy (kVAh)	0.0kVAh to 119.3MVAh	±1.5%rdg
Reactive Power Energy (kVARh)	0.0kVARh to 119.3MVARh	±1.5%rdg
Harmonics	1 to 31 (with the software)	±1.5%rdg
Datalogging	20,000 reading (automatically); 99 sets (manually)	
UL/CE/CAT rating	UL/CE/CAT III-1000V	
Warranty	1 year	
Dimensions	9.25 x 4.5 x 2.1" (235 x 116 x 54mm)	
Weight	Meter: 25.8oz (730g); Clamp: 11.8oz (333g)	

Specifications

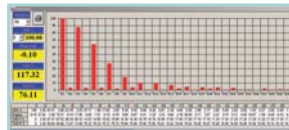

Software included for Harmonics Analysis

Ordering

- 3820901000A 3-Phase Power Analyzer/Datalogger (120V)
- 3820911000A 3-Phase Power Analyzer/Datalogger (220V)

Accessories

- 382099Voltage Test Leads with Alligator Clips (4 leads)
- USB100.....RS-232 to USB Adaptor

EM100 Energy Logger

Smart plug-in Energy Monitor computes cost of operation and stores power usage for analysis

Features:

- Monitor and record real time power usage of motors, pumps and appliances for energy conservation and cost reduction programs
- Internal memory stores up to 4 months of data at 1 minute intervals
- Transfer data to a PC using a SD card (sold separately)
- Windows compatible software included for analysis and report generation
- Display line Voltage, Current, Frequency, Power, VA and PF
- Displays ID, kWh and cost of operating the plugged in device
- Projects cost of operation per week, month and year
- Real time clock; MAX/MIN display
- Program power cost for single or dual level pricing
- Rotating 120V socket for use in either ground up or ground down outlet schemes
- Power range of 1.0W to 3500W
- Operates from 85V to 140V and up to 15A
- Battery backup stores data when removed from outlet
- UL and CE approved; 1 year warranty
- Complete with rotating plug and socket and Windows® compatible software



A. Smart plug-in Energy Monitor computes cost of operation and stores power usage for analysis.
B. The meter rotates 180° for convenient viewing angle.
C. Optional SD memory card to store data for further analysis or generate a report on your computer using included PC software.

Ordering:

- EM100Energy Logger

380820 Universal AC Power Source + AC Power Analyzer **NEW**

Front (100W) and Rear (2000W max) Universal Output Sockets for testing products from 85 to 250VAC, 45 to 65Hz

Features:

- Standby Power Measurement for desktop and notebook PCs, LCD TVs, AC adaptor/chargers, and any other products that continue to use power when connected to AC, even though they are not in use
- Power Quality Measurement (Watts, Power Factor, Voltage, Current, Harmonics)
- Cost Function calculates cost per day, month, and year
- 99 memory locations for preset voltage and frequency output settings
- Standby and Operation button
- User-programmable Over Current Protection (current limiting)
- Programmable through the built-in RS-232 interface
- Data acquisition mode captures real time data to your PC with a user-programmable sampling rate of 2 to 65,535 second
- Complete with AC power cord, RS-232 to USB cable and software

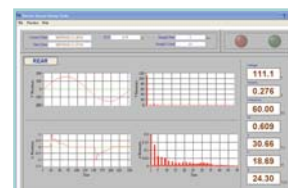

Software included



Function	Range	Resolution	Basic Accuracy
Front Panel			
Output Voltage	85 to 250V	0.1V	±1%
Output Frequency	45 to 65Hz	0.01Hz	±0.1Hz
Power	10mW to 100W	0.1mW	±1%
AC Current	5mA to 1.5A	0.1mA	±1%
Power Factor	0 to 1	0.001	±0.04
Rear Panel			
Output Voltage	85 to 250V	0.1V	±1%
Output Frequency	45 to 65Hz	0.01Hz	±0.1Hz
Power	100mW to 2000W	0.1mW	±1%
AC Current	5mA to 10A	0.1mA	±1%
Power Factor	0 to 1	0.001	±0.04
Harmonics (in amps)	1 to 50th order	0.1mA	±1.4% (1-10th)
THD	0.0 to 999.9%	0.1%	±3%
Input Power Source	110V or 220V; 45 to 65Hz		
Dimension/Weight	12 x 10.2 x 5.9" (305 x 260 x 151mm) / 21.8lbs (9.9kg)		

Ordering

380820Universal AC Power Source/Analyzer

380801/380803 Appliance Tester/Power Analyzer

Compact, battery operated device for analyzing AC power loads — with PC interface plus datalogging

Features:

- Four simultaneous displays of Power, Power Factor or VA, Voltage or Hz, Current
- True RMS Voltage & Current measurements of sine, square, triangular and distorted wave forms with a crest factor < 5
- Max, Data Hold and Overload Protection
- Battery or AC adaptor provides line isolation
- Plug device to be tested directly into the Power Analyzer
- Sampling (update) rate is 2.5 times/second
- Complete with Windows compatible software, cable, 8 x AA batteries, power cord, 117 VAC adaptor and case



Function	Range	Resolution	Accuracy (%rdg)	Input Signal Range
Watt (AC)	200, 2000W	0.1W, 1W	±0.9%	300V, 20A, 50 - 400Hz
Power Factor (Watt/VA)	0 to 1.00	0.001	±4 digits	250V, 20A, 50/60Hz
Voltage	200V, 750V	0.1V, 1V	±0.9%	
Current	2/20A via terminals 2/15A via sockets		±0.9%	(Fuse Protected)
Frequency	2kHz, 20MHz	1Hz to 10kHz	±0.5%	
Warranty	1 year			
Dimensions/Weight	13.9x11.8x3.9" (352x300x100mm) / 3.6lbs (1.6kg)			

Model 380803 Datalogger

- Built-in Datalogger stores up to 1,012 readings (Single record storage or continuous datalogging)

Model 380801

- Used for data acquisition when connected to a PC



Software included to download and store data to a PC



Built-into heavy duty carrying case.

Ordering

- 380801True RMS Single Phase Power Analyzer
- 380801-NIST.....380801 with NIST Certificate
- 380803True RMS Power Analyzer Datalogger
- 380803-NIST.....380803 with NIST Certificate
- USB100.....RS-232 to USB Adaptor



DC Power Supplies

Extech offers a complete range of DC power supplies, including Analog, Digital, and Dual Display models that meet the needs of the hobbyist, product designer and the production engineer.

Featuring Model 382260

▶ 3 Selectable Ranges

Eliminates the need for three separate power supplies

▶ Compact Housing

Slim tower ideal for tight workbench

▶ Remote Sensing

For accurate applied voltage at the load

▶ Switching Power Supply

High efficiency with minimum power loss

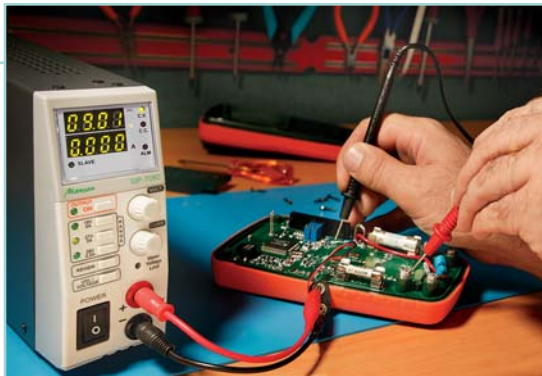

Specifications

Model
Analog or Digital Display
DC Voltage Output (Max Res.)
DC Current Output (Max Res.)

Basic Accuracy
Ripple and Noise
Line Regulation
Load Regulation
Power
Dimensions
Weight
CE
Warranty

Passive Component R/C SMD Tweezer Tester

Need fast, precise identification and measurement of surface mount components? Extech offers the RC100 Passive Component R/C SMD Tweezer Meter (see p. 51). It displays Resistance, Capacitance, and Diode Test. Convenient one-handed operation for SMD component sorting or inspection!





**382200/382202
Digital Single Output
DC Power Supplies**

Adjustable 30V/1A and 18V/3A supplies with dual LCD displays

- Constant voltage or current
- Dual backlit LCD displays for voltage and current
- Short circuit protection
- Current limiting
- High load/line regulation
- Low noise/ripple
- Banana plug output terminals
- Complete with power cord



**382203/382213
Analog or Digital
Triple Output
DC Power Supply**

Adjustable to 30V/3A with fixed 5V and 12V outputs

- Adjustable Voltage and Current output
- Easy snap terminals for fixed 5V/0.5A and 12V/1A outputs
- Constant Voltage or Current
- Current limiting indicator
- Overload and short circuit protection
- Binding post terminals for variable supply
- Complete with power cord



3-in-1 Power Supply!

**382260 80 Watt
Switching Mode DC
Power Supply**

3 output ranges perform like 3 power supplies in one

- 3 selectable ranges:
 - 0.10 to 16.40V/0.100 to 5.100A
 - 0.10 to 27.60V/0.100 to 3.100A
 - 0.10 to 36.80V/0.100 to 2.300A
- 4-Digit LED displays
- Front/Rear output terminals
- Remote sensing for accurate applied voltage at load point
- Compact slim tower housing is ideal for tight workbench
- Lightweight for easy portability
- Complete with AC power cord

382200	382202	382203	382213	382260
Dual LCD	Dual LCD	Analog	Digital LCD	Digital LED (dual display)
0 to 30.0V	0 to 18.0V	0 to 30V	0 to 30V (0.1V)	3 to 15V
0 to 1.00A	0 to 3.00A	0 to 3A	0 to 3A (0.01)	0.10 to 16.40V; 0.10 to 27.60V; 0.10 to 36.80V 0.100 to 5.100A; 0.100 to 3.100A; 0.100 to 2.300A
±(1.5%rdg); ±(2%rdg)	±(1.5%rdg); ±(2%rdg)	±7%FS	±1%FS	±1%
<0.5mV/<3mA	<0.5mV/<3mA	<5mV	<5mV	<30mV
< 0.01% + 3mV/< 0.2% + 3mA	< 0.01% + 3mV/< 0.2% + 3mA	<0.05%+10mV	<0.05%+10mV	<4mV
< 0.01% + 2mV/< 0.2% + 3mA	< 0.01% + 2mV/< 0.2% + 3mA	<0.05%+10mV	<0.05%+10mV	<20mV
110V/60Hz	110V/60Hz	110/220 VAC (50/60Hz)	110/220 VAC (50/60Hz)	90-264VAC (47-63Hz)
9.4 x 4.25 x 6" (240 x 108 x 154mm)	9.4 x 4.25 x 6" (240 x 108 x 154mm)	6x5.6x9.5" (152x142x242mm)	6x5.6x9.5" (152x142x242mm)	13x5x2" (330x127x53.3mm)
4.4lbs. (2 kg)	6.6lbs. (3kg)	11lbs (5kg)	11lbs (5kg)	4.21lbs (1.9kg)
—	—	Yes	Yes	Yes
1 year	1 year	1 year	1 year	1 year



DC Power Supplies

Extech offers a complete range of DC power supplies, including Analog, Digital, and Dual Display models that meet the needs of the hobbyist, product designer and the production engineer.

Featuring Model 382275



▶ 600 Watt Switching Power Supply

High efficiency single output with minimum power loss

▶ User-Defined Presets

Two user-defined presets and one 13.8V/20A factory preset

▶ Intelligent Fan Speed Control

Produces a quiet running power supply

▶ Remote Control

For Output Voltage/Current and On/Off



Specifications

Model
Analog or Digital Display
DC Voltage Output (Max Res.)
DC Current Output (Max Res.)
Basic Accuracy
Type
Ripple and Noise
Line Regulation
Load Regulation
Power
Dimensions
Weight
CE
Warranty



382270 210 Watt Quad Output DC Power Supply

Two fully adjustable outputs combined with two auxiliary (semi adjustable) outputs

- Two 0 to 30V/0 to 5A outputs with selectable Constant Voltage and Constant Current modes
- Two auxiliary outputs with variable voltage and fixed current of 3 to 6.5V/3A and 8 to 15V/1A
- Outputs up to 60V in series mode or 10A in parallel mode
- Overload and short circuit protection
- Complete with 4 pairs of test leads (banana plug to alligator clip)



382280 200 Watt Triple Output Programmable DC Power Supply

40V/5A programmable supply with high resolution output and 200 test setup memories; 1 adjustable and 2 fixed outputs

- High resolution (1mV and 1mA) user programmable output
- Selectable constant Voltage or Current modes
- 0 to 60 second programmable overload delay timer
- Storage/Recall memory
- High stability with low ripple and noise
- Forced air cooling fan
- Bi-directional PC interface commands allow setup and readback using Windows® HyperTerminal or similar PC communications programs
- Dual output terminal for source and monitor connections



382275 600 Watt Single Output Laboratory Grade DC Power Supply

Dual Action Voltage and Current Controls with push knob for fine and coarse adjustments

- Remote Control for output Voltage/Current and On/Off
- Two user-defined Voltage and Current presets and one 13.8V/20A factory preset
- Adjustable 0 to 30V/ 0 to 20A output
- Automatic Constant Current crossover
- Dual 3-Digit LED displays
- High RFI immunity and excellent EMI
- Thermostatic Control Fan from zero to full speed
- Overload, over-temperature, and short circuit protection
- Low profile and small footprint
- Complete with power cord; 382275 - 120VAC model 382276 - 220VAC model

382270	382280	382275	382276
Digital LED (Dual display)	Digital Backlit LCD (dual display)	Digital LED (Twin display)	
0 to 30V, 0 to 30V, 3 to 6.5V, 8 to 15V	0 to 40V (1mV)	0 to 30V (0.1V)	
5A 5A 3A 1A	0 to 5A (1mA)	0 to 20A (0.1A)	
±(0.5%+2 digits)	±(0.05%+9mV), ±(0.2%+9mA)	±(0.5%+2 digits)	
Linear	Linear	Switching	
<0.5mV	<3mV	<5mV	
<0.02%+3mV	—	<20mV	
<0.02%+3mV	1mV/A	<50mV/100mA	
110/240VAC (50/60Hz)	110/220 VAC (50/60Hz)	120VAC (50/60Hz)	220 VAC (50/60Hz)
10.2x6.3x14.5" (260x160x370mm)	12.2x9.9x5.3" (310x250x135mm)	7.9x3.5x8.5" (200x90x215mm)	
26.5lbs(12kg)	10lbs (4.5kg)	5.7lbs (2.6kg)	
—	Yes	Yes	
1 year	1 year	1 year	

42509 IR Thermometer with Color Alert

NEW

Fastest and Easiest to use

Programmable alarm with fast two-color display and audible alarm

Features:

- Great for processes that require temperature control and monitoring
- Fast, accurate measurements at 12" where the two lasers converge with 12:1 field of view
- Measures up to 950°F (510°C)
- Blue backlit dual LCD display changes to Red when reading exceeds High or Low set points
- Exclusive 150 millisecond instantaneous response for capturing spikes in temperature
- Max mode captures and holds rapidly changing temperatures
- Lock function for continuous readings
- Adjustable emissivity increases measurement accuracy for different surfaces
- Adjustable High/Low set points with audible alarm alerts user when temperature exceeds the programmed set points
- Double molded housing
- Complete with case and 9V battery

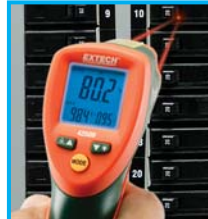

Blue backlight: within temperature range



Red backlight plus audible alert: exceeds temperature



Specifications	Function	
	Laser Convergence Distance	12" (30.5 cm)
	Range	-4 to 950°F (-20 to 510°C)
	Repeatability	±0.5% or 1.8°F/1°C
	Basic Accuracy	±(1% of rdg + 2°F/1°C)
	Max resolution	0.1°F/C
	Emissivity	0.10 to 1.00 Adjustable
	Field of View (Distance to Target)	12:1
	Dimensions	5.7x4x1.6" (146x104x43mm)
	Weight	5.7oz (163g)

Ordering

4250912" Distance Dual Laser InfraRed Thermometer
42509-NIST42509 with NIST Certificate

42512 Dual Laser IR Thermometer

Fast and accurate measurements to 1832°F (1000°C)

Features:

- Dual laser simplifies distance-to-target ratio—no more calculations!
- Accurate measurements at 30" distance
- Exclusive 150 millisecond instantaneous response for capturing spikes in temperature
- Max mode captures and holds rapidly changing temperatures
- Lock function for continuous readings
- White backlit dual LCD display
- Adjustable emissivity increases measurement accuracy for different surfaces
- Double molded housing
- Adjustable High/Low set points with audible alarm alerts user when temperature exceeds the programmed set points
- Complete with carrying case and 9V battery



30" Distance IR



Fast response captures hot spots



Specifications	Function	
	Laser Convergence Distance	30" (76.2 cm)
	Range	-58 to 1832°F (-50 to 1000°C)
	Repeatability	±0.5% or 1.8°F/1°C
	Basic Accuracy	±(1% of rdg + 2°F/1°C)
	Max resolution	0.1°F/C
	Emissivity	0.10 to 1.00 Adjustable
	Field of View (Distance to Target)	30:1
	Dimensions	5.7x4x1.6" (146x104x43mm)
	Weight	5.7oz (163g)

Ordering

4251230" Distance Dual Laser InfraRed Thermometer
42512-NIST42512 with NIST Certificate

42570 High Temperature IR Thermometer

Fast response (100ms) with highest accuracy at point where dual lasers converge plus Type K input and USB interface

Features:

- High 50:1 distance to target ratio measures smaller surface areas at greater distances
- Dual Laser Targeting indicates ideal measuring distance when two laser points converge to 1" target spot
- Fast 0.10 second response time
- Lock function for continuous measurements
- Stores up to 100 readings
- White backlit LCD with bargraph
- MAX/MIN/AVG/DIF functions
- Adjustable emissivity
- Adjustable High/Low set points with audible alarm
- Tripod mounting feature
- Complete with Type K bead wire probe (-22 to 572°F/ -30 to 300°C), USB cable and PC software, tripod, 9V battery and case
(See pages 42 and 80 for Type K Thermocouple probes)



Type K input



Fast, easy-to-use, dual laser pointer converge at 50" distance from target providing precise reading without the guesswork.

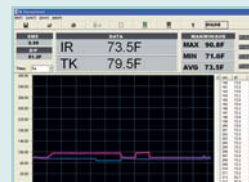

PC software included

Function	
Laser Convergence Distance	50" (127cm)
IR Temperature Range	-58 to 3992°F (-50 to 2200°C)
Repeatability	±0.5% or 1.8°F/1°C
Basic Accuracy	±(1% of rdg + 2°F/1°C)
Max resolution	0.1°F/°C
Emissivity	0.10 to 1.00 Adjustable
Field of View (Distance to Target)	50:1
Type K Range	-58 to 2498°F (-50 to 1370°C)
Dimensions/Weight	8x6.1x2" (204x155x52mm)/ 11.3oz (320g)

Ordering

42570.....50" Distance Dual Laser InfraRed Thermometer
42570-NISTL*42570 with NIST Certificate

**Limited NIST for Certificate of Traceability from -4 to 1500°F (-20 to 815°C).*

42560 IR Thermometer with Wireless PC Interface

Wireless USB interface transmits temperature data to a PC

Features:

- Place meter on the Base to transmit wirelessly continuous readings to the Remote Receiver connected to a PC via USB cable
- High 30:1 distance to target ratio
- Built-in laser pointer
- Lock function for continuous measurements
- Stores up to 20 readings
- Type K temperature function
- MAX/MIN/AVG/DIF functions
- Manual/Automatic emissivity
- High/Low set points with audible alarms
- Data Hold, Auto power off with disable function, low battery indication, 1mV/°F analog output
- Tripod mounting feature
- Complete with Transmitter Base, Remote Receiver with USB cable, Type K bead wire probe (-22 to 572°F/-30 to 300°C), tripod, analog output cable, PC software, 9V battery, AC adaptor, and hard case
See p. 80 for additional Type K Thermocouple probes (sold separately)



Type K input

WIRELESS Transmitter



Continuous wireless data transfer to the PC using the receiver and software (included). Meter is mounted on a tripod for applications that requires an on-going temperature monitoring of a specific area when meter is set on lock measuring position.

Function	
IR Range	-58 to 1922°F (-50 to 1050°C)
Type K Range	-58 to 2498°F (-50 to 1370°C)
Repeatability	±0.5% or ±1.8°F/1°C
Basic Accuracy	IR: ±2% or ±4°F/2°C ; Type K: ±1.5% ±5°F/3°C
Max. Resolution	0.1°F/°C
Emissivity	0.1 to 1.00 Adjustable
Field of View (Distance to Target)	30:1
Power	9V battery; AC adaptor for Base
Dimensions/Weight	3.9x2.2x9" (100x56x230mm)/ 10.2oz (290g)

Ordering

42560IR Thermometer w/Wireless PC Interface (918MHz)
42560-NIST42560 with NIST Certificate

42560-EIR Thermometer w/Wireless PC Interface (433MHz)
42560-E-NIST42560-E with NIST Certificate

TR100Spare Tripod

(NOTE: USA, Mexico, and Canada use 918MHz model and majority of other countries use 433MHz model)



InfraRed Thermometers

Extech's range of High Temperature IR Thermometers include models with alarms, Type K inputs or Datalogging and printing capabilities.



Featuring Model 42545

▶ High Temperature

-58 to 1832°F (-50 to 1000°C) for demanding applications

▶ 50:1 Distance to Target

Measures small areas from greater distances

▶ Laser Pointer

Identifies target area and improves aim

50:1 field of view

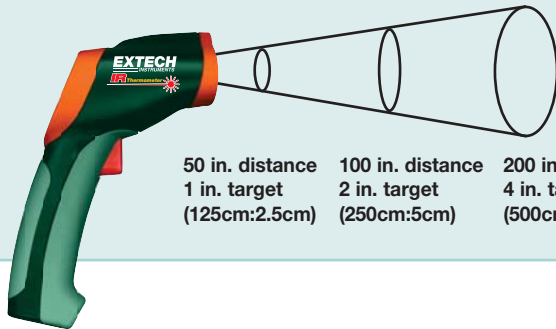

All models include carrying case (either soft or hard) and 3 year warranty

Order Meter with NIST Certificate*

All Extech meters come factory calibrated. For an additional charge, Extech will supply your meter with a Certificate of Calibration Traceable to N.I.S.T. with Data at multiple points. **To order meter with NIST:**

- 42515-NIST
- 42540-NIST
- 42545-NIST

*Only products listed are available with NIST Certificate. Meter must be ordered with NIST Certificate at time of purchase.

Specifications

Model	
Range	
Basic Accuracy	
Repeatability	
Max. Resolution	
Emissivity	
Field of View (Distance to Target)	
Dimensions	
Weight	
CE	
Warranty	



Type K input for contact measurements

42515 1472°F (800°C), 13:1, IR Thermometer Type K Input, Memory

Automatic Emissivity Adjustment allows accurate measurement of virtually any surface

- ✓ Wide temperature range for IR temperature and type K thermocouple measurements
 - ✓ Automatic emissivity adjustment (for temperatures 212°F or higher)
 - ✓ Memory stores up to 20 readings
 - ✓ Adjustable high/low visual and audible alarm
 - ✓ MAX/MIN/AVG/DIF features display highest, lowest, average, and MAX minus MIN values
 - Large LCD display with bright backlight
 - Built-in laser pointer improves aim
 - Data Hold, Auto power off, and Low battery indication
 - Complete with 9V battery, type K bead wire probe (-22 to 572°F/-30 to 300°C), and soft case
- See pages 42 and 80 to order other Type K probes



42540 1400°F (760°C), 16:1, with Alarm, IR Thermometer

16:1 distance to target ratio, rugged thermometer

- ✓ High Temperature range from -58° to 1400°F (-50 to 760°C)
- ✓ 16 to 1 distance to target ratio
- ✓ Adjustable high/low alarm alerts user visually and audibly when temperature exceeds programmed limits
- ✓ Adjustable emissivity for better accuracy on different surfaces
- ✓ MIN/MAX/AVG/DIF features display highest, lowest, average, and MAX minus MIN values
- Large backlit display
- Laser pointer identifies target area
- Automatic Data Hold
- Auto power off
- Complete with 9V battery and hard carrying case



42545 1832°F (1000°C), 50:1, with Alarm, IR Thermometer

50:1 distance to target ratio

- ✓ Highest 50 to 1 distance to target ratio measures smaller surface areas at greater distances
- ✓ Widest Temperature range from -58 to 1832°F (-50 to 1000°C)
- ✓ Adjustable high/low alarm alerts user visually and audibly when temperature exceeds programmed limits
- ✓ Adjustable emissivity for better accuracy on different surfaces
- ✓ MIN/MAX/AVG/DIF features display highest, lowest, average, and MAX minus MIN values
- Large backlit display
- Laser pointer identifies target area
- Automatic Data Hold
- Auto power off
- Complete with 9V battery and hard carrying case

42515	42540	42545
-58 to 1472°F (InfraRed); -58 to 2498°F (Type K) -50 to 800°C (InfraRed); -50 to 1370°C (Type K) (IR) ±2%rdg or 4°F (2°C); ±1.5%rdg + 2°F/1°C (Type K)	-58 to 1400°F -50 to 760°C ±2%rdg or 4°F (2°C) whichever is greater < 932°F (500°C); ±(2.5%rdg + 5°) > 932°F (500°C)	-58 to 1832°F -50 to 1000°C 2%rdg + 4°F/2°C < 932°F (500°C); 3% + 9°F/4°C > 932°F (500°C)
±0.5% or ±1.8°F/1°C 0.1°F/°C	±0.5% or ±1.8°F/1°C 0.1°F/°C	±0.5% or ±1.8°F/1°C 0.1°F/°C
0.1 to 1.00 Adjustable	0.1 to 1.00 Adjustable	0.1 to 1.00 Adjustable
13:1	16:1	50:1
3.2 x 1.6 x 6.3" (82x42x160mm)	3.9x2.2x9" (100x56x230mm)	3.9x2.2x9" (100x56x230mm)
6.4oz (180g)	10.2oz (290g)	10.2oz (290g)
Yes	Yes	Yes
✓ 3 years	✓ 3 years	✓ 3 years



InfraRed Thermometers

Extech's non-contact InfraRed thermometers point and measure technology provide fast, easy and accurate readings for most surface temperature measurements.

Featuring Model 42510A

▶ Programmable Alarm

Adjustable High/Low set points alert user when temperature exceeds set point

▶ Adjustable Emissivity

For better accuracy on different surfaces

▶ Laser Pointer

Identifies target area and improves aim

▶ High Accuracy

With $\pm 1\%$ rdg basic accuracy and 0.1° resolution to 199.9°



Mini size

IR100 446°F (230°C), 1:1, Mini IR Thermometer

Mini size design for the ultimate convenience and portability

- Measures non-contact surface temperature up to 446°F (230°C)
- Economical mini size design for convenience
- Automatic Data Hold when measure button is released
- Max Hold or Min Hold
- Lock feature for continuous scanning
- Fixed 0.95 emissivity covers 90% of surface applications
- Auto power off
- Complete with CR2032 3V battery



Applications

Choose the best InfraRed Thermometer to fit your application needs by selecting the proper measurement range, field of view, resolution, and accuracy. Applications include Refrigeration, Boiler, Pavement, Printer/Copier, HVAC/R, Automotive, and Industrial Troubleshooting.

Order Meter with NIST Certificate*

All Extech meters come factory calibrated. For an additional charge, Extech will supply your meter with a Certificate of Calibration Traceable to N.I.S.T. with Data at multiple points. **To order meter with NIST:**

42500-NIST
42510A-NIST

*Only products listed are available with NIST Certificate. Meter must be ordered with NIST Certificate at time of purchase.

Specifications

Model	IR100
IR Temperature (Non-contact)	-31 to 446°F -35 to 230°C
Basic Accuracy	$\pm(2.0\%rdg)$ or $\pm 4^\circ F/2^\circ C$
Max. Resolution	0.1°
Emissivity	0.95 fixed
Field of view (Distance to Target)	1:1
Dimensions	3x1.6x0.7" (75x40x18mm)
Weight	1.5oz (43g)
CE	Yes
Warranty	1 year



Palm size



Compact Handheld size



Compact Handheld size

IR201 518°F (270°C), 6:1, Pocket Laser IR Thermometer

Handy troubleshooting thermometer with laser pointer

- Measures non-contact surface temperature up to 518°F (270°C)
- Economical small pocket size design for convenience
- Built-in laser pointer identifies target area
- Data Hold and Max Hold
- Auto power off
- Fixed 0.95 emissivity covers 90% of surface applications
- Complete with two AAA batteries and pouch case

42500 500°F (260°C), 6:1, Compact Laser IR Thermometer

Compact thermometer measures up to 500°F (260°C)

- Built-in laser pointer identifies target area
- Backlighting
- Automatic Data Hold when trigger released
- Fixed 0.95 emissivity covers 90% of surface applications
- Auto power off
- Complete with 9V battery and pouch case

42510A 1200°F (650°C), 12:1, Compact Laser IR Thermometer

Compact thermometer with high accuracy

- ✓ Adjustable high/low visual and audible alarm
- ✓ Adjustable emissivity for better accuracy on different surfaces
- Measures temperature from -58 to 1200°F (-50 to 650°C) with 0.1° resolution up to 199.9°
- Built-in laser pointer identifies target area
- Backlighting
- Overrange indicator
- Automatic Data Hold when trigger released
- MAX/MIN features display highest and lowest values
- Auto power off
- Complete with 9V battery and pouch case

IR201	42500	42510A
-4 to 518°F	-4 to 500°F	-58 to 1200°F
-20 to 270°C	-20 to 260°C	-50 to 650°C
±(2.5%rdg±3°F/2°C)	±2% of reading or ±4°F/±2°C (whichever is greater)	±(1% of reading + 2°F/1°C)
1°F/°C	1°F/°C	0.1°F/°C; 1°F/°C
0.95 fixed	0.95 fixed	0.1 to 1.00 Adjustable
6:1	6:1	12:1
3.7x2x1" (94x51x25mm)	3.2x1.7x6.7" (82x44x170mm)	3.2x1.6x6.3" (82x42x160mm)
2.7oz (76g)	4.9oz (140g)	6.4oz (180g)
Yes	Yes	Yes
1 year	✓3 years	✓3 years



Thermocouple Thermometers, Datalogger, Printer

Extech offers a selection of thermometers with datalogging and printing capabilities for data storage analysis and report generation.

Featuring Model HD200

► Dual Input

Differential temperature measurements for servicing refrigeration and air conditioning

► IR Thermometer Probe

For non-contact temperature measurements from -22 to 1022°F (-30 to 550°C) for surfaces that are hard-to-reach or unsafe to touch

► Triple Display

Simultaneously view [T1, T2, T3 (IR)] or [T1-T2] or [T1-T3] or [T2-T3]



Accessories



TP882 High Temperature Penetration Probe



TP200 Clamp Probe

- TP200.....Type K Clamp Probe (-40 to 212°F)
 - TP882.....Type K Penetration Probe (-50 to 1000°F)
 - 872502.....Type J Bead Wire Probe (-328 to 392°F)
 - 801515.....Type J, 4" (100mm) General Purpose Temperature Probe (-328 to 842°F)
 - 409996.....Soft Vinyl Pouch Carrying Case (for EA15)
- See pages 42 and 80 for additional temperature probes.

Order Meter with NIST Certificate*

All Extech meters come factory calibrated. For an additional charge, Extech will supply your meter with a Certificate of Calibration Traceable to N.I.S.T. with Data at multiple points. **To order meter with NIST:**

- EA11A-NIST
- TM100-NIST
- EA10-NIST
- EA15-NIST
- HD200-NIST

*Only products listed are available with NIST Certificate. Meter must be ordered with NIST Certificate at time of purchase.

Specifications

Model	EA11A	TM100
Single or Dual Input	Single	Single
Type K °F (°C)	-58 to 1999°F (-50 to 1300°C)	-328 to 2501°F (-200 to 1372°C)
Type J °F (°C)	—	-346 to 2012°F (-210 to 1100°C)
InfraRed °F (°C)	—	—
Basic Accuracy	±0.3% rdg	±0.15% rdg
Resolution	0.1°/1°	0.1°/1°
Datalogging	—	—
Dimensions	5.9x2.8x1.3" (150x72x35mm)	8.7x2.5x1.1" (220x 63 x 28mm)
Weight	8.3oz (235g)	7oz (200g)
CE	Yes	Yes
Warranty	1 year	1 year



EA11A EasyView® Type K Single Input Thermometer

Large dual LCD display with 0.3% accuracy and memory

- Simultaneously displays current temperature and Max/Min/Avg or stored memory location
- Selectable units of °F and °C
- Manually store/recall up to 150 readings
- Data Hold and Auto power off
- Records MAX/MIN/AVG readings for later recall
- Complete with built-in stand, protective holster, Type K bead wire probe (-4 to 482°F/-20 to 250°C), and 6 AAA batteries. (Optional temperature probes available on pages 42 and 80)



NEW

TM100 Type J/K Single Input Thermometer

Side-mounted controls allow for convenient one-handed operation

- Large backlit LCD display
- Wide temperature range with 0.1°/1° resolution
- Readout in °F, °C, or K (Kelvin)
- Data Hold function freezes reading on display
- Max/Min/Avg readings with relative time stamp
- Offset key used for zero function to make relative measurements
- Auto Power off with disable feature
- Complete with Type K bead wire temperature probe (-22 to 572°F/-30 to 300°C) and 9V battery



**EA10 EasyView®
Type K Dual input
Thermometer with
Dual readings**

Big backlit display with relative and elapsed time indication

- Displays [T1 and T2] or [T1-T2 and T1] or [T1-T2 and T2]
- Selectable units of °C/°F or Kelvin
- Timer function displays elapsed time plus the time when MAX/MIN readings are taken
- OFFSET key used for zero function to make relative measurements
- Data hold and Auto power off
- Complete with built-in stand, protective holster, two Type K bead wire temperature probes (-4 to 482°F/-20 to 250°C), and 6 AAA batteries. (Optional temperature probes available on pages 42 and 80)

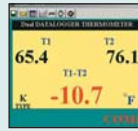

Software Included

**EA15 EasyView®
7 Thermocouple
Datalogger**

Internal memory stores up to 8800 data sets

- Seven Thermocouple type selections: K, J, T, E, R, S, N
- Large backlit display
- Stores Time, T1 and T2
- Manual push-button datalogging or automatic with programmable sample rate of 3 to 355 seconds per reading
- Manual record/recall of data
- Data Hold and Auto power off
- MAX/MIN/AVG or MAX/MIN with elapsed time
- Complete with two Type K bead wire temperature probes (-4 to 482°F/-20 to 250°C), Windows® 95/98/ME/NT/2000/XP compatible software, RS-232 cable for data transfer, protective holster, case, and 6 AAA batteries



USB port with PC Software

**HD200 Differential
Thermometer
Datalogger + IR**

Automatically stores up to 18,000 readings and takes differential temperature readings with dual Type K thermocouple probes plus non-contact surface temperature measurement using IR Thermometer Probe

- Display [T1, T2, T3 (IR)] or [T1-T2] or [T1-T3] or [T2-T3]
- Records in a continuous mode up to 18,000 readings
- Differential displays for HVAC/ Superheat measurements
- Heavy duty double molded housing
- MAX/MIN/AVG and Data Hold
- USB port includes PC software
- Includes IR Thermometer probe (HD200-IR) with 8:1 distance to target ratio and Laser pointer
- Complete with two Type K bead wire temperature probes (-22 to 572°F/-30 to 300°C), IR probe, built-in stand, Windows® compatible software, USB cable, hard carrying case, and 9V battery

EA10	EA15	HD200	Model
Dual	Dual	Dual + IR	Single or Dual Input
-200 to 1999°F (-200 to 1360°C)	-200 to 1994°F (-150 to 1090°C) -200 to 1999.9°F (-150 to 1370°C)	-328 to 2501°F (-200 to 1372°C)	Type K °F (°C)
—	—	—	Type J °F (°C)
±0.3% rdg	±0.05% rdg	-22 to 1022°F (-30 to 550°C) with IR probe	InfraRed °F (°C)
0.1°/1°	0.1°	±0.15%	Basic Accuracy
—	8800 readings	0.1°/1°	Resolution
6x2.8x1.5" (152x72x37mm)	5.91x2.83x1.38" (150x72x35mm)	18,000 readings	Datalogging
8.3oz (235g)	8.3oz (235g)	7.9x2.9x1.9" (201x75x50mm)	Dimensions
Yes	Yes	9.8oz (280g)	Weight
1 year	1 year	Yes	CE
		✓3 years	Warranty



Thermocouple Thermometers, Datalogger, Printer

Extech offers a selection of thermometers with datalogging and printing capabilities for data storage analysis and report generation.

Featuring Model 421509

▶ 7 Thermocouple Types

Use with J, K, T, E, R, S, and N Thermocouples

▶ Datalogger plus PC software (included)

Stores up to 1024 readings for further analysis using PC software

▶ Differential Temperature

Calculates the difference between two temperature readings (T1-T2) for Type J, Type K, or both Type J and K

▶ Programmable Alarm

High and Low temperature setpoints with audible alarm

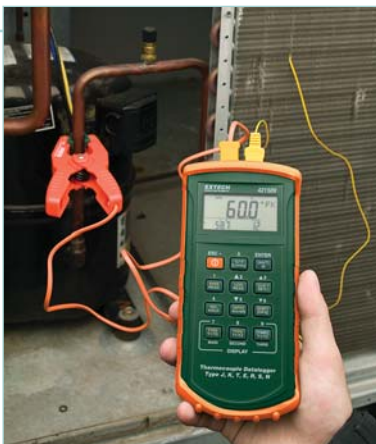

Dual Type K Thermometer for differential temperature measurement in HVAC applications

Order Meter with NIST Certificate*

All Extech meters come factory calibrated. For an additional charge, Extech will supply your meter with a Certificate of Calibration Traceable to N.I.S.T. with Data at multiple points. **To order meter with NIST:**

421502-NIST
421509-NIST
407907-NIST

*Only products listed are available with NIST Certificate. Meter must be ordered with NIST Certificate at time of purchase.

Specifications

Model
Single/Dual Input
Type K °F (°C)
Type J °F (°C)
RTD/Thermistor °F (°C)
Basic Accuracy
Max. Resolution
Datalogging
Dimensions/Weight
CE
Warranty

Accessories:

(See pages 42 and 80 for Thermocouple/RTD Temperature Probes)

AC Adaptor

156119117V AC Adaptor (for 407907)

156221220V AC Adaptor (for 407907)

Carrying Case

409997Soft Vinyl Pouch Case (for 421502, 421509)

140001Hard Vinyl Carrying Case (for Heavy Duty Series)



421502 Type J/K, Dual Input Thermometer with Alarms

Dual J or K input with dual display, relative and programmable High/Low audible alarms

- Widest range with highest 0.05% accuracy
 - Rugged design for field use
 - Large dual LCD displays T1, T2 or T1-T2, plus Elapsed Time
 - Differential temperature between Type J, Type K, or both Type J and K
 - MIN/MAX/AVG readings
 - Data Hold and Relative functions
 - Programmable Hi/Lo audible alarms
 - Complete with two Type K bead wire temperature probes (-4 to 482°F/-20 to 250°C), protective holster with stand, and 9V battery
- (Optional temperature probes available on pages 42 and 80)*



421509 7 Thermocouple Datalogger with Alarm

Memory stores up to 16 data sets, 1024 maximum data capacity

- Seven Thermocouple type selections: K, J, T, E, R, S, N
- Large backlit LCD with two secondary displays for simultaneous T1, T2, T1-T2, Time and advanced readouts
- T/C offset adjustment
- REC, MAX, MIN, MAX-MIN, AVG and °C/°F switchable
- Data Hold and Relative function
- Bi-directional RS-232 PC interface
- Programmable Hi/Lo alarm with Real time clock with calendar
- Auto power off with disable feature
- Complete with two Type-K bead wire temperature probes (-4 to 482°F/-20 to 250°C), Windows® 95/98/ME/NT/2000/XP compatible software, RS-232 cable, protective holster, and 9V battery

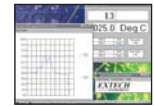

See p. 108 for details on Data Acquisition software & Datalogger.

407907 Heavy Duty RTD Thermometer with PC Interface

Higher resolution to 0.01° over wide Temperature ranges

- Wide temperature range measures to 1562°F (850°C)
- Built-in linearity correction with fast response
- Sampling time of 0.4 second
- Built-in RS-232 PC serial interface with optional 407001 Windows® 95/98/NT/2000/XP compatible Data Acquisition software and 380340 Datalogger (see page 108 for full details)
- Accepts 4 wire Pt-100Ω RTD probes with 4-pin connector
- Data Hold
- Complete with protective holster with stand and 9V battery (stainless steel RTD Temperature probes with 4-pin plugs sold separately)

421502	421509	407907
Dual	Dual	No
-328 to 2498°F (-200 to 1370°C)	-328 to 2501°F (-200 to 1372°C)	—
-328 to 1922°F (-200 to 1050°C)	-346 to 2192°F (-210 to 1200°C)	—
—	—	RTD: -199.99 to 1562°F (-199.99 to 850°C)
±0.05% rdg	±0.05% rdg	±(0.1%rdg+0.4°F/0.2°C)
0.2°F/0.1°C	0.1°	0.01°
—	1024 readings	Optional Datalogger 380340 (p.108)
7.63x3.6x2.1" (192x91x53mm)/13oz (365g)	7.5x3.6x2.0" (192x91x53mm)/12.8oz (365g)	7.1x2.8x1.3" (180x72x32mm)/10oz (285g)
Yes	Yes	Yes
1 year	1 year	✓3 years

Thermocouple Temperature Probes

Bead Wire probes

Probes for air and surface temperature measurement (not suitable for liquids).

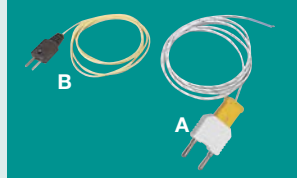

Surface probe

Flat tip is specially designed for making surface temperature measurements.



General Purpose probes

Suitable for air and liquid temperature measurement.

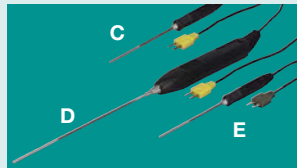

Clamp probe (212°F/100°C)

Conveniently fits 0.25 to 1.5" (6.4 to 38mm) pipes



Penetration probes

Ideal for food service, liquids or gels.

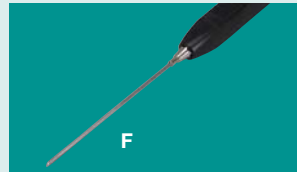

High Temperature Clamp probe (450°F/232°C)

Conveniently fits 0.25 to 1.5" (6.4 to 38mm) pipes



RTD Temperature Probes

General Purpose Probe

Suitable for air and liquid temperature measurement.

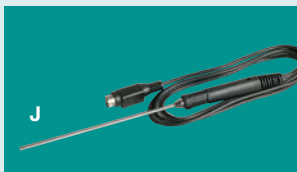

Surface Probe

Flat tip is specially designed for making surface temperature measurements.



Air probe

Suitable for air temperature measurement.



Ordering:

Temperature Probes with 39" (1m) cable

Bead Wire

- A. TP873Type K Bead Wire Temperature Probe (-22 to 572°F/-30 to 300°C)
- B. 872502Type J Bead Wire Temperature Probe (-328 to 392°F/-200 to 200°C)

General Purpose

- C. 871515Type K, 4" (100mm) General Purpose Probe (-32 to 1292°F/-200 to 700°C)
- D. 881605Type K, 8" (203mm) General Purpose Probe, (-328 to 1292°F/-200 to 700°C)
- E. 801515Type J, 4" (100mm) General Purpose Probe (-328 to 842°F/-200 to 450°C)

Penetration

- F. 881603Type K, 6" (150mm) Immersion Probe, (-58 to 1292°F/-50 to 700°C)

Surface

- G. 881602Type K, 6" (150mm) Surface Probe, (-58 to 1472°F/-50 to 800°C)
- H. TP200Type K Pipe Clamp Probe, (-40 to 212°F/-40 to 100°C)
- I. TP400Type K Pipe Clamp Probe, (-4 to 450°F/-20 to 232°C)

RTD Probes

- J. 850187RTD General Purpose probe, (-328 to 932°F/-200 to 500°C)
- K. 850186RTD Surface probe, (-328 to 482°F/-200 to 250°C)
- L. 850189RTD Air probe, (-328 to 752°F/-200 to 400°C)



Soft pouch case included

392085 Pocket Thermometer

Audible High/Low Alarms

- Audible alarm alerts user when pre-set MAX/MIN temperature is reached or exceeded; Data Hold
- Durable 2.5" (64mm) stainless steel probe with 20" (508mm) cable
- Temperature: -58 to 302°F (-50 to 150°C), ±1.8°F/1°C basic accuracy, 0.1°/1° resolution
Dims: 4.8x3x0.8" (122x76x20mm)
Weight: 3.4oz (96g)
- Complete with case, stainless steel probe, and 1.5V button battery



401012 Indoor/Outdoor Temperature Alarm

Audible Alarm alerts user when Temperature exceeds the setpoints

- Displays indoor/outdoor temperature
- Single or Dual point audible alarm (external sensor)
- -58.0 to 158.0°F, ±1.8°F accuracy, 0.1°F resolution; Dims: 2.75x2.75" (70x70mm), Weight: 3oz (85g)
- Complete with internal plus 10ft (3m) weatherproof temperature sensor with adhesive backing, stand, one AAA battery, and screws for wall mounting



401014 Big Digit Indoor/Outdoor Thermometer

Built-in memory stores Minimum and Maximum Temperature readings

- Large LCD displays 1" (25mm) digits for indoor/outdoor temperature
- Indoor Range: 14 to 140°F (-10 to 60°C)
Outdoor Range: -58 to 158°F (-50 to 70°C)
±1.8°F /1°C accuracy; 0.1°F/°C resolution
Dims: 4.4x4x0.9" (112x102x22mm)
Weight: 6.5oz (186g)
- Complete with weatherproof temperature sensor with 9.6ft (3m) thin cable, stand, AAA battery, and wall mounting bracket

CE All temperature indicators featured on this page are CE certified and include a one year warranty



39240 Waterproof Thermometer

Pocket-size with MAX/MIN recording

- 2.75" (70mm) Stainless steel stem
- Data Hold and Auto power off
- Temperature: -40 to 392°F (-40 to 200°C), ±2°F/1°C accuracy, 0.1°/1° resolution
- Dims: 5.9x0.8x0.7" (150x20x18mm)
- Weight: 0.7oz (20g)
- Complete with one LR44 button battery and protective cover



392050 Penetration Dial Thermometer

Sharp stainless steel probe measures temperature in air, liquids, and semi-solids

- 5" (130mm) stainless steel probe with 2" (54mm) dial
- Range: -58 to 302°F (-50 to 150°C)
- ±2°F/1°C accuracy, 0.1°/1° resolution
- ON/OFF switch saves battery life
- Auto Power off after 1 hour
- Weight: 1oz (29g)
- Complete with 1.5V LR44 battery



39272 Pocket Fold-up Thermometer with Adjustable probe

4.5" (114mm) stainless steel probe adjusts from 0 to 180°

- Detents at 45°, 90°, 135°, and 180°
- Fast response; Auto Power off after 1 hour
- Data Hold and Min/Max
- Temperature: -58 to 572°F (-50 to 300°C), ±1.8°F/1°C, 0.1°/1° resolution
- Dims: 6.1x2x0.8" (154x50x20mm)
Weight: 2.5oz (71g)
- Complete with wrist strap & AAA battery

RH520A Humidity+Temperature Chart Recorder

Best value graphical datalogger in the market that's easy to set up and operate



Features:

- Simultaneous numerical & graphical display of Humidity and Temperature readings, plus Time and Date
- Large dual graphical LCD displays with adjustable vertical and horizontal resolution indicate % of memory remaining
- Internal memory records up to 49,000 data points can be transferred to a PC
- Detachable probe extends to 3ft (1m)
- Audible and visual alarm with Hi/Low setpoints
- Output socket used with optional external alarm module
- Complete with built-in stand, detachable probe with 3ft (1m) cable, RS232 cable, RS-232 to USB adaptor, LabView-based PC software, 100-240VAC 50/60Hz adaptor, and 3 AA batteries



Function	
Relative Humidity range	10.0 to 95.0%
Temperature range	-20.0 to 140.0°F (-28.0 to 60.0°C)
Basic Accuracy	±3% Relative Humidity; ±1.8°F (±1°C)
Dimensions	5 x 7.7 x 0.9" (129 x 195 x 22mm)
Weight	12.6oz (357g)

Ordering

- RH520AHumidity+Temperature Chart Recorder (110V adaptor)
- RH520A-NIST ..RH520A with NIST Certificate
- RH520A-220Humidity+Temperature Chart Recorder (220V adaptor)
- RH520A-240Humidity+Temperature Chart Recorder (240V adaptor)
- RH522Replaceable Humidity/Temperature Probe
- SL123AC Alarm Relay Module 9ft (3m) cable
- SL124DC Alarm Relay Module 9ft (3m) cable

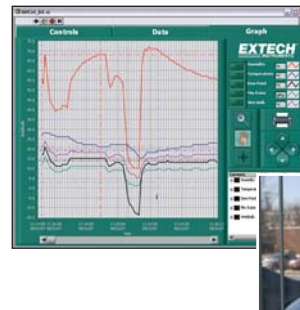

New LabView based PC software and cable for download control and to graph Relative Humidity, ambient temperature, dew point, wet bulb, and mix ratios (gpp or g/kg)

Wall mountable

RHT20 Humidity and Temperature Datalogger **NEW**

Datalogs 16,000 Humidity and 16,000 Temperature readings

Features:

- USB interface for easy setup and data download to a PC
- Dew point indication via Windows® compatible software (included)
- Selectable data sampling rate: 2s, 5s, 10s, 30s, 1m, 5m, 10m, 30m, 1hr, 2hr, 3hr, 6hr, 12hr, 24hr
- User-programmable alarm thresholds for RH and Temperature
- LCD displays current readings, Min/Max, and alarm status
- Long battery life (approx. 1 year)
- Complete with 3.6V Lithium battery, mounting bracket with combination lock, and Windows® 98, 2000, XP, and Vista compatible analysis software



Function	Range	Resolution	Basic Accuracy
Temperature	-40 to 158°F -40 to 70°C	0.1°F/°C	±1.8°F ±1.0°C
Humidity	0 to 100%RH	0.1%RH	±3%RH
Datalogging interval	1 second to 24 hours		
Memory	Temperature: 16,000 points; Relative Humidity: 16,000 points		
Dimensions	3.7 x 1.9 x 1.2" (94.4 x 48.9 x 31.2mm)		
Weight	3.2oz (90.7g)		



Monitors Humidity and Temperature levels in warehouse, storage rooms, freezers, shipping vans, and offices. USB connector easily plugs into a computer for data analysis.

Ordering (Available Q4 2009)

- RHT20Humidity and Temperature Datalogger

42265/42275 Temperature & Humidity Datalogger Kits

Choice of Temperature/Humidity or Temperature only Datalogger — Compact, powerful and easy to use with PC interface

Features:

- **42265** — Waterproof (IP65) Temperature Datalogger Kit records up to 8000 readings
- **42275** — Water resistant Temperature and Humidity Datalogger Kit records up to 16,000 readings (8,000 readings/parameter)
- Real time clock with date and time
- Logs data for days, weeks or months
- Three start methods: Scheduled, immediate or magnetic

- Multiple Dataloggers (42260 or 42270) can be programmed and data downloaded from one single docking station
- Programmable sampling rate from 1sec to 2hrs plus Hi/Lo limits with alarm indication

Datalogger Kit available in two configurations:
42265 includes one 42260 datalogger. **42275** includes one 42270 datalogger. Both include Windows® compatible software & docking station.



Specifications	Function	Range	Resolution	Basic Accuracy
	Relative Humidity	0 to 100% RH	0.1%RH	±3%RH
	Temperature	-40 to 185°F (-40 to 85°C)	0.1°F/°C	±1°F (±0.6°C)
	CE/ Warranty	CE/ 1 year		
	Dims/Wt	42260 or 42270 — 3x2.3x0.88" (76.2x57.2x22.3mm); 2.6oz (72.6g)		
		42265 or 42275 — 4.9x3.8x2" (123.8x95.3x51mm); 9oz (254g)		
		42266 or 42276 — 6.1x4.8x1.9" (155x122x48mm)/12oz (338g)		

Ordering

- 42275** Temperature/Humidity Datalogger Kit with PC Interface
- 42270** Temperature/Humidity Datalogger for 42275
- 42265** Temperature Datalogger Kit with PC Interface
- 42260** Temperature Datalogger for 42265
- 42299** Replacement 3.6V Lithium batteries (2pk)
- USB100** RS-232 to USB Adaptor

RHT10/TH10 Humidity & Temperature USB Dataloggers

Two models to choose from with USB interface for easy set-up and data download

Features:

- **Model RHT10** datalogs 16,000 Temperature/ 16,000 RH readings; Dew point indication via Windows® compatible software

RHT10-SW software for RHT10 to calculate Grains Per Pound (grams per kilogram) to 1120GPP (160g/kg)

Model TH10 datalogs 32,000 Temperature readings

- Selectable data sampling rate: 2s, 5s, 10s, 30s, 1m, 5m, 10m, 30m, 1hr, 2hr, 3hr, 6hr, 12hr, 24hr

- User-programmable alarm thresholds for RH and Temperature
- Humidity: 0 to 100%RH (Model RHT10 only)
Temperature: -40 to 158°F (-40 to 70°C);
Accuracy: ±3%RH; ±1°F/0.5°C
- 1yr battery life; Dims: 5.1x1.1x0.9" (130x30x25mm)/Wt: 1oz (20g)

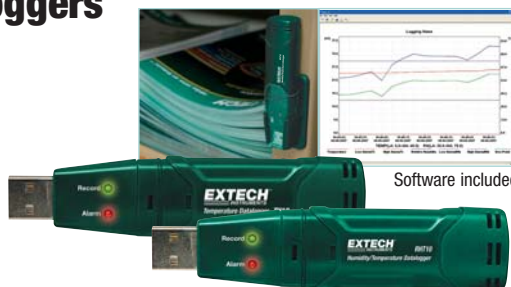

Software included

Complete with 3.6V Lithium battery, protective USB cap, mounting bracket, and Windows® compatible software for analysis

Ordering

- RHT10** Humidity and Temperature USB Datalogger
- RHT10-SW** GPP (g/kg) Software for RHT10
- TH10** Temperature USB Datalogger

42280 Temperature and Humidity Datalogger

Records up to 16,000 readings with USB interface for downloading to a PC

Features:

- Programmable from keypad or PC
- Selectable data sampling rate
- User programmable audible and visual alarms
- Wall, desktop, or tripod mount
- Calibration via optional salt bottles

Specifications	Function
	Relative Humidity range 0 to 100% RH
	Temperature range -4 to 144°F (-20 to 70°C)
	Resolution 0.1%RH, 0.1°F/°C
	Basic Accuracy ±3% Relative Humidity; ±1°F (±0.6°C)
	CE/ Warranty CE/ 1 year
	Dims/Wt 4.75x3.5x1.5" (120.7x88.9x38.1mm)/ 5.7oz (163g)



Software included



Complete with Windows® compatible software, USB cable, 110V AC adaptor, and four AA batteries

Ordering

- 42280** Temperature and Humidity Datalogger
- RH300-CAL** ..33% and 75%RH Calibration Kit



Digital Psychrometers

New humidity and temperature meters with built-in or remote probes include wet bulb and dew point measurements for quick assessment of air moisture content.

Featuring Model HD500

► Built-in InfraRed Thermometer

30:1 IR Thermometer for fast and accurate non-contact surface temperature measurements

► USB Interface and PC Software

Easy data transfer to a PC

► Highest Accuracy

Precision 2% RH accuracy

► Wet Bulb and Dew point

Digital Psychrometer displays air moisture content without slinging



Only Extech offers
Dew Point Meters with
Differential and IR Thermometer

Accessories

- RH300-CAL.....33% and 75%RH Calibration Kit for RH300
- RH350-CAL.....33% and 75%RH Calibration Kit for RH350
- RH401-CAL.....33% and 75%RH Calibration Kit for RH401
- TP890.....Thermistor Temperature Probe for RH300
- 407752PC Software and Cable for RH401 and RH405
- 589250RS-232 PC cable for RH350 and RH355
- USB100.....RS-232 to USB Adaptor

Order Meter with NIST Certificate*

All Extech meters come factory calibrated. For an additional charge, Extech will supply your meter complete with a Certificate of Calibration Traceable to N.I.S.T. with Data at multiple points. **To order meter with NIST:**

- RH300-NIST
- RH305-NIST
- RH350-NIST
- RH355-NIST
- RH390-NIST
- HD500-NIST
- HD550-NIST
- HD500-NISTL**
- HD550-NISTL**

*Only products listed are available with NIST Certificate. Meter must be ordered with NIST Certificate at time of purchase.

**Limited NIST; Product certified to all functions except IR Thermometer.

Specifications

Model	RH300	RH305 (kit)	RH350	RH355 (kit)
Sensor Type	Capacitance		Capacitance	
Dew Point	-90.4 to 122°F (-68.0 to 49.9°C)		-90.4 to 122°F (-68.0 to 49.9°C)	
Wet Bulb	-6.9 to 122°F (-21.6 to 49.9°C)		-6.9 to 122°F (-21.6 to 49.9°C)	
Humidity (Basic Accuracy)	0 to 100%RH (±3%RH)		0 to 100%RH (±3%RH)	
Temperature (internal)	-4 to 122°F (-20 to 50°C)		-4 to 122°F (-20 to 50°C)	
Basic Accuracy	±1.8°F or ±1°C		±1.8°F or ±1°C	
Temperature (external)	-4 to 158°F (-20 to 70°C)		-328 to 2498°F (-200 to 1370°C)	
Basic Accuracy	±1.8°F or ±1°C		±0.3% or 1.8°F or ±1°C	
Temperature (IR)	—		—	
Basic Accuracy	—		—	
Emissivity	—		—	
Field of View	—		—	
PC Interface	—		Optional	RS-232
Memory/Datalogging	—		99 readings	
CE/Warranty	CE/ 1 year		CE/ 1 year	
Dimensions/Weight	7x1.9x1" (178.5x48.4x24.7mm)/ 3.3oz (95g)		9x2.2x1.7" (230x57x44)/ 5.3oz (153g)	



RH305 Value Kit

RH300/RH305 Hygro-Thermometer Psychrometer

External Probe Temperature measurements for differential

- Simultaneous display of %RH, Temperature and Dew Point or Wet Bulb or Probe Temperature
- Calculates T1-T2 differential (Air Temperature minus External Probe Temperature) using optional probe (TP890) and T2-Dew Point
- Data Hold and Auto power off
- MAX/MIN readings
- Optional TP890 probe for Differential Temperature
- RH300 includes 2 AAA batteries
- RH305 kit (see photo on p. 85) includes RH300, TP890 external temperature probe, RH300-CAL calibration bottles and carrying case



RH355 Value Kit

Kit includes PC software

RH350/RH355 Dual Input Hygro-Thermometer Psychrometer

Two Type K External Probe inputs for Superheat plus memory

- Superheat differential measurements: T1-T2, Air-T1, and T1-Dew Point
- Backlit LCD displays 3 parameters: %RH and Temperature with either Dew Point, Wet Bulb or Type K
- RS-232 interface - optional software
- Stores up to 99 data points
- MAX/MIN with time stamp+AVG
- Data Hold, Auto power off
- RH350 includes 2 Type K bead wire probes (-58 to 482°F/-50 to 250°C), 4 AAA batteries
- RH355 kit (see photo on p. 85) includes RH350, RH350-CAL calibration bottles, 589250 software cable, and case



High Accuracy

RH390/RH490 Precision Hygro-Thermometer Psychrometer

Highest 2% RH accuracy with Fast 30 second Response Time

- Dual backlit display
- Simultaneous display of: Humidity/Temperature, Humidity/Dew Point, Humidity/Wet Bulb
- Fast 30 second response time
- Slim design with rubberized sides for better grip and for one hand operation
- **Model RH490** measures Grains Per Pound (grams per kilogram) to 1120GPP (160g/kg)
- Complete with carrying case and 9V battery



BUILT IN IR
Thermometer
Patented

RH405 Value Kit

Kit includes PC software

RH401/RH405 Psychrometer + 8:1 InfraRed Thermometer

IR for Non-contact Temperature measurements

- Triple display with backlighting:
 - Air temp+RH+surface temp
 - Dew Point+RH+surface temp
 - Wet Bulb+RH+surface temp
- Calculates T1 - DP, (IR Surface Temperature) - (Dew Point) differential
- Data Hold and Auto power off
- Built-in RS-232 interface (optional 407752 software & cable) - captures readings to a PC using Windows® Hyperterminal
- **RH401** includes 4 AAA batteries and carrying case
- **RH405** kit includes RH401, RH401-CAL calibration bottles, 407752 software/cable, and case



NEW

BUILT IN IR
Thermometer
Patented

USB port, cable and PC software included

HD500/HD550 Psychrometers + 30:1 InfraRed Thermometer

Combination Humidity Meter, Type K thermometer, and InfraRed Thermometer

- Built-in IR Thermometer for non-contact surface temperature measurements
- Type K Thermometer for contact temperature measurement
- Highest 2% RH accuracy
- Large triple LCD backlit display
- USB port includes PC software
- Auto power Off
- **Model HD550** measures Grains Per Pound (grams per kilogram) to 1120GPP (160g/kg)
- Complete with Type K bead wire probe (-22 to 572°F/-30 to 300°C), PC software, USB cable, built-in stand, case, & 9V battery

Psychrometer Kits



RH305 Kit — includes RH300, temperature probe, 33% and 75% calibration bottles, and case



RH355 Kit — includes RH350, 33% and 75% calibration bottles, PC cable, and case



RH405 Kit — includes RH401 with 33% and 75% calibration bottles, PC cable, and case

RH390	RH490	RH401	RH405 (kit)	HD500	HD550	Model
Capacitance	Capacitance	Capacitance	Capacitance	Capacitance	Capacitance	Sensor Type
-22 to 199°F (-30 to 100°C)	-22 to 199°F (-30 to 100°C)	-90.4 to 122°F (-68.0 to 49.9°C)	-90.4 to 122°F (-68.0 to 49.9°C)	-90.4 to 140°F (-68 to 60°C)	-90.4 to 140°F (-68 to 60°C)	Dew Point
32 to 176°F (0 to 80°C)	32 to 176°F (0 to 80°C)	-6.9 to 122°F (-21.6 to 49.9°C)	-6.9 to 122°F (-21.6 to 49.9°C)	-6.88 to 140°F (-21.6 to 60°C)	-6.88 to 140°F (-21.6 to 60°C)	Wet Bulb
0 to 100%RH (±2%RH)	0 to 100%RH (±2%RH)	0 to 100% (±3%RH)	0 to 100% (±3%RH)	0 to 100% (±2%RH)	0 to 100% (±2%RH)	Humidity (Basic Accuracy)
-22 to 199°F (-30 to 100°C)	-22 to 199°F (-30 to 100°C)	-4 to 122°F (-20 to 50°C)	-4 to 122°F (-20 to 50°C)	14 to 140°F (-10 to 60°C)	14 to 140°F (-10 to 60°C)	Temperature (internal)
±1.8°F/1°C	±1.8°F/1°C	±1.8°F (±1°C)	±1.8°F (±1°C)	±4°F (±2°C)	±4°F (±2°C)	Basic Accuracy
—	—	—	—	-148 to 2501°F (-100 to 1372°C)	-148 to 2501°F (-100 to 1372°C)	Temperature (external)
—	—	—	—	±3%	±3%	Basic Accuracy
—	—	-40 to 932°F (-40 to 500°C)	-40 to 932°F (-40 to 500°C)	-58 to 932°F (-50 to 500°C)	-58 to 932°F (-50 to 500°C)	Temperature (IR)
—	—	±3%	±3%	±2% or ±4°F (±2°C)	±2% or ±4°F (±2°C)	Basic Accuracy
—	—	Adjustable 0.3 to 1.0	Adjustable 0.3 to 1.0	0.95 fixed	0.95 fixed	Emissivity
—	—	8:1	8:1	30:1	30:1	Field of View
—	—	Optional	Optional	USB	USB	PC Interface
—	—	RS-232	RS-232	—	—	Memory/Datalogging
CE/ 1 year	CE/ 1 year	CE/ 1 year	CE/ 1 year	CE/ ✓3 years	CE/ ✓3 years	CE/Warranty
7.8x1.7x1.3" (200x45x33mm)/7oz (200g)	7.8x1.7x1.3" (200x45x33mm)/7oz (200g)	10x2.9x2" (255x75x50mm)/12.2oz (350g)	10x2.9x2" (255x75x50mm)/12.2oz (350g)	10x2.9x2" (255x75x50mm)/12.2oz (350g)	10x2.9x2" (255x75x50mm)/12.2oz (350g)	Dimensions/Weight



Humidity & Temperature Meters

Extech's Humidity/Temperature meters are available in the style to fit the user's measurement needs: remote probe for easy access into ducts and vents, and integral probe for convenient one hand operation.

Featuring Model **HT30**

► Heat Stress Index

Measures how hot it feels when humidity is combined with temperature, air movement, and radiant heat

► Wet Bulb Globe Temperature

Considers the effects of temperature, humidity and direct or radiant sunlight

► Black Globe Temperature

Monitors the effects of direct solar radiation on an exposed surface

► PC Interface

Capture and analyze data



Ideal for use in sporting events



Kit includes calibration standards and case

445580/445582 Humidity/ Temperature Pen

Compact, Digital Hygro-Thermometer, ideal for field use

- Simultaneous display of Temperature (°C/°F) and Relative Humidity
- MAX/MIN and Data Hold
- Built-in self calibration utility allows for field calibrations using optional Relative Humidity calibration bottles (RH300-C)
- **Model 445580** includes meter with pocket clip and 3V lithium battery
- **Model 445582** includes 445580 plus 33% and 75% RH calibration standards, and hard vinyl case

Accessories

RH300-CAL ..33% & 75% RH Calibration Kit
407752.....Software and Cable for HT30

Order Meter with NIST Certificate*

All Extech meters come factory calibrated. For an additional charge, Extech will supply your meter complete with a Certificate of Calibration Traceable to N.I.S.T. with Data at multiple points.

To order meter with NIST:

445580-NIST
445582-NIST
EA20-NIST
EA25-NIST

*Only products listed are available with NIST Certificate. Meter must be ordered with NIST Certificate at time of purchase.

Specifications

Model	445580 Pen	445582 Kit
Sensor Type		Capacitance
Humidity		10 to 90%
Dew Point		—
Temperature (Wet Bulb Globe)		—
Temperature (Black Globe)		—
Temperature (Air)		14 to 122°F (-10 to 50°C)
Temperature (IR)		—
Basic Accuracy		±5%, ±1.5°
Max. Resolution		0.1%, 0.1°
PC Interface		—
Datalogging		—
Dimensions		5.7x1.2x1" (145x30x25mm)
Weight		2.3oz (65g)
CE		Yes
Warranty		1 year



HT30 Heat Stress WBGT Meter

Wet Bulb Globe Temperature (WBGT) considers the effects of temperature, humidity and direct or radiant sunlight

- Heat Stress Index measures how hot it feels when humidity is combined with temperature, air movement, and radiant heat
- Black Globe Temperature (TG) monitors the effects of direct solar radiation on an exposed surface
- In/Out Function displays the WBGT value with or without direct sun exposure
- Auto power off with override
- Built-in RS-232 interface with optional PC software (407752)
- Complete with two AAA batteries



BUILT IN IR
Thermometer
Patented



Non-contact Temperature measurements

RH101 Hygro-Thermometer + IR

Humidity, Air Temperature plus IR for non-contact Temperature measurements

- Large backlit LCD dual display
- Primary and Secondary displays: Primary display is user selectable for IR or Humidity; Secondary displays ambient temperature
- InfraRed thermometer has built-in laser pointer, 8:1 distance to target ratio, and fixed 0.95 emissivity
- Auto power off, MAX and Data Hold
- Remote humidity sensor with 39" (1m) coiled cable measures both humidity and ambient temperature
- Overrange indication
- Complete with built-in stand, holster, Humidity/Temperature probe, 9V battery, and carrying case



EA20/EA25 EasyView® Hygro-Thermometer and Datalogger

Stores up to 99 or 15,000 readings

- Dual display of RH, Temperature, Dew Point and Wet Bulb
- Data Hold, Relative, and MAX/MIN
- Programmable power off timer
- Complete with stand, holster, probe with 39" (1m) cable, 6 AAA batteries, and carrying case; Model EA25 includes Windows® compatible software and cable
- **EA20** - Stores up to 99 manual readings for display recall
- **EA25 additional features**
- Stores up to 15,000 readings for PC download
- Programmable Start/Stop datalogging time and sample rate of 1 to 86,000 seconds

HT30	RH101	EA20	EA25
Capacitance	Capacitance	Capacitance	
0 to 100%RH	10 to 95%	10 to 95%	
—	—	-91.1 to 139.8°F (-68.4 to 59.9°C)	
32 to 122°F (0 to 50°C)	—	—	
-22 to 1022°F (-30 to 550°C)	—	—	
32 to 122°F (0 to 50°C)	-4 to 140°F (-20 to 60°C)	-4 to 140°F (-20 to 60°C)	
—	-58 to 932°F (-50 to 500°C)	—	
±3%, ±1.1°F/0.6°C	±3.5%RH; ±2% or ±4°F/2°C (IR); ±3°F/1.5°C (Air)	±3%RH, ±1.8°F (±1°C)	
0.1%, 0.1°	0.1%, 0.1°	0.1%, 0.1°	
Yes	—	—	Yes
—	—	99 readings	15,000 readings
Meter: 10x1.9x1.1" (254x49x30mm); Ball: 1.6" (40mm)dia, 1.4" (35mm) high	5.9x2.95x1.57" (150x75x40mm)	6x2.8x1.4" (152x72x35mm)	
4.8oz (136g)	7oz (200g)	8.3oz (235g)	
Yes	Yes	Yes	
1 year	1 year	1 year	



Moisture Meters

Extech's Moisture meters determine % moisture in building materials including, wood, brick, tile, plaster, concrete slabs, and roofing plus soil.

Featuring Model M0220

► Wide Moisture Ranges

Measures from 6 to 99.9% Wood moisture

► Automatic Temperature Compensation

Displays °F or °C temperature up to 176°F (80°C)

► Remote Moisture Probe (included)

Used to measure moisture in hard to reach areas

► Replaceable Threaded Pins

Easy to replace threaded pins help extend the life of the meter

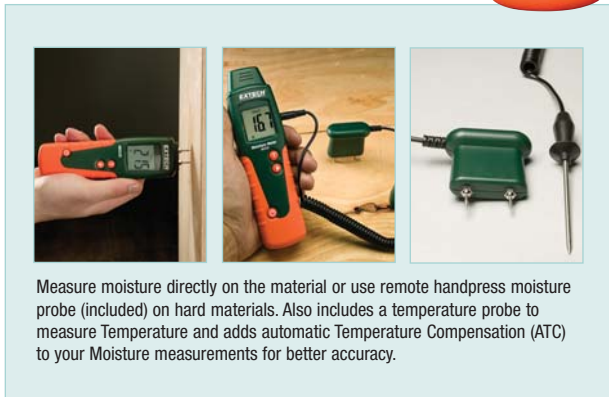

Measure moisture directly on the material or use remote handpress moisture probe (included) on hard materials. Also includes a temperature probe to measure Temperature and adds automatic Temperature Compensation (ATC) to your Moisture measurements for better accuracy.

Accessories

- MO100-PINS..Replacement pins for MO100 (20 pins)
- MO200-PINS..Replacement pins for MO210 (50 pins)
- MO220-PINS..Replacement pins for MO220 (50 pins)
- MO250-PINS..Replacement pins for MO250 (50 pins)
- MO252Remote probe w/3.9ft (120cm) cable for MO250
- MO750-P.....Replacement Moisture Probe for MO750

Specifications

Model	M0100	M0210
Sensor Type	Contact Pins	Contact Pins
Moisture Content	0 to 100	6 to 44% (Wood); 0.2 to 2.0% (Materials)
Max. Resolution	0.1	1% (Wood) / 0.1% (Materials)
Temperature °F (°C)	32 to 122°F (0°C to 50°C)	—
Dimensions/Weight	7.6x0.8x1.8" (192x30x45mm)/ 3.8oz (108g)	5.1x1.6x1.0" (130x40x25mm)/3.5oz (100g)
CE	Yes	Yes
Warranty	1 year	1 year



Multi-position sensor with safety storage and position lock



Battery check and measurement verification test

M0100 Pocket Size Moisture Detector

Convenient adjustable pins for wood and building materials

- Unique dual LCD displays wall moisture (0 to 100) and air temperature (32° to 122°F or 0 to 50°C) simultaneously
- Moisture content displayed on a relative scale
- Multi-position pins with safety storage of replaceable pins
- Easy to operate with selectable side switch (OFF, Test, and Calibrate)
- Data hold to freeze reading on display
- Calibration adjustment for better repeatability
- °C/°F switchable
- Low battery indication
- Complete with 2 AAA batteries, 10 spare pins, and pouch case

M0210 Pocket Size Moisture Detector

Large dual graphical LCD displays moisture in wood and other building materials

- 2-in-1 Digital LCD readout and analog bargraph
- Measures Wood Moisture and Building Material Moisture
- Use on wall board, sheet rock, cardboard, plaster, concrete, and mortar
- Self-contained, pocket sized meter with belt clip
- Replaceable threaded measurement electrode pins
- Impact proof housing
- Auto power off conserves battery energy
- Built-in battery check and measurement verification test
- Complete with protective cap, replacement pins, and three CR-2032 button batteries



Includes remote moisture and temperature probes

M0220 Wood Moisture Detector

Specifically designed for monitoring moisture in wood

- Memory contains 8 wood groups with calibrations for approximately 170 species of wood
- Measurements can be taken using the integral pin electrodes or a heavy duty remote probe (included)
- Automatically temperature compensated (ATC) readings when used with the temperature probe (included)
- Built-in calibration check
- Replaceable measurement electrode pins
- User settable Auto power off (1 to 9 minutes) with disable
- Low battery indication
- Includes remote moisture probe, Temperature probe, protective cap, replacement pins, pouch case, and battery



Optional remote probe (M0252)

M0250 Wood/ Building Material Moisture Meter

Combination LED bargraph indicator and large digital LCD reading

- Wood and building material moisture measurement
- Basic accuracy of 5%
- LCD display with the red LED bar graph
- Built-in pins, all in one, easy operation
- Data hold and MAX/MIN
- Complete with 9V battery
- Optional remote probe with 3.9ft (120cm) cable (M0252) measures wood moisture in difficult to access areas see p. 88 to order)



NEW



Large LCD display

M0750 Soil Moisture Meter

Integrated 8" (20cm) Heavy Duty Moisture Probe monitors the moisture level in soil

- Soil moisture content measurement from 0 to 50%
- Easy one-hand operation
- Min/Max records minimum and maximum moisture readings
- Data hold to freeze reading on display
- Water resistant housing
- Replaceable Heavy Duty Moisture Probe (M0750-P)
- Complete with moisture probe, 4 x AAA batteries and sensor cap

M0220	M0250	M0750	Model
Contact Pins	Contact Pins	Integrated Contact Probe	Sensor Type
6 to 99.9% (Wood)	6 to 40% (Wood); 13 to 100% (Materials)	0 to 50%	Moisture Content
±1% (Wood)	0.1%	0.1%	Max. Resolution
-31 to 176°F (-35 to 80°C)	—	—	Temperature °F (°C)
7x1.9x1.2" (180x50x31mm) 6.1oz (175g)	8.4x2.7x1.2" (217x69x30mm)/ 8.9oz (251g)	14.7x1.6x1.6" (374x40x40mm)	Dimensions/Weight
Yes	Yes	Yes	CE
1 year	1 year	1 year	Warranty



Pinless Moisture Meters

The versatile MO290 and MO295 Moisture Meters allow for pinless moisture measurement preventing any surface damage. For applications that requires a more accurate moisture reading, a pin probe (included with the meter) is used to penetrate the surface of the area being measured. A patented built-in InfraRed Thermometer adds value to the Moisture Meters allowing non-contact temperature measurement to determine if the surface is near or at the Dew Point level indicated.

Featuring Model **MO295**

▶ Remote Pin-style Moisture Probe

Used to measure moisture in hard to reach areas (included)

▶ 20 Point Memory

Stores/Recall 20 readings of each parameter: Moisture, Relative Humidity, Air Temperature plus Grains Per Pound (GPP), Dew Point (DP), and Vapor Pressure

▶ Large Dual LCD with Bargraph

Displays both Moisture and Temperature reading plus bargraph to show trending of Moisture level



Patent Pending



See p. 92 for complete Restoration Kits that include meters and accessories stored in a hard carrying case

Accessories for MO290 and MO295

Moisture Extension Probe

MO290-EPExtension Probe: Moisture Extension Probe with 30" cable.
Includes 4 pins (8.5cm pin depth)

MO290-PINS-EP...Replacement pins (20 pins, 8.5cm pin depth) for MO290-EP probe
MO290-EXT.....11.8" (30cm) Extender Handles (set of 2) for MO290-EP

Moisture Hammer Probe

MO290-HPMoisture Hammer Probe with 30" cable. Includes 4 pins (4cm pin depth)
MO290-PINS-HP .Replacement pins (40 pins, 4cm pin depth) for MO290-HP

Moisture Pin Probe

MO290-PMoisture Pin Probe with 30" cable. Includes 4 pins (1cm pin depth)
MO220-PINSReplacement pins (50 pins, 1cm pin depth) for MO290-P probe

Moisture Baseboard Probe

MO290-BPMoisture Baseboard Probe (Dual fixed flat pins with 10.5cm pin length) w/30" cable

Specifications

Model	Pinless Moisture
Pin-type Moisture (remote probe)	Pinless Moisture
Relative Humidity	Relative Humidity
Temperature (Air)	Temperature (Air)
Temperature (IR)	Temperature (IR)
Max Resolution	Max Resolution
Dimensions/Weight	Dimensions/Weight
CE	CE
Warranty	Warranty



M0280 Pinless Moisture Meter

Non-Invasive moisture content of building materials and wood

- Quickly indicates the moisture content of materials
- Select from 10 wood types and measurement ranges
- LCD displays % moisture of wood or material being tested
- Measurement depth to 0.75" (22mm) below the surface
- Automatic internal test and calibration
- Electro-magnetic testing technology
- Low battery indication
- Complete with 9V battery and pouch case



NEW
BUILT IN IR
Thermometer
Patent Pending



Includes MO290-P remote moisture probe

M0290 Pinless Moisture Meter + IR Thermometer

5-in-1 Meter with patented built-in IR Thermometer

- Quickly identify surface temperature changes with built-in IR thermometer and verify moisture levels with pinless sensor or pin-type probe (included)
- Pinless measurement depth to 0.75" (19mm) below the surface
- Patented IR design measures non-contact surface temperature; 8:1 distance to spot ratio with 0.95 fixed emissivity
- Measures Relative Humidity, Air Temperature plus Grains Per Pound (GPP), grams/kg, Dew Point (DP), Condensation levels, and Vapor Pressure
- Programmable high/low Moisture and Humidity alarms
- Calculation of differential Temperature (IR - DP) to determine condensation point
- Min/Max, Data Hold, Auto power off and low battery indication
- Complete with pin moisture probe, 9V battery, and case



NEW
BUILT IN IR
Thermometer
Patent Pending



Includes MO290-P remote moisture probe

M0295 Pinless Moisture Meter with Memory + IR Thermometer

Memory stores up to 20 readings of each parameter and displays trending bargraph of Moisture level

- Stores 20 readings of Moisture, Relative Humidity, Air Temperature plus Grains Per Pound (GPP), grams/kg, Dew Point (DP), Condensation levels, and Vapor Pressure
- Pinless measurement depth to 0.75" (19mm) below the surface
- Remote Pin-type probe (included) allows for surface contact moisture readings
- Patented IR design measures non-contact surface temperature; 8:1 distance to spot ratio with 0.95 fixed emissivity
- Programmable high/low Moisture and Humidity alarms
- Calculation of differential Temperature (IR - DP) to determine condensation point
- Min/Max, Data Hold, Auto power off and low battery indication
- Complete with MO290-P pin moisture probe, 9V battery, and case

M0280	M0290	M0295
0 to 99% (limited by wood type)	0 to 99.9 (Relative)	0 to 99.9 (Relative)
—	0 to 99.9%	0 to 99.9%
—	0 to 99.9% RH	0 to 99.9% RH
—	-20 to 170°F (-29 to 77°C)	-20 to 170°F (-29 to 77°C)
—	-4 to 392°F (-20 to 200°C)	-4 to 392°F (-20 to 200°C)
0.1%	0.1%, 0.1°F/°C	0.1%, 0.1°F/°C
7.6x0.8x1.8" (192x30x45mm)/ 3.8oz (108g)	6.5x2.8x1.5" (165x70x38mm)/ 7.4oz (210g)	6.5x2.8x1.5" (165x70x38mm)/ 7.4oz (210g)
Yes	Yes	Yes
1 year	1 year	1 year

MO290-RK Water Restoration Contractor Kit

NEW

A complete solution for the Restoration Contractor

Features:

- Use combination moisture meter/thermal hygrometer to capture all ambient conditions as well as moisture levels in one meter. Includes essential probes to measure moisture levels under baseboards, in between walls, and in hard wood and plywood subfloors. Use USB Humidity/ Temperature datalogger for GPP calculations
- MO290 includes: Pin Probe, Hammer Probe, Deep Wall Probe, and Baseboard Probe for contact moisture readings (see p. 90 for details)
- Supplied in a rugged hard carrying case
- **Model MO290 Pinless Moisture Psychrometer + IR Thermometer** monitors moisture in wood and building materials with no surface damage. Built-in patented IR Thermometer for non-contact temperature; Fixed probe measures Air Temperature, RH, Grains Per Pound (GPP), Dew Point (DP), & Vapor Pressure (see p. 91)
- **Model RHT10/RHT10-SW** Humidity/Temperature USB Datalogger + GPP (g/kg) Calculation datalogs 16,000 data (RH and Temperature). USB interface and software included (see p. 83).



Special Value Kit



MO290

RHT10

Ordering

MO290-RK...Water Restoration Contractor Kit

MO280-RK Restoration Contractor's Kit

NEW

A complete solution for the Restoration Contractor

Features:

- Use pin and pinless meters to better diagnose the amount of moisture content. Thermal Hygrometer provides fast, accurate readings of ambient room conditions and GPP (g/kg) calculations
- Supplied in a rugged hard carrying case
- **Model MO280 Pinless Moisture Meter** displays 0 to 99% moisture (select from 10 wood types). Measurement surface depth to 0.75" (22mm) with virtually no surface damage (see p. 91).
- **Model MO220 Wood Moisture Meter** with integral pins or remote pin probe displays 6 to 99.9% moisture level (8 wood types with calibrations for approx. 170 species of wood) (see p. 89).
- **Model RH490 Precision Hygro-Thermometer** with 2%RH accuracy and fast 30sec RH response time. Measures Humidity, Temperature, Dew Point, Wet Bulb, GPP and g/kg (see p. 85).
- **Model RHT10/RHT10-SW** Humidity/Temperature USB Datalogger + GPP (g/kg) Calculation datalogs 16,000 data (RH and Temperature). USB interface and software included (see p. 83).



Special Value Kit



MO220

RHT10

MO280

RH490

Ordering

MO280-RK...Restoration Contractor's Kit

MO280-KH Home Inspector Kits

Aid in identification of moisture, HVAC, electrical and hot water system issues

Features:

- Specifically designed for home inspection professionals
- Supplied in an attractive storage case
- Dims: 9.5x6.8x2.8" (241x173x71mm); Wt: 1.8lbs (0.7kg)
- **Model MO280 Pinless Moisture Meter** displays 0 to 99% moisture (select from 10 wood types). Measurement surface depth to 0.75" with virtually no surface damage (see p. 91).
- **Model 42500 IR Thermometer** for testing HVAC supply and return. Measures from -4 to 500°F (-20 to 260°C) (see p. 75)
- **Model ET10 GFCI Receptacle Tester** tests for faulty wiring in 3 wire receptacle and GFCI Circuits and detects 5 wiring faults (not included in MO280-KH2 kit)
- **Model 39240 Waterproof Stem Thermometer** for testing hot water heaters. Measures temperature from -40 to 392°F (-40 to 200°C) (see p. 81)



MO280-KH.

Special
Value Kit



39240



MO280



42500



ET10

Ordering

MO280-KH....Home Inspector Kit
MO280-KH2....Home Inspector Kit
(MO280-KH2 does not include ET10)

MO280-KW Water Damage Restoration Kit

To monitor job site conditions, progress, and insurance company reporting

Features:

- Specifically designed for water damage restoration contractors
- Supplied in an attractive storage case
- Dims: 9.5x6.8x2.8" (241x173x71mm); Wt: 1.8lbs (0.7kg)
- **Model MO280 Pinless Moisture Meter** displays 0 to 99% moisture (select from 10 wood types). Measurement surface depth to 0.75" (22mm) with virtually no surface damage (see p. 91).
- **Model RH490 Precision Hygro-Thermometer** with 2%RH accuracy and fast 30sec RH response time. Measures Humidity, Temperature, Dew Point, Wet Bulb, GPP and g/kg (see p. 85).
- **Model MO210 Pocket Moisture Meter** measures moisture of wood or other building materials displaying both digital and graphical readings (see p. 88).

Special
Value Kit



RH490



MO280



MO210



Ordering

MO280-KW....Water Damage Restoration Kit



Hygro-Thermometer Indicators

Extech offers a full selection of Humidity/ Temperature indicators and alarms whether they are desktop or wall mount. NIST certificates are available for models with remote probes.

Featuring Model 445815

▶ Alarm Function

Audible and Visual alarms warn when Humidity level is too high or too low

▶ NIST Traceable

Humidity and Temperature adjustments plus optional humidity standards and Certificate of traceability to NIST

▶ Dew Point

Indicates where condensation may occur

▶ Max/Min

Captures highest and lowest temperature and humidity readings



Applications

- Monitors Dew Point levels in a basement for potential mold growth
- Monitors Humidity and Temperature levels in calibration labs, and production areas
- Alerts user when low Humidity level is present in computer server rooms to help prevent electrostatic conditions

Order Meter with NIST Certificate*

All Extech meters come factory calibrated. For an additional charge, Extech will supply your meter with a Certificate of Calibration Traceable to N.I.S.T. with Data at two Calibration Points (33% and 75%). **To order meter with NIST:**

445715-NIST
445815-NIST
445715-NISTL
445815-NISTL

*Only products listed are available with NIST Certificate. Meter must be ordered with NIST Certificate at time of purchase.

Specifications

Model	445703	445715	445715-NISTL
Remote Sensor	—	18" cable	—
Dew Point	—	—	—
Relative Humidity	10 to 99%	10 to 99%	10 to 99%
Basic Accuracy	±5%RH	±4%RH	±4%RH
Temperature (Indoor)	14 to 140°F (-10 to 60°C)	14 to 140°F (-10 to 60°C)	14 to 140°F (-10 to 60°C)
Basic Accuracy	±1.8°F/1°C	±1.8°F/1°C	±1.8°F/1°C
Temperature (Outdoor)	—	—	—
Basic Accuracy	—	—	—
Dimensions	4.3x3.9x0.78" (109x99x20mm)	4.3x3.9x0.78" (109x99x20mm)	4.3x3.9x0.78" (109x99x20mm)
Weight	6oz (169g)	6oz (169g)	6oz (169g)
CE	Yes	Yes	Yes
Warranty	1 year	1 year	1 year



445703 Big Digit Hygro-Thermometer

1" Digits on Super Large LCD

- Large dual display for easy viewing
- Simultaneous display of Temperature and Humidity
- MAX/MIN with reset function
- Complete with stand, wall mounting bracket, and 1 AAA battery



445715 Big Digit Remote Probe Hygro-Thermometer

NIST Traceable* and Calibrateable

- Probe clips onto meter or extends on 18" (457mm) cable
- Large dual display for easy viewing
- Simultaneous display of Temperature and Humidity
- MAX/MIN with reset function
- Rear calibration adjustment pot
- Complete with built-in stand, wall mount bracket, sensor and AAA battery; optional calibration salt bottles (RH300-CAL - illustrated on the right page)

Optional Limited NIST
445715-NISTL includes Certificate of Traceability to NIST at 75%.

For Certificate of Traceability to NIST at 2 points (33% and 75%), order 445715-NIST



445713 Indoor/Outdoor Hygro- Thermometer

Simultaneous display of
Temperature/Humidity

- Outdoor sensor with 35" (89cm) cable
- MAX/MIN with reset function
- Complete with stand, wall mounting bracket, outdoor sensor with 35" (89cm) cable, and 1 AAA battery

445814 Humidity Alert

Programmable Alarm warns when Humidity level is too high or too low

- %RH audible and visual alarm alerts when humidity exceeds set limit
- Displays Dew Point temperature
- Built-in Humidity and Temperature sensors
- Max/Min with reset function
- Rear calibration adjustment pot for Humidity and Temperature
- Ideal for warning when conditions for mold growth exist
- Complete with built-in stand, wall mount bracket, sensor and 1 AAA battery

445815 Humidity Alert II with Remote Probe

NIST Traceable* and Calibrateable plus programmable Alarms

- %RH audible and visual alarm alerts when humidity is higher or lower than HI/LO set points
- Displays Dew Point temperature
- Probe clips onto meter or extends on 18" (457mm) cable
- Max/Min with reset function
- Rear calibration adjustment pot for Humidity and Temperature
- Warns when conditions for mold growth exist or air too dry (bad for health or static)
- Complete with built-in stand, wall mount bracket, sensor and 1 AAA battery; optional calibration salt bottles (RH300-CAL - illustrated on the right of page)

*Optional Limited NIST
445815-NISTL includes Certificate of Traceability to NIST at 75%.*

For Certificate of Traceability to NIST at 2 points (33% and 75%), order 445815-NIST

RH300-CAL Calibration Kit



- Optional Calibration kit for calibrating Humidity Indicators (445715, 445815)
- 33%RH and 75%RH bottles
- Bottle designed with small opening for a tight fit of the sensor
- Includes 33%RH and 75%RH calibration bottles

445713	445814	445815	445815-NISTL	Model
35" cable	—	18" cable	—	Remote Sensor
—	Yes	Yes	—	Dew Point
10 to 99%	10 to 99%	10 to 99%	—	Relative Humidity
±5%RH	±4%RH	±4%RH	—	Basic Accuracy
14 to 140°F (-10 to 60°C)	14 to 140°F (-10 to 60°C)	14 to 140°F (-10 to 60°C)	—	Temperature (Indoor)
±1.8°F/1°C	±1.8°F/1°C	±1.8°F/1°C	—	Basic Accuracy
14 to 140°F (-10 to 60°C)	—	—	—	Temperature (Outdoor)
±1.8°F/1°C	—	—	—	Basic Accuracy
4.3x3.9x0.78" (109x99x20mm)	4.3x3.9x0.78" (109x99x20mm)	4.3x3.9x0.78" (109x99x20mm)	—	Dimensions
6oz (169g)	6oz (169g)	6oz (169g)	—	Weight
Yes	Yes	Yes	—	CE
1 year	1 year	1 year	—	Warranty



Hygro-Thermometers and Clocks

Extech offers a full selection of Humidity/Temperature indicators both desktop or wall mount. Models with calendar and clock functions are also available.

Featuring Model CTH10



▶ Radio Controlled Settings

Automatically and accurately adjusts year, date, day, hour, minute, second, and DST from the US official atomic clock

▶ Super Large LCD: 17" x 12"

Simultaneously displays Time, RH%, Temperature, Month, Date, and Day. Overall Size approximately 17x12x11.4" (43x30x29cm) can be seen 150ft (45m)

▶ Alarm Clock

Audible alarm clock function



Perfect for Wall mount display. Big digits can be easily viewed from a distance up to 150ft (45m).

Hygro-Thermometer Stopwatch

See HW30 on p. 126 for our Heatwatch with built-in Humidity and/or Temperature sensors, plus it calculates the Heat Index!



445702 Hygro-Thermometer Clock

Combines three displays for Time, Temperature, and Humidity

- Clock display 12/24 hour time
- MAX/MIN with "reset" function
- Temperature is °C/°F switchable
- Settable clock alarm
- Complete with stand, wall mounting bracket, and one AAA battery



44550 Humidity and Temperature Pen

Pocket size for quick and reliable measurements at any location

- Built-in sensors provide simultaneous readings of Relative Humidity and Temperature on dual LCD
- °C/°F switchable
- Max/Min memory functions for display of highest and lowest readings for both Temperature & Relative Humidity
- "Clear" function key to erase stored Max/Min readings to record new values
- Complete with pocket clip and one LR44 button battery

Specifications

	445702	44550
Model	445702	44550
Relative Humidity	10 to 85%	20 to 90%
Basic Accuracy	±6%RH	±5%RH
Temperature	14 to 140°F (-10 to 60°C)	14 to 122°F (-10 to 50°C)
Basic Accuracy	±1.8°F/1°C	±2°F/1°C
Clock	Yes	—
Clock Alarm	Yes	—
Calendar	—	—
Dimensions	4.3x2.8x0.8" (109x71x20mm)	5.9x0.8x0.7" 150x20x18mm)
Weight	4oz (113g)	0.7oz (20g)
CE	Yes	Yes
Warranty	1 year	1 year



445706 Radio Controlled 9x12" Hygro-Thermometer Clock

Five selectable languages on Day display

- Large digit display clock ideal for desktop or wall mount
- °C/°F switchable
- Displays day, date and month
- Audible alarm clock function
- MAX/MIN Temperature and Humidity
- Complete with desktop stand and two AA batteries



WTH100 Radio Controlled Wireless Clock with Weather Station

Receives Time Code from NIST Radio Station WWVB (North America only) and automatically adjusts time, date, and DST

- Large backlit LCD displays Time, Temperature, Barometric Pressure, Weather Symbols (sunny, slightly cloudy, cloudy, rainy, stormy) and Moon phase
- Selectable barometric pressure in mb/hPa or inHg
- Automatically adjusts for daylight savings time (DST)
- Days of the Week displayed in 5 selectable languages: English/German/French/Italian/Spanish
- Accuracy of 1 second per day, ±8mb@25°C
- Alarm Clock with snooze
- °F/°C switchable
- Complete with built-in stand, and two AAA batteries



CTH10 Radio Controlled 17x12" Wall Clock Hygro-Thermometer

Receives radio signal (WWVB) from the NIST U.S. Atomic Clock to maintain accuracy within 1 second (North America only)

- Automatically adjusts year, date, day, hour, minute, second, and DST
- Large LCD displays Time, RH%, Temperature, Year, Month, Date, and Day
- Super Large 4.3" (109mm) digit clock display can be viewed from 150ft (45m)
- Signal indicator displays signal strength in 3 levels to indicate successful synchronization
- °F/°C switchable
- Built-in stand for desktop or wall-mount
- Complete with built-in stand and four AA batteries

445706	WTH100	CTH10	Model
20 to 90%	—	20 to 90%	Relative Humidity
±5%RH	—	±6% RH	Basic Accuracy
23 to 113°F (-5 to 45°C)	32 to 113°F (0 to 45°C)	23 to 122°F (-5 to 50°C)	Temperature
±2°F/1°C	±2°F/1°C	±2°F/1°C	Basic Accuracy
Yes	Yes	Yes	Clock
Yes	Yes	Yes	Clock Alarm
Yes	Yes	Yes	Calendar
8.7x11.8x1" (221x300x24mm)	3.1x1.9x3.9" (79x49x99mm)	17x12x11.4" (43x30x29cm)	Dimensions
21.4oz (608g)	6.7oz (191g)	2.75lbs (1.2kg)	Weight
Yes	Yes	Yes	CE
1 year	1 year	1 year	Warranty



Air Velocity Meters

Extech's Thermo-Anemometers with built-in vanes are designed for convenience and ease of use. Dual displays of air velocity and temperature provide quick answers to airflow questions.

Featuring Model 45170

► Rugged 4-in-1 Meter

Measures Humidity, Temperature, Air Velocity and Light Level

► Smart Display

Characters reverse direction depending on measurement mode

► Ergonomic & Lightweight

Designed for easy one-handed operation



Air Velocity



Type K Temperature



Humidity Level



Light Intensity



45118 Mini Thermo-Anemometer

Waterproof pocket size with Air Velocity, Temperature and Windchill

- Display Air Velocity and Temperature or Windchill
- Selectable averaging function of 5, 10, or 13 second intervals
- Fold up protective housing extends to 9" (229mm) for better reach
- Tripod mount (optional TR100 Tripod — sold separately)
- Data Hold with Auto power off
- Water resistant housing floats
- Replaceable plastic vane 45116
- Complete with CR2032 lithium battery and 43" (1.09m) lanyard



45158 Mini Thermo-Anemometer+ Humidity

Waterproof pocket size with Air Velocity, Temperature, %RH, Dew Point & Windchill

- Display air velocity and either Relative Humidity, Dew Point, Temperature or Windchill
- Selectable averaging function of 5, 10, or 13 second intervals
- Fold up protective housing extends to 9" (229mm) for better reach
- Tripod mount (optional TR100 Tripod — sold separately)
- Data Hold with Auto power off
- Water resistant housing floats
- Replaceable plastic vane 45156
- Complete with CR2032 lithium battery and 43" (1.09m) lanyard

Specifications

Model	45118	45158
ft/min (res.)	100 to 5500 (20)	100 to 5500 (20)
m/s (res.)	0.5 to 28 (0.1)	0.5 to 28 (0.1)
km/h (res.)	1.8 to 100.6 (0.7)	1.8 to 100.6 (0.7)
MPH (res.)	1.1 to 62.5 (0.2)	1.1 to 62.5 (0.2)
knots (res.)	1.0 to 54.3 (0.3)	1.0 to 54.3 (0.3)
Beaufort Force (res.)	1 to 17 (1)	1 to 17 (1)
Temperature & Windchill °F/°C	0 to 122°F (0.1°)/-18 to 50°C (0.1°)	0 to 122°F (0.1°)/-18 to 50°C (0.1°)
Relative Humidity (res.)	—	10% to 95% (1%)
Foot Candles/Lux (res.)	—	—
Basic Accuracy		
Airflow	±3% of reading	±3% of reading
Temperature	±1.8°F, ±1°C	±1.8°F, ±1°C
Relative Humidity	—	±5%RH
Light	—	—
Dimensions	5.25x2.75x0.75" (133x70x19mm) Vane: 1" (26mm)D	5.25x2.75x0.75" (133x70x19mm) Vane: 1" (26mm)D
Weight	3oz (95g)	3oz (95g)
CE	Yes	Yes
Warranty	1 year	1 year

Accessories

45116...Mini Impeller (2pk)
for 45118

45156...Mini Impeller (2pk)
for 45158

TR100...Tripod

CA895...Small Vinyl Pouch Case
for 45118, 45158



Optional Tripod (TR100)



45160 3-in-1 Humidity, Temperature and Airflow meter

Ergonomic pocket size housing, large dual LCD

- Simultaneously displays Temperature and Air Velocity or Relative Humidity
- Type K input measures temperature to 2372°F (1300°C) (Probe sold separately - see p. 80)
- MAX/MIN, Data hold, Auto power off with disable feature
- Built-in low friction vane wheel improves air velocity accuracy
- Thin-film capacitance humidity sensor for fast response
- Complete with wrist strap and 9V battery



NEW

45170 4-in-1 Environmental Meter

Measures Humidity, Temperature, Airflow, and Light Level

- Characters on display reverse direction depending on function
- Utilizes precision photo diode and color correction filter
- Cosine and color corrected light measurements
- Type K input measures temperature to 2372°F (1300°C) (Probe sold separately - see p. 80)
- MAX/MIN, Data hold, Auto power off with disable feature
- Built-in low friction vane wheel improves air velocity accuracy
- Thin-film capacitance humidity sensor for fast response
- Includes wrist strap & 9V battery



AN400 Cup Thermo-Anemometer

Rotating cups provide accurate air velocity measurements from any direction

- Wide range air velocity measures m/s, ft/min, km/hr, and knots
- Dual LCD digital display of Air Velocity and Temperature
- Record MAX/MIN values
- Record up to 100 readings
- Water resistant housing
- Complete with four AAA batteries

45160	45170	AN400	Model
80 to 5910 (10)	80 to 5910 (10)	144 to 6895 (1)	ft/min (res.)
0.4 to 30 (0.1)	0.4 to 30 (0.1)	0.9 to 35.0 (0.1)	m/s (res.)
1.4 to 108.0 (0.1)	1.4 to 108.0 (0.1)	2.5 to 126.0 (0.1)	km/h (res.)
0.9 to 67.0 (0.1)	0.9 to 67.0 (0.1)	1.6 to 78.2 (0.1)	MPH (res.)
0.8 to 58.3 (0.1)	0.8 to 58.3 (0.1)	1.4 to 68.0 (0.1)	knots (res.)
—	—	—	Beaufort Force (res.)
32 to 122°F (0.1°)/0 to 50°C (0.1°)	32 to 122°F (0.1°)/0 to 50°C (0.1°)	32 to 122°F (0.1°)/0 to 50°C (0.1°)	Temperature & Windchill °F/°C
10 to 95% (0.1%)	10 to 95% (0.1%)	—	Relative Humidity (res.)
—	0 to 1860Fc (0.1Fc)/ 0 to 20,000Lux (1Lux)	—	Foot Candles/Lux (res.)
—	—	—	Basic Accuracy
±3% FS	±3% FS	±2% of reading	Airflow
±2.5°F, ±1.2°C	±2.5°F, ±1.2°C	±1.5°F, ±0.8°C	Temperature
±4%RH	±4%RH	—	Relative Humidity
—	±5% of reading	—	Light
6.1x2.4x1.3" (156x60x33mm)	6.1x2.4x1.3" (156x60x33mm)	7.5x1.6x1.3" (190x40x32mm)	Dimensions
Vane: 1.2" (30.5mm)D	Vane: 1.2" (30.5mm)D	Vane: 2.9" (70mm)D	
5oz (160g)	5oz (160g)	6.3oz (181g)	Weight
Yes	Yes	Yes	CE
1 year	1 year	1 year	Warranty



Thermo-Anemometers

Extech's Thermo-Anemometers with remote sensors are the most popular models for HVAC applications. Available with Vane or Hot Wire sensor.

Featuring Model 451181

All In One

Airflow, air velocity, %RH, Temperature & Dew Point

Datalogging

Manual (99 readings) or Automatic (2400 readings) time stamped measurements

PC Interface

Download data logged readings for analysis and report generation

Built-in Printer

For hard copy receipts with date/time stamp



Digital printout



EZ30 EzFlex™ Thermo-Anemometer

Air Velocity Meter with flexible gooseneck probe

- Remote vane extends on 16" (406mm) gooseneck for easy access into hard to reach areas
- Ideal when reaching into an air duct or other HVAC applications
- Type K sensor for temperature measurements
- Large easy to read LCD display
- Data hold, Auto power off, and MAX Hold
- Complete with battery and carrying case

Specifications

Model	EZ30
Ranges (Max Resolution)	
ft/min	80 to 5900 (1)
m/s	0.40 to 30.00 (0.01)
km/h	1.4 to 108.0 (0.1)
MPH	0.9 to 67.0 (0.1)
knots	0.8 to 58.0 (0.1)
Temperature & Windchill	32 to 122°F (0.1°)/0 to 50°C (0.1°)
Humidity	—
Wet Bulb	—
Air Flow (CFM=ft³/min)	—
Air Flow (CMM=m³/min)	—
Basic Accuracy	±3%rdg; ±3.6°F (±1.8°C)
Dimensions	6.4x1.8x1.3" (163x45x34mm)
	Vane: 1.75" (44mm)D
Weight	7.4oz (210g)
Warranty/CE	1 year/CE

Accessories

USB100RS-232 to USB adaptor
422377Thermal Paper Roll - 2pk;
1.5"W (38mm) for 451181

Order Meter with NIST Certificate*

All Extech meters come factory calibrated. For an additional charge, Extech will supply your meter complete with a Certificate of Calibration Traceable to N.I.S.T. with Data at multiple points. **To order meter with NIST:**

451126-NIST
407123-NIST

*Only products listed are available with NIST Certificate. Meter must be ordered with NIST Certificate at time of purchase.



451181 Printing Anemometer/ Hydro-Thermometer

Measure, datalog, download and print air flow readings to a PC

- Simultaneously measures and displays Air Velocity, Temperature, Humidity, Wet Bulb, plus calculates CFM/CMM
- Manually logs 99 readings or setup time interval for automatic logging (2400 points)
- Datalogger date/time stamps and stores data for later recall, printing or downloading to a PC
- Thermal printer prints readings an date/time stamp
- RS-232 PC interface with Windows® compatible software
- Complete with vane sensor with 4ft (120cm) cable, software and cable, 4 AA batteries, carrying case, and one paper roll



Software included

451126 CFM/CMM Vane Anemometer Datalogger

Measures Air Velocity, or Air Volume and Temperature with built-in Datalogger and RS-232 PC interface

- Dual Display provides [Air Velocity + Temperature] or [Airflow + Area]
- Measures Airflow in CFM (ft³/min) and CMM (m³/min)
- Internal 1000 point datalogger plus built-in RS-232 PC interface
- MAX/MIN/AVG readings
- Complete with vane sensor, Windows® 95/98/2000/ME/NT/XP compatible software, cable, 9V battery, and case



407123 Heavy Duty Hot Wire Thermo-Anemometer

Telescoping probe is designed to fit into small openings and measure airflow down to 40ft/min

- Telescoping probe is ideal for measuring in HVAC ducts and other small vents; extends up to 7ft (2.1m) maximum length with cable
- Super large 1.4" (36mm) dual LCD display
- MAX/MIN, Data Hold
- Optional Data Acquisition software (407001) and Datalogger (380340); (see details on p. 108)
- Complete with telescoping probe with cable, six AAA batteries and protective holster.

NOTE: AC Adaptor not available for this model.

451181	451126	407123
60 to 4930 (1)	60 to 8800 (2)	40 to 3940 (10)
0.4 to 25 (0.1)	0.3 to 45 (0.01)	0.2 to 20 (0.1)
—	1 to 140 (0.04)	0.7 to 72 (0.1)
—	0.7 to 100 (0.02)	0.5 to 45 (0.1)
—	0.6 to 88 (0.02)	1.0 to 31 (0.1)
-4 to 144°F (0.1°)/-20 to 60°C (0.1°)	32 to 122°F (0.4°)/0 to 50°C (0.2°C)	32 to 122°F (0.1°)/0 to 50°C (0.1°)
0 to 100% (0.1%)	—	—
-7.6 to 158°F (0.1°)/-22 to 70°C (0.1°)	—	—
0 to 99999CFM (0.1)	0 to 999900CFM (0.001)	—
0 to 99999CMM (0.1)	0 to 999900CMM (0.001)	—
±3% rdg 1.°F/°C, ±3%RH	±3%rdg; ±1.8°F (±1°C)	±3% rdg or ±(1%+1d)FS; ±1.5°F (±0.8°C)
8.1x2.75x2" (208x70x53mm)	6.6x3.5x1" (168x88x26mm)	7x2.9x1.3" (178x74x33mm)
Vane: 2.83" (72mm)D	Vane: 2.6" (66mm)D	0.5" (13mm)D
9oz (260g)	12.2oz (350g)	17oz (482g)
1 year/CE	1 year/CE	✓3 years/CE



CFM Thermo-Anemometers

Extech's anemometers with CFM capabilities allow you to input the measured area of a duct and display air volume flow. Datalogging model also available. Select vane type or hot wire sensors.

Featuring Model HD350

► Pitot Tube

Measures Air Velocity/Air Flow/Pressure in difficult-to-reach or tight locations where a vane anemometer won't fit

► Differential Manometer

Low Range/High Resolution Gauge or Differential Pressure

► USB Interface & PC Software

Record data to a PC for analysis

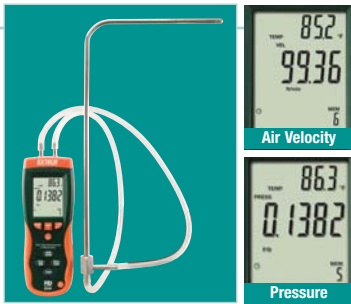

Unique Pitot tube sensor used for measuring air velocity, airflow, and pressure in vents, ducts and other small openings.



AN100/AN200 CFM/CMM Thermo-Anemometers

Large backlit display of Airflow or Air Velocity plus model with built-in InfraRed Thermometer

- Simultaneous display of Ambient Temperature and Air Flow or Air Velocity
- Up to 8 easy to set Area dimensions stored in internal memory (ft² or m²)
- 20 point AVG for Air Flow
- Low friction 2.83"D (72mm) ball bearing vane wheel
- Data Hold, MIN/MAX, Auto off

AN200 Additional Features

- Built-in IR Thermometer
- Complete with vane sensor on 3.9ft (120cm) cable, 9V battery, protective rubber holster, and case



Software included

HD300 CFM/CMM Thermo-Anemometer + IR Thermometer

Built-in IR Thermometer for quick and easy troubleshooting of ceiling vents, duct work, and other remote surfaces

- IR Thermometer has 30:1 distance to target ratio and Laser pointer
- Simultaneous display of Air Flow in CFM/CMM or Air Velocity Plus Ambient Temperature
- Up to 8 easy to set Area dimensions stored in memory
- Large backlit LCD
- 20 point AVG for air flow
- USB port includes PC software
- Includes PC software, cable, vane sensor on 3.9ft (120cm) cable, built-in stand, case, & 9V battery

Order Meter with NIST Certificate*

All Extech meters come factory calibrated. For an additional charge, Extech will supply your meter complete with a Certificate of Calibration Traceable to N.I.S.T. with Data at multiple points. **To order meter with NIST:**

- AN100-NIST
- AN200-NIST
- HD300-NIST
- 407113-NIST
- 407119-NIST

Limited NIST: Below products are certified to all functions except IR Thermometer.

- AN200-NISTL
- HD300-NISTL

*Only products listed are available with NIST Certificate. Meter must be ordered with NIST Certificate at time of purchase.

Specifications

Model	AN100	AN200	HD300
Air Velocity (Max Res.)			
ft/min	80 to 5900 (1)		80 to 5900 (1)
m/sec	0.4 to 30.00 (0.01)		0.4 to 30.00 (0.01)
km/h	1.4 to 108.0 (0.1)		1.4 to 108.0 (0.1)
MPH	0.9 to 67.0 (0.1)		0.9 to 67 (0.1)
knots	0.8 to 58.0 (0.1)		0.8 to 58.0 (0.1)
Temperature (°F/°C)	14 to 140°F (0.1°)/ -10 to 60°C (0.1°)		14 to 140°F (0.1°)/-10 to 60°C (0.1°C)
Temperature (IR) (with Laser pointer)	—	-58 to 500°F/ -50 to 260°C (0.1°/1°)	-58 to 932°F/ -50 to 500°C (0.1°/1°)
Air Flow (CFM = ft³/min)	0 to 9999CFM (1)	0 to 99999CFM (0.1)	0 to 999900CFM (0.001)
Air Flow (CMM = m³/min)	0 to 9999CMM (1)	0 to 99999CMM (0.1)	0 to 999900CMM (0.001)
Pressure			
psi	—	—	—
mbar	—	—	—
inH ₂ O	—	—	—
mmH ₂ O	—	—	—
Pa	—	—	—
Basic Accuracy	±3%rdg; ±2°F (±1°C)		±3%rdg; ±4°F (2°C)
Dimensions/Weight	7x2.9x1.3" (178x74x33mm)/1.6lbs (700g)		8x3x1.9" (203x75x50mm)/12.2oz (350g)
CE/Warranty	CE/ 1 year		CE/ ✓3 years



NEW
Available Q4 2009



Includes Pitot Tube sensor and two connection hoses

HD350 Pitot Tube Anemometer + Differential Manometer

Measures Air Velocity/Airflow in tight locations

- Simultaneous display of Pressure, Air Velocity or Air Flow plus Temperature
- 5 selectable pressure units
- MIN/MAX/AVG recording and Relative time stamp
- Data Hold, Auto power off and Zero functions
- Large backlit LCD display
- Record up to 99 readings
- USB port includes software
- Includes PC software with cable, 9V battery, pitot tube with two connection hoses, 100V-240V universal AC Adaptor, & hard case



407113 High Temperature CFM Metal Vane Anemometer

Withstands temperatures to 175°F (80°C) and airspeed to 7880ft/min

- Display Air Flow (CFM) or Air Velocity plus Temperature
- Air Flow displayed in 3 modes: Instantaneous value, Up to 20 point average, or 2/3 flow value
- Record and Recall MIN/MAX
- Data Hold plus Auto power off
- Built-in RS-232 PC Interface
- Optional Data Acquisition software 407001 and datalogger 380340 (see p. 108)
- Includes metal vane sensor with 3.9ft (120cm) cable, 9V battery, holster with stand, & hard case



407119 Hot Wire CFM Anemometer

Accurately measures Air Flow (CFM/ CMM) or Air velocity plus Temperature

- Air velocity measurements as low as 40ft/min
- Telescoping probe extends up to 3ft (940mm) long
- Measures air volume in CFM (ft³/min) and CMM (m³/min) plus Temperature simultaneously
- Air Flow displayed in 2 modes as an instantaneous value or up to 20 point average
- Record and Recall MIN/MAX
- Data Hold plus Auto power off
- Optional software 407001 and datalogger 380340 (see p. 108)
- Complete with telescoping probe with 5.5ft (167.6cm) cable, and four AA batteries

HD350	407113	407119	Model
200 to 15733 (1)	100 to 6890 (1)	40 to 3940 (1)	Air Velocity (Max Res.)
1 to 80.00 (0.01)	0.5 to 35 (0.1)	0.2 to 20 (0.1)	ft/min
3.5 to 288.0 (0.1)	1.8 to 126.0 (0.1)	0.7 to 72.0 (0.1)	m/sec
2.25 to 178.66 (0.01)	1.1 to 78.3 (0.1)	0.9 to 44.7 (0.1)	km/h
2.0 to 154.6 (0.1)	1.0 to 68.0 (0.1)	0.4 to 33.8 (0.1)	MPH
32 to 122°F (0.1°)/0 to 50°C (0.1°C)	32 to 175°F (0.1°)/ 0 to 80°C (0.1°)	32 to 122°F (0.1°)/ 0 to 50°C (0.1°)	knots
—	—	—	Temperature (°F/°C)
0 to 99,999CFM (0.001)	0 to 999,900CFM (0.001)	0 to 999,900CFM (0.001)	Temperature (IR)
0 to 99,999CMM (0.001)	0 to 999,900CMM (0.001)	0 to 999,900CMM (0.001)	(with Laser pointer)
0.7252psi (0.0001psi)	—	—	Air Flow (CFM = ft³/min)
50.00mbar (0.01mbar)	—	—	Air Flow (CMM = m³/min)
20.07inH ₂ O (0.01inH ₂ O)	—	—	Pressure
509.8mmH ₂ O (0.01mmH ₂ O)	—	—	psi
5000Pa (1Pa)	—	—	mbar
±3%rdg; ±3%FS; ±2°F (1°C)	±2%rdg; ±1.5°F (±0.8°C)	±5%FS; ±1.5°F (±0.8°C)	inH ₂ O
8x3x1.9" (210x75x50mm)/12oz (340g)	7x2.9x1.3" (178x74x33mm)/1.35lbs (612g)	7x2.9x1.3" (178x74x32mm)/1.1lbs (482g)	mmH ₂ O
CE/ ✓3 years	CE/ ✓3 years	CE/ ✓3 years	Pa
			Basic Accuracy
			Dimensions/Weight
			CE/Warranty

475055 High Capacity Force Gauge with PC Interface

220lbs (100kg), Tension and Compression

Features:

- Ranges: 0.05 to 100kg
0.05 to 220lbs
0.2 to 980 Newton
- Basic accuracy of 0.5%
- Tension or Compression, Peak hold and Zero functions
- Positive/Reverse display for easy readability
- Large LCD with back light feature
- RS-232 PC interface
- Optional software



Complete with tension and compression adaptors, six AA 1.5V batteries, and case



Ordering

- 475055Force Gauge
 475055-NIST475055 with NIST Certificate
 407001Data Acquisition Software and Serial Cable
 407001-USBUSB adaptor for 407001

475040/475044 Digital Force Gauges

Push/Pull measurements in kg, lbs, oz and Newton units

Features:

- 5 digit 0.4" (10mm) LCD with reversible display feature to match viewing angle
- Load cell measurement transducer
- Zero Adjust and Peak Hold
- Overrange, low battery, and advanced function indication
- Selectable fast/slow response

Function	475040	475044 (High Capacity)
Range	176oz, 5000g, 49 Newtons	44lbs, 20kg, 196 Newtons
Accuracy (23°C)	±(0.4%+1 digit)	±(0.5%+2 digits)
Resolution	0.05oz, 1g, 0.01 Newtons	0.01lbs, 0.01kg, 0.05 Newtons
Overload capacity	10kg	30kg
Update Rate	Fast mode 0.2secs; Slow mode 0.6secs.	
Full scale deflection	2.00mm	
Transducer type	Load cell	
Power Supply	Six 1.5V AA (UM-3) batteries or DC 9V adaptor (not included)	
Mounting Holes	Located on rear of gauge for optional test stand	
CE/Warranty	CE approved/ 1yr warranty	
Dimensions/ Weight	8.9x3.3x1.5" (227x83x39mm)/ 1.2lbs (551g)	

Ordering

- 475040Digital Force Gauge
 475040-NIST..475040 with NIST Certificate
 475044High Capacity Force Gauge
 475044-NIST..475044 with NIST Certificate
 479097Accessory Kit (2ea.- hook, flat, cone, & chisel head adaptors)
 153117120VAC Adaptor
 153230220VAC Adaptor



Complete with hook adaptor for tension, compression adaptors (flat, cone and chisel head), 5" (127mm) extension rod, 6 AA batteries, and case

CO10 Carbon Monoxide (CO) Meter

Check CO level in all environments up to 1000ppm

Features:

- Auto Zero at start up
- Displays CO levels from 0 to 1000ppm
- 1ppm resolution with $\pm 5\%$ or $\pm 10\text{ppm}$ basic accuracy (whichever is greater)
- Utilizes a stabilized electrochemical gas specific (CO) fast response sensor
- Audible alarm starts at 35ppm
- Memory stores 10 readings
- Ergonomic pocket size housing
- Max Hold and Data hold buttons
- Auto Power off
- Dims: 6.3x2.2x1.57" (160x56x40mm); Weight: 6.35oz (180g)
- 1 year warranty; CE approved
- Complete with 9V battery, protective holster, and case

Ordering

CO10Carbon Monoxide Meter



EZ40 EzFlex™ Combustible Gas Detector

Quickly Identifies and Pinpoints gas leaks

Features:

- 16" (406mm) gooseneck for easy access into hard to reach locations
- High Sensitivity
- One hand operation with thumb controlled sensitivity adjustment, to eliminate background gas levels
- Visible and audible alarm at 10% (LEL) Lower Explosive Limit for methane
- Locate the smallest leaks
- Complete with 3 "C" batteries

Applications:

- Natural Gas, Methane, Ethane, Propane, Butane, LPG

Specifications	Function	
	Pump driven field calibration range	10ppm
	Sensor type	Solid State
	Alarm	Visible and Audible @ 10% LEL for Methane
	Warm-up	Approx. 1 minute
	Response Time	< 2 seconds (up to 40% LEL)
	Duty Cycle	Intermittent
	Battery life	8 hours continuous use typical
	Dimensions	8.7 x 2.83 x 1.8" (221 x 72 x 46mm)
	Weight	18.4oz (520g)



Ordering

EZ40ExFlex™ Combustible Gas Detector

FG100 Combustible Gas Leak Detector

Fast response detection of flammable gas leakage from 500 to 6500ppm

Features:

- Detects flammable gases: Liquefied Natural Gas (LNG) and Liquefied Propane Gas (LPG)
- Highly sensitive detection circuitry with audible and visual alarm
- LED indicators for gas leakage and static absorption
- Continuous operation up to 4 hours
- Dims: 6.5 x 0.8" (164mm x 21mm) Weight: 0.9oz (25g)
- 1 year warranty, CE approved
- Complete with pocket clip and two AAA batteries



Ordering

FG100 ...Combustible Gas Leak Detector

CO200 Desktop Indoor Air Quality CO₂ Monitor **NEW**

Measures Carbon Dioxide (CO₂), Air Temperature and Humidity with user-settable high/low alarms

Features:

- Checks for Carbon Dioxide (CO₂) concentrations
- Maintenance free NDIR (non-dispersive infrared) CO₂ sensor
- Indoor Air Quality displayed in ppm with Good (380 to 420ppm), Normal (<1000ppm), Poor (>1000ppm) indication
- Visible and Audible CO₂ warning alarm with relay output for ventilation control
- Displays Year, Month, Date, and Time
- Max/Min CO₂ value recall function
- Auto Baseline Calibration (minimum CO₂ level over 7.5 days) or manual calibration in fresh air
- Complete with Universal AC adaptor



Desktop Carbon Dioxide (CO₂) Meter monitors the air quality in conference rooms insuring proper air ventilation

Function	Range	Resolution
CO ₂	0 to 9,999ppm	1ppm
Temperature	14 to 140°F (-10 to 60°C)	0.1°F/°C
Humidity	0.1 to 99.9%	0.1%
CE approval	Yes	
Warranty	1 year	
Dimensions/Weight	4.6 x 4 x 4" (117 x 102 x 102mm)/ 7.2oz (204g)	

Ordering
CO200Desktop Indoor Air Quality CO₂ Monitor

CO250 Portable Indoor Air Quality CO₂ Meter **NEW**

Measures Carbon Dioxide (CO₂), Temperature, Humidity, Dew Point, and Wet Bulb and calculates statistical 8 hour and 15 minute time weighted averages

Features:

- Checks for Carbon Dioxide (CO₂) concentrations
- Calculates statistical weighted averages of TWA (8 hour time weighted average) and STEL (15 minute short term exposure limit)
- Maintenance free NDIR (non-dispersive infrared) CO₂ sensor
- User programmable audible alarm
- Backlit triple LCD display
- RS-232 interface, Data acquisition software and cable included to analyze data on a PC
- Optional 33% and 75% RH calibration bottles (RH300-CAL)
- Complete with software and cable, 4 AA batteries, and carrying case



Measure CO₂ level in office buildings to check the air quality of conference rooms insuring proper ventilation.

Function	Range	Resolution
CO ₂	0 to 5,000ppm	1ppm
Temperature	14 to 140°F (-10 to 60°C)	0.1°F/°C
Humidity	0.0 to 99.9%	0.1%
Wet Bulb and Dew Point	Calculated	
CE / Warranty	CE/ 1 year	
Dimensions/Weight	7.9x2.7x2.3" (200x70x57mm)/ 6.7oz (190g)	

Ordering
CO250Portable Indoor Air Quality CO₂ Meter
RH300-CAL.....33% and 75%RH Calibration Kit

EA80 Indoor Air Quality CO₂ Meter/Datalogger

Measures Carbon Dioxide (CO₂), Temperature, Humidity, Dew Point and Wet Bulb

Features:

- Checks for Carbon Dioxide (CO₂) concentrations
- Maintenance free dual wavelength NDIR (non-dispersive infrared) CO₂ sensor
- Continuous (20,000 sets) or manual (99 sets) data logging
- Data hold, Max/Min with Time stamp, Alarm, and Auto Power Off
- Easy calibration in fresh air
- 1 year warranty
- Complete with (6) AAA batteries, RS-232 cable, and Windows® 95/98/NT/2000/ME/XP compatible software



Function	Range	Resolution
CO ₂	0 to 6,000ppm	1ppm
Temperature	-4 to 140°F (-20 to 60°C)	0.1°F/°C
Humidity	10 to 95%	0.1%
Datalogging	Continuous: 20,000 sets/Manual 99 sets	
Dimensions/ Weight	5.3x2.8x1.2" (135x72x31mm)/ 8.2oz (235g)	

Ordering
EA80Indoor Air Quality CO₂ Meter/Datalogger

461880 Vibration Meter + Laser Combination Tachometer

NEW

Measures Acceleration, Velocity and Displacement plus RPM and Linear Surface Speed

Features:

- Unique large LCD displays characters on reverse direction depending on contact, photo, or vibration mode
- Windows® 95/98/NT/2000/XP compatible software (included) allows captured readings to be downloaded to your PC for further analysis
- Complete with remote vibration sensor, magnetic mount, wheels for linear surface speed or RPM (cone tip and flat tip), reflective tape, 4 AA batteries, software with cable, and hard carrying case

Vibration Meter Features:

- Remote vibration sensor with magnetic adapter on 39"(1m) cable
- Wide frequency range of 10Hz to 1kHz
- RMS or Peak Value measurement modes
- Manual/Auto store/recall up to 1000 readings
- Data Hold freezes the displayed reading
- Auto shut-off saves battery life

Tachometer Features:

- Uses a laser for greater distance non-contact measurements up to 4.9ft (1.5m)
- Stores Last, Max, and Min readings



Function	
Vibration Meter	
Acceleration	656ft/s ² , 200m/s ² , 20.39g
Velocity	7.87in/s, 200mm/s, 19.99cm/s
Displacement	0.078in, 2mm
Resolution	2ft/s ² , 0.5m/s ² , 0.05g; 0.02in/s, 0.5mm/s, 0.05cm/s; 0.002in, 0.005mm
Basic accuracy	±(5%+2 digits)
Tachometer	
Photo	10 to 99,999rpm
Contact	0.5 to 19,999rpm
Surface Speed	0.2 to 6,560ft/min (0.05 to 1,999.9m/min)
Basic accuracy	±(5%+1 digit)
Dimensions	7.4 x 3 x 1.8" (188 x 75.5 x 46.8mm)
Weight with Probe	1.12lbs (507g)

Ordering

461880Vibration Tachometer
461880-NIST461880 with NIST Certificate



Contact Tachometer function measures the speed of rotating objects by placing the wheel tip onto the surface.



Photo Tachometer function measures the speed of rotating objects without contacting the surface by using a laser beam and reflective tape

407860 Heavy Duty Vibration Meter

Measure Velocity, Acceleration and Displacement plus built-in PC interface

Features:

- Selectable units of in/s or mm/s for Velocity, ft/s² or m/s² for Acceleration, and in or mm for Displacement
- Velocity range of 7.87in/s or 200mm/s; Acceleration range of 656ft/s² or 200m/s² Displacement range: 0.078in or 1.999mm Frequency range: 10Hz to 1kHz
- Basic accuracy of ±(5% of reading + 2 digits)
- Remote vibration sensor on 39" (1m) cable
- Max/Min, Data Hold and Auto Power off
- RMS or Peak Value measurement modes
- Auto/Manual store/recall up to 500 readings
- Optional 407001 software for downloaded data to your PC for analysis
- Dims: 7.1x2.9x1.3" (180x72x32mm); Wt: 0.87lbs (395g)

Ordering

407860Heavy Duty Vibration Meter
407860-NIST407860 with NIST Certificate
407001Data Acquisition Software & Serial Cable
156119117 VAC Adaptor
156221220 VAC Adaptor



Optional Data Acquisition and Datalogging PC software

Meter includes remote sensor with 3.9ft (1.2m) cable, magnetic mount, 9V battery, holster with stand and case; 3 year warranty.



Light Meters

Extech provides a wide range of measuring solutions from basic models that meet the requirements of a limited budget, to models with a wide measuring range that work in more demanding applications.

Featuring Model 407026

▶ Auto Zero

Set baseline measurements in the field

▶ High Resolution

For low level measurements in places like parking lots, stairwells, and ATM machines

▶ Light Source Selection

Source selection of Sodium, Daylight/Tungsten, Fluorescent and Mercury improves accuracy for common light sources

▶ PC Interface

Record data to a PC for analysis

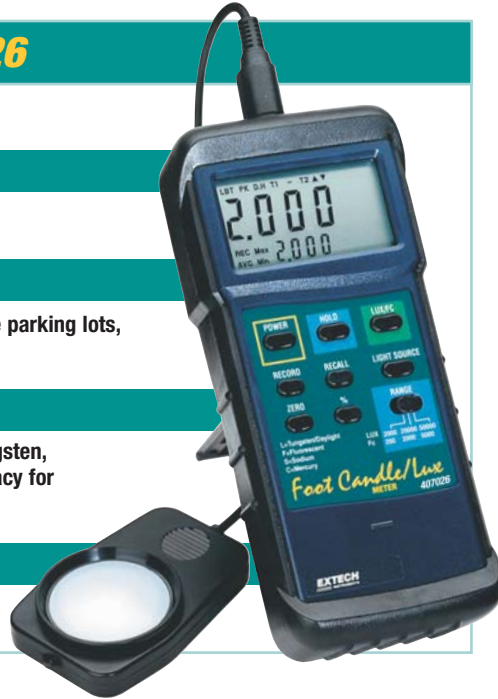

401027 Pocket Foot Candle Light Meter

Measures up to 2,000Fc for basic lighting applications

- Easy to operate Foot candle light meter with 2 ranges
- Convenient pocket size design
- Overrange indication
- Complete with 9V battery, light sensor with protective cover and 47" (1.2m) cable, and built-in stand

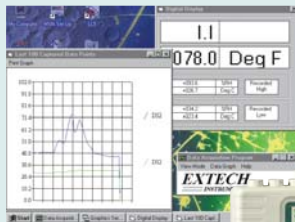

Software & Datalogger Designed For Extech's Heavy Duty Series



407001 — Data Acquisition Software

- Enables user of Extech's Heavy Duty series to capture, display and store readings on a PC
- Sampling time: 1sec - 60 mins
- Import data into Lotus or Excel
- Includes Windows® 95/98/2000/NT/XP compatible software on CD-ROM and serial cable
- Optional USB Adaptor — 407001-USB

380340 — Battery Operated Datalogger

- Captures up to 8000 readings from Extech's Heavy Duty meters
- Selectable sampling rates (1sec to 99hrs)
- Complete with 4 AA batteries, Windows® compatible software and cable. Optional AC Adaptor (153117 and 153220)

Order Meter with NIST Certificate*

All Extech meters come factory calibrated. For an additional charge, Extech will supply your meter with a Certificate of Calibration Traceable to N.I.S.T. with Data at multiple points. **To order meter with NIST:**

- 401027-NIST
- 401025-NIST
- 407026-NIST
- LT300-NIST

*Only products listed are available with NIST Certificate. Meter must be ordered with NIST Certificate at time of purchase.

Specifications

Model	401027
Fc Range	200, 2000Fc
Lux Range	—
Max. Resolution	0.1Fc
Basic Accuracy	±5% FS
Cosine & Color Corrected	Yes
Analog output	—
RS-232 Interface	—
Datalogging	—
Dimensions	5.2x2.8x1" (131x70x25mm)
Weight	6.9oz (195g)
CE	Yes
Warranty	1 year



401025 Foot Candle/Lux Meter

Includes analog output and fast/slow response feature

- Accurately displays light level in terms of Fc or Lux over three ranges
- Select fast (1 second) or slow (2 seconds) response time
- Analog output of 1mV per count for capturing readings to a recorder
- Complete with 9V battery, light sensor with protective cover and 47" (1.2m) cable, and built-in stand



LT300 Light Meter

Digital and Analog display of light in Foot-candles or Lux

- Wide range to 20,000 Foot- Candles or Lux with high resolution to 0.01 Fc/Lux
- Relative mode indicates change in light levels
- Peak mode captures highest reading
- Remote light sensor on 12" (305mm) coiled cable — expandable to 24" (609mm)
- Utilizes precision photo diode and color correction filter
- Cosine and color corrected measurements
- MIN/MAX and Data Hold
- Large LCD display with analog bargraph
- Backlight for readings in low light levels
- Complete with 9V battery, light sensor with protective cover, protective holster, and pouch case



407026 Heavy Duty Light Meter with PC Interface

Enhance accuracy by selecting one of four lighting types plus PC interface

- % displays differential from reference point
- "ZERO" Re-Calibration
- Enhance accuracy by selecting lighting type Tungsten/Daylight, Fluorescent, Sodium, Mercury
- MAX/MIN/AVG, Data Hold, and Auto power off
- Built-in RS-232 PC serial interface with optional 407001 Data Acquisition software 407001 and Datalogger 380340 (see p. 108 for details)
- Complete with 9V battery, light sensor, and protective cover with 46" (1.2m) cable, and protective holster with stand. Optional 117V (156119) or 220V (156221) AC adaptors (see p.107 for ordering).

401025	LT300	407026
200, 2000, 5000Fc	20,000Fc	200, 2000, 5000Fc
2000, 20000, 50000Lux	20,000Lux	2000, 20000, 50000LUX
0.1Fc/1Lux	0.01Fc/Lux	0.1Fc/1Lux
±5% FS	±5% rdg	±4%FS
Yes	Yes	Yes
Yes	—	—
—	—	Optional 407001 (see p. 108)
—	—	Optional 380340 (see p. 108)
6.4x2.8x1.2" (163x70x30mm)	5.9x2.95x1.57" (150x75x40mm)	7x2.9x1.3" (178x74x33mm)
8.3oz (220g)	7oz (200g)	1.6lbs (726g)
Yes	Yes	Yes
1 year	1 year	✓3 years



Light Meters & Dataloggers

Extech's Light meters include models with data collection capability for long term analysis of lighting conditions. Special functions provide fast measuring solutions in a wide range of applications.

Featuring Model HD450

Datalogging

Datalogs up to 16,000 readings

Relative Mode

Indicates change in light level

Peak Mode

Captures highest reading (10µS)

USB Interface & PC Software

Record data to a PC for analysis



In-house Calibration Lab for Light meters



NIST Certificate with Data



EA31 EasyView® Big Digit Light Meter

Measures light intensity up to 20,000Fc/Lux

- Compact and rugged design with large display and bargraph
- Data Hold and MIN/MAX readings
- Auto power off
- Complete with built-in stand, light sensor and protective cover with 39" (1m) coiled cable, protective holster, 6 AAA batteries, and carrying case



EA30 EasyView® Big Digit, Wide range Light Meter

Measures high intensity light up to 40,000Fc and 400,000Lux, is ideal for outdoor applications

- Compact and rugged design
- Large display with bargraph
- Relative function for zero or difference from reference value
- Peak captures short light pulses to 100µSeconds
- Data Hold and MIN/MAX readings
- Auto power off, Zero function
- Complete with built-in stand, light sensor and protective cover with 39" (1m) coiled cable, protective holster, 6 AAA batteries, and carrying case

Order Meter with NIST Certificate*

All Extech meters come factory calibrated. For an additional charge, Extech will supply your meter complete with a Certificate of Calibration Traceable to N.I.S.T. with Data at multiple points. **To order meter with NIST:**

- EA31-NIST
- EA30-NIST
- EA33-NIST
- HD400-NIST
- HD450-NIST

*Only products listed are available with NIST Certificate. Meter must be ordered with NIST Certificate at time of purchase.

Specifications

Model	EA31	EA30
Display counts	2000 count LCD	4000 count LCD
Fc Range	20, 200, 2000, 20,000Fc	40, 400, 4000, 40,000Fc
Lux Range	20, 200, 2000, 20,000Lux	40, 400, 4000, 40,000, 400,000Lux
Max. Resolution	0.01Fc/Lux	0.01Fc/Lux
Basic Accuracy	±3%rdg + 0.5%FS	±3%rdg + 0.5%FS
Cosine & Color Corrected	Yes	Yes
RS-232 Interface	—	—
Datalogging	—	—
Dimensions	5.9x2.8x1.4" (150x72x33mm)	5.9x2.8x1.4" (150x72x33mm)
Weight	8.3oz (235g)	8.3oz (235g)
CE	Yes	Yes
Warranty	1 year	1 year



EA33 EasyView® Light Meter with Memory

Advanced illuminance functions and features

- Wide measurement range to 99,990Fc (999,900 Lux)
- Luminous intensity (candela) calculations
- Store and recall up to 50 measurements, includes relative or real time clock stamp
- Ripple function excludes the effect of stray light from the primary light source measurement
- Auto power off with disable
- Multiple point average function
- Timed-Hold, Relative in absolute value or % deviation, and Comparator function with high/low alarms
- Includes built-in stand, light sensor and protective cover with 36" (0.9m) coiled cable, protective holster, 6 AAA batteries, and case



Software included

HD400 Light Meter

Large backlit display with fast, 40-segment bar graph for capturing trends

- Wide range to 40,000Fc or 400,000Lux
- Cosine and color corrected measurements
- Utilizes precision silicon photo diode and spectral response filter
- Peak mode (10µs) captures highest reading
- Relative mode indicates change in light levels
- Heavy duty, rugged double molded housing
- Built-in USB port
- Includes light sensor and cover with 39" (1m) cable, Windows® 95/98/NT/2000/ME/XP compatible software with USB cable, built-in stand, hard carrying case, and 9V battery



Software included

HD450 Light Meter Datalogger

Automatically stores up to 16,000 readings or manually store/recall up to 99 readings

- Records in a continuous mode up to 16,000 readings
- Wide range to 40,000Fc or 400,000Lux
- Cosine and color corrected measurements
- Utilizes precision silicon photo diode and spectral response filter
- Peak mode (10µs) captures highest reading
- Relative mode indicates change in light levels
- Heavy duty, rugged double molded housing
- Built-in USB port
- Includes light sensor and cover with 39" (1m) cable, Windows® 95/98/NT/2000/ME/XP compatible software, USB cable, built-in stand, case, and 9V battery

EA33	HD400	HD450	Model
999,999 count LCD	4000 count backlit LCD	4000 count backlit LCD	Display counts
9.999, 99.99, 999.9, 9999, 99,990Fc	40, 400, 4000, 40kFc	40, 400, 4000, 40kFc	Fc Range
99.99, 999.9, 9999, 99,990, 999,900Lux	400, 4000, 40k, 400kLux	400, 4000, 40k, 400kLux	Lux Range
0.001Fc/0.01Lux	0.01Fc/0.1Lux	0.01Fc/0.1Lux	Max. Resolution
±3%	±5%	±5%	Basic Accuracy
Yes	Yes	Yes	Cosine & Color Corrected
—	USB with software included	USB with software included	RS-232 Interface
—	—	16,000 data (continuous)/ 99 data (manual)	Datalogging
5.9x2.8x1.4" (150x72x33mm)	6.7x 3.1x1.6" (170x80x40mm)	6.7x 3.1x1.6" (170x80x40mm)	Dimensions
11.29oz (320g)	13.7oz (390g)	13.7oz (390g)	Weight
Yes	Yes	Yes	CE
1 year	✓3 year	✓3 year	Warranty



Sound Level Meters

Extech sound meters include all the features/functions needed for basic noise level surveys or to meet the requirements for OSHA compliance, community noise ordinances or machine noise evaluation.

Featuring Model 407732-KIT



Special Value Kit

▶ Type 2 Precision

Meets ANSI and IEC standards to conform to OSHA guidelines

▶ Sound Level Calibrator

Verifies Sound Meter calibration (94/114dB) before & after use

▶ Hard Carrying Case

Conveniently stores and protects your meter

Accessories

TR100Tripod (for meters with Tripod mount feature)
40705X...AC/DC Recorder Output Cable

Order Meter with NIST Certificate*

All Extech meters come factory calibrated. For an additional charge, Extech will supply your meter complete with a Certificate of Calibration Traceable to N.I.S.T. with Data at multiple points. **To order meter with NIST:**

407703A-NIST
407730-NIST
407732-NIST
407732-KIT-NIST
407736-NIST
407750-NIST
407744-NIST
407766-NIST

*Only products listed are available with NIST Certificate. Meter must be ordered with NIST Certificate at time of purchase.

Specifications

Model	407703A	407730
Range	54 to 126dB	40 to 130dB
Basic Accuracy	±2dB	±2dB
Weighting (A&C)	Yes	Yes
Response Time (Fast/Slow)	Yes	Yes
Condenser Microphone	0.5" (12.7mm)	0.5" (12.7mm)
Analog Output	AC	AC
Dimensions	7.1x2.7x1.4" (180x68x36mm)	9x2.2x1.7" (230x57x44mm)
Weight	5.1oz (145g)	5.6oz (160g)
CE	Yes	Yes
Warranty	1 year	1 year



407703A Analog Sound Level Meter

Check noise level economically

- Easy to read analog display
- MAX Hold
- Battery check
- Analog AC output for connection to chart recorders and dataloggers
- Tripod mount for field use (optional TR100 Tripod — sold separately)
- Complete with 9V battery



407730 Digital Sound Level Meter

Analog bargraph with 30dB range updates every 40ms

- ±2dB accuracy with 0.1dB resolution
- AC analog output
- Record MAX/MIN values over time
- Auto power off and MAX Hold functions
- Utilizes 0.5" (12.7mm) condenser microphone
- Tripod mount for field use (optional TR100 Tripod — sold separately)
- Complete with microphone wind cover and four AAA batteries



Optional 407732-KIT comes complete with a sound calibrator and case

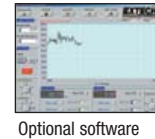

Optional software

Sound Level Calibrators

407766
(94dB/114dB)



407744
(94dB)

407732 Type 2 Sound Meter

Two range meter with backlit LCD display

- High accuracy meets Type 2 standards (ANSI S1.4-1983, IEC 60651, EN 60651)
- High & Low measuring ranges
- Data Hold and MAX Hold functions
- Backlit display to view in dimly lit area
- Complete with microphone wind cover and 9V battery
- Optional 407732-NISTL includes Certificate of Traceability to NIST at single point calibration to 94dB
- Optional 407732-KIT includes 407732 Sound Meter, 407722 94dB Sound Calibrator, and protective hard carrying case
(Optional NIST available for kit: 407732-KIT-NIST includes 407732-NISTL and 407722-NIST)

407736 Type 2 Sound Meter with Calibration Check

High accuracy Type 2 meter

- High accuracy meets Type 2 standards (ANSI S1.4-1983, IEC 60651, EN 60651)
- High and Low measuring ranges
- MAX Hold with reset button
- Built-in calibration check (94dB)
- Analog AC/DC outputs for connection to an analyzer or recorder
- Tripod mount for field use (optional TR100 Tripod — sold separately)
- Optional 407744 or 407766 Sound Calibrator
- Complete with microphone wind cover, 9V battery, and carrying case

407750 Sound Level Meter with PC Interface

Big backlit display, PC interface & background sound absorber

- High accuracy meets Type 2 standards (ANSI S1.4-1983, IEC 60651, EN 60651)
- Background noise absorber for noise measurements with high ambient noise levels
- RS-232 interface for capturing data to PC, optional Windows® 95/98/NT/2000/ ME/XP compatible software (407752)
- Large backlit display with analog bargraph
- Auto/Manual ranging and MIN/MAX readings
- Analog AC/DC outputs for connection to a recorder
- Tripod mount (optional TR100 Tripod — sold separately)
- Complete with microphone wind cover, 9V battery and case

- Calibrate and verify Sound Level Meter operation
- 1kHz sine wave at 94dB/114dB (407766) or 94dB (407744) is generated to an accuracy of $\pm 5\%$ (frequency) and $\pm 0.5\text{dB}$ (94dB); $\pm 0.8\text{dB}$ (114dB)
- Accommodate both 0.5" to 1.0" microphones
- For use with all of Extech's Sound Level Meters
- Includes screwdriver, two 9V batteries, and carrying case

407732	407732-NISTL	407732-KIT	407736	407750	Model Range
Low: 35 to 100dB			Low: 35 to 90dB	30 to 130dB	
High: 65 to 130dB			High: 75 to 130dB		
$\pm 1.5\text{dB}$ (Type 2)			$\pm 1.5\text{dB}$ (Type 2)	$\pm 1.5\text{dB}$ (Type 2)	Basic Accuracy
Yes			Yes	Yes	Weighting (A&C)
Yes			Yes	Yes	Response Time (Fast/Slow)
0.5" (12.7mm)			0.5" (12.7mm)	0.5" (12.7mm)	Condenser Microphone
—			AC/DC	AC/DC	Analog Output
8.2x2.1x1.25" (210x55x32mm)			9.5x2.7x1" (241x69x25mm)	10x3.1x1.5" (256x80x38mm)	Dimensions
8.1oz (230g)			7.6oz (215g)	8.5oz (240g)	Weight
Yes			Yes	Yes	CE
1 year			1 year	1 year	Warranty



Sound Level Meters & Dataloggers

Extech's Sound Level Meters with PC interface are Type 2 meters with the added capability to store data directly into internal memory or to a computer.

Featuring Model **HD600**

▶ Type 2 Precision

Meets new IEC 61672-1 accuracy standard for OSHA and other local and national noise ordinances

▶ Built-in Datalogger

Stores up to 20,000 records with real date and time stamp

▶ USB Interface

For downloading, storing and documenting test results to a PC. Records up to 10 readings/second when dB recording directly to a PC



TR100



407764-EXT

Accessories

Calibrators

- 40774494dB Sound Calibrator (0.5", 1" microphones)
- 407744-NIST..407744 with NIST Certificate
- 40776694/114dB Sound Calibrator (0.5", 1" microphones)
- 407766-NIST..407766 with NIST Certificate

Tripod

- TR100Tripod (for meters with Tripod mount feature)

Cables & Software

- 40705X.....AC/DC Recorder Output Cable (3ft/0.9m)
- 407764-EXT ...15ft (4.7m) Microphone Extension Cable
- USB100.....RS-232 to USB adaptor

AC Adaptors for 407764, 407780, 407790

- 144118110 VAC Adaptor
- 144220220 VAC adaptor
- 144240240 VAC adaptor

Order Meter with NIST Certificate*

All Extech meters come factory calibrated. For an additional charge, Extech will provide a Certificate of Calibration Traceable to N.I.S.T. with Data at multiple points. **To order meter with NIST:**

- 407768-NIST
- HD600-NIST
- 407764-NIST
- 407780-NIST

*Only products listed are available with NIST Certificate. Meter must be ordered with NIST Certificate at time of purchase.

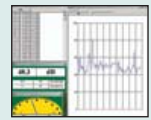

Software included

407768 Sound Level Meter with PC Interface

Includes Windows® compatible software

- High accuracy meets Type 2 standards (ANSI S1.4-1983, IEC 61672 Class 2, EN 60651)
- Auto/Manual ranging
- MIN/MAX and Max Hold
- RS-232 interface for capturing data directly on a PC
- Analog AC output for connection to a recorder
- Tripod mount ideal for field use (optional TR100 Tripod — sold separately)
- Complete with 9V battery, Windows® 95/98/NT/2000/XP compatible software, Serial cable, and carrying case

Specifications

Model	407768
Range	30 to 130dB
Basic Accuracy	±1.4dB
Weighting (A & C)	Yes
Response Time (Fast/Slow)	Yes
Condenser Microphone	0.5" (12.7mm)
Analog Output	AC
PC Interface	Included
Datalogging	—
Dimensions/Weight	10.6x2.7x1.1" (268x68x29mm)/10oz (284g)
CE	Yes
Warranty	1 year

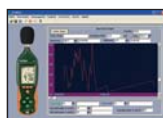

Software included

HD600 20,000 Point Datalogging Sound Level Meter

Double Molded housing with USB port

- 1.4dB accuracy
- Meets ANSI and IEC 61672-1 Type 2 standards
- Capture up to 10 readings/sec when connected to a PC
- Datalogging capability up to 20,000 records at speeds from 1/sec to 1/59sec
- Records readings with real date and time stamp
- MIN/MAX and Data Hold
- USB port includes PC software
- Tripod included for convenient field use
- Auto power off with disable capability
- Complete with AC Adaptor, Windows® compatible software with USB cable, wind cover, tripod, built-in stand, hard carrying case, and 9V battery



Software included

407764 128,000 point Datalogging Sound Level Meter

Type 2 meter with datalogging memory plus PC interface

- High accuracy meets Type 2 standards (ANSI S1.4-1983, IEC 60651, EN 60651)
- Large LCD with bargraph display
- Stored data can be transferred to a PC via RS-232 interface
- Real time and Date are logged with data; MAX Hold function
- Tripod mount ideal for field use (optional TR100 Tripod — sold separately)
- Optional 15ft (4.7m) microphone extension cable 407764-EXT for measurements in enclosures and other remote locations
- Complete with microphone wind cover, Windows® compatible software, Serial cable, 4 AA batteries, and case (Optional AC Adaptor - see page 114)



Software included

407780 Integrating Sound Level Datalogger

Leq and SEL measurements with built-in datalogger and PC interface

- Meets Type 2 standards (ANSI S1.4-1983, IEC 60651, EN 60651)
- Datalogging function records up to 32,000 records
- Programmable integrating time; Real time calendar/clock
- Linearity over wide range (100dB)
- Display modes: SPL, SEL, Lmax/Lmin, Leq
- Impulse/Fast/Slow response time
- Tripod mount ideal for field use (optional TR100 Tripod — sold separately)
- Complete with RS-232 cable, 9 to 25 pin gender changer, Windows® 95/98/NT/2000/ME/XP compatible software, microphone wind cover, 4 AA batteries and carrying case; (Optional AC adaptor)

HD600	407764	407780
30 to 130dB	30 to 130dB	30 to 130dB
±1.4dB	±1.5dB	±1.5dB
Yes	Yes	Yes
Yes	Yes	Yes
0.5" (12.7mm)	Detachable 0.5" (12.7mm)	Detachable 0.5" (12.7mm)
AC/DC	AC/DC	AC/DC
USB	Included	Included
20,000 Records	128,000 Records	32,000 Records
10.9x3x2" (278x76x50mm)/12.3oz (350g)	10.4x2.8x0.8" (265x72x21mm)/11.5oz (358g)	10.4x2.8x0.8" (265x72x21mm)/10.9oz (310g)
Yes	Yes	Yes
1 year	✓3 years	1 year

407760 USB Sound Level Datalogger **NEW**

High accuracy datalogging of up to 129,920 records

Features:

- Designed to meet ANSI and IEC 61672 Class 2 standards
- USB interface for easy setup and data download
- Selectable data sampling rate
- Records readings with real time clock
- Two start methods: programmed (from PC) or manual
- Includes 3.6V Lithium battery, Windows® compatible software, USB cover, tripod, and windscreen

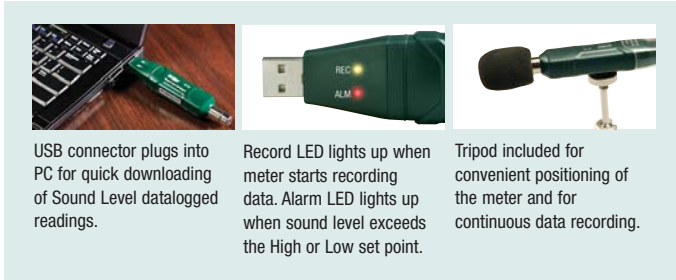

USB connector plugs into PC for quick downloading of Sound Level datalogged readings.

Record LED lights up when meter starts recording data. Alarm LED lights up when sound level exceeds the High or Low set point.

Tripod included for convenient positioning of the meter and for continuous data recording.

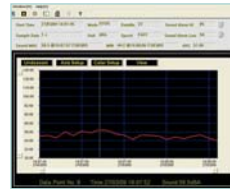

Includes PC software for further analysis of downloaded data



Specifications	Functions	
	Condenser Microphone	0.5" (12.7mm)
	Range	30 to 130dB
	Frequency Range	31.5 to 8kHz
	Basic accuracy	±1.4dB
	Weighting	A and C
	Response Time	Fast (125ms)/Slow (1s)
	Datalogging	129,920 points
	PC Interface	USB
	Dimensions/ Weight	5.1 x 1.1 x 0.9" (130 x 30 x 25mm)/ 1oz (20g)

Ordering

- 407760USB Sound Level Datalogger
- 407760-NISTL.407760 with NIST Certificate (single point)
- 42299.....3.6V Lithium Battery (pkg of 2)

SL130G Sound Level Alert with Alarm

Continuous monitoring of Sound Level — Built-in LEDs alert user when sound level is too high or too low

Features:

- Bright LEDs (red flashing or green) alert user when sound level is too high or too low – LEDs can be read from 30m (100ft)
- Continuous Monitoring of Sound Level
- Ideal for hospital, auditoriums, schools and other areas where there is a need for being alerted when sound level reaches set point
- Meets ANSI Type 2 and EN IEC 60651 standards — compliant to OSHA
- Wall, desk or tripod mount (optional TR100 tripod — sold separately)
- Settable high/low limit indication with output to drive external relay module (Optional SL123 & SL124 relay modules)
- Microphone rotates 180° for desired placement. Optional 15ft (5m) microphone extension cable (SL125) for remote monitoring
- Complete with AC adaptor and microphone wind cover



Specifications	Display	
	Frequency bandwidth	31.5 Hz to 8 kHz
	Microphone	0.5" Electret Condenser Microphone (removable)
	Measurement ranges	30 to 80dB, 60 to 110dB, 80 to 130dB
	Frequency weighting	'A' and 'C' (Programmable)
	Response time	Fast (125ms) / Slow (1s) (Programmable)
	Resolution	0.1dB
	Alarm output	3.5mm Mono Phone Plug, Maximum: 3.4mA @ 5 VDC
	Minimum Output	Voltage: 2.5 VDC
	Power	AC/DC Adaptor for full functions; 8xAA batteries for monitoring function only without LED alert
	CE/Warranty	CE approved/ 1 year warranty
	Dimensions / Weight	8.75x7.1x1.25" / 0.63 lbs. (22x18x3.2cm / 285g)

Ordering

- SL130GSound Level Alert (with 110V adaptor)
- SL130G-NIST ..SL130G with NIST Certificate
- SL130-220Sound Level Alert (with 220V adaptor)
- SL130-240.....Sound Level Alert (with 240V adaptor)
- Accessories**
- SL123AC Alarm Relay Module 9 foot cable (3m)
- SL124DC Alarm Relay Module 9 foot cable (3m)
- SL125Remote Microphone cable 15'
- TR100Tripod (for meters with Tripod mount feature)
- 407766Sound Level Calibrator, 94/114dB

407790 Real Time 1/3 Octave Band Analyzer

Type 2 integrating sound level meter with Octave and 1/3 Octave Band Real Time display

Features:

- 160x160 dot matrix backlit LCD
- Memory stores 12,280 records in SLM mode and 1024 points in 1/1 or 1/3 octave mode
- Stored data can be transferred to a PC and analyzed using software and cable provided
- A, C, Flat weighting; Fast/Slow response time
- Detachable 0.52" (13.2mm) diameter condenser microphone and Tripod mount
- Real time clock with Year, Month, Day, Hour, Minute, and Second display
- Maintain noise level statistics for internal and external audits

Specifications	Applicable standards	ANSI S1.4 Type 2, EN IEC 60651, EN IEC 60804, and EN IEC 1260-1995
	Accuracy	±1.5dB (ref 94dB @ 1kHz)
	Measurement range / function	30dB to 130dB / La, Lc, Lp, Leq, LE, Lmax, Lmin
	Frequency range	25Hz ~ 10kHz
	Sound level meter display	Integrating SLM: Digital, 4 Digits with Bargraph
	Real Time Analyzer display	Graphical, Bargraph with cursor
	1/1- 1/3 Analyzer level range	30 to 130dB
	1/1 Octave and 1/3 Octave	1/1 Octave band center frequencies: (9 bands); 1/3 Octave band center frequencies: (27 bands);
	Signal output	AC output: 2 Vrms (at full scale); DC output: 10mVDC/dB
	Power	Four type C size 1.5V batteries, External DC power: 6V, 1A
Safety/Warranty	CE approved, one year warranty	
Dimensions/Weight	13.6x3.9x2.4" (345x100x60mm)/ 33.5oz (950g)	

Ordering

- 407790.....Octave Band Sound Analyzer
 407790-NIST.....407790 with NIST Certificate
 407764-EXT.....15ft (4.7m) Microphone Extension Cable
 407744.....94dB Sound Level Calibrator (see page 113)
 407766.....94/114dB Sound Level Calibrator (see page 113)
 USB100.....RS-232 to USB Adaptor



Complete with Windows® 95/98/NT/2000/ME compatible software, Serial cable, 4 x C batteries, mini screwdriver, 120V AC adaptor, and case. See page 114 for 220-240V Adaptors



407355 Personal Noise Dosimeter Datalogger

Measure total sound exposure over an 8-hour period

Features:

- Perform OSHA and IEC Noise accumulation surveys
- Adjustable Criterion Level, Exchange Rate, and Threshold
- Optional 94/114dB calibrator to perform "before" and "after" calibration checks
- Ideal for personal/workplace accumulated noise exposure
- Bi-directional RS-232 with Windows® 95/98/NT/2000/ ME/XP compatible software to control setup and retrieve stored events or analyze real time measurements. Software lists and graphs functions. Complete with 9 pin to 25 pin adaptor and RS-232 cable
- Datalogs up to 4500dB readings when used as a sound level meter
- Stores up to 5 dosimeter surveys. Data includes Start/Stop Time, %Dose, TWA, Peak flags, when used in the Dosimeter mode
- Complete with belt clip, clip-on 0.5" microphone with 2.6ft (0.8m) cable, software, 4 AAA batteries, mini screwdriver and carrying case
- Available kit 407355-KIT-5 includes five 407355 Dosimeters, 407766 Sound level calibrator, and carrying case



407355-KIT-5 — Dosimeter Kit

Includes software

Specifications	Standards	Meets ANSI S1.25 (1991) Type 2, ISO-1999, BS 402 (1983)
	Range/Resolution	70 to 140dBA / 0.1dB (Frequency A Weighting)
	Digital Display	LCD 0.01-9999%
	Criterion/Threshold Level	80, 84, 85 or 90dB/ 70-90 (1db steps)
	Response Rate/Exchange Rate	Fast or Slow/ 3, 4, 5 or 6 dB
	High Level Detector/Peak Flag	115dB / 140dB
	Battery Life	34 hrs
	Event Storage	5 surveys
	CE/Warranty	CE approved, one year warranty
	Dimensions/Weight	4.2x2.5x1.3" (106x64x34mm)/ 8oz (227g) incl. batteries

Ordering

- 407355.....Noise Dosimeter/Datalogger
 407355-NIST...407355 with NIST Certificate
 407355-KIT-5...Noise Dosimeter/Datalogger Kit
 407744.....94dB Sound Level Calibrator (see page 113)
 407766.....94/114dB Sound Level Calibrator (see page 113)
 USB100.....RS-232 to USB Adaptor



Contact & Photo Tachometers

Extech offers both contact models for direct measurements and non-contact models (including laser models) for use on machinery where access is limited or high speed measurements are required.

Featuring Model **RPM10**

► Non-contact and Contact rpm

Combination meter permits rpm measurements in any situation

► Laser Light Source

Provides greater measuring distance up to 6.5ft (2m)

► Built-in InfraRed Thermometer

Quickly locate overheating motors or bearings

► Double Molded Housing

for better grip and added durability



Patented



RPM10 - Tachometer's patented built-in InfraRed Thermometer takes non-contact surface Temperature measurements.



461891 Contact Tachometer

Fast and accurate RPM and surface speed measurements

- Make contact measurements of rotating objects
- Measure linear surface speeds in ft/min or m/min using three accessory wheels provided
- Recalls Last/MAX/MIN values
- Complete with cone tip, flat tip and spare wheel for surface speed measurements, four 1.5V AA batteries, and carrying case



461893 Non-contact Photo Tachometer

Non-contact RPM measurements using visible light

- Make non-contact rpm measurements of rotating objects
- Use reflective tape on object to be measured and point the integral light beam
- Integral light beam has an ideal measurement range up to 6" (152mm) distance
- Readings updated every second
- Recalls Last/MAX/MIN values
- Complete with 23" (0.6m) reflective tape, four 1.5V AA batteries, and carrying case

Order Meter with NIST Certificate*

All Extech meters come factory calibrated. For an additional charge, Extech will supply your meter complete with a Certificate of Calibration Traceable to N.I.S.T. with Data at multiple points. **To order meter with NIST:**

- 461891-NIST
 - 461893-NIST
 - 461895-NIST
 - 461995-NIST
 - RPM10-NIST
- Limited NIST: Product certified to all functions except IR Thermometer.
RPM10-NISTL

*Only products listed are available with NIST Certificate. Meter must be ordered with NIST Certificate at time of purchase.

Specifications

Model	461891	461893
Range rpm	0.5 to 20,000	5 to 99,999
ft/min	0.2 to 6560	—
m/min	0.05 to 1999.9	—
yd/min	—	—
Basic Accuracy	±0.05%rdg	±0.05%rdg
Max rpm Resolution	0.1rpm	0.1rpm
Laser	—	—
Temperature (IR)	—	—
Dimensions	6.7x2.8x1.5" (170x27x37mm)	6.7x2.8x1.5" (170x27x37mm)
Weight	9.2oz (260g)	8.8oz (250g)
CE	Yes	Yes
Warranty	1 year	1 year



**461895
Combination
Contact/Photo
Tachometer**

Combines both contact and non-contact models for use in all applications

- Characters on display reverse direction depending on contact or photo mode
- Uses visible light to read up to 6" (150mm) from target
- Memory/readings button holds last reading for 5 min and recalls min/max readings
- Complete with wheels for linear surface speed or rpm measurements, four 1.5V AA batteries, 23" (0.6m) reflective tape, and carrying case



**461995
Combination
Contact/
Laser Photo
Tachometer**

Combines both contact and non-contact models for use in all applications

- Characters on display reverse direction depending on contact or photo mode
- **Laser guided** for greater distance non-contact measurements up to 6.5ft (2m)
- Memory/readings button holds last reading for 5 min and recalls MAX/MIN readings
- Complete with wheels for linear surface speed or rpm measurements, four 1.5V AA batteries, 23" (0.6m) reflective tape, and carrying case



BUILT IN IR
Thermometer
Patented

**RPM10
Combination Laser
Tachometer +
IR Thermometer**

Photo/Contact Tachometer includes a non-contact IR Thermometer for surface temperature measurements

- Built-in IR thermometer with laser measures remote surface temperature on motors and rotating parts
- Fixed 0.95 emissivity, 6:1 distance to target ratio
- Non-contact Photo tachometer uses a Laser for greater measuring distance up to 6.5ft (2m)
- Contact tachometer for RPM and surface speed measurements
- Recalls Last/MAX/MIN values
- Characters on display reverse direction depending on mode
- Complete with tips/wheel, four 1.5V AA batteries, reflective tape, and carrying case

Accessories

**461937
Reflective Tape**



- Used with non-contact Photo Tachometers to measure speed of rotating objects
- Includes ten reflective tape strips — 23" x 0.25" (584mm x 6mm) ea. strip

**461990
Contact Wheels**



- Used with Contact Tachometers to measure surface speed of rotating objects and linear speed
- Includes 2 sets of three attachments (cone tip, flat tip, and spare wheel)

461895	461995	RPM10	Model
Photo: 5 to 99,999 / Contact: 0.5 to 19,999	Photo: 10 to 99,999 / Contact: 0.5 to 19,999	Photo: 10 to 99,999 / Contact: 0.5 to 20,000	Range rpm
0.2 to 6560	0.2 to 6560	0.2 to 6560	ft/min
0.05 to 1999.9	0.05 to 1999.9	0.05 to 1999.9	m/min
—	—	—	yd/min
±0.05%rdg	±0.05%rdg	±0.05%rdg	Basic Accuracy
0.1rpm	0.1rpm	0.1rpm	Max. rpm Resolution
—	Yes	Yes	Laser
—	—	-4 to 600°F (-20 to 315°C)	Temperature (IR)
8.5x2.6x1.5" (216x66x38mm)	8.5x2.6x1.5" (216x66x38mm)	8.5x2.6x1.5" (216x66x38mm)	Dimensions
10.6oz (300g)	10.6oz (300g)	10.6oz (300g)	Weight
Yes	Yes	Yes	CE
1 year	1 year	1 year	Warranty

461920 Mini Laser Photo Tachometer Counter

Non-contact RPM and Revolution count measurements

Features:

- Measure non-contact RPM readings of rotating objects by pointing the integral laser on the reflective tape placed on the object to be measured
- Large 5 digit LCD display with backlighting
- Memory button for Last/MAX/MIN readings
- Counter function counts to 99,999 revs
- Rugged double molded housing
- Complete with 9V battery and reflective tape



Specifications	Function	
	RPM range	2 to 99,999 rpm
	Count range	1 to 99,999 rev (revolution)
	Target Distance	1.6ft (500mm)
	Basic Accuracy	±0.05%
	Resolution	0.1rpm, 1 count
	Memory	Min/Max/Last
	Dimensions/Weight	6.2x2.3x1.6" (160x60x42mm)/5.3oz (151g)

Ordering

- 461920Mini Laser Photo Tachometer Counter
- 461920-NIST ...461920 with NIST Certificate
- 461937Spare reflective tape (23" each strip), 10pk

461700/461750 PocketTach® Mini Tachometers

For rpm and surface speed measurements

Features:

- Ergonomically designed and pocket size housing with protective finger guard
- Large (99,999 count) LCD display
- Autoranging with 0.1% basic accuracy
- Hold button freezes displayed readings
- Complete with 9V battery; 461700 includes reflective tape; 461750 includes surface wheels
- 461750 Contact Tachometer
 - Surface wheels enable tachometer to measure linear surface speeds (ft/min, m/min, yd/min)
- 461700 Non-contact Tachometer
 - Use reflective tape on object to be measured and point the integral light beam
 - Measures up to 6" (152mm) from target



Specifications	Function	Model 461700	Model 461750
	rpm (max res.)	10 to 99,999rpm (0.001)	10 to 10,000rpm (0.001)
	ft/min (max res.)	—	3 to 6560ft/min (0.0001)
	m/min	—	1 to 1999.9m/min
	yd/min	—	1 to 5,000yd/min
	Basic accuracy	±0.1%rdg	±0.1%rdg
	Sampling Time	1sec>60rpm, >1sec>10 to 60rpm	1sec>60rpm, >1sec>10 to 60rpm
	Dimensions	4.9x2x1.3" (124x50x33mm)	5.9x2x1.3" (149x50x33mm)
	Weight	4oz (114g)	5oz (142g)

Ordering

- 461700PockerTach® Mini Photo Tachometer
- 461700-NIST....461700 with NIST Certificate
- 461750PockerTach® Mini Contact Tachometer
- 461750-NIST....461750 with NIST Certificate

461825 Combination Photo Tachometer/Stroboscope

2 meters in one — Stroboscope to analyze rotating objects and Tachometer to measure rpms

Features:

- Stroboscope course and fine flash rate adjustments to freeze and analyze rotating objects
- Unique display features characters that reverse direction depending on measurement mode
- Large 0.4" (10mm) 5 digit LCD display
- Memory stores Last/MAX/MIN readings
- Complete with four 1.5V AA batteries, reflective tape, and carrying case



Specifications	Function	Photo Tachometer (rpm)	Stroboscope (fpm/rpm)
	Range (rpm)	5 to 99,999	100 to 100,000
	Accuracy	±0.1%rdg	±0.1%rdg
	Sampling Time	1 Sec ≥ 60rpm;	1 Sec ≥ 60rpm;
	Resolution	0.1rpm (<1,000rpm) 1rpm (≥1,000rpm)	0.1fpm (<1,000fpm) 1fpm (≥1,000fpm)
	CE/Warranty	CE approved, one year warranty	
	Dims/Wt	8.5x2.6x1.5" (215x65x38mm) / 10.6oz (300g)	

Ordering

- 461825Tachometer/Stroboscope
- 461825-NIST....461825 with NIST Certificate
- 461937Spare reflective tape (23" each strip), 10pk

461830 Digital StroboTach

Freeze motion and analyze rotating objects without contact

Features:

- Checks and analyzes motion and speed by simply aiming and synchronizing its flash rate (fpm) with a rotating object
- rpms on 4 digit LED display
- Flash/Speed Rate of 100 to 10,000fpm/rpm; Basic accuracy of 0.05% rdg
- Duty Cycle of 5 to 30mins
- Tripod mount for stationary use
- Dims: 8.3x4.8x4.8" (211x122x122mm)
Wt: 2.2lbs (1kg)
- CE approved, 1 year warranty
- Complete with 6ft (1.9m) power cord and handle



Ordering

- 461830Digital StroboTach 115VAC, 60Hz
- 461830-NIST ..461830 with NIST Certificate
- 461831Digital StroboTach 220VAC, 50Hz
- 461831-NIST ..461831 with NIST Certificate
- 461834Spare Xenon Lamp (est life 300hrs), 2pk

461960 RPM Controller/Monitor

Built-in Control and Alarm Relays with user-settable high/low alarm limits

Features:

- RPM, m/min, ft/min
- Hysteresis value setting for control and alarm functions
- Roller diameter value setting for surface speed measurement
- User settable pulse per rotation value
- Large 0.5" (13mm) 4-digit LED display
- DIN size 3.8x1.9x4.2" (96x48x107mm)
- RS-232 interface with optional software
- Optional proximity and photo sensors
- Complete with bracket for mounting in standard 1/8 DIN panel cutout



461957 Photoelectric 461955 Proximity

Function	
Input Signal	Pulse
Time Base	Quartz Crystal
Range	10 to 99,999RPM, 0.2 to 32,805ft/min, 0.05 to 9,999m/min
Resolution	0.1RPM, 0.1ft/min, 0.01m/min
Accuracy	±(0.1% + 1 digit)
Sampling Time	1 second (approx)
Relay Outputs	Control (1ACA/250ACV; 1DCA/24DCV max) High/Low Alarm (1ACA/250ACV; 1DCA/24DCV max)
Sensor Power Supply	12VDC, 50mA max
Power	90 to 260VAC, 50/60Hz
CE/ Warranty	CE/ 1 year
Dimensions/Weight	3.8x1.9x4.2" (96x48x107mm)/ 13.5oz (384g)

Ordering

- 461960RPM Controller/Monitor
- 461955Proximity Sensor, max. 36,000rpm
- 461957Photoelectric Sensor, max. 6000rpm
- 407001Data Acquisition Software and Cable

461950 1/8 DIN Panel Tachometer

Continuous & accurate readings from 5 to 99,990rpm

Features:

- Large LED display updates 1/sec (rpm<60)
- Unique design permits rpm measurements of a one hole gear or disk eliminating the need for special gears
- A pulse is measured when a ferrous object (stud) passes by sensor
- Choice of two sensor pickup types (both include 6ft/1.8m cable): Proximity sensor: 0.1" (3mm) target distance, range up to 36,000rpm (600Hz); Photoelectric sensor: 0.4" (10mm) target distance, range up to 6000rpm (100Hz)



461957 Photoelectric 461955 Proximity

Function	
rpm	5 to 99,990rpm
Basic accuracy	±0.05%
Resolution	0.1rpm (5 to 1000rpm), 1rpm (1000 to 9999rpm), 10rpm (10,000rpm to 99,990rpm)
Power	115V or 230V AC; 50/60Hz
Warranty	1 year
Dimensions/Weight	Bezel 3.8x1.9x2.4" (96x48x60mm); Panel cutout 3.6x1.8" (92x45mm) Meter 3.6x3.5x1.7" (92x90x42mm)/ 14oz (397g)

Ordering

- 461950Panel Mount Tachometer
- 461955Proximity Sensor, max. 36,000rpm
- 461957Photoelectric Sensor, max. 6000rpm

HD700 Series Differential Pressure Manometers **NEW**

Low Range/High Resolution Gauge or Differential Pressure

Features:

- Three models to choose from: Model HD700 (± 2 psi range) Model HD750 (± 5 psi range), and Model HD755 (± 0.5 psi range)
- 11 selectable units of measure
- MAX/MIN recording and Relative time stamp
- Data Hold, Auto power off, and Zero function
- Large LCD display with backlighting
- USB port includes PC software
- Includes 9V battery, Windows® compatible software with USB cable, AC adaptor, connection hose, built-in stand, and hard carrying case

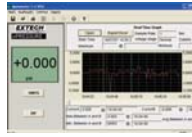

Software included



HD700 - (2psi)

HD750 - (5psi)

HD755 - (0.5psi)

Function	HD700 Range (Res.)	HD750 Range (Res.)	HD755 Range (Res.)	Basic Accuracy
psi	2psi (0.001psi)	5psi (0.001psi)	0.5psi (0.001psi)	$\pm 0.3\%FS$
inH ₂ O	55.40inH ₂ O (0.01inH ₂ O)	138.3inH ₂ O (0.1inH ₂ O)	13.85inH ₂ O (0.01inH ₂ O)	$\pm 0.3\%FS$
mbar	137.8mbar (0.1mbar)	344.7mbar (0.1mbar)	34.47mbar (0.01mbar)	$\pm 0.3\%FS$
kPa	13.78kPa (0.01kPa)	34.47kPa (0.01kPa)	3.447kPa (0.001kPa)	$\pm 0.3\%FS$
inHg	4.072inHg (0.001inHg)	10.18inHg (0.01inHg)	1.018inHg (0.001inHg)	$\pm 0.3\%FS$
mmHg	103.4mmHg (0.1mmHg)	258.5mmHg (0.1mmHg)	25.85mmHg (0.01mmHg)	$\pm 0.3\%FS$
ozin ²	32ozin ² (0.01ozin ²)	80ozin ² (0.01ozin ²)	8.00ozin ² (0.01ozin ²)	$\pm 0.3\%FS$
ftH ₂ O	4.616ftH ₂ O (0.001ftH ₂ O)	11.53ftH ₂ O (0.01ftH ₂ O)	1.154ftH ₂ O (0.001ftH ₂ O)	$\pm 0.3\%FS$
cmH ₂ O	140cmH ₂ O (0.1cmH ₂ O)	350.1cmH ₂ O (0.1cmH ₂ O)	2.59cmH ₂ O (0.01cmH ₂ O)	$\pm 0.3\%FS$
kgcm ²	0.140kgcm ² (0.001kgcm ²)	0.351kgcm ² (0.001kgcm ²)	0.035kgcm ² (0.001kgcm ²)	$\pm 0.3\%FS$
bar	0.137bar (0.001bar)	0.344bar (0.001bar)	0.034bar (0.001bar)	$\pm 0.3\%FS$
CE/Warranty	CE/ 3 years			
Dimensions	8.2x2.9x1.9" (210x75x50mm)			
Weight	9.8oz (280g)			

Specifications

Ordering

- HD700.....Differential Pressure Manometer (2psi)
- HD700-NIST...HD700 with NIST Certificate
- HD750.....Differential Pressure Manometer (5psi)
- HD750-NIST...HD750 with NIST Certificate
- HD755.....Differential Pressure Manometer (0.5psi)
- HD755-NIST...HD755 with NIST Certificate

407910 Heavy Duty Differential Pressure Manometer

Wide range dual input with multiple units and RS-232 interface

Features:

- Dual differential inputs with internal sensors
- Wide (± 802 inches of water) measurement range with high resolution to 0.5 inch
- Displays 8 types of pressure units
- Zero function for offset measurements
- Data Hold, Auto power off, and MAX/MIN
- Built-in RS-232 PC interface — optional 407001 Data Acquisition software or 380340 datalogger (see p. 108 for details)
- Includes 2 quick-disconnect fittings, 9V battery, protective holster with stand, and case

Function	Range	Resolution	Basic Accuracy
psi	± 29 psi	0.02psi	$\pm 1\% FS$
mbar	± 2000 mbar	1mbar	$\pm 2\% FS$
kg/cm ²	± 2.040 kg/cm ²	0.001kg/cm ²	$\pm 1\% FS$
mmHg	± 1500 mmHg	1mmHg	$\pm 1\% FS$
inHg	± 59.05 inHg	0.05inHg	$\pm 1\% FS$
mH ₂ O	± 20.40 mH ₂ O	0.01mH ₂ O	$\pm 1\% FS$
inH ₂ O	± 802.0 inH ₂ O	0.5inH ₂ O	$\pm 1\% FS$
Atmosphere	± 1.974 atm	0.001atm	$\pm 1\% FS$
CE/Warranty	CE approved; 3 years		
Dimensions/Weight	7x2.9x1.3" (178x74x33mm)/12oz (350g)		

Specifications



Ordering:

- 407910.....Heavy Duty Manometer
- 407910-NIST.....407910 with NIST Certificate
- 156119.....117VAC Adaptor
- 409997.....Soft Vinyl Pouch Carrying Case

BR200 Video Borescope/Wireless Inspection Camera **NEW**

3.5" Color TFT LCD Wireless Monitor with a microSD memory card for capturing images (JPEG) or video (AVI) for viewing on your PC

Features:

- Captured video with date/time stamp can be played back on the wireless monitor or on any monitor with a video input jack
- Video and images can also be transferred to your PC via the microSD card (with included SD adaptor) or USB cable (included) and viewed using Windows® Multimedia Player
- 39" (1m) waterproof (IP67) flexible gooseneck retains configured shape
- NTSC or PAL operation with menus in 10 languages: English, Chinese, German, French, Spanish, Portuguese, Italian, Japanese, Dutch, and Russian



Includes microSD memory card with SD adaptor, USB cable, magnetic base stand, video interconnect cable, extension tools (mirror, hook, magnet), AC adaptor (100-240V, 50/60Hz), 4 AA batteries, and hard case

Specifications	
Camera	
Pixels	712x486 (NTSC)/ 704x576 (PAL)
Transmission Frequency	2468MHz
Transmission Range	32ft (10m) unobstructed view
Viewing direction	Viewing Angle 50°
Viewing distance	5.9" to 9.8" (15 to 25cm)
Camera diameter	0.66" (17mm)
Working length	39" (1m)
Dimensions/Weight	7.3x5.7x1.6" (186x145x41mm)/18.7oz (530g)
Monitor	
LCD Screen Type	3.5" TFT
Pixels	320 x 240
Video Output Level	0.9 to 1.3V@75Ω
Video/Image Resolution	960 x 240 (AVI format)/640x 480 (JPEG format)
Operating/Charge Time	1.5 hours/3 hours
CE/FCC approvals	Yes
Warranty	1 year
Dimensions/Weight	3.9x2.7x1" (100x70x25mm)/4.9oz (140g)



Detachable wireless 3.5" color TFT LCD display can be viewed from a remote location up to 32ft (10m) from the measurement point.



Memory card included for capturing JPEG images and video (AVI) with date/time stamp.



Camera (17mm diameter) with 2 built-in bright LED lights illuminates dark areas.



Ideal Applications:
 - Water Restoration
 - HVAC and Refrigeration
 - Electrical inspection
 - Automotive
 - Pest control

Ordering

BR200.....Flexible Video Borescope

BR146 Flexible Borescope **NEW**

Fiberscope Inspection tool with built-in dual LED light source to illuminate viewed object; Made In USA

Features:

- High resolution image (7400 pixels) and optical system
- Easy to use eyepiece with focus adjustment
- 2 bright LED lamps illuminate viewed object
- Glare-free close-up and wide angle field of view
- 3 position switch (low-off-high)
- Flexible gooseneck with min. 3" (7.62cm) bend radius retains configured shape
- Removable 90° side viewing adaptor rotates 360°
- HDPE-coated shaft can be exposed to water, diesel, gasoline, brake fluid, antifreeze, oil and other liquids
- Clip-on magnet accessory will pick up approx. 0.25lbs (113g)

Specifications	
Function	
Viewing direction	0°; Viewing Angle 40°
Viewing distance	0.4" (10.2mm) to infinity
Side view adaptor	90°, Viewing Angle 45°
Shaft diameter	0.39" (10mm)
Working length	36" (914mm)
Weight	1.15lbs (0.52kg)
Case dimensions	17x13x4.5" (432x330x114mm)



Complete with 4 AA batteries, Clip-on 90° mirror, magnetic clip, and storage case

Ordering

BR146.....Flexible Borescope

412300A/412355A Current & Voltage Calibrators/Meters

Precision "source" for calibrating process devices and measuring DC process signals

Features:

- Upgraded models now feature super large LCD display and touch keypad
- LCD displays readings in mA or as a % of the 0 to 24mA range or as mV in voltage ranges
- Five stored calibration values for fast calibrations
- **412300A Current Calibrator** provides 0 to 24mA output displayed as mA or % and provides 24VDC power to measure a two-wire current loop
- Complete with 9V battery, calibration cable with spade lug terminals, carrying case, neckstrap and 100V-240V AC Universal Adaptor (50/60Hz)
- **412355A Current + Voltage Calibrator** provides adjustable 0 to 24mA and 0 to 20V calibration source



Functions		
Operating Modes		
Source	Output 0 to 24mA current for loads up to 1000 ohms	
	Output 0 to 20V (412355A only)	
Measure	0 to 50mA current signal	
	0 to 19.99V (412355A only)	
Power/Measure	Provides power (24VDC) to loop & measures current (412300A only)	
Input/Output	Ranges and Display	
	Resolution	
	-25.0 to 125.0% (representing 0 to 24mA)	0.1%
	0 to 19.99mA	0.01mA
	0 to 24.0mA	0.1mA
	0 to 1999mV	1mV
	0 to 20.00V	10mV
Accuracy	0.075% ±1 digit	
Power	9V battery or AC adaptor	
Dims/Wt	3.8x4.2x1.8" (96x108x45mm) folded/ 12oz (340g)	

Ordering

- 412300ACurrent Calibrator/Meter
 412300A-NIST412300A with NIST Certificate
 412355ACurrent & Voltage Calibrator/Meter
 412355A-NIST412355A with NIST Certificate

433201 Multi-Type Calibrator Thermometer

Source and measure 8 thermocouple type devices J, K, T, E, C, R, S, and N

Features:

- Upgraded model now features super large LCD display and touch keypad
- Five stored calibration values for fast calibrations
- Versatile thermometer measures over a wide temperature range
- Large LCD display built into adjustable cover
- Displays output in terms of mV or °F/°C temperature based on built-in thermocouple tables

Includes Type K Thermocouple Calibration Cable, Copper calibration cable, 9V NiCad rechargeable battery, neckstrap, AC adaptor/recharger, and case



Functions		
Type J	-58 to 1830°F (-50 to 1000°C)	0.15% rdg ±1°
Type K	-58 to 2498°F (-50 to 1370°C)	0.15% rdg ±1°
Type T	-184 to 752°F (-270 to 400°C)	0.15% rdg ±1°
Voltage	-5.00mV to +55.00mV	10µV ±2d
Resolution	0.1° (up to 999.9°) or 1° (over 999.9°)	
Warranty/CE	1 year warranty/ CE approved	
Dims/Wt	3.5x6.6x1" (88x168x26mm)/ 11.6oz (330g)	

Ordering

- 433201Calibrator Thermometer (w/115V AC adaptor)
 433201-NIST ...433201A with NIST Certificate
 433202-220Calibrator Thermometer (w/220V AC adaptor)
 433202-240Calibrator Thermometer (w/240V AC adaptor)
 Order thermocouple probes from pages 42 and 80.

412400 Multifunction Process Calibrator

Precision source and measure for thermocouples, mA, mV and V devices

Features:

- Source 0 to 24mA with 0.01mA resolution
- Measure 0 to 50mA (0.1mA resolution)
- Select Type K, J, or T thermocouple for precision calibrations in °F/°C or mV
- Output 0 to 1999mV or 0 to 10.00V
- Measure 0 to 19.99V
- Single/continuous step function for Voltage and Current
- Self-contained 24V loop power supply drives current loads up to 1000Ω
- Memory for 5 user settable output values of each type for fast calibrations



Functions	Range	Basic Accuracy (of reading)
DC Source		
Current	0 to 24mA, -25% to +125%	$\pm(0.075\% + 1 \text{ digit})$ or ± 3 digits, whichever is greater
Voltage	0 to 10V	$\pm(0.075\% + 1 \text{ digit})$ or ± 3 digits, whichever is greater
Type J	-58 to 1830°F (-50 to 1000°C)	$\pm(0.15\% + 1.8^\circ\text{F or } 1^\circ\text{C})$
Type K	-58 to 2498°F (-50 to 1370°C)	$\pm(0.15\% + 1.8^\circ\text{F or } 1^\circ\text{C})$
Type T	-184 to 752°F (-120 to 400°C)	$\pm(0.15\% + 1.8^\circ\text{F or } 1^\circ\text{C})$
Loop Power	24V	$\pm(10\mu\text{V} \pm 1 \text{ digit})$
Max. Load	1000Ω @ 24mA	
DC Measure		
Current	0 to 50mA, -25% to +230%	$\pm(0.075\% + 1 \text{ digit})$ or ± 3 digits, whichever is greater
Voltage	0 to 20V	$\pm(0.075\% + 1 \text{ digit})$ or ± 3 digits, whichever is greater
Type J	-58 to 1830°F (-50 to 1000°C)	$\pm(0.15\% + 1.8^\circ\text{F or } 1^\circ\text{C})$
Type K	-58 to 2498°F (-50 to 1370°C)	$\pm(0.15\% + 1.8^\circ\text{F or } 1^\circ\text{C})$
Type T	-184 to 752°F (-120 to 400°C)	$\pm(0.15\% + 1.8^\circ\text{F or } 1^\circ\text{C})$
Dimensions/Weight	3.8 x 4.7 x 2.0" (96 x 118 x 45mm)/12oz (340g)	

Specifications



Includes six AA batteries, test leads with detachable alligator clips, temperature calibration cable with spade lug connector, carrying case, neckstrap, and 100V-240V AC Universal adaptor (50/60Hz)

Conduct fast and accurate process controls calibration

Ordering

412400Multifunction Process Calibrator
412400-NIST412400 with NIST Certificate

412440-S Calibration Source Checker

Easy to use pocket checker for simulating Current Loops

Features:

- Pocket Checkers are easy to use and provide a quick and easy way for checking calibration of meters or controllers
- Instantly determine if your device needs calibration or if sensor needs to be replaced
- Sources three discrete current levels: 4mA, 12mA and 20mA
- Ideal for checking calibration and as a current source for setting up engineering units on a process indicator or controller
- Bright red LEDs indicate simulation output or battery status
- Accurate to 0.1mA
- Overload indication when load exceeds 240Ω
- Compact case features push button output selector switch
- Dimensions: 3.5x2.3x1" (89x58.4x25.4mm); Weight: 10oz (283.5g)



Ordering

412440-SCalibration Source Checker
412440-S-NIST ..412440-S with NIST Certificate

...trusted by the professionals.



Stopwatch/Timers

Extech's stopwatches accurately time single or repetitive events including sporting periods or laps, industrial processes, and task length.

Featuring Model HW30

▶ Stopwatch/Timer

Multi-function stopwatch includes UP/DOWN timer, laps, Temperature and Humidity

▶ Temperature & Humidity

Monitor your environment

▶ 30 Lap Memory

Track the consistency of an activity

▶ Heat Index

Measures how hot it feels when humidity is combined with the actual temperature



Patent Pending



Stopwatch display

HW30 Humidity/ Thermometer Stopwatch

Digital UP/DOWN timer displays Temperature, Humidity, and Heat Index

- User settable Heat Index alarm
- Stopwatch/chronograph mode with 1/100 second resolution
- Fastest/Slowest/Average Lap recall
- 99 lap counter with 30 lap/split memory
- 10 hour countdown timer with audible beeper warning for the last 5 seconds
- Programmable alarm
- Calendar mode displays day, month, and date
- 12 or 24 hour clock operation
- Complete with 39" (1m) lanyard and one 3V CR2032 battery



Only Extech offers a Stopwatch with Humidity, Temperature and Heat Index function.



HW30 HeatWatch is recommended by the National Health & Wellness Club

MEMBER TESTED and RECOMMENDED

Order Meter with NIST Certificate*

All Extech meters come factory calibrated. For an additional charge, Extech will supply your meter complete with a Certificate of Calibration Traceable to N.I.S.T. with Data at multiple points. **To order meter with NIST:**

365510-NIST
365515-NIST
365535-NIST

Limited NIST (-NISTL): Product certified to Stopwatch functions only.
HW30-NISTL

*Only products listed are available with NIST Certificate. Meter must be ordered with NIST Certificate at time of purchase.

Specifications

Model	HW30
Timing capacity	9hrs, 59mins, and 59secs
Accuracy	±5 seconds/day
Alarm	Yes
Countdown Timer	Yes
Lap Memory	30 laps
Heat Index	70 to 122°F (22 to 50°C)
Temperature	14 to 122°F (-10 to 50°C)
Humidity	1 to 99%
Dimensions	3.1x2.6x0.8" (79x66x21mm)
Weight	3oz (85g)
CE	Yes
Warranty	1 year



Stopwatch display



Stopwatch display



High resolution display

365510 Stopwatch/Clock

Digital Stopwatch plus Calendar and Alarm

- Stopwatch/Chronograph mode with 1/100sec resolution
- 12 or 24 hour clock operation
- Programmable alarm with an hourly chime
- Split time and two competitor timer
- Calendar displays day, month, and date
- Water resistant housing is complete with LR44 battery and 39" (1m) neckstrap

365515 Stopwatch/Clock with Backlit display

Large backlit display feature —perfect for viewing in dimly lit area

- 1/100th second resolution for 30mins
- 1 second resolution up to 24 hours
- 12 or 24 hour clock format
- Calendar displays day, month and date
- Programmable alarm and hourly chime setting
- Backlight turns off after 4 seconds
- Water resistant housing is complete with LR44 battery and 39" (1m) neckstrap

365535 Decimal Stopwatch/Clock

User-selectable resolution of 1/100 of a second, 1/1000 of a minute and 1/100,000 of an hour Large triple display with adjustable contrast

- 1/100th second precision for 19 hours
- 500 memory records of Split and Lap times
- Calendar displays day, month and date
- Time of day with daily alarm
- 12 or 24 hour clock format
- 3 Mode Countdown timer: count down stop, count down repeat, count down then count up
- Stroke measurement
- Pacer from 5 to 240 beeps per minute
- Water resistant housing
- Complete with CR2032 lithium battery and 39" (1m) neckstrap

365510

23hrs, 59mins and 59.99secs
±3 seconds/day
Yes
—
—
—
—
2.3x2.8x0.5" (57x70x15mm)
2oz (50g)
Yes
1 year

365515

23hrs, 59mins and 59.99secs
±3 seconds/day
Yes
—
—
—
—
2.3x2.8x0.5" (57x70x15mm)
2oz (50g)
Yes
1 year

365535

19hrs, 59mins and 59.99secs
±5 seconds/day
Yes
3 Modes
500 laps
—
—
—
2.5x3.2x0.8" (64x81x20mm)
2.7oz (77g)
Yes
1 year

RF Series Portable Brix Refractometers **NEW**

Measure the concentration of Sugar, Salt or industrial cutting/cooling lubricants

Features:

- Easy to operate refractometers provide accurate and repeatable measurements on easy to read scales
- Automatic Temperature Compensation (RF11, RF12, RF15 and RF20 models)
- Requires only 2 or 3 drops of solution
- The prism and lens with a simple focus adjustment provide repeatable results
- One year warranty
- Complete with case, calibration screwdriver, and calibration solution

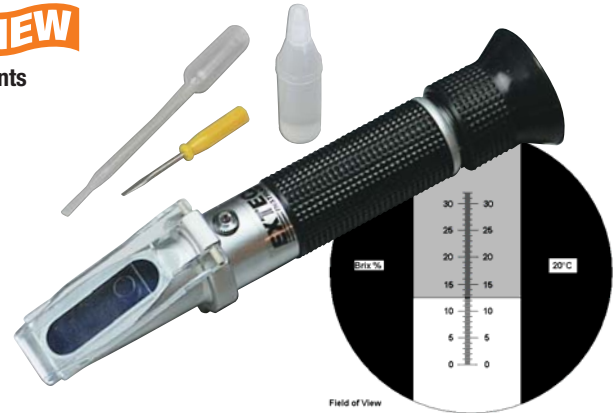

Scale view through eyepiece

Specifications	Model	Type	Ranges	Resolution	Accuracy
	RF10	Sucrose	0 to 32% Brix	0.2	±0.2%
	RF15	Sucrose (ATC)	0 to 32% Brix (10 to 30°C)	0.2	±0.2%
	RF18	Brix (Lubricants)	0 to 18% Brix	0.1%	±0.2%
	RF20	Salt (ATC)	0 to 100ppt (10 to 30°C)	1ppt	±0.1%
			1.000 to 1.070 Specific Gravity	0.001	±0.001
	RF16	Sucrose	0 to 10% Brix	0.1	±0.1%
	RF11	Sucrose (ATC)	0 to 10% (10 to 30°C)	0.1	±0.1%
	RF12	Lubricants/Cutting fluids (ATC)	0 to 18% Brix (10 to 30°C)	0.2	±0.2%
	RF30	Triple Range General Service	0 to 41% Brix 42 to 71% Brix 72 to 90% Brix	0.2 0.2 0.2	±0.2% ±0.2% ±0.2%

Ordering

- RF10.....0 to 32% Brix Refractometer
- RF11.....0 to 10% Brix Refractometer with ATC
- RF12.....0 to 18% Brix Refractometer with ATC
- RF15.....0 to 32% Brix Refractometer with ATC
- RF16.....0 to 10% Brix Refractometer
- RF18.....0 to 18% Brix Refractometer
- RF20.....Salinity Refractometer with ATC
- RF30.....Triple Range General Service (0 to 90% Brix) Refractometer

Sucrose (RF10, RF11, RF15, RF16, and RF18)

- RF10 Dims/Wt: 6.6x1.3x1.3" (168x32x32mm)/ 3.2oz (91g)
- RF15 Dims/Wt: 6.3x1.4x1.4" (159x35x35mm)/ 7oz (200g)
- RF11/RF16 Dims/Wt: 7.5x1.6x1.2" (190x40x30mm)/ 6.5oz (185g)

- Sucrose brix refractometers measure the concentration of sugar in fruit juice and industrial fluids

Brix (RF12 and RF18)

- RF18 Dims/Wt: 6.7x1.6x1.2" (170x41x31mm)/ 3.2oz (91g)
- Maintain proper lubricant cooling concentration to extend equipment life and prevent corrosion

Salinity (RF20)

- Salinity refractometer measures the concentration of dissolved salt in water
- Dims/Wt: 7.6x1.5x1.5" (194x38x38mm)/ 8oz (227g)

General Purpose Brix (RF30)

- Dims/Wt: 7.9x1.5x1.1" (200x38x28mm)/ 21.86oz (620g)

RF40/RF41 Battery Coolant/ Glycol Refractometer

Measure the % of Ethylene Glycol and Propylene Glycol

Features:

- Measures the freezing point of automotive coolants plus battery charge condition
- Provide accurate and repeatable measurements of % Ethylene Glycol and Propylene Glycol and °F on easy to read scale
- Automatic Temperature Compensation
- Requires only 2 or 3 drops of solution
- Complete with case, calibration screwdriver, and calibration solution

Specifications	Function	Ranges	Resolution	Basic Accuracy
	Propylene Glycol freeze point	RF40: -60°F (63%) to 32°F (12%)	2°F (1%)	±5°F (2%)
		RF41: -50°C to 0°C	1°C	
	Ethylene Glycol freeze point	RF40: -60°F (59%) to 25°F (16%)	2°F (1%)	±5°F (2%)
		RF41: -50°C to 0°C	1°C	
	Specific Gravity of Battery Acid	1.15 to 1.30	0.01	
Warranty	1 year			
Dimensions/ Weight	6.5x1.5x1.5" (165x38x38mm)/ 7oz (200g)			

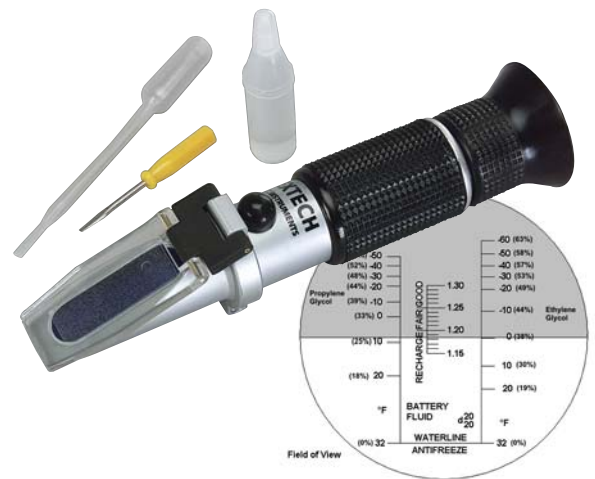

Scale view through eyepiece

Ordering

- RF40.....Battery Coolant/Glycol Refractometer w/ATC (°F)
- RF41.....Battery Coolant/Glycol Refractometer w/ATC (°C)

MC108 Digital Mini Microscope **NEW**

Compact device with TFT color display enlarges, measures and captures images up to 108x

Features:

- Capture and measure images of objects as small as 0.01mm with built in scale
- 1.8" (46mm) TFT color LCD plus 2MB memory displays up to 60 JPEG images
- 7x to 108x magnification range
- Four white LEDs with adjustable brightness for object illumination
- 5 Image Effect and Dual Window View
- Real-time imaging on your PC screen via USB interface and included software
- Dims: 4.7 x 2.2 x 1" (120 x 56 x 25mm); Wt: 2.5oz (70g) without batteries
- Complete with stand, three AAA Ni-MH rechargeable batteries, 100 to 240VAC (50/60Hz) adaptor/charger, Windows® compatible software with mini USB cable, cleaning cloth, and wrist strap



PC board inspection



Dual window view simultaneously displays magnified image next to the original image

Ordering (See p. 21 for specifications)

MC108.....Mini Microscope

PH150-C Concrete pH Kit **NEW**

Flat surface electrode provides fast & easy on-the-spot pH measurements on concrete

Features:

- 3ft (1m) extension cable with probe guard/weight attaches to the Concrete pH Meter for taking measurements on flat concrete surfaces
- Rust-free metal weight probe guard helps keep electrode in contact with the wet concrete surface and protects the electrode
- RENEW indicator tells you when it's time to replace your electrode
- CAL alert tells you it's time to recalibrate
- Memory records and recalls 25 readings
- 1, 2 or 3 point calibration
- Data Hold, Auto power off, and Low battery indication
- Waterproof/dustproof design (IP57)
- Complete with flat surface concrete pH electrode, protective sensor cap, sample cup with cap, plastic stand, 1m extension cable with weighted probe guard, plastic bottle, four 3V CR2032 button batteries, 48" (1.2m) neckstrap, and carrying case



Measure pH level of concrete using a pH meter with a flat surface pH electrode plus a metal weight probe guard for stability and protection

Ordering

PH150-CConcrete pH Kit
PH155.....Spare ExStik® Concrete pH Electrode Module

PH50/PH60 pH Pens

Easy-to-use, low cost waterproof pH pens

Features:

- Waterproof housing
- Easy to calibrate single CAL key with automatic pH buffer recognition (4, 7, and 10pH calibration buffers sold separately)
- Data hold with Low battery indicator
- Auto power off with disable feature
- Complete with built in electrode, sensor cap, inner pH electrode protection cap, and four LR44 button batteries

Specifications	Function	Model PH50	Model PH60
	pH	2.0 to 12.0pH	0.0 to 14.0pH
	Temperature	—	32 to 122°F (0 to 50°C)
	Resolution	0.1pH, 0.1°	0.1pH, 0.1°
	Accuracy	±0.3pH	±0.2pH; ±1°F/±0.5°C
	CE/Warranty	CE approved / 1 year	
	Dimensions	6x1.5x0.9" (152x37x24mm)	
	Weight	2.3oz (65g)	



Model PH50 Measures pH

Model PH60 Measures pH and Temperature Automatic Temperature Compensation

Ordering:

PH50.....Waterproof pH Pen
PH60.....Waterproof pH Meter with Temperature
PH103.....Tripak buffers (6ea - 4,7,10pH+2 Rinse solutions)



ExStik® Series (Patent Pending)
Provide great versatility in measuring pH, ORP, Conductivity, Dissolved Oxygen, TDS, Salinity, and Temperature for field or laboratory use.

Featuring Model PH100

▶ Flat Surface Electrode

For any application that requires direct contact such as food, paper, cement and wet surfaces

▶ Built-in Memory

Record/Recall up to 15 labeled readings

▶ Built-in Smart Chip

Tells you when to replace your electrode or when to recalibrate your meter



Accessories (See p. 138 for pH Buffers)

Conductivity Standards (Pint size)

- EC-84-P84µS Conductivity Standard (2 bottles/1 pint ea)
- EC-1413-P.....1413µS Conductivity Standard (2 bottles/1 pint ea)
- EC-12880-P 12880µS Conductivity Standard (2 bottles/1 pint ea)

Replacement Electrodes

- PH105pH ExStik® Electrode Module
- RE305ORP ExStik® Electrode Module
- EC405*ExStik® II Conductivity Cell Module for EC400
- EC505*ExStik® II pH/Conductivity Cell Module for EC500
- DO605*ExStik® II Dissolved Oxygen Module for DO600
- DO603.....Membrane Kit for DO600/DO605
- FL705*ExStik® II Fluoride Module for FL700
- FL704.....TISAB reagent tablets for FL700 (100 tablets)

Extension Cables for DO600

- EX0103ft (1m) Extension Cable with Probe Guard/Weight
- EX05016ft (5m) Extension Cable with Probe Guard/Weight

Carrying Case

- CA895Small vinyl carrying case with belt loop
- CA904Large hard case for meter and accessories

*ExStik® II electrode modules are not interchangeable with ExStik® pH/ORP/Chlorine meters



Flat Surface pH Electrode

PH100 ExStik® pH Meters

Flat Surface electrode provides on-the-spot pH measurements

- **RENEW feature** tells you when it's time to replace your pH electrode
- **CAL feature** tells you when it's time to recalibrate your meter
- **Waterproof** to IP57
- **Flat Surface pH electrode** rugged design measures pH on solid and semi-solid surfaces
- **Analog bargraph** originates at neutral point (pH 7.00) to view trends in acidity or alkalinity
- ATC plus measures Temperature
- 1, 2 or 3 point calibration (order pH buffers separately on p. 138)
- Includes flat surface pH electrode, sensor cap, sample cup with cap, four 3V CR2032 button batteries and 48" (1.2m) neckstrap



Flat Surface ORP Electrode

RE300 ExStik® ORP Meter

High resolution of 1mV

- Measures ORP/Redox from -999 to 999mV
- Automatic electronic self calibration
- Simulated analog bargraph displays change in ORP reading
- **Waterproof** to IP57 protects meter from wet environment
- Complete with flat surface ORP electrode, protective sensor cap, sample cup with cap, four 3V CR2032 button batteries and 48" (1.2m) neckstrap

Specifications

	PH100	RE300
Model	PH100	RE300
pH	0.00 to 14.00pH	—
ORP (mV)	—	-999 to 999mV
Conductivity	—	—
TDS/Salinity	—	—
DO saturation/concentration	—	—
Temperature	23° to 194°F (-5 to 90°C)	—
Max. Resolution	0.01pH, 0.1°	1mV
Basic Accuracy	±0.01pH, ±1.8°F/1°C	±4mV
Dimensions	1.4x6.8x1.6" (35.6x172.7x40.6mm)	1.4x6.8x1.6" (35.6x172.7x40.6mm)
Weight	3.8oz (110g)	3.8oz (110g)
CE	Yes	Yes
Warranty	1yr (meter)/6mo conditional warranty (electrode)	1yr (meter)/6mo conditional warranty (electrode)



EC500 with combination flat surface pH electrode and Conductivity cell

EC400/EC500 Conductivity Meters

Autorangeing, high accuracy combination electrode measures multi parameters

- Analog bargraph indicates trends
- Memory stores 25 labeled data
- Adjustable Conductivity to TDS ratio from 0.4 to 1.0
- 0.5 fixed Salinity ratio
- EC500 - RENEW feature tells user to replace electrode
- Data Hold, Auto power off, Low battery indicator
- **Waterproof** to IP57
- EC400 with Conductivity/TDS cell; EC500 with combination pH/Conductivity/TDS cell
- Includes electrode, sensor cap, sample cup with cap, four 3V CR2032 batteries, and 48" (1.2m) neckstrap. *Order Conductivity standards separately on p.130.*



DO sensor with easy screw-on membrane cap assembly

DO600 Dissolved Oxygen Meter

Easy to replace screw-on membrane cap with optional extension cables

- Oxygen level displayed as % Saturation or Concentration (mg/L [ppm])
- Adjustable Altitude Compensation (0 to 20,000ft in 1,000ft increments)
- Adjustable Salinity Compensation from 0 to 50ppt
- Analog bargraph indicates trends
- Memory stores 25 labeled data
- Self calibration on power up
- **Waterproof** to IP57
- **DO600 meter** includes DO electrode, sensor cap, spare membrane cap, electrolyte, four 3V CR2032 batteries, and 48" (1.2m) neckstrap
- **DO600-K Kit** includes DO600 meter, DO603 membrane kit, 16ft (5m) extension cable, weighted probe guard, and case



Flat Surface Fluoride electrode with built-in ATC

FL700 Fluoride Meter

Direct reading of Fluoride down to 0.1ppm with ATC

- First Fluoride meter with built-in Automatic Temperature Compensation
 - Fastest response Fluoride meter (<1min)
 - Small sample/TISAB volume required for testing (10mL)
 - In compliance with EPA Method 340.2. (Potentiometric Ion Selective Electrode)
 - Automatic electronic 1 or 2 point calibration with offset adjustment
 - Memory stores 25 labeled data
 - **Waterproof** to IP57
 - Includes electrode, TISAB reagent tablets, sensor cap, four 3V button batteries, and 48" (1.2m) neckstrap
- Contact Extech or your local lab supply for Fluoride calibration standards*



Did You Know?

pH Meters require pH buffers for calibration before taking accurate pH measurements. For low pH range, calibrate with 4 and 7pH buffers. For high pH range, calibrate with 7 and 10 pH buffers. Order pH Buffers on p. 138 to work with your new ExStik pH meter.

Conductivity Meters require calibration before taking accurate measurements. Extech offers three types of standards for calibration: 84µS for Low range, 1413µS for mid-range, and 12880µS for high range. Order these calibration standards listed on p. 130 with your meter.

EC400	EC500	DO600	DO600-K	FL700	
—	0.00 to 14.00pH	—	—	—	Model
0 to 199.9µS, 200 to 1999µS, 2.00 to 19.99mS	—	—	—	—	pH
0 to 99.9ppm (mg/L), 100 to 999ppm (mg/L), 1.00 to 9.99ppt (g/L)	—	—	—	0.1 to 10ppm	ORP
—	—	0 to 200.0% / 0 to 20.00ppm (mg/L)	—	—	Conductivity
32° to 149°F (0 to 65°C)	23° to 194°F (-5 to 90°C)	32° to 122°F (0 to 50°C)	—	32° to 140°F (0 to 60°C)	TDS/Salinity
0.1µS, 0.1ppm (mg/L), 0.01pH, 0.1°F/°C	±2%FS, ±0.01pH, ±1.8°F/1°C	0.1%, 0.01ppm (mg/L), 0.1°F/°C	—	0.1ppm, 0.1°	DO saturation/concentration
1.4x6.8x1.6" (35.6x172.7x40.6mm)	3.8oz (110g)	±2.0% FS, 0.4ppm (mg/L), ±1.8°F/1°C	1.4x6.8x1.6" (35.6x172.7x40.6mm)	±3.0% of reading	Temperature
—	Yes	3.8oz (110g) Meter only	—	1.4x6.8x1.6" (35.6x172.7x40.6mm)	Max. Resolution
—	—	Yes	—	3.8oz (110g)	Basic Accuracy
1yr (meter)/6mo conditional warranty (electrode)	—	1yr (meter)/6mo conditional warranty (electrode)	—	Yes	Dimensions
—	—	—	—	1yr (meter)/6mo conditional warranty (electrode)	Weight
—	—	—	—	—	CE
—	—	—	—	—	Warranty

CL200 ExStik® Waterproof Chlorine Meter

Direct reading of Total chlorine down to 0.01ppm and is unaffected by color or Turbidity of the sample

Features:

- Direct reading of Total Chlorine provides fast and easy measurements
- Low detection limit down to 0.01ppm
- Wide dynamic range to 10ppm
- Unaffected by sample color or turbidity
- Automatic electronic calibration
- Memory stores 15 labeled readings
- Unique flat surface chlorine electrode eliminates any concerns for clogged junctions or glass breakage
- Waterproof to IP57
- Large LCD simultaneously displays ppm of Total Chlorine, Temperature and analog bargraph indicator
- Optional Special Value Kits for complete water quality analysis including pH/ORP. (See page 133)
- Complete with meter and flat surface Chlorine electrode, ExTab™ reagent tablets (50 tests), protective sensor cap, sample cup with cap, four 3V button batteries, and 48" (1.2m) neckstrap



Patent Pending

EPA Approved Methodology

- Designed as a simple method to test for Total Chlorine following "Standard Methods for Examination of Water and Waste Water" (4500-Cl I)
- Approved by the U.S. EPA as an acceptable alternative method for 40 CFR Part 136 wastewater compliance monitoring



CL207 Chlorine standards (1ppm)

Specifications	Function
	ppm 0.01 to 10.00ppm
	Temperature 23° to 194°F (-5 to 90°C)
	Resolution 0.01ppm; 0.1°F/°C;
	Basic accuracy ±10% of reading ±0.01ppm; ±1.8°F/±1°C
	Power Four 3V CR2032 button batteries
	Dimensions 1.4x6.8x1.6" (35.6x172.7x40.6mm)
	Weight 3.85oz (110g)

Ordering

CL200ExStik® Chlorine Meter
 CA895Small vinyl carrying case with belt loop
 CL207Chlorine Standard (1ppm) - 3 ampules (20mL ea.)
 (See accessories below or Special Value Kits on p. 133)

EX006 Weighted Base & Solution Cups

Features:

- Complete with weighted base and 5 solution cups with caps to hold meter and solution when taking a measurement to obtain a stable reading



Recommended for ExStik® Chlorine

CL203/CL204 ExTab™ Chlorine Reagent tablets

Features:

- 1 tablet per test
- Foil packaging provides very stable environment with long shelf life
- No dosing equipment required
- No messy powder reagents
- Available in 10pk (100 tests) or Value pack 100pk (1000 tests)



Patent Pending

CL205 Replacement Flat Surface Chlorine Electrode Module

Features:

- Easy to clean flat surface electrode
- Measures Chlorine and Temperature
- Interchangeable with ExStik® pH or ORP Meter
- Complete with protective connector cap. Six month conditional warranty



CL207 Chlorine Standard

Features:

- 1ppm standard for chlorine meter calibration
- Complete with 3 ampules (20mL each) 1ppm calibration standards



Ordering

EX006Weighted base with 5 solution cups
 EX007Spare sample solution cups (24pk)
 CL203ExTab™ Reagent tablets (10pk - 100 tests)
 CL204ExTab™ Reagent tablets (100pk - 1000 tests)
 CL205Spare Chlorine electrode
 CL207Chlorine Standard (1ppm) - 3 ampules (20mL ea.)

EX900 ExStik® 4-in-1 Kit

Complete kit allows you to measure Chlorine, pH, ORP, and Temperature with all the necessary accessories

Kit Includes:

- CL200 Chlorine ExStik® meter, flat surface pH electrode, flat surface ORP electrode, ExTab™ reagent tablets (50 tests), pH 4, 7 buffer solutions (20mL) and rinse solution, weighted base with 6 sample plastic cups with caps, four 3V CR2032 button batteries, 48" (1.2m) neckstrap, and case
- Also available EX800 Kit includes all of the above except for ORP electrode. EX800-R includes refillable pH electrode.



See p. 130 and 132 for more details on the ExStik Meters

Function	Range	Max. Resolution	Basic Accuracy
ppm	0.01 to 10.00ppm		
pH	0.00 to 14.00pH		
ORP	-999 to 999mV		
Temperature	23° to 194°F (-5 to 90°C)		
Resolution	0.01ppm; 0.01pH; 0.1mV; 0.1°		
Accuracy	±10% of reading ±0.01ppm; 0.01pH; ±4mV; ±1.8°F/±1°C		
Power	Four 3V CR2032 button batteries		
Dims/ Wt	9.5x6.8x2.8" (241x173x71mm)/1.68lbs (0.76kg)		

Ordering

EX900ExStik® 4-in-1 Kit Chlorine, pH, ORP, Temperature
EX800ExStik® 3-in-1 Kit Chlorine, pH, Temperature
EX800-R .ExStik® 3-in-1 Kit Chlorine, Ref. pH, Temperature

EC410 ExStik® II* Conductivity Kit

Highly accurate multi-ranging sensor that measures Conductivity, TDS, Salinity, and Temperature

Kit Includes:

- EC400 ExStik® II Conductivity/TDS/Salinity/ Temperature meter with sensor, protective cap, 84µS, 1413µS and 12880µS standards (30mL bottle each), weighted base, 3 sample plastic cups with caps, four 3V CR2032 button batteries, 48" (1.2m) neckstrap, and carrying case



See p. 131 for more details on the EC400 meter

Function	Range	Max. Resolution	Basic Accuracy
Conductivity	0 to 199.9µS	0.1µS	±2% FS
	200 to 1999µS	1µS	
	2.00 to 19.99mS	0.01mS	
TDS/Salinity	0 to 99.9ppm (mg/L)	0.1ppm (mg/L)	±2% FS
	100 to 999ppm (mg/L)	1ppm (mg/L)	
	1.00 to 9.99ppt (g/L)	0.01ppt (g/L)	
Temperature	32° to 149°F (0 to 65°C)	0.1°	±1.8°F/1°C
Power	Four 3V CR2032 button batteries		
Dims/ Wt	9.5x6.8x2.8" (241x173x71mm)/1.56lbs (0.71kg)		

*ExStik® II Series electrodes are not interchangeable with ExStik® pH/Chlorine/ORP meters

Ordering

EC410ExStik® Conductivity Kit

EC510 ExStik® II pH/Conductivity Kit

Measures pH, Conductivity, TDS, Salinity, and Temperature using a combination electrode

Kit Includes:

- EC500, 84µS, 1413µS, 12880µS calibration standards, pH buffer pouches (1 each of 4, 7, 10pH plus rinse solution), weighted base, 3 sample cups with caps, four 3V CR2032 batteries, neckstrap, and case



See p. 131 for more details on the EC500 meter

Function	Range	Max. Resolution	Basic Accuracy
pH	0.00 to 14.00pH	0.01pH	±0.01pH
Conductivity	0 to 199.9µS	0.1µS	±2% FS
	200 to 1999µS	1µS	
	2.00 to 19.99mS	0.01mS	
TDS/Salinity	0 to 99.9ppm (mg/L)	0.1ppm (mg/L)	±2% FS
	100 to 999ppm (mg/L)	1ppm (mg/L)	
	1.00 to 9.99ppt (g/L)	0.01ppt (g/L)	
Temperature	32° to 149°F (0 to 65°C)	0.1°	±1.8°F/1°C
Power	Four 3V CR2032 button batteries		
Dims/ Wt	9.5x6.8x2.8" (241x173x71mm)/1.56lbs (0.71kg)		

Ordering

EC510.....ExStik® pH/Conductivity Kit

DO610 ExStik® II* DO/pH/EC Kit

Measures Dissolved Oxygen, pH, Conductivity, TDS, Salinity, and Temperature

Kit Includes:

- EC500 pH/Conductivity ExStik® II meter with combination high accuracy multi-ranging Conductivity sensor for Conductivity, TDS, Salinity, pH and Temperature measurements
- DO600 Dissolved Oxygen ExStik® II meter with electrode, replacement membrane cap, electrolyte, and polishing paper



Accessories included:

- Sample pH Buffers — Single use pouches for pH4, pH7, pH10, and rinse solution
- Weighted base with 2 cups and caps, four 3V CR2032 batteries and neckstrap with each meter, and case

See p. 131 for more details on the EC500 and DO600 meters

Ordering

DO610.....ExStik® II DO/pH/Conductivity Kit



pH/mV/Temperature Meters

Extech's pH meters perform with laboratory accuracy and withstand the rigors of field testing. ATC and automatic buffer recognition provide simplicity and repeatable measurements.

Featuring Model PH300

▶ Durable Waterproof Housing

Protects against splashes and accidental drops

▶ Large Backlit LCD Display

Simultaneously displays pH (or mV) and Temperature

▶ Push Button Calibration

Automatic calibration buffer recognition

▶ Compete Kit

Read to use kit packaged in a hard carrying case includes pH electrode and calibration buffers



Read to use complete kit includes all the necessary accessories stored in a hard carrying case for easy transportation. Ideal for field use.

Accessories

pH Electrodes

- PH105Spare pH ExStik® Electrode Module
- PH115Spare Refillable pH ExStik® Electrode Module
- PH113Reference Refill Solution Kit for PH110
- PH305Spare pH Electrode for PH300, EC600, DO700
- 6015WC.....Waterproof pH Electrode with cable for Palm pH
- 6012WSWaterproof Stick Type pH Electrode for Palm pH
- 6750WC.....Waterproof ORP Electrode with cable for Palm pH
- 6750WSWaterproof Stick Type ORP Electrode for Palm pH

pH Buffers

- PH4-PpH 4 Buffer Solution (2 bottles - 1 pint each)
- PH7-PpH 7 Buffer Solution (2 bottles - 1 pint each)
- PH10-PpH 10 Buffer Solution (2 bottles - 1 pint each)
- PH103Tripak Buffer pouches (see photo above)

Temperature Probes

- 850185RTD Stainless Steel Temp. Probe for the Oyster™
- 850188Temperature probe, stainless steel for 407228

AC Adaptors and cases

- UA100-240..100-240V AC Adaptor for the Oyster pH Meter
- CA895Vinyl Pouch Carrying Case for PH100

See pages 138 for replacement electrodes and other pH accessories



Unique gel filled or refillable (pictured) flat surface electrode design

Patent Pending

PH100/PH110 Waterproof ExStik® pH Meters

Choice of rugged gel filled or refillable Flat surface pH electrode

- "RENEW" feature alerts user when electrode needs replacement
- "CAL" indicator alerts user to recalibrate
- Analog bargraph originates at neutral point (pH 7.00) to conveniently view trends in acidity or alkalinity
- 1, 2 or 3 point buffer calibration; ATC
- Stores/recalls up to 15 labeled readings
- **Waterproof** (IP57) and floats in water
- Complete with protective sensor cap, sample cup with cap, four 3V button batteries, and 48" (1.2m) neckstrap
- **Select PH100** for meter with gel filled pH flat surface electrode
- **Select PH110** for meter with refillable flat surface pH electrode; Order PH113 KCl reference kit separately (see p.134)

Note: Requires pH buffers (not included).

Specifications

Model	PH100	PH110
Type	Gel Filled pH Electrode	Refillable pH Electrode
Waterproof	Yes	
pH	0.00 to 14.00pH	
mV	—	
Temperature	23° to 194°F (-5 to 90°C)	
Max Resolution	0.01pH, 0.1°	
Basic Accuracy	±0.01pH, ±1.8°F/1°C	
PC interface	—	
Memory	15 readings	
Dimensions/ Weight	1.4x6.8x1.6" (35.6x172.7x40.6mm)/ 3.8oz (110g)	
CE	Yes	
Warranty	1 year (meter)/6 months conditional warranty (electrode)	



PH220-C includes pH electrode with 39" (1m) cable.

PH220 Waterproof Palm pH/ORP Meter

Big Digit LCD display in rugged housing with choice of stick or cabled pH Electrode

- Large LCD displays pH or mV and Temperature simultaneously
- Automatic Buffer recognition
- Automatic Temperature Compensation via Pt-100 sensor built into electrode
- Low Battery indicator and Auto Power off
- Rugged design for handheld or wall mount (magnetic back)
- Complete with waterproof meter, pH electrode, protective holster, pH 4 & 7 buffers (1 pouch ea.), and 9V battery
- **Select PH220-C Kit** to include ATC pH polycarbonate electrode (12mm diameter) with 39" (1m) cable
- **Select PH220-S Kit** to include ATC pH stick type polycarbonate electrode (12mm diameter) for direct connection to meter



PH300 Waterproof pH/Temperature Kit

Measures pH, mV, and Temperature

- Waterproof housing (meets IP57)
- Automatic calibration (4, 7, and 10pH)
- Choice of 3 point calibration for better accuracy
- Automatic Temperature Compensation
- Memory stores up to 200 labeled readings
- Large blue backlit dual LCD displays both pH and Temperature readings
- Auto power off with disable function
- Complete with pH/mV/Temperature electrode, pH calibration solutions (4, 7, and 10pH), 2 AA batteries, and hard carrying case



Oyster™ Series pH/ORP/Temp Kits

Exclusive Oyster™ Design can be used in the lab or in the field

- Large LCD built into adjustable "flip-up" cover displays pH or mV and Temperature simultaneously
- Neckstrap for "hands-free" operation
- Stores/recalls 25 labeled readings
- Min/Max mode; Auto or Manual Temperature compensation (ATC/MTC)
- Self diagnostics display codes
- Low Battery indicator & Auto Power off
- 5 point buffer recognition (1.68, 4.00, 7.00, 10.00, 12.45) with adjustable buffer values
- **OYSTER-15 Kit** includes Oyster-10 meter, neckstrap, 9V battery, 60120B mini pH electrode, sample buffers (4 and 7pH), and carrying case
- **OYSTER-16 Kit** is same as Oyster-15 plus RTD Temperature probe. Optional AC Adaptor (see p. 134)

PH220-C	PH220-S	PH300	OYSTER-15	OYSTER-16
Cabled pH Electrode	Stick pH Electrode	Cabled pH Electrode	Meter+pH electrode +case	Meter+pH electrode+ case+Temp probe
Yes	Yes	Yes	—	—
0.00 to 14.00pH	0.00 to 14.00pH	-2.0 to 19pH	0.00 to 14.00pH	0.00 to 14.00pH
-999 to 999mV	-999 to 999mV	-1999mV to 1999mV	-999 to 999mV	-999 to 999mV
32° to 212°F (0 to 99.9°C)	32° to 212°F (0 to 99.9°C)	32 to 212°F (0 to 100°C)	32° to 212°F (0 to 99.9°C)	32° to 212°F (0 to 99.9°C)
0.01pH, 1mV, 0.1°	0.01pH, 1mV, 0.1°	0.01pH, 1mV, 0.1°	0.01pH, 1mV, 0.1°	0.01pH, 1mV, 0.1°
±0.01pH, ±2mV, ±0.8°F/0.5°C	±0.01pH, ±2mV, ±0.8°F/0.5°C	±0.02pH, ±0.15mV, ±1°F/0.5°C	±0.02pH, ±2mV, ±0.8°F/0.5°C	±0.02pH, ±2mV, ±0.8°F/0.5°C
—	—	—	—	—
4.4x3.1x1.5" (111x79x39mm)/ 9.2 oz (260g)	4.4x3.1x1.5" (111x79x39mm)/ 9.2 oz (260g)	200 readings 4.7x2.6x1.2" (120x65x31mm)/6.3oz (180g)	25 readings 3.7x4.2x2" (94x107x51mm)/ 12oz (340g)	25 readings 3.7x4.2x2" (94x107x51mm)/ 12oz (340g)
Yes	Yes	Yes	Yes	Yes
1 year (meter)/6 months conditional warranty (electrode)	1 year (meter)/6 months conditional warranty (electrode)	1 year (meter)/6 months conditional warranty (electrode)	1 year (meter)/6 months conditional warranty (electrode)	1 year (meter)/6 months conditional warranty (electrode)



Conductivity/TDS/pH Meters

Extech's conductivity meters are used to monitor and maintain the quality of industrial and commercial process waters, conditioning fluids and additives.

Featuring Model EC600

▶ 7-in-1 Meter

Measures Conductivity, TDS, Salinity, Resistivity, pH, mV, and Temperature

▶ One point Conductivity Calibration

Automatically recognizes 8 calibration solutions from USA, Europe and China series

▶ Memory

Stores up to 300 numbered readings with easy recall

▶ Autoranging

Five Conductivity measurement ranges



Read to use complete kit includes all the necessary accessories stored in a hard carrying case for easy transportation. Ideal for field use.



EC400 ExStik® II Conductivity/TDS/Salinity/Temp Meter

High accuracy multi-range sensor measures all four parameters

- 8 units of measure include: μS , mS , ppm , ppt , mg/L , g/L , $^{\circ}\text{C}$, $^{\circ}\text{F}$
- Simultaneous display of Conductivity or TDS plus Temperature and bargraph
- Memory stores up to 25 labeled readings
- Adjustable Conductivity to TDS ratio factor from 0.4 to 1.0
- Self calibration on power up
- **Waterproof** to IP57
- **EC400 meter** includes Conductivity cell*, protective sensor cap, sample cup with cap, four 3V CR2032 button batteries, and 48" (1.2m) neckstrap; *Calibration standards sold separately*
- **EC410 kit** (p.133) includes EC400, 84 μS , 1413 μS , 12880 μS calibration standards, weighted base, 3 sample cups with caps, and case

Accessories

Conductivity Standards

EC-84-P.....84 μS Conductivity Standard (2 bottles - 1 pint each)
EC-1413-P...1413 μS Conductivity Standard (2 bottles - 1 pint each)
EC-12880-P.12880 μS Conductivity Standard (2 bottles - 1 pint each)

Replacement Conductivity Cells

EC405*Spare ExStik® II Conductivity Cell Module for EC400
EC505*Spare ExStik® II pH/Conductivity Cell Module for EC500
EC605Spare Conductivity Cell for EC600 and DO700
804010A.....Polymer Conductivity Cell for 341350A-P

Replacement pH Electrode

PH305Spare pH Electrode for PH300, EC600, DO700
60120BSpare Mini pH Electrode for 341350A-P

Carrying Case and Temperature Probe

CA895.....Small vinyl case with belt loop for EC400, EC500
850190.....Thermistor Probe (32 to 194 $^{\circ}\text{F}$ /0 to 90 $^{\circ}\text{C}$) for 341350A-P

*ExStik® II Conductivity cell is not interchangeable with ExStik® pH, ORP, & Chlorine models

Specifications

Model	EC400	EC410 kit
Conductivity	0 to 199.9 μS , 200 to 1999 μS , 2,000 to 19.99mS	
TDS/Salinity	0 to 99.9ppm (mg/L), 100 to 999ppm (mg/L), 1.00 to 9.99ppt (g/L)	
pH	—	
mV	—	
Temperature	32 $^{\circ}$ to 149 $^{\circ}\text{F}$ (0 to 65 $^{\circ}\text{C}$)	
Max. Resolution	0.1 μS , 0.1ppm (mg/L), 0.1 $^{\circ}\text{F}/^{\circ}\text{C}$	
Basic Accuracy	$\pm 2\%$ FS, $\pm 1.8^{\circ}\text{F}/1^{\circ}\text{C}$	
Dimensions	Meter: 1.4x6.8x1.6" (36x173x41mm)/3.8oz (110g) Kit: 9.5x6.8x2.8" (241x173x71mm)/1.56lbs (708g)	
CE	Yes	Yes
Warranty	1 year (meter)/ 6 months conditional warranty (electrode)	



EC510 kit

EC500 ExStik® II pH/Conductivity/ Temperature Meter

Combination rugged flat surface
pH electrode with Conductivity cell

- 9 units of measure: pH, μ S, mS, ppm, ppt, mg/L, g/L, $^{\circ}$ C, $^{\circ}$ F
- Analog bargraph indicates trends
- Memory stores up to 25 labeled readings
- Adjustable Conductivity to TDS ratio from 0.4 to 1.0; 0.5 fixed Salinity ratio
- RENEW feature alerts user when electrode needs replacement
- **Waterproof** to IP57
- **EC500 meter** includes electrode, protective sensor cap, sample cup with cap, four 3V CR2032 batteries, and 48" (1.2m) neckstrap; *Calibration standards sold separately*
- **EC510 Kit** includes EC500, 84 μ S, 1413 μ S, 12880 μ S calibration standards, pH buffer pouches (1 each of 4, 7, 10pH plus rinse solution), weighted base, 3 sample cups with caps, and case



NEW

EC600 Waterproof Conductivity Kit

Measures Conductivity, TDS, Salinity,
Resistivity, pH, mV and Temperature

- Waterproof housing (meets IP57)
- Automatic one button pH calibration (4, 7, and 10pH)
- Choice of 3 point pH calibration for better accuracy
- One point Conductivity calibration – automatically recognizes 8 calibration solutions
- Automatic Temperature Compensation (non-linear compensation for purified water <10 μ S/cm to improve measuring accuracy)
- Memory stores up to 300 labeled readings
- Large blue backlit dual LCD display
- Auto power off with disable function
- Complete with pH/mV/Temperature electrode, polymer Conductivity cell, pH calibration solutions (4, 7, and 10pH), Conductivity calibration solution (1413 μ S), 2 AA batteries, and hard carrying case



NEW

Comes complete
with accessories
and hard case

341350A-P pH/Conductivity/TDS/ ORP/Salinity Meter

Exclusive Oyster™ Design can be
used in the lab or in the field

- Large dual LCD built into adjustable “flip-up” cover
- Microprocessor based with splash-proof housing and front panel tactile touch pad to slope and calibrate
- Rugged design for handheld or benchtop use; neckstrap for “hands-free” operation
- Memory function stores and recalls 25 labeled readings
- Automatic Temperature Compensation for Conductivity/TDS via thermistor built into conductivity cell
- Manual Temperature Compensation for pH (0 to 100 $^{\circ}$ C)
- Complete with mini pH electrode, thermistor probe (850190), sample buffers, polymer conductivity cell, 9V battery, neckstrap and case

EC500	EC510 kit
0 to 199.9 μ S, 200 to 1999 μ S, 2.00 to 19.99mS	0 to 99.9ppm (mg/L), 100 to 999ppm (mg/L), 1.00 to 9.99ppt (g/L) 0.00 to 14.00pH
—	—
32 $^{\circ}$ to 149 $^{\circ}$ F (0 to 65 $^{\circ}$ C)	—
0.1 μ S, 0.1ppm (mg/L), 0.01pH, 0.1 $^{\circ}$ F/ $^{\circ}$ C \pm 2%FS, \pm 1.8 $^{\circ}$ F/ $^{\circ}$ C	—
1.4x6.8x1.6" (36x173x41mm)/ 3.8oz (110g)	—
Kit: 9.5x6.8x2.8" (241x173x71mm)/1.56lbs (708g)	—
Yes	—
1 year (meter)/ 6 months conditional warranty (electrode)	—

EC600
—
0 to 100g/L 0 to 100ppt -2 to 19pH -1999mV to + 1999
pH/mV: 32 to 212 $^{\circ}$ F (0 to 100 $^{\circ}$ C) Other: 32 to 122 $^{\circ}$ F (0 to 50 $^{\circ}$ C)
0.01pH, 1mV, 0.01 μ S, 0.01mg/L, 0.01ppt, 0.1 $^{\circ}$ F/ $^{\circ}$ C \pm 0.02pH, \pm 0.15mV, \pm 1.5%FS, \pm 1 $^{\circ}$ F/0.5 $^{\circ}$ C
4.7x2.6x1.2" (120x65x31mm)/6.3oz (180g)
Kit: 9.5x6.8x2.8" (241x173x71mm)/1.56lbs (708g)
Yes
1 year (meter)/ 6 months conditional warranty (electrode)

341350A-P (Polymer)
10 to 19,990 μ S/cm
TDS range: 10 to 19,990ppm (mg/L)
0.01 to 14.00pH
—
Thermistor probe: 32 to 194 $^{\circ}$ F (0 to 90.0 $^{\circ}$ C)
10 μ S; 0.01pH \pm 0.5%, \pm 0.02pH
3.7x4.2x2" (96x108x45mm)/ 12oz (340g)
—
1 year (meter)/ 6 months conditional warranty (electrode)

pH Electrodes

Choice of Standard or Specialized electrodes with Ag/AgCl gel filled (fast response: 95% in 5sec)

Features:

General purpose pH/Ref electrodes 60120B and 601500

- Rugged, polycarbonate construction features glass pH sensing bulb surrounded by protective teeth. pH range (0 to 14pH), operating temperature (0 to 80°C). Choice of Mini or Standard size.

Flat surface electrode (Easy to clean) 601100

- PVC bodied electrode, ideal for pH of solid products with minimal moisture like cheese, soils or electrophoretic/agar gels. pH range (0 to 14pH), operating temperature (5 to 80°C).

Ordering

- 60120BMini pH Electrode (10 x 120mm)
601500Standard pH Electrode (12 x 160mm)
601100Flat Surface pH Electrode (15 x 106mm)

60120B
Mini size



601500
Standard size



601100
Flat Surface



Include 39" (1m) cable with BNC connection and storage solution bottle or cap. 6 month conditional warranty.

ExStik® Replacement pH, ORP, and Chlorine Electrode Modules

Features:

- Interchangeable pH, ORP, and Chlorine sensor modules for ExStik® series meters featured on (p. 130, 132)
- ATC via built-in Pt-100Ω sensor (PH105, PH115 & CL205)
- Refillable pH electrode (PH115) provides an economical way to refill your electrode, eliminates the problem of limited electrode shelf life, contamination, and usage life in aggressive applications
- Note: The PH105, CL205 and RE305 replacement modules are not interchangeable with ExStik® II meters shown on p. 130, 132
- 6 month conditional warranty



PH105 CL205 RE305

Flat surface pH, Chlorine, and ORP electrode modules



PH113 Reference Refilling Solution Kit for PH115 Refillable pH electrode module

Ordering

- PH105pH ExStik® Electrode Module
PH115Refillable pH ExStik® Electrode Module
PH113Reference Refilling Solution Kit for PH115
CL205Chlorine ExStik® Electrode Module
RE305ORP ExStik® Electrode Module

pH Buffers

Convenient calibration solutions for your pH meter

Features:

- Easy to use, already made fresh pH buffers for calibration
- Helpful table shows what the pH value should be vs. the temperature of the buffer solution measured
- Rinsing solution used for cleaning off the pH electrode before and after taking the next measurement from a different solution to prevent contamination
- Convenient pouch eliminates the need for a cup to store buffer or rinsing solution
- PH103 contains 6 pouches of each buffer (pH 4.00, 7.00, and 10.00), plus 2 Rinsing solutions
- Pint size pH buffer solutions available (PH4-P, PH7-P, and PH10-P)



Ordering

- PH4-PpH 4 Buffer Calibration Solution (2 bottles - 1 pint each)
PH7-PpH 7 Buffer Calibration Solution (2 bottles - 1 pint each)
PH10-P ..pH 10 Buffer Calibration Solution (2 bottles - 1 pint each)
PH103Tripak Buffer pouches (6ea: 4, 7, 10pH, 2 Rinse solutions)

D0700 Waterproof Series Dissolved Oxygen Kit

NEW

8-in-1 Meter — Measures DO concentration/saturation, pH, mV, Conductivity, TDS, Salinity, Resistivity and Temperature

Features:

- Automatic salinity compensation and manual barometric pressure compensation for DO measurements
- Waterproof housing (meets IP57)
- Choice of 3 point pH calibration for better accuracy
- One point Conductivity calibration – automatically recognizes 8 calibration solutions
- Automatic Temperature Compensation
- Memory stores up to 400 labeled readings
- Large blue backlit dual LCD display
- Auto power off with disable function
- Complete with Dissolved Oxygen probe with 3 membrane caps and DO internal fill solution (30mL), pH/mV/ Temperature electrode, polymer Conductivity cell, pH calibration solutions (4, 7, and 10pH), Conductivity calibration solution (1413µS), 2 AA batteries, and hard carrying case



Functions	Range	Resolution	Basic Accuracy
Dissolved Oxygen (Concentration)	0 to 40.00mg/L	0.01mg/L	±1.5%FS
Dissolved Oxygen (Saturation)	0 to 200.0%	0.1%	±1.5%FS
pH	-2.00 to 19.99pH	0.01pH	±0.02pH
mV	-1999 to + 1999mV	1mV	±0.15mV
Conductivity	0.00 to 199.9mS	0.01µS	±1.5%FS
TDS	0 to 100g/L	0.01mg/L	±1.5%FS
Salinity	0 to 100ppt	0.01ppt	±1.5%FS
Resistivity	0 to 100MΩ · cm	0.1Ω	±1.5%FS
Temperature (pH and mV)	32 to 212°F (0 to 100°C)	0.1°	±1°F/±0.5°C
Temperature (other)	32 to 122°F (0 to 50°C)	0.1°	±1°F/±0.5°C
Power	Two AA batteries		
Dimension/ Weight	4.7 x 2.6 x 1.2" (120 x 65 x 31mm)/ 6.3oz (180g)		

Specifications

Ordering:

- DO700Waterproof Series Dissolved Oxygen Kit
- DO705Dissolved Oxygen Electrode
- DO703Replacement Membrane Caps (3 caps)
- PH305Spare pH/mV/Temperature Electrode
- EC605Spare Polymer Conductivity Cell



Read to use complete kit includes all the necessary accessories stored in a hard case for easy transportation. Ideal for field use.

407510 Heavy Duty Dissolved Oxygen Meter

Dual display of Oxygen concentration in solutions and Temperature — plus RS-232 PC interface

Features:

- Measures dissolved oxygen, oxygen, plus temperature
- Min/Max/Avg, Data Hold and Auto power off
- Automatic Temperature Compensation
- Super large 1.4" (36mm) LCD display
- Built-in RS-232 PC interface with optional Data Acquisition Software 407001 and Datalogger 380340 (See p. 108)

Functions	Dissolved Oxygen	Oxygen	Temperature
Range	0 to 19.9mg/L	0 to 100.0%	32 to 122°F (0 to 50°C)
Accuracy	±0.4mg/L	±0.7%	±1.5°F/ ±0.8°C
Probe Compensation & Adjustment	Salt: 0 to 39%	Altitude 0 to 3900m	Temp: 0 to 50°C
CE/Warranty	CE approved; 3 years (meter)/ 6 months conditional warranty (electrode)		
Dimensions	Meter: 7x3x1.3" (178x74x33mm); Probe: 0.8Dx4.9"L		
Weight	17oz (482g)		

Ordering

- 407510Heavy Duty Dissolved Oxygen Kit
- 407510-PDissolved Oxygen probe with 13ft (4m) cable
- 780417AReplacement Membranes (10/pack)
- 780418DO Internal Fill Solution (2pks — 50mL each)



Complete with 0.8" (20mm) probe on 13ft (4m) cable, membranes, protective holster with stand, 9V battery, and carrying case



Part No.	Page #
140001	78
144118	114
144220	114
144240	114
153117	51
153220	51
153230	104
156119	78
156221	78
341350A-P	137
365510	127
365515	127
365535	127
380193	51
380260	57
380320	56
380340	108
380353	57
380360	57
380363	59
380366	59
380379	56
380395	59
380396	59
380460	55
380462	55
380465	55
380560	55
380562	55
380565	55
380580	55
380801	65
380803	65
380820	65
380926	39
380940	60
380941	37
380942	36
380947	37
380950	37
380976	39, 61
381295A	21
381676	23
382000	62, 63
382068	61
382075	61
382090	64

Part No.	Page #
382091	64
382095	63
382096	63
382097	63
382098	63
382099	64
382100	62
382152	54
382153	54
382154	54
382200	67
382202	67
382203	67
382213	67
382252	54
382253	54
382254	54
382260	67
382270	68-69
382275	69
382276	69
382280	69
382357	54
382400	39
392050	81
392085	81
39240	81
39272	81
401012	81
401014	81
401025	109
401027	108
401050	40
40130	40
40180	48
407001	108
407026	109
40705X	112, 114
407113	103
407119	103
407123	101
407355	117
407355-KIT-5	117
407510	139
407510-P	139
407703A	112
407730	112

Part No.	Page #
407732	113
407732-KIT	113
407736	113
407744	113
407750	113
407752	84, 86
407760	116
407764	115
407764-EXT	114
407766	113
407768	114
407780	115
407790	117
407860	107
407907	79
407910	122
409992	43
409996	43
409997	43, 122
412300A	124
412355A	124
412400	125
412440-S	125
421502	79
421509	79
42260	83
42265	83
42270	83
42275	83
42280	83
42299	83, 116
42500	75
42509	70
42510A	75
42512	70
42515	73
42540	73
42545	73
42560	71
42560-E	71
42570	71
433201	124
44550	96
445580	86
445582	86
445702	96
445703	94

Part No.	Page #
445706	97
445713	95
445715	94
445814	95
445815	95
451126	101
45116	98
45118	98
451181	101
45156	98
45158	98
45160	99
45170	99
461700	120
461750	120
461825	120
461830	121
461831	121
461834	121
461880	107
461891	118
461893	118
461895	119
461920	120
461937	119, 120
461950	121
461955	121
461957	121
461960	121
461990	119
461995	119
475040	104
475044	104
475055	104
479097	104
480172	35
480400	52
480403	52
480823	51
480826	50
480836	50
480846	50
589250	84
601100	138
60120B	136, 138
6012WS	134
601500	138

Part No.	Page #
6015WC	134
6750WC	134
6750WS	134
780417A	139
780418	139
801515	80
804010A	136
850185	134
850186	80
850187	80
850188	134
850189	80
850190	136
871515	80
872502	80
881602	80
881603	80
881605	80
AM300	34
AN100	102
AN200	102
AN400	99
BR146	123
BR200	123
CA200	43
CA250	43
CA500	43
CA895	130, 132
CA899	43
CA900	43
CA904	130
CB10	46
CL200	132
CL203	132
CL204	132
CL205	132, 138
CL207	132
CO10	105
CO200	106
CO250	106
CT100	48
CT20	47
CT40	47
CTH10	97
DA30	40
DA50	40
DL150	53

Part No.	Page #
DL152	53
DM110	23
DM220	23
DO600	131
DO600-K	131
DO603	130
DO605	130
DO610	133
DO700	139
DO703	139
DO705	139
DT100	53
DV20	40
DV24	40
DV25	41
DV30	41
DV40	41
DV50	40
DVA30	41
EA10	77
EA11A	76
EA15	77
EA20	87
EA25	87
EA30	110
EA31	110
EA33	111
EA80	106
EC-12880-P	130, 136
EC-1413-P	130, 136
EC400	131, 136
EC405	130, 136
EC410	133
EC500	131, 137
EC505	130, 136
EC510	133
EC600	137
EC605	136, 139
EC-84-P	130, 136
EM100	64
EX006	132
EX007	132
EX010	130
EX050	130
EX310	17
EX320	17
EX330	17

Part No.	Page #
EX410	15
EX411	15
EX420	15
EX430	15
EX470	15
EX503	13
EX505	13
EX505-K	25
EX520	13
EX530	13
EX540	11
EX542	11
EX570	10
EX612	29
EX613	29
EX622	29
EX623	29
EX710	33
EX720	33
EX730	33
EX800	133
EX800-R	133
EX810	30
EX820	31
EX830	31
EX840	31
EX900	133
EZ30	100
EZ40	105
FG100	105
FL700	131
FL704	130
FL705	130
F0600FC2-KIT	49
F0600M-KIT	49
F0600SC2-KIT	49
F0600ST2-KIT	49
FS880	18
FS881	18
HD200	77
HD300	102
HD350	103
HD400	111
HD450	111
HD500	85
HD550	85
HD600	115

Part No.	Page #
HD700	122
HD750	122
HD755	122
HG500	13
HT30	87
HW30	126
IR100	74
IR201	75
LE200ST	49
LE220ST	49
LS300FC	49
LS300SC	49
LS300ST	49
LS320FC	49
LS320SC	49
LS320ST	49
LT300	109
MA120	38
MA150	38
MA200	34
MA220	34
MA250	35
MA410	35
MA620	35
MA620-K	25
MA640	35
MA640-K	52
MC108	21, 129
MM560	19
MM570	19
MN15A	22
MN16A	22
MN25	22
MN26T	22
MO100	88
MO100-PINS	88
MO200-PINS	88
MO210	88
MO220	89
MO220-PINS	88, 90
MO250	89
MO250-PINS	88
MO252	88
MO280	91
MO280-KH	93
MO280-KH2	93
MO280-KW	93

Part No.	Page #
MO280-RK	92
MO290	91
MO290-BP	90
MO290-EP	90
MO290-EXT	90
MO290-HP	90
MO290-P	90
MO290-PINS-EP	90
MO290-PINS-HP	90
MO290-RK	92
MO295	91
MO750	89
MO750-P	88
MP510	19
MP530	19
MS420	20
MS460	20
OYSTER-15	135
OYSTER-16	135
PCSTST	49
PCSTST-SM	49
PH100	130, 134
PH103	134, 138
PH105	134, 138
PH10-P	134, 138
PH110	134
PH113	134, 138
PH115	134, 138
PH150-C	129
PH155	129

Part No.	Page #
PH220-C	135
PH220-S	135
PH300	135
PH305	134, 138
PH4-P	134, 138
PH50	129
PH60	129
PH7-P	134, 138
RC100	51
RE300	130
RE305	130
RF10	128
RF11	128
RF12	128
RF15	128
RF16	128
RF18	128
RF20	128
RF30	128
RF40	128
RF41	128
RH101	87
RH300	84
RH300-CAL	95
RH305	84
RH350	84
RH350-CAL	84
RH355	84
RH390	85
RH401	85

Part No.	Page #
RH401-CAL	84
RH405	85
RH490	85
RH520A	82
RH520A-220	82
RH520A-240	82
RH522	82
RHT10	83
RHT10-SW	83
RHT20	82
RPM10	119
RT30	46
RT32	46
SL123	116
SL124	116
SL125	116
SL130-220	116
SL130-240	116
SL130G	116
SW800	18
SW810	18
TG30	48
TH10	83
TK430	24
TK430-IR	24
TL747	45
TL748	45
TL709	45
TL740	45
TL741	44

Part No.	Page #
TL742	44
TL708	45
TL743	44
TL744	45
TL726	45
TL803	42
TL805	42
TL806	42
TL807	42
TL807-C	42
TL809	42
TL810	42
TL833	44
TL831	44
TL841	44
TM100	76
TP200	43
TP400	43
TP870	42
TP873	42
TP875	42
TP890	84
TR100	71, 98
UA100-240	134
USB100	64
VT10	41
VT30	41
WTH100	97



WORLDWIDE Distributor Support

Visit www.distributors.extech.com
for a network of stocking distributors
throughout the USA and more than
100 countries worldwide.

Electrical

The Extech i5 reveals a loose connection: a potential fire risk.

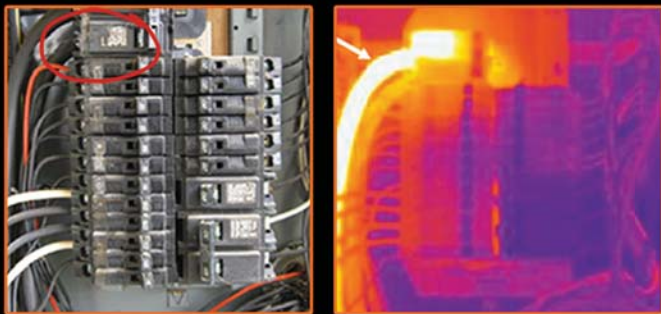

HVAC/R

The Extech i5 reveals an overheating main line: a productivity loss risk.

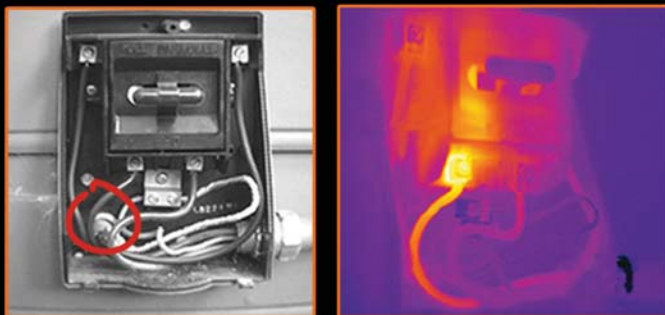

Building

The Extech i5 reveals missing insulation: Potential heat loss



Thermal Imaging Just Got Easier

Thermal imaging cameras can detect what no eye can see such as the minor variations in temperature that can signal electrical or moisture problems. Infrared inspection with the EXTECH i5 thermal imaging camera gives you a powerful non-invasive monitoring and diagnosing tool. Detect hot spots, avoid electrical and mechanical failures, locate water damage sources, find missing insulation and leaky air ducts. Your results can be captured and documented instantly into professional reports providing documented proof of your findings. Arm yourself and your crew with an EXTECH i5 and see what you've been missing!

To order from an authorized Extech distributor, visit www.extech.com/i5
For complete solutions to finding problems with Thermal Imagers and solving them with Extech test tools, visit www.extech.com/completesolution

EXTECH i5

See what you've been missing

Designed for HVAC, Electrical, Building, and Plant Professionals

- 2% thermal accuracy
- Patented radiometric JPEGs that are easy to share or analyze
- 1,000 JPEG SD card storage capacity and USB connectivity
- Browsable on-screen thumbnail gallery
- All in a rugged double-molded housing



EXTECH[®]
INSTRUMENTS
A FLIR COMPANY

Category Index

Air Velocity Meters/Anemometers	98-103	IR Thermometers	70-75
Air Quality Meter	106	LCR Meter	51
Appliance Tester/Analyzers	65	Light Meters and Dataloggers	99, 108-111
Borescopes/Video Inspection Camera	123	Manometers (Pressure Meters)	103, 116-117
Cable Testers, Network and LAN	47-49	Megohmmeters (Insulation Testers)	56-59
Calibrators-Current, Voltage, T/C, Process, pH	124-125	Microscopes	21, 129
Carbon Dioxide (CO ₂) Meters	106	Milliohm Meters	55
Carbon Monoxide (CO) Meters	105	Moisture Meters	88-91
CFM Meters	101-103	MultiMeters	8-23
Chlorine Meter, Kits, and Accessories	132-133	MultiMeter Accessories	42-45
Circuit Breaker Finder	46	MultiMeter Adaptors	43
Clamp Meter Kits	24-25, 52	MultiMeter Test Kits	24-25
Clamp-on Meters	26-39	ORP Meters	130
Clocks, Hygro-Thermometer	96-97	Oscilloscopes, Graphical MultiMeters	20-21
Component Tester	51	Phase & Motor Rotation Testers	52
Concrete pH Kit	129	pH/mV/Temp Meters, Accessories	129-130, 133-135, 138
Conductivity Meters, Kits	131, 133, 136-137	Pitot Tube (Air Flow Meter)	102-103
Continuity Tester/Cable Locator	40	Power Meters/Dataloggers/ Analyzers	39, 60-65
Controllers-RPM	121	Power Supplies, DC	66-69
Dataloggers, Recorders - Voltage/Current	53	Pressure Meters (Manometers)	103, 116-117
Dataloggers, Recorders - Temperature/Humidity	82-83	Psychrometers, Dew Point/Wet Bulb	84-85
Dew Point/Web Bulb	84-85, 87	Refractometers: Sucrose, Salinity, Battery Coolant	128
Dissolved Oxygen Meters	131, 133, 139	Sound Level Alert/Monitors	116
Distance Meter	53	Sound Level Meters, Calibrators, Datalogger	112-117
Dosimeters, Noise	117	Stopwatches	126-127
Electrical Testers	41, 46	Stroboscope Tachometers	120-121
Electrical Test Kits	36-37	Tachometers - Contact, Photo, & Strobotach	107, 118-121
EMF/ELF, Gauss Meter	50-51	TDS Meters (Total Dissolved Solids)	131, 133, 136-137, 139
Energy Cost Monitor/Datalogger	64	Temperature Indicators	81
Fiber Optic Power Meters and Light Sources	49	Temperature Probes (Thermocouple and RTD)	42-43, 76, 80
Fluoride Meter	131	Test Leads and Accessories	42-45
Force Gauge Meters	104	Thermal Imaging Cameras	143
Gas Detectors	105	Thermo-Anemometers	92-97
Ground Resistance/Earth Resistance Testers	54	Thermometers - IR, Thermocouple, RTD	70-79
Harmonics Analyzers	63	Timers-Programmable, Countdown, Stopwatch	126-127
Heat Index Stopwatch	126	Tone Generators and Wire Tracers	48
Heat Stress WBGT Meter	86-87	Vibration Meters	107
Home Inspection & Water Restoration Kits	92-93	Video Fiber Borescope	123
Humidity Graphical Recorder	82	Voltage and Current Dataloggers	53
Humidity Meters, Hygro-Thermometers	86-87, 94-97	Voltage and Current Detectors	40-41
Humidity Indicators	94-97	Water Quality Meters, Kits, Accessories	130-139
Insulation Testers (Megohmmeters)	56-59	Water Restoration Kit	92-93

All specifications and prices are subject to change without notice. See page 140-142 for a complete part number index

For the name of your local distributor, visit www.extech.com

EXTECH[®]
INSTRUMENTS
A FLIR COMPANY

Extech Instruments Corporation
285 Bear Hill Road
Waltham, MA 02451-1064
ph: 1.781.890.7440 or 1.781.434.3900
Fax: 1.781.890.7864