



Save Time

FOR PROGRAMLESS OPERATION
FOR REDUCTION OF DOWNTIME
GOT1000



Mitsubishi Electric Corporation Nagoya Works and Himeji Works are factories certified for ISO14001 (standards for environmental management systems) and ISO9001 (standards for quality assurance management systems).



The GOT1000 series saves time on the manufacturing front.

With new products coming and going very quickly in rapidly changing markets, "time" is the key to competitiveness and success. This is why the GOT1000 sticks to saving time. How about starting up equipment quickly without even bothering with programming? Or debugging and troubleshooting at worksites to reduce downtime? To make it happen, the GOT1000 offers cutting-edge solutions, leaving conventional HMIs far behind.

is why the GOT1000 sticks to saving time. to reduce downtime?

PROGRAMLESS OPERATION

PROGRAMLESS OPERATION

Linking up with MELSEC process control

Effectively creates process control screens without programming, enabling process control systems to start up quickly.

PROGRAMLESS OPERATION

MES interface function

Simply and conveniently enables "programless" connection between worksites and information systems. Easily adds or alters system from the user side.

PROGRAMLESS OPERATION

Compatible with iQ Platform

Links GOTs with engineering environment, controllers, and networks without programming.

REDUCTION OF DOWNTIME

REDUCTION OF DOWNTIME

Backup/restoration function

Backs up programs and data automatically, enabling efficient maintenance work.

REDUCTION OF DOWNTIME

Document display/motion images

Enables viewing of equipment manuals at a worksite in case of trouble. Use of motion images makes restoration efficient.

REDUCTION OF DOWNTIME

Monitor functions

<Ladder monitor, SFC monitor, etc.>

Equipped with standard features to set and monitor Mitsubishi Electric's FA equipment. Combined with transparent function makes adjustment and debugging efficient.



The GOT lets the manufacturing front line evolve.

GRAPHIC OPERATION TERMINAL
GOT1000



The cutting-edge GT16 epitomizes an "all-in-one" HMI. Coming on the center stage with a dignified full flat face.

GT16

GOT1000 GRAPHIC OPERATION TERMINAL



15" type



12.1" type

With cost performance second to none. The GT10 offers 5.7" type GT105.

GT10

GOT1000 GRAPHIC OPERATION TERMINAL



5.7" type

With a variety of integrated functions,
such as Ethernet and multimedia

GT16

GOT1000 GRAPHIC OPERATION TERMINAL

- Multimedia
- Video RGB
- Network
- Bus
- Serial

15" type



XGA TFT (High-brightness, wide viewing angle)
GT1695M-XTBA AC type GT1695M-XTBD DC type
Resolution : 1024 x 768 Display colors : 65,536 colors
Multimedia, video/RGB model

12.1" type



SVGA TFT (High-brightness, wide viewing angle)
GT1685M-STBA AC type GT1685M-STBD DC type
Resolution : 800 x 600 Display colors : 65,536 colors
Multimedia, video/RGB model

10.4" type



SVGA TFT (High-brightness, wide viewing angle)
GT1675M-STBA AC type GT1675M-STBD DC type
Resolution : 800 x 600 Display colors : 65,536 colors
Multimedia, video/RGB model

VGA TFT (High-brightness, wide viewing angle)
GT1675M-VTBA AC type GT1675M-VTBD DC type
Resolution : 640 x 480 Display colors : 65,536 colors
Multimedia, video/RGB model

8.4" type



SVGA TFT (High-brightness, wide viewing angle)
GT1665M-STBA AC type GT1665M-STBD DC type
Resolution : 800 x 600 Display colors : 65,536 colors
Multimedia, video/RGB model

VGA TFT (High-brightness, wide viewing angle)
GT1665M-VTBA AC type GT1665M-VTBD DC type
Resolution : 640 x 480 Display colors : 65,536 colors
Multimedia, video/RGB model

The GOT expands its lineup in
all four models to meet
the demands of the manufacturing front.

LINE-UP GOT1000

GT16 model/GT15 model/GT11 model/GT10 model

Wide range of uses from network to stand alone

GT15

GOT1000 GRAPHIC OPERATION TERMINAL

- Multimedia
- Video RGB
- Network
- Bus
- Serial

15" type



XGA TFT (High-brightness, wide viewing angle)
GT1595-XTBA AC type GT1595-XTBD DC type
Resolution : 1024 x 768 Display colors : 65,536 colors

12.1" type



SVGA TFT (High-brightness, wide viewing angle)
GT1585V-STBA AC type GT1585V-STBD DC type
Resolution : 800 x 600 Display colors : 65,536 colors
Video/RGB model

SVGA TFT (High-brightness, wide viewing angle)
GT1585-STBA AC type GT1585-STBD DC type
Resolution : 800 x 600 Display colors : 65,536 colors

10.4" type



SVGA TFT (High-brightness, wide viewing angle)
GT1575V-STBA AC type GT1575V-STBD DC type
Resolution : 800 x 600 Display colors : 65,536 colors
Video/RGB model

SVGA TFT (High-brightness, wide viewing angle)
GT1575-STBA AC type GT1575-STBD DC type
Resolution : 800 x 600 Display colors : 65,536 colors

VGA TFT (High-brightness, wide viewing angle)
GT1575-VTBA AC type GT1575-VTBD DC type
Resolution : 640 x 480 Display colors : 65,536 colors

VGA TFT
GT1575-VNBA AC type GT1575-VNBD DC type
Resolution : 640 x 480 Display colors : 256 colors

VGA TFT
GT1572-VNBA AC type GT1572-VNBD DC type
Resolution : 640 x 480 Display colors : 16 colors

8.4" type



VGA TFT (High-brightness, wide viewing angle)
GT1565-VTBA AC type GT1565-VTBD DC type
Resolution : 640 x 480 Display colors : 65,536 colors

VGA TFT
GT1562-VNBA AC type GT1562-VNBD DC type
Resolution : 640 x 480 Display colors : 16 colors

5.7" type



VGA TFT (High-brightness, wide viewing angle)
GT1555-VTBD DC type
Resolution : 640 x 480 Display colors : 65,536 colors

QVGA TFT (High-brightness, wide viewing angle)
GT1555-OTBD DC type
Resolution : 320 x 240 Display colors : 65,536 colors



QVGA STN
GT1555-QSBD DC type
Resolution : 320 x 240 Display colors : 4,096 colors



QVGA STN
GT1550-QLBD DC type
Resolution : 320 x 240 Display colors : 16 gray scales

Enhanced with basic functions
for stand alone application

GT11

GOT1000 GRAPHIC OPERATION TERMINAL

- Multimedia
- Video RGB
- Network
- Bus
- Serial

5.7" type



QVGA TFT
GT1155-OTBD DC type
GT1155-OTBDQ DC type Q bus connection
GT1155-OTBDA DC type A bus connection
Resolution : 320 x 240 Display colors : 256 colors



QVGA STN
GT1155-QSBD DC type
GT1155-QSBDQ DC type Q bus connection
GT1155-QSBDA DC type A bus connection
Resolution : 320 x 240 Display colors : 256 colors



QVGA STN
GT1150-QLBD DC type
GT1150-QLBDQ DC type Q bus connection
GT1150-QLBDA DC type A bus connection
Resolution : 320 x 240 Display colors : 16 gray scales



QVGA Handy GOT/STN
GT1155HS-QSBD DC type
Resolution : 320 x 240 Display colors : 256 colors



QVGA Handy GOT/STN
GT1150HS-QLBD DC type
Resolution : 320 x 240 Display colors : 16 gray scales

Including all the basic functions
required for a HMI display

GT10

GOT1000 GRAPHIC OPERATION TERMINAL

- Multimedia
- Video RGB
- Network
- Bus
- Serial

5.7" type



QVGA STN
GT1050-QSBD 24VDC type
Resolution : 320 x 240
Display colors : 256 colors



QVGA STN
GT1050-QBBD 24VDC type
Resolution : 320 x 240
Display colors : Monochrome (blue/white) 16 gray scales

4.7" type



QVGA STN Coming in Winter 2008
GT1045-QSBD 24VDC type
Resolution : 320 x 240
Display colors : 256 colors



QVGA STN Coming in Winter 2008
GT1040-QBBD 24VDC type
Resolution : 320 x 240
Display colors : Monochrome (blue/white) 16 gray scales

4.5" type



STN
GT1030-LBD Black 24VDC type RS-422 connection
GT1030-LBD2 Black 24VDC type RS-232 connection
GT1030-LWD White 24VDC type RS-422 connection
GT1030-LWD2 White 24VDC type RS-232 connection
Resolution : 288 x 96
Display colors : Monochrome (black/white) (Tricolor LED (green/orange/red))



STN
GT1030-LBDW Black 24VDC type RS-422 connection
GT1030-LBDW2 Black 24VDC type RS-232 connection
GT1030-LWDW White 24VDC type RS-422 connection
GT1030-LWDW2 White 24VDC type RS-232 connection
Resolution : 288 x 96
Display colors : Monochrome (black/white) (Tricolor LED (white/pink/red))

3.7" type



STN
GT1020-LBD Black 24VDC type RS-422 connection
GT1020-LBD2 Black 24VDC type RS-232 connection
GT1020-LBL Black 5VDC type RS-422 connection
GT1020-LBLW White 24VDC type RS-422 connection
GT1020-LWD White 24VDC type RS-232 connection
GT1020-LWD2 White 24VDC type RS-232 connection
Resolution : 160 x 64
Display colors : Monochrome (black/white) (Tricolor LED (green/orange/red))



STN
GT1020-LBDW Black 24VDC type RS-422 connection
GT1020-LBDW2 Black 24VDC type RS-232 connection
GT1020-LBLW White 5VDC type RS-422 connection
GT1020-LBLW2 White 24VDC type RS-422 connection
GT1020-LWL White 5VDC type RS-422 connection
Resolution : 160 x 64
Display colors : Monochrome (black/white) (Tricolor LED (white/pink/red))

The **GT1000** now goes even further.
The new all-in-one model is packed with
all the solutions to meet the needs of customers.

Human sensor

Automatically detects approaching people. Saves both energy and running cost.



USB host and USB device

Aesthetically pleasing and completely flat surface with a full-flat USB environmental protection cover. Just one touch to open the cover, and there is no need to use a screwdriver.

Extension unit

For mounting a multimedia unit, a video/RGB unit, a communication unit, etc.

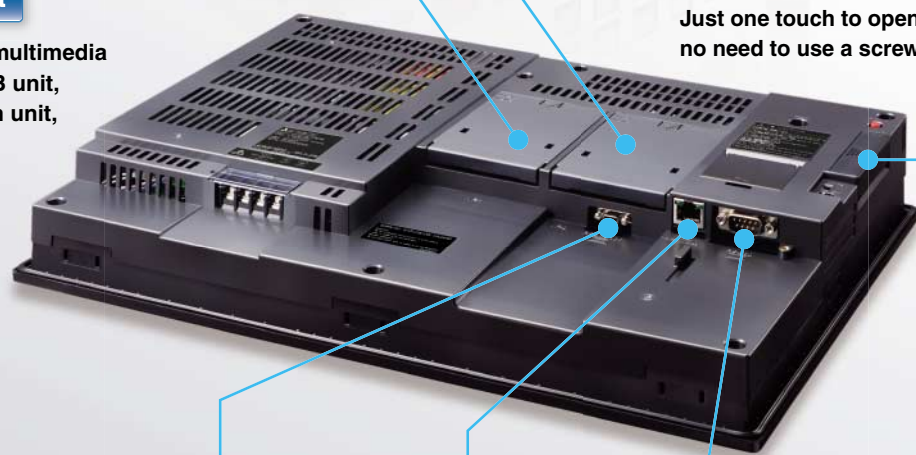

CF card

RS-422/485

Ethernet

RS-232

Greatly increased memory capacity! Requiring no optional function boards

Enables use of real parts without having to worry about the memory capacity

The user memory is increased from the standard 9MB to 15MB. An optional function board is not necessary for memory extension.
▶ Increased memory capacity (See page 26.)

Useful functions are available while requiring no optional function boards

Requires no optional function boards that were previously necessary when using the multi-channel function, the document display, and the Q/QnA ladder monitor function.

User memory capacity

GT15 Standard 9MB

GT16 Standard 15MB

No need for optional function boards for memory extension.

1.7 times

Equipped with USB host and USB devices

USB host (Type A)

Hooking up a USB memory drive here enables storage of resource data such as operating systems, project data and alarm logs, as well as backup/restored data such as sequence programs. The data communication is simple and easy between the GOT main unit and a CF card.



USB device (Mini-B)

Connecting the USB device (Mini-B) to a personal computer enables the transfer of operating systems and project data without opening the panel. The FA transparent function enables modification of sequence programs.



▶ Equipped with front USB interface (See page 43.)
▶ FA transparent function (See page 43.)

Various interfaces are available as standard features, including Ethernet, RS-422/485, and RS-232

A variety of built-in interfaces

The built-in interfaces (Ethernet, RS-422/485 and RS-232) enable connection to up to four kinds of FA equipment simultaneously without installing an additional optional communication unit.

▶ Multi-channel function (See page 29.)

Ethernet helps extend systems

The built-in Ethernet interface connects to a PLC CPU with a built-in Ethernet and a host system easily while requiring no optional communication unit.

▶ Wide selection of connectable FA devices and peripherals (See page 28.)
▶ Gateway function (See page 32.)
▶ MES interface function (See page 33.)

* : For the Ethernet connection, if connected to equipment compatible with 10BASE (-T/2/5), use a switching hub for its operation in a network environment where both 10Mbps and 100Mbps systems are operable.

Ethernet enables simultaneous monitoring of PLCs of different manufacturers

The built-in Ethernet interface enables connection to up to four kinds of PLCs of different manufacturers.

▶ Multi-channel function (See page 29.)

Example of system configuration with Ethernet

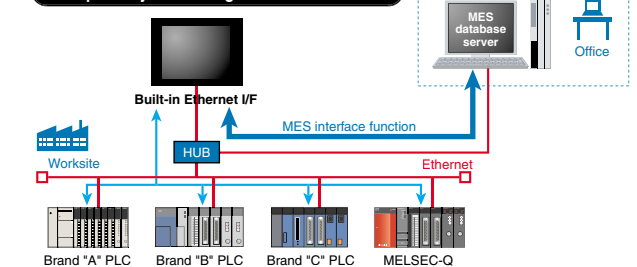

All the models are compatible with multimedia and video/RGB units

Compatible with recording and playing back high resolution motion images

Multimedia functions capable of recording and playing back smooth flow of motion images can visually check and monitor site conditions in an emergency and give instructions in the form of motion image manuals.

▶ Multimedia function (See page 30.)

The 15" type is also compatible with video/RGB

Even when displaying motion images from four video cameras in four respective windows simultaneously on the screen, the GT16 displays natural, smooth, and large motion images without skipping image cells.

▶ For Video/RGB (See page 30.)

Featuring an analog touch panel

Layout flexibility to create desired pictures

Free to lay out objects such as touch switches, enabling creation of desired screens. The clear display without grids makes it easy to recognize pictures and characters.

Many more useful functions are available

- More flexible and free screen design
- Seven-segment display
- GT Designer2 is easier to use.
- The GOT operation history is traceable.
- ▶ Overlap window extension (See page 26.)
- ▶ An assortment of fonts allows for more expression (See page 36.)
- ▶ Guideline, others (See page 39.)
- ▶ Batch self check function (See page 45.)

**Equipped with necessary and sufficient functions,
the 5.7" type of the second-to-none cost performance
GOT is here to debut!**



GT1055 NEW
GT1055-QSBD STN color (256 colors)
High cost performance,
256-color model



GT1050 NEW
GT1050-QBBD STN monochrome
16 gray scales (white/blue)
Equipped with a white/blue monochrome
liquid crystal display – a new feature of the
GOT1000 series



GT1020 GT1030 NEW
The white frame model – launched into market
(Built to order)
* : See "GT10 model" (page 52) for details.

Equipped with 3-channel communication port

■ The GT10 has all of its communication ports on the back

- ① RS-232 (D-SUB 9-pin, male)
- ② RS-422 (D-SUB 9-pin, female)
- ③ USB device (Mini-B)

As the GT10 is on many occasions for stand-alone applications, it has personal computer interfaces on its back.

The GT105□ has a USB, offering three-channel communication ports together with RS-422 and RS-233.

The USB and RS-232 ports are compatible with the FA transparent function of Mitsubishi PLCs.

* : Refer to "GOT1000 connection manual" for the details of compatible models and connections.



OS pre-installed

■ Pre-installed OS reduces process time

The GT10 has a basic operating system and communication driver (for FX) pre-installed as it is often used with FX series production equipment.

For connection to an FX PLC, simply enter the project data, and the GT10 is already up and running.

3MB memory of ample margin

■ Use the functions as you like without concern for memory constraint

The GT10 has 3MB memory, the same as for the higher model GT11. You can use a variety of objects, parts and functions without being bothered by the memory capacity.

GT11	3MB
GT105□	3MB
GT1030	1.5MB
GT1020	512KB

* : Note that the maximum number of screens differs between GT10 and GT11.

Easy updating with a memory board

■ An optional memory board is available

This enables to easily update the GOT without a personal computer. The feature is convenient where you cannot take your personal computer with you such as on a business trip or when servicing a customer in a remote area. It also enables reading out of the current data to back it up before alteration.

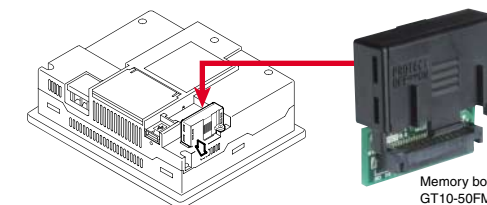

An outstanding cost performance

■ Offers more functions at lower cost than conventional models

Developing ease of use unique to the GOT1000 and offering satisfactory functions at a 25 percent cost reduction.

Specification comparison between F940GOT and GT1055

	F940GOT-SWD	GT1055-QSBD
Memory	512KB	3MB
Communication port	2ch	3ch
Baud rate	38.4Kbps	115.2Kbps
STN color	8 colors	256 colors
Environment resistance	IP65f	IP67f

Improved functions

Standard price comparison of STN color types between F940GOT and GT1055

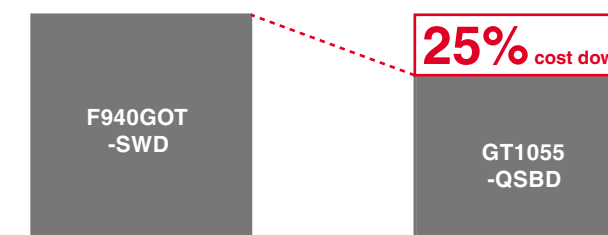

* : For other functions, see "GT10 model" (page 52).

Ensuring safe operation, the GT16/GT15 offers better solutions for you.

CASE 1

Don't panic when encountering unexpected errors
— Quick troubleshooting at the worksite

Before

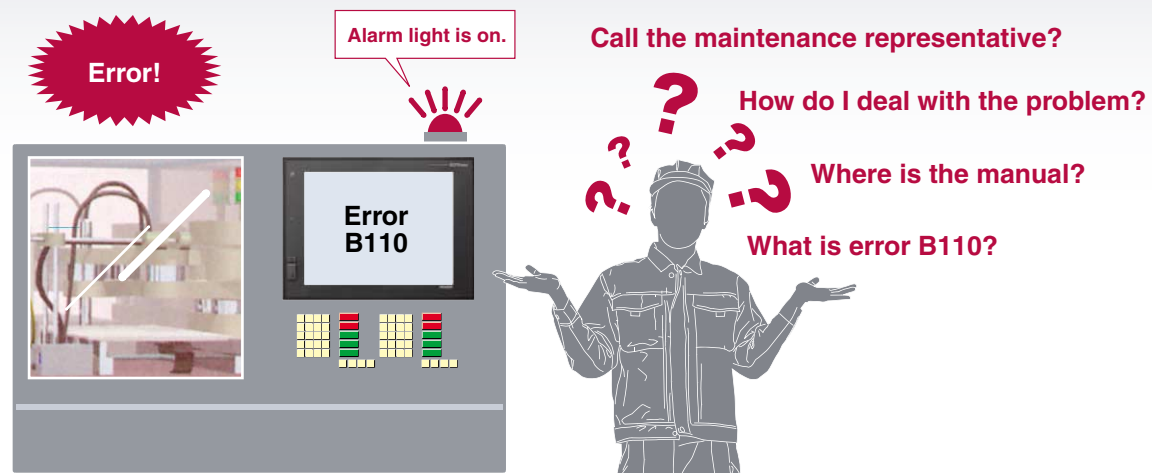

GOT Solution 2

Investigate the problem cause at the production site

(Error occurred in ST2 device!)

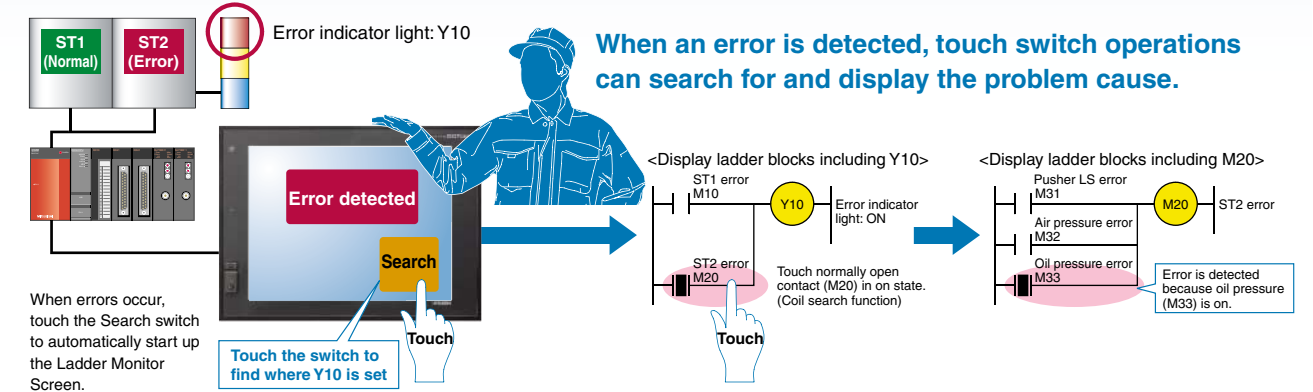

Reduce downtime after problems caused by equipment breakdown or a halt in the operation

GOT1000 GRAPHIC OPERATION TERMINAL

One-Touch Ladder Jump function

- Just touch the operation flow diagram on the GOT, which will show you the root cause of the problem. There is no need to use personal computers or ladder programs.
- Using general purpose PLC error indication programs and detection programs makes developing new search programs and screens unnecessary.

<For more details, see page 50 of this catalog.>

(Application case) When error messages are not displayed

Before

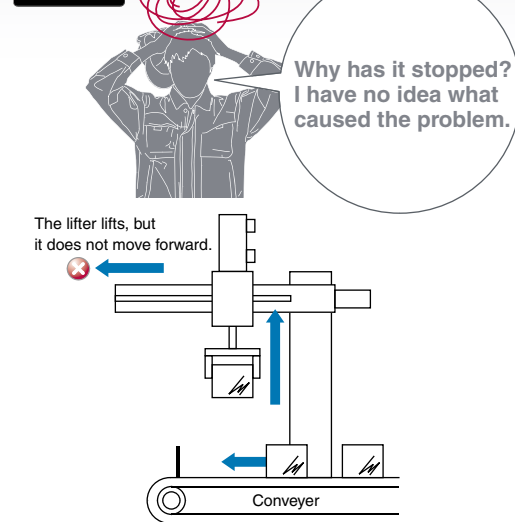

GOT Solution

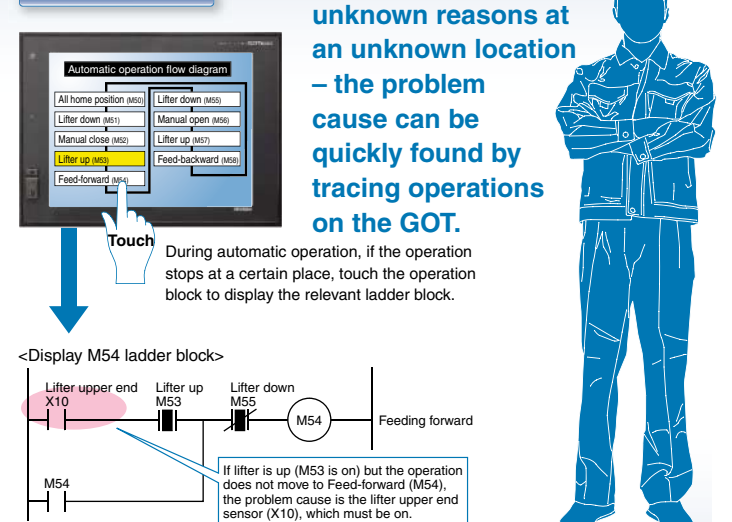

GOT Solution 1

Install troubleshooting manuals on GOT1000, and let's get simple problems solved at a worksite.

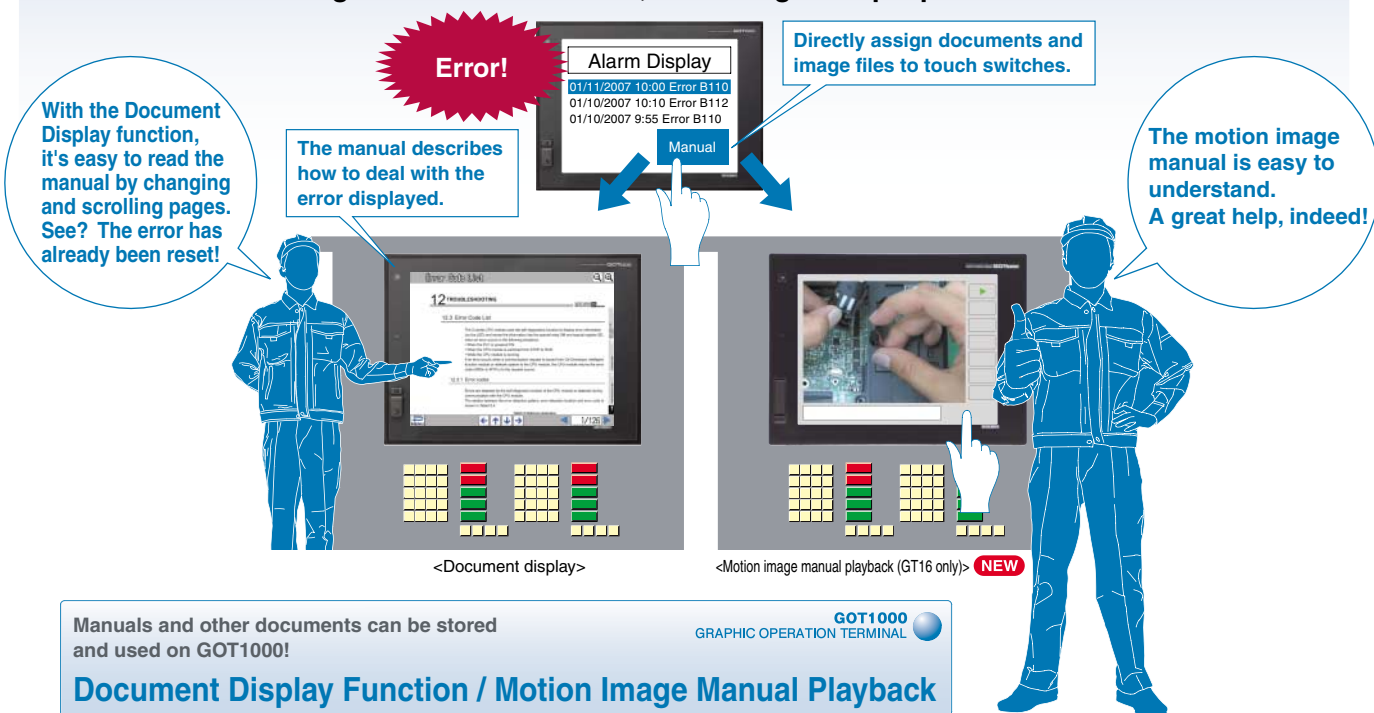

Manuals and other documents can be stored and used on GOT1000!

GOT1000 GRAPHIC OPERATION TERMINAL

Document Display Function / Motion Image Manual Playback

- Documents such as troubleshooting manuals can be displayed for quick reference to reduce downtime.
- Particularly efficient in places where paper manuals or personal computers cannot be brought in, such as clean rooms.
- General-purpose documents (doc, xls, ppt, pdf, jpg, and bmp) and general-purpose file formats (3GP and MP4) are supported, making it easy to create your own screens.

* : Motion image manual playback is for the GT16 only.

<See pages 30 and 45 for details of the functions.>

CASE 2

Quickly detect the cause of the problem to minimize production loss due to unexpected product failures

Before

Production failure!

There is no way to know which operation caused the problem...

- Checking the production data and timesheet information to specify the operator takes time.
- The operator's memory about the operation is too vague to identify the problem cause.

Who was working at that time? I don't remember.

What was being operated and how?

GOT Solution

What is the cause of the defective product?

You don't have to panic. The GOT will find the cause.

The operation log including the operator information is shown for analysis.

It is found that Jon Smith entered wrong data.

Root cause investigation by using the operator information and the operation records stored in the CF card
Operator Authentication function + Operation Log function

- In combination with the Operator Authentication function, the Operation Log function enables users to identify the problem cause in detail, such as who did which operation (e.g. key operation, data input) and entered what kind of data.
- If a defective product is produced due to an operation error, the operator and the operation contents are easily and quickly accessible.
- Operator log-on control by external authentication devices (RFID, fingerprint authentication) is also available. **Coming soon**

<For more details, see page 47 of this catalog.>

We can determine the cause of the error and this will be helpful in improving operations and preventing a recurrence.

CASE 3

Backup your sequence programs on the GOT. Keep your system safe in case of a PLC failure.

Before

PLC failed!

No battery!

I have to go back to the worksite right now!

I need to go to the warehouse to get another PLC!

I also need to go to the office to get a PC.

Where did we store the sequence program?

GOT Solution

Don't we need a PC?

The GOT backs up the sequence program.

Backup

In addition to a manual backup function, automatic backups are possible by using a trigger device or by specifying the time and day!

PLC failed!

No battery!

It is OK, because the latest program was stored in the GOT.

Change CPU. Restore

Speedy restorations! No need for PC and program searches.

PLC programs can be stored and written to the GOT without using a personal computer.
Backup/restoration function

- Sequence programs, parameters, comments, and file registers can be read and stored by GOT! (Backup function)
- Sequence programs saved on the GOT can easily be written to a new PLC! (Restore function)
- Backing up the latest data enables quick system restorations in the event of problems caused by battery failures or changes to new programs.
- Automatic backups are possible by using a trigger device or by specifying the time and day. Backups can be easily performed, for example at the end of a working day, or prior to weekends and other consecutive holidays.

<For more details, see page 48 of this catalog.>

CASE 4

Quick connection of third-party FA devices! Data exchange without using programs.

Before Connection of a temperature controller requires a dedicated unit and program. Extra cost and PLC burdens...

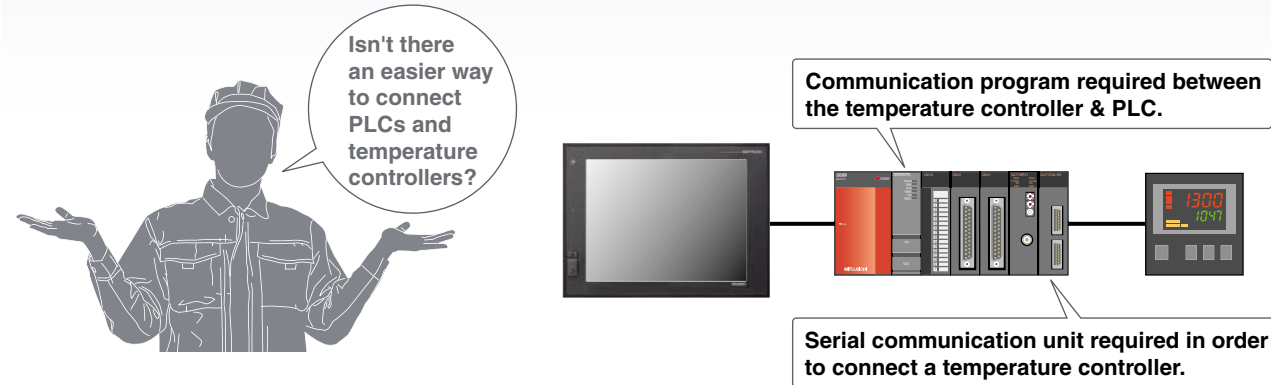

GOT Solution

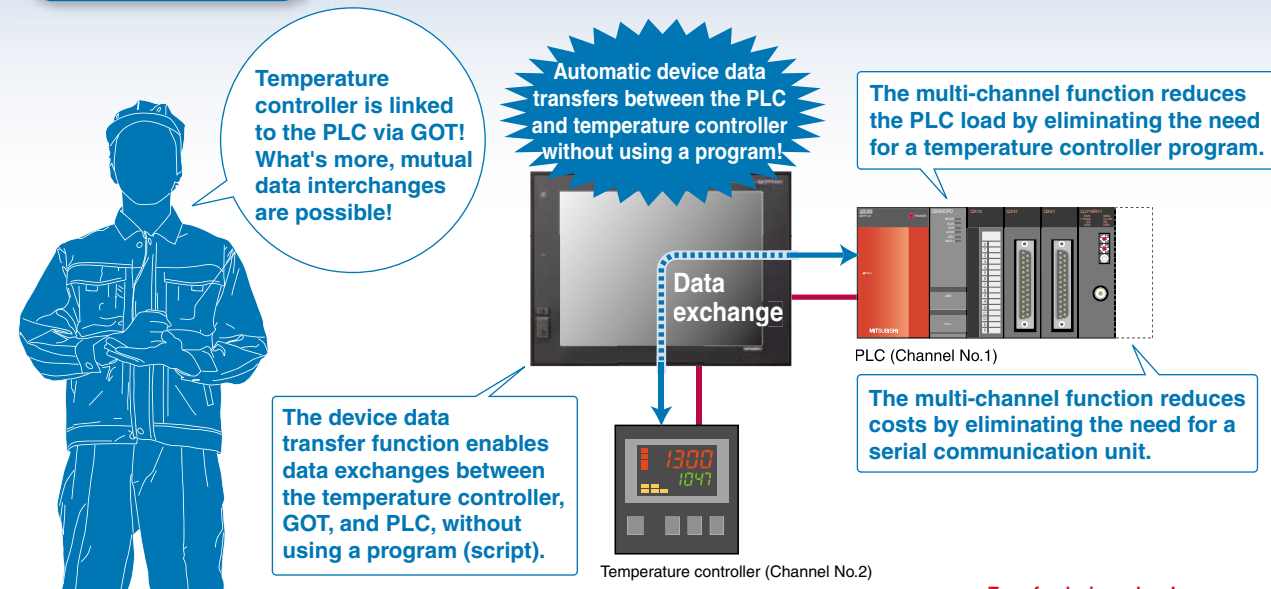

The PLC and temperature controller are easily linked via GOT!

GOT1000
GRAPHIC OPERATION TERMINAL

Multi-channel function + Device data transfer function

- With the multi-channel function, a single GOT unit can monitor up to 4 channels of FA devices.
- The device data transfer function can be set to read/write specified device values at specified times, or periodically!
- Simply specify the transfer source & destination devices, and the trigger in GT Designer2!

<For more details, see page 29 of this catalog.>

Transfer device values!

No.	Device Type	Points	Source Device	Destination Device
1	Special BN16	5	920-1 A0000	R1000
2			920-1 A0001	R1001
3			920-1 A0002	R1002
4			920-1 A0003	R1003
5			920-1 A0004	R1004

Temperature controller (Channel No.2) device, A0000 to A0004 values. Written to PLC (Channel No.1) device, at R1000 to R1004.

Device data transmission setting screen

CASE 5

Direct connection to I/O devices! Effectively reduces both costs and wiring.

Before In systems where the PLC and the operation panel are separated, connecting wires to the operation panel switches and lamps is troublesome...

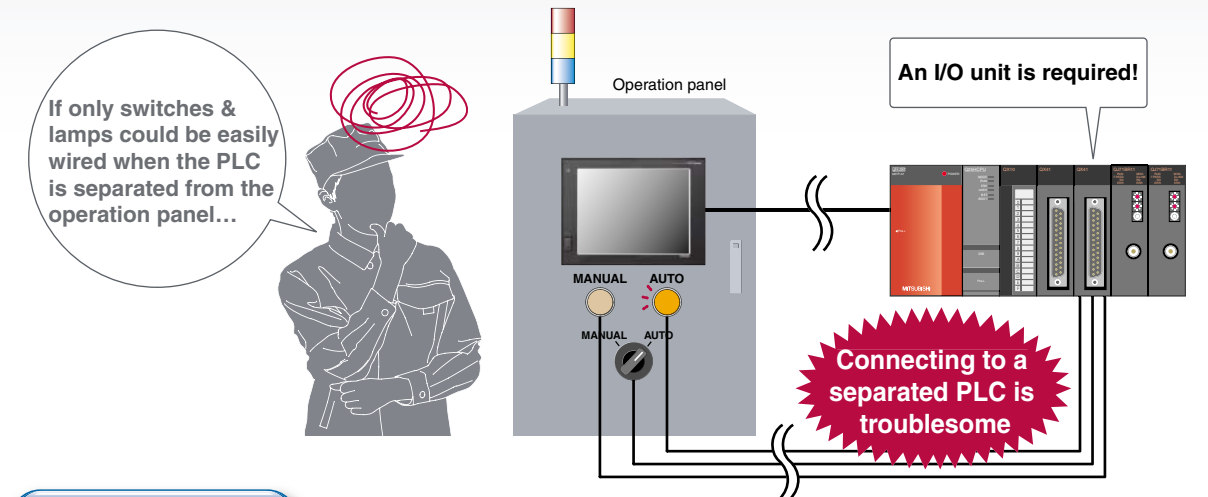

GOT Solution

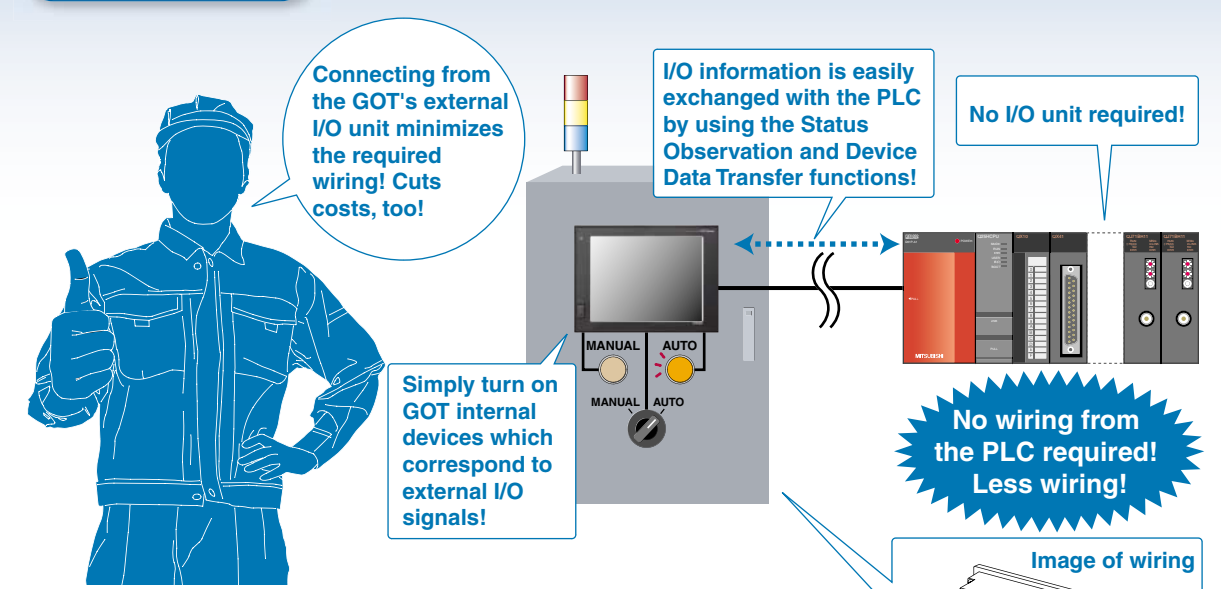

Less wiring is required with direct inputs/ outputs from the GOT!

GOT1000
GRAPHIC OPERATION TERMINAL

External I/O function

- Up to 128 input points (16 input points x 8 scan points), and 16 output points!
- The system can be simplified by connecting the GOT directly to the I/O device!

<For more details, see page 31 of this catalog.>

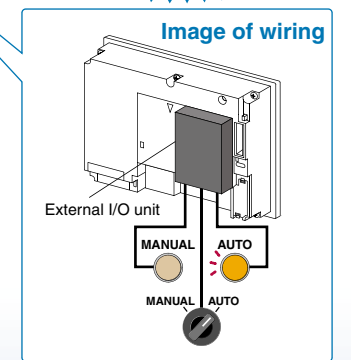

CASE 6

Smooth debugging even when the operation & control panels are separated.

Before Assuming a system in which the equipment is on the 1st floor and the control panel is on the 2nd floor in an electrical room, a debugging operation involving actual equipment operation is a major undertaking requiring several workers...

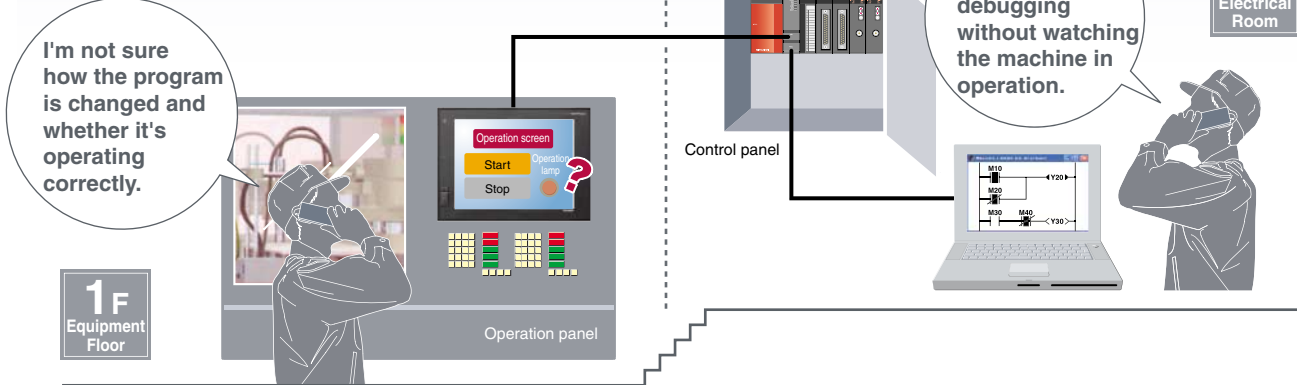

1F
Equipment
Floor

2F
Electrical
Room

GOT Solution

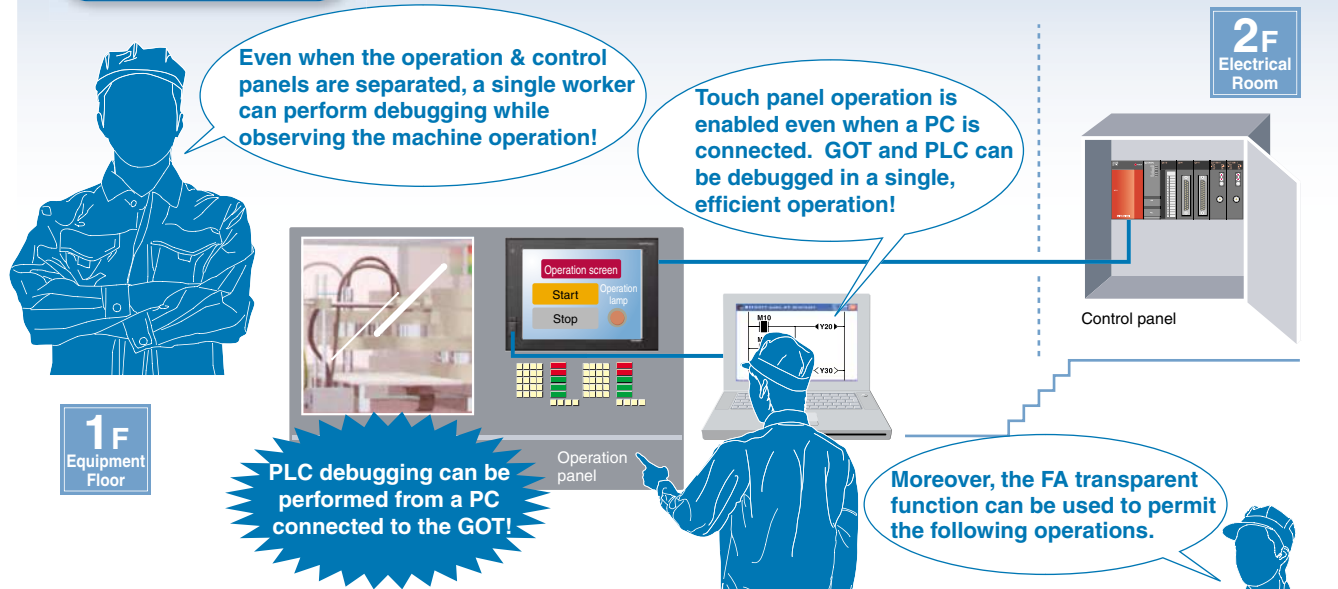

1F
Equipment
Floor

2F
Electrical
Room

PLC and PC can be connected via GOT.

GOT1000
GRAPHIC OPERATION TERMINAL

FA Transparent Function

- Programming and setup software can be operated via the GOT's front face USB port.
- Programming and setup of Mitsubishi PLCs, motion CPUs, inverters, servo amplifiers, and robot controllers **NEW** can be performed from the GOT's front face USB port.
- Bus connection and CPU direct connection formats are supported for GOT and PLC connections. Computer link connection is also supported.

<For more details, see page 43 of this catalog.>

Using the GX Developer and GOT Ladder Monitor simultaneously (e.g., a large GX Developer display at the Device Test screen, and a GOT display at the Ladder Monitor screen), permits debugging operations which are both efficient and easy to view. This is also a convenient way to check the linked operation of multiple programs.



CASE 7

SFC monitor function enables quick identification of line stop causes.

Before Because ladder program configurations vary from one program creator to another, they can be confusing when viewed by someone other than the creator...

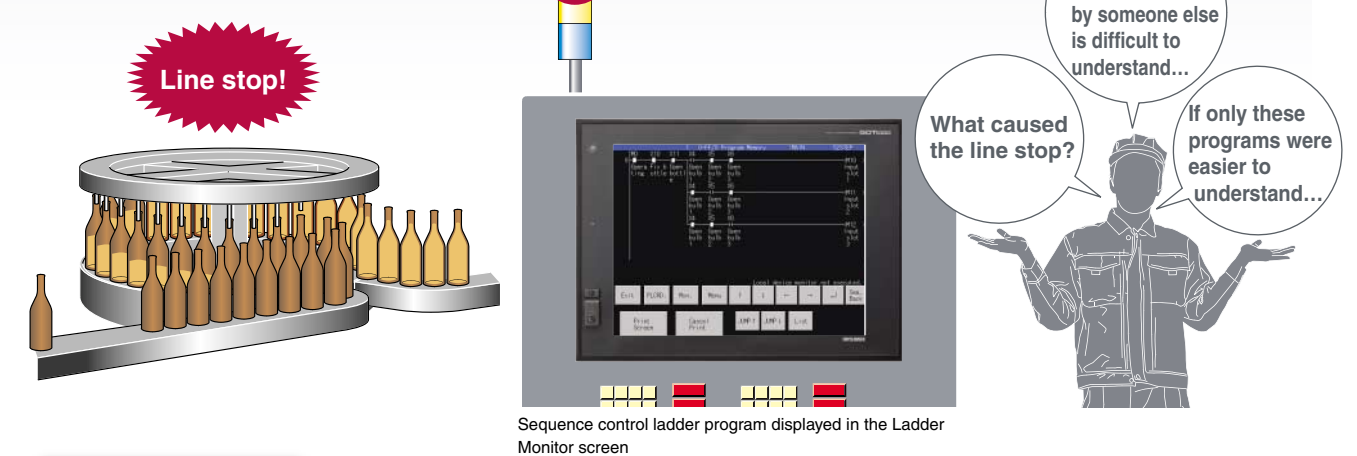

Sequence control ladder program displayed in the Ladder Monitor screen

GOT Solution

SFC programs are easily understood by anyone! Moreover, GOT's SFC monitor function allows the equipment operation status to be verified at a glance, even without a PC, thereby facilitating corrective actions!

SFC programs express the equipment operation sequences in a flowchart format, making them easy to create and understand, even when created by someone else.

* : These programs are created/edited in GX Developer.

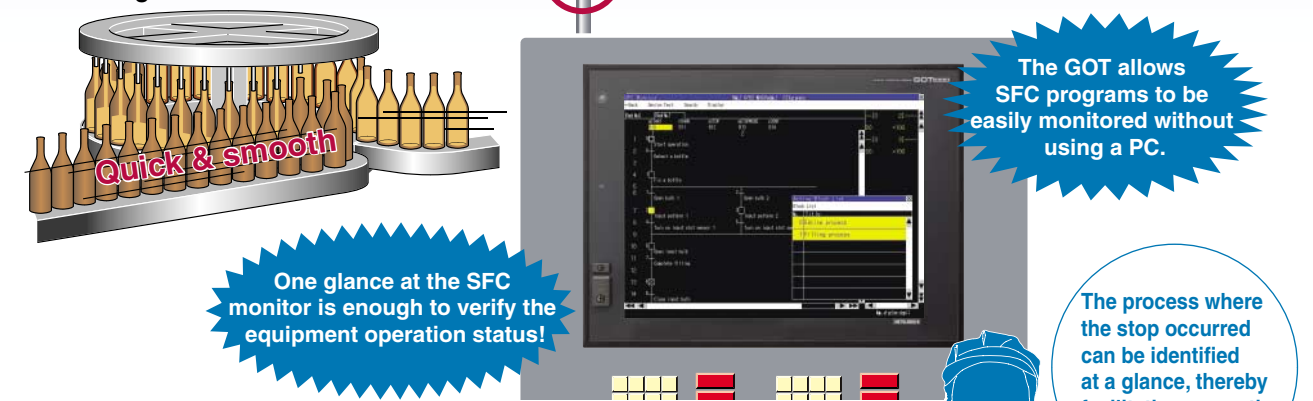

One glance at the SFC monitor is enough to verify the equipment operation status!

A visualized process format makes troubleshooting easy.

GOT1000
GRAPHIC OPERATION TERMINAL

SFC Monitor Function

- Mitsubishi Q-Series PLC SFC programs (MELSP3, MELSP-L) can be monitored on the GOT.
- SFC graphics allow the current process to be identified at a glance, for quick and efficient status verification.
- List displays such as block lists, step lists, and device lists are also possible.
- QnUD(E)(H)CPU is also supported. **NEW**

<For more details, see page 51 of this catalog.>

The process where the stop occurred can be identified at a glance, thereby facilitating corrective actions!

For a wide variety of applications, the GT11/GT10 fits all parts of the production line.

CASE 8

Portable handy type GOT expands machine design flexibility and increases work comfort.

Before In machine tool manufacturing, the position and layout of the operation panel for easy operation has been a problem.

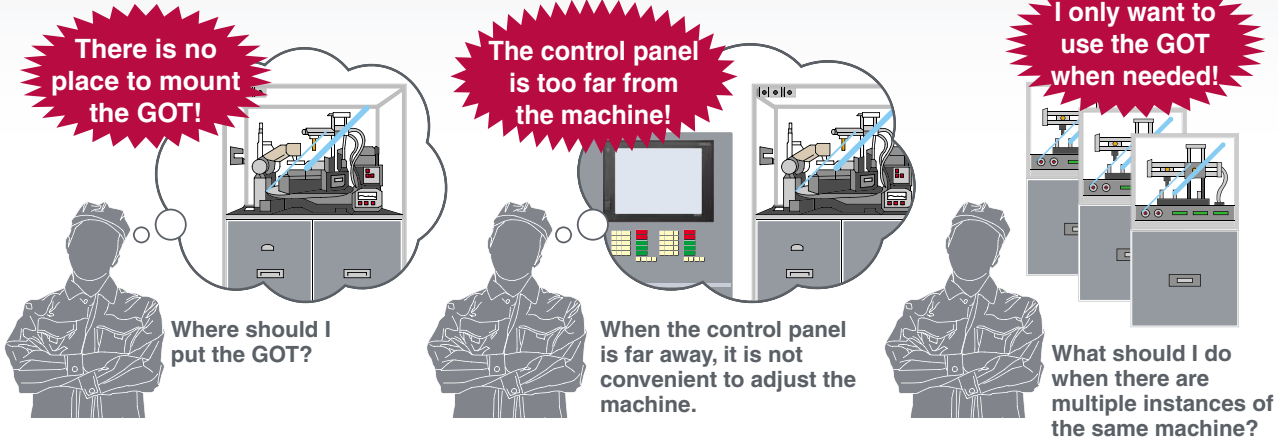

GOT Solution

Portable and wearable Handy terminals can be used in many ways.

Limitless installation possibilities

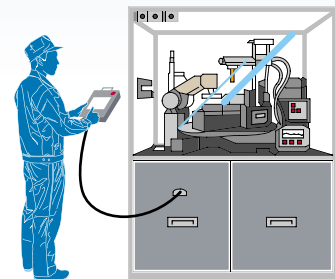

Small installation space. Operators can connect the GOT only when needed.

Operable from every direction

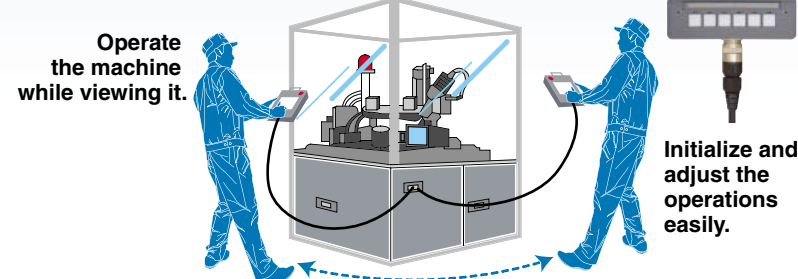

Take the GOT around only when needed

Easy to connect and disconnect. One GOT for two or more devices.

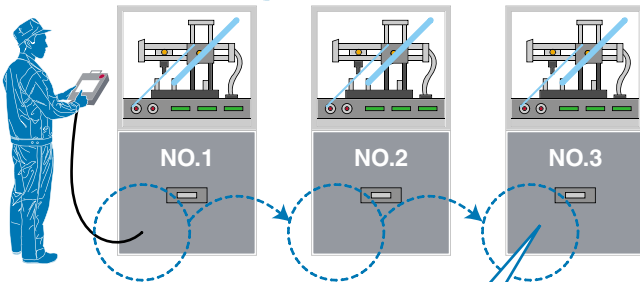

Easy to carry, easy to mount. The possibilities are endless.

Handy GOT



- Minimum mounting space required for handy terminal.
- Possible to use a single GOT to operate multiple machines by connecting the GOT to the machines one by one.
- Easy to initialize and adjust machine tools. The portable handy GOT can be used from different positions around the machine.

<For more details of functions, see page 57 of this catalog.>



CASE 9

Extremely compact size expands the effectiveness of the GOT1000 series

Before Hardware switches and lamps take up space on the control panel, and it takes a lot of effort to change the layout and wiring when specifications are changed.

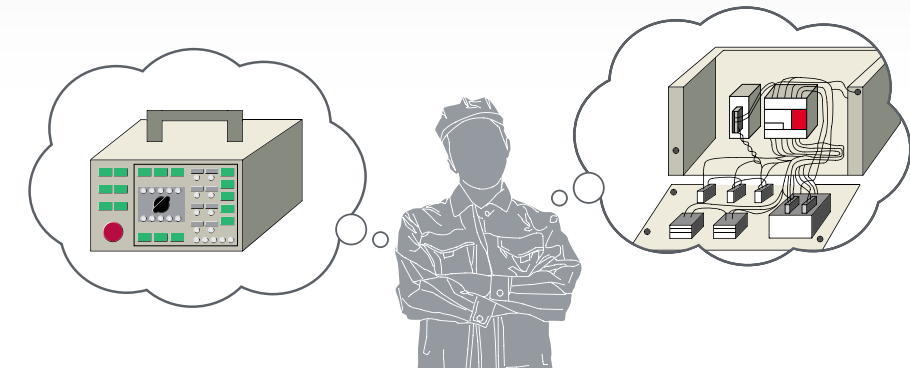

GOT Solution

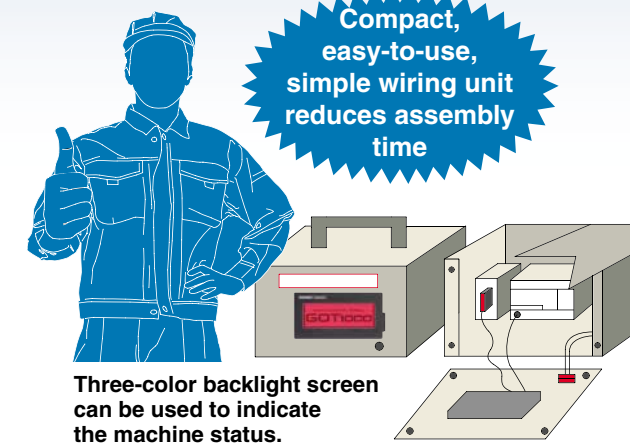

Both horizontal and vertical mounting available to meet the needs of different applications.



For simple and small applications, GOT1000 is just right.

GT10 models (GT1020/GT1030)

■ Highly flexible GOT screen layout with bright, clear 3-color indication

Compact, readable display <GT1020 3.7" type>



Clear, sharp, wide display <GT1030 4.5" type>

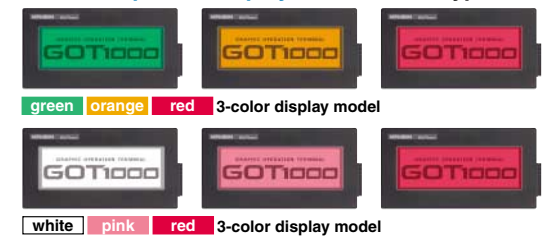

The white frame type is now available for GT1020/GT1030! **NEW**



<For more details of functions, see pages 52 to 56 of this catalog.>

GOT1000 provides a variety of functions to satisfy user requirements

Usability depends on who the users are and where they carry out their tasks.

Designers want to use the most advanced HMI technology, while maintenance engineers want the safest HMI for their facilities.

To satisfy all of our customers, we are constantly developing more and more functions for the GOT1000.

INDEX

For Designers P24

For Operators P42

For Initial Startup & Adjustment Operators P43

For Maintenance Personnel P44

GT10 P52

Handy GOT P57

GT SoftGOT1000 Version2 P58

iQ Platform P60

MELSEC Process Control + GOT1000 P61

List of Connectable Models P62

Specifications P67

External Dimensions P73

Notes for Use P77

Function List P82

Product List P86

Warranty P93

There are many different applications to be solved.
How do we stay flexible?

For designers

- Comment groups P24
- Automatic length adjustment of comment group labels P24
- Comment groups for switch/lamp labels and alarm history comments P24
- Multilingual support P25
- Script function P25
- Increased memory capacity P26
- Component layering (Layer function) P26
- Transparent bitmap figures P26
- Overlap window extension P26
- Advanced recipe function P27
- Wide selection of connectable FA devices and peripherals P28
- Multi-channel function P29
- Device data transfer function P29
- Multimedia function P30
- For Video/RGB P30
- CF card unit/CF card extension unit P31
- Sound output function P31
- Remote personal computer operation function P31
- External I/O function P31
- Gateway function P32
- MES interface function P33
- GT Designer2 Version2 P34
- GT Converter2 Version2 P38
- GT Simulator2 Version2 P41

In addition to a clear, easy-to-read display,
we make stress-free operation a priority.

For operators

- Drawing, computing, communication; a trio of high-speed response functions P42
- Dialog window function P42
- Display in different world languages P42

Efficiency requires both fast data transfer as well as user-friendly functions.

For initial startup & adjustment operators

- Equipped with front USB interface P43
- FA transparent function P43

To restore a system as quickly as possible,
response capabilities for "just in case"
situations is the key to selecting a HMI display.

For maintenance personnel

- Advanced alarm P44
- Document display function P45
- Batch self check function P45
- Logging function P46
- Historical trend graph P46
- Operator authentication function P47
- Operation log function P47
- Backup/restoration function P48
- Color-coded front face LED P48
- Maintenance time notification function P48
- List editor for A/List editor for FX P48
- System monitor function P49
- Q series motion monitor function P49
- Intelligent unit monitor function P49
- Network monitor function P49
- Servo amplifier monitor function P49
- CNC monitor function / CNC data I/O function P49
- Ladder monitor function P50
- SFC monitor function P51



The functions bearing these marks are available on the GT16/GT15 model only. All other functions are supported by GT16, GT15, GT11 models.

Efficient input of extensive comment data

GOT1000 GRAPHIC OPERATION TERMINAL

Comment groups

- CSV/Unicode text format files can be imported. Multiple files can also be imported to individual comment groups, allowing the comment input task to be distributed among several workers, greatly reducing the required input time.
- GT Designer2 allows easy column and line insertions and comment No. changes similar to those offered by Microsoft® Excel.

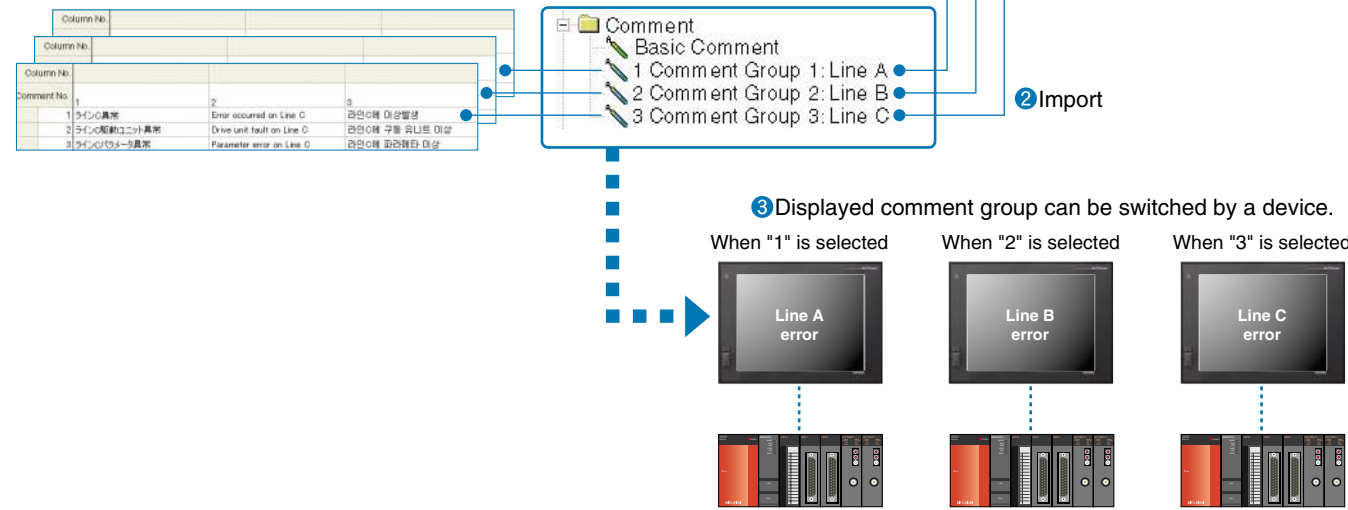

No need to adjust character string length

GOT1000 GRAPHIC OPERATION TERMINAL

Automatic length adjustment of comment group labels

- Automatically adjusts character size and inserts line feeds according to the object size.
- <Supported objects>
 - Touch switches or lamps where "comment group" is selected for labels
 - Comment displays where "comment group" is used



When switching languages, character string length is automatically adjusted to fit within the object.

Easy-to-create language switching screens

GOT1000 GRAPHIC OPERATION TERMINAL

Comment groups for switch/lamp labels and alarm history comments.

- Comment groups can be used for alarm history comments.
- Comment groups can be used to display label names on touch switches and lamps.
- <Supported objects>
 - Touch switches, lamps, alarm history, comment display, advanced alarm

Example of touch-switch label usage

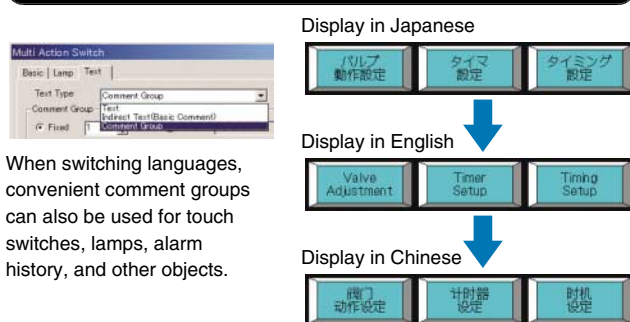

Easy creation of multilingual screens

GOT1000 GRAPHIC OPERATION TERMINAL

Multilingual support

- Different language comments can be created for each comment group column to switch the display language.
- Comment group comments can be created freely for applications, as well as for different languages.
- You can specify the column number of the comment group to change the language of the startup message on the GOT. **NEW**
- * : For details, see "Comment groups" (page 24).

Convenient for language switching

When stroke fonts are used with switching languages for touch switches, lamps or comment displays, the character size is automatically adjusted by the size of the object. There is no need to adjust the size of the object when creating a multi-language screen.

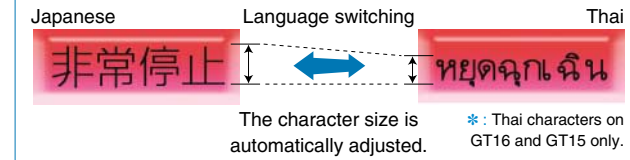

For better work efficiency and enhanced customization functions

GOT1000 GRAPHIC OPERATION TERMINAL

Script function

Project script/screen script

- Controlling GOT display by using GOT scripts can reduce the load on PLCs (PLC CPU, microcomputer, etc.) dramatically.
- Capable of executing a script file including multiple data formats, such as integers and real numbers, within one script. (Data format conversion function)
- Enables reading of device values from or writing values to a file freely with file operation functions (such as creating, deleting, opening, closing, reading and writing files).

Input support function makes it easy to specify functions and properties, thereby preventing spelling errors and reducing the time to look up control statements.

GT Designer2 script editor screen

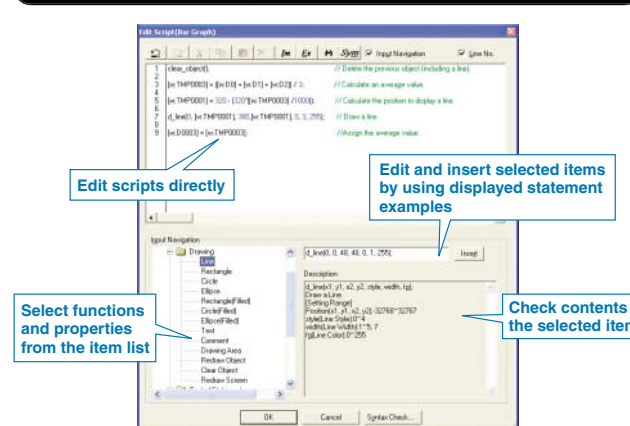

Users can quickly change the language display.

GOT1000 GRAPHIC OPERATION TERMINAL

Example of switching between Japanese, English, and Korean screens

Column No.			
Comment No.	1	2	3
	1 メニュー	Menu	메뉴
	2 タイミング設定	Timing Setup	시간설정

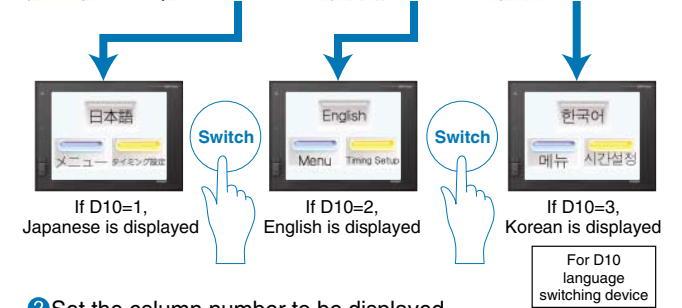

- 1 Create Japanese, English, and Korean comments in their respective columns.
- 2 Set the column number to be displayed within the language switching device.
- 3 The displayed comment (language) changes.

Object script (For GT16 and GT15 only)

- Drawing and display control functions can be specified for every object, allowing objects to be easily used in other projects.
- Scripts make screen display control highly flexible by changing properties (colors and display positions) and making the object design process flexible. <Patent pending>
- Capable of referring to the height and width of an object using the property (display attribute). This increases drawing control flexibility when using drawing functions. **NEW**

Example of how to use object scripts (draw straight line on graph display)

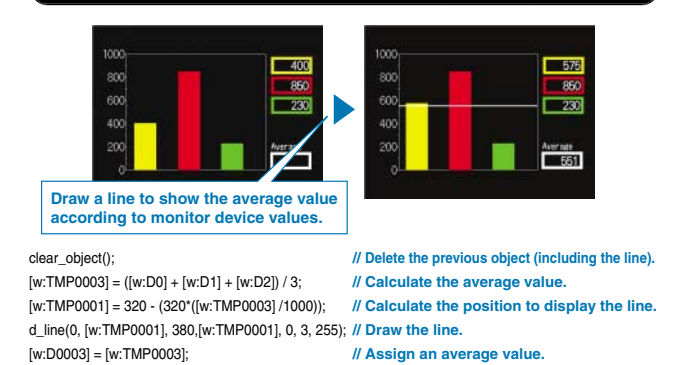

Improved usability provides designers with more comfortable and flexible screen design options

For designers

Designing and using functions without memory capacity limitations

GOT1000 GRAPHIC OPERATION TERMINAL

Increased memory capacity

- The GT16 has increased the user area (built-in flash memory: ROM) to 15MB as a standard feature, enabling operation of many optional functions at the same time. **NEW**

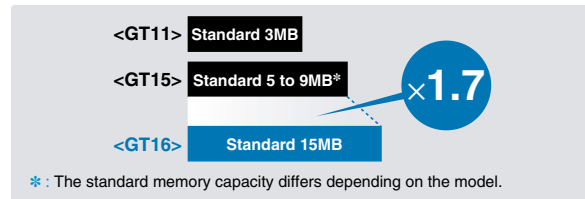

*: For more details about the memory capacity, see "Notes for use" (page 78).

An optional device may be necessary. For details, see "Selection of optional units and devices" (page 77).

Increased flexibility in designing screens

GOT1000 GRAPHIC OPERATION TERMINAL

Component layering (Layer function)

- Component (object, figures) layering increases the flexibility of design.

- The GT16 has an operation memory (RAM) of 57MB as a standard feature. Up to 57MB is available for use without an optional function board. **NEW**
- When the total of project data, optional function operating systems and other data exceeds the user area (built-in flash memory capacity), the GT16 and GT15 store the project data in a CF card to extend the user area up to 57MB.

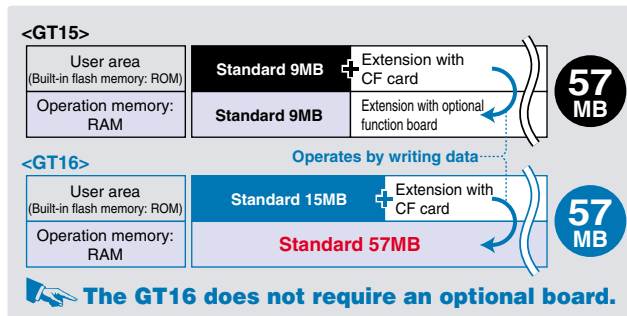

Layer graphs

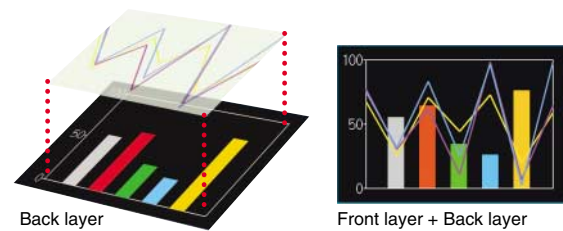

Improved expressiveness in screen design

GOT1000 GRAPHIC OPERATION TERMINAL

Transparent bitmap figures

- Designers can specify a transparent color for bitmap data.
- Since the background of figures (not limited to rectangle) can be made transparent, the expressiveness of screen design is widely expanded.

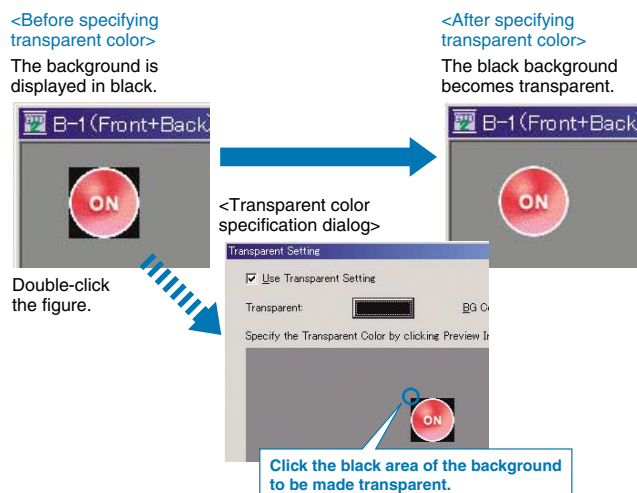

Up to five windows appear on the screen. For designing screens flexibly and effectively

GOT1000 GRAPHIC OPERATION TERMINAL

Overlap window extension

- Displaying up to 5 overlapped windows on the screen at one time. (Up to 2 for models other than the GT16)
- More information appears simultaneously on the screen, improving flexibility in screen design.

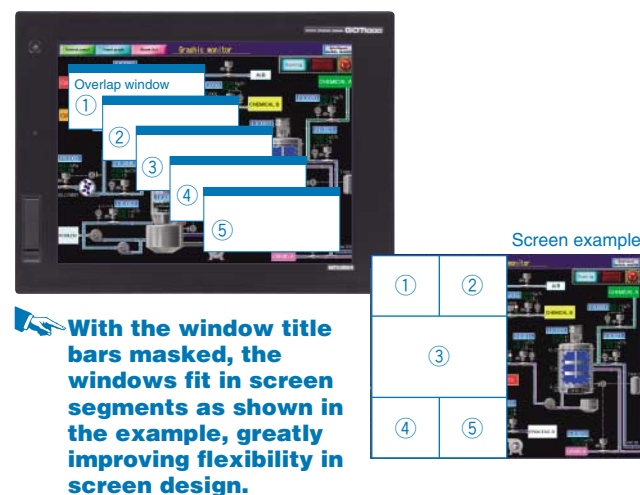

Simplify complicated production setup with the GOT

For designers

Simple process of creating complicated recipe data

GOT1000 GRAPHIC OPERATION TERMINAL

Advanced recipe function

This function allows material combination data and processing conditions data (device values) to be held in the GOT, with only the required data being written to and read from the PLC.

Extensive number of recipe files, device points, and record points

- Greatly expanded capacity permits up to 2,048 recipe files and 32,767 device points.
- Up to 2,000 types of device values can be handled by a single advanced recipe setting file.

Flexible recipe data can now be created.

- Flexible recipe data can be created by combining advanced recipe settings and records.
- Reading/writing is performed by specifying the recipe No. and record No., eliminating the need for a trigger device for each file. This reduces the number of devices, and permits trigger device concentration. *1
- Because devices also permit bit and word combinations and arbitrary device settings, there is no need to centralize the sequential devices used, thereby reducing the total number of device points used.
- Advanced recipe files can be converted into CSV or Unicode format text files, and can be edited on a personal computer. *2

*1: The "recipe No. saving device," "record No. saving device," and the "external control device" can be specified in the advanced recipe common settings in GT Designer2. (These settings are required when using Advanced Recipe) After values are saved to every device, reading and writing of the recipe data is enabled in accordance with the ON/OFF status of the external control device. (It is also possible to specify a trigger device for reading/writing each advanced recipe setting)

- Up to 2,048 blocks can be used, each block comprises of sequential word devices, an arbitrary word device (1 point), and a bit device (1 point).

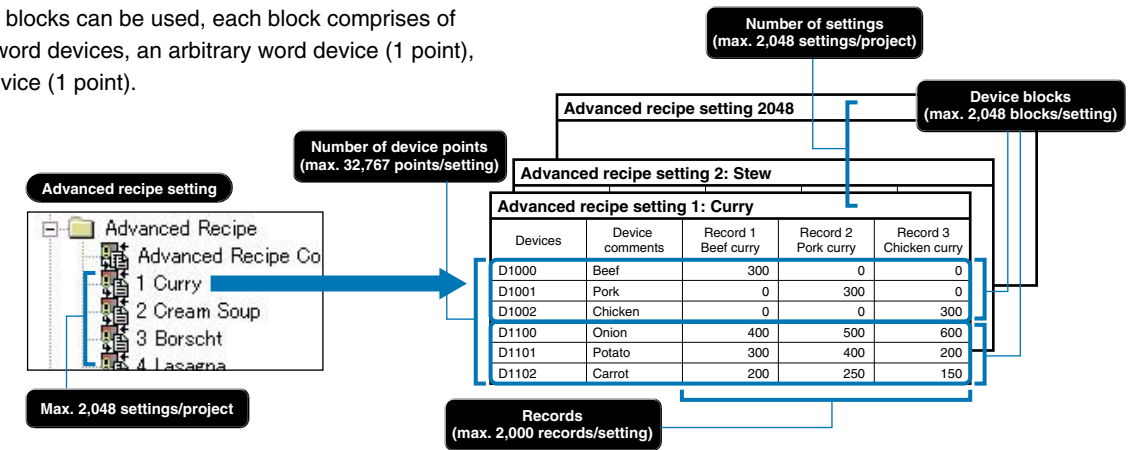

Easy handling of recipe data using the GOT

- Recipes can be handled easily by the GOT's utility function without having to create a recipe operation screen.
- The utility function permits the following operations: folder create/delete, advanced recipe file copy/delete/rename, record write/read/consistency check.

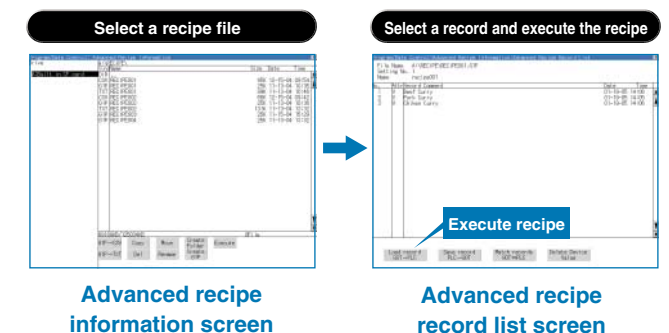

For Designers

For Operators

For Initial Startup & Adjustment Operators

For Maintenance Personnel

GT10

Handy GOT

GT-Soft GOT1000

Version2

IQ Platform

ME/SEC Process Control + GOT1000

List of Connectable Models etc.

26

Continuously expanding connectable devices and models

GOT1000 GRAPHIC OPERATION TERMINAL

Wide selection of connectable FA devices and peripherals

PLCs

- A wide array of device models / types are now connectable. **NEW**
- Mitsubishi MELSEC FX series: FX3G • PLCs made by LS Industrial Systems.
- Mitsubishi MELSEC-Q series: Compatible with QCPU having built-in Ethernet port (QnUDE(H)CPU).
- The GT16 series models are equipped with an Ethernet interface as a standard feature. When connecting to QCPU with built-in Ethernet port (QnUDE(H)CPU), neither the PLC nor the GOT requires an Ethernet unit. This makes system configuration simple and easy.
- Mitsubishi MELSEC process control: Compatible with medium-size process CPUs (Q02PHCPU and Q06PHCPU).

Microcomputers

- Supported protocol
- Mitsubishi Q/QnA/A computer link unit (8 types)
- GOT-A900 series compatible (2 types)
- GOT-F900 series compatible (2 types)
- Digital Electronics (Proface) memory link format (3 types)

Temperature controllers

- Connectable models and types are expanded. **NEW**
- Shinko Technos: PCD-300 series • RKC Instrument: CB series
- Shinko Technos: Connection through RS-485 with ACS-13A/DCL-33A/JC/JCM-33A/PC-900/JIR-301-M series
- Data logging, parameter setting, and alarm display for temperature controllers are possible.

Mitsubishi CNCs

- When the C70 CNC is connected, the CNC data I/O function can be used to copy and delete work programs and parameters, etc.

*: For CNC data I/O function details, see "CNC monitor function / CNC data I/O function" (page 49).

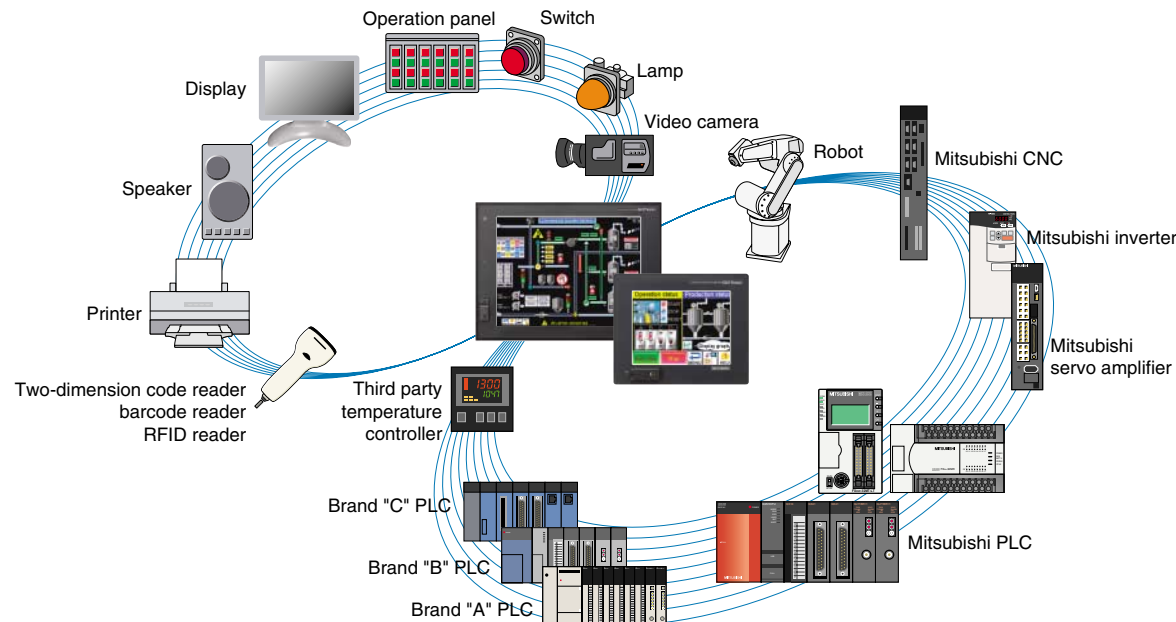

Mitsubishi servo amplifiers

- MR-J3-□T and MR-J2S-□CP point tables can be edited. Positioning information is easily edited by connecting a GOT to the servo amplifier.

- Users can create parameter settings, alarm displays, and test operation screens. There is no need to create screens to use the servo amplifier monitor function.

*: For more details on the servo amplifier monitor function, see "Servo amplifier monitor function" (page 49).

Mitsubishi inverters

- Up to 10 inverters can be connected in multi-drop connection with capabilities of parameter setting and alarm display.

Mitsubishi industrial robots

- Connection to robot controllers is now possible.
- CRnQ-700 series • CRnD-700 series

Other peripheral devices

- External devices (operation panels, switches, lamps, and relays)
- Speakers • Video cameras • Displays (RGB output)
- Personal computers (RGB input) • Printers
- The latest PictBridge printers can be connected with a USB cable.
- Print GOT screens (Hardcopy function) and output production results (Report function) when an error occurs.
- Two-dimensional code readers and barcode readers
- RFID reader

*: Connectable models and usable functions vary depending on the GOT main unit. For more details, see "List of connectable models" (page 62), "Notes for use" (page 77) and "Function list" (page 82).



Central storage of FA device information on a single GOT terminal

GT16 GT15

GOT1000 GRAPHIC OPERATION TERMINAL

Multi-channel function

- Monitor up to 4 channels of FA devices (e.g. PLCs, servos, inverters, and temperature controllers).
- Monitor all FA devices on a single screen on the GOT. The monitor screen can be flexibly designed.

- The GT15 supports multi-channel connection by using the standard RS-232 interface and communication units simultaneously.
- Using the standard feature of Ethernet interface, the GT16 can simultaneously monitor up to four types of PLCs of different manufacturers. **NEW**
- Using the built-in interfaces (Ethernet, RS-422/485, and RS-232), the GT16 can connect with up to four types of FA equipment without an optional communication unit. **NEW**

➡ The GT16 enables multi-channel connection without a communication unit!

Typical applications

Third party PLCs via Ethernet **NEW**

GT16

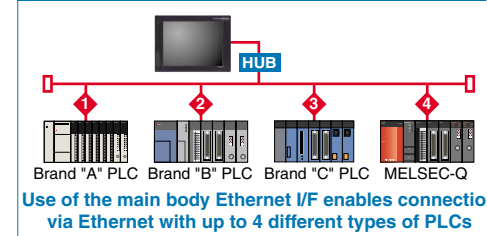

Third party PLCs

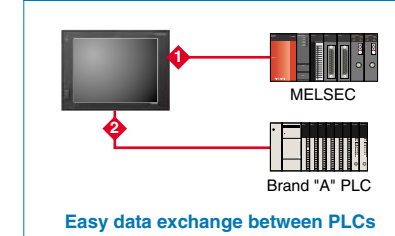

MELSERVO + Microcomputer

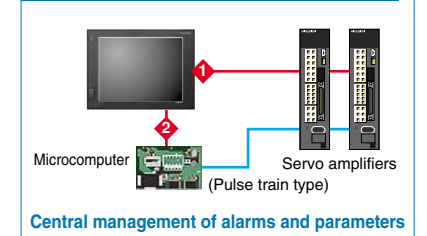

PLC + Temperature controller + Inverter

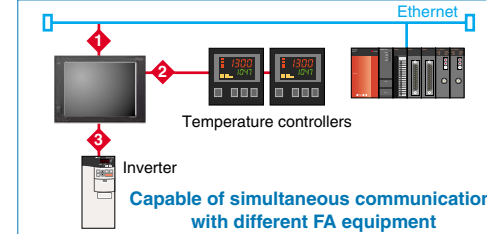

Stand-alone PLCs (FX, or third party PLCs) + MELSECNET/H

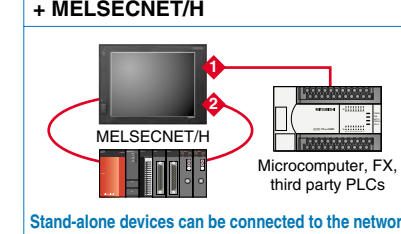

MELSEC + Third party temperature controllers

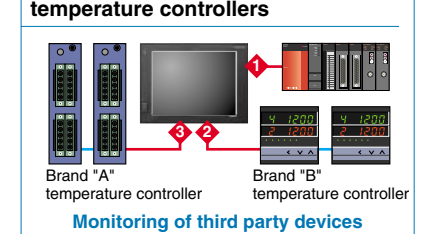

*: For the Ethernet connection of the GT16, if the GT16 is connected to equipment compatible with 10BASE(-T/2/5), use a switching hub for its operation in a network environment where both 10Mbps and 100Mbps systems are operable.

*: The number of channels and functions, which can be used with the multi-channel function, vary depending on the connection configuration. For more details, see "Notes for use" (page 77).

An optional device may be necessary. For details, see "Selection of optional units and devices" (page 77).

Greater control flexibility for system applications

GT16 GT15

GOT1000 GRAPHIC OPERATION TERMINAL

Device data transfer function

- Device values from FA devices connected to GOT can easily be transmitted to GOT's internal device. Also, the multi-channel function can be used for easy mutual data transfer between multiple FA equipment.

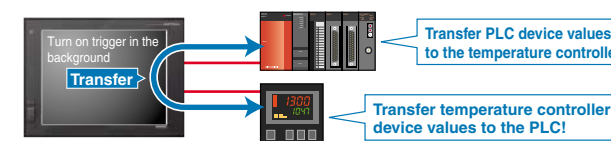

- Data transfer timing can be set periodically or can be set by a trigger device, enabling control of various applications.
- Easily specify the transfer source, transfer destination, and the trigger in GT Designer2.

Transfer device values!

Temperature controller (Channel No.2) device, A0000 to A0004 values. Written to PLC (Channel No.1) device, at R1000 to R1004.

No.	Device Type	Points	Source Device	Destination Device
1	Signed BIN16	5	@20-1 A0000	R1000
2			@20-1 A0001	R1001
3			@20-1 A0002	R1002
4			@20-1 A0003	R1003
5			@20-1 A0004	R1004

Device data transmission setting screen

Smooth, high-quality motion images helps efficiently investigate the cause of a problem
 GT1000 GRAPHIC OPERATION TERMINAL
Multimedia function

<Recording video images>

- VGA (640 × 480) and QVGA (320 × 240) are available for selection of image recording.
- The recording frame rate is maximum 30fps for QVGA and maximum 15fps for VGA, enabling to record smooth, natural motion images.
- Saves recorded motion image files on the multimedia CF card. By using the gateway function (FTP) and the multimedia data link tool, files can be transmitted to the server personal computer.

* : The GOT main body needs a CF card to transmit motion image files to a personal computer.

Images are recorded and played back on the dedicated multimedia screen, reducing the time spent designing screens.



<Recording pre/post event motion images>

- Capable of recording motion images for 120 seconds each before and after an error occurrence (with the event trigger device turned on), up to 240 seconds in total. The motion images tell you all about the conditions before and after the error occurrence.

Saves a motion image file of up to 240 seconds.



An optional device may be necessary. For details, see "Selection of optional units and devices" (page 77).

The multimedia data link tool is a multimedia-dedicated software program coming with GT Works2 / GT Designer2.

High-quality images with 65,536 colors provide precise detail
 GT1000 GRAPHIC OPERATION TERMINAL
For Video/RGB

Enhanced compatibility with cameras and inspection devices <Video input>

- Input images from up to four video cameras and inspection devices are simultaneously and precisely displayed on four windows in 65,536 colors. Images can be saved in JPEG format.
- Since a video window can be placed anywhere on the screen the screen flexibility is improved.
- A simple one-touch operation allows users to switch the display size. (100%, 50%, 25%)

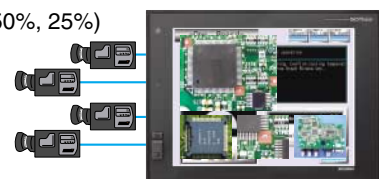

An optional device may be necessary. For details, see "Selection of optional units and devices" (page 77).

<Playing back motion image files>

- The GOT or a personal computer can play back motion image files recorded at a worksite. Checking the motion images before and after an error enables to detect the cause of a problem quickly.

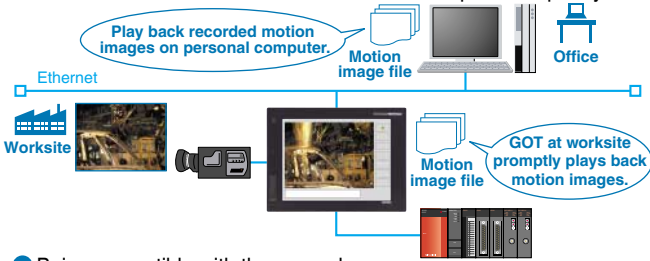

- Being compatible with the general-purpose formats, the GOT plays back motion images edited on a personal computer, which is a convenient function to create documents such as an instruction manual with motion images.

<Applicable software programs> • QuickTime 7 Pro
<Compatible file formats> • 3GP and MP4

Very general-purpose because of the capability of handling motion image data created by a commercially available software program.

* : Only one of the following devices can be used at a time; multimedia unit, video input unit, RGB input unit, video/RGB input unit or RGB output unit.

Displays PC images on GOT <RGB input>

- PC images of either XGA (1024 × 768 dots), SVGA (800 × 600 dots) or VGA (640 × 480 dots) can be displayed at the same time as the GOT monitor screen. (XGA is for the GT1695M only.)
- Up to two channels can be used when handling RGB input. One GOT unit can conveniently switch between two personal computers or between the images on a personal computer and a vision sensor. (Only when using the GT16 M-R2.)

An optional device may be necessary. For details, see "Selection of optional units and devices" (page 77).

Display the GOT screen on a display <RGB output>

- Connect to a commercial display so that the GOT screen can be displayed larger.
- An optional device may be necessary. For details, see "Selection of optional units and devices" (page 77).
- * : Only the GT1585V and GT1575V for the GT15 series. Only one of the following devices can be used at a time; video input unit, RGB input unit, video/RGB input unit, or RGB output unit.
- * : Only one of the following devices can be used on the GT16 at a time; video input unit, RGB input unit, video/RGB input unit, RGB output unit, or multimedia unit.

Additional CF card unit for more convenient use
 GT1000 GRAPHIC OPERATION TERMINAL
CF card unit/CF card extension unit

- The standard CF card interface unit (A drive) and the optional CF card interface unit (B drive) can be used for separate purposes.

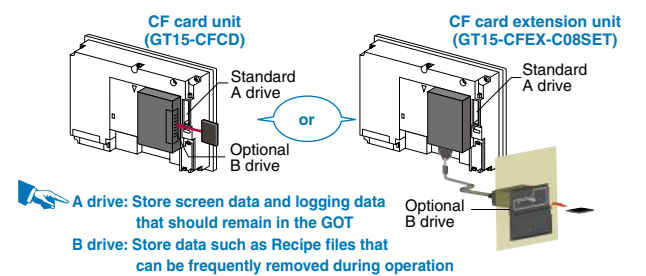

* : Either the CF card unit or the CF card extension unit can be used at a time.

- Using the new CF card extension unit attached to the front face of a panel, operators can insert/remove a CF card without opening the control panel. This greatly improves the machine operability.

An optional device may be necessary. For details, see "Selection of optional units and devices" (page 77).

Touch-operating, the GOT enables personal computer operation
 GT1000 GRAPHIC OPERATION TERMINAL
Remote personal computer operation function

- When using RGB input, touch-operating the GOT can operate the personal computer screen displayed on the GOT (e.g. store the information such as touched coordinates in GOT internal devices, transmit the data to a personal computer).

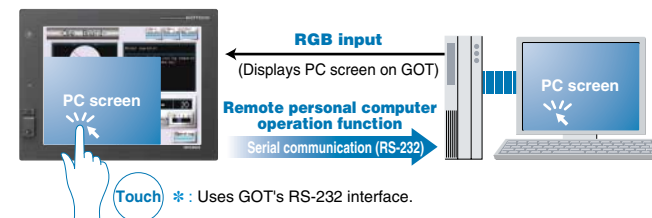

Compatible Windows OS Windows® XP Professional SP2, Windows® XP Home Edition SP2, Windows® 2000 Professional SP4

* : Supported only on the GT1585V and GT1575V models in the GT15 series.

An optional device may be necessary. For details, see "Selection of optional units and devices" (page 77).

External notification of touch status (GT16/GT15/GT11)

- The information such as coordinates touched and whether touched or not is stored in GOT internal devices.
- Applicable in various ways of use when combined with other functions.

(Example) Combined with the parts move function, a part object moves to the position touched.

Sound notification of alarms
 GT1000 GRAPHIC OPERATION TERMINAL
Sound output function

- By connecting a speaker, the GOT can play WAV sound files (8kHz, 16bit mono) synchronized with device operation.
- Synchronized with alarms, audio error notifications quickly notify operators of problems.

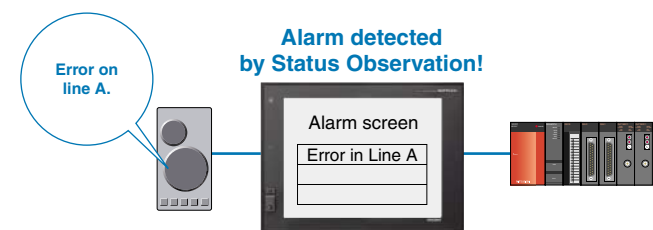

* : A speaker with a built-in amplifier must be used. (Compatible jack: f3.5 stereo mini-jack, straight type)

An optional device may be necessary. For details, see "Selection of optional units and devices" (page 77).

Direct connection to I/O devices simplifies your system
 GT1000 GRAPHIC OPERATION TERMINAL
External I/O function

- Connecting various I/O devices (e.g. hard switches, lamps, sensors, relays) directly to the GOT can reduce PLC I/O connections and wiring in order to reduce the cost of your system.
- A user-created operation panel can be connected to use Numerical Input and ASCII Input without displaying key windows on the GOT screen.
- In addition to the positive-common input/sink type output unit, a negative-common/source type output unit is now available on the market.

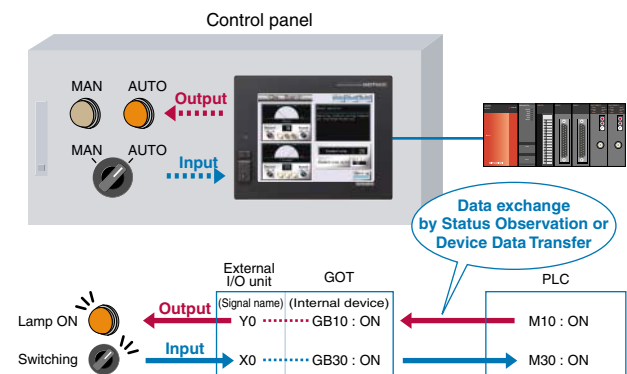

* : An internal device is assigned to a signal in advance.

<Input: Max. 128 device points (16 input points × 8 scanning points = 128 points), Output: Max. 16 points>

An optional device may be necessary. For details, see "Selection of optional units and devices" (page 77).

For Designers
 For Operators
 For Initial Startup & Adjustment Operators
 For Maintenance Personnel
 GT10
 Handy GOT
 GT-SoftGOT1000 Version2
 I/O Platform
 MELSEC Process Control + GOT1000
 List of Connectable Models etc.

Transfers operation data in production lines in real time to host information systems. Sophisticated information link improves productivity.



Be alerted to worksite errors and collect device data from an office desk GT 16 GT 15
GOT1000 GRAPHIC OPERATION TERMINAL
Gateway function

The gateway function remotely monitors the worksite and supports remote maintenance from the office.

1 Collect data on a personal computer (server function)

- A GOT (server) can be monitored from the host personal computer (MX Component) to perform indirect reading/writing of connected devices being monitored by the GOT.
 - Even when monitoring third party devices, the server function can be used to perform reading/writing with the MX Component alone.
- * : The collected data can be displayed and analyzed by Excel without using any programs other than MX sheet. Programming Visual C++ and Visual Basic enables applications to be flexibly designed and built.

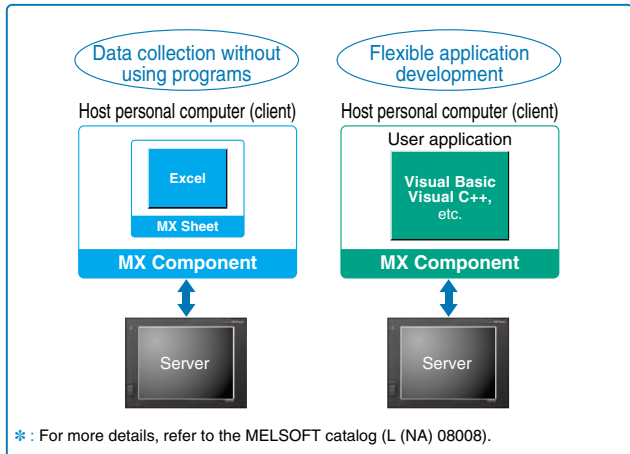

* : For more details, refer to the MELSOFT catalog (L (NA) 08008).



2 Monitor other GOTs from a GOT (client function)

- A GOT (client) indirectly reads/writes device values of equipment monitored by the GOT (server).
- The client function can also be used to indirectly read/write device values of PLC CPUs other than the one to which the GOT (client) is connected.
- Communication is possible between a GOT1000 and a GOT-A900.

3 Direct check/edit of data in CF card (FTP server function)

- Files in the CF card within the GOT (e.g. alarms, recipes, and hard copies) can be directly read and written from a personal computer.
- No need to visit all factories to collect CF cards from all GOTs when there are multiple GOTs or when a GOT is located far away from the personal computer.

4 Mail send function

- The alarm history display function can transmit alarm occurrences and recovery information by e-mail to personal computers and mobile phones.
- Error information can be checked from locations far away from the worksite.

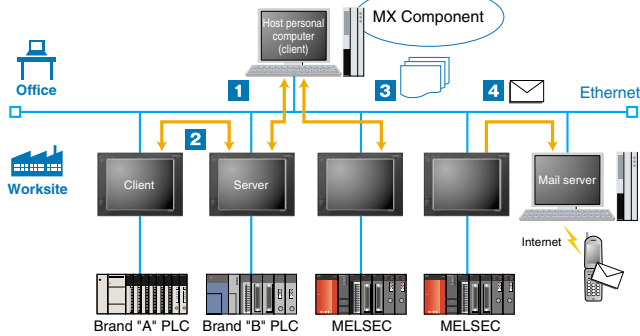

Database linkage supports enhances productivity at your worksite GT 16 GT 15
GOT1000 GRAPHIC OPERATION TERMINAL
MES interface function

The GOT transmits data from connected FA devices to the server personal computer database via SQL statements.

- For communication with the database, just specify the necessary data in GT Designer2 without programming. There is no need to use a gateway personal computer and complicated programs to communicate with the MES database server.
- If an error occurs during communication with the database, buffering of the transmission data (SQL statement) and recording of an error log are possible. Important data can be protected, and errors can be analyzed.
- When trigger conditions are met, the actions (data calculation and transmission) are stored in the buffer. The GOT can securely execute actions without any omission even if data sending is concentrated temporarily and actions cannot be executed immediately.

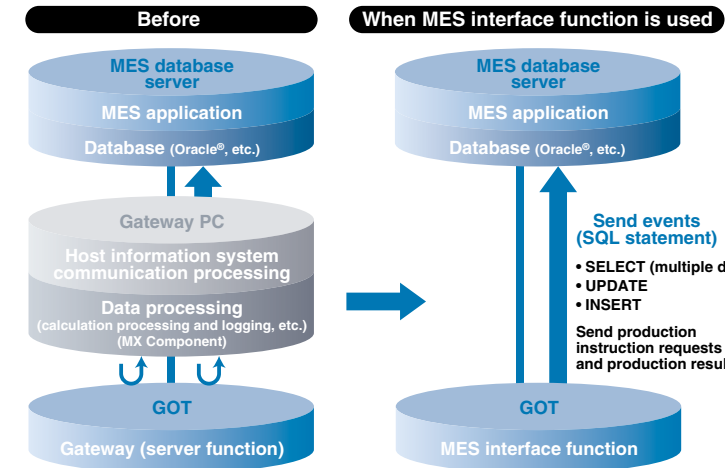

An optional device may be necessary. For details, see "Selection of optional units and devices" (page 77).

- When trigger conditions are met, you can write the resource data of advanced alarms, logging, and operation logs in a database. A vast quantity of data is efficiently controllable with the database.

MES interface function

- DB link function (tag function / trigger buffering function / trigger monitor function / SQL statement transmission function <SELECT / SELECT multiple data / UPDATE / INSERT> / calculation processing function / program execution function / DB buffering function)
- SNTP time synchronization function
- Resource data transmission function • Diagnosis function
- DB server function (ODBC connection function / connection setting function / log output function)

Usable databases*

- Oracle® 8i/9i/10g • Microsoft® Access 2000/2003/2007
- Microsoft® SQL Server 2000/2005
- Microsoft® SQL Server 2000 Desktop Engine (MSDE2000)
- Wonderware® Historian 9.0

* : Compatible only with 32-bit versions.

<MES (Manufacturing Execution System)>
 A manufacturing execution system (MES) is a system which controls and manages the production processes at a worksite in order to optimize quality, productivity, delivery date, and cost.

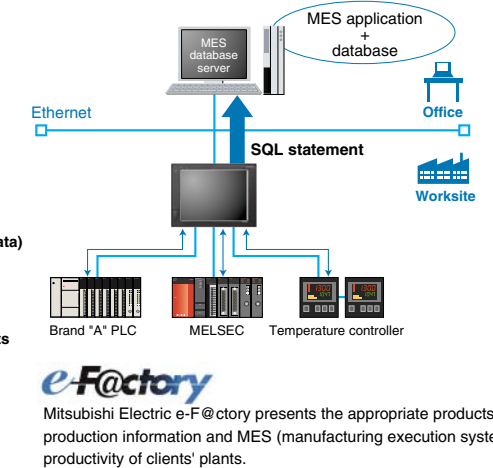

Mitsubishi Electric e-F@ctory presents the appropriate products to connect production information and MES (manufacturing execution system) to improve productivity of clients' plants.

Simply and easily forms an information system at the worksite consisting of units and equipment from different manufacturers. Minimizes initial installation & maintenance cost.

MES interface function - case examples

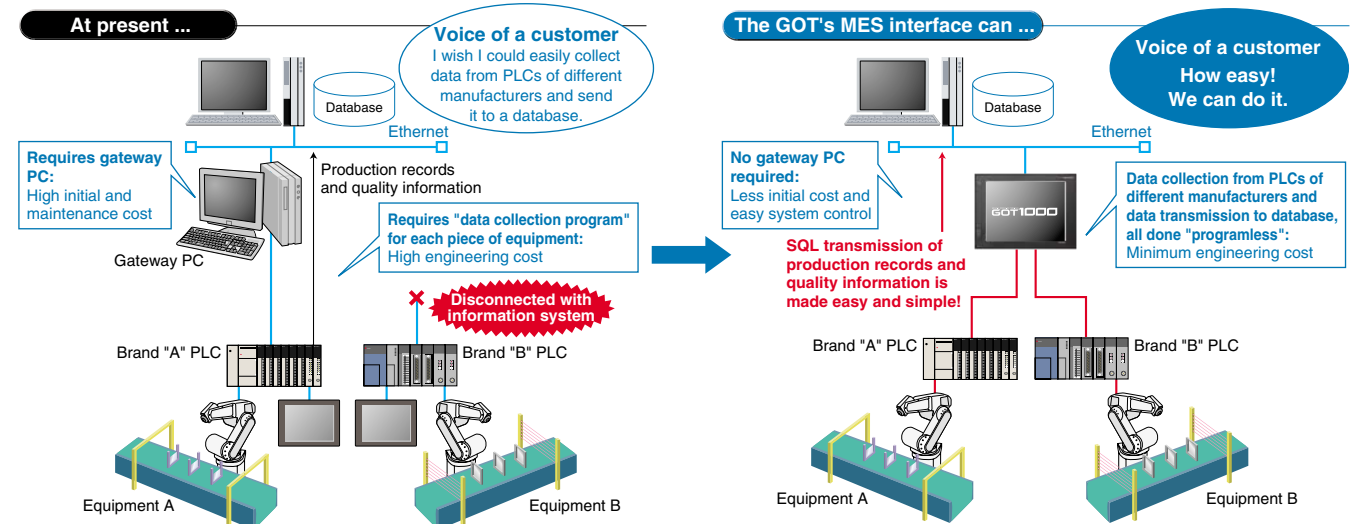

For Designers

For Operators

For Initial Startup & Adjustment Operators

For Maintenance Personnel

GT10

Handy GOT

GT-SoftGOT1000 Version2

IQ Platform

MELSEC-Process Control +GOT1000

List of Connectable Models etc.

A screen design software with many user-oriented functions, making custom screen creation easy

For designers

MELSOFT GT Designer 2 Version 2

Cut screen drawing time in half*

*: Compared with Mitsubishi Electric's GT Designer

Reduced screen drawing time

Windows® standard operation and menu configuration

Data compatibility with GT Designer

Efficient screen creation, even when there are many screens

Drawing screen (editor)

- The area for designing GOT screens.
- A set maximum number of screens can be opened simultaneously (up to 25 screens). When additional screens are opened, screens starting from the first opened screen are closed.

Conversion of multiple objects and figures at the same time

Batch conversion

- Device numbers, objects, figure colors, and lamp and touch switch figures can be converted at the same time.
- This tool is useful for changing objects and figures located on multiple screens.
- Different types of objects (touch switches and numerical displays) and figures (circles and rectangles) can also be converted simultaneously.

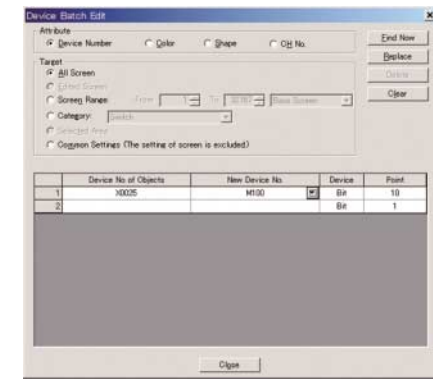

An intuitive tree display makes copying, deleting, and component registration easy

Workspace

Project workspace

The entire project settings such as the created screens and common settings can be shown in a tree view. It is easy to see the entire project so the screen to be edited can be selected quickly.

Category workspace

The entire project settings can be displayed in categories in a tree view. The devices, colors, and figures of components in multiple screens can be adjusted all at once by category.
*: "Category" refers to objects or figures that have been grouped according to purpose.

Library workspace

Registered objects and figures are displayed in a tree view. Frequently used components can be registered as "favorites," permitting quick access to an object or figure.

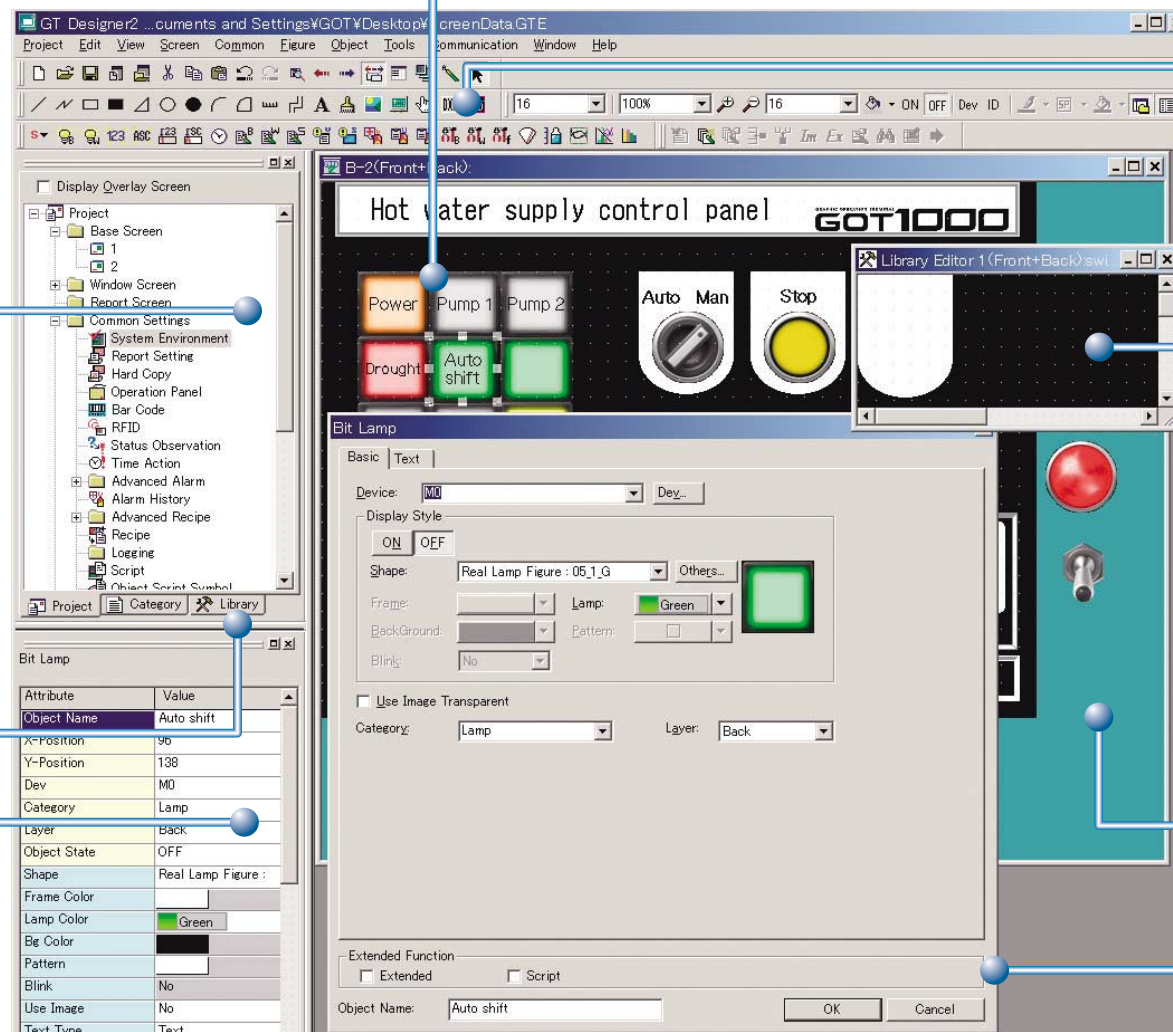

Icon display improves work efficiency

Tool bar

- Various tool bars are available such as Figure, Object, View, and My Favorites.
- Icons show object, figure type, and operation at a glance, improving work efficiency.
- Frequently used objects and figures can be registered as My Favorites.

Dedicated component editing screen

Library editor

- A component editing screen appears by double-clicking a registered component within the library workspace.
- Editing registered components is quick and easy.

Smoother screen design

Temporary area

- Placing objects in the temporary area facilitates smoother screen design and screen layout change operations.

Dialog box

Image display of registered components

Library image list

- Registered components can be shown by image color, making it easy to find the component to be used.
- Designing screens is made easy by selecting components from the image list and putting them on the drawing screen.



List display of object & figure attributes

Property sheet

- An attributes list can be displayed for the selected object or figure.
- Object settings can be changed without opening the dialog box.
- Multiple objects and figures of the same type can be selected, and their color and character size can be adjusted at the same time.

Easy to select overlapped figures

Data list

- All objects and figures located on the screen are listed.
- Data can be edited by double-clicking the object or figure from the list.

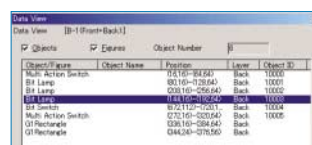

Device search jump for increasing work efficiency

Device list / Character strings list NEW

- Devices used in the screen or in the project are displayed in a list. <Device list>
- Lists the character strings of the text assigned to figures and objects. <Character strings list NEW >
- Double-clicking on a selected result jumps to the relevant object.

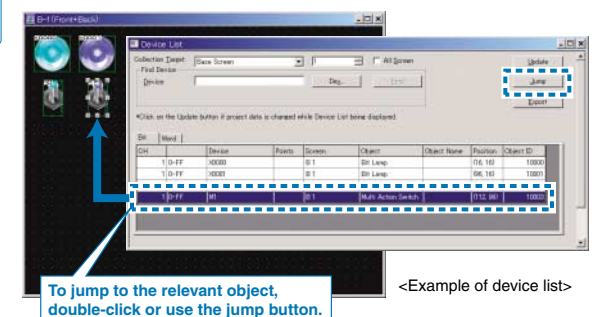

To jump to the relevant object, double-click or use the jump button.

<Example of device list>

For Designers

For Operators

For Initial Startup & Adjustment Operators

For Maintenance Personnel

GT10

Handy GOT

GT-SoftGOT1000 Version2

IQ Platform

MELSEC-Process Control +GOT1000

List of Connectable Models etc.

34

Crystal clear display, easy-to-create screens

GOT1000 GRAPHIC OPERATION TERMINAL

High-quality parts library

- User library can be easily imported.
- A variety of styles and designs are available for touch switches and lamps, easily permitting customized designs.
- All users can easily design sophisticated screens by using high-quality parts.

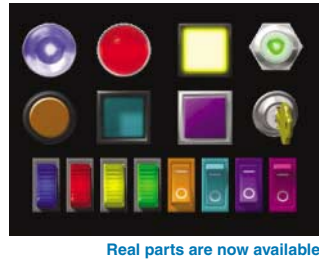

A variety of colors and an easy-to-use library

GOT1000 GRAPHIC OPERATION TERMINAL

Library color selection function

- Library images can be displayed by color. The new sort method helps users quickly look for the image to be used.

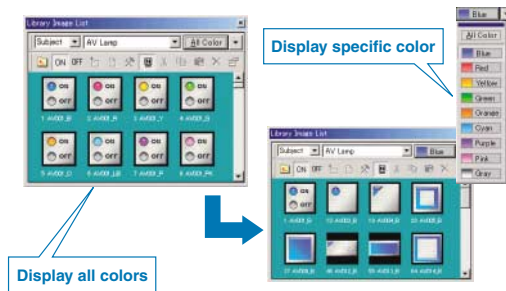

Elegant characters in any font and size

GOT1000 GRAPHIC OPERATION TERMINAL

An assortment of fonts allows for more expression

- The Unicode2.1 compatible standard font, high-quality font, and TrueType font display sharp and attractive characters in all languages.
 - The TrueType number fonts enable seven-segment display. **NEW**
 - When using a Windows® font, the font style (italic, underline, italic underline) can also be specified.
 - Since the curve of stroke fonts are clear even if it is enlarged or reduced, the font size can be incrementally adjusted. Japanese, Thai and Chinese (Simplified and Traditional) are available.
- * : The stroke fonts are for the GT16 and GT15 only.



Selecting screens from a thumbnail list improves your work efficiency

GOT1000 GRAPHIC OPERATION TERMINAL

Screen image list

- Screen image list displays all base screens and window screens, and allows users to copy or delete screens and change the screen numbers. Double-click on a thumbnail image to edit the screen.

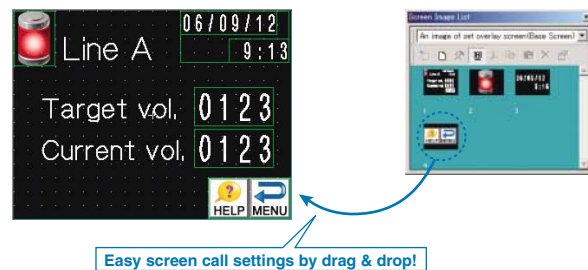

Easy confirmation of screen display

GOT1000 GRAPHIC OPERATION TERMINAL

Screen preview

- Language switching, security level change and on/off image switching of objects can be checked with GT Designer2 on a personal computer.

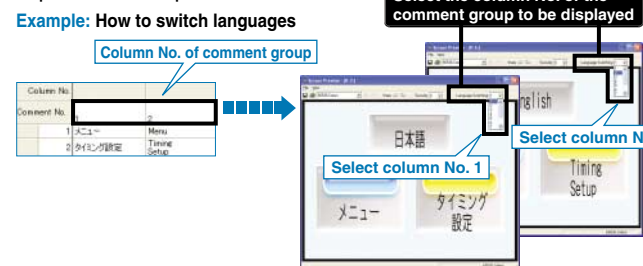

Display of the actual GOT screen

GOT1000 GRAPHIC OPERATION TERMINAL

Window preview

- The screen design software can display window screens (key windows, overlapping windows, superimposed windows) just as they would appear on the GOT, allowing them to be previewed.
- The key pad can be displayed just as it would appear on the GOT, allowing its position, size, appearance, etc., to be checked.

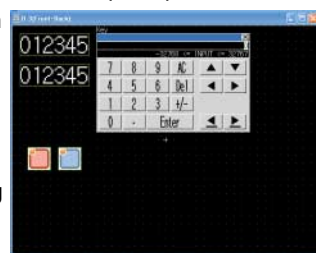

Convenient when converting different screen size data

GOT1000 GRAPHIC OPERATION TERMINAL

Automatic size adjustment of direct input characters

- When changing the object size, directly entered characters are automatically adjusted according to the object size.
- <Supported objects> • Touch switches, lamps

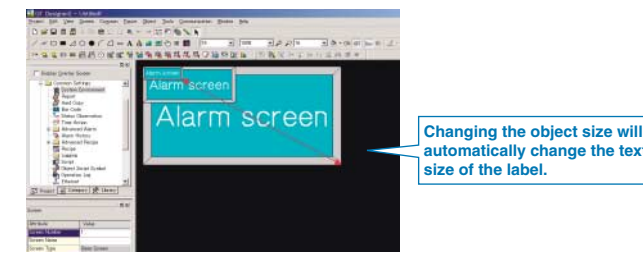

Efficient screen creation when changing the screen size or resolution

GOT1000 GRAPHIC OPERATION TERMINAL

Automatic object size change

- All figures and objects can be resized according to the GOT Type to be converted. This function makes the adjustment of screen sizes a lot easier.

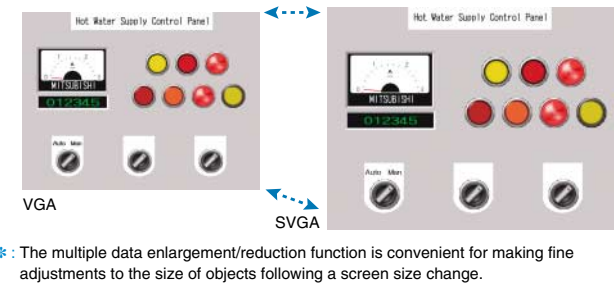

Enhanced functionality including F900 compatible functions (ex. Synchronized screen change)

GOT1000 GRAPHIC OPERATION TERMINAL

Complete conversion of GOT-F900 series data

- Changing screens is now synchronized with touch switch operations, increasing comfort of operation.

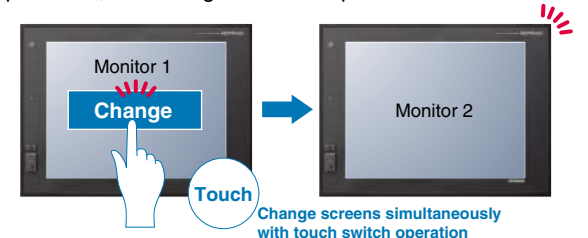

- Auto-repeat function that runs on specified intervals.

Easily create lamps from figures

GOT1000 GRAPHIC OPERATION TERMINAL

Lamp attribute added to figures

- Figures can be changed into lamps by setting colors and patterns for ON and OFF states.

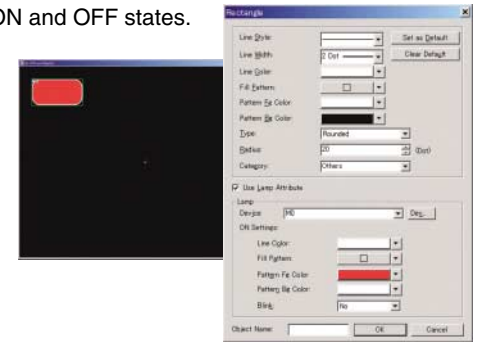

Optimized touch area of switches

GOT1000 GRAPHIC OPERATION TERMINAL

Touch area fit-in function

- Optimize the touch area (valid area) of a switch according to the figure frame. The touch area can be maximized within the switch figure frame.
- A new mode is added to hide the touch area. Users can select whether to display or to hide the touch area of switches.

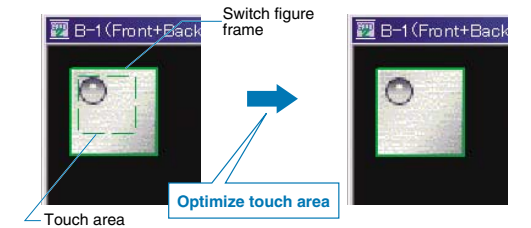

Easy creation of piping graphics

GOT1000 GRAPHIC OPERATION TERMINAL

Piping figure

- Piping graphics can be created in the same way as free form lines with easy apex editing.
- Piping width, pattern, and color can be specified.
- Lamp attributes can be specified, enabling ON/OFF and blinking displays.

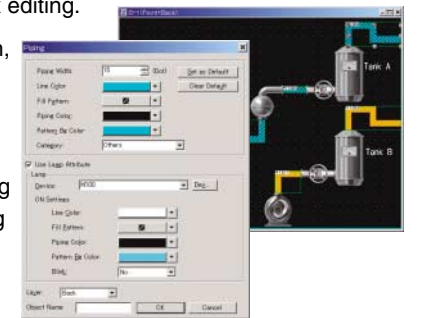

For Designers
For Operators
For Initial Startup & Adjustment Operators
For Maintenance Personnel
GT10
Handy GOT
GT-SoftGOT1000 Version2
IQ Platform
MELSEC Process Control +GOT1000
List of Connectable Models etc.

Easy comment registration using Microsoft® Excel

GOT1000 GRAPHIC OPERATION TERMINAL

Comment registration

- The comments selected on Excel can be copied/cut and pasted into the comment list.
- Comments selected on the comment list can also be copied/cut and pasted into an Excel sheet.

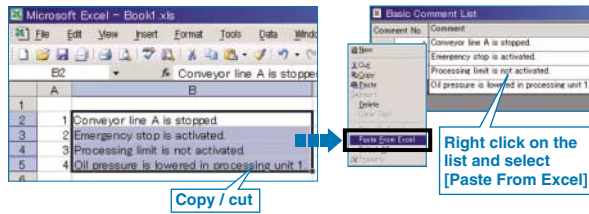

User-friendly setting procedure puts even beginners at ease

GOT1000 GRAPHIC OPERATION TERMINAL

Wizard function

- When creating a new project, the GOT type, the number of colors, communication configuration, and other settings can be interactively set in order.
- All the required settings on GOT can be smoothly set by using the Wizard function.

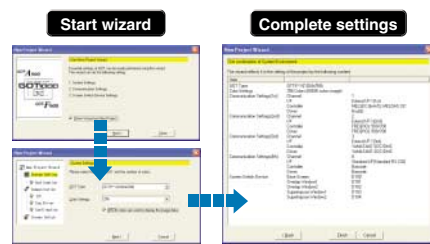

Make the most out of existing GOT projects

GOT1000 GRAPHIC OPERATION TERMINAL

Backward compatibility

- GOT900→GOT1000 compatibility
Simply changing the GOT type with the GT Designer2 enables the project data for the GOT900 to be used with GOT1000.
- GOT800→GOT1000 compatibility
GOT800 project data can be converted into data for the GOT1000 with GT Converter2.



* : Backward compatibility does not extend to certain data and functions.

Higher efficiency by using familiar software

GOT1000 GRAPHIC OPERATION TERMINAL

Improved import/export function

- Device data, range settings, device values, and comments, which have been created in a CSV/Unicode text file format, can easily be imported/exported to/from GT Designer2.
- This function is useful to import a large amount of data such as logging, advanced recipes, recipes, and comments.

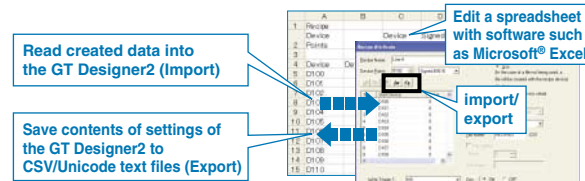

Better project data maintenance efficiency

GOT1000 GRAPHIC OPERATION TERMINAL

Project data consistency check function

- Consistency checks between the GOT's project data and the personal computer project data can be performed.
- This allows project data inconsistencies to be identified, thereby reducing unnecessary uploads and downloads.

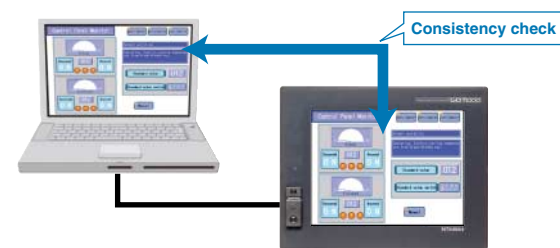

Easy project data conversion

GT Converter2

 Version2

- This software converts project data created with older screen design software to the data for GT Designer2 (GOT1000 or GOT-A900). (Included with GT Works2 and GT Designer2)
- Supported screen design software
 - GOT800 series screen design software (SW3NIW-A8GOTP)
 - ProFace drawing software (GP-PRO/PB III series)

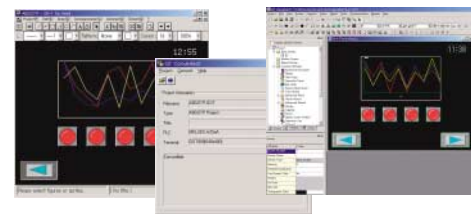

* : Backward compatibility does not extend to certain data and functions.

Lays out objects and figures neatly

GOT1000 GRAPHIC OPERATION TERMINAL

Guideline

- Simply lay out the graphics and objects along the guidelines, and you can align and position them easily and neatly.

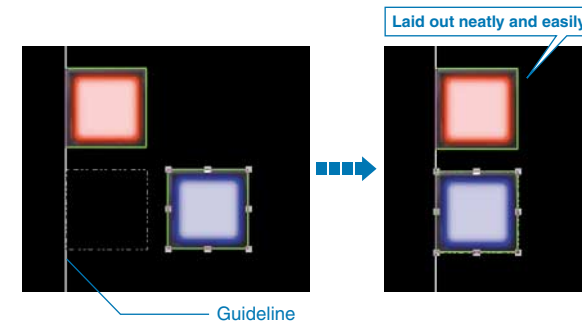

Able to search/convert devices in script – high efficiency

GOT1000 GRAPHIC OPERATION TERMINAL

Device list / batch device conversion

Version upgrade

- Listing devices used in a script and batch conversion of device numbers are available, increasing editing efficiency.
- Reading out other project data that corresponds to the script, improving data sharing.

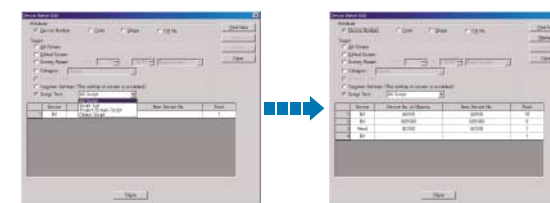

<Example of batch device conversion in script>

Efficient, as you can edit comments on the spot

GOT1000 GRAPHIC OPERATION TERMINAL

Editing comments on dialog screen

- Enables editing comments of the basic comment and comment groups directly from the attribute dialog box of touch switches, lamps, and comments.
- Quickly editing comments on the spot greatly improves work efficiency.

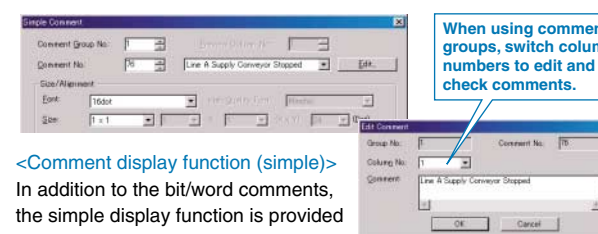

<Comment display function (simple)>
In addition to the bit/word comments, the simple display function is provided that does not require device setting.

Easy to fine-tune sizes of objects and figures

GOT1000 GRAPHIC OPERATION TERMINAL

Define the width/height of objects and figures numerically

- Use the toolbars and property sheets to define the X and Y coordinates, width and height of objects and figures. You can easily fine-tune the sizes dot by dot, which is otherwise difficult with a mouse.

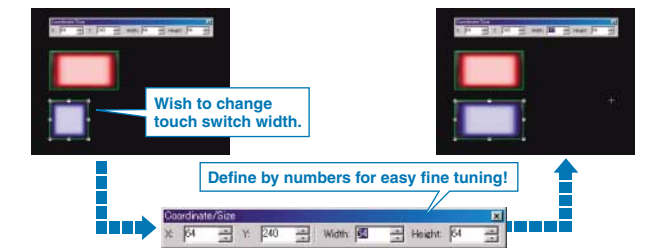

Duplication makes it easy to create objects

GOT1000 GRAPHIC OPERATION TERMINAL

Duplication of object

- "Duplicate" and "Consecutive copy" are added to the context menu that is prompted by right click on the editor screen.
- "Duplicate" is a function to copy and paste at the same time, quickly creating figures and objects of the same configuration.

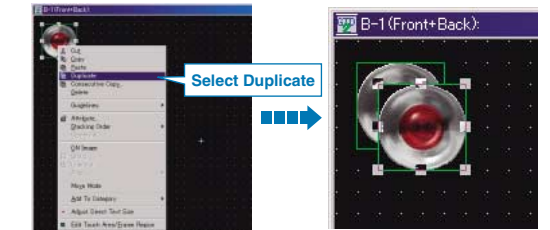

You can conveniently switch columns of a comment group during editing

GOT1000 GRAPHIC OPERATION TERMINAL

Indication of switching languages on editor

- When using the function to switch languages, you can switch the column numbers of comment groups on the editor to check the indication.
- Check the size and the layout of objects easily while creating a screen.

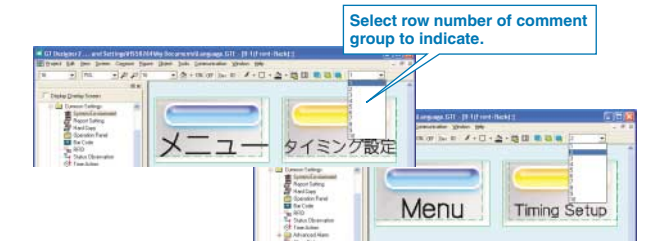

For Designers

For Operators

For Initial Startup & Adjustment Operators

For Maintenance Personnel

GT10

Handy GOT

GT-SoftGOT1000

Version2

IQ Platform

MELSEC Process Control +GOT1000

List of Connectable Models etc.

39

Convenient software programs are available to support designers

For designers

MELSOFT **GT Designer2** Version2
GRAPHIC OPERATION TERMINAL

Fast and simple data transfer tool considerably improves work efficiency

GOT1000 GRAPHIC OPERATION TERMINAL

Data transfer tool

The data transfer tool, dedicated for project data upload/download, is included with GT Works2 and GT Designer2.

- Even in environments without screen design software, the data transfer tool can be used to download/upload GOT project data, and to upload resource data (e.g. alarm log files).
- Even at worksites without screen design software, or when a sudden problem occurs, data can easily be downloaded/uploaded by operators without special training, thereby minimizing the need for dispatching software designers to the worksite.

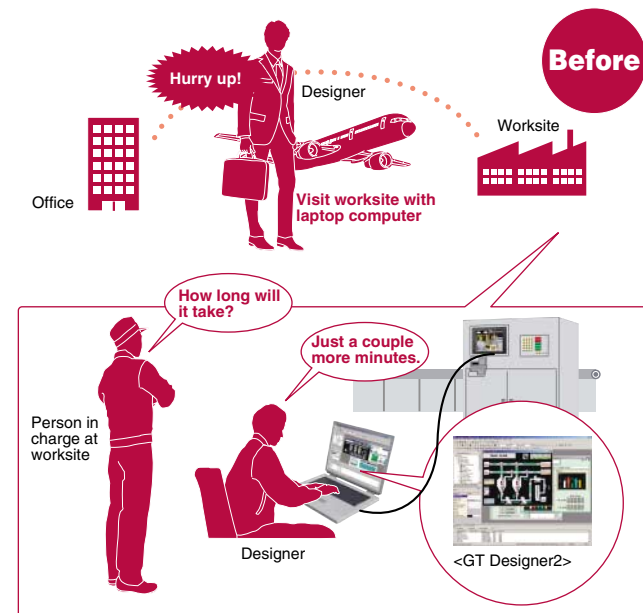

A simple operation to create clear, sharp document images

GOT1000 GRAPHIC OPERATION TERMINAL

Document converter

The document converter, converting files for use with the document display function, is included with GT Works2 and GT Designer2.

- When converting documents, the image quality of the documents (brightness, contrast, sharpness) can be adjusted.
- The document converter software creates clear and sharp document images.

* : For more details, see "Document display function" (page 45).
* : To use the document converter, Ghost Script GPL8.15 or later is needed. For more details, refer to the GT Designer2 Version 2 Screen Design Manual.

- Uploaded resource data binary files (advanced recipe files, data log files, and operation log files only) can be converted into CSV/Unicode text files. Advanced recipe files in the CSV/Unicode format can also be converted into binary files. **NEW**
- Compatible with a data transfer interface function. A user-created application program can download and upload the GOT series project data. **NEW**

Supported GOT model GOT1000, GOT-A900, GOT-F900, GOT800

Supported data Project data, resource data*(GOT1000 only)

* : Advanced alarm log files (advanced alarm), alarm log files (alarm history), advanced recipe files (advanced recipe), recipe files (recipe), data log files (logging), operation log files, image files (hard copy), and screen switching information files

Supported Windows OS Windows Vista®, Windows® XP, Windows® 2000

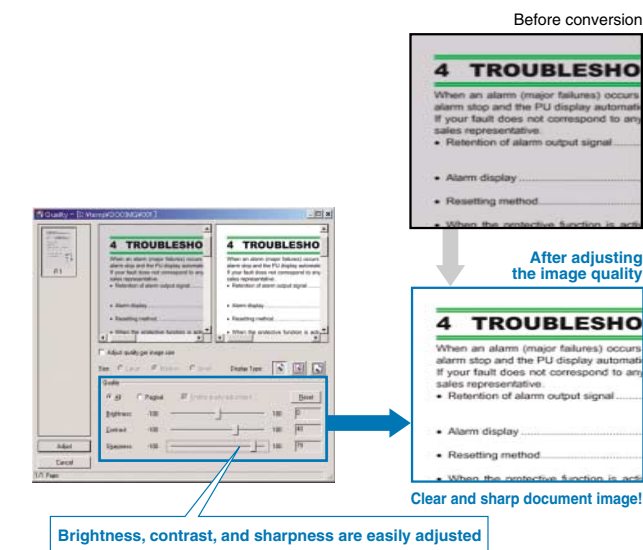
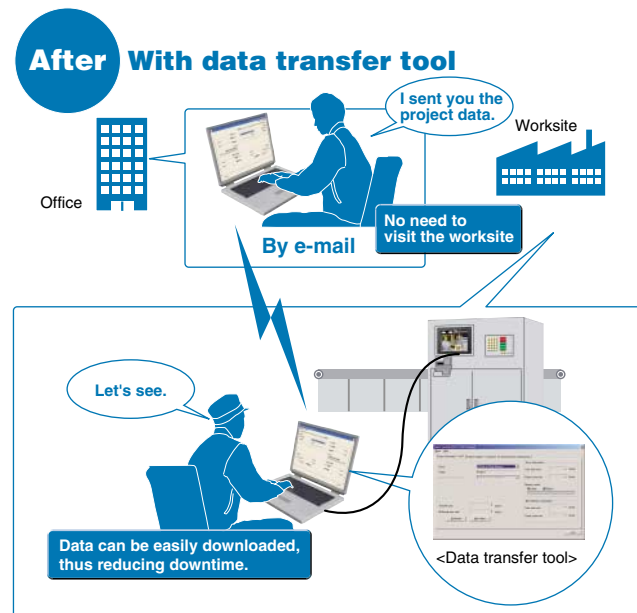

Time-saving debugging and simulation software

For designers

MELSOFT **GT Simulator2** Version2

GT Simulator2 helps designers debug projects by simulating GOT operations on a personal computer. (Included with GT Works2)

Debugging from a single personal computer

- GT Simulator2 can be used in combination with a sequence program simulated by GX Simulator*, allowing debugging to be performed in an intuitive manner from a single personal computer.
* : QnUD(E)(H)CPU/FX3G is not supported.
- The GT Simulator2 screen debugging function permits screen editing in GT Designer2 with the results immediately verifiable in GT Simulator2, thereby greatly reducing debugging man-hours.
- The touch switch input is simulated by clicking the mouse. In addition to monitoring devices, GT Simulator2 can be used to check stored data such as system alarms, script error information, and alarm history.

Quick and easy debugging without the GOT main unit.

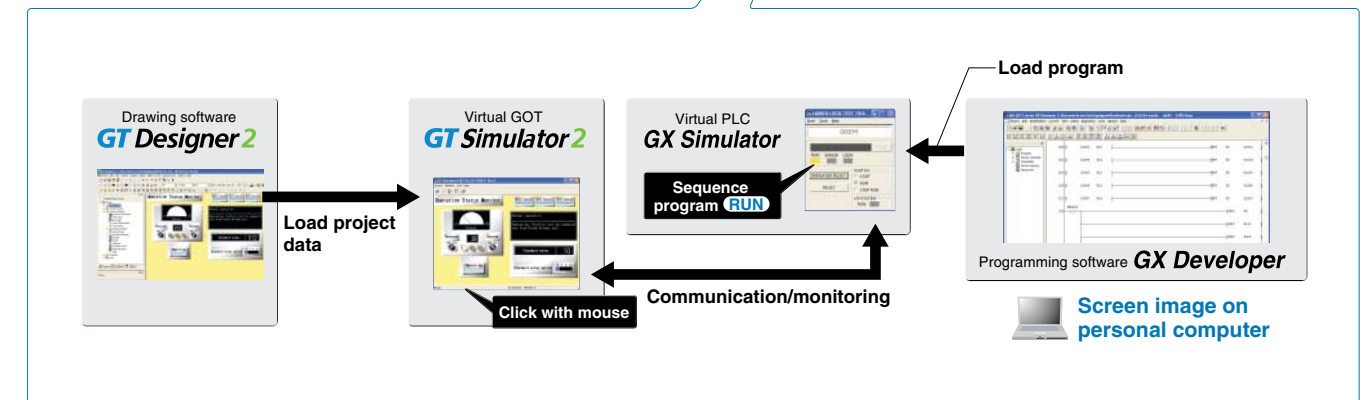
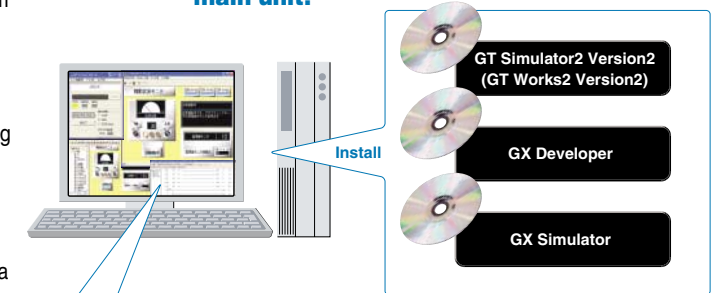

Debugging is possible by connection with a PLC, without actual GOT operation required

- Debugging can be performed using a direct CPU connection between a personal computer (GT Simulator2) and a Mitsubishi or Omron PLC, without an actual GOT unit.

Connectable PLC	PLC ⇄ Personal computer connection
Mitsubishi PLC (Q ⁺ /QnA/A/FX series)	CPU direct connection
Mitsubishi CNC (MELDAS C6/C64)	RS-232, RS-422
OMRON PLC	CPU direct connection
	RS-232

* : QnUD(E)(H)CPU/FX3G is not supported.

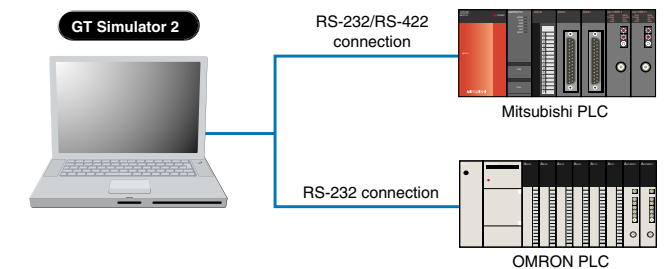

Powerful support of customer specifications, compatibility checks, and document creation

- While observing the operation image, the customer's screen specifications can be arranged without actual unit operation.
- Screen snapshots can be printed and saved as BMP/JPEG files which are extremely useful when creating specifications and operation manuals.



For Designers

For Operators

For Initial Startup & Adjustment Operators

For Maintenance Personnel

GT10

Handy GOT

GT-SoftGOT1000 Version2

IQ Platform

MELSEC Process Control + GOT1000

List of Connectable Models etc.

Quick response and useful standard functions provide users with comfortable operation



Dramatically improved GOT total response

Drawing, computing, communication; a trio of high-speed response functions

The GOT1000 series offers faster response in drawing, computing and communication, reducing monitoring and operation stress.

High-speed drawing

- Sharp and quick drawing of complex, layered component screens, and detailed photographic data in 65,536 colors.
- The GT16 further speeds up the drawing operation. **NEW**

High-speed computing

- Ultra-high performance processing power to satisfy the most complex and demanding of applications.

High-speed communication

- Greatly improved response performance.
- GT16, GT15, and GT11 offer high-speed communication through the bus connection.
- High-speed communication is possible for connections with both Mitsubishi and third party PLCs.

*: For connectable PLC models, see "List of connectable models" (page 62).

GT16/GT15 response performance comparison

[Using MELSEC Q series] As of August 2008

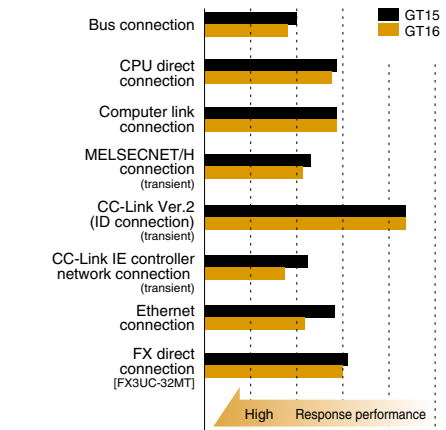

The monitor screen includes about 250 points of word devices.

Customized dialog windows showing custom messages to operators

Dialog window function

- Instead of using system dialogs (e.g. input error at numerical input), users can customize dialogs to display help on user operations or troubleshooting messages when alarms occur.
- With templates such as icons and an OK button, users can easily create dialogs with the wizard function.

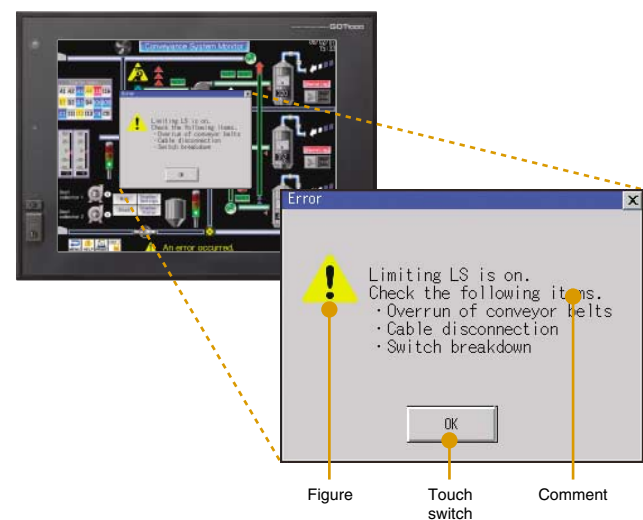

Figure Touch switch Comment

Easy switching between different languages to globalize your production site

Display in different world languages

- The Unicode2.1 compatible standard font, high-quality font, and TrueType font display sharp and attractive characters in all languages.
- The language displayed on the GOT main unit utility screen can be set to Japanese, English, Chinese (Simplified/Traditional*), Korean (Hangul), or German.

*: Traditional Chinese can be displayed only on the GT16 and GT15.



To minimize production time, the GOT provides the user with worksite-required functions



Easy data transmission without opening the cabinet

Equipped with front USB interface

- The front USB interface allows a programming cable to be connected without having to open the cabinet.
- Data transmission using the USB interface (up to 12Mbps) greatly reduces the time required for startup and adjustment.

- The environmentally protective USB port cover complies with the IP67f standard.*

- *: Compliance cannot be guaranteed in all customer environments.
- *: To connect the GOT to a personal computer, use the dedicated USB cable. For more details, see "Product list" (page 86).
- *: The GT16 has a USB device and USB host as standard features. The GT15 and GT11 have a USB device only as a standard feature.



With USB cable



With USB environmentally protective cover installed (standard feature) IP67f

*: For the GT15 and GT11, it is fastened with a coin-type screw.

Sequence program and parameters can easily be modified at the worksite

FA transparent function

- Connected with a personal computer, the GOT through itself enables to program, start up, and adjust FA equipment.
- Users do not have to bother themselves to open the cabinet or change cable connections. (When using the UBS interface)
- When multiple FA devices are connected, the communication target can be changed on the GOT main unit using the multi-channel function. (For the GT16 and GT15)

Supported software*

- GX Developer
Q/QnA/FXCPU, motion controller (A series)
- GX Configurator
Intelligent function module for the Q series (AD/DA/SC/CT/TC/TI/FL/PT/AS)
- PX Developer
Process control CPU (Q02PH/Q06PH/Q12PH/Q25PHCPU)
Redundant CPU (Q12PRH/Q25PRHCPU)
- MT Developer
Motion controller (Q series)
- MR Configurator
Q172HCPU(-T)/Q173HCPU(-T)+MR-J3-B (SSCNETIII)
- FR Configurator
FREQROL A700/F700/E700
- FX Configurator-FP
FXCPU
- RT ToolBox2 **NEW**
CRnQ-700

*: The version of the software depends on the system configuration.
*: For the software access range when using the FA transparent function, refer to the manual for the software being used.

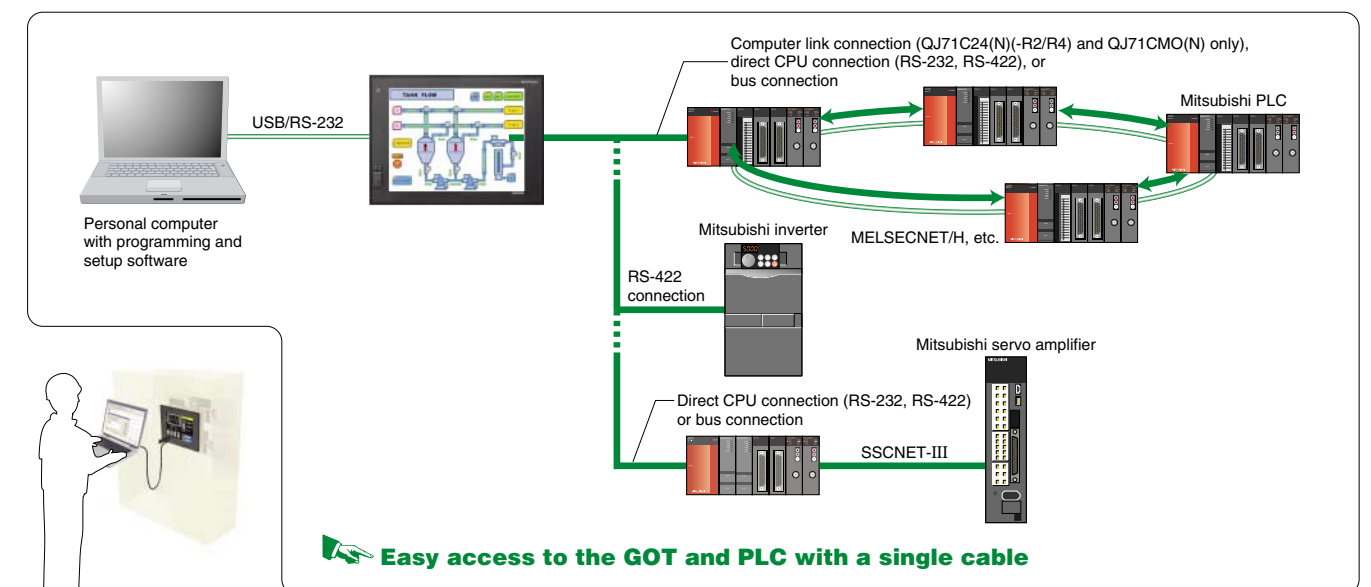

Easy access to the GOT and PLC with a single cable

For Designers
For Operators
For Initial Startup & Adjustment Operators
For Maintenance Personnel
GT10
Handy GOT
GT-SoftGOT1000 Version2
IQ Platform
MELSEC Process Control +GOT1000
List of Connectable Models etc.

Error detection and recovery through the GOT's Alarm Function with advanced features

For maintenance personnel

Accurate communication minimizes machine downtime even during an alarm

GT 16 GT 15
GOT1000 GRAPHIC OPERATION TERMINAL

Advanced alarm

1 A wider monitoring range protects even large-scale systems

- Alarm observation is possible for up to 32,767 devices with a maximum of 255 alarm observation setting groups.
- Three types of alarm displays can be specified for a single alarm observation setting.
- Up to 32,767 alarms can be saved in the alarm history.
- Batch display of large amounts of alarm information in large-scale systems, and unit-specific classification for easy management.

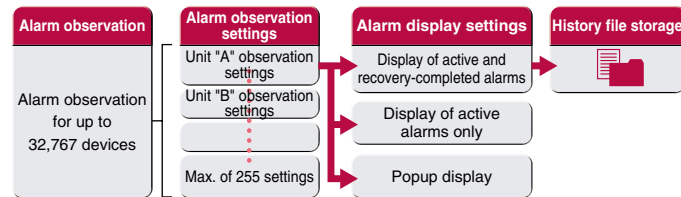

2 Rapid detection and corrective action for a wide array of alarms

Four-step alarm notification

- Alarm occurrence conditions can be divided into 4 steps and conveyed to the operator in an easy-to-understand, step-by-step format.
- The four-step display makes it easy to take in and sort out alarm conditions (information such as where, what, and how). This enables efficient troubleshooting when multiple problems occur.
- The contents of the 4 steps shown above can be freely defined to suit the application in question, with switching between the step displays performed by the step switching device or by touch-screen operation.

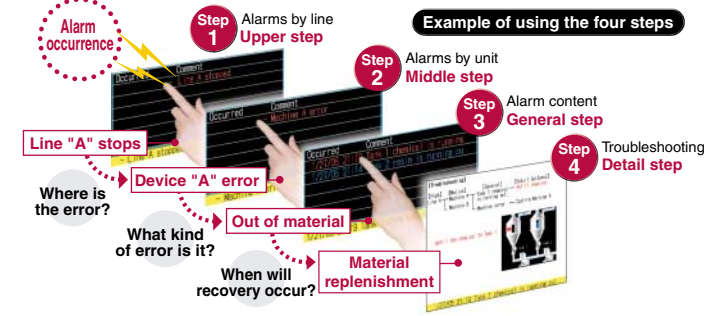

Group-specific & level-specific displays

- Alarms can be classified by group and level, with only the specified alarms being displayed.
- This makes it easy to identify the locations and types of alarms even when many alarms have occurred, and permits higher priority alarms to be handled first, resulting in a speedy system recovery.

Alarm	Group	Level
M0	Transport G	Mid-level
M1	Transport G	Mid-level
M2	Transport G	Mid-level
M3	Transport G	Mid-level
M4	Transport G	Major
M5	Process G	Major
M6	Process G	Minor
M7	Process G	Minor
M8	Process G	Minor
M9	Process G	Minor

Arrows indicate that combinations of Group and Level result in different alarm displays:

- Group: Transport G → Transport G alarm display
- Group: Process G → Minor alarm display
- Combination of level & group: M4 → Transport G major alarm display

3 Easy-to-understand display

- The use of colors and popups produce easily recognizable alarm displays.
- Ensuring that alarms are not overlooked and that the alarm contents are understood, results in a speedy system recovery.

Key features for an easy-to-understand display:

- Display subject switching**: Can display only active alarms or all contents.
- Comment display color**: Colors can be specified for each alarm status (occurred, restored, checked) and for each level and group.
- Sorting**: A sorting function permits the display order to be changed such as date & time, level, group, alarm status, occurrence count, and downtime.
- Cursor display color**: The cursor display color can be specified. Alarm displays are harder to miss, and the freedom of screen design has been increased.
- Floating alarm display**: Permits the entire text of long comments which cannot be contained in the display area to be read.
- Details display**: Users can create window screens freely to display details. **JPEG images can also be displayed.**
- Alarm popup display**: A popup display format ensures that user alarms and system alarms are not missed. The background color can be specified.

4 Improved system alarms

- The PLC/GOT/Network monitoring subject can be specified in advance, with only those specified alarms being displayed.
- It can be set so that only the active alarms are displayed. Alarm history display and history file storage are also possible.

5 Support in identifying alarm causes (utility function)

- Alarm occurrence conditions can be displayed in time-series graph form.
- Alarm occurrence counts can be displayed in bar-graph form.
- A graphical statistics display facilitates efficient analysis of error causes.

Display various documents on the GOT at the worksite

GT 16 GT 15
GOT1000 GRAPHIC OPERATION TERMINAL

Document display function

- When a system error occurs, referring to recovery methods in check lists and/or manuals on the GOT can reduce downtime.
- Even if there is no personal computer at the worksite, operation guidance and work instructions can be displayed on the GOT.

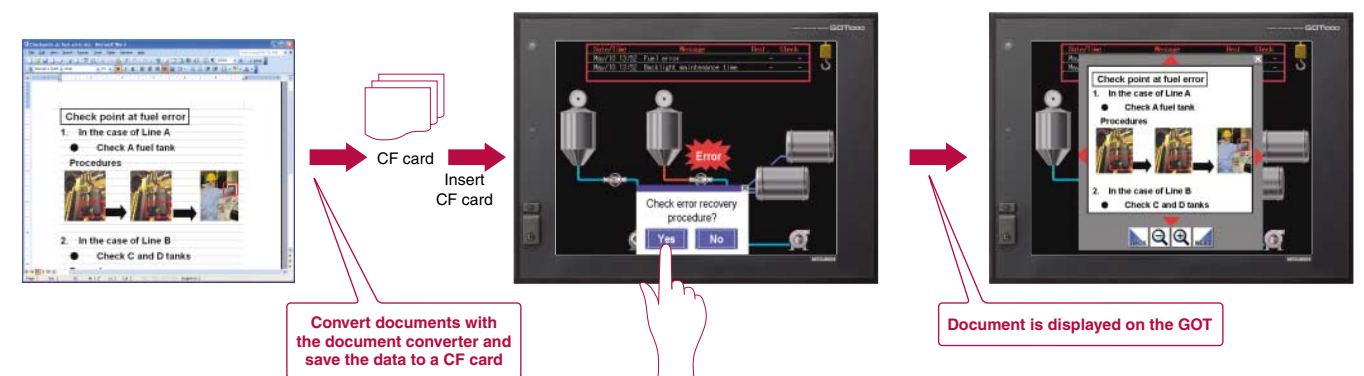

Display of documents and manuals on the GOT can reduce downtime.

An optional device may be necessary. For details, see "Selection of optional units and devices" (page 77).

Of great help when the user senses a problem

GT 16
GOT1000 GRAPHIC OPERATION TERMINAL

Batch self check function

- Enables to easily check the GOT operation history on a utility screen, helping you to locate the cause of the problem.
- Even if not set up in advance by the GT Designer2, the utility screen shows the data for the user to check. It is useful in an emergency.

<Typical items available for check>

- History of switching screens and system alarms
- Time of starting and ending communications between the GOT and connected devices
- History of using download, upload, and FA transparent functions
- List of types and versions of the operating systems installed
- List of model names of the GOT and units installed

- Pages can be changed, scrolled through, enlarged or reduced, and multi-page documents can be displayed.
- Document converter* is used to format documents to be displayed and save them to CF cards as JPEG files.
 - *: For more details, see "Document converter" (page 40).
- Documents created by applications such as Microsoft® Word can be used, reducing the man-hours for screen design.
 - Supported file formats: doc, xls, ppt, pdf, jpg, bmp
- The brightness and contrast of difficult to read documents can be adjusted when the documents are converted with the document converter to facilitate better viewing on the GOT.

Screen showing various startup information



Screen showing system alarm history

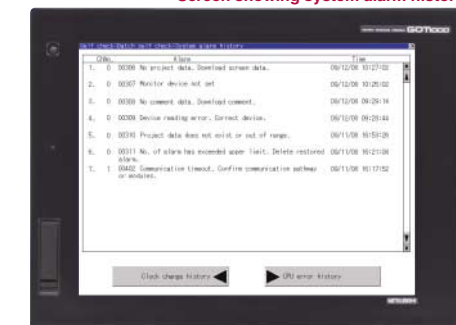

For Designers
For Operators
For Initial Startup & Adjustment Operators
For Maintenance Personnel
GT10
Handy GOT
GT-SoftGOT1000 Version2
IQ Platform
MELSEC Process Control + GOT1000
List of Connectable Models, etc.

GOT provides complete traceability for safe and secure operation

For maintenance personnel

Smooth operation from the collection of various data to storage of time-series data

GT 16 GT 15
GOT1000 GRAPHIC OPERATION TERMINAL

Logging function

- Collecting data from temperature controllers and other units with the GOT can reduce the load on the PLC.
- Up to 250 devices per setting and 32 settings per project can be set.
- Collected data can be used for record and analytical purposes when being saved to a CF card.
- Files can be saved in the GOT dedicated binary file, CSV or Unicode text file formats.

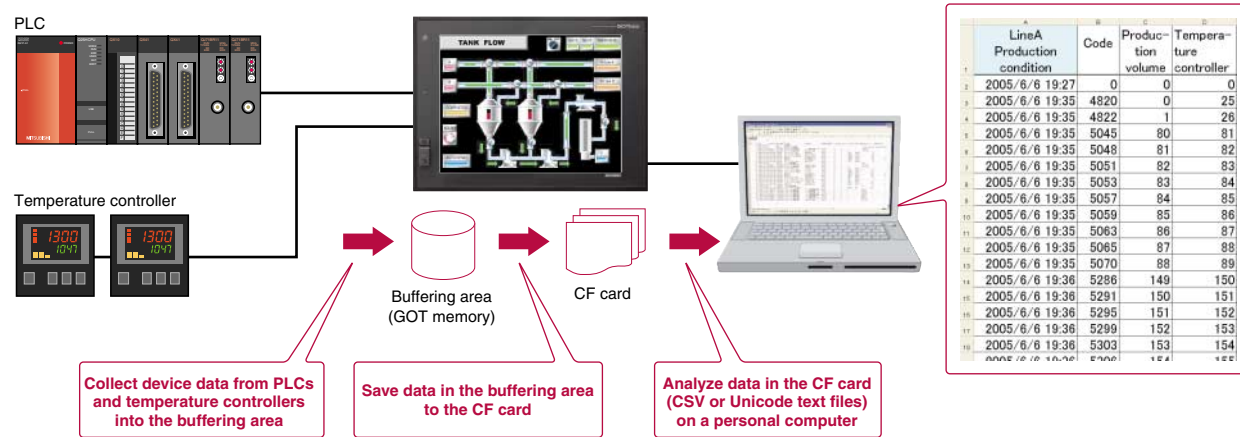

Easy-to-read logging data in a graphical display

GT 16 GT 15
GOT1000 GRAPHIC OPERATION TERMINAL

Historical trend graph

- Data collected by the logging function can be displayed in a time-series graph from a CF card as well as from the buffering area.
- * : Logging function settings are required to use historical trend graph.
- The data collected by the logging function can be displayed in graph form; the past data can be displayed simply by touching a scroll switch.
- Enabling the cursor displays the device value and time of the cursor position, and allows for enlargement or reduction of scale.
- Up to 32 data devices can be displayed in a graph; up to 8 graphs can be added to a screen.

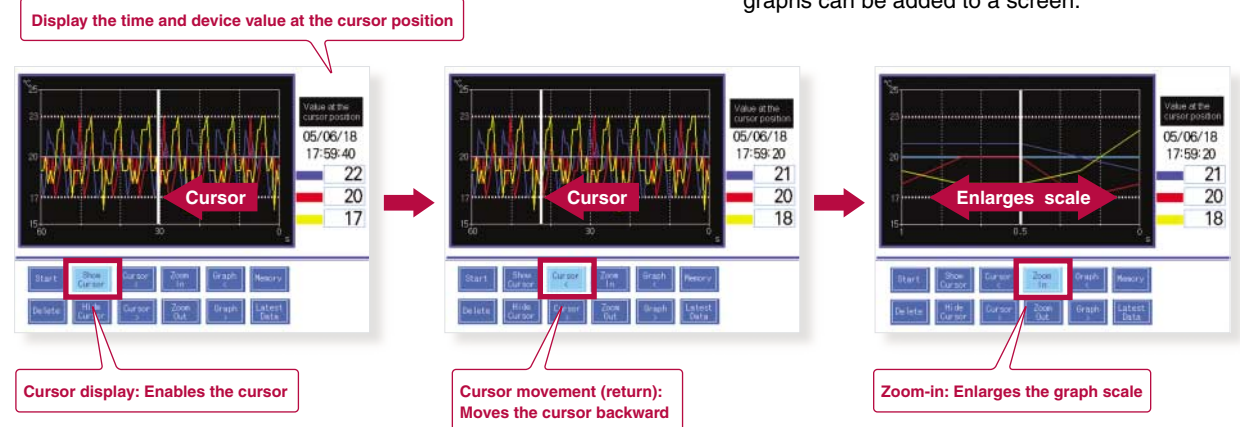

Enhanced security system by password control

GT 16 GT 15
GOT1000 GRAPHIC OPERATION TERMINAL

Operator authentication function

- When starting up the GOT or switching screens, a login screen appears to authenticate the operator name and password. The display and operation screen depends on the operator logged-in so that security is strengthened.

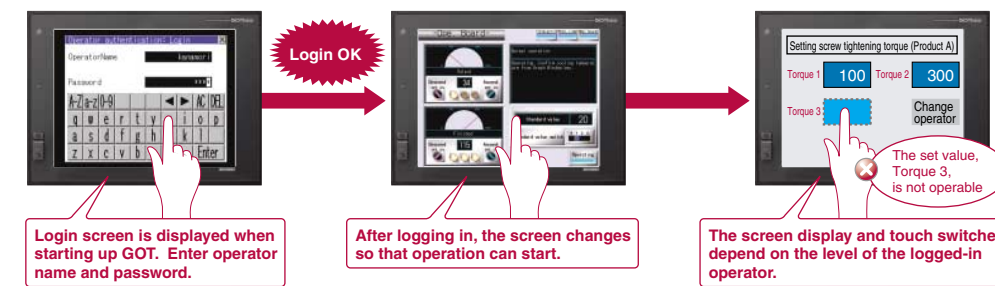

- If there is no operation for a certain period of time after logging-in, the login screen appears again, and the password must be re-entered to start operation. This prevents unauthorized operation.
- It is possible to add operators and change passwords in the GOT main unit utility screen.

Combined with the operation log function, who, what, when, and how the operator operated can be recorded.
* : See "Operation log function."

Date/Time: 05/05/2007 10:20:04

Function: NUMVAL

Numerical Input

Screen No: BASE_2

Operation: Torque 1 set value

Operator: JonSmith (ID:1)

User ID: -

Action No: 1

Data Type: BIN16

Device: D100

Change To: 100

Chng From: 10

Example: Jon Smith changed the Numerical Input (D100) value from 10 to 100 on base screen 2.

Setting the level (authority) of operation and display for each operator can strengthen security and prevent operation errors.

Helpful for identification and analysis of problem causes

GT 16 GT 15
GOT1000 GRAPHIC OPERATION TERMINAL

Operation log function

- Users can specify which operations to save in the log by changing the device value and GOT operation state.
- <Specifiable operations>
Touch switch operation, numerical input operation, security level change, screen change, etc.
- Operations performed by operators on the GOT can be recorded with respect to time.
- When problems occur (e.g. a system error), users can confirm when and how the operations were performed by referring to the operation log, using it to specify and analyze the cause of the error.
- Moreover, using the operator authentication function enables to check "who" has operated the system.
- * : See "Operator authentication function."

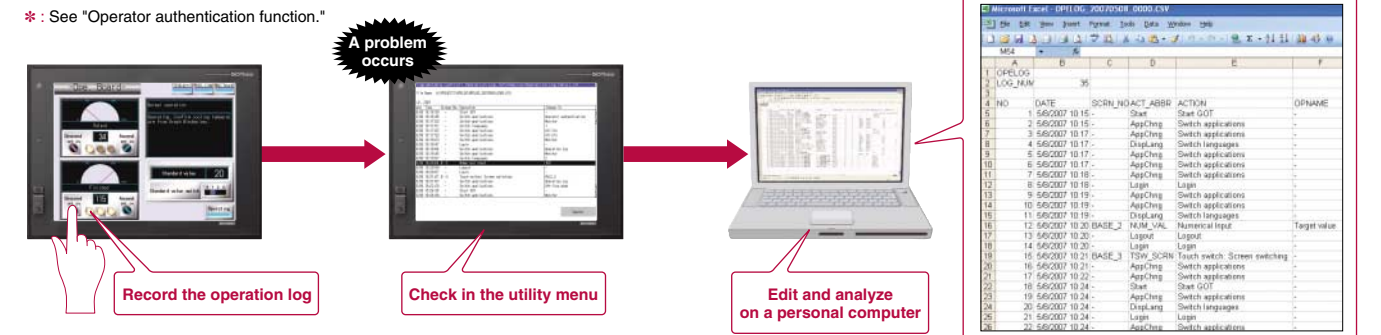

Refer to the operation log file, and investigate the problem cause.

An optional device may be necessary. For details, see "Selection of optional units and devices" (page 77).

For Designers
For Operators
For Initial Startup & Adjustment Operators
For Maintenance Personnel
GT10
Handy GOT
GOT Software Version 2
IO Platform
MELSEC Process Control + GOT1000
List of Connectable Models, etc.

Functions designed to support maintenance work significantly reduces downtime!

For maintenance personnel

Back up important sequence programs to be safe and secure in case of an emergency

GT 16 GT 15

Backup/restoration function

- <Objective data> Programs, parameters, device comments, device initial value data, file registers, etc.
- <Objective model> MELSEC Q-Series (excluding Q12PRH/Q25PRHCPU), Q-Series motion controllers (SV13/SV22 only), CNC C70
- <Usable connection type> Bus connection, CPU direct connection, computer link connection, Ethernet connection (host only)

Example of use ①

Make a data backup in preparation for the PLC or the CPU failure or a dead battery to quickly replace the faulty device and restore the system using the backup in such a case.

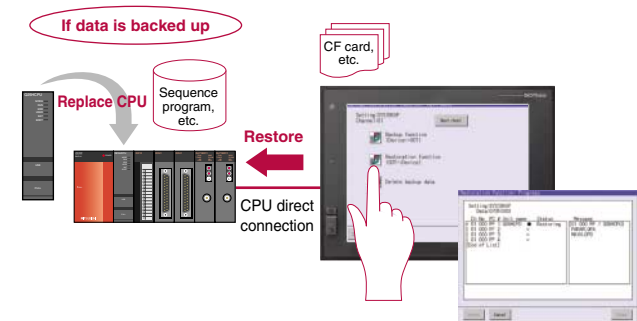

- The sequence program and parameter data of the PLC CPU and motion controller can be backed up to the CF card in the GOT.
- Automatic backups are possible by using a trigger device, or by specifying the time and day.
- Users can perform batch operation to restore the data to the PLC CPU or motion controller.

The backup data conversion tool is shipped with GT Works2 / GT Designer2.

Example of use ②

When a problem occurs, or when the PLC CPU program is updated, the sequence program data can be transferred, analyzed, and corrected without requiring an experienced engineer, increasing time and cost efficiency.

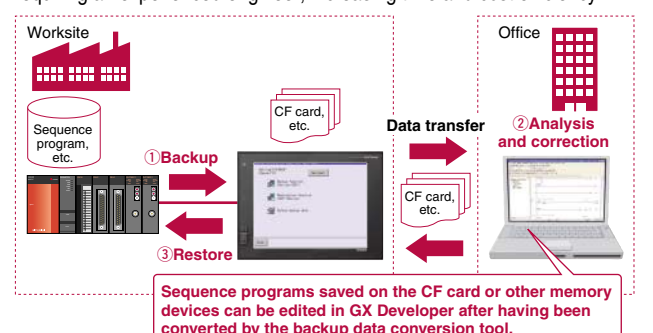

Sequence programs saved on the CF card or other memory devices can be edited in GX Developer after having been converted by the backup data conversion tool.

PLC CPU programs can be easily changed without a personal computer at the worksite or any previous GX Developer knowledge.

An optional device may be necessary. For details, see "Selection of optional units and devices" (page 77).

* : When replacing the PLC CPU, the restoration function may not be available depending on the system configuration and connection type.

Easy-to recognize backlight state

GOT1000 GRAPHIC OPERATION TERMINAL

Color-coded front face LED

- The color of the LED on the front of the GOT unit indicates whether the backlight is OFF or has expired.

[Power LED: Color-coded message]

Green ON	When normal power is being applied	Orange/green blinking	When backlight life has expired
Orange ON	When in screen-save mode	OFF	When power is not being supplied

For planned commodity maintenance

GT 16 GT 15

Maintenance time notification function

- The backlight ON time is automatically monitored, and the operator is notified when maintenance is required. This facilitates scheduled maintenance and prevents system malfunctions.

<Subject to be monitored> Backlight, display area, touch keys, and built-in flash memory

Warning! Backlight needs replacement soon.



An optional device may be necessary. For details, see "Selection of optional units and devices" (page 77).

Convenient method for minor program changes onsite

GOT1000 GRAPHIC OPERATION TERMINAL

List editor for A/List editor for FX

- MELSEC-A series, FX series PLC sequence programs can be edited in a list format (instruction word).
- Permits minor program changes onsite, even without peripheral devices.
- With the ladder monitor function used together, the GT16 and GT15 can edit sequence programs while viewing the ladder data.

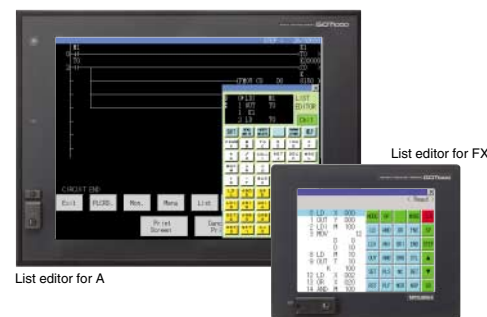

PLC device monitoring/changes

GOT1000 GRAPHIC OPERATION TERMINAL

System monitor function

- Mitsubishi PLC CPU devices can be monitored and changed.
 - * : Only monitoring, but not changing device values and other operations, is available with the QSCPU.
- Monitoring can be performed by selecting the device to be monitored, or by specifying the initial device.
- The current values and setting values of the timer (T) and counter (C) can be changed.
- The buffer memory (BM) of a special function unit can be monitored and changed.
- The display format (decimal/hexadecimal) and the device comment display status (on/off) can be switched.



Easy adjustment of Q series motion controller

GOT1000 GRAPHIC OPERATION TERMINAL

Q series motion monitor function

- Up to 3 Q-type motion controllers can be used on a single base, with monitoring and parameter settings possible.

<Objective models>

- Q172D/Q173DCPU
- Q172(N)/Q173(N)CPU
- Q172H/Q173HCPU

* : Supported only if the Q series motion controller CPU has SV13/SV22 OS version. Moreover, available functions of the Q series motion monitor vary according to the CPU type.



Easy-to-understand display of buffer memory values and I/O information

GOT1000 GRAPHIC OPERATION TERMINAL

Intelligent unit monitor function

- Buffer memory values of intelligent function units and the ON/OFF status of I/O units can be monitored and changed.
- When a QCPU (Q mode) or a QSCPU is in use, CPU operating status and existing errors can be monitored by PLC diagnosis.

* : Supported by the XGA/SVGA/VGA models.



At-a-glance monitoring of MELSECNET network status

GT 16 GT 15

Network monitor function

- Enables to monitor the network line conditions of the CC-Link IE, MELSECNET/H, MELSECNET/10, and MELSECNET II on the dedicated screen.
- Communication line and information from the host and other stations can be monitored to check the communication status.



Easy startup and adjustment of a servo amplifier

GOT1000 GRAPHIC OPERATION TERMINAL

Servo amplifier monitor function

- In a system which outputs pulse strings, the GOT can be connected to a servo amplifier in a serial connection to perform the following operations: setting up, monitoring, alarm display, diagnosis, parameter setting, and test operations.

- When multiple servo amplifiers are connected, monitor screens can be easily switched on a GOT by specifying station numbers.

* : Available monitoring functions vary according to the servo amplifier type.



Save space and cost when no dedicated display device is required

GOT1000 GRAPHIC OPERATION TERMINAL

CNC monitor function / CNC data I/O function

CNC monitor function

- Connecting to a CNC (C70, C6/C64) enables functions such as position display and alarm diagnosis, and allows tool offset parameters to be set.

CNC data I/O function

- This function can be used to copy and delete CNC C70 work programs, parameters, etc.

An optional device may be necessary. For details, see "Selection of optional units and devices" (page 77).

* : Supported by the XGA/SVGA models.



For Designers

For Operators

For Initial Startup & Adjustment Operators

For Maintenance Personnel

GT10

Handy GOT

GT-SoftGOT1000 Version2

IQ Platform

MELSEC Process Control + GOT1000

List of Connectable Models, etc.

Extensive FA device compatibility reduces your maintenance work

For maintenance personnel

GT 16 GT 15
GOT Ladder Monitor Function is greatly improved with the One-Touch Ladder Jump function
GOT1000 GRAPHIC OPERATION TERMINAL
Ladder monitor function

MELSEC Q/QS/QnA/FX series PLC sequence programs can be monitored in a circuit diagram (ladder format).

Wide monitoring range

- Not only the PLCs connected to the GOT, but also PLCs of other stations, multiple CPUs, multiple programs in the CPU, and local devices (Q series only) can be monitored.

One-Touch Ladder Jump function (Q/QnA series)

- By setting a program name and coil number of the PLC to a touch switch, the relative ladder circuit block can be displayed directly.

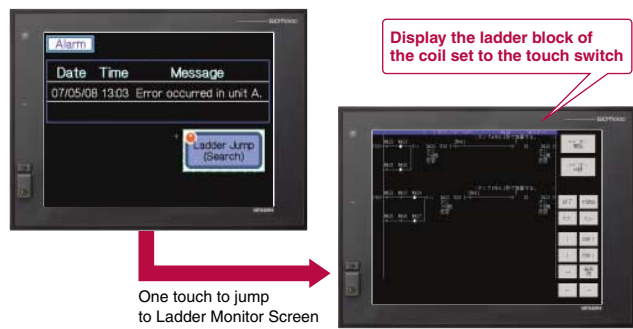

- For the touch switch, users can set the PLC station No., CPU No., program name, and coil No. The touch switch will then display the corresponding ladder blocks within the multiple programs that are contained in the PLCs connected to the GOT, other station PLCs, and multiple CPUs. Local devices can be monitored for the Q series PLC.

Other useful functions

- Device values and timer (T)/counter (C) set values can be changed while viewing the change points on the Ladder Monitor.
- When a problem occurs, the alarm history can be displayed and a back-tracking ladder search can be performed to find the contact which triggered the alarm. <Defect search>

Example of defect search (when error indicator light [Y30] is on)

■ Search for the cause of component error (M130) which turned on the error indicator light (Y30)

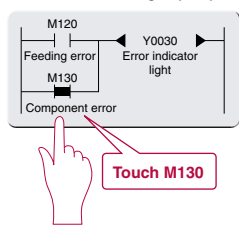

■ Search for the cause of the height sensor operation (M133) which caused the component error (M130)

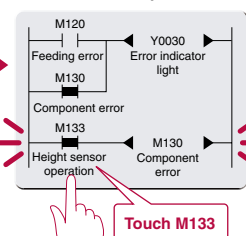

■ Search for and display the coil of the height sensor operation (M133)

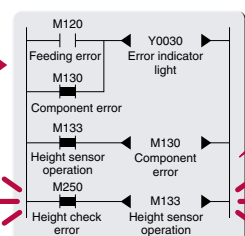

The error indicator light was turned on because of a height check error (M250)

Since the cause of operation halts and interlocks can be checked, unexpected problems can be detected quickly.

An optional device may be necessary. For details, see "Selection of optional units and devices" (page 77).



- * : Supported by the XGA/SVGA/VGA models.
- * : The QS series models can only monitor the data through the Q/QnA circuit. It cannot alter the device values, for instance.
- * : FX3GCPU is not supported.

Device comments are stored in the GOT CF card (Q/QnA series)

- Since the comment data of sequence programs can be stored in the GOT CF card to be displayed in the Ladder Monitor screen, the PLC memory used is greatly reduced.
- Device comments in the sequence programs written in Korean (Hangul) characters can also be displayed.

How to use the One-Touch Ladder Jump function

- Select [SP Function]-[Ladder Monitor] from the touch switch property dialog.

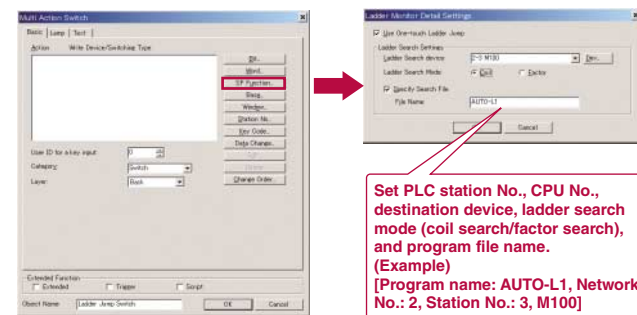

Set PLC station No., CPU No., destination device, ladder search mode (coil search/factor search), and program file name. (Example) [Program name: AUTO-L1, Network No.: 2, Station No.: 3, M100]

GT 16 GT 15
Monitor SFC programs on the GOT to make troubleshooting even easier
GOT1000 GRAPHIC OPERATION TERMINAL
SFC monitor function

MELSEC Q series PLC SFC programs (MELSAP3, MELSAP-L) can be monitored in a graphical format.

Easy monitoring of the program's progress

- SFC charts can be displayed from user-created screens or the utility menu. In user-created screens, setting program names and block numbers to touch switches makes it possible to jump to the relevant SFC programs, simply by touching the switches.
- Active steps are highlighted, and SFC programs can automatically be scrolled along with the progress of running programs, allowing quick and easy monitoring of the program status.

<SFC (Sequential Function Chart)>

- SFC programs express the equipment operation sequences in a flowchart format, making them easy to create and understand, even when created by someone else.
- Block: Indicates each process in the line.
 - Step: A unit to indicate the operation of the equipment that exists in each process. The more detailed controls are programmed in ladder programs.
 - Active block: Indicates the block where operation is currently in progress.
 - Active step: Indicates the step where operation is currently in progress.

* : Supported by the XGA/SVGA/VGA models.

- By simply touching a block tab or a block startup step, the screen display can be switched between the source and destination blocks in the SFC program. A new block appears in sequential tabs from the left, making it easy to return instantly to the jump source block.
- Touch a SFC chart or a zoom window to specify a device in order to display other sequence programs that use the specified device (by using the Ladder Monitor function).

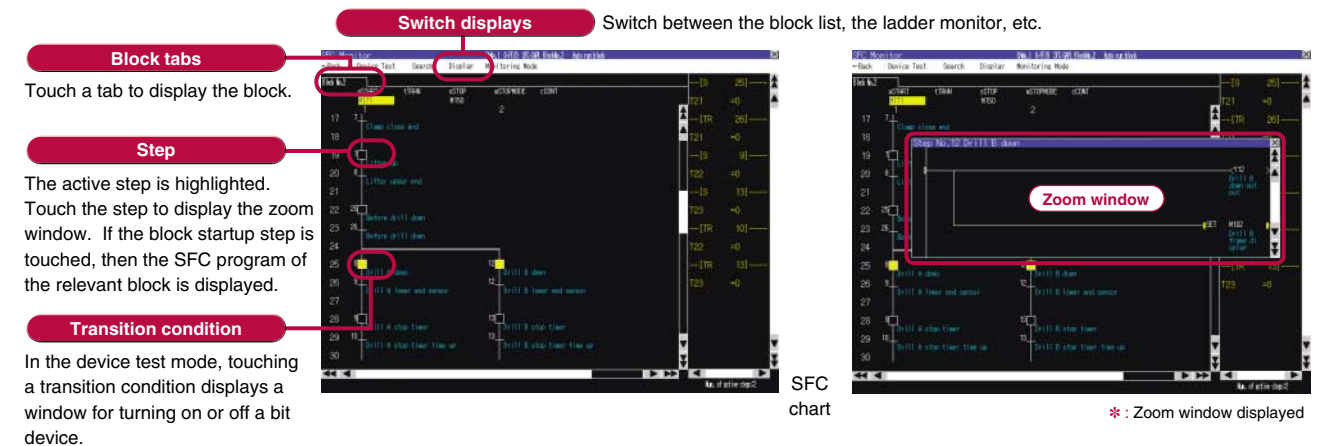

An array of displays permits the program's overall status to be seen at a glance

- The overall status of a program is easily analyzed by using various lists, even when the program has numerous blocks and steps.

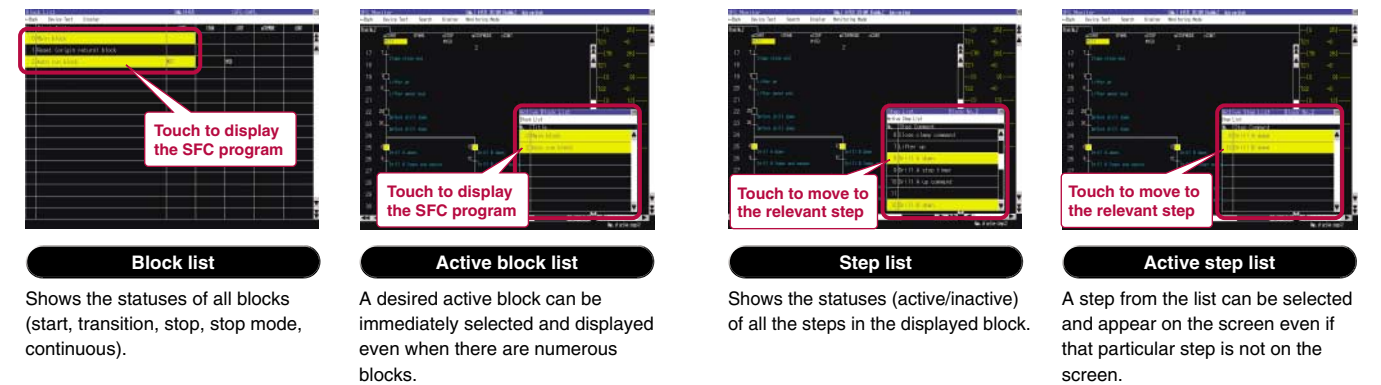

Easy device tests

- Device tests can be performed from the SFC program or the block list. It is convenient to execute active steps as a test.

An optional device may be necessary. For details, see "Selection of optional units and devices" (page 77).

Save program comments to a CF card in the GOT

- Programs can be read from the PLC CPU and saved on the CF card, eliminating the need for re-reading from the PLC CPU even after switching off the GOT power.
- Comments in sequence programs can be saved to the GOT CF card and displayed on the SFC monitor. This can save a significant amount of PLC CPU memory.

For Designers
 For Operators
 For Initial Startup & Adjustment Operators
 For Maintenance Personnel
 GT10
 Handy GOT
 GT-SoftGOT1000 Version2
 IQ Platform
 MELSEC Process Control + GOT1000
 List of Connectable Models, etc.

The GT10 enhances its specifications for a better selection

GT10 MODEL

Enhanced screen size lineup, ranging from small to medium

- The GT10 now offers a line up of models with a 5.7" screen, enabling free and flexible screen layout. The 4.5" and 3.7" wide screen models are now also available with a white frame.

GT1050/GT1055 5.7inch

- QVGA 320 × 240 dots
- Matrix touch panel
- Minimum touch key size: 16 × 16 dots
- Maximum number of touch keys: 50/Screen



- #### GT1030 4.5inch
- 288 × 96 dots
 - Matrix touch panel
 - Minimum touch key size: 16 × 16 dots
 - Maximum number of touch keys: 50/Screen



- #### GT1020 3.7inch
- 160 × 64 dots
 - Analog touch panel
 - Minimum touch key size: 2 × 2 dots
 - Maximum number of touch keys: 50/Screen

Similar dimensions to F900 Series allows for simple replacement without panel design changes*1

*1 : When the F940GOT is replaced with the GT1050/GT1055 or when the F930GOT is replaced with the GT1030

GT1050/GT1055

- The GT1050/GT1055 has the same panel mounting dimensions as the F940GOT.

F940GOT ▶ GT1050/GT1055

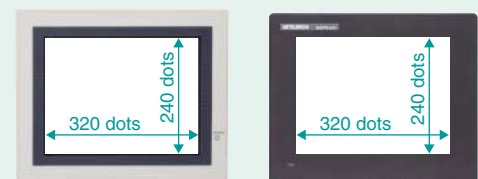

- QVGA 320 × 240 dots in each model

F940GOT ▶ GT1050/GT1055

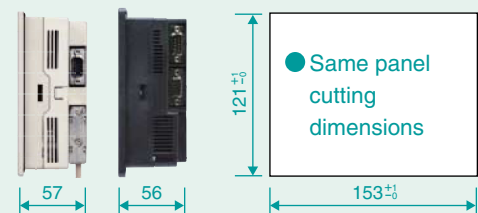

- Same connection direction for the communication connector

Unit: mm

GT1030

- The GT1030 has the same panel mounting dimensions as the F930GOT yet with improved resolution*2.

*2 : 1.44 times compared with the F930GOT

F930GOT ▶ GT1030

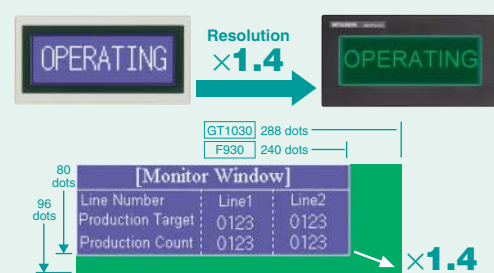

F930GOT ▶ GT1030

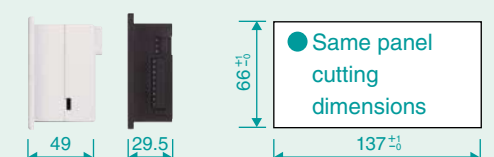

- Slim design

Unit: mm

Transparent function connecting the PLC via the GOT

- Through the personal computer communication connector at the rear of the GOT, users can debug, start, and adjust sequence programs.

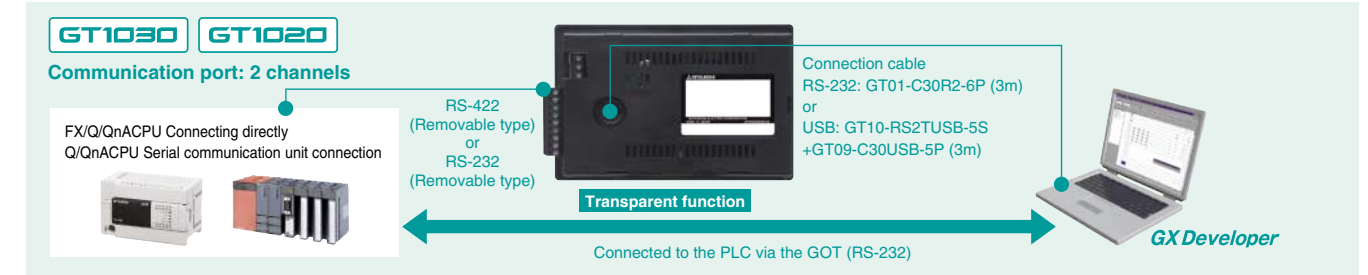
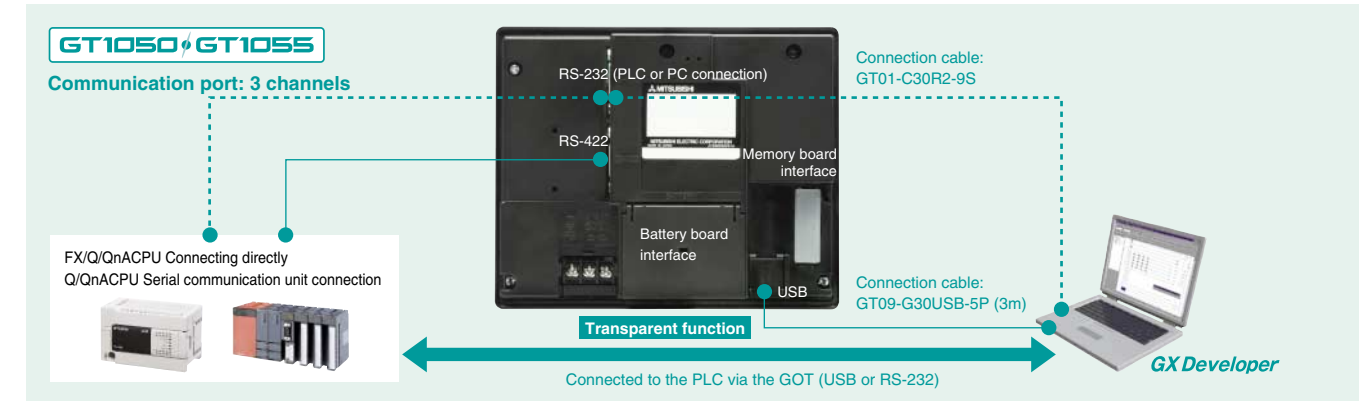

Multi-terminal connection*3

- Up to two GT10 units can be connected to one PLC unit even if the screen sizes differ. Thus enabling greater flexibility with terminal positioning.

*3 : The transparent function is not available when multiple units are connected. The USB interface is not available for connection of two units.

GT1050/GT1055

When RS-422 is used to connect the 1st unit*4



When RS-232 is used to connect the 1st unit*4



*4 : Refer to the connection manual for applicable models, required interface and compatibility with serial communication units (computer link units). The maximum length varies depending on the connected equipment. Refer to the connection manual for details.

*5 : A functional extension board or an adapter is necessary.

GT1030 GT1020

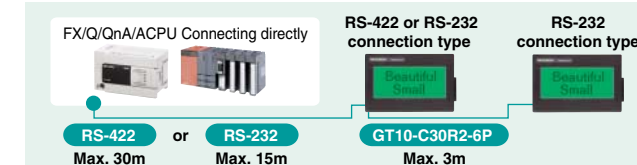

Versatile mounting

- Both horizontal and vertical mounting is available to the GT10 Series causing minimal impact on application design.



Power supply & communication

GT1020

The 5V DC type GOT draws power through the FX programming port communication cable. Additional power supply is not required.

- Power supply and communication

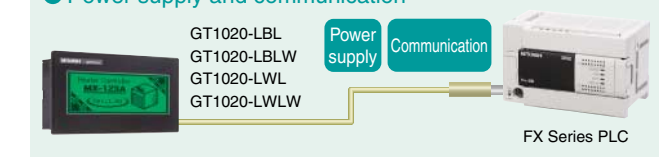

For Designers

For Operators

For Initial Startup & Adjustment Operators

For Maintenance Personnel

GT10

Handy GOT

GT-Soft/GT1000 Version2

IQ Platform

MELSEC Process Control + GOT1000

List of Connectable Models, etc.

Common software functionality

GT10 MODEL

Alternative start-up screen

- Alternative bitmap images can be displayed when the GOT starts. Images may include photos, company logos etc. (The logo label "GOT1000" can also be removed.)



Choose your font!

- A variety of fonts are available including the standard type set and the windows type set. When windows fonts are selected, italic, underlined, and underlined italic are also available.



Design unification using the parts library

- Lamps and switches can be selected from the Screen Design Software's built in library. Alternatively new parts can be downloaded from the web. Library images can be displayed in all colors.

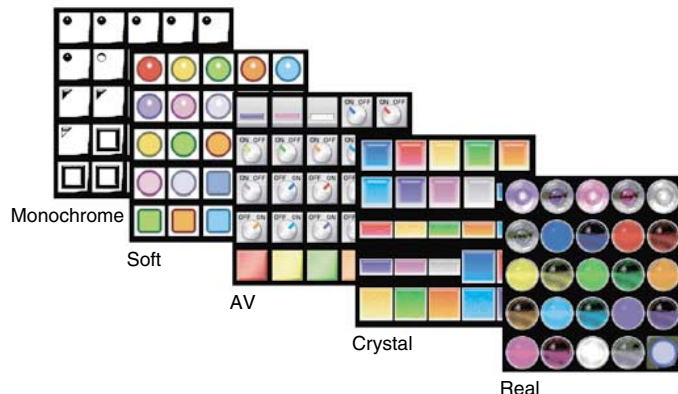

Multi action switch

- Because one switch can determine multiple functions, it is not necessary to overlay different switches types for each function. You can reduce loads on sequence programs by combining the settings of delay, repetition, interlock, etc. according to the operations within the PLC.

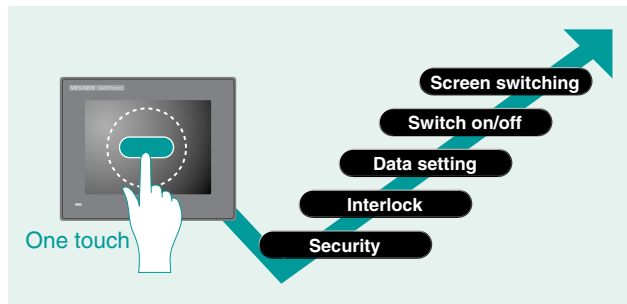

Format string function

- The GT10 can display characters (alphabets, numbers, kanji, and symbols) in the device value display.

When the formatted character string in the basic settings is set as follows



When the device value is "1234"

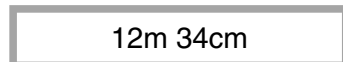

Simple set-up of language switching windows

- Language switching windows can be easily created allowing one language to be switched to another, for example English to Japanese. Up to 10 languages can be switched per comment group. Window switching can take place not only for languages but also for different applications.

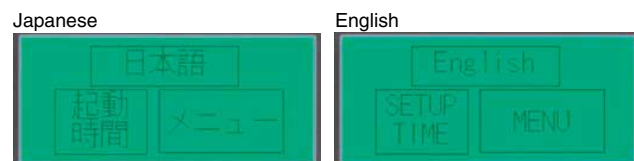

Characters from all over the world for people all over the world

The GOT1000 series can display a number of languages for a variety of countries and areas.



Device monitor function

- You can monitor the ON/OFF status of bit devices and values of word devices in FX/Q/QnA Series PLCs, as well as change the timer and counter values.

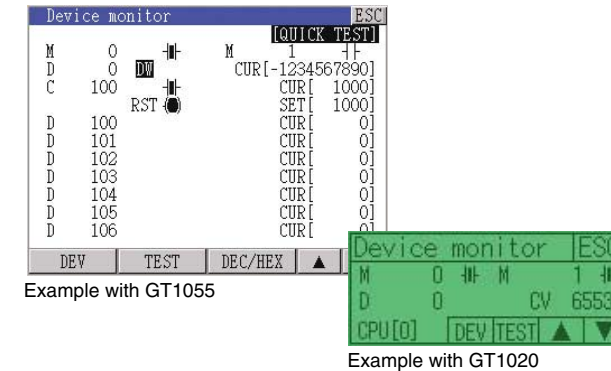

Preinstalled OS to enable immediate use

- Pre-installed OS**
The OS of the GOT is installed before shipment from the factory.
- Communication driver**
The communication driver installed before shipment is provided for an FX Series PLC. To connect a Q/QnA Series PLC, microcomputer board or other supported PLC device you have to install the required communication driver available from GT Designer2.

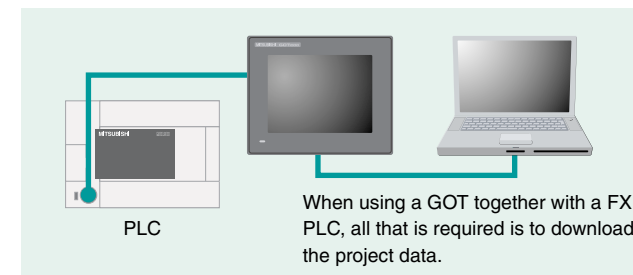

Sequence program edition



- You can edit sequence programs in the list format of the FX PLC in the GOT. This function is convenient for simple program changes at the local site.

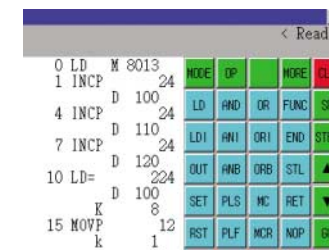

Simple data setting using the recipe function

- The GOT has a built-in memory for up to 4,000 points (corresponding to 16-bit word devices). Using this memory the GOT can transfer a range of values to and from the PLC.

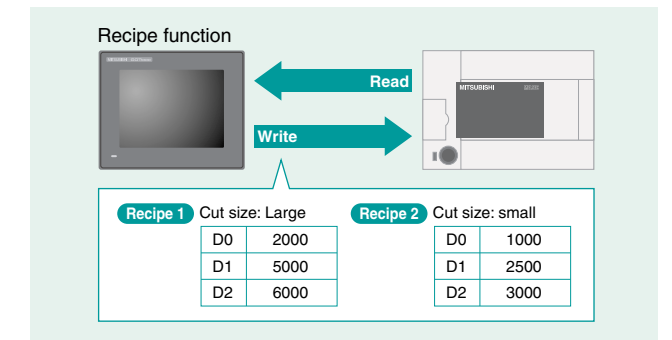

Alarm function

- The GOT offers alarm display, alarm history, and alarm scroll functions to enable display setting for each window. Language switching for alarms is also available.

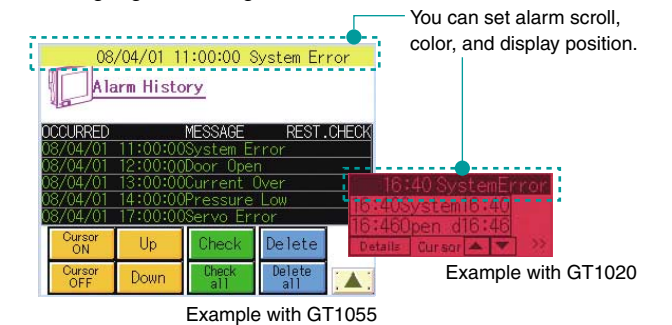

Screen save function

- The backlight ON/OFF setting achieves energy-saving whilst still enabling the GOT to function. The GOT screen can be controlled from the PLC, allowing backlight and alarm windows to be controlled in the event of an error.

Functionality

Category	Functionality
Common	<ul style="list-style-type: none"> Screen (base: max. 1,024 screens, window: max. 512 windows) Fonts (standard (6 x 8 dots: Gothic, 16 dots: Gothic, 12 dots: gothic [except GT1020])/high quality/TrueType/Windows) Screen switching function, screen call-up function, language switching function, password, system information, setting connected devices, and startup logo
Drawing and graphics	<ul style="list-style-type: none"> Straight lines, continuous lines, rectangular, polygons, chamfered quadrangles, circles, ellipses, arcs, elliptic arcs, circular sectors, and elliptic sectors Division indication Painting Images (BMP/DXF)
Objects	<ul style="list-style-type: none"> Comment registration (basic comments and comment groups) Parts registration Data computing function Offset function Security function Lamp indications Touch switches Numeric indications and input ASCII indications and input Clock function (GT1050, GT1055, GT1040, GT1045, GT1030: Integrated clock, GT1020: Read from the PLC clock) Comment displays Alarm list and alarm history Parts display Panel meters Trend graphs, kinked line graphs, bar graphs, statistic crossbar graphs, statistic circular graphs Status monitor function Recipe function (4,000 points) Time action function

*: See the manual for details.

Easily added functions make it simpler to use

GT10 MODEL

Enhanced window functions

GT Designer2 Ver.2.73B or later

- 512 windows are available.
- The window overlay function is available.
- The window superimpose function is provided.

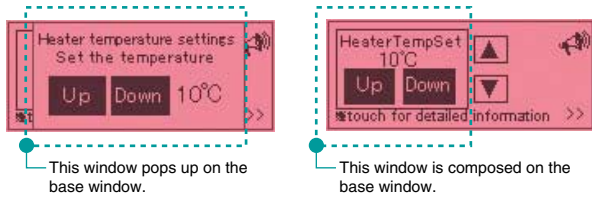

Connection to the Mitsubishi inverter series

GT Designer2 Ver.2.73B or later

The popular, favored GT10 series has become compatible with inverters.

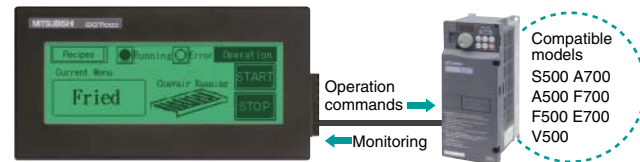

Connection to a barcode reader

GT Designer2 Ver.2.77F or later

- The RS-232 connection port for personal computer can be connected to a barcode reader.

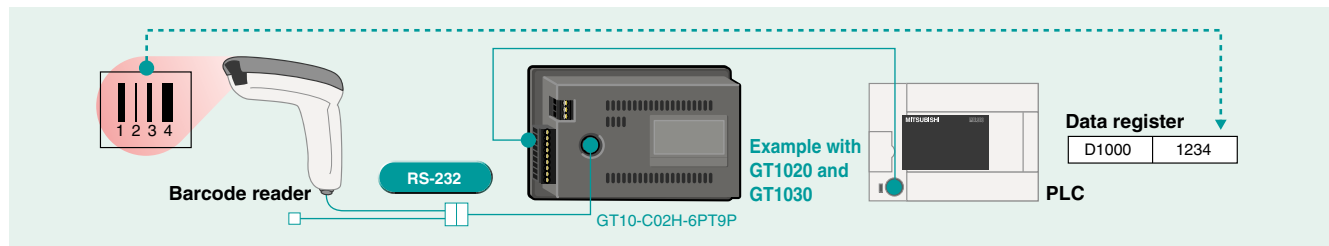

Data transfer for improved user-friendliness and flexibility

- Optional memory board and memory loader provide a convenient way to download project data and operating system to terminals without a PC. Furthermore when downloading to multiple units speed and efficiency is increased.

Data transfer memory board GT10-50FMB

GT1050 GT1055

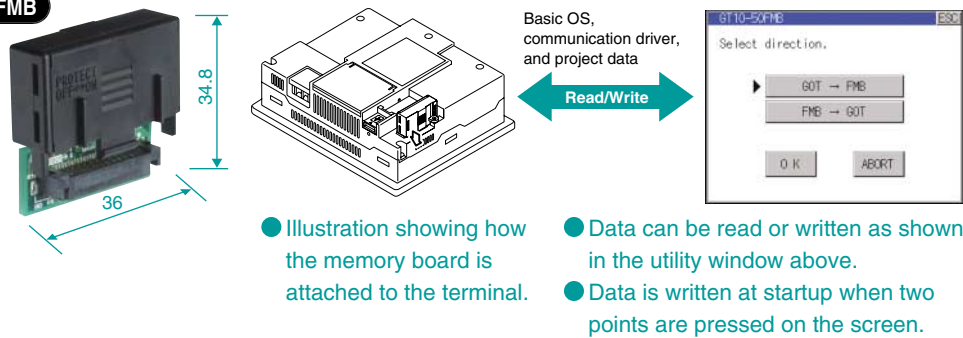

- Illustration showing how the memory board is attached to the terminal.
- Data can be read or written as shown in the utility window above.
- Data is written at startup when two points are pressed on the screen.

Memory loader GT10-LDR

GT1030 GT1020

- Has a compact design (70 × 110 mm), where the GOT transfer cable can be accommodated inside the body.
- Can write the basic OS, communication driver, and project data.
- Can read the project data and resource data.
- Offers simple switch type operation, where the write-protect switch prevents erroneous reading.
- Does not require power supply as power is supplied from the GOT or personal computer.

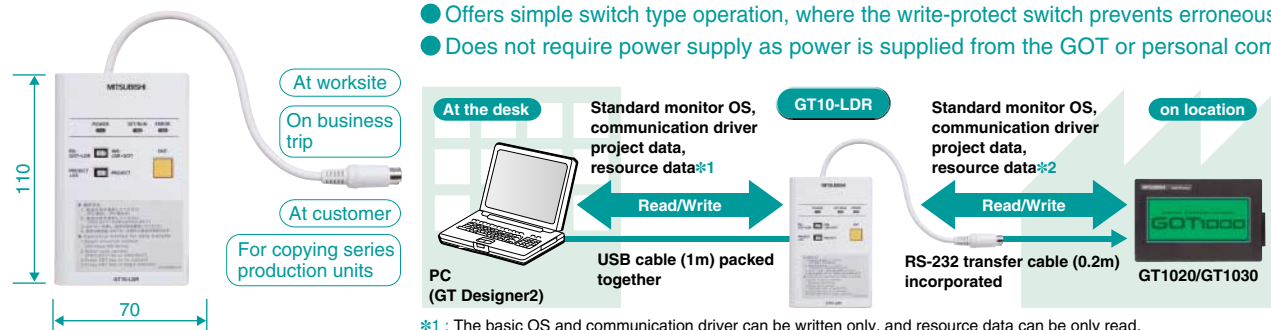

*1 : The basic OS and communication driver can be written only, and resource data can be only read.
*2 : Resource data can be only read.

Portable and wearable Handy terminal can also be mounted on a wall or a machine

Handy GOT

GT1155HS-QSBD/GT1150HS-QLBD

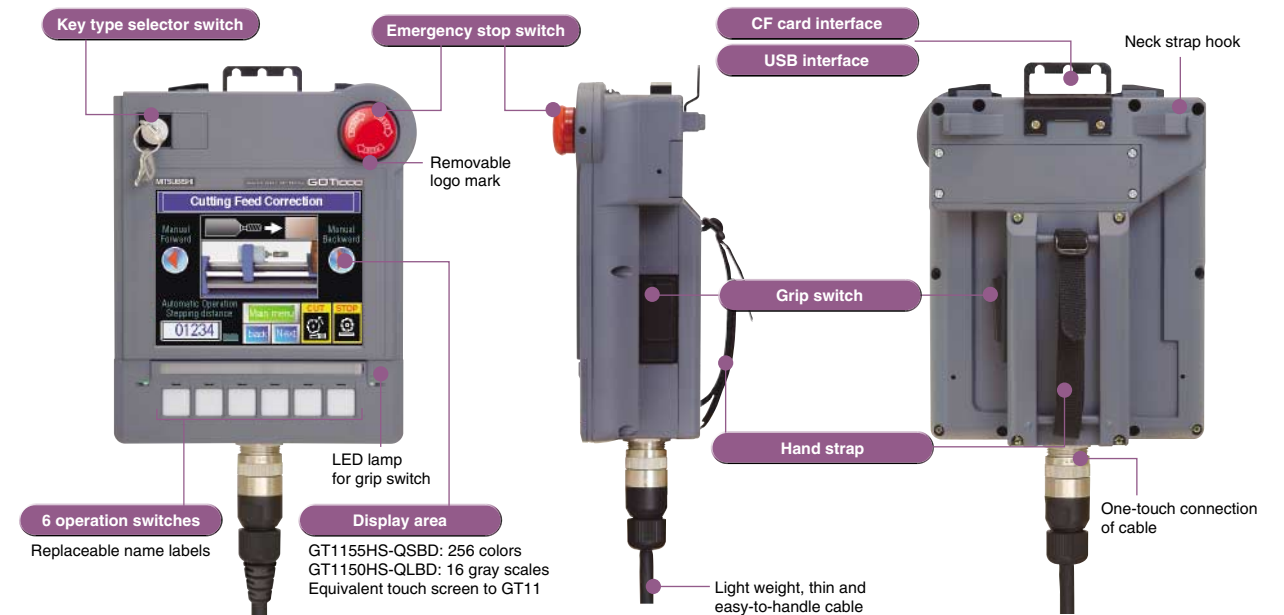

Display area equivalent to GT11

- The GT1155HS-QSBD has a 256-color display; the GT1150HS-QLBD has a 16 degree gray scale display.

Key type selector switch

- Restricts access of certain operations (manual/auto switching, mode selection, setup change, etc.) to authorized operators.

Emergency stop switch using two break contacts

- Improved safety by using two break contacts connected in series, either of which can execute a stop command when being switched off.

Grip switch

- The three position (OFF-ON-OFF) switch can be connected to external devices as a dead-man switch. The grip switch can be used for immediate execution of a command to stop a machine.

6 operation switches

- When wired directly to external devices, these switches can be used as pushbutton switches to operate and stop various machines. The operation switch name labels can be changed freely.
- The control panel is equipped with 6 LED lamps (green) for the operation confirmation of each of these switches.

CF card interface

- The CF card interface enables quick GOT data transfer.

USB interface

- The USB interface permits fast data transfer between GT Designer2 and the GOT.

RS-232 interface

- An RS-232 interface is provided for the GOT data transfer when the USB interface is not used.

RS-232/RS-422 communication

- Either RS-232 or RS-422 can be selected for communication with connected devices.

Optional devices

- Emergency stop switch guard (GT11H-50ESCOV)
- Connector conversion box for Handy GOT
- CF card
- Optional function board (GT11-50FNB)
- Replacement battery (GT11-50BAT)
- External connection cable
- Personal computer connection cable (RS-232 cable/USB cable)
- Protective sheet

For Designers
For Operators
For Initial Startup & Adjustment Operators
For Maintenance Personnel
GT10
Handy GOT
GT-Soft GOT1000 Version2
IQ Platform
MELSEC Process Control + GOT1000
List of Connectable Models etc.

Ensuring reliable coordination with controllers compatible with the iQ Platform, the GOT1000 represents all the controls.

iQ Platform

Mitsubishi FA Integrated Platform optimizes front line of production

"iQ Platform," the next generation integrated platform

- integrated Q
- improved Quality
- intelligent & Quick
- innovation & Quest

With high speed control and convenience fully assured, "controllers compatible with the iQ Platform" and the "GOT1000" are the keys to higher productivity and lower costs.

PLCs, motion controllers, CNCs, and robot controllers are integrated into one as a controller compatible with the iQ Platform. The GOT1000 can integrate different types of monitor units that were previously connected to each controller.

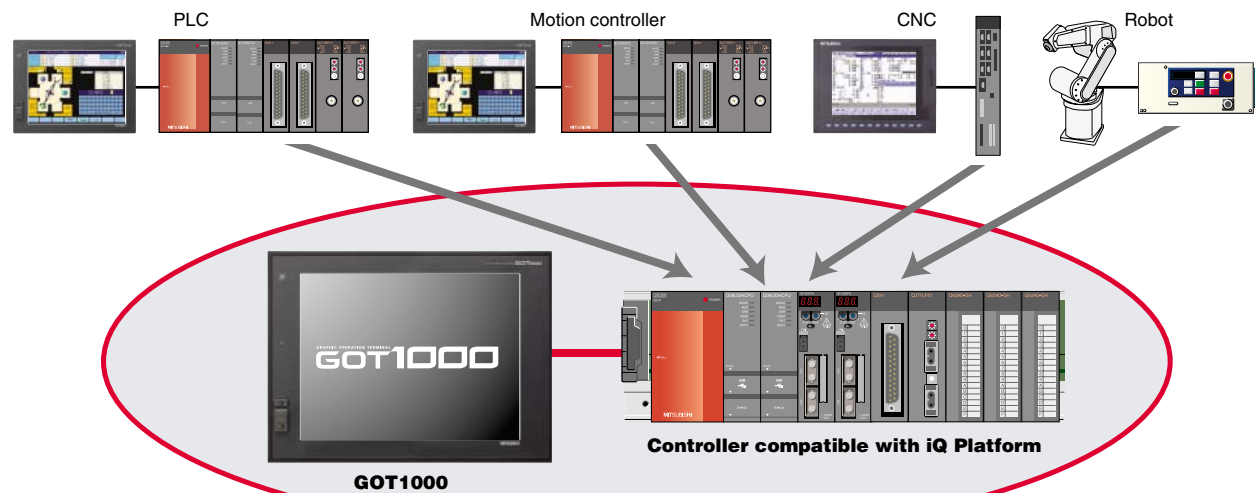

① Reducing engineering cost

The screen design software "GT Designer2" enables to create monitor screens for each controller.

② Reducing spare parts cost

One GOT1000 can integrate different types of monitor units connected to each controller, greatly reducing spare parts cost.

③ Powerful support for maintenance

The GOT1000 has a variety of useful maintenance functions such as the "Q motion monitor function" and "CNC monitor function," very capable of and reliable for troubleshooting. (GT16 and GT15 only)

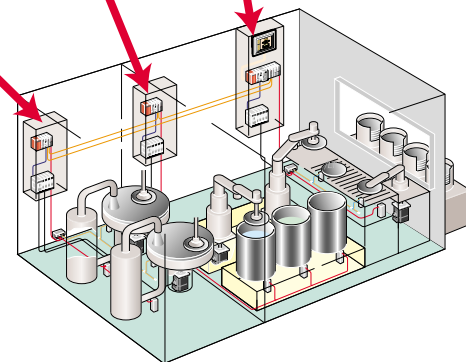

Example of created screen

* : Connectable models and usable functions vary depending on the GOT main unit. For more details, see "List of connectable models" (page 62), "Notes for use" (page 77) and "Function list" (page 82).

Flexibly interacting with process control Building up monitor systems without SCADA MELSEC process control + GOT1000

"MELSEC process control" was developed for process control with general-purpose PLCs. The GOT1000 can play an active role as the monitoring interface, offering various features and advantages such as excellent interaction that only a group of Mitsubishi brand units can develop, the ability to build up monitoring systems without SCADA, and many others.

Three benefits that MELSEC process control and GOT1000 (GT16/GT15) can offer.

① The PX Developer creates GOT process control screens automatically.

Based on the information such as tags defined by the PX Developer, process control monitor screens for the GOT can be created automatically, greatly reducing the man-hours for screen design. GT Designer2 can then customize the automatically created screens.

[Screen examples that can be created automatically]

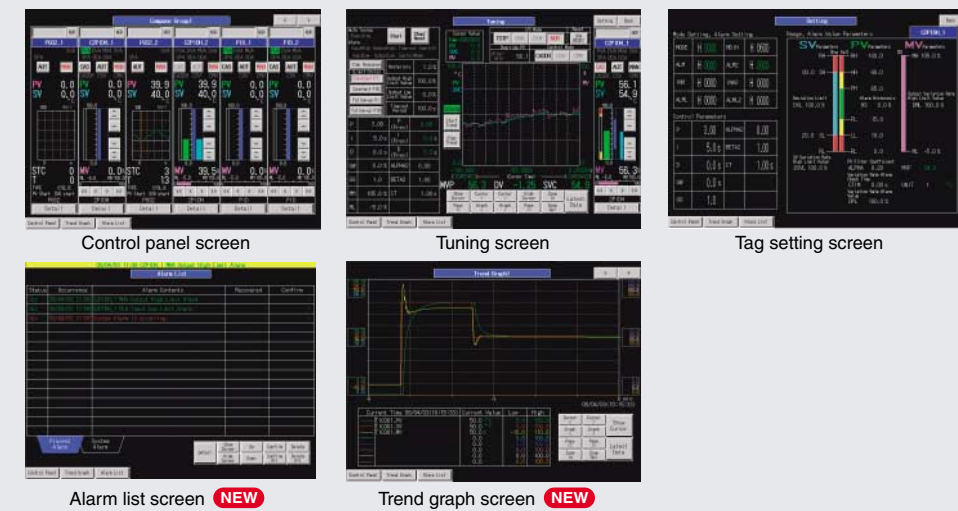

② Utilizing GOT1000 & SoftGOT1000 data

Only by using GT Designer2 and PX Developer, a process control monitor system can be developed for both a worksite (GOT1000) and a monitor room (GT SoftGOT1000). Screen data can be shared to monitor screens efficiently.

③ A variety of functions of GOT1000 that a process control CPU can also use.

Hooked up to the GOT1000, a process control CPU can use a variety of functions that are characteristic of the GOT1000 such as the backup and restoration functions.

Compatible with new process control CPUs (Q02PH/Q06PHCPU). Best fit for small-scale process equipment!

The worksite or the monitor room needs no SCADAs, making it simple and easy to build up a "process control monitor system."

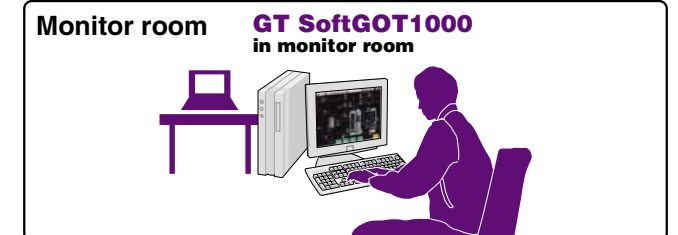
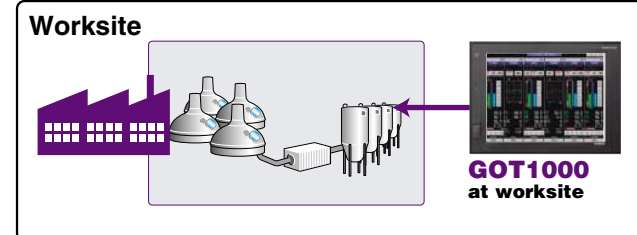

- Excellent anti-environment performance (IP67f) and operates in various kinds of worksites.
- The function to automatically generate process control screens enables process control monitor screens to be created simply and easily, which was previously a time consuming task.
- A variety of functions that are characteristic of the GOT1000 are available for use such as the operation log function, operator authentication, and backup/restoration functions.

- Best fit for monitoring in a monitor room because of being operable on a personal computer.
- Touch switches on the GT SoftGOT1000 can call up screens such as face plates and the alarm list of the PX Developer monitor tool.
- Since the GOT1000 screen data can be used for GT SoftGOT1000 without modification, no screens need to be created for a monitor room.

< For more details, see page 58 of this catalog.>

<For detailed descriptions on these functions, see PX Developer New Product Release No.308E and PX Developer Operating Manual (GOT Screen Generator).>

For Designers
 For Operators
 For Initial Startup & Adjustment Operators
 For Maintenance Personnel
 GT10
 Handy GOT
 GT SoftGOT1000 Version2
 iQ Platform
 MELSEC Process Control + GOT1000
 List of Connectable Models etc.

List of connectable models

For details of connection configurations, see the GOT1000 Series Handbook and the GOT1000 Series Connection Manual.

The GOT1000 series allows connection to Mitsubishi PLCs and a variety of other FA devices.

Third party PLCs/motion controllers The GOT can be connected with third party PLCs through RS-232 communication at up to 115.2kbps or Ethernet.

Manufacturer	Model name	GT16/GT15/GT11/GT10						
		Computer link connection		CPU direct connection		Ethernet connection		
		RS-422	RS-232	RS-422	RS-232			
OMRON	SYSMAC CPM	CPM1A				×		
		CPM1	×			○		
		CPM2A				○		
		CPM2C				×		
	SYSMAC CQM1H	CQM1H				×		
	SYSMAC CJ1	CJ1H				○		
		CJ1G				○		
		CJ1M		○	×			
	SYSMAC CP1	CP1H				×		
		CP1L	○					
	SYSMAC α	C200HX				○		
		C200HG				○		
		C200HE				×		
	SYSMAC CS1	CS1H						
		CS1G						
CS1D								
SYSMAC CVM1/CV	CV500				○			
	CV1000				○			
	CV2000	×	×	○				
	CVM1				○			
	CQM1				○			
	C200HS				○			
	C200H	○	○	×	×			
	C1000H				×			
	C2000H				×			
	C2000H				×			
KEYENCE	KV series	KV-700						
		KV-1000	○	○	×	○		
		KV-3000				×		
	KV-5000				×			
	SU series	SU-5E						
KOSTAC SU series	SU-6B	○	○	○	○			
	SU-5M							
	SU-6M							
	PZ3	×	×	○	○			
DirectLOGIC 205 series	D2-240			×				
	D2-250-1	○	○	○	○			
	D2-260				×			
DirectLOGIC 05 series	D0-05AA							
	D0-05AD							
	D0-05AR							
	D0-05DA	○	○	×	○			
	D0-05DD							
	D0-05DD-D							
	D0-05DR							
	D0-05DR-D							
DirectLOGIC 06 series	D0-06DD1							
	D0-06DD2							
	D0-06DR							
	D0-06DA	○	○	○	○			
	D0-06AR							
	D0-06AA							
	D0-06DD1-D							
	D0-06DD2-D							
SHARP	JW series	JW-21CUH	○	×	×	×		
		JW-31CUH						
		JW-50CUH						
		JW-22CU						
		JW-32CUH						
	Z series	Z-512J	×	×		○		
		JTEKT TOYOPUC series	PC3JG	TIC-6088	○	○	×	○
				TIC-6125				
				TIC-5339	○	○	○	○
				TIC-5783				
PC2J	THC-5070					○		
	THC-5169					○		
	THC-5173		○	○	×			
	THC-2764					×		
	THC-2994					×		
	THC-5053					×		
TOSHIBA PROSEC T series	T2 (PU224)				○			
	T2E	×	×		○			
	T3				○			
	T3H				×			
V series	model 3000 (S3)				○			
	model 2000 (S2)	×	×	○	×			
	model 2000 (S2T)				×			

Manufacturer	Model name	GT16/GT15/GT11/GT10				
		Computer link connection		CPU direct connection		Ethernet connection
		RS-422	RS-232	RS-422	RS-232	
TOSHIBA MACHINE	TCmini series	TC3-01				
		TC3-02				
		TC5-20	×	×	×	○
		TC6-00				
		TC8-00				
Hitachi Industrial Equipment Systems	Large-sized H series	H-302 (CPU2-03H)				
		H-702 (CPU2-07H)				
		H-1002 (CPU2-10H)				
		H-2002 (CPU-20H)	○	○	×	○
		H-4010 (CPU3-40H)				
		H-300 (CPU-03Ha)				
		H-700 (CPU-07Ha)				
		H-2000 (CPU-20Ha)				
		H-200 (CPU-02H, CPE-02H)				
		H-250 (CPU21-02H)				
Hitachi	H-200 to 252 series	H-252 (CPU22-02H)	×	×	×	○
		H-252B (CPU22-02HB)				
		H-252C (CPU22-02HC)				
		H-252C (CPE22-02HC)				
		H-20DR				
		H-28DR				
		H-40DR				
		H-64DR				
		H-20DT	×	×	×	○
		H-28DT				
Hitachi	H series board type	H-40DT				
		H-64DT				
		HL-40DR				
		HL-64DR				
		EH-CPU104				
		EH-CPU208				
		EH-CPU308				
		EH-CPU316				
		LQP510				
		LQP520				
Hitachi	S10V	LQP800	○	○	×	×
		LQP000				
		LQP010				
		LQP011				
Fuji Electric FA Components & Systems	MICREX-F	LQP120				
		F55				
		F70				
		F120S	○	○	×	×
Matsushita Electric Works	FP series	F140S				
		F15 S				
		FP0-C16CT				
		FP0-C32CT	×	×	×	○
		FP1-C24C				
		FP1-C40C				
		FP2				
		FP2SH				
		FP3	×	○	×	○
		FP5				
YASKAWA Electric	MP series	FP10 (S)				
		FP10SH				
		FP-M (C20TC)				
		FP-M (C32TC)	×	×	×	○
		FP-Σ				
		FP-X	○	○		
		GL120				
		GL130				
		GL60S	○		×	×
		GL60H				
YASKAWA Electric	CP series	GL70H				
		CP-9200SH	×	○		×
		CP-9300MS				
		MP920	○	○	×	
		MP930				
		MP940				
		PROGIC-8	×	×		×
		CP-9200 (H)				
		CP-312				
		MP2200	○	○		×
MP2300						

Manufacturer	Model name	GT16/GT15/GT11/GT10				
		Computer link connection		CPU direct connection		Ethernet connection
		RS-422	RS-232	RS-422	RS-232	
Yokogawa Electric	FA500	FA500		○	×	×
		F3SP05				
		F3SP08	○			○
		F3SP10	×			○
		F3SP20				×
		F3SP30				×
		F3FP36				×
		F3SP21				○
		F3SP25				○
		F3SP35	○		×	
		F3SP28				○
		F3SP38				○
		F3SP53				○
		F3SP58				○
		F3SP67	×	×		○
STARDOM	NFCP100	×	×	×	○	
	NFJT100				○	
Allen-Bradley (Rockwell Automation, Inc)	SLC500 series	SLC500-20				
		SLC500-30				
		SLC500-40				
		SLC5/01	×	×	×	○
		SLC5/02				○
		SLC5/03				○
		SLC5/04				○
		SLC5/05				○
		1761-L10BWA				
		1761-L10BWB				
Allen-Bradley (Rockwell Automation, Inc)	MicroLogix 1000 series (digital CPU)	1761-L16AWA				
		1761-L16BWA				
		1761-L16BWB				
		1761-L16BBB				
		1761-L32AWA				
		1761-L32BWA	×	×	×	○
		1761-L32BWB				○
		1761-L32BBB				○
		1761-L32AAA				
		1761-L20AWA-5A				
Allen-Bradley (Rockwell Automation, Inc)	MicroLogix 1000 series (analog CPU)	1761-L20BWA-5A				
		1761-L20BWB-5A				
		1762-L24BWA				
Allen-Bradley (Rockwell Automation, Inc)	MicroLogix 1200 series	1764-LSP				
		1756-L				
		1756-L1M1				
		1756-L1M2				
		1756-L1M3				
		1756-L61				
		1756-L62				
		1756-L63				
		1756-L55M12	×	×	×	○
		1756-L55M13				
Allen-Bradley (Rockwell Automation, Inc)	CompactLogix series	1756-L55M14				
		1756-L55M16				
		1756-L55M22				
		1756-L55M23				
		1756-L55M24				
		1769-L31				
		1769-L32E	×	×	×	○
		1769-L32C				○
		1769-L35E				○
		1769-L35CR				×
Allen-Bradley (Rockwell Automation, Inc)	FlexLogix series	1794-L33	×	×	×	○
		1794-L34				×

Manufacturer	Model name	GT16/GT15/GT11/GT10						
		Computer link connection		CPU direct connection		Ethernet connection		
		RS-422	RS-232	RS-422	RS-232			
GE Fanuc Automation Corporation	Series 90-30	IC693CPU311						
		IC693CPU313						
		IC693CPU323						
		IC693CPU350						
		IC693CPU360	○	○	×	×		
		IC693CPU363						
		IC693CPU366						
		IC693CPU367						
		IC693CPU374						
		IC697CPU731						
		IC697CPX772						
		IC697CPX782						
		IC697CPX928						
		IC697CPX935						
		GE Fanuc Automation Corporation	Series 90-70	IC697CPU780	○	○	×	×
IC697CGR772								
IC697CGR935								
IC697CPU788								
IC697CPU789								
IC697CPM790								
IC200UAA003	○			○	○			
IC200UAR014								
IC200UDD104								
IC200UDD112								
IC200UDR001								
IC200UDR002								
IC200UDR003								
IC200UAL004								
IC200UAL005								
LS Industrial Systems	VersaMax Micro	IC200UAL006	×	×				
		IC200UAA007						
		IC200UAR028						
		IC200UDD110						
		IC200UDD120						
		IC200UDD212						
		IC200UDR005						
		IC200UDR006						
		IC200UDR010						
		IC200UDD064						
		IC200UDD164	○	○				
		IC200UDR164						
		IC200UDR064						
		LS Industrial Systems	Modicon Premium	K300S				
				K4P-15S		</		

List of connectable models

For details of connection configurations, see the GOT1000 Series Handbook and the GOT1000 Series Connection Manual.

Modules usable when connected with a third party computer link and Ethernet modules

Manufacturer	RS-422	RS-232	Ethernet
OMRON Host link unit/ communication unit/ communication board	C200H-LK202-V1 C500-LK201-V1 COM1-SCB41 CJ1W-SCU41 CJ1W-SCU21-V1-CP1W-EXT01 CS1W-SCB41 C200HW-COM03 C200HW-COM06 CP1W-CIF11	C200H-LK201-V1 C500-LK201-V1 CS1W-SCU21 CS1W-SCB21 CS1W-SCB41 CJ1W-SCU21-V1 CJ1W-SCU21-V1-CP1W-EXT01 C200HW-COM02 C200HW-COM05 C200HW-COM06 COM1-CIF01 COM1-CIF02 COM1-SCB41 CPM1-CIF01 CPM2C-CN111 CPM2C-CIF01-V1 CP1W-CIF01	—
KEYENCE Multi-communication unit	KV-L20R KV-L20 KV-L20V	KV-L20R KV-L20 KV-L20V	—
KOYO ELECTRONICS INDUSTRIES Data communication module/ serial data communication module	U-01DM D2-DCM D0-DCM	U-01DM D2-DCM D0-DCM	—
SHARP Link unit	JW-21CM JW-10CM ZW-10CM	—	—
JTEKT Link unit	THU-2755 THU-2927 THU-5139	—	—
Hitachi Industrial Equipment Systems Intelligent serial port module	COMM-H COMM-2H	COMM-H COMM-2H	—
Hitachi Communication module	LOE565 LOE165	LOE560 LOE060 LOE160	—
Manufacturer	RS-422	RS-232	Ethernet
Fuji Electric FA Components & Systems	RS-232C interface card RS-232C/485 interface capsule General interface module	— FFK120A-C10	NV1L-RS2 FFK120A-C10
Matsushita Electric Works Computer communication unit	NC1L-RS4 FFU120B	NC1L-RS2 FFU120B	—
YASKAWA Electric MEMOBUS module/ communication module	JAMSC-120NOM27100 JAMSC-IF612 2171F 2171F-01	AFP2462 AFP3462 AFP5462 AFPX-COM1 AFPX-COM2 AFPX-COM4	2181F 2181F-01
Yokogawa Electric Personal computer link module/ Ethernet interface module	LC02-0N F3LC11-2N	LC01-0N LC02-0N F3LC01-1N F3LC11-1N F3LC11-1F F3LC12-1F	F3LE01-5T F3LE11-0T F3LE12-0T
Allen-Bradley (Rockwell Automation, Inc.) EtherNet/IP communication module	—	—	1756-ENBT
GE Fanuc Automation Corporation Communication module	IC693CMM311 IC697CMM711	IC693CMM311 IC697CMM711	—
LS Industrial Systems	Cnet communication unit G6L-CUEC G4L-CUEA	G7L-CUEC G7L-CUEB	—
Schneider Electric SA Ethernet unit	—	—	TSX ETY 4102 TSX ETY 5102 140 NOE 771 00 140 NOE 771 10 140 NWM 100 00

Temperature controllers/indicating controllers

The GOT can be used to log data, set parameters, and display alarms.

Manufacturer	Model name	GT16/GT15/GT11				
		RS-485	RS-422	RS-232		
OMRON	Thermac NEO	E5AN E5EN E5CN E5GN	○ (2-wire type) *1	×	○ *2	
	In-Panel NEO	E5ZN	○ (2-wire type) *1	×	○ *2	
	ACS-13A series	ACS-13A /M, C5	○ (2-wire type) *1	×	○ *2	
	DCL-33A series	DCL-33A /M, C5	○ (2-wire type) *1	×	○ *2	
	JC series	JCS-33A /M, C5 JCR-33A /M, C5 JCD-33A /M, C5	○ (2-wire type) *1	×	○ *2	
	JCM-33A series	JCM-33A /M, C5	○ (2-wire type) *1	×	○ *2	
	FCR-100 series	FCR-13A /M, C FCR-13A /M, C5 FCR-15A /M, C FCR-15A /M, C5	○ (2-wire type) *1	×	○ *2	
	FCD-100 series	FCD-13A /M, C FCD-13A /M, C5 FCD-15A /M, C FCD-15A /M, C5	○ (2-wire type) *1	×	○ *2	
	FCR-23A series	FCR-23A /M, C FCR-23A /M, C5	○ (2-wire type) *1	×	○ *2	
	PC-900 series	PC935 /M, C5 PC955 /M, C PC955 /M, C5	○ (2-wire type) *1	×	○ *2	
Shinko Technos	PCD-300 series	PCD-33A /M, C5	○ (2-wire type) *1	×	○ *2	
	FIR series	FIR-201-M, C FIR-201-M, C5	○ (2-wire type) *1	×	○ *2	
	JIR-301-M series	JIR-301-M /M, C5	○ (2-wire type) *1	×	○ *2	
	LT300 series	LT350, LT370	○ (2-wire type) *1	×	○ *2	
	LT400 series	LT450, LT470	○ (2-wire type) *1	×	○ *2	
	DZ1000 series	DZ1000 *7	○ (2-wire type) *1	×	○ *2	
	DZ2000 series	DZ2000 *7	○ (2-wire type) *1	×	○ *2	
	LT230 series	LT230	○ (2-wire type) *1	×	○ *2	
	LT830 series	LT830	○ (2-wire type) *1	×	○ *2	
	GT120 series	GT120	○ (2-wire type) *1	×	○ *2	
Fuji Electric Systems	Micro Controller X	PXR PXR3/4/5/9 PXG PXG4/5/9 PXH PXH9	○ (2-wire type) *1	×	○ *2	
YAMATAKE	SDC	SDC20/21 SDC30/31 SDC40A/40B/40G SDC15 SDC25/26 SDC35/36	○ (4-wire type) ○ (2-wire type) *1	×	○ *2	
	DMC	DMC10	○ (2-wire type) *1	×	○ *2	
	Manufacturer	Model name	RS-485	RS-422	RS-232	
	Yokogawa	GREEN series	UT320 UT321 UT350 UT351 UT420 UT450 UT520 UT550 UT551 UT750 UP350 UP351 UP550 UP750 UM330 UM331 UM350 UM351 US1000	○ (2-wire type) *1 /4-wire type	×	○ *2
		UT100 series	UT130 UT150 UT152 UT155 UP150	○ (2-wire type) *1	×	○ *2
UT2000 series		UT2400 UT2800	○ (4-wire type)	×	○ *2	
SR Mini HG series		H-PCP-J H-PCP-A, H-PCP-B	○ (2-wire type) *1	○	○	
SRZ series		Z-TIO, Z-DIO	○ (2-wire type) *1 *6	○ *5	○ *2	
CB series (to MODBUS® communication specification)		CB100 CB400 CB500 CB700 CB900	○ (2-wire type) *1	×	○ *2	
RKC Instrument		SR Mini HG series	H-PCP-J H-PCP-A, H-PCP-B	○ (2-wire type) *1	○	○
SRZ series		Z-TIO, Z-DIO	○ (2-wire type) *1 *6	○ *5	○ *2	
CB series (to MODBUS® communication specification)		CB100 CB400 CB500 CB700 CB900	○ (2-wire type) *1	×	○ *2	

- *1: Supported by GT16 and GT15 only.
- GT16: Use RS-422/485 interface or GT15-RS4-TE. GT-15-RS4-9S is not applicable.
- GT15: Use GT15-RS4-TE. GT-15-RS4-9S is not applicable.
- *2: If the temperature controller/indicating controller is designed for RS-485, use the RS-232/RS-485 converter supplied by the manufacturer.
- *3: If the temperature controller/indicating controller is designed for RS-422, use the RS-232/RS-422 converter supplied by the manufacturer.
- *4: Only indicating controllers with RS-232 serial communication function can be connected.
- *5: Use a communication extension module (Z-COM).
- *6: Use a communication extension module (Z-COM) depending on the temperature controller system configuration.
- *7: Select a model name that supports the MODBUS® communication function.

Specifications

GT16

General specifications

Item	Specification	
Operating ambient temperature*1	Display: 0°C to 50°C Other than display: 0°C to 55°C	
Storage ambient temperature	-20°C to 60°C	
Operating ambient humidity	10 to 90%RH, no condensation	
Storage ambient humidity	10 to 90%RH, no condensation	
Vibration resistance	Conforming to JIS B 3502 and IEC 61131-2	
	Under intermittent vibration	Frequency: 5 to 9Hz, Acceleration: 9 to 150Hz, 9.8m/s ²
	Under continuous vibration	Frequency: 5 to 9Hz, Acceleration: 9 to 150Hz, 4.9m/s ²
	Sweep count	10 times in each of X, Y and Z directions
Impact resistance	Conforming to JIS B 3502 and IEC 61131-2 (147m/s ² , 3 times in each of X, Y and Z directions)	
Operating atmosphere	No corrosive gas	
Operating altitude*2	2000m or less	
Installation location	In control panel	
Overvoltage category*3	II or lower	
Contamination level*4	2 or less	
Cooling method	Self-cooling	
Grounding	Type D grounding (100Ω or less). Connect to panel if unable to ground.	

- *1: The maximum operating ambient temperature should be 5°C lower than that shown in the table on the left when connecting to a multimedia unit (GT16M-MMR), MELSECNET/H communication unit (GT15-J71LP23-25 or GT15-J71BR13), or CC-Link communication unit (GT15-J61BT13).
- *2: Do not operate or store the GOT unit in pressurized environments where the pressure exceeds the 0m elevation atmospheric pressure, as this could result in abnormal operation.
- *3: Assuming that the device is connected at some point between a public power distribution network and local system equipment. Category II applies to devices that are supplied with power from fixed equipment. The surge withstand voltage is 2500V for devices with ratings up to 300V.
- *4: Index that indicates the level of foreign conductive matter in the operating environment of device. Contamination level 2 denotes contamination by non-conductive matter only, though momentary conductivity may occur due to occasional condensation.

Do not use or store the GOT under direct sun light or in an environment with excessively high temperature, dust, humidity or vibration.

Performance specifications

Item	Specification	
	GT1695M-XTBA GT1695M-XTBD	GT1685M-STBA GT1685M-STBD
Display *1	Type	TFT color LCD (high-brightness, wide viewing angle)
	Screen size	15"
	Resolution	XGA: 1024 × 768 [dots] SVGA: 800 × 600 [dots]
	Display size	304.1(W) × 228.1(H)[mm] 246(W) × 184.5(H)[mm]
	No. of displayed characters	16-dot standard font: 64 chars. × 48 lines (2-byte) 12-dot standard font: 85 chars. × 64 lines (2-byte)
	Display colors	65,536 colors
	View angle*2	Right/left: 75°, Up: 50°, Down: 60° Right/left: 80°, Up: 60°, Down: 80°
	Intensity	450 [cd/m ²] 470 [cd/m ²]
	Intensity adjustment	8-step adjustment
	Life	Approx. 52,000 hours (operating ambient temperature: 25°C)
Backlight	Cold-cathode fluorescent tube (replaceable), with backlight OFF detection function. Backlight off time and screen save time can be set.	
	Life*3	Approx. 50,000 hours or more (Time for display intensity reaches 50% at operating ambient temperature of 25°C)
Touch panel	Type	Analog resistive type
	Key size	Min. 2 × 2 [dots] (per key)
	No. of simultaneous touch points	Simultaneous touch prohibited*4 (1 point only)
Human sensor	Life	1,000,000 times or more (operating force 0.98N or less)
	Detection distance	1 [m]
	Detection range	Right/left/up/down: 70°
Memory *5	Detection delay time	0 to 4 [sec]
	Detection temperature	Temperature difference to be 4°C or more between human body and ambient air
	C drive	15MB built-in flash memory (for saving project data and OS)
Battery	Life (No. of writings)	100,000 times
	Backed up data	GT15-BAT type lithium battery
	Life	Clock data, maintenance time notification data and system log data (Approx. 5 years (operating ambient temperature: 25°C))
RS-232	Transmission speed	RS-232, 1ch Transmission speed: 115200/57600/38400/19200/9600/4800bps, Connector shape: D-sub 9-pin (male)
	Application	Application: Communication with connected devices, connection to personal computer (project data upload/download, OS installation, FA transparent function)
RS-422/485	Transmission speed	RS-422/485, 1ch Transmission speed: 115200/57600/38400/19200/9600/4800bps, Connector shape: 14-pin (female)
	Application	Application: Communication with connected devices
Built-in interface	Ethernet	Data transfer system: 100BASE-TX, 1ch Connector shape: RJ-45 (modular jack) Application: Communication with connected devices, gateway function, connection to personal computer (project data upload/download, OS installation, MES interface function)
	USB	USB (full-speed 12Mbps), host 1ch Connector shape: TYPE-A Application: Data transfer and storage USB (full-speed 12Mbps), device 1ch Connector shape: TYPE Mini-B Application: Connection to personal computer (project data upload/download, OS installation, FA transparent function)
CF card	Optional function board	Compact flash slot, 1ch, Connector shape: TYPE I Application: Data transfer, data storage, GOT startup
	Extension unit	1ch for optional function board installation
Buzzer output	Single tone (tone length adjustable)	
Protective construction	JEM1030 Front: IP67*6 In panel: IP2X	
External dimensions (without USB port cover)	397(W) × 296(H) × 61(D)[mm]	316(W) × 242(H) × 52(D)[mm]
Panel cut dimensions	383.5(W) × 282.5(H)[mm]	302(W) × 228(H)[mm]
Weight (excl. mounting brackets)	5.0[kg]	2.7[kg]
Applicable software packages	Screen design software	GT Designer2 Version 2.90U or later
	Simulation software	GT Simulator2 Version 2.90U or later

Power supply specifications

Item	Specification			
	GT1695M-XTBA	GT1685M-STBA	GT1695M-XTBD	GT1685M-STBD
Input power supply voltage	100 to 240VAC (+10%, -15%)	24VDC (+25%, -20%)	—	
Input frequency	50/60Hz ±5%	—		
Input maximum apparent power	150VA (at max. load)	110VA (at max. load)	—	
Power consumption	64W or less	46W or less	60W or less	40W or less
	38W or less	32W or less	30W or less	26W or less
Inrush current	26A or less (4ms, at max. load)	12A or less (75ms, at max. load)	11A or less (40ms, at max. load)	—
	Permissible instantaneous failure time	Within 20ms (100VAC or more)	Within 10ms	
Noise resistance	Noise voltage 1500Vp-p, noise width 1μs by noise simulator with noise frequency 25 to 60Hz	Noise voltage 500Vp-p, noise width 1μs by noise simulator with noise frequency 25 to 60Hz	—	
Withstand voltage	1500VAC for 1 minute between power supply terminal and ground	500VDC for 1 minute between power supply terminal and ground		
Insulation resistance	10MΩ or higher with an insulation resistance tester (500VDC between power supply terminal and ground)			
Applicable wire size	0.75 to 2 [mm ²]			
Clamp terminal	Clamp terminals for M3 screw RAV1.25-3, V2-S3.3, V2-N3A, FV2-N3A			
Tightening torque (terminal block's terminal screws)	0.5 to 0.8 [N·m]			

Component names

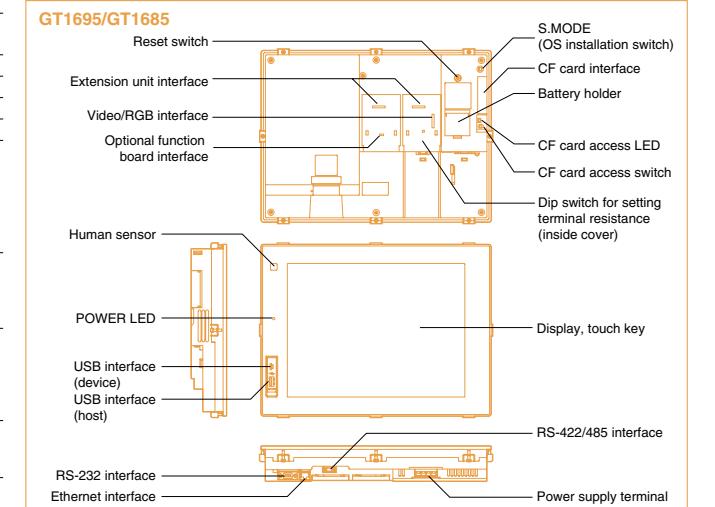

- *1: On LCD screens, bright dots (permanently lit) and black dots (not to be lit) generally appear. Because the large number of display elements exist on an LCD screen, it is not possible to reduce appearance of the bright and black dots to zero. Flickering may occur depending on the display colors. Note that the existence of bright and black dots is a standard characteristic of LCD screens, and it does not mean that the products are defective or damaged.
- *2: LC panels have characteristics of tone reversal. Note that even within the indicated view angles, the screen display may not be clear enough depending on the display color.
- *3: Using the GOT screen save/backlight OFF functions prevents screen burn-in and extends the backlight life.
- *4: An analog resistive touch display is used. When 2 points on the screen are touched simultaneously, if a switch is located the middle of the 2 points then the switch will be activated. Therefore, avoid touching 2 points on the screen simultaneously.
- *5: The memory is a ROM that permits overwriting of new data without having to delete the existing data.
- *6: With the USB environmentally protective cover is on, pressing firmly the portion marked "△" makes it conform to IP67 (JEM1030). (The USB interface conforms to IP2X (JEM1030) when a USB cable or a USB memory is connected.) However, this does not guarantee protection in all users' environments. The unit may not be used in an environment where it is exposed to splashing oil or chemicals for a long time or it is soaked with oil mist.

For Designers

For Operators

For Initial Startup & Adjustment Operators

For Maintenance Personnel

GT10

Handy GOT

GT-SoftGOT1000 Version2

IQ Platform

MELSEC Process Control +GOT1000

List of Connectable Models, etc.

GT10

GT10

GT10

Specifications

GT15

General specifications

Item	Specification	
Operating ambient temperature*1	0°C to 50°C	
Other than display	0°C to 55°C	
Storage ambient temperature	-20°C to 60°C	
Operating ambient humidity*2	10 to 90%RH, no condensation	
Storage ambient humidity*2	10 to 90%RH, no condensation	
Vibration resistance*3	Conforming to JIS B 3502 and IEC 61131-2	
	Under intermittent vibration	Frequency: 5 to 9Hz Acceleration: 9.8m/s ² Half amplitude: 3.5mm
	Under continuous vibration	Frequency: 5 to 9Hz Acceleration: 9.8m/s ² Half amplitude: 1.75mm
	Under continuous vibration	Frequency: 9 to 150Hz Acceleration: 4.9m/s ² Half amplitude: -
	Under continuous vibration	Frequency: 9 to 150Hz Acceleration: 4.9m/s ² Half amplitude: -
Impact resistance	Conforming to JIS B 3502 and IEC 61131-2 (147m/s ² , 3 times in each of X, Y and Z directions)	
Operating atmosphere	No corrosive gas	
Operating altitude*4	2000m or less	
Installation location	In control panel	
Overvoltage category*5	II or lower	
Contamination level*6	2 or less	
Cooling method	Self-cooling	
Grounding	Type D grounding (100Ω or less). Connect to panel if unable to ground.	

- *1: The maximum operating ambient temperature should be 5°C lower than that shown in the table on the left when connecting to a MELSECNET/H communication unit (GT15-J71LP23-25 or GT15-J71BR13), or CC-Link communication unit (GT15-J61BT13).
- *2: Water bulb temperature for STN display type must be 39°C or lower.
- *3: Refer to the Communication Unit User's Manual for vibration resistance specifications when using the MELSECNET/10 communication unit (GT15-75J71LP23-Z or GT15-75J71BR13-Z) or CC-Link communication unit (GT15-75J61BT13-Z). (The specifications of communication units are different from those of the GOT main unit.)
- *4: Do not operate or store the GOT unit in pressurized environments where the pressure exceeds the 0m elevation atmospheric pressure, as this could result in abnormal operation.
- *5: Assuming that the device is connected at some point between a public power distribution network and local system equipment. Category II applies to devices that are supplied with power from fixed equipment. The surge withstand voltage is 2500V for devices with ratings up to 300V.
- *6: Index that indicates the level of foreign conductive matter in the operating environment of device. Contamination level 2 denotes contamination by non-conductive matter only, though momentary conductivity may occur due to occasional condensation.

Do not use or store the GOT under direct sun light or in an environment with excessively high temperature, dust, humidity or vibration.

Performance specifications

Item	Specification							
	GT1595-VTBD	GT1585V-STBA GT1585V-STBD	GT1575V-STBA GT1575V-STBD	GT1575-VTBA GT1575-VTBD	GT1575-VNBA GT1575-VNBD	GT1572-VNBA GT1572-VNBD	GT1565-VTBA GT1565-VTBD	GT1562-VNBA GT1562-VNBD
Type	TFT color LCD (high-brightness, wide viewing angle)				TFT color LCD		TFT color LCD (high-brightness, wide viewing angle)	TFT color LCD
Screen size	15"		12.1"		10.4"		8.4"	
Resolution	XGA: 1024 × 768 [dots]		SVGA: 800 × 600 [dots]		VGA: 640 × 480 [dots]			
Display size	304.1(W) × 228.1(H) [mm]		246(W) × 184.5(H) [mm]		211(W) × 158(H) [mm]		171(W) × 128(H) [mm]	
No. of displayed characters	16-dot standard font: 64 chars. × 48 lines (2-byte) 12-dot standard font: 85 chars. × 64 lines (2-byte)		16-dot standard font: 50 chars. × 37 lines (2-byte) 12-dot standard font: 66 chars. × 50 lines (2-byte)		16-dot standard font: 40 chars. × 30 lines (2-byte) 12-dot standard font: 53 chars. × 40 lines (2-byte)			
Display colors	65,536 colors				256 colors		16 colors	
View angle*6	Right/left: 75°, Up: 50°, Down: 60°		GT1585V Right/left: 60°, Up: 40°, Down: 50° GT1585 Right/left: 65°, Up: 45°, Down: 55°		Right/left/up/down: 85°		Right/left/down: 85°	
Contrast adjustment	-							
Intensity	450 [cd/m ²]		GT1585V: 350 [cd/m ²] GT1585: 400 [cd/m ²]		400 [cd/m ²]		380 [cd/m ²]	
Intensity adjustment	8-step adjustment				4-step adjustment		8-step adjustment	
Life	Approx. 52,000 hours (operating ambient temperature: 25°C)		Approx. 50,000 hours (operating ambient temperature: 25°C)		Approx. 41,000 hours (operating ambient temperature: 25°C)			
Backlight	Cold-cathode fluorescent tube (replaceable), with backlight OFF detection function. Backlight off time and screen save time can be set.							
Life*2	Approx. 50,000 hours or more				Approx. 40,000 hours or more			
	(Time for display intensity reaches 50% at operating ambient temperature of 25°C)							
Type	Analog resistive type		Matrix resistive type					
No. of touch keys	-		1900 keys/screen (38 lines × 50 columns)			1200 keys/screen (30 lines × 40 columns)		
Key size	Min. 2 × 2 [dots] (per key)		Min. 16 × 16 [dots] (per key) (16 × 8 only on lowermost line)			Min. 16 × 16 [dots] (per key)		
No. of simultaneous touch points	Simultaneous touch prohibited*3 (1 point only)		Max. 2 points					
Life	1,000,000 times or more (operating force 0.98N or less)							
Detection distance	1 [m]		-					
Detection range	Right/left/up/down: 70°		-					
Detection delay time	0 to 4 [sec]		-					
Detection temperature	Temperature difference to be 4°C or more between human body and ambient air		-					
C drive	9MB built-in flash memory (for saving project data and OS)				5MB built-in flash memory (for saving project data and OS)		9MB built-in flash memory (for saving project data and OS)	5MB built-in flash memory (for saving project data and OS)
Life (No. of writings)	100,000 times							
Backed up data	GT15-BAT type lithium battery (optional)							
Life	Clock data and maintenance time notification data							
	Approx. 5 years (operating ambient temperature: 25°C)							
RS-232	RS-232, 1ch, Transmission speed: 115200/57600/38400/19200/9600/4800bps, Connector shape: D-sub 9-pin (male)							
Application:	Communication with connected devices, connection to personal computer (project data upload/download, OS installation, FA transparent function)							
USB	USB (full-speed 12Mbps), device 1ch, Connector shape: TYPE Mini-B							
Application:	Connection to personal computer (project data upload/download, OS installation, FA transparent function)							
CF card	Compact flash slot, 1ch, Connector shape: TYPE I, Application: Data transfer, data storage, GOT startup							
Optional function board	1ch for optional function board installation							
Extension unit	2ch for communication unit/optional unit installation							
Buzzer output	Single tone (tone length adjustable)							
Protective construction	JEM1030 Front: IP67*5 In panel: IP2X							
External dimensions (without USB port cover)	397(W) × 296(H) × 61(D) [mm]		316(W) × 242(H) × 52(D) [mm]		303(W) × 214(H) × 49(D) [mm]		241(W) × 192(H) × 52(D) [mm]	
Panel cut dimensions	383.5(W) × 282.5(H) [mm]		302(W) × 228(H) [mm]		289(W) × 200(H) [mm]		227(W) × 176(H) [mm]	
Weight (excl. mounting brackets)	5.0 [kg]		2.8 [kg]		GT1575V: 2.3 [kg] GT1575: 2.4 [kg]	2.4 [kg]	2.3 [kg]	1.9 [kg]
Applicable software packages	Screen design software: GT Designer2 Version 2.90U or later Simulation software: GT Simulator2 Version 2.90U or later							

Power supply specifications

Item	Specification										
	GT1595-VTBA	GT1585V-STBA GT1585V-STBD	GT1575V-STBA GT1575V-STBD GT1575-VNBA GT1565-VTBA GT1562-VNBA	GT1595-VTBD	GT1585V-STBD GT1585V-STBD	GT1575V-STBD GT1575-VTBD GT1572-VNBD GT1565-VTBD GT1562-VNBD	GT1555-VTBD	GT1555-VTBD	GT1555-VTBD	GT1550-VTBD	GT1550-VTBD
Input power supply voltage	100 to 240VAC (+10%, -15%)					24VDC (+25%, -20%)					
Input frequency	50/60Hz ±5%										
Input maximum apparent power	110VA (at max. load)										
Power consumption	56W or less	41W or less	39W or less	57W or less (2380mA/24VDC)	43W or less (1790mA/24VDC)	41W or less (1710mA/24VDC)	19W or less (790mA/24VDC)	18W or less (750mA/24VDC)	17W or less (710mA/24VDC)	15W or less (620mA/24VDC)	
With backlight off	30W or less	28W or less	28W or less	32W or less (1330mA/24VDC)	30W or less (1250mA/24VDC)	30W or less (1250mA/24VDC)	14W or less (580mA/24VDC)	13W or less (540mA/24VDC)	13W or less (540mA/24VDC)	13W or less (540mA/24VDC)	
Inrush current	50A or less (4ms, at max. load)	45A or less (4ms, at max. load)	40A or less (4ms, at max. load)	100A or less (4ms, at max. load)	115A or less (1ms, at max. load)	115A or less (1ms, at max. load)	67A or less (1ms, at max. load)	67A or less (1ms, at max. load)	60A or less (1ms, at max. load)	60A or less (1ms, at max. load)	
Permissible instantaneous failure time	Within 20ms (100VAC or more)					Within 10ms					
Noise resistance	Noise voltage 1500Vp-p, noise width 1μs by noise simulator with noise frequency 25 to 60Hz					Noise voltage 500Vp-p, noise width 1μs by noise simulator with noise frequency 25 to 60Hz					
Withstand voltage	1500VAC for 1 minute between power supply terminal and ground					500VDC for 1 minute between power supply terminal and ground					
Insulation resistance	10MΩ or higher with an insulation resistance tester (500VDC between power supply terminal and ground)										
Applicable wire size	0.75 to 2 [mm ²]										
Clamp terminal	Clamp terminals for M3 screw RAV1.25-3, V2-S3.3, V2-N3A, FV2-N3A										
Tightening torque (terminal block's terminal screws)	0.5 to 0.8 [N·m]										

Performance specifications

Item	Specification			
	GT1555-VTBD	GT1555-VTBD	GT1555-VTBD	GT1550-VTBD
Type	TFT color LCD (high-brightness, wide viewing angle)		STN color LCD	STN monochrome (black/white) LCD
Screen size	5.7"			
Resolution	VGA: 640 × 480 [dots]		QVGA: 320 × 240 [dots]	
Display size	115(W) × 86(H) [mm]			
No. of displayed characters	16-dot standard font: 40 chars. × 30 lines (2-byte) 12-dot standard font: 53 chars. × 40 lines (2-byte)		16-dot standard font: 20 chars. × 15 lines (2-byte) 12-dot standard font: 26 chars. × 20 lines (2-byte)	
Display colors	65,536 colors		4,096 colors	Monochrome 16 gray scale
View angle*6	Right/left: 80°, Up: 80°, Down: 70°		Right/left: 70°, Up: 70°, Down: 50°	Right/left: 55°, Up: 65°, Down: 70°
Contrast adjustment	16-step adjustment			
Intensity	350 [cd/m ²]		400 [cd/m ²]	220 [cd/m ²]
Intensity adjustment	8-step adjustment			
Life	Approx. 50,000 hours (operating ambient temperature: 25°C)			
Backlight	Cold-cathode fluorescent tube (not replaceable), with backlight OFF detection function. Backlight off time and screen save time can be set.			
Life*2	Approx. 75,000 hours or more (Time for display intensity reaches 50% at operating ambient temperature of 25°C)			
Type	Matrix resistive type			
No. of touch keys	1200 keys/screen (30 lines × 40 columns)		300 keys/screen (15 lines × 20 columns)	
Key size	Min. 16 × 16 [dots] (per key)			
No. of simultaneous touch points	Max. 2 points			
Life	1,000,000 times or more (operating force 0.98N or less)			
Detection distance	-			
Detection range	-			
Detection delay time	-			
Detection temperature	-			
C drive	9MB built-in flash memory (for saving project data and OS)			
Life (No. of writings)	100,000 times			
Backed up data	GT15-BAT type lithium battery (optional)			
Life	Clock data and maintenance time notification data			
	Approx. 5 years (operating ambient temperature: 25°C)			
RS-232	RS-232, 1ch, Transmission speed: 115200/57600/38400/19200/9600/4800bps, Connector shape: D-sub 9-pin (male)			
Application:	Communication with connected devices, connection to personal computer (project data upload/download, OS installation, FA transparent function)			
USB	USB (full-speed 12Mbps), device 1ch, Connector shape: TYPE Mini-B			
Application:	Connection to personal computer (project data upload/download, OS installation, FA transparent function)			
CF card	Compact flash slot, 1ch, Connector shape: TYPE I, Application: Data transfer, data storage, GOT startup			
Optional function board	1ch for optional function board installation			
Extension unit	1ch for communication unit/optional unit installation			
Buzzer output	Single tone (tone length adjustable)			
Protective construction	JEM1030 Front: IP67*5 In panel: IP2X			
External dimensions (without USB port cover)	167(W) × 135(H) × 60(D) [mm]			
Panel cut dimensions	153(W) × 121(H) [mm]			
Weight (excl. mounting brackets)	1.1 [kg]			
Applicable software packages	Screen design software: GT Designer2 Version 2.90U or later Simulation software: GT Simulator2 Version 2.90U or later			

Component names

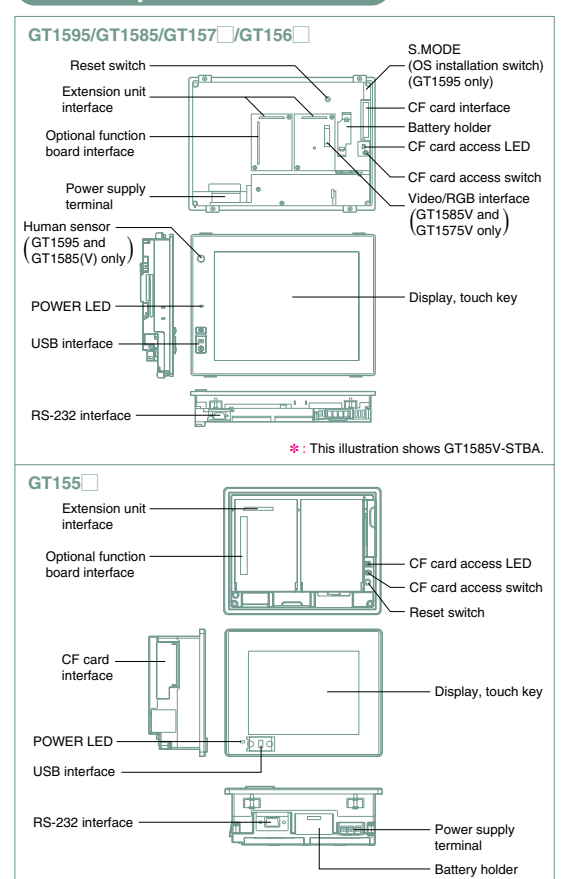

- *1: On LCD screens, bright dots (permanently lit) and black dots (not to be lit) generally appear. Because the large number of display elements exist on an LCD screen, it is not possible to reduce appearance of the bright and black dots to zero. Flickering may occur depending on the display colors. Note that the existence of bright and black dots is a standard characteristic of LCD screens, and it does not mean that the products are defective or damaged.
- *2: Using the GOT screen save/backlight OFF functions prevents screen burn-in and extends the backlight life.
- *3: An analog resistive touch display is used. When 2 points on the screen are touched simultaneously, if a switch is located the middle of the 2 points then the switch will be activated. Therefore, avoid touching 2 points on the screen simultaneously.
- *4: The memory is a ROM that permits overwriting of new data without having to delete the existing data.
- *5: With the USB environmentally protective cover is on, the main unit conforms to IP67 (JEM1030). (The USB interface conforms to IP2X (JEM1030) when a USB cable is connected.) However, this does not guarantee protection in all users' environments. The unit may not be used in an environment where it is exposed to splashing oil or chemicals for a long time or it is soaked with oil mist.
- *6: LC panels have characteristics of tone reversal. Note that even within the indicated view angles, the screen display may not be clear enough depending on the display color.
- *7: The GT1555-VTBD can be operated with a stylus pen. Using a stylus pen enables touching small switches without fault. Use a stylus pen within the following specifications.
 - Material: Polyacetal resin
 - Point tip radius: 0.8mm or more

For Designers

For Operators

For Initial Startup & Adjustment Operators

For Maintenance Personnel

GT10

Handy GOT

GT-SoftGOT1000

IQ Platform

MELSEC Process Control + GOT1000

List of Compatible Models, etc.

Specifications

GT11 GT10

General specifications

Item	Specification	
Operating ambient temperature	0°C to 50°C*5	
Other than display	0°C to 55°C (horizontal installation), 0°C to 50°C (vertical installation)*5	
Storage ambient temperature	-20°C to 60°C	
Operating ambient humidity*1	10 to 90%RH, no condensation	
Storage ambient humidity*1	10 to 90%RH, no condensation	
Vibration resistance	Conforming to JIS B 3502 and IEC 61131-2	
	Under intermittent vibration	Frequency: 5 to 9Hz, Acceleration: 9.8m/s ² , Half amplitude: 3.5mm, Sweep count: 10 times in each of X, Y and Z directions
	Under continuous vibration	Frequency: 5 to 9Hz, Acceleration: 9.8m/s ² , Half amplitude: 1.75mm, Sweep count: 10 times in each of X, Y and Z directions
	Under continuous vibration	Frequency: 9 to 150Hz, Acceleration: 4.9m/s ² , Half amplitude: 1.75mm, Sweep count: 10 times in each of X, Y and Z directions
Impact resistance	Conforming to JIS B 3502 and IEC 61131-2 (147m/s ² , 3 times in each of X, Y and Z directions)	
Operating atmosphere	Free from oil mist, corrosive gases, flammable gases and excessive conductive dusts or direct sun beams (The same applies to unit storage.)	
Operating altitude*2	2000m or less	
Installation location	In control panel*6	
Overvoltage category*3	II or lower	
Contamination level*4	2 or less	
Cooling method	Self-cooling	
Grounding	Type D grounding (100Ω or less). Connect to panel if unable to ground.*7	

- *1: Water bulb temperature for STN display type must be 39°C or lower.
- *2: Do not operate or store the GOT unit in pressurized environments where the pressure exceeds the 0m elevation atmospheric pressure, as this could result in abnormal operation.
- *3: Assuming that the device is connected at some point between a public power distribution network and local system equipment. Category II applies to devices that are supplied with power from fixed equipment. The surge withstand voltage is 2500V for devices with ratings up to 300V.
- *4: Index that indicates the level of foreign conductive matter in the operating environment of device. Contamination level 2 denotes contamination by non-conductive matter only, though momentary conductivity may occur due to occasional condensation.
- *5: 0 to 40°C for GT115□_HS
- *6: Excluding GT115□_HS
- *7: The 5VDC type requires no grounding.

Performance specifications

Item	Specification										
	GT1155-QTBD	GT1155-QSBD	GT1150-QLBD	GT1155HS-QSBD	GT1150HS-QLBD	GT1155-QTBDQ GT1155-QTBDA	GT1155-QSBDQ GT1155-QSBDA	GT1150-QLBDQ GT1150-QLBDA	GT1155-QTBDQ GT1155-QTBDA	GT1155-QSBDQ GT1155-QSBDA	
Display*1	Type	TFT color LCD	STN color LCD	STN monochrome (black/white) LCD	STN color LCD	STN monochrome (black/white) LCD	TFT color LCD	STN color LCD	STN monochrome (black/white) LCD	STN monochrome (black/white) LCD	
	Screen size	5.7"									
	Resolution	QVGA: 320 × 240 [dots]									
	Display size	115(W) × 86(H) [mm] (in horizontal display mode)			115(W) × 86(H) [mm]			115(W) × 86(H) [mm] (in horizontal display mode)			
	No. of displayed characters	16-dot standard font: 20 chars. × 15 lines (2-byte)			12-dot standard font: 26 chars. × 20 lines (2-byte) (in horizontal display mode)			16-dot standard font: 20 chars. × 15 lines (2-byte)			
	Display colors	256 colors		Monochrome (black/white) 16 gray scale	256 colors		Monochrome (black/white) 16 gray scale	256 colors		Monochrome (black/white) 16 gray scale	
	View angle	Right/left: 70°, Up: 70°, Down: 50° (in horizontal display mode)	Right/left: 50°, Up: 50°, Down: 60° (Hardware versions A and B) (in horizontal display mode)	Right/left: 45°, Up: 20°, Down: 40° (in horizontal display mode)	Right/left: 50°, Up: 50°, Down: 60° (Hardware versions A and B)	Right/left: 55°, Up: 65°, Down: 70° (Hardware version C or later)	Right/left: 45°, Up: 20°, Down: 40°	Right/left: 45°, Up: 20°, Down: 40°	Right/left: 70°, Up: 70°, Down: 50° (in horizontal display mode)	Right/left: 55°, Up: 65°, Down: 70° (in horizontal display mode)	Right/left: 45°, Up: 20°, Down: 40° (in horizontal display mode)
	Contrast adjustment	16-step adjustment									
	Intensity	400 [cd/m ²]	350 [cd/m ²] (Hardware versions A and B)	220 [cd/m ²]	350 [cd/m ²] (Hardware versions A and B)	380 [cd/m ²] (Hardware version C or later)	220 [cd/m ²]	400 [cd/m ²]	380 [cd/m ²]	220 [cd/m ²]	
	Intensity adjustment	8-step adjustment									
Backlight	Approx. 50,000 hours (operating ambient temperature: 25°C)										
	Life*2	Cold-cathode fluorescent tube (not replaceable), with backlight OFF detection function. Backlight off time and screen save time can be set. Approx. 75,000 hours or more (Time for display intensity reaches 50% at operating ambient temperature of 25°C)									
Touch panel	Type	Matrix resistive type									
	No. of touch keys	300 keys/screen (matrix consisting of 15 lines × 20 columns)									
	Key size	Min. 16 × 16 [dots] (per key)									
Memory	No. of simultaneous touch points	Max. 2 points									
	Life	1,000,000 times or more (operating force 0.98N or less)									
C drive*3	Life (No. of writings)	3MB built-in flash memory (for saving project data and OS)									
	D drive	100,000 times									
Battery	Backed up data	512KB built-in SRAM (battery backup)									
	Life	GT11-50BAT type lithium battery									
Built-in interface	Bus	-			1ch for QCPU (Q mode)/motion controller CPU (Q series) or 1ch for QnA/ACPU/motion controller CPU (A series) Application: For bus connection of PLC						
	RS-422	RS-422, 1ch, Transmission speed: 115200/57600/38400/19200/9600/4800bps Connector shape: D-sub 9-pin (female) Application: Communication with connected devices			-						
	RS-422/232	-			RS-422/232, 1ch (Select one when using.) Transmission speed: 115200/57600/38400/19200/9600/4800bps, Connector shape: Round type, 32-pin (male) Application: Communication with connected devices						
	RS-232	RS-232, 1ch, Transmission speed: 115200/57600/38400/19200/9600/4800bps, Connector shape: D-sub 9-pin (male) Application: Communication with connected devices, connection to personal computer (project data upload/download, OS installation, FA transparent function, etc.)			RS-232, 1ch, Transmission speed: 115200/57600/38400/19200/9600/4800bps, Connector shape: Mini-DIN 9-pin (female) Application: Connection to personal computer (project data upload/download, OS installation, FA transparent function, etc.)			RS-232, 1ch, Transmission speed: 115200/57600/38400/19200/9600/4800bps, Connector shape: D-sub 9-pin (male) Application: Connection to barcode reader/personal computer (project data upload/download, OS installation, FA transparent function, etc.)			
	USB	USB (full-speed 12Mbps), device 1ch Application: Connection to personal computer (project data upload/download, OS installation, FA transparent function)									
	CF card	Compact flash slot, 1ch, Connector shape: TYPE I Application: Data transfer and data storage									
	Optional function board	1ch for optional function board installation (Embedded in main unit)									
	Buzzer output	Single tone (tone length adjustable)									
	Protective construction*4	JEM1030 Front: IP67 In panel: IP2X									
	External dimensions (without USB port cover)	164(W) × 135(H) × 56(D) [mm]			176(W) × 220(H) × 93(D) [mm]			167(W) × 135(H) × 65(D) [mm]			
Panel cut dimensions	153(W) × 121(H) [mm]										
Weight	0.7 [kg] (excl. mounting brackets)			1.0 [kg] (main unit only)			0.9 [kg] (excl. mounting brackets)				
Applicable software packages	Screen design software			GT Designer2 Version 2.90U or later							
	Simulation software			GT Simulator2 Version 2.90U or later							

Power supply specifications

Item	Specification							
	GT1155-QTBD GT1155-QSBD GT1155HS-QSBD	GT1150-QLBD GT1150HS-QLBD	GT1155-QTBDO GT1155-QTBDA	GT1155-QSBDO GT1155-QSBDA	GT1150-QLBDO GT1150-QLBDA	GT1055-QSBD	GT1050-QBBD	
Input power supply voltage	24VDC (+10%, -15%), ripple voltage of 200mV or less							
Input frequency	-							
Input maximum apparent power	-							
Power consumption	9.84W or less (410mA/24VDC)	9.36W or less (390mA/24VDC)	11.16W or less (465mA/24VDC)	9.72W or less (405mA/24VDC)	7.92W or less (330mA/24VDC)	9.84W or less (410mA/24VDC)	9.36W or less (390mA/24VDC)	
With backlight off	4.32W or less (180mA/24VDC)		5.04W or less (210mA/24VDC)		4.32W or less (180mA/24VDC)		4.32W or less (180mA/24VDC)	
Inrush current	15A or less (2ms, at max. load)		26A or less (4ms, at max. load)		15A or less (26.4V) 2ms		15A or less (26.4V) 2ms	
Permissible instantaneous failure time	Within 5ms		Within 10ms		Within 5ms		Within 5ms	
Noise resistance	Noise voltage 1000Vp-p, noise width 1μs by noise simulator with noise frequency 25 to 60Hz		Noise voltage 500Vp-p, noise width 1μs by noise simulator with noise frequency 25 to 60Hz		Noise voltage 1000Vp-p, noise width 1μs by noise simulator with noise frequency 30 to 100Hz		Noise voltage 1000Vp-p, noise width 1μs by noise simulator with noise frequency 30 to 100Hz	
Withstand voltage	500VAC for 1 minute between power supply terminal and ground							
Insulation resistance	10MΩ or higher with an insulation resistance tester (500VDC between power supply terminal and ground)							
Applicable wire size	0.75 to 2 [mm ²]*1							
Clamp terminal	Clamp terminals for M3 screw RAV1.25-3, V2-N3A, FV2-N3A*1							
Tightening torque (terminal block's terminal screws)	0.5 to 0.8 [N·m]*1							

*1: Excluding GT115□_HS

Performance specifications

Item	Specification	
	GT1055-QSBD	GT1050-QBBD
Display*1	Type	STN color LCD
	Screen size	5.7"
	Resolution	QVGA: 320 × 240 [dots]
	Display size	115(W) × 86(H) [mm] (in horizontal display mode)
	No. of displayed characters	16-dot standard font: 20 chars. × 15 lines (2-byte), 12-dot standard font: 26 chars. × 20 lines (2-byte) (in horizontal display mode)
	Display colors	256 colors
	View angle	Right/left: 55°, Up: 65°, Down: 70° (in horizontal display mode)
	Contrast adjustment	16-step adjustment
	Intensity	380 [cd/m ²]
	Life*2	Approx. 50,000 hours (Time for display contrast reaches 20% at operating ambient temperature of 25°C) Guarantee one year
Backlight	Cold-cathode fluorescent tube (not replaceable) with backlight OFF detection function. Backlight off time and screen save time can be set.	
	Life	Approx. 75,000 hours or more (Time for display intensity reaches 50% at operating ambient temperature of 25°C) Guarantee one year
Touch panel	Type	Matrix resistive type
	No. of touch keys	Max. 50 keys/screen
	Key size	Min. 16 × 16 [dots] (per key)
Memory	No. of simultaneous touch points	Max. 2 points
	Life	1,000,000 times or more (operating force 0.98N or less)
Battery	User memory*3	Built-in flash ROM for saving project data (3 MB or less) and OS
	Life (No. of writings)	100,000 times
Built-in interface	RS-422	RS-422, 1ch, Transmission speed: 115200/57600/38400/19200/9600/4800bps Connector shape: D-sub 9-pin (female) Application: Communication with PLCs
	USB	USB (full-speed 12Mbps), device 1ch Connector shape: TYPE Mini-B (receptacle) Application: Communication with personal computer (project data upload/download, OS installation, transparent function)
Buzzer output	Single tone (tone length adjustable/none)	
Protective construction*4	Conforming to IP67f (JEM1030) (front panel)	
External dimensions	164(W) × 135(H) × 56(D) [mm]	
Panel cut dimensions	153(W) × 121(H) [mm]	
Weight	0.7kg (excl. mounting brackets)	
Applicable software package	GT Designer2 Version 2.90U or later	

- *1: On LCD screens, bright dots (permanently lit) and black dots (not to be lit) generally appear. Because the large number of display elements exist on an LCD screen, it is not possible to reduce appearance of the bright and black dots to zero. Flickering may occur depending on the display colors. Note that the existence of bright and black dots is a standard characteristic of LCD screens, and it does not mean that the products are defective or damaged.
- *2: Using the GOT screen save/backlight OFF functions prevents screen burn-in and extends the backlight life.
- *3: The memory is a ROM that permits overwriting of new data without having to delete the existing data.
- *4: This does not guarantee protection in all users' environments. The specification is not applied when the interface protective cover and rear face protective cover are removed.

Component names

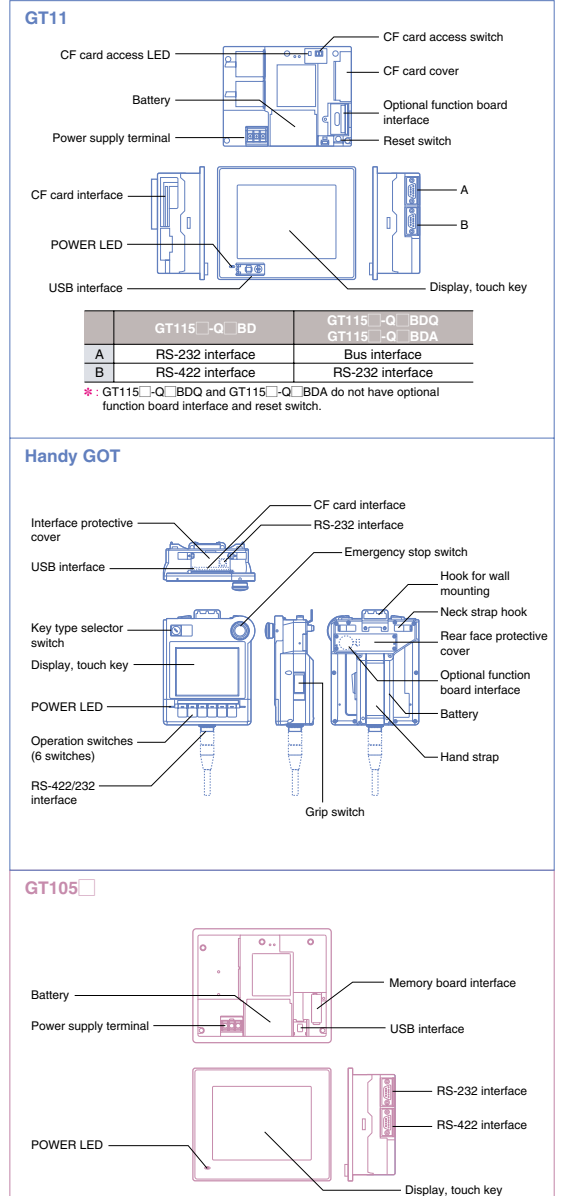

For Designers

For Operators

For Initial Startup & Adjustment Operators

For Maintenance Personnel

GT10

Handy GOT

GT-SoftGOT1000 Version2

IQ Platform

ME/SECC Process Control + GOT1000

List of Connectable Models, etc.

Specifications

GT10

Power supply specifications

Item	Specification			
	GT1030-LBD GT1030-LWD GT1030-LBD2 GT1030-LWD2	GT1030-LBDW GT1030-LWDW GT1030-LBDW2 GT1030-LWDW2	GT1020-LBD GT1020-LWD GT1020-LBD2 GT1020-LWD2	GT1020-LBDW GT1020-LWDW GT1020-LBDW2 GT1020-LWDW2
Input power supply voltage	24VDC (+10%, -15%), ripple voltage of 200mV or less			5VDC (±5%), supplied from PLC communication cable
Input frequency	-			
Input maximum apparent power	-			
Power consumption	2.2W or less (90mA/24VDC)	1.9W or less (80mA/24VDC)	1.1W or less (220mA/5VDC)	
With backlight off	1.7W or less (70mA/24VDC)	1.2W or less (50mA/24VDC)	0.6W or less (120mA/5VDC)	
Inrush current	18A or less (26.4DCV) 1ms	13A or less (26.4DCV) 1ms	-	
Permissible instantaneous failure time	Within 5ms			
Noise resistance	Noise voltage 1000Vp-p, noise width 1μs by noise simulator with noise frequency 30 to 100Hz			
Withstand voltage	500VAC for 1 minute between power supply terminal and ground			
Insulation resistance	10MΩ or higher with an insulation resistance tester (500VDC between power supply terminal and ground)			
Applicable wire size	Single-wire installation: 0.14 to 1.5mm ² , AWG26 to AWG16 (single wire), 0.14 to 1.0mm ² , AWG26 to AWG16 (stranded wire) Two-wire installation: 0.25 to 0.5mm ² , AWG24 to AWG20 (bar terminal with insulation sleeve)			
Clamp terminal	AI2.5-6BU, AI0.34-6TQ, AI0.5-6WH (made by Phoenix Contact)			
Tightening torque (terminal block's terminal screws)	0.22 to 0.25 [N·m]			

Performance specifications

Item	Specification								
	GT1030-LBD GT1030-LWD	GT1030-LBDW GT1030-LWDW	GT1030-LBD2 GT1030-LWD2	GT1030-LBDW2 GT1030-LWDW2	GT1020-LBD GT1020-LWD GT1020-LBD2 GT1020-LWD2	GT1020-LBDW GT1020-LWDW GT1020-LBDW2 GT1020-LWDW2	GT1020-LBL GT1020-LWL	GT1020-LBD2 GT1020-LWD2	GT1020-LBDW2 GT1020-LWDW2
Display*	Type	STN monochrome (black/white) LCD							
	Screen size	4.5"				3.7"			
	Resolution	288 × 96 [dots] (in horizontal mode)				160 × 64 [dots] (in horizontal mode)			
	Display size	109.42(W) × 35.98(H)[mm](in horizontal mode)				86.4(W) × 34.5(H)[mm](in horizontal mode)			
	No. of displayed characters	16-dot standard font: 36 chars. × 6 lines (1-byte) or 18 chars. × 6 lines (2-byte) (in horizontal mode) 12-dot standard font: 48 chars. × 8 lines (1-byte) or 24 chars. × 8 lines (2-byte) (in horizontal mode)				16-dot standard font: 20 chars. × 4 lines (1-byte) or 10 chars. × 4 lines (2-byte) (in horizontal mode)			
	Display colors	Monochrome (black/white)							
	View angle	Right/left: 30°, Up: 20°, Down: 30°(in horizontal display mode)							
	Contrast adjustment	16-step adjustment							
	Intensity	200 [cd/m ²] (in green)	300 [cd/m ²] (in white)	200 [cd/m ²] (in green)	300 [cd/m ²] (in white)	200 [cd/m ²] (in green)	300 [cd/m ²] (in white)	200 [cd/m ²] (in green)	300 [cd/m ²] (in white)
	Intensity adjustment	8-step adjustment							
Life**	Approx. 50,000 hours (Time for display contrast reaches 20% at operating ambient temperature of 25°C)								
Backlight	Color	3-color LED (green, orange and red) (replacement not needed)	3-color LED (white, pink and red) (replacement not needed)	3-color LED (green, orange and red) (replacement not needed)	3-color LED (white, pink and red) (replacement not needed)	3-color LED (green, orange and red) (replacement not needed)	3-color LED (white, pink and red) (replacement not needed)	3-color LED (green, orange and red) (replacement not needed)	3-color LED (white, pink and red) (replacement not needed)
	Function	Status control (color, on/flashing/off) is available and screen save time setting can be set. PLC can control color and status of backlight based on system information.							
Touch panel	Type	Matrix resistive type				Analog resistive type			
	No. of touch keys	Max. 50 keys/screen							
	Key size	Min. 16 × 16 [dots] (per key)				Min. 2 × 2 [dots] (per key)			
	No. of simultaneous touch points	Max. 2 points				Impossible (If there is a switch near the center of the pressed keys, the switch may function.)			
Memory	User memory**3	Built-in flash ROM for saving project data (1.5MB or less) and OS				Built-in flash ROM for saving project data (512KB or less), OS, alarm history and recipe data			
	Life (No. of writings)	100,000 times							
Battery	Backed up data	GT11-50BAT type lithium battery							
	Life	Clock data, alarm history and recipe data							
Built-in interface	For communication with PLC	RS-422, 1ch, Transmission speed: 115200/57600/38400/19200/9600/4800bps, Connector shape: Connector terminal block, 9-pin Application: Communication with PLC		RS-232, 1ch, Transmission speed: 115200/57600/38400/19200/9600/4800bps, Connector shape: Connector terminal block, 9-pin Application: Communication with PLC		RS-422, 1ch, Transmission speed: 115200/57600/38400/19200/9600/4800bps, Connector shape: Connector terminal block, 9-pin Application: Communication with PLC		RS-232, 1ch, Transmission speed: 115200/57600/38400/19200/9600/4800bps, Connector shape: Connector terminal block, 9-pin Application: Communication with PLC	
	For communication with personal computer	RS-232, 1ch, Transmission speed: 115200/57600/38400/19200/9600/4800bps Connector shape: Mini DIN 6-pin (female) Application: Communication with personal computer (project data upload/download, OS installation, transparent function)							
	Buzzer output	Single tone (tone length adjustable/none)							
	Protective construction**4	Conforming to IP67 (JEM1030) (front panel)							
External dimensions	145(W) × 76(H) × 29.5(D)[mm]				113(W) × 74(H) × 27(D)[mm]				
Panel cut dimensions	137(W) × 66(H)[mm]				105(W) × 66(H)[mm]				
Weight	0.3kg (excl. mounting brackets)				GT1020-L _D (W): 0.2kg (excl. mounting brackets) GT1020-L _L (W): 0.18kg (excl. mounting brackets)		0.2kg (excl. mounting brackets)		
Applicable software package	GT Designer2 Version 2.90U or later								

*1: On LCD screens, bright dots (permanently lit) and black dots (not to be lit) generally appear. Because the large number of display elements exist on an LCD screen, it is not possible to reduce appearance of the bright and black dots to zero.
Flickering may occur depending on the display colors.

Note that the existence of bright and black dots is a standard characteristic of LCD screens, and it does not mean that the products are defective or damaged.

*2: Using the GOT screen save/backlight OFF functions prevents screen burn-in and extends the backlight life.

*3: The memory is a ROM that permits overwriting of new data without having to delete the existing data.

*4: This does not guarantee protection in all users' environments.

Component names

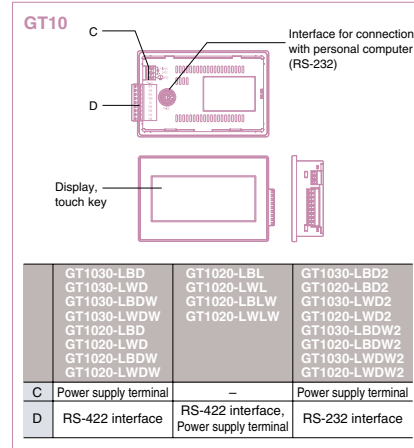

External dimensions

GOT main unit

External dimensions

(Unit: mm)

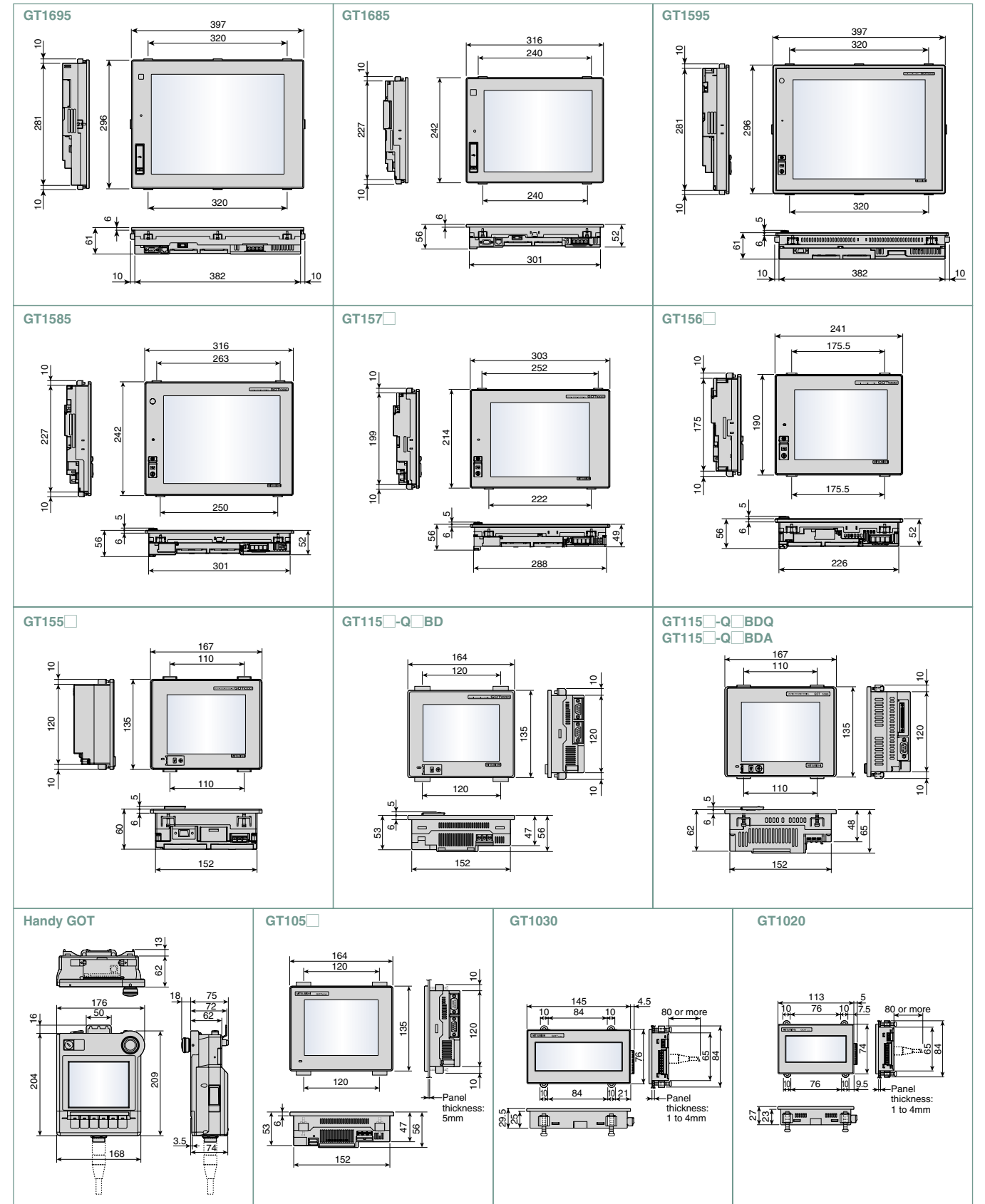

For Designers

For Operators

For Initial Startup & Adjustment Operators

For Maintenance Personnel

GT10

Handy GOT

GT-SoftGOT1000 Version2

IQ Platform

ME/SEC Process Control + GOT1000

List of Connectable Models, etc.

External dimensions

Panel cut dimensions

When GOT is installed

Screen size	Type of GOT main unit	A	B
15"	GT1695	383.5	282.5
	GT1595		
12.1"	GT1685	302	228
	GT1585*1		
10.4"	GT157	289	200
	GT156		
8.4"	GT155*3	153	121
	GT115		
5.7"	GT1030	137	66
	GT1020		
4.5"	GT105	105	66

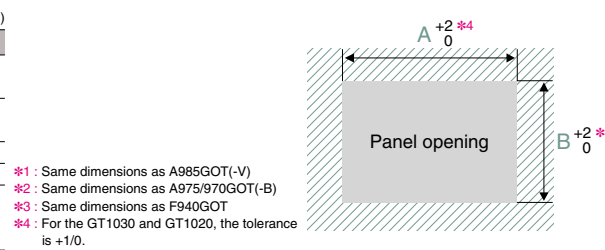

*1 : Same dimensions as A985GOT(-V)
 *2 : Same dimensions as A975/970GOT(-B)
 *3 : Same dimensions as F940GOT
 *4 : For the GT1030 and GT1020, the tolerance is +1/0.

For compatibility with GOT900 series, see "Backward compatibility" (page 77).

When CF card extension unit (mounting unit on control panel) is installed

Type	A	B
GT15-CFEX-C08SET	94.0	33.0

Cautions when installing and uninstalling

When installing the CF card extension unit on the control panel, make sure that the extension unit does not interfere with the extension unit cable or the CF card interface of the GOT. Place the CF card extension unit at a distance of 25mm or more from the GOT. For installation locations, see the GT15 User's Manual.

Product installation interval

The GOT must have the clearances from other devices as shown in [Fig. A]. The GOT may require more distance than the dimensions shown in the table depending on the types of connection cables. Consider the connector dimensions and radius of cable bending curvature when designing the installation.

GT16/GT15

Item	GT1695	GT1685	GT1595	GT1585	GT157	GT156	GT155
GOT only					50 or more (31 or more)	50 or more (36 or more)	65 or more
When bus connection unit is installed	50 or more (20 or more)						
When serial communication unit is installed	50 or more (20 or more)						
When RS-422 conversion unit is installed	50 or more	51 or more	50 or more	51 or more	68 or more	73 or more	-
When Ethernet communication unit is installed	50 or more (20 or more)						
When CC-Link communication unit (GT15-J61BT13) is installed	50 or more (20 or more)						
When CC-link IE controller network communication unit is installed	50 or more (20 or more)						
When MELSECNET/H communication unit (coaxial) is installed	50 or more (20 or more)	50 or more (24 or more)	50 or more (20 or more)	50 or more (24 or more)	50 or more (38 or more)	50 or more	72 or more
When MELSECNET/H communication unit (optical) is installed	50 or more (20 or more)*1						
When printer unit is installed	50 or more (20 or more)						
When multimedia unit is installed	50 or more (20 or more)						
When video input unit is installed	50 or more (20 or more)						
When RGB input unit is installed	50 or more (20 or more)*2						
When video/RGB input unit is installed	50 or more (20 or more)*3						
When RGB output unit is installed	50 or more (20 or more)*3						
When CF card unit is installed	50 or more (20 or more)						
When CF card extension unit is installed	50 or more (20 or more)						
When audio output unit is installed	50 or more (20 or more)						
When external input/output unit is installed	50 or more (20 or more)						
B	80 or more (20 or more)						
C (When CF card is not used)	50 or more (20 or more)						
D (When CF card is used)	50 or more (20 or more)						
E	100 or more						
	50 or more (20 or more)						
	100 or more (20 or more)						

*1 : The distance varies depending on the cable to be used. For details, consult the closest Mitsubishi Electric System & Service office.
 The values in the table are given for your reference.
 *2 : The distances required when the coaxial cable 3C-2V (JIS C 3501) is used.
 *3 : The distance varies depending on the cable to be used. When the bending radius of the cable is larger than the indicated value, keep a space appropriate to the bending radius.

GT11

GOT main unit	A, D	B	C		E
			When CF card is not used	When CF card is used	
GT1155	50 or more (20 or more)	80 or more*1	50 or more*2	100 or more	100 or more (20 or more)
GT1150	50 or more (20 or more)	80 or more*1	50 or more*2	100 or more	100 or more (20 or more)

*1 : 50 or more (20 or more) in the case of vertical installation
 *2 : 80 or more (20 or more) in the case of vertical installation

GT10

GOT main unit	A	B	C	D	E
GT105	50 or more (20 or more)	80 or more (20 or more)	50 or more (20 or more)	50 or more (20 or more)	100 or more (20 or more)*3
GT1030	50 or more (20 or more)*1	50 or more (20 or more)	50 or more (20 or more)	50 or more	80 or more (20 or more)*2
GT1020	50 or more (20 or more)*1	50 or more (20 or more)	50 or more (20 or more)	50 or more	80 or more (20 or more)*2

*1 : 50 or more when an RS-232/USB conversion adapter is used.
 *2 : 80 or more when a personal computer connection cable is used or when a personal computer RS-232 interface is used for connecting multiple GOTs.
 *3 : 50 or more when an RS-232 interface is used for using an RS-232/USB conversion adapter.
 *4 : 80 or more when using a USB cable or a memory board.

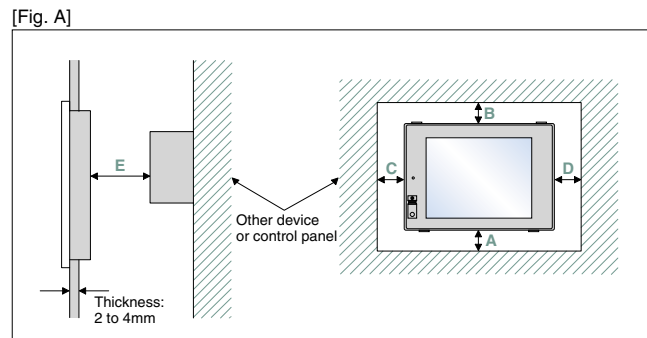

Bus connection cables

Cable model name	Cable length	External dimensions
GT15-QC-B	0.6, 1.2, 3, 5, 10m	Fig. 1
GT15-QC-BS	15, 20, 25, 30, 35m	Fig. 1
GT15-C-NB	1.2, 3, 5m	Fig. 2
GT15-AC-NB	0.6, 1.2, 3, 5m	Fig. 3
GT15-A370C-BS1	1.2, 2.5m	Fig. 4
GT15-A370C-B	1.2, 2.5m	Fig. 5
GT15-A1SC-B	0.7, 1.2, 3, 5m	Fig. 6
GT15-A1SC-NB	0.45, 0.7, 3, 5m	Fig. 7
GT15-C-EXSS-1*1	10.6, 20.6, 30.6m	Figs. 8 & 9
GT15-EXCNB	0.5m	Fig. 8
GT15-C-BS	0.7, 1.2, 3, 5, 10, 20, 30m	Fig. 9
GT15-J2C10B	1m	Fig. 10

*1 : GT15-C-EXSS-1 is a set consisting of GT15-EXCNB and GT15-C-BS. (See Fig. A.)

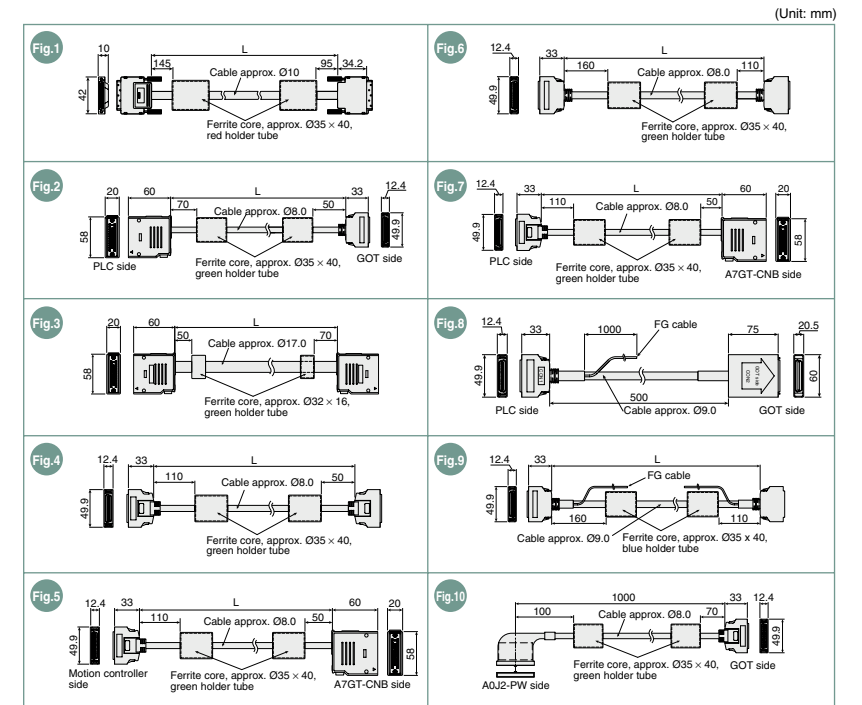
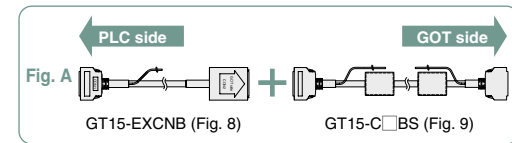

RS-422 cables

Cable model name	Cable length	External dimensions
GT16-C02R4-9S	0.2m	Fig. 11
GT01-C30R4-25P	3m	Fig. 12
GT01-C-R4-25P	10, 20, 30m	Fig. 13
GT01-C-R4-8P	1, 3, 10, 20, 30m	Fig. 14
GT10-C-R4-8P	1, 3, 10, 20, 30m	Fig. 15
GT10-C-R4-25P	3, 10, 20, 30m	Fig. 16
GT10-C10R4-8PL	1m	Fig. 17

RS-232 cables

Cable model name	Cable length	External dimensions
GT01-C30R2-6P	3m	Fig. 18
GT01-C30R2-9S	3m	Fig. 19
GT01-C30R2-25P	3m	Fig. 20
GT10-C30R2-6P	3m	Fig. 21

RS-485 terminal block conversion unit

Model name	Cable length	External dimensions
FA-LTBGTR4CBL	0.5, 1, 2m	Fig. 22

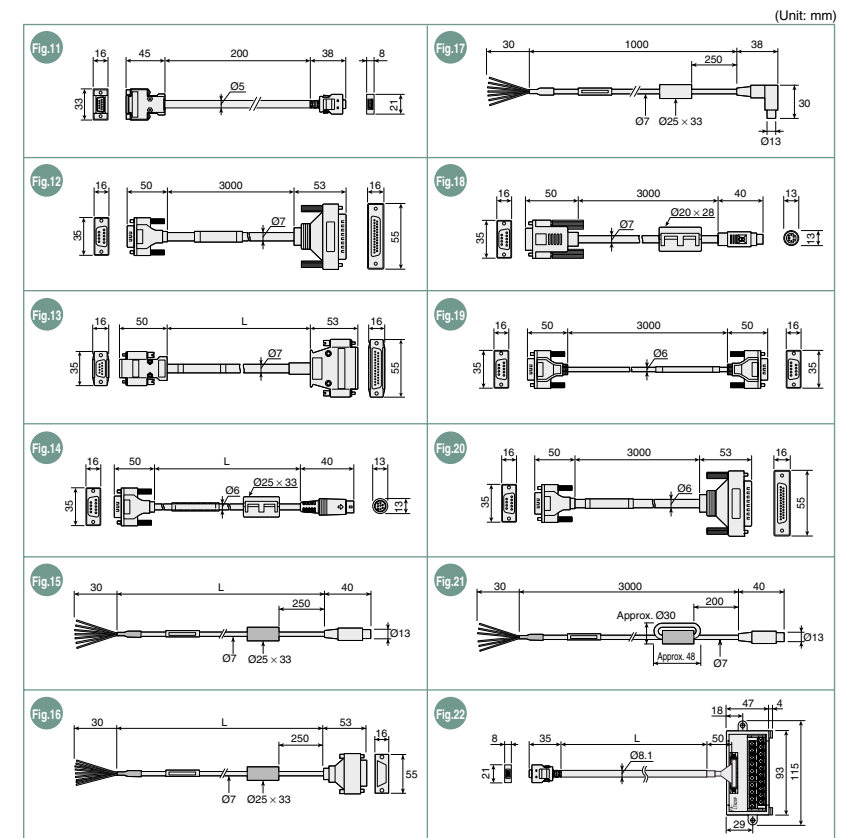

Dimensions shown in parentheses apply when there are no devices nearby (contactor, etc.) which produce radiated noise or heat. Even with these dimensions, however, the ambient temperature must never exceed 55°C.

Depending on the unit and cable being used, a cable length longer than dimension A (or dimension D for the GT10) in above [Fig. A] may be required.

For Designers

For Operators

For Initial Startup & Adjustment Operators

For Maintenance Personnel

GT10

Handy GOT

GT-SoftGOT1000 Version2

IQ Platform

MELSEC Process Control + GOT1000

List of Connectable Models, etc.

External dimensions

Communication units/optional units

Communication units/bus extension connector boxes

Product name	Model name	External dimensions
Bus connection unit	Standard model of bus connection unit for QCPU (Q mode)/motion controller CPU (Q Series)	1ch GT15-QBUS Fig. 1
		2ch GT15-QBUS2 Fig. 2
	Standard model of bus connection unit for QnA/ACPU/motion controller CPU (A Series)	1ch GT15-ABUS Fig. 1
		2ch GT15-ABUS2 Fig. 2
	Thin model of bus connection unit for QCPU (Q mode)/motion controller CPU (Q Series)	1ch GT15-75QBUSL Fig. 3
		2ch GT15-75QBUS2L Fig. 3
Serial communication unit	Thin model of bus connection unit for QnA/ACPU/motion controller CPU (A Series)	1ch GT15-75ABUSL Fig. 3
		2ch GT15-75ABUS2L Fig. 3
	RS-232 serial communication unit (D-sub 9-pin (male))	GT15-RS2-9P Fig. 4
	RS-422/485 serial communication unit (D-sub 9-pin (female))	GT15-RS4-9S Fig. 4
	RS-422/485 serial communication unit (terminal block)	GT15-RS4-TE Fig. 5
	RS-422 conversion unit	RS-232→RS-422 conversion unit (9-pin) GT15-RS2T4-9P Fig. 6
	RS-232→RS-422 conversion unit (25-pin) GT15-RS2T4-25P Fig. 6	
Bus extension connector box	A9GT-QCNB Fig. 7	
Bus connector conversion box	A7GT-CNB Fig. 8	
MELSECNET/H communication unit	Optical loop unit	GT15-J71LP23-25 Fig. 9
	Coaxial bus unit	GT15-J71BR13 Fig. 10
CC-Link IE controller network communication unit	GT15-J71GP23-SX Fig. 11	
CC-Link communication unit Intelligent device station unit	GT15-J61BT13 Fig. 12	
Ethernet communication unit	GT15-J71E71-100 Fig. 13	

Optional units

Product name	Model name	External dimensions
Printer unit	GT15-PRN Fig. 14	
Multimedia unit	GT16M-MMR Fig. 15	
Video input unit	GT16M-V4 Fig. 16	
	GT15V-75V4 Fig. 17	
RGB input unit	GT16M-R2 Fig. 16	
	GT15V-75R1 Fig. 17	
Video/RGB input unit	GT16M-V4R1 Fig. 16	
	GT15V-75V4R1 Fig. 17	
RGB output unit	GT16M-ROUT Fig. 18	
	GT15V-75ROUT Fig. 18	
CF card unit	GT15-CFCD Fig. 19	
CF card extension unit	GT15-CFEX-C08SET Fig. 20	
Audio output unit	GT15-SOUT Fig. 21	
External input/output unit	GT15-DIOR Fig. 22	
	GT15-DIO Fig. 22	
Handy GOT connector conversion box	GT11H-CNB-37S Fig. 23	

*1: The connector shape varies depending on the model.

*2: Dimensions A to D for each communication unit

Model name	A	B	C	D
GT15-QBUS	2.5	12	31.5	-
GT15-QBUS2	2.5	11	29	33.5
GT15-ABUS	4.5	15	29.5	-
GT15-ABUS2	4.5	11	31	31

*3: Dimension X when GOT is installed
1mm smaller when a CF card unit is mounted.

For GT16

Units other than CC-Link IE controller network communication unit and multimedia unit	1st	2nd	3rd
15"	19.5	41	62.5
12.1"	18	39.5	61.5

CC-Link IE controller network communication unit and multimedia unit	1st	2nd	3rd
15"	33.5	55	76.5
12.1"	32	53	75

For GT15

Units other than CC-Link IE controller network communication unit	1st	2nd	3rd
15", 10.4"	21	42.5	64.5
12.1"	18	39.5	61.5
8.4", 5.7"	23	44.5	66.5

CC-Link IE controller network communication unit	1st	2nd	3rd
15", 10.4"	34.5	56	78
12.1"	31.5	53	75
8.4", 5.7"	36.5	58	80

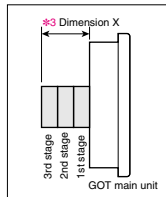

*4: Dimension A for each communication unit

Model name	A
GT15-75QBUSL	2.5
GT15-75QBUS2L	2.5
GT15-75ABUSL	4
GT15-75ABUS2L	4

*5: Dimension X when GOT is installed

For GT16

15"	6.5
12.1"	5

For GT15

15", 10.4"	8
12.1"	5
8.4", 5.7"	10

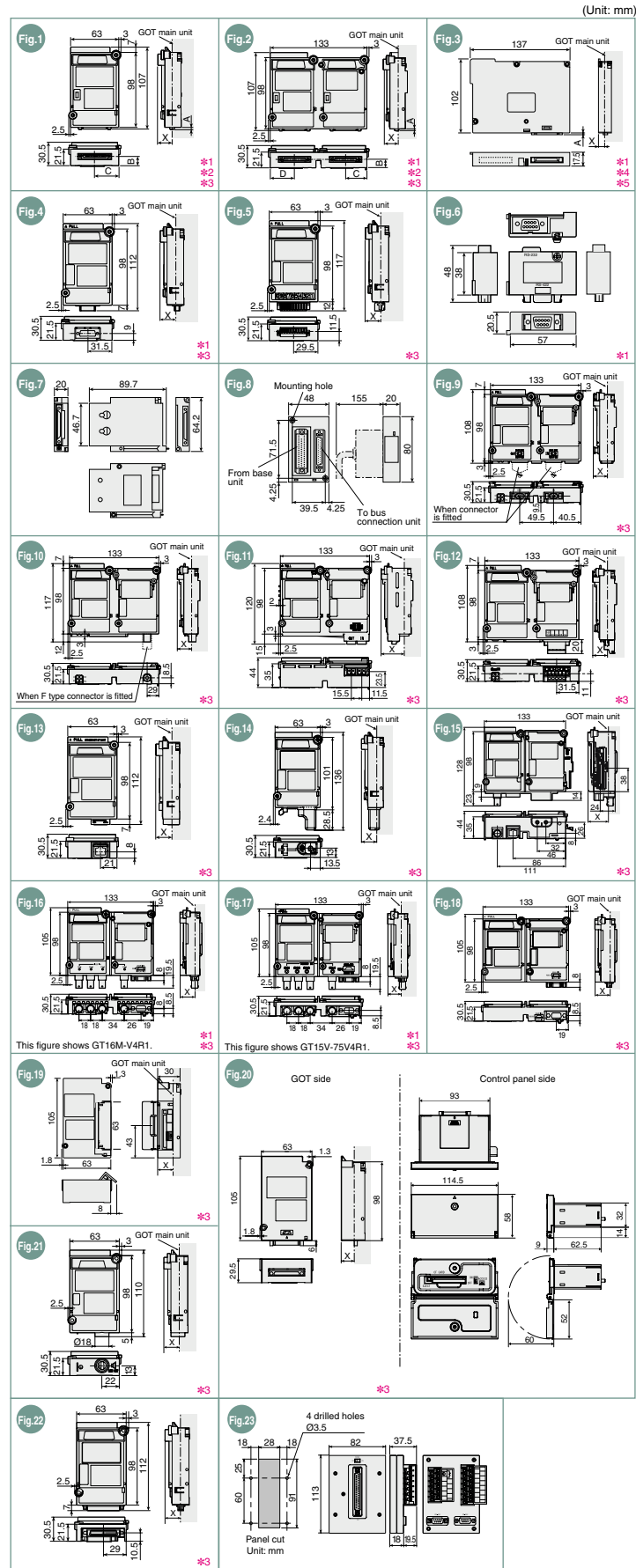

Notes for use

Backward compatibility

Project data

■ **GT Designer→GT Designer2 compatibility***
Project data created in GT Designer can be used in GT Designer2.

■ **GOT900 series→GOT1000 series compatibility***

● **Using data from the GOT-A900 series**

The GOT900 series project data can be used on the GOT1000 series.

● **Using data from the GOT-F900 series**

The GOT-F900 series project data can be used on the GOT1000 series.

For details, see "Project Data Conversion Summary (JY997D1761)."

*Some data and functions cannot be used on the GOT1000 series.

Cables

- For details on using the GOT900 series bus connection cables, RS-422 cables and RS-232 cables with the GOT1000 series, see Technical Bulletin No.GOT-A-0009.
- The bus connection cables, RS-422 cables and RS-232 cables for the GOT1000 series cannot be used for the GOT900 series.

Panel cut dimensions

■ **GOT900 series→GOT1000 series compatibility**

- The A985GOT(-V) and GT1585, A975/970GOT(-B) and GT157□, and F940GOT and GT155□/GT115□ have the same panel cut dimensions, respectively. Therefore, it is not necessary to change the mounting hole size.
- Although the A95□ differs in panel cut dimensions from the GT155□, GT115□-Q□BDQ and GT115□-Q□BDA, the former model can be replaced with any of the latter ones without changing the mounting hole size.

Selection of optional units and devices

Using the optional functions listed in the table below may require optional devices or units as shown. Note that the required optional units and devices may vary depending on the GOT main unit. The functions not listed in the table below may also require a CF card depending on the application. For details, see "Function list" (page 82) and "GT Designer2 Version2 Screen Design Manual." An optional function board or a CF card may be necessary depending on the function version and hardware version of the GOT main unit or available space of the user area. For details, see "CF card & optional function board selection <GT16/GT15/GT11>" (page 78).

Function	Required optional units and devices			
	GT16	GT15	GT11	GT10
Memory extension	CF card	Optional function board: GT15-QFNB□M or GT15-MESB48M CF card	None	None
Multi-channel function	Not necessary	Optional function board: GT15-QFNB□M or GT15-MESB48M	None	None
Multimedia function	Multimedia unit: GT16M-MMR CF card for multimedia	None	None	None
Video/RGB function	Video input	Video input unit: GT16M-V4 or, Video/RGB input unit: GT16M-V4R1	Video input unit: GT15V-75V4 or, Video/RGB input unit: GT15V-75V4R1	None
	RGB input	RGB input unit: GT16M-R2 or, Video/RGB input unit: GT16M-V4R1	RGB input unit: GT15V-75R1 or, Video/RGB input unit: GT15V-75V4R1	None
	RGB output	RGB output unit: GT16M-ROUT	RGB output unit: GT15V-ROUT	None
CF card unit/CF card extension unit	CF card unit: GT15-CFCD or, CF card extension unit: GT15-CFEX-C08SET	CF card unit: GT15-CFCD or, CF card extension unit: GT15-CFEX-C08SET	None	None
Sound output function	Sound output unit: GT15-SOUT	Sound output unit: GT15-SOUT	None	None
Remote personal computer operation function	RGB input unit: GT16M-R2 or, Video/RGB input unit: GT16M-V4R1	RGB input unit: GT15V-75R1 or, Video/RGB input unit: GT15V-75V4R1	None	None
External input/output function, operation panel function	External input/output unit: GT15-DIO or GT15-DIOR	External input/output unit: GT15-DIO or GT15-DIOR	None	None
Gateway function	Not necessary	Ethernet communication unit: GT15-J71E71-100	None	None
MES interface function	Optional function board: GT16-MESB	Ethernet communication unit: GT15-J71E71-100 Optional function board: GT15-MESB48M	None	None
Document display function	CF card	Optional function board: GT15-QFNB□M or GT15-MESB48M CF card	None	None
Operation log function	CF card	CF card	None	None
Backup/restoration function	USB memory or CF card	CF card	None	None
Maintenance time notification function	Not necessary (equipped with battery as standard feature)	Battery: GT15-BAT	None	None
CNC data input/output function	USB memory or CF card	CF card	None	None
Ladder monitor function (when using Q/QnA ladder monitor function)	Not necessary	Optional function board: GT15-QFNB□M or GT15-MESB48M	None	None
SFC monitor function	CF card	Optional function board: GT15-QFNB□M or GT15-MESB48M CF card	None	None
Report function	Printer unit: GT15-PRN	Printer unit: GT15-PRN	None	None
	CF card	CF card	None	None
Hard copy function	Saving files on CF card	CF card	None	None
	Printing by printer	Printer unit: GT15-PRN	Printer unit: GT15-PRN	None

For Designers

For Operators

For Initial Startup & Adjustment Operators

For Maintenance Personnel

GT10

Handy GOT

GT-SoftGOT1000 Version2

IQ Platform

MELSEC Process Control +GOT1000

List of Connectable Models, etc.

CF card & optional function board selection <GT16/GT15/GT11>

When using the GT16

When using optional functions & extended functions

When using the MES interface function, install the optional function board GT16-MESB. No optional boards are necessary when using other functions. Some functions, however, may require a CF card due to OS installation. See below for details.

Storage memory (ROM) and operation memory (RAM)

The GOT operates while decompressing the OS and project data, which is stored in the storage memory (ROM), on the operation memory (RAM). Since the GT16 compresses some data before storing it on the storage memory (ROM), the data size becomes larger when decompressed on the operation memory (RAM). The GT16 has a 15MB built-in flash memory for the storage memory (ROM) as a standard feature. The CF card expands the memory if the OS and project data exceeds 15MB. The GT16 has a 57MB operation memory (RAM) as a standard feature. The operation memory is not extendable. The built-in flash memory is for "drive C". The CF card is for "drive A (standard)" or "drive B (extension)."

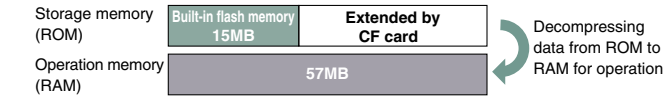

Types and capacities of data and CF card selection

The data types and capacities are as shown in the table below.

Data type	Data capacity
A Extended function OS and optional function OS stored in ROM	Capacity of "GT16(ROM)" in [Table A] on page 79
A Extended function OS and optional function OS decompressed on RAM	Capacity of "GT16(RAM)" in [Table A] on page 79
B Communication driver	Check with [Table B] on page 79.
C Special data	Check with a screen design software.
D Project data	Check with a screen design software.
E Buffering area	Check with a screen design software.

As for the extended function OS and optional function OS, when decompressing the compressed data **A** in the storage memory (ROM) on the operation memory (RAM), the data size becomes larger as shown in **A**. The buffering area **E** is an area for storing resource data such as logging and extension alarms. It uses the operation memory (RAM). The data size differs depending on the setting. When the screen design software designates file saving, the accumulated resource data is stored in the designated storage (drive A or B). (The storage memory (ROM) is not used.) If the size of data decompressed on the operation memory (RAM) exceeds 57MB, it is necessary to reduce, for instance, the project data size or delete unnecessary OS.

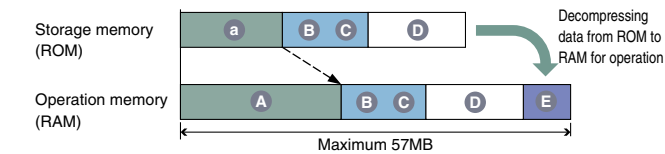

Necessity and capacity of the CF card depend on the data size. Determine the necessity and capacity of the CF card according to the following flow chart.

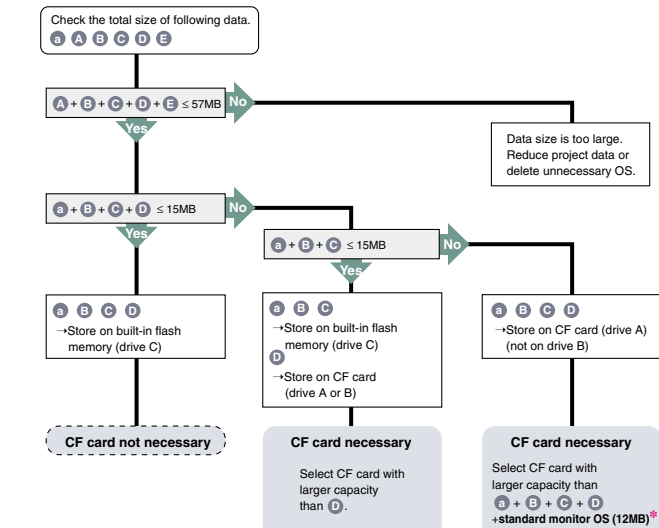

*: When storing the extended function OS and optional function OS in the CF card (drive A), the standard monitor OS (standard monitor OS, standard font, etc.) needs to be stored in the CF card (drive A).

When using the GT15

When using optional functions & extended functions

When using the following function, install the optional function board GT15-MESB48M. • MES interface function When using the following function, install the optional function board GT15-QFNB or GT15-MESB48M. • SFC monitor function

When using the following function, install the optional function board GT15-QFNB () or GT15-MESB48M. • Multi-channel function • Document display function • MELSEC-Q/QnA ladder monitor function

The following GOT requires no optional function boards when using optional functions other than above. • GT15: functional version D or later To activate the built-in optional function board in the GOT, it is necessary to install the standard monitor OS on the GOT using the GT Designer Version 2.55H or later. Some functions, however, require an optional function board with expansion memory (GT15-QFNB or GT15-MESB48M) and a CF card. See below for details.

Storage memory (ROM) and operation memory (RAM)

The GOT operates while decompressing the OS and project data, which is stored in the storage memory (ROM), on the operation memory (RAM). The GT15 has a 9MB* storage memory (ROM) and the operation memory (RAM) as a standard feature. When the OS or the project data exceeds 9MB, use a CF card and an optional function board with expansion memory (GT15-QFNB or GT15-MESB48M) to increase the memory. The built-in flash memory is for "drive C". The CF card is for "drive A (standard)" or "drive B (extension)."

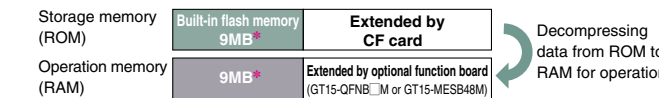

Types and capacities of data and CF card selection

The data types and capacities are as shown in the table below.

Data type	Data capacity
A Extended function OS, optional function OS	Capacity of "GT15" in [Table A] on page 79
B Second communication driver and onwards	150KB for each
C Special data	Check with a screen design software.
D Project data	Check with a screen design software.
E Buffering area	Check with a screen design software.

The buffering area **E** is an area for storing resource data such as logging and extension alarms. It uses the operation memory (RAM). The data size differs depending on the setting. When the screen design software designates file saving, the accumulated resource data is stored in the designated storage (drive A or B). (The storage memory (ROM) is not used.) If the size of data decompressed on the operation memory (RAM) exceeds 57MB*, it is necessary to reduce, for instance, the project data size or delete unnecessary OS.

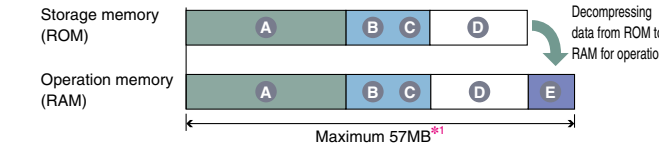

Necessity and capacity of the optional function board with expansion memory and the CF card depend on the data size. Determine the necessity and capacity of the optional function board with expansion memory and the CF card according to the following flow chart.

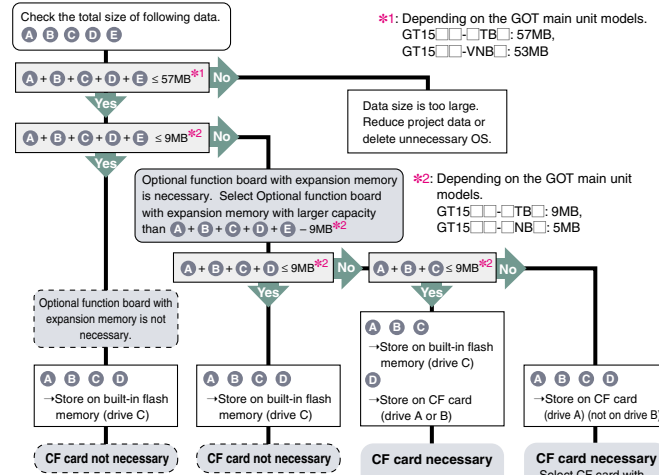

*3: When storing the extended function OS and optional function OS in the CF card (drive A), the standard monitor OS (standard monitor OS, standard font, first communication driver, etc.) needs to be stored in the CF card (drive A).

When using the GT11

When using optional functions

Since the following GOT models have a built-in optional function board (GT11-50FNB), it is unnecessary to mount an optional function board to use optional functions shown in [Table A].

- GT115-Q-BDQ • GT115-Q-BDA • GT115-QTBD • GT115-QS-Q-BD: Version B or later • GT115-Q-BD: Version C or later

[Table A] Capacity of extended functional OS and optional function OS

Function	User area size to be used (KB)				
	GT16		GT15	GT11	
	RAM	ROM			
Barcode	84	84	84	*1	
RFID	166	166	166	*1	
System monitor	746	746	746	*1	
Report	235	150	235	None	
Printer	1104	522	1104	None	
Operation log (device name conversion library)	800	400	800	None	
Stroke font	Stroke font support function	400	400	400	None
	Stroke basic font (Japanese)	2160	2160	2160	None
	Stroke basic font (Japanese) (with Hangul)	3175	3175	3175	None
	Stroke basic font (Chinese: Simplified)	1474	1474	1474	None
Video display/RGB display	Video/RGB	474	292	512	None
	Video/RGB	474	292	512	None
Multimedia	Remote personal computer operation	84	50	84	None
	Remote personal computer operation	84	50	84	None
Backup/restoration	766	420	820	None	
Operator authentication	730	460	784	None	
Audio output	200	100	200	None	
External I/O operation panel	100	70	100	None	
CNC data	CNC data input/output	383	210	437	None
	input/output GOT platform library	200	77	100	None
Device data transfer	100	50	100	None	
Maintenance time notification	Multi-channel	*2	*2	*2	None
	Multi-channel	*2	*2	*2	None
Chinese region	Standard font (Chinese: Simplified)	1280	1280	1280	None
	Standard font (Chinese: Traditional)	1920	1920	1920	None
	Standard font (Japanese)	1280	1280	1280	None
	Stroke font (Japanese)	1037	1037	1037	None
	Stroke font (Chinese: Simplified)	1248	1248	1248	None
	Stroke font (Chinese: Traditional)	1680	1680	1680	None
Optional functions	Operation log	1221	384	1218	None
	Document display	3072	150	2048	None
	Kana-Kanji conversion	None	None	1223	None
	Kana-Kanji conversion (enhanced version)	1274	242	1274	None
	Historical trend graph*3	*2	*2	*2	None
	Logging*4	710	380	740	None
	Recipe	100	70	100	*1
	Advanced recipe	1187	310	1241	None
	Object script*4	360	180	360	None
	Ladder monitor	MELSEC-A ladder monitor	674	342	523
MELSEC-FX ladder monitor		674	342	592	None
MELSEC-Q/QnA ladder monitor		4170	590	1082	None

To use the multi-channel function <GT16/GT15>

The multi-channel function is designed to connect and monitor multiple FA devices by mounting multiple communication units on a single GOT unit or by using the standard interface.

Acceptable combinations

The following connection combinations can be used for the multi-channel function.

When using GT16:

- ① Bus connection, or network connection *1 + serial connection *2
- ② Bus connection, or network connection *1 + Ethernet connection *3
- ③ Ethernet connection *3 + serial connection *2
- ④ Bus connection, or network connection *1 + Ethernet connection *3 + serial connection *2
- ⑤ Serial connection *2
- ⑥ Ethernet connection *3

When using GT15:

- ① Bus connection, network connection *1, or Ethernet connection *3 + serial connection *2
- ② Serial connection *2

*1: The network connections include the following connection configurations. • MELSECNET/H connection • MELSECNET/10 connection • CC-Link IE connection • CC-Link connection (ID) *2: The serial connections include the following connection configurations. • CPU direct connection • Computer link connection • CC-Link connection (via G4) • Microcomputer connection • Connection with third party PLCs • Temperature controller connection • Inverter connection • Servo amplifier connection • CNC connection (CPU direct connection) *3: The Ethernet connections include the following connection configurations. • Ethernet connection • MODBUS/TCP connection

	GT1695/GT1685	GT1595/GT1585GT157 /GT156	GT155	Description
(1) Number of connectable channels	Up to 4 channels		Up to 2 channels	For GT16: The number of communication ports (communication units and interfaces) for use for communication on GOT. • Only one channel per one GOT can be connected in bus connection and network connection. • Ethernet connection is available up to four channels. • When the Ethernet interface built in the GOT is used for functions other than communication with the connected device *4, the interface is not included in the number of connected channels. • When the RS-232 standard interface is used for connection *5 with a peripheral device, the interface is not included in the number of connected channels. (See "Calculation of current consumed by units <GT16/GT15>" (page 80).) For GT15: The number of communication ports (communication units and interfaces) for use for communication on GOT. • Only one channel per one GOT can be connected in bus connection and network connection. • When the Ethernet communication unit is used for functions other than communication with the connected device *4, the unit is not included in the number of connected channels. • When the RS-232 standard interface is used for connection *5 with a peripheral device, the interface is not included in the number of connected channels. (See "Calculation of current consumed by units <GT16/GT15>" (page 80).)
Number of mountable units	Up to 5 units		Up to 3 units	The number of units that can be mounted on the extension unit interfaces 1 and 2 of GOT. • More than one serial communication unit *6 of the same model can be mounted. • Optical units are included in the number of units. • RS-422 conversion units are not included in the number of units. • It is necessary to calculate the total current consumed by the units to be mounted. (See "Calculation of current consumed by units <GT16/GT15>" (page 80).)
Number of mounting stages	Up to 3 stages (2 slots)		Up to 3 stages (1 slot)	The number of mounting stages that units can be stacked on the extension unit interfaces 1 and 2 of GOT. • Units that occupy two slots *7 *8 must be mounted on the first stage. • When any units in *8 is used, mount the unit on the first stage, then mount other units on the second or subsequent stages. • Units in *9 cannot be stacked on other units. Mount any of the units on the first stage. (See "External dimensions" (page 76) and "Mounting units on the GOT side interface <GT16/GT15>" (page 80).)

*4: Ethernet download function, gateway function and MES interface function *5: Barcode function, RFID function, remote personal computer operation function, FA transparent function, OS install and project data download *6: GT15-QBUSL, GT15-QBUS2L, GT15-75ABUSL, GT15-75ABUS2L, GT15-75J1BP23-Z, GT15-75J61BT13-Z *7: GT15-QBUS2, GT15-ABUS2, GT15-J1LP23-25, GT15-J1BP23-25, GT15-J1BP23-25, GT15-J1BP23-25 *8: GT16M-V4, GT15V-75V4, GT16M-R2, GT15V-75R1, GT16M-V4R1, GT15V-75V4R1, GT16M-ROUT, GT15V-75ROUT, GT16M-MMR *9: GT15-RS2-9P, GT15-RS4-9S and GT15-RS4-TE

For Designers For Operators For Initial Startup & Adjustment Operators For Maintenance Personnel GT10 Handy GOT GT-SoftGOT1000 Version2 IQ Platform MELSEC Process Control +GOT1000 List of Connectable Models etc.

Mounting units on the GOT side interface <GT16/GT15>

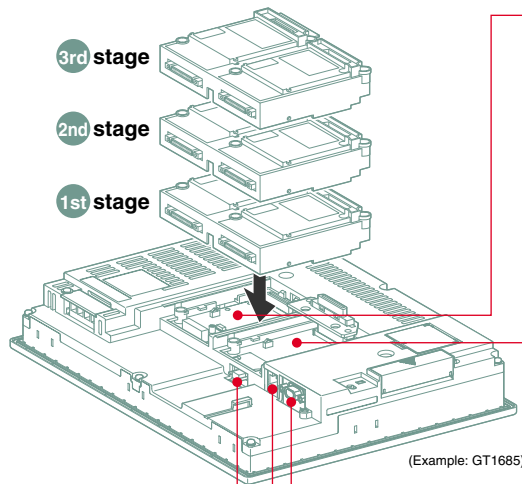

Extension unit interface 1

Extension unit interface 2 (GT155□ has the extension unit interface 1 only)

Up to 3 communication units and optional units can be mounted on each extension unit interface.

Mount a unit that occupies two slots on the first stage. However, when any of the following units are used, mount the unit on the first stage, then mount other units on the second and subsequent stages.

For GT16 (Only one of these units can be mounted on the GT16)
 ●GT16M-V4, GT16M-R2, GT16-V4R1, GT16-ROUT, GT16M-MMR

For GT15 (Only one of these units can be mounted on the GT1585V and GT1575V)
 ●GT15V-75V4, GT15V-75R1, GT15V-75V4R1, GT15V-75ROUT

The following units must not be stacked on other units. Mount any of them on the first stage.

- GT15-75QBUSL, GT15-75QBUS2L, GT15-75ABUSL, GT15-75ABUS2L
- GT15-75J1LP23-Z, GT15-75J1BR13-Z, GT15-75J61BT13-Z (GT16 or GT155□ cannot be used.)

Instructions for mounting and removing the GT15-CFCD

- An extension unit cannot be mounted on a CF card unit. When extension units are mounted, mount the CF card unit on the last stage.
- When mounting a CF card unit on the extension interface 1 (left), ensure that the number of extension units mounted on the extension interface 2 (right) is smaller than the number on the extension interface 1 (left). Otherwise, the CF card cannot be inserted or removed.
- Remove the CF card unit in the designated direction (ΔPULL) to prevent damage to the connector.

Unit occupying two slots
Ex.: GT15-QBUS2

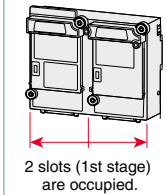

Standard interface (built-in RS-232 interface)

The interface can establish a serial connection with connected devices and peripheral devices, such as a barcode reader.

Standard interface (built-in Ethernet interface) (GT16 only)

The interface can establish a connection with connected devices via Ethernet.

Standard interface (built-in RS-422/485 interface) (GT16 only)

The interface can establish a serial connection with connected devices.

Calculation of current consumed by units <GT16/15>

When using multiple units, a barcode reader, and a RFID controller, the total current consumed by the units, barcode reader and RFID controller must be less than the current that can be supplied by the GOT. Design the system using the following values so that the total current is within the range of the current supply capacity of the GOT.

(1) Current that can be supplied by the GOT

GOT model	Current supply capacity (A)
GT1695	2.4
GT1685	2.4
GT1595	2.13
GT1585 (incl. GT1585V)	1.74
GT157□ (incl. GT1575V)	2.2
GT156□	2.2
GT155□	1.3

(2) Current used by units, barcode reader and RFID controller

Unit model	Consumed current (A)	Unit model	Consumed current (A)
GT15-QBUS	0.275*1	Barcode reader	*2
GT15-QBUS2		GT15-PRN	0.09
GT15-75QBUSL		GT16M-V4	0.12 *1
GT15-75QBUS2L	GT15V-75V4	0.2 *1	
GT15-ABUS	GT16M-R2	0 *1	
GT15-ABUS2	GT15V-75R1	0.2 *1	
GT15-75ABUSL	GT16M-V4R1	0.12 *1	
GT15-75ABUS2L	GT15V-75V4R1	0.2 *1	
GT15-RS2-9P	0.29	GT16M-ROUT	0.11 *1
GT15-RS4-9S	0.33	GT15V-75ROUT	0.11
GT15-RS4-TE	0.3	GT16M-MMR	0.27 *1
GT15-RS2T4-9P	0.098	GT15-CFCD	0.07
GT15-J71E71-100	0.224	GT15-CFEX-C08SET	0.15
GT15-J71GP23-SX	1.07	GT15-SOUT	0.08
GT15-J71LP23-25	0.56	GT15-DIO	0.1
GT15-J71BR13	0.77	GT15-DIOR	0.1
GT15-J61BT13	0.56	RFID controller	*2

*1: This value is used for calculating the current consumption of multi-channel functions. For the specifications of each unit, see the manual supplied with each unit.
 *2: When using a barcode reader or a RFID controller to which the power is supplied from the standard interface, add the current to be used by the barcode reader and RFID controller at 5VDC. (Maximum less than 0.3A)

(3) Calculation example

(a) When GT15-J71BR13, GT15-RS4-9S (3 units), GT15-J71E71-100 (for gateway function) and barcode reader (0.12A) are connected to GT1575-V:

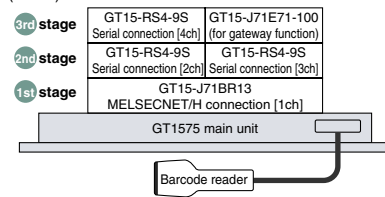

Current supply capacity of GOT (A)	Total current to be consumed (A)
2.2	0.77+0.33+0.33+0.33+0.224+0.12=2.104

Since the total current is within the current supply capacity of the GOT, the units can be used.

(b) When GT15-J71BR13, GT15-RS4-9S (2 units), GT15-J71E71-100 (for gateway function) and barcode reader (0.12A) are connected to GT1585-S:

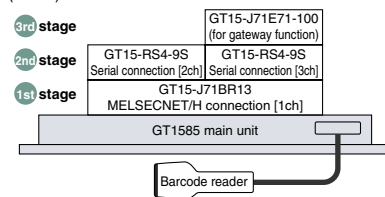

Current supply capacity of GOT (A)	Total current to be consumed (A)
1.74	0.77+0.33+0.33+0.224+0.12=1.774

Not allowed to use because the current exceeds the current supply capacity of the GOT.

GT Designer2 (English version) operating environment

Item	Description
Personal computer	PC/AT compatible machine on which Windows® operates
OS	Microsoft® Windows®98 Operating System (English version)*8 Microsoft® Windows® Millennium Edition Operating System (English version)*8 Microsoft® WindowsNT® Workstation 4.0 Operating System Service Pack 3 or later (English version)*1*8 Microsoft® Windows® 2000 Professional Operating System Service Pack 4 or later (English version)*1*8 Microsoft® Windows® XP Professional Operating System Service Pack 2 or later (English version)*2*4*5*8 Microsoft® Windows® XP Home Edition Operating System Service Pack 2 or later (English version)*2*4*5*8 Microsoft® Windows Vista® Ultimate Operating System (English version)*3*4*5*8 Microsoft® Windows Vista® Enterprise Operating System (English version)*3*4*5*8 Microsoft® Windows Vista® Home Premium Operating System (English version)*3*4*5*8 Microsoft® Windows Vista® Home Basic Operating System (English version)*3*4*5*8
CPU	Pentium® 200MHz or higher Microsoft® Windows® XP : Pentium II® 300MHz or higher Microsoft® Windows Vista® : 800MHz or more (recommended: 1GHz or more)
Required memory	64MB or more Microsoft® Windows Vista® : 512MB or more (recommended: 1GB or more)
Free hard disk space	For installation: 1.1GB or more *7 For operation: 100MB or more
Disk drive	CD-ROM disk drive
Display colors	High color (16 bits) or more
Display*6	Resolution 800 × 600 dots or more
Other	Internet Explorer version 5.0 or later must be installed. Mouse, keyboard, printer and CD-ROM drive that can be used on the above OS

*1: To install GT Designer2, administrator authority is required.
 *2: To install and use GT Designer2, administrator authority is required.
 *3: To install GT Designer2, administrator authority is required. To use GT Designer2 in cooperation with another application, if an administrator account is used to run the application then use an administrator account to run GT Designer2.
 *4: The following functions are not supported.
 • Compatible Mode • Fast User Switching • Desktop Theme (Font) Change • Remote Desktop
 *5: Only the 32-bit OS is applicable.
 *6: To use the MES interface function, the display must have a resolution of 1024 × 768 dots or more.
 *7: 800MB or more for Windows® 98, Windows® Millennium Edition and WindowsNT®.
 *8: The following language versions are also applicable: Chinese (Simplified/Traditional), Korean, German.

GT Simulator2 (English version) operating environment

Item	Description
Personal computer	PC/AT compatible machine on which Windows® operates
OS	Microsoft® Windows®98 Operating System (English version) Microsoft® Windows® Millennium Edition Operating System (English version) Microsoft® WindowsNT® Workstation 4.0 Operating System Service Pack 3 or later (English version)*2 Microsoft® Windows® 2000 Professional Operating System Service Pack 4 or later (English version)*2 Microsoft® Windows® XP Professional Operating System Service Pack 2 or later (English version)*3*4*7 Microsoft® Windows® XP Home Edition Operating System Service Pack 2 or later (English version)*3*4*7 Microsoft® Windows Vista® Ultimate Operating System (English version)*3*4*7 Microsoft® Windows Vista® Enterprise Operating System (English version)*3*4*7 Microsoft® Windows Vista® Business Operating System (English version)*3*4*7 Microsoft® Windows Vista® Home Premium Operating System (English version)*3*4*7 Microsoft® Windows Vista® Home Basic Operating System (English version)*3*4*7
CPU	Pentium® 200MHz or higher Microsoft® Windows® XP : Pentium II® 300MHz or higher Microsoft® Windows Vista® : 800MHz or more (recommended: 1GHz or more)
Required memory	64MB or more Microsoft® Windows® XP : 128MB or more Microsoft® Windows Vista® : 512MB or more (recommended: 1GB or more)
Free hard disk space*1	For installation (product only) : 700MB or more For operation (product + manual): 950MB or more For operation : 200MB or more
Disk drive	CD-ROM disk drive
Display colors	For GT16 simulator: 65,536 colors For GT15 simulator: 65,536 colors For GT11 simulator: 256 colors
Display	Resolution 800 × 600 dots or more (to use full-screen display function: resolution 1024 × 768 dots or more)

Software	For creation/editing of project data	For use of GX Simulator
	GT Designer2*5	GX Simulator version 5 or later*6
	The GX Simulator software versions for simulating PLC CPUs are as follows.	
	PLC CPU to be simulated	Software version
	QCPU (A mode), ACPU, motion controller CPU (A series)	Version 5A or later
	QCPU (Q mode) (excl. Q00J, Q00 and Q01CPU), QnACPU, FXCPU	Version 5E or later
	Q00JCPU, Q00CPU, Q01CPU	Version 6.00A or later
	Q02PHCPU, Q06PHCPU	Version 7.20W or later
	Q12PHCPU, Q25PHCPU	Version 6.10L or later
	Q12PRHCPU, Q25PRHCPU	Version 6.20W or later
	FX3uc series	Version 6.20W or later
	FX3u series	Version 7.08J or later

*1: To use GT Designer2, GX Developer and GX Simulator, additional free space is required.
 *2: To install GT Simulator2, administrator authority is required.
 *3: To install and use GT Simulator2, administrator authority is required.
 *4: The following functions are not supported.
 • Compatible Mode • Fast User Switching • Desktop Theme (Font) Change • Remote Desktop
 *5: Use GT Designer2 in the GT Works2 containing GT Simulator2.
 *6: Use GT Simulator2, GX Developer and GX Simulator of the same language version.
 *7: Only the 32-bit OS is applicable.

For Designers
 For Operators
 For Initial Startup & Adjustment Operators
 For Maintenance Personnel
 GT10
 Handy GOT
 GT-SoftGOT1000 Version2
 IQ Platform
 MELSEC Process Control + GOT1000
 List of Connectable Models, etc.

Function list

Category	GT16		GT15		GT SoftGOT		Optional function board #2	Extended optional function OS installation #2	Other necessary devices #3	Details page	Model										
	Function #1		GT16		GT15						GT15							GT SoftGOT 1000 Version2 #4			
	GT1695M	GT1685M	GT1595	GT1585(V)	GT1575(V)	GT157					GT1565	GT1562	GT155	GT155	GT155	GT155	GT155	GT155			
Specifications	Supported image data format	BMP image display	●	●	●	●	●	●	●	●	●	●	●	●	●	●	●				
		JPEG image display	●	●	●	●	●	●	●	●	●	●	●	●	●	●	●	●			
		DXF data	●	●	●	●	●	●	●	●	●	●	●	●	●	●	●	●			
		IGES data	●	●	●	●	●	●	●	●	●	●	●	●	●	●	●	●			
	Standard fonts (basic)	Japanese, Japanese (supporting European languages), Chinese (Simplified), Chinese (Traditional), supporting European languages	●	●	●	●	●	●	●	●	●	●	●	●	●	●	●	●			
		Chinese (Simplified)	●	●	●	●	●	●	●	●	●	●	●	●	●	●	●	●			
		Chinese (Traditional)	●	●	●	●	●	●	●	●	●	●	●	●	●	●	●	●			
	Standard fonts (optional)	Japanese	●	●	●	●	●	●	●	●	●	●	●	●	●	●	●	●			
		High-quality font	●	●	●	●	●	●	●	●	●	●	●	●	●	●	●	●			
		TrueType font	●	●	●	●	●	●	●	●	●	●	●	●	●	●	●	●			
	Common settings	Screen switching	●	●	●	●	●	●	●	●	●	●	●	●	●	●	●	●			
		Station No. switching	●	●	●	●	●	●	●	●	●	●	●	●	●	●	●	●			
		Multilingual support function	●	●	●	●	●	●	●	●	●	●	●	●	●	●	●	●			
		Password	●	●	●	●	●	●	●	●	●	●	●	●	●	●	●	●			
		System information	●	●	●	●	●	●	●	●	●	●	●	●	●	●	●	●			
Screen design	Parts (object + figure) layer function	Screen switching	●	●	●	●	●	●	●	●	●	●	●	●	●	●	●				
		Station No. switching	●	●	●	●	●	●	●	●	●	●	●	●	●	●	●	●			
		Multilingual support function	●	●	●	●	●	●	●	●	●	●	●	●	●	●	●	●			
	Object settings	Parts registration	●	●	●	●	●	●	●	●	●	●	●	●	●	●	●	●			
		Data operation function	●	●	●	●	●	●	●	●	●	●	●	●	●	●	●	●			
		Offset function	●	●	●	●	●	●	●	●	●	●	●	●	●	●	●	●			
	Others	Security function	●	●	●	●	●	●	●	●	●	●	●	●	●	●	●	●			
		Lamp display	●	●	●	●	●	●	●	●	●	●	●	●	●	●	●	●			
		Touch switch	●	●	●	●	●	●	●	●	●	●	●	●	●	●	●	●			
	Maintenance functions	Device data transfer function	Remote personal computer function	●	●	●	●	●	●	●	●	●	●	●	●	●	●	●	●		
			Sound output function	●	●	●	●	●	●	●	●	●	●	●	●	●	●	●	●		
			External input/output function	●	●	●	●	●	●	●	●	●	●	●	●	●	●	●	●		
		Script function	Operation panel function	●	●	●	●	●	●	●	●	●	●	●	●	●	●	●	●		
			Screen call function	●	●	●	●	●	●	●	●	●	●	●	●	●	●	●	●		
			Operation log function	●	●	●	●	●	●	●	●	●	●	●	●	●	●	●	●		
Maintenance functions		Document display function	●	●	●	●	●	●	●	●	●	●	●	●	●	●	●	●			
		Logging function	●	●	●	●	●	●	●	●	●	●	●	●	●	●	●	●			
		Script function	●	●	●	●	●	●	●	●	●	●	●	●	●	●	●	●			
Maintenance functions		Device data transfer function	Device data transfer function	●	●	●	●	●	●	●	●	●	●	●	●	●	●	●	●		
			Device monitor function	●	●	●	●	●	●	●	●	●	●	●	●	●	●	●	●		
			System monitor function	●	●	●	●	●	●	●	●	●	●	●	●	●	●	●	●		
		Script function	List editor for A	●	●	●	●	●	●	●	●	●	●	●	●	●	●	●	●		
			List editor for FX	●	●	●	●	●	●	●	●	●	●	●	●	●	●	●	●		
			SFC monitor function	●	●	●	●	●	●	●	●	●	●	●	●	●	●	●	●		
	Maintenance functions	Ladder monitor function	●	●	●	●	●	●	●	●	●	●	●	●	●	●	●	●			
		Intelligent unit monitor function	●	●	●	●	●	●	●	●	●	●	●	●	●	●	●	●			
		Q motion monitor function	●	●	●	●	●	●	●	●	●	●	●	●	●	●	●	●			
	Maintenance functions	Servo amplifier monitor function	●	●	●	●	●	●	●	●	●	●	●	●	●	●	●	●			
		Network monitor function	●	●	●	●	●	●	●	●	●	●	●	●	●	●	●	●			
		CNC monitor function	●	●	●	●	●	●	●	●	●	●	●	●	●	●	●	●			
	Maintenance functions	CNC data input/output function	●	●	●	●	●	●	●	●	●	●	●	●	●	●	●	●			
		Backup/restoration function	●	●	●	●	●	●	●	●	●	●	●	●	●	●	●	●			
		Maintenance time notification function	●	●	●	●	●	●	●	●	●	●	●	●	●	●	●	●			

Category	GT11		GT10		Optional function board #2	Extended optional function OS installation #2	Other necessary devices #3	Details page	Model						
	Function #1		GT11						GT10 #4		GT1020				
	GT115	GT115	GT115	GT105					GT1030	GT1020					
Specifications	Supported image data format	BMP image display	●	●	●	●	●	●	●	●	●	●	●	●	
		JPEG image display	●	●	●	●	●	●	●	●	●	●	●	●	
		DXF data	●	●	●	●	●	●	●	●	●	●	●	●	
		IGES data	●	●	●	●	●	●	●	●	●	●	●	●	
	Standard fonts (basic)	Japanese, Japanese (supporting European languages), Chinese (Simplified), Chinese (Traditional), supporting European languages	●	●	●	●	●	●	●	●	●	●	●	●	
		Chinese (Simplified)	●	●	●	●	●	●	●	●	●	●	●	●	
		Chinese (Traditional)	●	●	●	●	●	●	●	●	●	●	●	●	
	Standard fonts (optional)	Japanese	●	●	●	●	●	●	●	●	●	●	●	●	
		High-quality font	●	●	●	●	●	●	●	●	●	●	●	●	
		TrueType font	●	●	●	●	●	●	●	●	●	●	●	●	
	Common settings	Screen switching	●	●	●	●	●	●	●	●	●	●	●	●	
		Station No. switching	●	●	●	●	●	●	●	●	●	●	●	●	
		Multilingual support function	●	●	●	●	●	●	●	●	●	●	●	●	
		Password	●	●	●	●	●	●	●	●	●	●	●	●	
		System information	●	●	●	●	●	●	●	●	●	●	●	●	
Screen design	Parts (object + figure) layer function	Screen switching	●	●	●	●	●	●	●	●	●	●	●	●	
		Station No. switching	●	●	●	●	●	●	●	●	●	●	●	●	
		Multilingual support function	●	●	●	●	●	●	●	●	●	●	●	●	
	Object settings	Parts registration	●	●	●	●	●	●	●	●	●	●	●	●	
		Data operation function	●	●	●	●	●	●	●	●	●	●	●	●	
		Offset function	●	●	●	●	●	●	●	●	●	●	●	●	
	Others	Security function	●	●	●	●	●	●	●	●	●	●	●	●	
		Lamp display	●	●	●	●	●	●	●	●	●	●	●	●	
		Touch switch	●	●	●	●	●	●	●	●	●	●	●	●	
	Maintenance functions	Device data transfer function	Remote personal computer function	●	●	●	●	●	●	●	●	●	●	●	●
			Sound output function	●	●	●	●	●	●	●	●	●	●	●	●
			External input/output function	●	●	●	●	●	●	●	●	●	●	●	●
		Script function	Operation panel function	●	●	●	●	●	●	●	●	●	●	●	●
			Screen call function	●	●	●	●	●	●	●	●	●	●	●	●
			Operation log function	●	●	●	●	●	●	●	●	●	●	●	●
Maintenance functions		Document display function	●	●	●	●	●	●	●	●	●	●	●	●	
		Logging function	●	●	●	●	●	●	●	●	●	●	●	●	
		Script function	●	●	●	●	●	●	●	●	●	●	●	●	
Maintenance functions		Device data transfer function	Device data transfer function	●	●	●	●	●	●	●	●	●	●	●	●
			Device monitor function	●	●	●	●	●	●	●	●	●	●	●	●
			System monitor function	●	●	●	●	●	●	●	●	●	●	●	●
		Script function	List editor for A	●	●	●	●	●	●	●	●	●	●	●	●
			List editor for FX	●	●	●	●	●	●	●	●	●	●	●	●
			SFC monitor function	●	●	●	●	●	●	●	●	●	●	●	●
	Maintenance functions	Ladder monitor function	●	●	●	●	●	●	●	●	●	●	●	●	
		Intelligent unit monitor function	●	●	●	●	●	●	●	●	●	●	●	●	
		Q motion monitor function	●	●	●	●	●	●	●	●	●	●	●	●	
	Maintenance functions	Servo amplifier monitor function	●	●	●	●	●	●	●	●	●	●	●	●	
		Network monitor function	●	●	●	●	●	●	●	●	●	●	●	●	
		CNC monitor function	●	●	●	●	●	●	●	●	●	●	●	●	
	Maintenance functions	CNC data input/output function	●	●	●	●	●	●	●	●	●	●	●	●	
		Backup/restoration function	●	●	●	●	●	●	●	●	●	●	●	●	
		Maintenance time notification function	●	●	●	●	●	●	●	●	●	●	●	●	

- *1: The function details, such as the number of settings and the data storage destination, vary depending on the model.
- *2: An optional function board may be required depending on the models, function version or hardware version of the GOT main unit. The optional function board to be used varies depending on the required function. For details, see "Notes for use" (page 77). For the GT10 and GT SoftGOT1000, it is unnecessary to install an optional function board or the extended/optional function OS.
- *3: Necessary options or optional units other than the optional function board are shown. Parenthesized devices will be required depending on conditions of use. For details, see "Notes for use, Selection of optional units and devices" (page 77).
- *4: For details, see "GT10" (page 52), "Handy GOT" (page 57) and "GT SoftGOT1000" (page 58).
- *5: The RS-232 interface can be used as an RS-422 interface by connecting an RS-422 conversion unit.
- *6: Structural restrictions are applied.
- *7: Only user alarms can be used.
- *8: To use the historical trend graph, it is necessary to specify the logging function in advance. In addition, it is necessary to install the optional function OS (logging).
- *9: Read from the PLC clock.
- *10: Only Japanese fonts (supporting European languages) can be used.
- *11: Different connection configurations may require different communication units. For details, see the GOT1000 Series Handbook and the GOT1000 Series Connection Manual.

For Designers
 For Operators
 For Initial Startup & Adjustment Operators
 For Maintenance Personnel
 GT10
 Handy GOT
 GT SoftGOT1000 Version2
 IQ Platform
 MELSEC Process Control + GOT1000
 List of Connectable Models, etc.

Product list

Main unit model name

GT16 9 5 M - XTBA

Code	Screen size	Code	Display colors	Code	Mounting type	Code	Resolution	Code	Display device	Code	Power supply	Code	Communication interface
9	15"	5	256 colors or more	V	Compatible with video/RGB	X	XGA (1024 × 768 dots)	T	TFT color (high brightness, wide viewing angle)	A	100 to 240VAC	Q*1	With built-in bus connection interface for QCPU (Q mode)/motion controller CPU (Q series)
8	12.1"	2	16 colors	None	Panel mount type	S	SVGA (800 × 600 dots)	N	TFT color	D	24VDC	A*1	With built-in bus connection interface for QnA/ACPU/motion controller CPU (A series)
7	10.4"	0	Monochrome	HS	Handy type	V	VGA (640 × 480 dots)	S	STN color	L	5VDC	2*2	With built-in RS-232
6	8.4"			M	Compatible with multimedia & Video/RGB	Q	QVGA (320 × 240 dots)	B	STN monochrome (blue/white)	None*2		None*2	With built-in RS-422
5	5.7"					None	(288 × 96 dots)	L	STN monochrome			*1 : GT115□□-Q□_BDQ and GT115□□-Q□_BDA only	
3	4.5"						(160 × 64 dots)					*2 : GT10 only	
2	3.7"												

Code	Main unit frame	Code	GT10 backlight
B	Black	W	White backlight
W	White	None	Green backlight

* For inquiries relating to products which conform to UL, cUL, and CE directives, please contact your local sales office.

GOT main units

Model name	Screen size [resolution]	Display	Display colors (number of colors)	Power supply	Memory size	Remarks		
GT16	GT1695M-XTBA NEW	15" XGA [1024 × 768 dots]	TFT color LCD (high brightness, wide viewing angle)	65,536 colors	100-240VAC 24VDC	15MB	Compatible with multimedia & Video/RGB	
	GT1695M-XTBD NEW	15" XGA [1024 × 768 dots]	TFT color LCD (high brightness, wide viewing angle)	65,536 colors	100-240VAC 24VDC	15MB	Compatible with multimedia & Video/RGB	
	GT1685M-STBA NEW	12.1" SVGA [800 × 600 dots]	TFT color LCD (high brightness, wide viewing angle)	65,536 colors	100-240VAC 24VDC	15MB	Compatible with multimedia & Video/RGB	
	GT1685M-STBD NEW	12.1" SVGA [800 × 600 dots]	TFT color LCD (high brightness, wide viewing angle)	65,536 colors	100-240VAC 24VDC	15MB	Compatible with multimedia & Video/RGB	
GT15	GT1595	15" XGA [1024 × 768 dots]	TFT color LCD (high brightness, wide viewing angle)	65,536 colors	100-240VAC 24VDC	9MB	—	
	GT1585	GT1585V-STBA	12.1" SVGA [800 × 600 dots]	TFT color LCD (high brightness, wide viewing angle)	65,536 colors	100-240VAC 24VDC	9MB	Compatible with Video/RGB
		GT1585V-STBD	12.1" SVGA [800 × 600 dots]	TFT color LCD (high brightness, wide viewing angle)	65,536 colors	100-240VAC 24VDC	9MB	Compatible with Video/RGB
		GT1585-STBA	12.1" SVGA [800 × 600 dots]	TFT color LCD (high brightness, wide viewing angle)	65,536 colors	100-240VAC 24VDC	9MB	Compatible with Video/RGB
		GT1585-STBD	12.1" SVGA [800 × 600 dots]	TFT color LCD (high brightness, wide viewing angle)	65,536 colors	100-240VAC 24VDC	9MB	Compatible with Video/RGB
	GT157	GT1575V-STBA	10.4" SVGA [800 × 600 dots]	TFT color LCD (high brightness, wide viewing angle)	65,536 colors	100-240VAC 24VDC	9MB	Compatible with Video/RGB
		GT1575V-STBD	10.4" SVGA [800 × 600 dots]	TFT color LCD (high brightness, wide viewing angle)	65,536 colors	100-240VAC 24VDC	9MB	Compatible with Video/RGB
		GT1575-VTBA	10.4" VGA [640 × 480 dots]	TFT color LCD (high brightness, wide viewing angle)	65,536 colors	100-240VAC 24VDC	9MB	—
		GT1575-VTBD	10.4" VGA [640 × 480 dots]	TFT color LCD (high brightness, wide viewing angle)	65,536 colors	100-240VAC 24VDC	9MB	—
		GT1575-VNBA	10.4" VGA [640 × 480 dots]	TFT color LCD	256 colors	100-240VAC 24VDC	5MB	—
		GT1575-VNBD	10.4" VGA [640 × 480 dots]	TFT color LCD	16 colors	100-240VAC 24VDC	5MB	—
	GT156	GT1565-VTBA	8.4" VGA [640 × 480 dots]	TFT color LCD (high brightness, wide viewing angle)	65,536 colors	100-240VAC 24VDC	9MB	—
GT1565-VTBD		8.4" VGA [640 × 480 dots]	TFT color LCD (high brightness, wide viewing angle)	65,536 colors	100-240VAC 24VDC	9MB	—	
GT1562-VNBA		8.4" VGA [640 × 480 dots]	TFT color LCD	16 colors	100-240VAC 24VDC	5MB	—	
GT1562-VNBD		8.4" VGA [640 × 480 dots]	TFT color LCD	16 colors	100-240VAC 24VDC	5MB	—	
GT155	GT1555-VTBD	5.7" VGA [640 × 480 dots]	TFT color LCD (high brightness, wide viewing angle)	65,536 colors	24VDC	9MB	—	
	GT1555-QTBD	5.7" QVGA [320 × 240 dots]	STN color LCD	4,096 colors	24VDC	9MB	—	
	GT1555-QSBD	5.7" QVGA [320 × 240 dots]	STN monochrome LCD	Monochrome (black/white) 16 gray scales	24VDC	9MB	—	
	GT1550-QLBD	5.7" QVGA [320 × 240 dots]	STN monochrome LCD	Monochrome (black/white) 16 gray scales	24VDC	9MB	—	
GT11	GT1155-QTBD	5.7" QVGA [320 × 240 dots]	TFT color LCD	256 colors	24VDC	3MB	—	
	GT1155-QTBDQ		Dedicated to Q bus connection					
	GT1155-QTBDA		Dedicated to A bus connection					
	GT1155-QSBD		—					
	GT1155-QSBDQ	Dedicated to Q bus connection						
	GT1155-QSBDQ	Dedicated to Q bus connection						
	GT1155-QSBDQ	Dedicated to Q bus connection						
	GT1155-QSBDQ	Dedicated to Q bus connection						
	GT1150-QLBD	5.7" QVGA [320 × 240 dots]	STN monochrome LCD	Monochrome (black/white) 16 gray scales	24VDC	3MB	—	
	GT1150-QLBDQ		Dedicated to Q bus connection					
GT1150-QLBDA	Dedicated to A bus connection							
GT1150-QLBDQ	Dedicated to Q bus connection							
GT1150-QLBDA	Dedicated to A bus connection							
Handy GOT	GT1155HS-QSBD	STN color LCD	256 colors	24VDC	3MB	—		
	GT1150HS-QLBD	STN monochrome LCD	Monochrome (black/white) 16 gray scales	24VDC	3MB	—		
GT10	GT1055-QSBD NEW	5.7" QVGA [320 × 240 dots]	STN color LCD	256 colors	24VDC	3MB	—	
	GT1050-QBBD NEW		STN monochrome LCD				Monochrome (blue/white) 16 gray scales	
	GT1030	GT1030-LBD	4.5" [288 × 96 dots]	STN monochrome LCD	3-color LED (green, orange, red)	24VDC	1.5MB	Dedicated to RS-422 connection
		GT1030-LBD2						Dedicated to RS-232 connection
		GT1030-LBDW						Dedicated to RS-422 connection
		GT1030-LBDW2	Dedicated to RS-232 connection					
		GT1030-LWD	4.5" [288 × 96 dots]	STN monochrome LCD	3-color LED (green, orange, red)	24VDC	1.5MB	Dedicated to RS-422 connection
		GT1030-LWD2						Dedicated to RS-232 connection
	GT1020	GT1020-LBD	3.7" [160 × 64 dots]	STN monochrome LCD	3-color LED (green, orange, red)	24VDC	512KB	Dedicated to RS-422 connection
		GT1020-LBD2						Dedicated to RS-232 connection
		GT1020-LBL						Dedicated to RS-422FX connection
		GT1020-LBDW						Dedicated to RS-422 connection
GT1020-LBDW2		Dedicated to RS-232 connection						
GT1020-LBLW		3.7" [160 × 64 dots]	STN monochrome LCD	3-color LED (green, orange, red)	24VDC	512KB	Dedicated to RS-422FX connection	
GT1020-LWD							Dedicated to RS-422 connection	
GT1020-LWD2							Dedicated to RS-232 connection	
GT1020-LWL							Dedicated to RS-422FX connection	
GT1020-LWDW							Dedicated to RS-422 connection	

Communication interface

Product name	Model name	Specifications	Applicable model				
			GT16	GT15	GT11	Handy GOT	GT10
Bus connection unit	GT15-QBUS	Bus connection (1ch) unit standard model for QCPU (Q mode)/motion controller CPU (Q series)	●	●	—	—	—
	GT15-QBUS2	Bus connection (2ch) unit standard model for QCPU (Q mode)/motion controller CPU (Q series)	●	●	—	—	—
	GT15-ABUS	Bus connection (1ch) unit standard model for QnA/ACPU/motion controller CPU (A series)	●	●	—	—	—
	GT15-ABUS2	Bus connection (2ch) unit standard model for QnA/ACPU/motion controller CPU (A series)	●	●	—	—	—
	GT15-75QBUSL	Bus connection (1ch) unit thin model*1 for QCPU (Q mode)/motion controller CPU (Q series)	●	●	—	—	—
	GT15-75QBUS2L	Bus connection (2ch) unit thin model*1 for QCPU (Q mode)/motion controller CPU (Q series)	●	●	—	—	—
	GT15-75ABUSL	Bus connection (1ch) unit thin model*1 for QnA/ACPU/motion controller CPU (A series)	●	●	—	—	—
Serial communication unit	GT15-RS2-9P	RS-232 serial communication unit (D-sub 9-pin (male))	●	●	—	—	—
	GT15-RS4-9S	RS-422/485 serial communication unit (D-sub 9-pin (female))*2 *3	●	●	—	—	—
	GT15-RS4-TE	RS-422/485 serial communication unit (terminal block)*2 * Usable only when connecting to temperature controllers/indicating controllers via RS-485.	●	●	—	—	—
	RS-422 conversion unit	GT15-RS2T4-9P	RS-232 → RS-422 conversion unit	●	●*4	—	—
MELSECNET/H communication unit	GT15-J1LP23-25	Optical loop unit	●	●*4	—	—	—
	GT15-J71BR13	Coaxial bus unit	●	●	—	—	—
CC-Link IE controller network communication unit	GT15-J71GP23-SX	Optical loop unit	●	●	—	—	—
	GT15-J61BT13	Intelligent device station unit (supporting CC-Link version 2)	●	●	—	—	—
Ethernet communication unit	GT15-J71E71-100	Ethernet (100Base-TX) unit	—	●	—	—	—

*1 : The unit cannot be used stacked on other units.
 *2 : The unit may not be able to be used depending on the connection destination. See "List of connectable models" (page 66).
 *3 : The unit cannot be used when connecting to temperature controllers/indicating controllers via RS-485 (2-wire type).
 *4 : The unit cannot be used with the GT155□□.

Optional units

Product name	Model name	Specifications	Applicable model				
			GT16	GT15	GT11	Handy GOT	GT10
Printer unit	GT15-PRN	USB slave (PictBridge) for printer connection, 1ch * Cable for printer connection (3m) included	●	●	—	—	—
Multimedia unit	GT16M-MMR NEW	For video input (NTSC/PAL) 1ch motion image playback	●	—	—	—	—
Video input unit	GT16M-V4 NEW	For video input (NTSC/PAL) 4ch	●	—	—	—	—
	GT15V-75V4	For video input (NTSC/PAL) 4ch	—	●*5	—	—	—
RGB input unit	GT16M-R2 NEW	For analog RGB input 2ch	●	—	—	—	—
	GT15V-75R1	For analog RGB input 1ch	—	●*5	—	—	—
Video/RGB input unit	GT16M-V4R1 NEW	For video input (NTSC/PAL) 4ch / analog RGB 1ch composite input	●	—	—	—	—
	GT15V-75V4R1	For video input (NTSC/PAL) 4ch / analog RGB 1ch composite input	—	●*5	—	—	—
RGB output unit	GT16M-ROUT NEW	For analog RGB output 1ch	●	—	—	—	—
	GT15V-75ROUT	For analog RGB output	—	●*5	—	—	—
CF card unit	GT15-CFCD	For additional CF card port (B drive) on the back of the GOT	●	●	—	—	—
CF card extension unit	GT15-CFEX-C08SET	For additional CF card port (B drive) at the front of the control panel*6	●	●	—	—	—
Sound output unit	GT15-SOUT	For sound output	●	●	—	—	—
External input/output unit	GT15-DIOR NEW	For external input/output devices and operation panel connection (negative common input / source type output)	●	●	—	—	—
	GT15-DIO	For external input/output devices and operation panel connection (positive common input / sink type output)	●	●	—	—	—

*5 : Only GT1585V and GT1575V are applicable.
 *6 : Includes unit to be installed on the control panel, unit to be installed on the GOT, and connection cable (0.8m).

Software

Product name	Model name	Included products				Remarks
		Screen design software GT Designer2 Ver.2	Simulation software GT Simulator2 Ver.2	Simple data conversion function GT Converter2 Ver.2	SoftGOT function*7 GT SoftGOT1000 Ver.2	
GT Designer2 Version2	SW2D5C-GTD2-E Version upgrade	●	—	●	●	English version
GT Works2 Version2	SW2D5C-GTWK2-E Version upgrade	●	●	●	●	English version
License key for GT SoftGOT1000*7	GT15-SGTKEY-U	●	—	—	—	For USB port
	GT15-SGTKEY-P	●	—	—	—	For parallel port

*7 : To use GT SoftGOT1000, a license key for GT SoftGOT1000 is necessary for each personal computer.

For Designers
 For Operators
 For Initial Startup & Adjustment Operators
 For Maintenance Personnel
 GT10
 Handy GOT
 GT-SoftGOT1000 Version2
 IQ Platform
 MELSEC Process Control + GOT1000
 List of Connectable Models, etc.

Product list

Options

Product name	Model name	Specifications	Applicable model				
			GT16	GT15	GT11	Handy GOT	GT10
Backlight	GT16-90XLTT NEW	For GT1695M-XTB	●	—	—	—	—
	GT16-80SLTT NEW	For GT1685M-STB	●	—	—	—	—
	GT15-90XLTT	For GT1595-XTB	—	●	—	—	—
	GT15-80SLTT	For GT1585V-STB /GT1585-STB	—	●	—	—	—
	GT15-70SLTT	For GT1575-STB ^{*1}	—	●	—	—	—
	GT15-70VLT	For GT1575V-STB /GT1575-VTB /GT1575-STB ^{*2}	—	●	—	—	—
	GT15-70VLTN	For GT1575-VNB /GT1572-VNB	—	●	—	—	—
	GT15-60VLT	For GT1565-VTB	—	●	—	—	—
	GT15-60VLTN	For GT1562-VNB	—	●	—	—	—
	Optional function board	GT16-MESB NEW	For MES interface function	●	—	—	—
GT15-FNB		(No expansion memory)	—	●	—	—	—
GT15-QFNB		(No expansion memory)	—	●	—	—	—
GT15-QFNB16M		+ 16MB expansion memory	—	●	—	—	—
GT15-QFNB32M		+ 32MB expansion memory	—	●	—	—	—
GT15-QFNB48M		+ 48MB expansion memory	—	●	—	—	—
GT15-MESB48M		+ 48MB expansion memory	—	●	—	—	—
GT11-50FNB		Optional function board	—	—	● ^{*3}	●	—
GT10-LDR		For GT1030/GT1020 (for OS project data transfer) no power source required	—	—	—	—	● ^{*7}
GT10 memory board		GT10-50FMB NEW	For GT105 (for OS and project data transfer)	—	—	—	● ^{*8}
Protective sheet	GT16-90PSCB NEW	Clear, 5 sheets	●	—	—	—	—
	GT16-90PSGB NEW	Antiglare, 5 sheets	●	—	—	—	—
	GT16-90PSCW NEW	Clear (frame: white), 5 sheets	●	—	—	—	—
	GT16-90PSGW NEW	Antiglare (frame: white), 5 sheets	●	—	—	—	—
	GT15-90PSCB	Clear, 5 sheets	—	●	—	—	—
	GT15-90PSGB	Antiglare, 5 sheets	—	●	—	—	—
	GT15-90PSCW	Clear (frame: white), 5 sheets	—	●	—	—	—
	GT15-90PSGW	Antiglare (frame: white), 5 sheets	—	●	—	—	—
	GT16-80PSCB NEW	Clear, 5 sheets	●	—	—	—	—
	GT16-80PSGB NEW	Antiglare, 5 sheets	●	—	—	—	—
	GT16-80PSCW NEW	Clear (frame: white), 5 sheets	●	—	—	—	—
	GT16-80PSGW NEW	Antiglare (frame: white), 5 sheets	●	—	—	—	—
	GT15-80PSCB	Clear, 5 sheets	—	●	—	—	—
	GT15-80PSGB	Antiglare, 5 sheets	—	●	—	—	—
	GT15-80PSCW	Clear (frame: white), 5 sheets	—	●	—	—	—
	GT15-80PSGW	Antiglare (frame: white), 5 sheets	—	●	—	—	—
	GT15-70PSCB	Clear, 5 sheets	—	●	—	—	—
	GT15-70PSGB	Antiglare, 5 sheets	—	●	—	—	—
	GT15-70PSCW	Clear (frame: white), 5 sheets	—	●	—	—	—
	GT15-70PSGW	Antiglare (frame: white), 5 sheets	—	●	—	—	—
	GT15-60PSCB	Clear, 5 sheets	—	●	—	—	—
	GT15-60PSGB	Antiglare, 5 sheets	—	●	—	—	—
	GT15-60PSCW	Clear (frame: white), 5 sheets	—	●	—	—	—
	GT15-60PSGW	Antiglare (frame: white), 5 sheets	—	●	—	—	—
	GT15-50PSCB	Clear, 5 sheets	—	●	—	—	—
	GT15-50PSGB	Antiglare, 5 sheets	—	●	—	—	—
	GT15-50PSCW	Clear (frame: white), 5 sheets	—	●	—	—	—
	GT15-50PSGW	Antiglare (frame: white), 5 sheets	—	●	—	—	—
	GT11-50PSCB	Clear, 5 sheets	—	—	●	—	—
	GT11-50PSGB	Antiglare, 5 sheets	—	—	●	—	—
GT11-50PSCW	Clear (frame: white), 5 sheets	—	—	●	—	—	
GT11-50PSGW	Antiglare (frame: white), 5 sheets	—	—	●	—	—	
GT11H-50PSC	Clear, 5 sheets	—	—	—	●	—	
GT10-50PSCB NEW	Clear, 5 sheets	—	—	—	—	●	
GT10-50PSGB NEW	Antiglare, 5 sheets	—	—	—	—	●	
GT10-50PSCW NEW	Clear (frame: white), 5 sheets	—	—	—	—	●	
GT10-50PSGW NEW	Antiglare (frame: white), 5 sheets	—	—	—	—	●	
GT10-30PSCB	Clear, 5 sheets	—	—	—	—	●	
GT10-30PSGB	Antiglare, 5 sheets	—	—	—	—	●	
GT10-30PSCW	Clear (frame: white), 5 sheets	—	—	—	—	●	
GT10-30PSGW	Antiglare (frame: white), 5 sheets	—	—	—	—	●	
GT10-20PSCB	Clear, 5 sheets	—	—	—	—	●	
GT10-20PSGB	Antiglare, 5 sheets	—	—	—	—	●	
GT10-20PSCW	Clear (frame: white), 5 sheets	—	—	—	—	●	
GT10-20PSGW	Antiglare (frame: white), 5 sheets	—	—	—	—	●	
USB protective cover	GT16-UCOV NEW	Protective cover for USB interface on main unit front panel (for replacement)	●	—	—	—	—
	GT15-UCOV	For 15"/12.1"	—	●	—	—	—
	GT11-50UCOV	For 15"/12.1"/10.4"/8.4" / For 5.7"	—	—	●	—	—
Oil resistant cover ^{*5}	GT05-90PCO	Oil resistant cover for 15" screen	●	●	—	—	—
	GT05-80PCO	Oil resistant cover for 12.1" screen	●	●	—	—	—
	GT05-70PCO	Oil resistant cover for 10.4" screen	—	●	—	—	—
	GT05-60PCO	Oil resistant cover for 8.4" screen	—	●	—	—	—
	GT05-50PCO	Oil resistant cover for 5.7" screen	—	●	—	—	● ^{*8}
Emergency stop switch guard	GT11H-50ESCOV	For accidental operation prevention of emergency stop switch	—	—	—	●	—
Stand	GT15-90STAND	Stand for 15" type	●	●	—	—	—
	GT15-80STAND	Stand for 12.1" type	●	●	—	—	—
	GT15-70STAND	Stand for 8.4"/10.4" type	—	●	—	—	—
	GT05-50STAND	Stand for 5.7" type	—	●	—	—	● ^{*8}
CF card	GT05-MEM-32MC	32MB flash ROM	●	●	●	●	—
	GT05-MEM-64MC	64MB flash ROM	●	●	●	●	—
	GT05-MEM-128MC	128MB flash ROM	●	●	●	●	—
	GT05-MEM-256MC	256MB flash ROM	●	●	●	●	—
	GT05-MEM-512MC coming soon	512MB flash ROM	●	●	●	●	—
	GT05-MEM-1GC coming soon	1GB flash ROM	●	●	●	●	—
	GT05-MEM-2GC coming soon	2GB flash ROM	●	●	●	●	—
Memory card adapter	GT05-MEM-ADPC	CF card→memory card (TYPE II) conversion adapter	●	●	●	●	—

Options

Product name	Model name	Specifications	Applicable model				
			GT16	GT15	GT11	Handy GOT	GT10
Attachment	GT15-70ATT-98	A985GOT ^{*6}	—	●	—	—	—
	GT15-70ATT-87	Attachment for 10.4" type	A870GOT-SWS	—	●	—	—
		A870GOT-TWS	A8GT-70GOT-TB	—	—	—	—
	GT15-60ATT-97	Attachment for 8.4" type	A8GT-70GOT-TW	A8GT-70GOT-SW	—	—	—
			A8GT-70GOT-TW	A8GT-70GOT-SB	—	—	—
			A97 GOT	A960GOT	—	—	—
	GT15-60ATT-87	Attachment for 8.4" type	A870GOT-EWS	A77GOT-EL-S5	—	—	—
A870GOT-TWS			A77GOT-EL-S3	—	—	—	
GT15-60ATT-77	Attachment for 8.4" type	A8GT-70GOT-EB	A77GOT-EL	—	—	—	
		A77GOT-CL-S5	A77GOT-L-S5	—	—	—	
GT15-50ATT-95W	Attachment for 5.7" type	A77GOT-CL-S3	A77GOT-L-S3	—	—	—	
		A77GOT-CL	A77GOT-L	—	—	—	
Battery	GT15-BAT	Battery for backup of clock data and maintenance time notification data	●	●	—	—	—
	GT11-50BAT	Battery for backup of clock data, alarm history, and recipe data (for replacement)	—	—	—	—	● ^{*8}

- *1: Function version B or earlier
- *2: Function version C or later
- *3: Excluding GT115-Q-BDO and GT115-Q-BDA
- *4: For GT105/GT1030 only
- *5: Check if the oil resistant cover can be used in the actual environment before use. When using the oil resistant cover, the front USB interface and human sensor cannot be used.
- *6: Including the GP250 and GP260 manufactured by Pro-face.
- *7: For GT1030/GT1020 only
- *8: For GT105 only

Manuals

Manual title	Contents	Catalog No.
GT Designer2 Version2 Basic Operation/Data Transfer Manual <for GOT1000 Series>	Basic software installation, basic screen design techniques, and data transfer to a terminal	SH-080529ENG
GT Designer2 Version2 Screen Design Manual <for GOT1000 Series>	Programming manual, including instruction for objects, specifications	SH-080530ENG
GOT1000 Series Connection Manual	System configurations and procedure to create customized cables	SH-080532ENG
GOT1000 Series Extended Function/Optional Function Manual	Information on extended functions and optional functions available to the GOT	SH-080544ENG
GOT1000 Series Gateway Function Manual	Specifications, system configurations, and setting procedures for the Gateway function	SH-080545ENG
GOT1000 Series MES Interface Function Manual	Specifications, system configurations, and setting procedures for the MES interface function	SH-080654ENG
GT16 User's Manual	GT16 general specification overview, parts and settings, external dimensions, mounting, wiring, optional interfaces	SH-080778ENG
GT15 User's Manual	GT15 general specification overview, parts and settings, external dimensions, mounting, wiring, optional interfaces	SH-080528ENG
GT11 User's Manual	GT11 general specification overview, parts and settings, external dimensions, mounting, wiring, optional interfaces	JY997D17501
Handy GOT User's Manual	Handy GOT general specification overview, parts and settings, external dimensions, wiring, optional interfaces, in addition to explanations of utility, system configurations, and cable fabrication	JY997D20101
GT10 User's Manual	GT10 general specification overview, parts and settings, external dimensions, mounting, wiring, optional interfaces	JY997D24701
GT SoftGOT1000 Version2 Operation Manual	GT SoftGOT1000 screen configuration, functions, and operating procedures	SH-080602ENG
GT Simulator2 Version2 Operation Manual	GT Simulator2 specifications and operating instructions	SH-080546ENG
GT Converter2 Version2 Operation Manual	GT Converter2 operating instructions	SH-080533ENG

For Designers

For Operators

For Initial Startup & Adjustment Operators

For Maintenance Personnel

GT10

Handy GOT

GT SoftGOT1000 Version2

IQ Platform

MES/SC Process Control + GOT1000

List of Connectable Models, etc.

List of Connectable Models, etc.

List of Connectable Models, etc.

List of Connectable Models, etc.

Product list

Cables

Product name	Model name	Cable length	Third party products *1	Application	Applicable model *2								
					GT16	GT15	GT11	Handy GOT	GT10				
Bus connection cable for QCPU (Q mode)	QCPU extension cable GOT-to-GOT connection cable	GT15-QC06B	0.6m	○	For connection between QCPU and GOT For connection between GOT and GOT	●	●	●	—	—			
		GT15-QC12B	1.2m			●	●	●	—	—			
		GT15-QC30B	3m			●	●	●	—	—			
		GT15-QC50B	5m			●	●	●	—	—			
		GT15-QC100B	10m			●	●	●	—	—			
	Long-distance connection cable for QCPU GOT-to-GOT long-distance connection cable	GT15-QC150BS	15m	○	For long-distance (13.2m or more) connection between QCPU and GOT (A9GT-QCNB required) For long-distance connection between GOT and GOT	●	●	●	—	—			
		GT15-QC200BS	20m			●	●	●	—	—			
		GT15-QC250BS	25m			●	●	●	—	—			
		GT15-QC300BS	30m			●	●	●	—	—			
		GT15-QC350BS	35m			●	●	●	—	—			
Bus extension connector box	A9GT-QCNB	—	—	Used for QCPU long-distance (13.2m or more) bus connection	●	●	●	—	—				
Bus connection cable for QnA/ACPU/motion controller CPU (A series)	Large CPU extension cable	GT15-C12NB	1.2m	○	For connection between QnA/ACPU/motion controller CPU (A series, extension base) and GOT	●	●	●	—	—			
		GT15-C30NB	3m			●	●	●	—	—			
		GT15-C50NB	5m			●	●	●	—	—			
		GT15-AC06B	0.6m	○	For connection between QnA/ACPU/motion controller CPU (A series, extension base) and A7GT-CNB	●	●	●	—	—			
		GT15-AC12B	1.2m			●	●	●	—	—			
		GT15-AC30B	3m			●	●	●	—	—			
		GT15-AC50B	5m			●	●	●	—	—			
		GT15-A370C12B-S1	1.2m			●	●	●	—	—			
		GT15-A370C25B-S1	2.5m			●	●	●	—	—			
		GT15-A370C12B	1.2m			●	●	●	—	—			
	GT15-A370C25B	2.5m	●	●	●	—	—						
	Small CPU extension cable	GT15-A1SC07B	0.7m	○	For connection between QnAS/AnSCPU/motion controller CPU (A series) and GOT	●	●	●	—	—			
		GT15-A1SC12B	1.2m			●	●	●	—	—			
		GT15-A1SC30B	3m			●	●	●	—	—			
		GT15-A1SC50B	5m			●	●	●	—	—			
	Small CPU extension cable	GT15-A1SC05NB	0.45m	○	For connection between QnAS/AnSCPU/motion controller CPU (A series) and A7GT-CNB	●	●	●	—	—			
		GT15-A1SC07NB	0.7m			●	●	●	—	—			
		GT15-A1SC30NB	3m			●	●	●	—	—			
	Small CPU long-distance connection cable	GT15-A1SC50NB	5m	○	For connection between QnAS/AnSCPU and A7GT-CNB	●	●	●	—	—			
		GT15-C100EXSS-1	10.6m			●	●	●	—	—			
Small CPU long-distance connection cable	GT15-C200EXSS-1	20.6m	○	For long-distance connection between QnAS/AnSCPU/motion controller CPU (A series) and GOT For long-distance connection between A7GT-CNB and GOT *Set of GT15-EXCNB and GT15-C100BS	●	●	●	—	—				
	GT15-C300EXSS-1	30.6m			●	●	●	—	—				
GOT-to-GOT connection cable	GT15-C07BS	0.7m	○	For connection between GOT and GOT	●	●	●	—	—				
	GT15-C12BS	1.2m			●	●	●	—	—				
	GT15-C30BS	3m			●	●	●	—	—				
	GT15-C50BS	5m			●	●	●	—	—				
	GT15-C100BS	10m			●	●	●	—	—				
GOT-to-GOT long-distance connection cable	GT15-C200BS	20m	○	For connection between GOT and GOT	●	●	●	—	—				
	GT15-C300BS	30m			●	●	●	—	—				
	GT15-C300BS	30m			●	●	●	—	—				
AQJ2HCPU connection cable	GT15-J2C10B	1m	—	For connection between power supply unit (AQJ2-PW) for AQJ2HCPU and GOT	●	●	●	—	—				
Bus connector conversion box	A7GT-CNB	—	—	Used for QnA/ACPU long-distance bus connection	●	●	●	—	—				
Buffer circuit cable	GT15-EXCNB	0.5m	○	Usable as GT15-C100EXSS-1 in combination with GT15-C100BS	●	●	●	—	—				
Ferrite core set for Q bus cable (two-pack)	GT15-QFC	—	○	Ferrite cores for replacing existing GOT-A900 bus cable with bus cable for GOT1000	●	●	●	—	—				
Ferrite core set for A bus cable (two-pack)	GT15-AFC	—	○	Ferrite cores for replacing existing GOT-A900 bus cable with bus cable for GOT1000	●	●	●	—	—				
RS-422 conversion cable	NEW GT16-C02R4-9S	0.2m	○	For connection between RS-422/485 (connector) and RS-422 cable (D-sub 9 pins)	●	—	—	—	—				
RS-485 terminal block conversion unit	NEW FA-LTBGTR4CBL05	0.5m	○	For connection between RS-422/485 (connector) and terminal block conversion cable	●	—	—	—	—				
	FA-LTBGTR4CBL10	1m			●	—	—	—	—				
	FA-LTBGTR4CBL20	2m			●	—	—	—	—				
RS-232 cable	QnA/ACPU direct connection cable Computer link connection cable	GT01-C30R4-25P	3m	—	For connection between QnA/ACPU/motion controller CPU (A series)/FXCPU (D-sub 25-pin connector) and GOT For connection between FA-CNV1_CBL and GOT For connection between serial communication unit and GOT For connection between AJ65BT-G4-S3 and GOT	●	●	●	—	●*4			
		GT01-C100R4-25P	10m			●	●	●	—	●*4			
		GT01-C200R4-25P	20m			●	●	●	—	●*4			
		GT01-C300R4-25P	30m			●	●	●	—	●*4			
		GT10-C30R4-25P	3m			—	—	—	—	—	●*5		
		GT10-C100R4-25P	10m			—	—	—	—	—	●*5		
		GT10-C200R4-25P	20m			—	—	—	—	—	●*5		
		GT10-C300R4-25P	30m			—	—	—	—	—	●*5		
		GT09-C30R4-6C	3m			—	—	—	—	—	●*4		
		GT09-C100R4-6C	10m			—	—	—	—	—	●*4		
	Computer link connection cable	GT09-C200R4-6C	20m	○	For connection between serial communication unit and GOT For connection between computer link unit and GOT	●	●	●	—	●*4			
		GT09-C300R4-6C	30m			●	●	●	—	●*4			
		GT01-C10R4-8P	1m			—	For connection between FXCPU (MINI-DIN 8-pin connector) and GOT For connection between FXCPU communication function extension board and GOT	●	●	●	—	●*4	
		GT01-C30R4-8P	3m					●	●	●	—	●*4	
		GT01-C100R4-8P	10m					●	●	●	—	●*4	
		GT01-C200R4-8P	20m					●	●	●	—	●*4	
		GT01-C300R4-8P	30m					●	●	●	—	●*4	
		GT10-C10R4-8P	1m					—	—	—	—	—	●*5
		GT10-C30R4-8P	3m					—	—	—	—	—	●*5
		GT10-C100R4-8P	10m					—	—	—	—	—	●*5
GT10-C200R4-8P	20m	—	—	—	—			—	●*5				
GT10-C300R4-8P	30m	—	—	—	—			—	●*5				
QCPU direct connection cable Data transfer cable	GT01-C30R2-6P	3m	—	For connection between QCPU (MINI-DIN 8-pin connector) and GOT For connection between FXCPU communication function extension board and GOT *The unit cannot be used with the FX1NC, FX2NC, FX3UC-D/SS, FX3G.	●	●	●	—	●*4				
	GT10-C30R2-6P	3m	—	For connection between QCPU and GOT/personal computer (GT SoftGOT1000) (D-sub 9-pin)	—	—	—	—	●*5				
	GT11H-C30R2-6P	3m	—	For connection between personal computer (screen design software) (D-sub 9-pin, female) and GOT (MINI-DIN 6-pin, male)	—	—	—	—	●*5				
	GT11H-C30R2-6P	3m	—	For connector conversion box between QCPU and Handy GOT	—	—	—	—	●*5				
FX communication function extension board connection cable, FX communication function adapter connection cable, Data transfer cable	GT01-C30R2-9S	3m	—	For connection between QCPU and GOT and between GOTs.	—	—	—	—	●				
	GT01-C30R2-9S	3m	—	For connection between FXCPU communication function extension board (D-sub 9-pin connector) and GOT/personal computer (GT SoftGOT1000) (D-sub 9-pin) For connection between FXCPU communication function adapter (D-sub 9-pin connector) and GOT For connection between personal computer (screen design software) (D-sub 9-pin, female) and GOT (D-sub 9-pin, female)	●	●	●	—	●*4				

Cables

Product name	Model name	Cable length	Third party products *1	Application	Applicable model *2					
					GT16	GT15	GT11	Handy GOT	GT10	
RS-232 cable	FX communication function adapter connection cable	GT01-C30R2-25P	3m	—	For connection between FXCPU communication special adapter (D-sub 25-pin connector) and GOT, personal computer (GT SoftGOT1000) (D-sub 9-pin)	●	●	●	—	●*4
	Computer link connection cable	GT09-C30R2-9P	3m	○	For connection between serial communication unit and GOT For connection between computer link unit and GOT For connection between AJ65BT-R2N and GOT (GT09-C30R2-9P only)	●	●	●	—	●*4
Connector conversion box for Handy GOT	GT11H-CNB-37S	—	—	Converts D-sub 37-pin connector to terminal block and D-sub 9-pin connector	—	—	—	●	—	—
External connection cable	FA device, power supply and operation switch connection cable	GT11H-C30-37P	3m	—	For connection between FA device connection relay cable and GOT	—	—	—	●	—
		GT11H-C60-37P	6m			—	—	—	●	—
		GT11H-C100-37P	10m			—	—	—	●	—
		GT11H-C30	3m			—	—	—	●	—
		GT11H-C60	6m			—	—	—	●	—
FA device connection relay cable	RS-422, power supply and operation switch connection cable	GT11H-C15R4-8P	1.5m	—	For connection between FXCPU and GOT For connection between power supply and operation switches and GOT	—	—	—	●	—
		GT11H-C15R4-25P	1.5m			—	—	—	●	—
RS-232, power supply and operation switch connection cable	RS-232, power supply and operation switch connection cable	GT11H-C15R2-6P	1.5m	—	For connection between QCPU and GOT For connection between power supply and operation switches and GOT	—	—	—	●	—
		GT11H-C15R2-6P	1.5m			—	—	—	●	—
Barcode reader connection cable	GT10-C20H-6PT9P	0.3m	—	For connection between barcode reader (D-sub 9-pin, female) and GOT (MINI-DIN 6-pin, female) RS-232	—	—	—	—	●*5	
External I/O unit connection conversion cable	GT15-C03HTB	0.3m	○	For connection between GOT1000 (external I/O unit) and GOT-A900 external I/O interface unit connection cable (A8GT-C05TK/A8GT-C30TB/user-fabricated cable)	●	●	—	—	—	
Analog RGB cable	NEW GT15-C50VG	5m	○	For connection between external monitor, personal computer and vision sensor and GOT	●	●	—	—	—	
USB cable	RS-232/USB conversion adapter for data transfer	GT10-RS2TUSB-5S	—	—	For connection between personal computer (USB) and GOT (RS-232) (Adapter and personal computer are connected with GT09-C30USB-5P.)	—	—	—	—	●*5
	Data transfer cable	GT09-C30USB-5P	3m	○	For connection between personal computer (USB) and GOT (USB mini-B) For connection between QnCPU (USB mini-B) and personal computer (GT SoftGOT1000) For connection between printer and GOT (printer unit)	●	●	●	●	●*4

*1 : FA-LTBGTR4CBL□□ is developed by Mitsubishi Electric Engineering Company Limited and sold through your local sales office.
The other products listed are developed by Mitsubishi Electric System & Service Co., LTD. and sold through your local sales office.
*2 : The applicable connection configuration and cable vary depending on the GOT main unit. For more details, see the GOT1000 Series Handbook and the GOT1000 Series Connection Manual.
*3 : Can be used when used together with the Handy GOT connector conversion box.
*4 : Can be used only for GT105□.
*5 : Can be used only for GT1030 and GT1020.

Cables for third party FA devices

Product name	Model name	Cable length	Third party products *1	GOT connection destination	Applicable model *2					
					GT16	GT15	GT11	Handy GOT	GT10	
RS-232 cable	Cable for OMRON PLC	GT09-C30R20101-9P	3m	PLC CPU: CQM1/CQM1H/CS1/CJ1/CV500/CV1000/CV2000/CVM1 Serial communication unit: CS1W-SCU21/CJ1W-SCU41 Communication board: C200HW-COM02/COM05/COM06 Serial communication board: CQM1-SCB41/CS1W-SCB21 Connection cable: CQM1-CIF01 Base mount type host link unit: C500-LK201-V1	●	●	●	—	—	●*4
		GT09-C30R20102-25S	3m		●	●	●	—	—	●*4
	Cable for KEYENCE PLC	GT09-C30R21101-6P	3m	PLC CPU: KV-700/1000 Multi-communication unit: KV-L20/L20R port 1 Multi-communication unit: KV-L20/L20R port 2	●	●	●	—	—	—
		GT09-C30R21102-9S	3m		●	●	●	—	—	—
	Cable for SHARP PLC	GT09-C30R20601-15P	3m	PLC CPU: JW-22CU/73CUH/100CUH/100CU PLC CPU: JW-32CUH/33CUH	●	●	●	—	—	—
		GT09-C30R20602-15P	3m		●	●	●	—	—	—
	Cables for JTEKT PLC	GT09-C30R21201-25P	3m	RS-232/RS-422 converter: TXU-2051	●	●	●	—	—	—
		GT09-C30R21401-4T	3m		●	●	●	—	—	—
	Cable for Shinko Technos digital indicating controller	GT09-C30R20501-9P	3m	Digital indicating controller: FCR-100/FCD-100/FCR-23A/PC-900/FIR series	●	●	●	—	—	—
		GT09-C30R20502-15P	3m		●	●	●	—	—	—
	Cable for TOSHIBA PLC	GT09-C30R20401-15P	3m	PLC CPU: T2E PLC CPU: T2N PLC CPU: H-4010/H series board type/EH-150 series Intelligent serial port module: COMM-H/COMM-2H PLC CPU: H-4010/EH-150 series	●	●	●	—	—	—
		GT09-C30R20402-15P	3m		●	●	●	—	—	—
	Cable for Hitachi Industrial Equipment Systems PLC	GT09-C30R21301-9S	3m	Communication module: LQE560/LQE060/LQE160	●	●	●	—	—	—
		GT09-C30R21003-25P	3m		●	●	●	—	—	—
	Cable for Fuji Electric FA Components & Systems PLC	GT09-C30R20901-25P	3m	RS-232C interface card: NV1L-RS2 RS-232C/485 interface capsule: FFK120A-C10 General interface module: NC1L-RS2/FFU120B RS-422→232 conversion adapter: AFP8550 PLC CPU: FP2/FP2SH/FP10(S)/FP10SH/FP-M Computer communication unit: AFP2462/AFP3462/AFP5462 PLC CPU: FP1-C24C/C40C PLC CPU: FP1-C16CT/C32CT PLC CPU: PROGIC-8/MP-920/MP-930 PLC CPU: PROGIC-8 PLC CPU: CP-930MS MEMOBUS module: CP-217IF (when connected to CN1) PLC CPU: MP940 MEMOBUS module: CP-217IF (when connected to CN2) Yokogawa Electric personal computer module: LC01-ON/LC02-0N CPU port/D-sub 9-pin conversion cable: KM10-0C Personal computer module: F3LC11-1N/F3LC11-1F/F3LC12-1F/F3LC11-2N PLC CPU: NFPC1000/NFJT100	●	●	●	—	—	—
		GT09-C30R20902-9P	3m		●	●	●	—	—	—
	Cable for Matsushita Electric Works PLC	GT09-C30R20903-9P	3m	PLC CPU: FP2/FP2SH/FP10(S)/FP10SH/FP-M Computer communication unit: AFP2462/AFP3462/AFP5462 PLC CPU: FP1-C24C/C40C PLC CPU: FP1-C16CT/C32CT PLC CPU: PROGIC-8/MP-920/MP-930 PLC CPU: PROGIC-8 PLC CPU: CP-930MS MEMOBUS module: CP-217IF (when connected to CN1) PLC CPU: MP940 MEMOBUS module: CP-217IF (when connected to CN2) Yokogawa Electric personal computer module: LC01-ON/LC02-0N CPU port/D-sub 9-pin conversion cable: KM10-0C Personal computer module: F3LC11-1N/F3LC11-1F/F3LC12-1F/F3LC11-2N PLC CPU: NFPC1000/NFJT100	●	●	●	—	—	—
		GT09-C30R20904-3C	3m		●	●	●	—	—	—
	Cable for YASKAWA Electric PLC	GT09-C3								

Cables for third party FA devices

Product name	Model name	Cable length	Third party products *1	GOT connection destination	Applicable model *2				
					GT16	GT15	GT11	Handy GOT	GT10
Cable for OMRON PLC	GT09-C30R40101-9P	3m	●	PLC CPU: CV500/CV1000/CV2000/CVM1 Serial communication unit: CJ1W-SCU41 Serial communication board: CQM1-SCB41/CS1W-SCB41					
	GT09-C100R40101-9P	10m							
	GT09-C200R40101-9P	20m							
	GT09-C300R40101-9P	30m							
	GT09-C30R40102-9P	3m							
	GT09-C100R40102-9P	10m							
	GT09-C200R40102-9P	20m							
	GT09-C300R40102-9P	30m							
	GT09-C30R40103-5T	3m							
	GT09-C100R40103-5T	10m							
Cable for KEYENCE PLC	GT09-C200R40103-5T	20m	●	Base mount type host link unit: C200H-LK202-V1/C500H-LK201-V1 Communication board: C200HW-COM03/COM06					
	GT09-C30R41101-5T	3m							
	GT09-C100R41101-5T	10m							
	GT09-C200R41101-5T	20m							
	GT09-C300R41101-5T	30m							
	GT09-C30R40601-15P	3m							
	GT09-C100R40601-15P	10m							
	GT09-C200R40601-15P	20m							
	GT09-C300R40601-15P	30m							
	GT09-C30R40602-15P	3m							
Cable for SHARP PLC	GT09-C100R40602-15P	10m	●	PLC CPU: JW-22CU/70CUH/100CUH/100CU					
	GT09-C200R40602-15P	20m							
	GT09-C300R40602-15P	30m							
	GT09-C30R40603-6T	3m							
	GT09-C100R40603-6T	10m							
	GT09-C200R40603-6T	20m							
	GT09-C300R40603-6T	30m							
	GT09-C30R41201-6C	3m							
	GT09-C100R41201-6C	10m							
	GT09-C200R41201-6C	20m							
Cable for JTEKT PLC	GT09-C300R41201-6C	30m	●	PLC CPU: JW-32CUH/33CUH					
	GT09-C30R40501-15P	3m							
	GT09-C100R40501-15P	10m							
	GT09-C200R40501-15P	20m							
	GT09-C300R40501-15P	30m							
	GT09-C30R40502-6C	3m							
	GT09-C100R40502-6C	10m							
	GT09-C200R40502-6C	20m							
	GT09-C300R40502-6C	30m							
	GT09-C30R40503-15P	3m							
Cable for TOSHIBA PLC	GT09-C100R40503-15P	10m	●	Link unit: JW-21CM/10CM/ZW-10CM					
	GT09-C200R40503-15P	20m							
	GT09-C300R40503-15P	30m							
	GT09-C30R40401-7T	3m							
	GT09-C100R40401-7T	10m							
	GT09-C200R40401-7T	20m							
	GT09-C300R40401-7T	30m							
	GT09-C30R41301-9S	3m							
	GT09-C100R41301-9S	10m							
	GT09-C200R41301-9S	20m							
Cable for Hitachi Industrial Equipment Systems PLC	GT09-C300R41301-9S	30m	●	PLC CPU: PC3J/PC3JL Communication module: PC/CMP2-LINK					
	GT09-C30R41001-6T	3m							
	GT09-C100R41001-6T	10m							
	GT09-C200R41001-6T	20m							
	GT09-C300R41001-6T	30m							
	GT09-C30R40201-9P	3m							
	GT09-C100R40201-9P	10m							
	GT09-C200R40201-9P	20m							
	GT09-C300R40201-9P	30m							
	GT09-C30R40202-14P	3m							
Cable for Hitachi PLC	GT09-C100R40202-14P	10m	●	PLC CPU: T2/T3/T3H/model3000(S3)					
	GT09-C200R40202-14P	20m							
	GT09-C300R40202-14P	30m							
	GT09-C30R40301-6T	3m							
	GT09-C100R40301-6T	10m							
	GT09-C200R40301-6T	20m							
	GT09-C300R40301-6T	30m							
	GT09-C30R40302-6T	3m							
	GT09-C100R40302-6T	10m							
	GT09-C200R40302-6T	20m							
Cable for Fuji Electric FA Components & Systems PLC	GT09-C300R40302-6T	30m	●	PLC CPU: T2N					
	GT09-C30R40303-6T	3m							
	GT09-C100R40303-6T	10m							
	GT09-C200R40303-6T	20m							
	GT09-C300R40303-6T	30m							
	GT09-C30R40304-6T	3m							
	GT09-C100R40304-6T	10m							
	GT09-C200R40304-6T	20m							
	GT09-C300R40304-6T	30m							
	GT09-C30R40304-6T	3m							
Cable for Yaskawa Electric PLC	GT09-C100R40304-6T	10m	●	Intelligent serial port module: COMM-H/COMM-2H					
	GT09-C200R40301-6T	20m							
	GT09-C300R40301-6T	30m							
	GT09-C30R40302-6T	3m							
	GT09-C100R40302-6T	10m							
	GT09-C200R40302-6T	20m							
	GT09-C300R40302-6T	30m							
	GT09-C30R40303-6T	3m							
	GT09-C100R40303-6T	10m							
	GT09-C200R40303-6T	20m							
Cable for Yokogawa Electric	GT09-C300R40303-6T	30m	●	PLC CPU: LQP510 Communication module: LQE565/LQE165					
	GT09-C30R41001-6T	3m							
	GT09-C100R41001-6T	10m							
	GT09-C200R41001-6T	20m							
	GT09-C300R41001-6T	30m							
	GT09-C30R40201-9P	3m							
	GT09-C100R40201-9P	10m							
	GT09-C200R40201-9P	20m							
	GT09-C300R40201-9P	30m							
	GT09-C30R40202-14P	3m							
Cable for PLC	GT09-C100R40202-14P	10m	●	RS-232C/485 interface capsule: FFK120A-C10 General interface module: NC1L-RS4/FFU120B					
	GT09-C200R40202-14P	20m							
	GT09-C300R40202-14P	30m							
	GT09-C30R40301-6T	3m							
	GT09-C100R40301-6T	10m							
	GT09-C200R40301-6T	20m							
	GT09-C300R40301-6T	30m							
	GT09-C30R40302-6T	3m							
	GT09-C100R40302-6T	10m							
	GT09-C200R40302-6T	20m							
Cable for Temperature controller	GT09-C300R40302-6T	30m	●	MEMOBUS module: JAMSC-120NOM27100/JAMSC-IF612					
	GT09-C30R40303-6T	3m							
	GT09-C100R40303-6T	10m							
	GT09-C200R40303-6T	20m							
	GT09-C300R40303-6T	30m							
	GT09-C30R40304-6T	3m							
	GT09-C100R40304-6T	10m							
	GT09-C200R40304-6T	20m							
	GT09-C300R40304-6T	30m							
	GT09-C30R40304-6T	3m							
Cable for PLC	GT09-C100R40304-6T	10m	●	PLC CPU: MP940					
	GT09-C200R40301-6T	20m							
	GT09-C300R40301-6T	30m							
	GT09-C30R40302-6T	3m							
	GT09-C100R40302-6T	10m							
	GT09-C200R40302-6T	20m							
	GT09-C300R40302-6T	30m							
	GT09-C30R40303-6T	3m							
	GT09-C100R40303-6T	10m							
	GT09-C200R40303-6T	20m							
Cable for Temperature controller	GT09-C300R40303-6T	30m	●	Personal computer link module: F3LC11-2N					
	GT09-C30R40304-6T	3m							
	GT09-C100R40304-6T	10m							
	GT09-C200R40304-6T	20m							
	GT09-C300R40304-6T	30m							
	GT09-C30R40304-6T	3m							
	GT09-C100R40304-6T	10m							
	GT09-C200R40304-6T	20m							
	GT09-C300R40304-6T	30m							
	GT09-C30R40304-6T	3m							
Cable for PLC	GT09-C100R40304-6T	10m	●	Personal computer link module: LC02-0N					
	GT09-C200R40302-6T	20m							
	GT09-C300R40302-6T	30m							
	GT09-C30R40303-6T	3m							
	GT09-C100R40303-6T	10m							
	GT09-C200R40303-6T	20m							
	GT09-C300R40303-6T	30m							
	GT09-C30R40304-6T	3m							
	GT09-C100R40304-6T	10m							
	GT09-C200R40304-6T	20m							
Cable for Temperature controller	GT09-C300R40304-6T	30m	●	Temperature controller: GREEN series					
	GT09-C30R40304-6T	3m							
	GT09-C100R40304-6T	10m							
	GT09-C200R40304-6T	20m							
	GT09-C300R40304-6T	30m							
	GT09-C30R40304-6T	3m							
	GT09-C100R40304-6T	10m							
	GT09-C200R40304-6T	20m							
	GT09-C300R40304-6T	30m							
	GT09-C30R40304-6T	3m							
Cable for PLC	GT09-C100R40304-6T	10m	●	Temperature controller: UT2000 series					
	GT09-C200R40304-6T	20m							
	GT09-C300R40304-6T	30m							
	GT09-C30R40304-6T	3m							
	GT09-C100R40304-6T	10m							
	GT09-C200R40304-6T	20m							
	GT09-C300R40304-6T	30m							
	GT09-C30R40304-6T	3m							
	GT09-C100R40304-6T	10m							
	GT09-C200R40304-6T	20m							

*1: Items listed above are developed by Mitsubishi Electric System & Service Co., LTD., and sold through your local sales office.
 *2: The applicable connection configuration and cable vary depending on the GOT main unit. For more details, see the GOT1000 Series Handbook and the GOT1000 Series Connection Manual.
 *3: The RS-422 cables less than 10m and the RS-232 cable less than 3m can be used when the connector conversion box for the Handy GOT is used.
 *4: Can be used only for GT105□.

Please confirm the following product warranty details before using this product.

Gratis Warranty Term and Gratis Warranty Range

If any faults or defects (hereinafter "Failure") found to be the responsibility of Mitsubishi occurs during use of the product within the gratis warranty term, the product shall be repaired at no cost via the sales representative or Mitsubishi Service Company. However, if repairs are required onsite at domestic or overseas location, expenses to send an engineer will be solely at the customer's discretion. Mitsubishi shall not be held responsible for any re-commissioning, maintenance, or testing on-site that involves replacement of the failed module.

Gratis Warranty Term

The gratis warranty term of the product shall be for thirty-six (36) months after the date of purchase or delivery to a designated place.

Note that after manufacture and shipment from Mitsubishi, the maximum distribution period shall be six (6) months, and the longest gratis warranty term after manufacturing shall be forty-two (42) months. The gratis warranty term of repair parts shall not exceed the gratis warranty term before repairs.

Gratis Warranty Range

- The customer shall be responsible for the primary failure diagnosis unless otherwise specified. If requested by the customer, Mitsubishi Electric Corporation or its representative firm may carry out the primary failure diagnosis at the customer's expense. The primary failure diagnosis will, however, be free of charge should the cause of failure be attributable to Mitsubishi Electric Corporation.
- The range shall be limited to normal use within the usage state, usage methods, usage environment, etc. which follow the conditions, precautions, etc. given in the instruction manual, user's manual, caution labels on the product, etc.
- Even within the gratis warranty term, repairs shall be charged for in the following cases.
 - Failure occurring from inappropriate storage or handling, carelessness or negligence by the user. Failure caused by the user's hardware or software design.
 - Failure caused by unapproved modifications, etc., to the product by the user.
 - When the Mitsubishi product is assembled into a user's device, Failure that could have been avoided if functions or structures, judged as necessary in the legal safety measures the user's device is subject to or as necessary by industry standards, had been provided.
 - Failure that could have been avoided if consumable parts designated in the user's manual etc. had been correctly serviced or replaced.
 - Replacing consumable parts such as the battery, backlight and fuses.
 - Failure caused by external irresistible forces such as fires or abnormal voltages, and Failure caused by force majeure such as earthquakes, lightning, wind and water damage.
 - Failure caused by reasons unpredictable by scientific technology standards at time of shipment from Mitsubishi.
 - Any other failure found not to be the responsibility of Mitsubishi or that admitted not to be so by the user.

Onerous repair term after discontinuation of production

- Mitsubishi shall accept onerous product repairs for seven (7) years after production of the product is discontinued. Discontinuation of production shall be notified with Mitsubishi Technical Bulletins, etc.
- Product supply (including repair parts) is not available after production is discontinued.

Overseas service

Overseas, repairs shall be accepted by Mitsubishi's local overseas FA Center. Note that the repair conditions at each FA Center may differ.

Exclusion of loss in opportunity and secondary loss from warranty liability

Regardless of the gratis warranty term, Mitsubishi shall not be liable for compensation to damages caused by any cause found not to be the responsibility of Mitsubishi, loss in opportunity, lost profits incurred to the user by Failures of Mitsubishi products, special damages and secondary damages whether foreseeable or not, compensation for accidents, and compensation for damages to products other than Mitsubishi products, replacement by the user, maintenance of on-site equipment, start-up test run and other tasks.

Changes in product specifications

The specifications given in the catalogs, manuals or technical documents are subject to change without prior notice.

Product application

- In using the Mitsubishi graphic operation terminal, the usage conditions shall be that the application will not lead to a major accident even if any problem or fault should occur in the graphic operation terminal device, and that backup and fail-safe functions are systematically provided outside of the device for any problem or fault.
- The Mitsubishi graphic operation terminal has been designed and manufactured for applications in general industries, etc. Thus, applications in which the public could be affected such as in nuclear power plants and other power plants operated by respective power companies, and applications in which a special quality assurance system is required, such as for Railway companies or Public service purposes shall be excluded from the graphic operation terminal applications. In addition, applications in which human life or property that could be greatly affected, such as in aircraft, medical applications, incineration and fuel devices, manned transportation equipment for recreation and amusement, and safety devices, shall also be excluded from the graphic operation terminal range of applications. However, in certain cases, some applications may be possible, providing the user consults the local Mitsubishi representative outlining the special requirements of the project, and providing that all parties concerned agree to the special circumstances, solely at our discretion. In some of these cases, however, Mitsubishi Electric Corporation may consider the possibility of an application, provided that the customer notifies Mitsubishi Electric Corporation of the intention, the application is clearly defined and any special quality is not required.

For Designers
 For Operators
 For Initial Startup & Adjustment Operators
 For Maintenance Personnel
 GT10
 Handy GOT
 GT-SoftGOT1000 Version2
 IQ Platform
 MELSEC Process Control + GOT1000
 List of Connectable Models, etc.

Mitsubishi Graphic Operation Terminal

Precautions for Choosing the Products

This catalog explains the typical features and functions of the GOT1000 series HMI and does not provide restrictions and other information on usage and module combinations.

When using the products, always read the user's manuals of the products.

Mitsubishi will not be held liable for damage caused by factors found not to be the cause of Mitsubishi; machine damage or lost profits caused by faults in the Mitsubishi products; damage, secondary damage, accident compensation caused by special factors unpredictable by Mitsubishi; damages to products other than Mitsubishi products; and to other duties.

For safe use

- To use the products given in this catalog properly, always read the related manuals before starting to use them.
- The products within this catalog have been manufactured as general-purpose parts for general industries and have not been designed or manufactured to be incorporated into any devices or systems used in purpose related to human life.
- Before using any product for special purposes such as nuclear power, electric power, aerospace, medicine or passenger movement vehicles, consult with Mitsubishi.
- The products within this catalog have been manufactured under strict quality control. However, when installing the product where major accidents or losses could occur if the product fails, install appropriate backup or failsafe functions in the system.

Country/Region	Sales office	Tel/Fax
USA	Mitsubishi Electric Automation Inc. 500 Corporate Woods Parkway, Vernon Hills, IL 60061, USA	Tel: +1-847-478-2100 Fax: +1-847-478-0327
Brazil	MELCO-TEC Rep. Com.e Assessoria Tecnica Ltda. Av. Paulista, 1439-CJ. 72 Cerqueira Cesar CEP 01311-200, Sao Paulo, SP, CEP: 01311-200, Brazil	Tel: +55-11-3146-2200 Fax: +55-11-3146-2217
Germany	Mitsubishi Electric Europe B.V. German Branch Gothaer Strasse 8, D-40880 Ratingen, Germany	Tel: +49-2102-486-0 Fax: +49-2102-486-1120
UK	Mitsubishi Electric Europe B.V. UK Branch Travellers Lane, Hatfield, Hertfordshire, AL10 8XB, UK.	Tel: +44-1707-276100 Fax: +44-1707-278992
Italy	Mitsubishi Electric Europe B.V. Italy Branch Viale Colleoni 7-20041 Agrate Brianza (Milano), Italy	Tel: +39-039-60531 Fax: +39-039-6053312
Spain	Mitsubishi Electric Europe B.V. Spanish Branch Ctra. de Rubí 76-80-AC.420, E-08190 Sant Cugat del Vallés (Barcelona), Spain	Tel: +34-93-565-3131 Fax: +34-93-589-2948
France	Mitsubishi Electric Europe B.V. French Branch 25, Boulevard des Bouvets, F-92741 Nanterre Cedex, France	Tel: +33-1-5568-5568 Fax: +33-1-5568-5757
South Africa	Circuit Breaker Industries Ltd. Private Bag 2016, ZA-1600 Isando, South Africa	Tel: +27-11-928-2000 Fax: +27-11-392-2354
Hong Kong	Mitsubishi Electric Automation (Hong Kong) Ltd. 10/F, Manulife Tower, 169 Electric Road, North Point, Hong Kong	Tel: +852-2887-8870 Fax: +852-2887-7984
China	Mitsubishi Electric Automation (Shanghai) Ltd. 17/F, ChuangXing Financial Center No.288 West Nanjing Road, Shanghai 200003	Tel: +86-21-2322-3030 Fax: +86-21-2322-3000
Taiwan	Setsuyo Enterprise Co., Ltd. 6F, No.105 Wu-Kung 3rd Rd, Wu-Ku Hsiang, Taipei Hsien 248, Taiwan	Tel: +886-2-2299-2499 Fax: +886-2-2299-2509
Korea	Mitsubishi Electric Automation Korea Co., Ltd. 1480-6, Gayang-dong, Gangseo-ku, Seoul 157-200, Korea	Tel: +82-2-3660-9552 Fax: +82-2-3664-8372
Singapore	Mitsubishi Electric Asia Pte, Ltd. 307 Alexandra Road #05-01/02, Mitsubishi Electric Building Singapore 159943	Tel: +65-6470-2460 Fax: +65-6476-7439
Thailand	Mitsubishi Electric Automation (Thailand) Co., Ltd. Bang-Chan Industrial Estate No.111 Soi Serithai 54, T.Kannayao, A.Kannayao, Bangkok 10230 Thailand	Tel: +66-2-517-1326 Fax: +66-2-517-3239
Indonesia	P.T. Autoteknindo Sumber Makmur Muara Karang Selatan, Block A / Utara No.1 Kav. No.11, Kawasan Industri Pergudangan, Jakarta- Utara 14440, P.O.Box 5045 Jakarta 11050-Indonesia	Tel: +62-21-663-0833 Fax: +62-21-663-0832
India	Messung Systems Pvt., Ltd. Electronic Sadan NO: III Unit No.15, M.I.D.C. Bhosari, Pune-411026, India	Tel: +91-20-2712-3130 Fax: +91-20-2712-8108
Australia	Mitsubishi Electric Australia Pty. Ltd. 348 Victoria Road, Rydalmere, N.S.W. 2116, Australia	Tel: +61-2-9684-7777 Fax: +61-2-9684-7245



HEAD OFFICE: TOKYO BUILDING, 2-7-3, MARUNOUCHI, CHIYODA-KU, TOKYO 100-8310, JAPAN
NAGOYA WORKS: 1-14, YADA-MINAMI 5, HIGASHI-KU, NAGOYA, JAPAN

When exported from Japan, this manual does not require application to the Ministry of International Trade and Industry for service transaction permission.