



23200

23210

WELCH ALLYN AM 232™ MANUAL AUDIOMETER

Ergonomic panel design and convenient controls allow one-handed operation of this easily portable audiometer. Frequency values and HL levels are easily visible at a glance. The AM 232 also offers selection modes for steady, pulsed or frequency-modulated stimulus for increased reliability of response. +10 dB push-button prevents mistaken presentation of uncomfortable frequency tones. Provides ample storage space inside hard-shell case for standard headphones and optional accessories.

- 23200 AM 232 Audiometer w/AC Only
- 23210 AM 232 Audiometer w/AC Power & Rechargeable Battery



23220

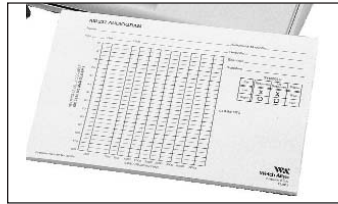

52300

WELCH ALLYN AM 232™ MANUAL AUDIOMETER ACCESSORIES

- 23220 Response Hand Switch
- 23221 Patch Cord
- 23222 Audiocups
- 52300 Audiogram Form, 50 sheets/pad, 10 pads/cs
- 72320 Replacement Rechargeable Battery Pack Only
- 72329 Complete Battery Pack Assembly w/rechargeable batteries



23300



92680

WELCH ALLYN AUDIOSCOPE® 3 SCREENING AUDIOMETER/OTOSCOPE

Versatile instrument for screening hearing loss combines 20, 25 and 40 db HL levels in one unit. Tones are presented in random intervals so patients can not second guess their hearing screen. This varied timing means improved results. Built-in 1000 Hz pretone, presented at 20 db HL above the screening level, allows patients to practice listening before they're actually screened. After pretone, patient is given the easiest tones for enhanced reliability of responses. 110-130V.

- 23300 AudioScope 3 w/AudioSpecs (no transformer)
- 92600 AudioScope 3 Set (AudioScope 3, set of AudioSpecs, charging transformer, recording forms)
- 92680 Complete Set (AudioScope 3, set of AudioSpecs, charging transformer, charging stand, recording forms)



23400



71040



72300

WELCH ALLYN AUDIOSCOPE® 3 SCREENING AUDIOMETER/OTOSCOPE ACCESSORIES

- 23303 Small AudioSpec
- 23305 Medium AudioSpec
- 23307 Large AudioSpec
- 23400 Set of AudioSpecs (small, medium, large)
- 55230 Recording Forms, 100/pk, 10 pk/bx
- 71040 Charging Transformer
- 71123 Charging Stand Only
- 72300 3.5V Nickel-Cadmium Rechargeable Replacement Battery
- 94005-0000 Paper, 5.3" x 5.8", 140 shts/pk, 12 pk/cs

SHIPPERT MEDWICK® EAR IRRIGATION PACK

PVA Expandacell ear canal pack for application of irrigation fluids, antibiotics or anti-inflammatory medication to prevent canal stricture after surgery. String attached for removal. Luer lock connection on tubing. Sterile.

- 25-M15-10 MedWick Ear Medication/Irrigation System, 15mm dia. x 24mm length, 10/bx



WELCH ALLYN EAR WASH SYSTEM PLUS

Easy to use by healthcare professionals and patient satisfaction. Chamber regulates the output pressure to prevent damage to the tympanic membrane. Handle indicator will contrast in color when water is within 10 degrees of body temperature. Chamber automatic shut-off will shut off system if water reaches 110 degrees. Multi-functional disposable tip. Device can be moved easily from location to location via a storage tray. One-year warranty.

- 29350 Ear Wash System Plus, English

Accessories

- 29330 Hose Assembly (tubing & fittings)
- 29355 Int'l Aerator Adapter Kit (aerator & 3 adapters)
- 29360 Eartips, 25/bx, 4 bx/cs
- 29373 Aerator Adapter Kit (aerator & 3 adapters)



WELCH ALLYN TM 262™ AUTO TYMP™

Offers tympanometry and ipsilateral acoustic reflex testing (with optional manual audiometry). Built-in printer and display. Improved ear seal via lightweight handheld probe. Delivers precision results with each use, and stores up to eight test results.

- 26200 Auto Tym w/IPSI Reflex
- 26230 Auto Tym w/audiometer

Accessories

- 05260-U Carrying Case
- 26100 Eartips (probe), 6 sizes
- 26240 Dust Cover
- 26241 Test Cavity
- 52600 Printer Paper, 5/bx

WELCH ALLYN OAE HEARING SCREENER

Fast, accurate results—about 10 seconds per ear. Objective testing—no patient response required. Clear results that don't require caregiver interpretation—Pass/Refer result provided by instrument. Portable, reliable design gives you increased confidence and flexibility. 10-test memory storage in device. Simple printer interface for easy patient data documentation. Patient information can be downloaded into a PC ASCII file. Optional power supply: rechargeable lithium battery or AC power. 1-year warranty, extended warranty available.

- 29400 Set Includes: OAE Hearing Screener (box only), Ear Probe, Label Printer, Ear Tip Sampler Pack, Power Supply w/cord, 6V DC, 4.0 Amp Output, Cord for Power Supply, 6' Cable, & Printer Cable
- 29402 Replacement OAE Ear Probe
- 520-PS6VDC Replacement OAE Power Supply w/cord, 6V DC, 4.0 Amp Output, Cord for Power
- 541-SEKBLE Replacement OAE Printer Cable
- 541-USB001 Replacement OAE USB 6' Cable

Accessories

- 29410 OAE Test Cavity, 5/bg
- 29411 OAE Ear Probe Body Nozzle, 5/bg
- 29420 Ear Tip Sampler Pack (tree, newborn, infants, adolescents, test cavities, & nozzle) 6/pk
- 29421 OAE Disposable Tree Ear Tips Newborn, 20/bg
- 29422 OAE Disposable Tree Ear Tips Newborn, 100/bg
- 29423 OAE Disposable Blue Infant Ear Tips, 20/bg
- 29424 OAE Disposable Blue Infant Ear Tips, 100/bg
- 29425 OAE Disposable Pediatric Foam Ear Tips, 20/bg
- 29426 OAE Disposable Pediatric Foam Ear Tips, 100/bg
- 29427 OAE Disposable Adolescent Foam Ear Tips, 20/bg
- 29428 OAE Disposable Adolescent Foam Ear Tips, 100/bg
- 29440 OAE Carrying Case (case for screener set only, no printer)
- 29450 OAE Label Printer
- 29451 OAE Label Printers, 220 labels/roll
- 29460EX Extended Warranty - One Year (covers hearing screener, unit, probe, calibration once every 2 years, battery replacement)



23640



93690

WELCH ALLYN MICRO TYMP® 2 PORTABLE TYMPANOMETRIC INSTRUMENT

Portable, hand-held unit detects otitis media and other middle ear disorders. Measures sound returned from eardrum under positive, negative, and atmospheric pressure to determine status of middle ear. Accurately identifies many middle ear disorders in asymptomatic cases. Printer/charger keeps Micro Tym fully charged and provides hardcopy documentation. Results instantly displayed on LCD before printing. 226 Hz frequency, 85 db HL intensity.

- 23640 Micro Tym II (includes 2 sets of tips)
- 93690 Micro Tym II Set (includes printer/charger, extra paper & tips)



23630

71170

WELCH ALLYN MICRO TYMP® 2 PORTABLE TYMPANOMETRIC INSTRUMENT ACCESSORIES

- 05276-U Carrying Case
- 23630 Set of Micro Tym II Tips (4 sizes)
- 23639 Multi-Pack of MicroTym® 2 Probe Tips (5 Small, 10 Medium, 10 Large, 5 X-Large)
- 71170 Printer/Charger (includes paper)
- 72900 2.4V Nickel Cadmium Rechargeable Battery

RIESTER SCHIOTZ TONOMETER

- 5110 Schiotz A, Straight Scale, Silver
- 5111 Schiotz B, Inclined Scale, Silver
- 5112 Schiotz C, Inclined Scale, Silver

RIESTER TUNING FORKS

Nickel steel or aluminum. Large selection of different frequencies: from 64 Hz to 4096 Hz. Tuning forks with and without clamps. Tuning forks with and without base for different requirements in everyday hospital and office practice.

- 5140 Tuning Fork Set I



WELCH ALLYN SURESIGHT™ VISION SCREENER

Screen with one-button touch from 14" away. Five-second, automatic test addresses compliance problems and makes testing easier. Minimal cooperation is required, making it ideal for use with young children. The lights and sounds engage the child's attention. Automatically measures and indicates abnormal readings. Addresses eye charts' sensitivity and specificity problems. Automatically screens for common vision problems, including near- and farsightedness, astigmatism, and anisometropia. Hand-held unit operates for three hours of continuous testing. Available battery-operated printer enables you to get print-outs anywhere, anytime. Weighs two lbs. and features an ergonomic grip and replaceable, self-adjusting hand strap. Features optics and electronics shock-mounted inside housing to protect unit. The sealed unit helps keep out dirt. Screens babies, children, and adults. You can even test patients while they're wearing glasses or contact lenses.

14000 SureSight™ Vision Screener Set, Includes 110-130V Charging Transformer & Stand

Accessories

- 05140-U Carrying Case
- 14042 Thermal Printer
- 53600 Printer Paper, 5 r/cs



WELCH ALLYN STRABISMOSCOPE™ UNIDIRECTIONAL OCCLUDER

Test for both heterophorias (latent Strabismus) and heterotropias (manifest Strabismus) at the same time. One-way mirror allows direct observation of occluded eye. View movement of both covered and uncovered eyes simultaneously. Allows for confident diagnosis of Dissociated Vertical Deviation. Rugged ABS housing withstands drops and falls. Lightweight and easy to clean. Fits all Welch Allyn 3.5V power sources. Handles must be ordered separately.

- 12400 StrabismoScope Head Only
- 12451 3.5-V Halogen StrabismoScope Set Includes StrabismoScope, Rechargeable Handle & Soft Carrying Case

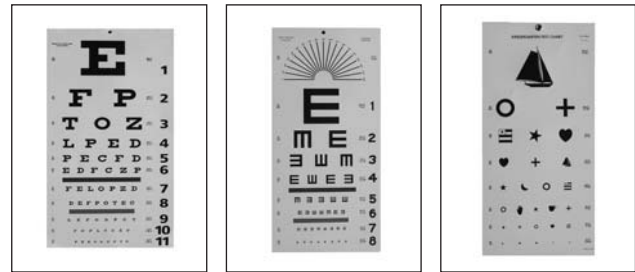

3050 3051 3052

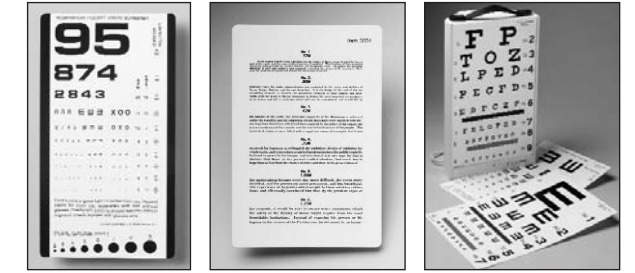

3053 3054 3060

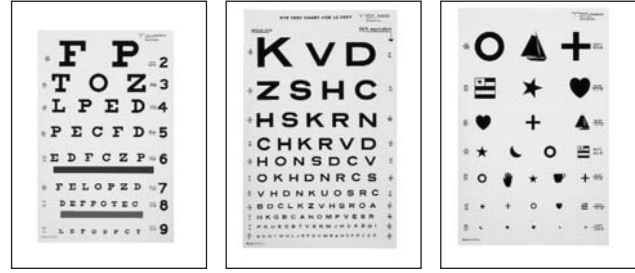

3061 3062 3063

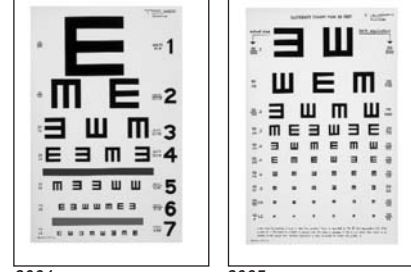

3064 3065



3066

TECH-MED EYE CHARTS

- 3050 Snellen Eye Test Chart, 20 ft, Non-Reflective Matte Finish, 22" x 11"
- 3051 Illiterate Eye Test Chart, 20 ft, Non-Reflective Matte Finish, 22" x 11"
- 3052 Kindergarten Eye Chart 20 ft, Non-Reflective Matte Finish, 22" x 11"
- 3053 Pocket Eye Chart, Use at 14", Provides 20/800 Distance, Laminated Plastic, 6 1/2" x 3 1/2"
- 3054 Jaeger Eye Chart
- 3060 Illuminated Eye Test Cabinet, Baked Enamel Finish w/handle & power cord, Includes 1 each Illuminated Eye Charts
- 3061 Illuminated Snellen Eye Test Chart, 20 ft
- 3062 Illuminated Snellen Eye Test Chart, 10 ft
- 3063 Illuminated Kindergarten Eye Test Chart, 20 ft
- 3064 Illuminated Illiterate Eye Test Chart, 20 ft
- 3065 Illuminated Illiterate Eye Test Chart, 10 ft
- 3066 Eye Occluder

GRAHAM FIELD ILLUMINATED EYE TEST CABINET

Non-glare, illuminated metal cabinet with standard Snellen, Illiterate E and Illiterate 10 ft translucent plastic eye charts. 8W daylight fluorescent bulb illuminates black letters on bright white screen for more efficient testing. Grey hammertone finish. 110-120V AC. Portable or can be wall mounted.

- 1258 Illuminated Eye Test Cabinet, 14" x 9" x 4", Includes 3 Charts (1261, 1262 & 1262-1)
 1261 Standard Snellen Eye Test

**AARON OPHTHALMIC BURR POWER HANDLES & BURR TIPS**

Disposable burr for foreign body and rust ring removal. Sterile. Single-use items unless noted.

- 0001 1mm Ophthalmic Burr, 10/bx
 0010 Burr II, Ophthalmic Burr, Non-Sterile
 0011 Diamond Burr, 2.5mm, Non-Sterile, Reusable
 0012 Diamond Burr, 5mm
 AB01 1mm Burr, 10/bx
 AB05 1/2mm Burr, 10/bx

**AARON NEURO-PULSE**

This nerve locator/stimulator has three variable outputs (1/2mA, 1mA, 2mA) which allow the surgeon to select the correct current depending on nerve size. The light emitting diode illuminates when the probe contacts exposed tissues. Excellent for hand and reconstructive surgery. Sterile. Two-year shelf life.

- 0003 Neuro-Pulse, 10/bx

ADC WOVEN TAPE MEASURE

Enclosed in compact container. Measures in inches and centimeters (60"/150cm). Push button in back to rewind tape.

- 396 Woven Tape Measure

ALBA TAPE MEASURE

- 185 C.A.R.E. Tape Measure, 12 ea/cs

GRAHAM FIELD GRAFCO® WOVEN TAPE MEASURE

Durable tape graduated with inches in black on one side and centimeters in red on reverse side. Blank space before zero. Push-button, white plastic case.

- 1340-2 72" Tape Measure 1/4" width, 6/bx

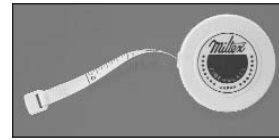
**MILTEX MEASURING TAPE**

- 1-3200 Fiberglass Measuring Tape

OMRON TAPE MEASURES

1/4" wide fiberglass tape. Self-winds with a push of a button. 72". Inches and centimeters printed on opposite sides. Inches printed in black, centimeters printed in red. Plastic housing.

- 8-380 White Housing Tape Measure

SECA 200 GIRTH MEASURING TAPE

Automatic retraction can be used for measuring head, arm, waist and leg circumference.

- 2001717009 Girth Measuring Tape w/automatic retraction -cm
 2001817009 Girth Measuring Tape w/automatic retraction -inches

**SECA 206 TAPE MEASURE**

Automatic metal tape measure to wall mounting.

- 2061717009 Tape Measure w/wall stop & magnifier
 2061817139 Tape Measure w/wall stop & magnifier

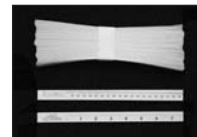

4412



4413



4414



4417



4421



4422

TECH-MED TAPE MEASURE

- 4412 36" Paper Tape Measure, Heavyweight Disposable w/blue markings, 1000/bx
 4413 24" Paper Tape Measure, Heavyweight Disposable w/blue markings, 1000/bx
 4414 Tape Measure, 72"L, 1/4"W, Linen-Like Fiberglass, White Plastic Case w/push button to retract tape, English Scale, Reverse Side Metric, 6/bx
 4417 Tape Measure, 72" L, 1/4" W, Linen-Like Fiberglass, English Scale & Metric Scale on Reverse Side, 10/pk
 4421 Envelopes, 3 1/2" x 2 1/4", Self Adhesive, 500/bx
 4422 Tape Measure, 120"L x 1/4 W, Linen-Like Fiberglass, 6/bx



PRO ADVANTAGE® DIGITAL THERMOMETER KIT

This dual scale (F/C) thermometer provides a digital readout in approximately 60 seconds. Beeps when measurement is complete. Can be used for oral, rectal or axillary measurement. Convenient automatic shut off and last reading memory. Moisture resistant. Meets ASTM E1112 Standards. Comes with storage case and 5 sheaths. Two year warranty.

P541222 Digital Thermometer w/5 thermometer sheaths

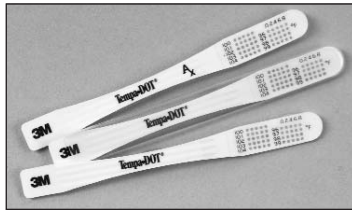

3M™ TEMPA-DOT™ AX THERMOMETERS

Single-use and disposable with an adhesive strip to hold itself in place in the underarm area when measuring axillary body temperature. Individually wrapped.

5001 Fahrenheit Thermometer, 80/bx, 20 bx/cs
5002 Celsius Thermometer, 80/bx, 20 bx/cs

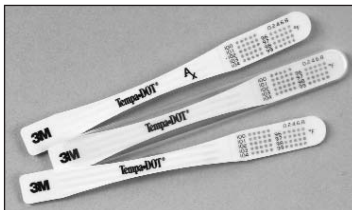

3M™ TEMPA-DOT™ SINGLE-USE THERMOMETERS

Single-use and disposable thermometer that can measure oral or axillary body temperature.

5122 Fahrenheit Thermometer, Sterile, Individually Wrapped, 100/bx, 20 bx/cs
5122NS Thermometer Fahrenheit, Non-Sterile, Individually Wrapped, 100/bx, 20 bx/cs
5125 Fahrenheit Thermometer, Sterile, Individually Wrapped, 100/bx, 5 bx/cs
5147 Fahrenheit Thermometer, Non-Sterile, Unwrapped, 250/bx, 24 bx/cs
5532 Celsius Thermometer, Sterile, Individually Wrapped, 100/bx, 20 bx/cs
5557 Celsius Thermometer, Non-Sterile, Unwrapped, 250/bx, 24 bx/cs

3M™ TEMPA-DOT™ PLUS THERMOMETERS

A single-use, disposable clinical thermometer pre-assembled in a sheath for use in measuring rectal body temperature.

5192R Thermometer, Rectal, Non-Sterile, Fahrenheit, Provided w/sheath, 100/bx, 16 bx/cs
5502R Thermometer, Rectal, Non-Sterile, Celsius, Provided w/sheath, 100/bx, 16 bx/cs

COVIDIEN/KENDALL FILAC 3000 THERMOMETER

Accuracy: direct mode 0.1°C; standard prediction mode 0.1°C; quick prediction mode (oral only) 0.3°C. Rapid response time: standard mode 6-10 second oral; 10-15 second axillary/rectal; quick mode 3-4 second oral; 10-15 second axillary/rectal. No assembly required, intuitive icons, and progress bar allows for ease of use. Temperature measurement status indication. Intuitive, contributes to ease of use. Alternates celsius/fahrenheit scale to customize temperature read outs to follow facility protocol. A "beep" allows facility to recognize that the temperature is completed. Color coded isolation chambers with matching probes helps keep probe covers and probes together for aiding in infection control. Auto on turns on when the probe is withdrawn from probe well. Auto off conserves battery life. Allows history of patients last temperature. Convenient for pulse monitoring. Lower preheat temperature option. Provides quicker accurate readings for post OR patients: 12-15 seconds oral; 15-20 seconds axillary/rectal. Electronic anti theft and locking base protects investment. Deters casual theft by disabling the thermometer after a preset number of temperatures have been taken. Easy to read with black light.

500026 Probe, Oral Filac 3000, 4 ft.
500027 Probe, Oral Filac 3000, 9 ft.
500028 Chamber ISO, Oral Filac 3000
500036 Probe, Rectal Filac 3000, 4 ft.
500037 Probe, Rectal Filac 3000, 9 ft.
500038 Chamber ISO, Rectal Filac 3000
500046 Wall Mount w/lock, Filac 3000
500099 Thermometer, Filac 3000, Calibration Plug
500500 Probe Covers Filac 3000, 500/cs
502000 Probe Covers Filac 3000, 2000/cs
504000 Thermometer, Filac EZ 3000, Oral/Axillary Complete
504005 Thermometer, Filac EZ 3000, Rectal Complete
504027 Thermometer, Filac EZ 3000, Oral/Axillary Complete, 9 ft.
504037 Thermometer, Filac 3000, Rrectal Complete, 9 ft.
505000 Thermometer, Filac AD 3000, Oral/Axillary Complete
505005 Thermometer, Filac AD 3000, Rectal Complete
505027 Thermometer, Filac AD 3000, Oral/Axillary Complete, 9 ft.
505037 Thermometer, Filac AD 3000, Rectal Complete 9 ft.

Accessories

500047 Filac 3000 Mounting Base For Mobile Stand
500048 Filac 3000 Mounting Base w/pole clamp



COVIDIEN/KENDALL FILAC FASTEMP ELECTRONIC THERMOMETER

4-10 second reading. Isolation chambers. Global iconography. Oversized backlit LCD display. Fahrenheit/Celsius button. Last temperature recall. 30 second pulse timer. Temperature range of 85°F-11°F/30°C-43°C. Electronic anti-theft system. ASTM and CEN compliance.

202000 Complete Oral/Ax System Including Electric Thermometer, 4 Lang Ops Man, Blue Oral/Ax Iso Chamber, Blue Probe w/4' cord, Wall Mountable Base, Mounting Hardware
202018 Fastemp Monitor, Including 4 Language Operating Manuals
202026 Fastemp Blue Oral/Axillary Probe w/blue 4' cord
202027 Fastemp Blue Oral/Axillary Probe w/blue 9' cord
202028 Fastemp Blue Oral/Axillary Isolation Chamber
202034 Fastemp Red Rectal Probe w/red 4' cord
202036 Fastemp Red Rectal Isolation Chamber
202037 Fastemp Red Rectal Probe w/red 9' cord
202038 Fastemp Red Rectal Isolation Chamber, Red Rectal Probe w/red 4' cord, Wall Mountable BS, Hardware
202099 Fastemp Calibration Plug
2020PC Primary Care Kit Includes: FastTemp Thermometer, Blue Oral/Axillary Isolation Chamber, Blue Oral/Axillary Probe w/4' cord, Wall Mountable Base, Mounting Hardware, (500) Probe Covers



COVIDIEN/KENDALL FILAC F-1500 ELECTRONIC THERMOMETER

Large, clear LCD temperature display. Automatic display. Auto Off feature. 30-35 second temperature reading. Audible signal. In-house two point calibration. Two lithium batteries. Lightweight.

- 8884103650 Oral Probe Only
- 8884103660 Rectal Probe Only

- Accessories**
- 8884221000 Probe Covers, 20/pkg, 25 pkg/bx, 10 bx/cs



COVIDIEN/KENDALL FASTEMP PROBE COVERS

Disposable, single-use. Smooth, rigid plastic. Dispenser package fits in the isolation chamber. Contains no latex or natural rubber.

- 202020 Probe Covers for FASTEMP Thermometer, 20/pk, 25 pk/bx, 10 bx/cs

COVIDIEN/KENDALL GENIUS2™ TYMPANIC THERMOMETER

Utilizes infrared technology to derive the most accurate body temperature from the tympanic membrane. Records and analyzes up to 100 temperature measurement, and selects the highest and most accurate in less than 2 seconds. Reduces the chance of an inaccurate reading due to improper technique or patient movement. Durable tip-based sensor technology improves durability and accuracy, minimizing the need for recalibration. Small tapered tip facilitates proper alignment with the tympanic ear canal to minimize technique errors, enhance patient comfort and facilitate pediatric use. One to two second response time. Provides actual current temperature status unlike predictive devices. Shows oral, rectal, auxiliary and core or an absolute temperature reading in the ear setting, and can be customized according to hospital protocol. No contact with mucosal membranes and the no-touch probe cover application and release reduce potential of cross-contamination.

- 303000 Thermometer w/base
- 303030 Thermometer Probe Covers, 96/ctn, 22 ctn/cs
- 303099 Thermometer, Calibration Checker

COVIDIEN/KENDALL GENIUS2 TYMPANIC THERMOMETER ACCESSORIES

- 303058 Genius Locking Wall Mount
- 303059 Genius 2 Mobile Stand w/locking mount
- 303060 Genius 2 Cart Conversion Kit



8884810055

COVIDIEN/KENDALL GENIUS MODEL 3000A TYMPANIC THERMOMETER ACCESSORIES

- 8884810055 Cassette of 21 Probe Covers, 5 cassettes/pkg, 10 pkg/bx, 2 bx/cs
- 8884813711 Side Utility Basket for Mobile Thermometer Stand, 1/cs
- 8884814065 Wall Mount
- 8884830301 Mobile Thermometer Stand, 1/cs

COVIDIEN/KENDALL SOFT-E™ TEMPERATURE PROBE COVERS

Gentle, non-irritating clear adhesive hydrogel securely anchors temperature probe to infant's skin. May be removed and repositioned. Reflective mylar acts as a barrier against ambient and radiant heat. Individually packaged in resealable packs.

- 31424784 Temperature Probe Covers, Small, 200/cs
- 31424792 Temperature Probe Covers, Large, 200/cs
- MI30002 Temperature Probe Covers, Cover Babies, 3/4" x 1 1/4", 800/cs

WELCH ALLYN SURETEMP® THERMOMETER

Oral response time: approx. 4 seconds. Axillary response time: approx. 10 seconds. Rectal response time: approx. 15 seconds. Continuous temperature reading. Measurement range: 84.0°F to 108.0°F. Unit dimensions: 2.25" x 3" x 7". Weight: 11.5 oz. Three AA alkaline batteries included. Three-year limited warranty on instrument. One-year limited warranty on probe.

- 01692-301 Model 692 SureTemp Plus Thermometer, One Per Room, Wall Mount, 9 ft Rectal Probe w/rectal probe well (must be locked to the wall)

Accessories

- 02891-0000 Probe Well, Blue, For SureTemp 690
- 02891-1000 Probe Well, Red, For SureTemp 690
- 02892-000 Probe & Well Kit, 4 ft Rectal
- 02892-100 Probe & Well Kit, 9 ft Rectal
- 02893-000 Probe, Oral w/well, Use w/SureTemp® Model 690
- 02893-100 Probe & Well Kit, 9 ft Oral
- 06138-000 Calibration Key, Assembly For 690/692
- 08273-000 Thermometer Stand, 690/692 w/holder For Spare Probe & Well
- 21013-0000 Wall Holder For 250 Probe Covers
- 21326-0000 Wall Holder For 690/692
- 21330-0000 Holder For Spare Probe & Probe Well For 690/692
- 21333-0000 Bracket, M600 Stand Upgrade, 690/692 w/holder For Spare Probe & Well



01690-200



01690-400

WELCH ALLYN SURETEMP® PLUS ELECTRONIC THERMOMETER

- 01690-200 Model 690 Electronic Thermometer, Oral Probe w/oral probe well, 2-Year Limited Warranty
- 01690-201 Model 690 Electronic Thermometer, Rectal Probe w/rectal probe well, 2-Year Limited Warranty
- 01690-300 Model 690 Electronic Thermometer, One Per Room, 9 ft Oral Probe w/oral probe well, 2-Year Limited Warranty (must be locked to the wall)
- 01690-301 Model 690 Electronic Thermometer, One Per Room, 9 ft Rectal Probe
- 01690-400 Model 690 Electronic Thermometer, Wall Mount, Oral Probe w/oral probe well, 2-Year Limited Warranty
- 01690-700 Model 690 Electronic Thermometer, Includes: Wall Mount, 9 ft Oral Probe w/oral probe well, Rolling Stand, Spare Probe, Well Holder, & 2-Year Limited Warranty.
- 01692-200 Model 692 Electronic Thermometer, Wall Mount, Security System w/ID location field, Oral Probe w/oral probe well, 3-Year Limited Warranty
- 01692-201 Model 692 Electronic Thermometer, Wall Mount, Security System w/ID location field, Rectal Probe w/rectal probe well, 3-Year Limited Warranty
- 01692-300 Model 692 Electronic Thermometer, One Per Room, Wall Mount, 9 ft Oral Probe w/oral probe well, 3-Year Limited Warranty (must be locked to the wall)
- 01692-700 Model 692 Electronic Thermometer, Wall Mount, 9 ft Oral Probe w/oral probe well, rolling stand, spare probe & well holder, 3-Year Limited Warranty



WELCH ALLYN PRO4000 EAR THERMOMETER

- 04000-200 Braun ThermoScan Pro4000 Ear Thermometer w/3 yr limited warranty
- 04000-300 Braun ThermoScan Pro4000 Ear Thermometer w/security base station and 3 yr limited warranty
- 04000-400 Braun ThermoScan Pro4000 Ear Thermometer w/roll stand and 3 yr limited warranty

Accessories

- 24001-0000 Rolling Thermometer Stand and Rechargeable Base Station
- 24001-1000 Recharging Base Station
- 53020-0000 Braun ThermoScan Pro4000 Rechargeable Battery Pack
- 80199-0000 Braun ThermoScan Pro4000 Replacement Power Cord for Base Station
- 85378-0000 Rolling Stand Mounting Bracket (Mounting Bracket for WA Universal Stand)

WELCH ALLYN EAR THERMOMETER PROBE COVERS

Probe covers are backward compatible with the old Braun ThermoScan products as well as the current PRO3000, PRO4000 Lines.

- 05075-005 Probe Covers, 5000/cs
- 05075-800 Probe Covers, 800/cs

ADC ADTEMP™ I DIGITAL THERMOMETER

An electronic thermometer designed and priced to be a viable replacement for mercury filled glass thermometers, which are gradually being phased out of healthcare. This new model features a striking translucent housing with integral case. It is dual-scale (C/F) switchable, water resistant and offers a last reading memory. It does not have a beeper, but it will lock in the reading once measurement is complete. This makes an ideal item as a true mercury thermometer replacement. Features a storage case, long life battery and auto-off feature.

- 412-00 Single Patient Use Digital Thermometer, Bulk, 20/pk
- 412K Single Patient Use Digital Thermometer SPU Kit

ADC ADTEMP™ II DIGITAL THERMOMETER

Features a water resistant design, last reading memory and is dual scale (C/F) switchable. Replaces the 410 and 6001 series thermometers.

- 413B Oral Digital Thermometer
- 413B-00 Oral Digital Thermometer, 25/pkg
- 413BK Oral Digital Thermometer SPU Kit
- 413R Rectal Digital Thermometer
- 413R-00 Rectal Digital Thermometer, 25/pkg
- 413RK Rectal Digital Thermometer SPU Kit

ADC ADTEMP™ III DIGITAL THERMOMETER

An electronic thermometer with a flexible probe designed and priced to be a viable replacement for mercury filled glass thermometers, which are gradually being phased out of healthcare. The flexible probe provides greater patient safety and is ideal for pediatric applications. This new model features a 2-piece case. It is dual-scale (C/F) switchable, water resistant and offers a last reading memory. Beeps when measurement is complete. Features a storage case, long life battery and auto-off feature.

- 414 Digital Thermometer Kit, Flex Tip, Retail Boxed
- 414K Digital Thermometer Kit, Flex Tip, Boxed w/5 sheaths

ADC ADTEMP™ IV DIGITAL THERMOMETER

- 415 Digital Thermometer
- 415K Digital Thermometer SPU Kit
- ADC 415 Digital Thermometer

ADC ADTEMP™ TYMPANIC THERMOMETER

The most compact Tympanic thermometer on the market. Measures core temperature instantly from the ear reliably and accurately. Switchable dual scale measurements in either °F for °C modes. Range 89.6°F - 08°F +/- .4°F or 32°C - 42.2°C +/- .2°C depending on scale selection. Probe cover FREE design is less costly and more convenient to use. Large 6mm displays is easy to read. Illuminated backlight display. Compact (1" long, 1.9 oz.) ergonomic design fits comfortably in operator's hand and patient's ear. Audible fever alarm at 99.5° (37.5°C). Stores last 12 readings in memory. Complete with Lithium battery, storage/travel case, and operating instructions. Two year warranty. Made in China, Inspected in U.S.A.

- 421 Tympanic Thermometer

ADC ADTEMP™ V DIGITAL THERMOMETER

Represents state-of-the-art in micro digital fever thermometers. This new unit features a stylish European design, extra large display and flexible tip. It is water resistant, dual scale (C/F) switchable and has a last reading memory. The response time is 10 seconds rectal and 18 seconds oral. Beeps when measurement is complete. Features a storage case, long life battery and auto-off feature.

- 418 Super Fast Read Digital Thermometer, Flex Tip, Boxed w/5 sheaths



ADC ADTEMP™ THERMOMETER SHEATHS

Disposable design eliminates cross contamination. Cost effective. Easy to apply. Suitable for oral or rectal use. Digital model designed for use with ADC® and most comparably sized digital thermometers. Made in the U.S.A.

416-100	ADTEMP™ Digital Sheaths, 100/bx
416-1000	ADTEMP™ Digital Sheaths, 1000/bx
416-50	ADTEMP™ Digital Sheaths, 50/bx

ADC ADTEMP™ 422 VETERINARY DIGITAL THERMOMETER

Auto-off function conserves battery life. Range 90°F - 109.9°F or 32°C - 43.9°C ± 1°C depending upon scale selection. Replaceable 1.55v (LR41) type battery provides up to 1,500 measurements. Specially designed housing with lanyard attachment for enhanced removal. Integral carry case.

422	Adtemp™ 422 Veterinary Digital Thermometer
-----	--

RIESTER THERMOMETRY

Its innovative infrared technology not only allows ri-thermo® N to measure the body temperature of children and adults easily in a matter of seconds but also means that it can measure the temperature of surfaces, rooms and bathwater. The temperature values are displayed in a range from 0 to 100°C or on the corresponding scale in ° Fahrenheit. Its large LCD display with backlighting makes the values easy to read. Even in the dark. Displays up to 12 stored temperatures. Temperature curves can also be plotted retrospectively or different measured values compared, so patients large and small can be monitored even more closely. The ri-thermo® N sounds a handy acoustic signal when it has finished measuring and if it detects a fever, has an energy-saving automatic switch-off function and comes with a hygienic storage container with probe covers.

12702	Disposable Probe Covers, 1000/pk
1805	Thermometer, 40 Probe Covers, Ri-Thermo® N

BD THERMOMETERS

522862	Basic Digital Thermometer, 12/bx
--------	----------------------------------

Accessories

522870	Probe Covers For Oral Thermometer, 50/bx, 20 bx/cs
522871	Probe Covers For Rectal Thermometer, 50/bx, 20 bx/cs

GRAHAM FIELD HEALTHTEAM® DIGITAL THERMOMETER WITH BEEPER

Quickly records and displays oral, rectal, or axillary temperature. Beeper sounds when peak temperature is reached. Easy-to-read LCD display. Auto shut off.

HT1856-1	Thermometer, Fahrenheit
HT1857	Thermometer, 10 Sec Response, Dual Scale F° or C°

GRAHAM FIELD HEALTHTEAM® DISPOSABLE PROBE COVERS

Helps stop infection. Fits most glass and digital thermometers.

HT1859	Disposable Probe Covers, 100/bx
--------	---------------------------------



OMRON BASAL DIGITAL THERMOMETER

Identify ovulation timing. Includes temperature tracking chart. Beeps at peak temperature. Waterproof for easy cleaning. Measures in 60 seconds and is three times faster than basal glass thermometers. Meets ASTM (E1112) standard.

MC-301N	Basal Digital Thermometer
---------	---------------------------



OMRON COMPACT DIGITAL THERMOMETER

No fear of broken glass or mercury poisoning. Fast, accurate reading in 60 seconds. Premium long life battery (up to 400 hours of continuous use). Waterproof for easy cleaning.

MC-102	Digital Thermometer (Spanish/Portuguese) Centigrade
MC-110	Digital Thermometer, 60 Second, Compact
MC-110B	Digital Rectal Thermometer, 20/cs



MC-130MO



MC-130MR

OMRON DIGITAL FEVER THERMOMETER

Oral or rectal available. Quick accurate temperature in 60 seconds. Beeps at peak temperature. Memory recalls last temperature. Meets ASTM (E1112) standard. Waterproof for easy cleaning.

MC-130MO	Digital Oral Thermometer
MC-130MR	Digital Rectal Thermometer

OMRON DIGITAL FLEXIBLE THERMOMETER

Flexible tip for added comfort and safety. Beeps at peak temperature. Memory recalls last temperature. 10 second reading. Meets ASTM (E1112) standard.

MC-206N	Flexible Digital Thermometer
---------	------------------------------

OMRON DIGITAL RIGID THERMOMETER

3 times faster than traditional digital thermometers. Features include jumbo display for easy reading, memory and long-life 3-volt battery. For use oral, underarm and rectal locations. Safe, no fear of glass breakage or mercury. Includes 5 probe covers.

MC-106N	Rigid Digital Thermometer
---------	---------------------------

OMRON PROBE COVERS

Individually wrapped disposable probe covers fit securely over the sensor portion on any Omron or Marshall thermometer.

- 0007PROB Probe Covers, 50/bx
- 0009PROB Probe Covers, 100/bx
- 600RPROBE Probe Covers For MC-600, 25/bx

OMRON GENTLE TEMP® INSTANT EAR THERMOMETER LENS COVER

- MC-505LC Lens Covers For Ear Thermometer, 40/bx



OMRON INSTANT EAR THERMOMETER ACCESSORIES

- MC-509NLC Thermometer Lens Covers, 40/bx

OMRON MC-514 EAR THERMOMETER

Instant, one second reading (takes 250 scans per second). Convenient storage case keeps thermometer and lens covers together. Engineered button placement ensures, safe comfortable use. Sleek design fits comfortably in the ear and in the palm of any size hand. Meets accuracy standards of ASTM (E 1965-98). Memory feature recalls last temperature reading. Measuring mode reads in Fahrenheit and Celsius. Lens cover detection for hygienic use. Five-year warranty.

- MC-514 MC-514 Ear Thermometer



TIDI SANITHERM THERMOMETER SHEATHS

- 20521 Mercury Oral Thermometer Sheaths, 100/bx, 50 bx/cs
- 20524 Mercury Oral Thermometer Sheaths, 500/bx, 10 bx/cs
- 20538 Mercury Oral Thermometer Sheaths, Bulk, 11000/cs
- 20631 White Digital Oral Thermometer Sheaths, Bulk, 11000/cs
- 20633 Digital Oral Thermometer Sheaths, 100/bx, 50 bx/cs
- 20634 Digital Oral Thermometer Sheaths, 500/bx, 10 bx/cs
- 20636 Digital Oral Thermometer Sheaths, 5000/cs
- 20657 Digital Oral Thermometer Sheaths, Packed in Sheets of 10, Indexed Every 50, Bulk, 10000/cs
- 20710 Prelubricated Mercury Rectal Thermometer Sheaths, 100/bx, 50 bx/cs
- 20775 Digital Rectal Thermometer Sheaths, 100/bx, 50 bx/cs



PRO ADVANTAGE® PREMIUM POCKET ANEROID SPHYGMOMANOMETER

A professional inflation system featuring a manometer, a cuff size marking system, chrome-plated brass air release valve, dip molded inflation bladder and bulb for heavy use and a zippered carry case. 20 year calibration warranty, lifetime system warranty. Available in latex and latex free.

- P548310 Adult, Black, Latex
- P548320 Child, Black, Latex
- P548350 Large Adult, Black, Latex
- P548330 Child, Black, Latex Free
- P548340 Adult, Black, Latex Free
- P548360 Large Adult, Black, Latex Free



PRO ADVANTAGE® STANDARD POCKET ANEROID SPHYGMOMANOMETER

An economical inflation system featuring a manometer, chrome-plated deflation valve, nylon cuff, inflation bladder and bulb and a zippered carry case. 10 year calibration warranty, 1 year system warranty. Contains latex.

- P548440 Adult, Navy Blue, Latex
- P548445 Child, Navy Blue, Latex
- P548450 Large Adult, Navy Blue, Latex

**Can't find what
you're looking for?
Call your
representative.**



PRO ADVANTAGE® DELUXE ANEROID SPHYGMOMANOMETER

This Deluxe Aneroid Sphygmomanometer offers the most features including a precision crafted manometer, cuff size marking system with extended graduation marks, filter protected bulb, dip molded inflation bladder for heavy use, chrome-plated brass air release valve and a zippered carry case. Lifetime calibration warranty, 2 year system warranty. Contains latex.

- P548200 Adult, Black, Latex
- P548210 Child, Black, Latex
- P548215 Large Adult, Black, Latex



P548900



P549200



P549220



P549500



P549510

PRO ADVANTAGE® SPHYGMOMANOMETER ACCESSORIES

Accessories for Pro Advantage Sphygmomanometers. Available choices are a pocket gauge, cuffs and bladders, and inflation systems. Gauge features a black enamel finish. Cuff and bladder features a nylon cuff with marking system. Inflation system and a dip molded bladder. Inflation system features a nylon cuff with marking system, inflation bladder, filter protected bulb and valve. The pocket gauge has a lifetime calibration warranty. Available in latex and latex free.

- P548900 Pocket Gauge, Black
- P549200 Cuff & Bladder, Adult, 2-Tube, Black, Latex
- P549220 Cuff & Bladder, Adult, 2-Tube, Black, Latex Free
- P549240 Cuff & Bladder, Large Adult, 2-Tube, Black, Latex Free
- P549500 Inflation System, Adult, Black, Latex
- P549505 Inflation System, Child, Black, Latex
- P549520 Inflation System, Large Adult, Black, Latex
- P549510 Inflation System, Child, Black, Latex Free
- P549515 Inflation System, Adult, Black, Latex Free
- P549525 Inflation System, Large Adult, Black, Latex Free

TERUMO ELEMANO™ BLOOD PRESSURE MONITOR & ACCESSORIES

- ES*H5503 Main Body of Elemano, Medium Cuff, 2 AA Alkaline Batteries, 1 Instruction Manual, 5/cs
- XX*ES11L06 Large Cuff Cover w/air bag & tubing, Washable Nylon
- XX*ES11M06 Medium Cuff Cover w/air bag & tubing, Washable Nylon
- XX*ES11S06 Small Cuff Cover w/air bag & tubing, Washable Nylon
- XX*ES11SS06 X-Small Cuff Cover w/air bag & tubing, Washable Nylon
- XX*ES14L06 Large Cuff Cover, Washable Nylon, 20/cs
- XX*ES14M06 Medium Cuff Cover, Washable Nylon, 20/cs
- XX*ES14S06 Small Cuff Cover, Washable Nylon, 20/cs
- XX*ES14SS06 X-Small Cuff Cover, Washable Nylon, 20/cs
- XX*ES1602 Accuracy Check Parts, 8/cs
- XX*ES1702 Storage Bag, 20/cs
- XX*ES1802 Inflation Bulb, 50/cs



7670-01



7670-03

WELCH ALLYN 767 SERIES WALL & MOBILE ANEROIDS

Latex free. The Tycos 767 Wall and Mobile Aneroids offer all the dependability and accuracy of our classic aneroids, along with an updated look. Precision, jewelled-movement manometer that is certified to be accurate within one percent of scale (± 3 mmHg). Laser-engraved dial face for precision calibration. Built-in basket for securely storing the inflation system. High-impact housing and bezel to protect the movement and crystal. Large dial face (6 1/4") and bright orange pointer for easy reading. 40° side-to-side swivel for clear viewing at all angles. The Mobile aneroid has adjustable height stand and locking collar, 4' coiled tubing and 360° manometer swivel for ease of reading. Lifetime calibration and manufacturing warranty.

- 7670-01 767 Wall Aneroid w/Adult Cuff
- 7670-02 767 Wall Aneroid Manometer Only w/8 ft tubing
- 7670-03 Mobile Aneroid w/Adult Cuff
- 7670-04 Mobile Aneroid w/weighted base & adult cuff
- Accessories**
- 7670-06 Mobile Stand & Basket Assembly Only (base weight not included)
- 7670-07 Inflation System Basket, White
- 7670-08 Crystal

Ask about our
new products.



5098-02



5098-18



5098-23

WELCH ALLYN CLASSIC HAND ANEROID

Unsurpassed accuracy and durability in the traditional classic design. For more than 30 years, the Tycos Classic Hand Aneroid has delivered performance and reliability in worldwide clinical use. Precision, jewelled bearings resist wear for consistently accurate readings. Every dial face is individually laser-engraved for exact calibration. Crisp white graphics on large charcoal-gray scale for better readability. Unique phosphor-bronze aneroid bellows ensure consistent pressure measurement. Recessed dial brings needle and dial markings close together and eliminates parallax. Single-tube leur connector allows for easy interchange of cuff sizes. Lifetime calibration and manufacturing warranty. All latex free.

- 5098-02 Aneroid w/Adult Cuff, Latex Free
- 5098-18 Pediatric Blood Pressure Kit w/case, Includes Newborn, Infant & Child Size Cuffs, Latex Free
- 5098-23 Family Practice Kit w/case, Includes Child Print Cuff, Adult & Large Adult, Latex Free

WELCH ALLYN CLASSIC POCKET ANEROID

Provides protection to the manometer during the rigors of clinical use. Precision, jewelled bearings resist wear for consistently accurate readings. Gauge attached to cuff protects instrument and prevents cuff and gauge from being easily separated. Laser-engraved dial for precise calibration. Unique phosphor-bronze bellows ensure consistent pressure measurement. Crisp, white graphics on large charcoal-gray scale for better readability. Lifetime warranty on calibration and manufacturing quality. All latex free.

- 5090-02 Aneroid w/Adult Cuff, Latex Free
- 5090-06 Aneroid w/Child Cuff, Latex Free
- 5090-37 Aneroid w/Thigh Cuff w/o case, Latex Free
- 5090-41 Aneroid w/Large Adult Cuff, Latex Free

Accessories

- 5090-03 Gauge Only, Latex Free

WELCH ALLYN DURASHOCK™ ECONOMY ANEROID

Latex free.

- DS44-09P Aneroid w/one-piece child print cuff
- DS44-09PCB Aneroid w/child print cuff & bladder
- DS44-10 Aneroid w/one-piece small adult cuff
- DS44-11 Aneroid w/one-piece adult cuff
- DS44-11CB Aneroid w/adult cuff & bladder
- DS44-12 Aneroid w/one-piece large adult cuff
- DS44-12CB Aneroid w/large adult cuff & bladder
- DS44-13CB Aneroid w/thigh cuff & bladder
- DS44-DUR09PF Cuff, Child w/inflation system
- DS44-DUR10F Cuff, Small Adult w/inflation system
- DS44-DUR11F Cuff, Adult w/inflation system
- DS44-DUR12F Cuff, Large Adult w/inflation system
- DS44-MC Cuffs, Family Practice Kit Includes: 1 ea Child, Small Adult, Adult & Large Adult w/inflation system
- DS45-09P Aneroid w/one-piece child print cuff
- DS45-09PCB Aneroid w/child print cuff & bladder
- DS45-10 Aneroid w/small adult cuff
- DS45-11 Aneroid w/adult cuff
- DS45-11CB Aneroid w/adult cuff & bladder
- DS45-12 Aneroid w/large adult cuff
- DS45-12CB Aneroid w/large adult cuff & bladder
- DS45-13CB Aneroid w/thigh cuff & bladder



5082-01H



5082-43



5086-01



5087-01

WELCH ALLYN ANEROID ACCESSORIES & PARTS

- 5082-01 Adult Non-Conductive Cuff
- 5082-01H Adult Cuff, Latex Free, 12/bx
- 5082-02 Child Non-Conductive Cuff
- 5082-03 Infant Cuff w/1-tube bag
- 5082-07 Newborn Cuff w/1-tube bag
- 5082-08 Infant Cuff w/2-tube bag
- 5082-11 Thigh Non-Conductive Cuff
- 5082-16 Large Adult Non-Conductive Cuff
- 5082-16H Large Adult Cuff, Latex Free, 6/bx
- 5082-21 Child Inflation System w/2 tube bag, Latex Free
- 5082-21H Inflation System, Child, Latex Free, 6/bx
- 5082-22 Adult Inflation System w/2 tube bag, Latex Free
- 5082-22H Inflation System, Adult, Latex Free, 6/bx
- 5082-23 Large Adult Inflation System w/2 tube bag, Latex Free
- 5082-23H Inflation System, Large Adult, Latex Free, 6/bx
- 5082-24 Child Cuff w/2-tube bag
- 5082-25 Adult Cuff w/2-tube bag
- 5082-257 Integrated Gauge Adapter Only
- 5082-26 Large Adult Cuff w/2-tube bag
- 5082-42 Child Cuff w/1-tube bag
- 5082-43 Adult Cuff w/1-tube bag
- 5082-44 Large Adult Cuff w/1-tube bag
- 5082-45 Thigh Inflation System
- 5085-07 Sphyg Carrying Case, Polyester
- 5085-08 Two-Sided Sphyg Carrying Case, Polyester
- 5086-01 Latex Inflation Bulb
- 5086-01H Latex Inflation Bulb, Latex Free, 12/bx
- 5086-03H Large Inflation Bulb, Latex Free, 6/bx
- 5087-01 Air Release Valve
- 5087-01H Air Release Valve, Latex Free, 12/bx
- 5087-08 Valve Assembly For Hand Model (after Jan. 1, 1979)
- 5087-09 Valve Thumb Screw For Hand Model (after Jan. 1, 1979)
- 5088-01 Air Release Valve & Bulb
- 5088-01H Bulb & Valve Combination, Latex Free, 12/bx
- 5089-01 Adult Inflation Bags, Non-Conductive, 2 Tubes
- 5089-01H Inflation Bag, Adult, 2 Tubes, Latex Free, 12/bx
- 5089-02 Child Inflation Bags, Non-Conductive, 2 Tubes
- 5089-02H Inflation Bag, Child, 2 Tubes, Latex Free, 12/bx
- 5089-03 Adult Inflation Bags, Non-Conductive, 1 Tube
- 5089-04 Child Inflation Bags, Non-Conductive, 1 Tube
- 5089-09 Metal Y Adaptor
- 5089-11 Metal Twist Fit Connector Set
- 5089-12 Tubing 27" Length
- 5089-13H Coil Tubing 8 ft Length, Latex Free, 12/bx
- 5089-18 Thigh Inflation Bags, Non-Conductive, 1 Tube
- 5089-19 Thigh Inflation Bags, Non-Conductive, 2 Tubes
- 5089-19H Inflation Bag, Thigh, 2 Tubes, Latex Free, 6/bx
- 5089-21 Large Adult Inflation Bags, Non-Conductive, 1 Tube
- 5089-22 Large Adult Inflation Bags, Non-Conductive, 2 Tubes
- 5089-22H Inflation Bag, Large Adult, 2 Tubes, Latex Free, 6/bx
- 5089-25 Infant Inflation Bags, Non-Conductive, 1 Tube
- 5089-26 Infant Inflation Bags, Non-Conductive, 2 Tubes
- 5090-29 Bulb End Valve
- 5090-30 Screen Assembly
- 5090-44 Front Ring Bezel For Aneroid
- 5090-45 Shatterproof Crystal For Aneroid
- 5090-64 Clip Assembly For Pocket Aneroid
- 5091-16 Crystal For Wall Gauge, Square
- 5091-33 Cuff Clip
- 5098-07 Luer Lock (set)
- 5098-17 Housing Screws For Hand Gauge (Packet of 12)
- 7052-25 Printer Paper For 7052-23 Only, 5 rolls/pack
- DS44A Model DS44 Gauge w/integrated gauge adapter only
- DS45A Model DS45 Gauge w/integrated gauge adapter only



5098-27



5098-30

WELCH ALLYN TYCOS® DS66 HAND ANEROID

Latex free. More accurate blood pressure readings & lower lifetime ownership cost due to award-winning design that is gear-free & shock-resistant. Welch Allyn's line of aneroid sphygmomanometers featuring gear-free, shock-resistant DuraShock technology offer practical benefits compared to traditional sphygmomanometers w/gears. This is especially true in busy medical environments where instruments may be handled roughly or dropped. With DuraShock technology, Welch Allyn sphygmomanometers will remain in calibration longer, providing more accurate readings than traditional sphygmomanometers w/gears. They won't need to be replaced as often as traditional gauges w/gears, providing lower lifetime ownership cost. Only Welch Allyn aneroids feature gear-free, shock resistant DuraShock technology to deliver unprecedented durability. The only gauge capable of passing AAMI Shock Resistant standard ensures your sphygmomanometer will remain accurately calibrated longer. Lower lifetime cost of ownership since DuraShock gauges don't need replacing as often due to drops & rough handling. Only Welch Allyn offers a jeweled movement w/an industrial sapphire at the key friction point for long product life. Only Welch Allyn calibrates by computer & laser engraves a unique, custom-matched dial face for unprecedented accuracy over the instrument life. Lighter weight than traditional sphygmomanometers so it won't weigh down your lab coat. 1-piece cuff design is more durable than traditional cuff & bladder systems & it eliminates the need to remove or replace bladders. Latex-free cuff is easy to clean, disinfect, or sterilize for safety. 15-year calibration warranty for overall value.

- 5098-27 Aneroid w/Adult Cuff in Zippered Case, Latex Free Cuff
- 5098-28 Aneroid w/Large Adult Cuff in Zippered Case, Latex Free Cuff
- 5098-29 Aneroid w/Child Cuff in Zippered Case, Latex Free Cuff
- 5098-30 Multi-Cuff Kit, Includes Adult, Large Adult & Child-Print Inflation Systems in Zippered Case, Latex Free Cuff



5091-38



5091-41



5091-13



5091-47

WELCH ALLYN TYCOS® 509 SERIES WALL & MOBILE ANEROIDS

Latex free. Tyco's 509 Series aneroids provide all the accuracy and reliability you expect from Tyco's - at an affordable price. Lifetime calibration and manufacturing warranty. Precision, jeweled bearings resist wear for consistently accurate readings. Unique phosphor-bronze aneroid bellows ensure consistent pressure measurement. Visual check of accuracy on the dial. Strong die-cast zinc internal housing protects mechanism. The Wall style has an 8' coiled tubing with 90° swivel for flexible reading, 10° forward tilt to reduce glare. The Mobile style has 360° swivel with adjustable height stand, and 4' coiled tubing.

- 5091-38 509 Wall Aneroid w/Adult Cuff, Latex Free
- 5091-39 509 Wall Aneroid Manometer Only w/8 ft tubing, Latex Free
- 5091-41 509 Mobile Aneroid w/Adult Cuff, Latex Free

Accessories

- 5091-13 Inflation System Basket, Small, Stainless Steel
- 5091-47 Inflation System Basket, Large, Black
- 5091-48 Mobile Aneroid Stand & Basket Assembly Only
- 7670-05 Mobile Stand Base Weight Only

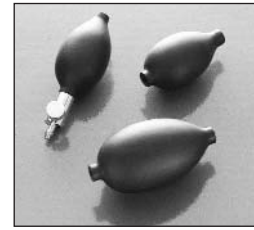

WELCH ALLYN TYCOS® DS66 HAND ANEROID ACCESSORIES

Latex free.

- 5082-18 Child Cuff, Print
- 5082-59 Adult Cuff, Black
- 5082-61 Large Adult Cuff, Black
- 5082-62 Child Print Cuff & Black Inflation Bag
- 5086-04 Bulb Assembly
- 5098-31 Gauge
- 5098-40 Crystal



5098-70



5098-73



5086-05

WELCH ALLYN TYCOS® TR-2 HAND ANEROID

Latex free. Lightweight and compact, the Tyco's TR-2 hand aneroid provides portability in an affordably priced, hand-held design. The trigger-release air valve is positioned for optional left or right-handed use and allows for easy fingertip control of cuff deflation. Large easy-to-read dial face with bright graphics. Balanced palm design allows for comfortable use over repeated measurements. Meets AAMI accuracy standard of $\pm 3\text{mmHg}$. Comes in a zippered case. Five year warranty. All latex free.

- 5098-70 Aneroid w/Adult Cuff
- 5098-71 Aneroid w/Large Adult Cuff
- 5098-72 Aneroid w/Child Print Cuff
- 5098-73 Aneroid Multi-Cuff Kit, Includes Adult, Large Adult & Child Print Cuff

Accessories

- 5082-63 Child Print Cuff
- 5086-05 Bulb Assembly
- 5098-79 Crystal

We offer:

- Great Service
- Great Pricing
- Great Products

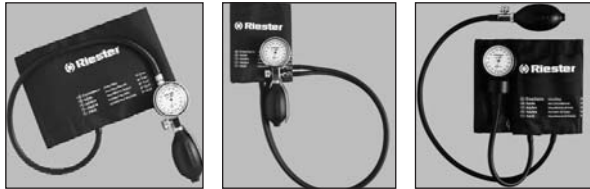

LF1312

LF1342

LF1350

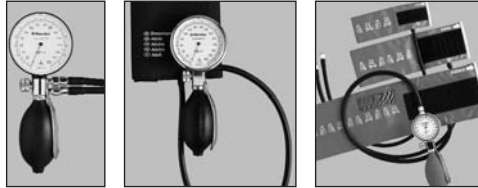

LF1360-107

LF1362

LF1441

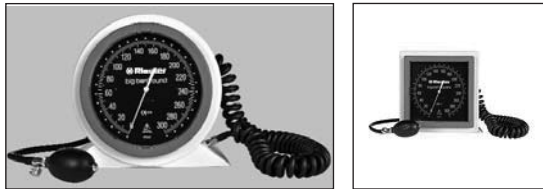

LF1453

LF1456

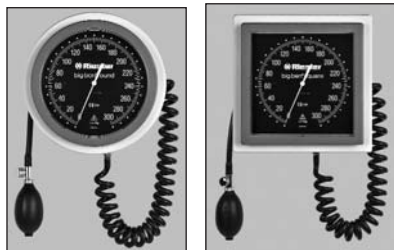

LF1459

LF1465

WELCH ALLYN CONNECTORS & ADAPTORS

1-HP	FlexiPort Fitting, Bayonet Connector, 1-Tube, 10/pk
1-MQ	FlexiPort Fitting, Locking Connector, 1-Tube, 10/pk
1-SC	FlexiPort Fitting, Screw Connector, 1-Tube, 10/pk
1-TP	FlexiPort Fitting, Tri-Purpose Connector, 1-Tube, 10/pk
2-BV	FlexiPort Fitting, Bulb & Valve Inflation System, 2-Tube, 10/pk
2-SC	FlexiPort Fitting, Screw Connector, 2-Tube, 10/pk
2-TP	FlexiPort Fitting, Tri-Purpose Connector, 2-Tube, 10/pk
5082-159	FlexiPort BP Cuff, Wash Cap

WELCH ALLYN TYCOS® TR-2 HOME ANEROID

Latex free. Designed for simple and accurate personal blood pressure monitoring at home or work. Built-in stethoscope chestpiece allows for clear detection of blood pressure sounds with minimal training. Easy-to-use trigger deflation valve provides smooth release of air pressure. D-ring cuff for convenient self-application. Large & bright dial face for easy viewing of numbers. Instructional audio cassette and blood pressure recording forms. Meets AAMI accuracy standard of ± 3 mmHg. Five year warranty. All latex free.

Accessories

5098-74 Gauge & Bulb Only, Latex Free

WELCH ALLYN DISPOSABLE FLEXIPOINT CUFFS

SOFT-06	Cuff, Soft, Small Infant, 20/pk
SOFT-06-1HP	Cuff, Soft, Bayonet Connector, 1-Tube, Small Infant, 20/pk
SOFT-06-1MZ	Cuff, Soft, Locking Connector, 1-Tube, Small Infant, 20/pk
SOFT-06-1SC	Cuff, Soft, Screw Connector, 1-Tube, Small Infant, 20/pk
SOFT-06-1TP	Cuff, Soft, Tri-Purpose Connector, 1-Tube, Small Infant, 20/pk
SOFT-07	Cuff, Soft, Infant, 20/pk
SOFT-07-1HP	Cuff, Soft, Bayonet Connector, 1-Tube, Infant, 20/pk
SOFT-07-1MQ	Cuff, Soft, Locking Connector, 1-Tube, Infant, 20/pk
SOFT-07-1SC	Cuff, Soft, Screw Connector, 1-Tube, Infant, 20/pk
SOFT-07-1TP	Cuff, Soft, Tri-Purpose Connector, 1-Tube, Infant, 20/pk
SOFT-07-2BV	Cuff, Soft, Inflation System, 2-Tube, Infant, 20/pk
SOFT-07-2MQ	Cuff, Soft, Locking Connector, 2-Tube, Infant, 20/pk
SOFT-07-2SC	Cuff, Soft, Screw Connector, 2-Tube, Infant, 20/pk
SOFT-07-2TP	Cuff, Soft, Tri-Purpose Connector, 2-Tube, Infant, 20/pk
SOFT-08	Cuff, Soft, Small Child, 20/pk
SOFT-08-1HP	Cuff, Soft, Bayonet Connector, 1-Tube, Small Child, 20/pk
SOFT-08-1MQ	Cuff, Soft, Locking Connector, 1-Tube, Small Child, 20/pk
SOFT-08-1SC	Cuff, Soft, Screw Connector, 1-Tube, Small Child, 20/pk
SOFT-08-1TP	Cuff, Soft, Tri-Purpose Connector, 1-Tube, Small Child, 20/pk
SOFT-08-2BV	Cuff, Soft, Inflation System, 2-Tube, Small Child, 20/pk
SOFT-08-2MQ	Cuff, Soft, Locking Connector, 2-Tube, Small Child, 20/pk
SOFT-08-2SC	Cuff, Soft, Screw Connector, 2-Tube, Small Child, 20/pk
SOFT-08-2TP	Cuff, Soft, Tri-Purpose Connector, 2-Tube, Small Child, 20/pk
SOFT-09	Cuff, Soft, Child, 20/pk
SOFT-09-1HP	Cuff, Soft, Bayonet Connector, 1-Tube, Child, 20/pk
SOFT-09-1MQ	Cuff, Soft, Locking Connector, 1-Tube, Child, 20/pk
SOFT-09-1SC	Cuff, Soft, Screw Connector, 1-Tube, Child, 20/pk
SOFT-09-1TP	Cuff, Soft, Tri-Purpose Connector, 1-Tube, Child, 20/pk
SOFT-09-2BV	Cuff, Soft, Inflation System, 2-Tube, Child, 20/pk
SOFT-09-2MQ	Cuff, Soft, Locking Connector, 2-Tube, Child, 20/pk
SOFT-09-2SC	Cuff, Soft, Screw Connector, 2-Tube, Child, 20/pk
SOFT-09-2SCC	Cuff, Soft, Screw Connector C, 2-Tube, Child, 20/pk
SOFT-09-2TP	Cuff, Soft, Tri-Purpose Connector, 2-Tube, Child, 20/pk
SOFT-10	Cuff, Soft, Small Adult, 20/pk
SOFT-10-1HP	Cuff, Soft, Bayonet Connector, 1-Tube, Small Adult, 20/pk
SOFT-10-1MQ	Cuff, Soft, Locking Connector, 1-Tube, Small Adult, 20/pk
SOFT-10-1SC	Cuff, Soft, Screw Connector, 1-Tube, Small Adult, 20/pk
SOFT-10-1TP	Cuff, Soft, Tri-Purpose Connector, 1-Tube, Small Adult, 20/pk
SOFT-10-2BV	Cuff, Soft, Inflation System, 2-Tube, Small Adult, 20/pk
SOFT-10-2MQ	Cuff, Soft, Locking Connector, 2-Tube, Small Adult, 20/pk
SOFT-10-2SC	Cuff, Soft, Screw Connector, 2-Tube, Small Adult, 20/pk
SOFT-10-2TP	Cuff, Soft, Tri-Purpose Connector, 2-Tube, Small Adult, 20/pk
SOFT-11	Cuff, Soft, Adult, 20/pk
SOFT-11-1HP	Cuff, Soft, Bayonet Connector, 1-Tube, Adult, 20/pk
SOFT-11-1MQ	Cuff, Soft, Locking Connector, 1-Tube, Adult, 20/pk
SOFT-11-1SC	Cuff, Soft, Screw Connector, 1-Tube, Adult, 20/pk
SOFT-11-1TP	Cuff, Soft, Tri-Purpose Connector, 1-Tube, Adult, 20/pk
SOFT-11-2BV	Cuff, Soft, Inflation System, 2-Tube, Adult, 20/pk
SOFT-11-2MQ	Cuff, Soft, Locking Connector, 2-Tube, Adult, 20/pk
SOFT-11-2SC	Cuff, Soft, Screw Connector, 2-Tube, Adult, 20/pk
SOFT-11-2TP	Cuff, Soft, Tri-Purpose Connector, 2-Tube, Adult, 20/pk
SOFT-11L	Cuff, Soft, Adult, Long, 20/pk
SOFT-11L-1HP	Cuff, Soft, Bayonet Connector, 1-Tube, Adult, Long, 20/pk
SOFT-11L-1MQ	Cuff, Soft, Locking Connector, 1-Tube, Adult, Long, 20/pk
SOFT-11L-1SC	Cuff, Soft, Screw Connector, 1-Tube, Adult, Long, 20/pk
SOFT-11L-1TP	Cuff, Soft, Tri-Purpose Connector, 1-Tube, Adult, Long, 20/pk
SOFT-11L-2BV	Cuff, Soft, Inflation System, 2-Tube, Adult, Long, 20/pk
SOFT-11L-2MQ	Cuff, Soft, Locking Connector, 2-Tube, Adult, Long, 20/pk
SOFT-11L-2SC	Cuff, Soft, Screw Connector, 2-Tube, Adult, Long, 20/pk
SOFT-11L-2TP	Cuff, Soft, Tri-Purpose Connector, 2-Tube, Adult, Long, 20/pk
SOFT-12	Cuff, Soft, Large Adult, 20/pk
SOFT-12-1HP	Cuff, Soft, Bayonet Connector, 1-Tube, Large Adult, 20/pk

Sphygmomanometers

WELCH ALLYN DISPOSABLE FLEXIPOINT CUFFS (Continued)

SOFT-12-1MQ	Cuff, Soft, Locking Connector, 1-Tube, Large Adult, 20/pk
SOFT-12-1SC	Cuff, Soft, Screw Connector, 1-Tube, Large Adult, 20/pk
SOFT-12-1TP	Cuff, Soft, Tri-Purpose Connector, 1-Tube, Large Adult, 20/pk
SOFT-12-2BV	Cuff, Soft, Inflation System, 2-Tube, Large Adult, 20/pk
SOFT-12-2MQ	Cuff, Soft, Locking Connector, 2-Tube, Large Adult, 20/pk
SOFT-12-2SC	Cuff, Soft, Screw Connector, 2-Tube, Large Adult, 20/pk
SOFT-12-2TP	Cuff, Soft, Tri-Purpose Connector, 2-Tube, Large Adult, 20/pk
SOFT-12L	Cuff, Soft, Large Adult, 20/pk
SOFT-12L-1HP	Cuff, Soft, Bayonet Connector, 1-Tube, Large Adult, Long, 20/pk
SOFT-12L-1MQ	Cuff, Soft, Locking Connector, 1-Tube, Large Adult, Long, 20/pk
SOFT-12L-1SC	Cuff, Soft, Screw Connector, 1-Tube, Large Adult, Long, 20/pk
SOFT-12L-1TP	Cuff, Soft, Tri-Purpose Connector, 1-Tube, Large Adult, Long, 20/pk
SOFT-12L-2BV	Cuff, Soft, Inflation System, 2-Tube, Large Adult, Long, 20/pk
SOFT-12L-2MQ	Cuff, Soft, Locking Connector, 2-Tube, Large Adult, Long, 20/pk
SOFT-12L-2SC	Cuff, Soft, Screw Connector, 2-Tube, Large Adult, Long, 20/pk
SOFT-12L-2TP	Cuff, Soft, Tri-Purpose Connector, 2-Tube, Large Adult, Long, 20/pk
SOFT-13	Cuff, Soft, Thigh, 20/pk
SOFT-13-1HP	Cuff, Soft, Bayonet Connector, 1-Tube, Thigh, 20/pk
SOFT-13-1MQ	Cuff, Soft, Locking Connector, 1-Tube, Thigh, 20/pk
SOFT-13-1SC	Cuff, Soft, Screw Connector, 1-Tube, Thigh, 20/pk
SOFT-13-1TP	Cuff, Soft, Tri-Purpose Connector, 1-Tube, Thigh, 20/pk
SOFT-13-2BV	Cuff, Soft, Inflation System, 2-Tube, Thigh, 20/pk
SOFT-13-2MQ	Cuff, Soft, Locking Connector, 2-Tube, Thigh, 20/pk
SOFT-13-2SC	Cuff, Soft, Screw Connector, 2-Tube, Thigh, 20/pk
SOFT-13-2TP	Cuff, Soft, Tri-Purpose Connector, 2-Tube, Thigh, 20/pk

WELCH ALLYN REUSABLE FLEXIPOINT CUFFS

REUSE-06	Cuff, Reusable, Small Infant
REUSE-06-1HP	Cuff, Reusable, Bayonet Connector, 1-Tube, Small Infant
REUSE-06-1MQ	Cuff, Reusable, Locking Connector, 1-Tube, Small Infant
REUSE-06-1SC	Cuff, Reusable, Screw Connector, 1-Tube, Small Infant
REUSE-06-1TP	Cuff, Reusable, Tri-Purpose Connector, 1-Tube, Small Infant
REUSE-07	Cuff, Reusable, Infant
REUSE-07-1HP	Cuff, Reusable, Bayonet Connector, 1-Tube, Infant
REUSE-07-1MQ	Cuff, Reusable, Locking Connector, 1-Tube, Infant
REUSE-07-1SC	Cuff, Reusable, Screw Connector, 1-Tube, Infant
REUSE-07-1TP	Cuff, Reusable, Tri-Purpose Connector, 1-Tube, Infant
REUSE-07-2BV	Cuff, Reusable, Inflation System, 2-Tube, Infant
REUSE-07-2MQ	Cuff, Reusable, Locking Connector, 2-Tube, Infant
REUSE-07-2SC	Cuff, Reusable, Screw Connector, 2-Tube, Infant
REUSE-07-2TP	Cuff, Reusable, Tri-Purpose Connector, 2-Tube, Infant
REUSE-08	Cuff, Reusable, Small Child
REUSE-08-1HP	Cuff, Reusable, Bayonet Connector, 1-Tube, Small Child
REUSE-08-1MQ	Cuff, Reusable, Locking Connector, 1-Tube, Small Child
REUSE-08-1SC	Cuff, Reusable, Screw Connector, 1-Tube, Small Child
REUSE-08-1TP	Cuff, Reusable, Tri-Purpose Connector, 1-Tube, Small Child
REUSE-08-2BV	Cuff, Reusable, Inflation System, 2-Tube, Small Child
REUSE-08-2MQ	Cuff, Reusable, Locking Connector, 2-Tube, Small Child
REUSE-08-2SC	Cuff, Reusable, Screw Connector, 2-Tube, Small Child
REUSE-08-2TP	Cuff, Reusable, Tri-Purpose Connector, 2-Tube, Small Child
REUSE-09	Cuff, Reusable, Child
REUSE-09-1HP	Cuff, Reusable, Bayonet Connector, 1-Tube, Child
REUSE-09-1MQ	Cuff, Reusable, Locking Connector, 1-Tube, Child
REUSE-09-1SC	Cuff, Reusable, Screw Connector, 1-Tube, Child
REUSE-09-1TP	Cuff, Reusable, Tri-Purpose Connector, 1-Tube, Child

WELCH ALLYN REUSABLE FLEXIPOINT CUFFS (Continued)

REUSE-09-2BV	Cuff, Reusable, Inflation System, 2-Tube, Child
REUSE-09-2MQ	Cuff, Reusable, Locking Connector, 2-Tube, Child
REUSE-09-2SC	Cuff, Reusable, Screw Connector, 2-Tube, Child
REUSE-09-2TP	Cuff, Reusable, Tri-Purpose Connector, 2-Tube, Child
REUSE-10	Cuff, Reusable, Small Adult
REUSE-10-1HP	Cuff, Reusable, Bayonet Connector, 1-Tube, Small Adult
REUSE-10-1MQ	Cuff, Reusable, Locking Connector, 1-Tube, Small Adult
REUSE-10-1SC	Cuff, Reusable, Screw Connector, 1-Tube, Small Adult
REUSE-10-1TP	Cuff, Reusable, Tri-Purpose Connector, 1-Tube, Small Adult
REUSE-10-2BV	Cuff, Reusable, Inflation System, 2-Tube, Small Adult
REUSE-10-2MQ	Cuff, Reusable, Locking Connector, 2-Tube, Small Adult
REUSE-10-2SC	Cuff, Reusable, Screw Connector, 2-Tube, Small Adult
REUSE-10-2TP	Cuff, Reusable, Tri-Purpose Connector, 2-Tube, Small Adult
REUSE-11	Cuff, Reusable, Adult
REUSE-11-1HP	Cuff, Reusable, Bayonet Connector, 1-Tube, Adult
REUSE-11-1MQ	Cuff, Reusable, Locking Connector, 1-Tube, Adult
REUSE-11-1SC	Cuff, Reusable, Screw Connector, 1-Tube, Adult
REUSE-11-1TP	Cuff, Reusable, Tri-Purpose Connector, 1-Tube, Adult
REUSE-11-2BV	Cuff, Reusable, Inflation System, 2-Tube, Adult
REUSE-11-2MQ	Cuff, Reusable, Locking Connector, 2-Tube, Adult
REUSE-11-2SC	Cuff, Reusable, Screw Connector, 2-Tube, Adult
REUSE-11-2TP	Cuff, Reusable, Tri-Purpose Connector, 2-Tube, Adult
REUSE-11L	Cuff, Reusable, Adult, Long
REUSE-11L-1HP	Cuff, Reusable, Bayonet Connector, 1-Tube, Adult, Long
REUSE-11L-1MQ	Cuff, Reusable, Locking Connector, 1-Tube, Adult, Long
REUSE-11L-1SC	Cuff, Reusable, Screw Connector, 1-Tube, Adult, Long
REUSE-11L-1TP	Cuff, Reusable, Tri-Purpose Connector, 1-Tube, Adult, Long
REUSE-11L-2BV	Cuff, Reusable, Inflation System, 2-Tube, Adult, Long
REUSE-11L-2MQ	Cuff, Reusable, Locking Connector, 2-Tube, Adult, Long
REUSE-11L-2SC	Cuff, Reusable, Screw Connector, 2-Tube, Adult, Long
REUSE-11L-2TP	Cuff, Reusable, Tri-Purpose Connector, 2-Tube, Adult, Long
REUSE-12	Cuff, Reusable, Large Adult
REUSE-12-1HP	Cuff, Reusable, Bayonet Connector, 1-Tube, Large Adult
REUSE-12-1MQ	Cuff, Reusable, Locking Connector, 1-Tube, Large Adult
REUSE-12-1SC	Cuff, Reusable, Screw Connector, 1-Tube, Large Adult
REUSE-12-1TP	Cuff, Reusable, Tri-Purpose Connector, 1-Tube, Large Adult
REUSE-12-2BV	Cuff, Reusable, Inflation System, 2-Tube, Large Adult
REUSE-12-2MQ	Cuff, Reusable, Locking Connector, 2-Tube, Large Adult
REUSE-12-2SC	Cuff, Reusable, Screw Connector, 2-Tube, Large Adult
REUSE-12-2TP	Cuff, Reusable, Tri-Purpose Connector, 2-Tube, Large Adult
REUSE-12L	Cuff, Reusable, Large Adult, Long
REUSE-12L-1HP	Cuff, Reusable, Bayonet Connector, 1-Tube, Large Adult, Long
REUSE-12L-1MQ	Cuff, Reusable, Locking Connector, 1-Tube, Large Adult, Long
REUSE-12L-1SC	Cuff, Reusable, Screw Connector, 1-Tube, Large Adult, Long
REUSE-12L-1TP	Cuff, Reusable, Tri-Purpose Connector, 1-Tube, Large Adult, Long
REUSE-12L-2BV	Cuff, Reusable, Inflation System, 2-Tube, Large Adult, Long
REUSE-12L-2MQ	Cuff, Reusable, Locking Connector, 2-Tube, Large Adult, Long
REUSE-12L-2SC	Cuff, Reusable, Screw Connector, 2-Tube, Large Adult, Long
REUSE-12L-2TP	Cuff, Reusable, Tri-Purpose Connector, 2-Tube, Large Adult, Long
REUSE-13	Cuff, Reusable, Thigh
REUSE-13-1HP	Cuff, Reusable, Bayonet Connector, 1-Tube, Thigh
REUSE-13-1MQ	Cuff, Reusable, Locking Connector, 1-Tube, Thigh
REUSE-13-1SC	Cuff, Reusable, Screw Connector, 1-Tube, Thigh
REUSE-13-1TP	Cuff, Reusable, Tri-Purpose Connector, 1-Tube, Thigh
REUSE-13-2BV	Cuff, Reusable, Inflation System, 2-Tube, Thigh
REUSE-13-2MQ	Cuff, Reusable, Locking Connector, 2-Tube, Thigh
REUSE-13-2SC	Cuff, Reusable, Screw Connector, 2-Tube, Thigh
REUSE-13-2TP	Cuff, Reusable, Tri-Purpose Connector, 2-Tube, Thigh

WELCH ALLYN PLATINUM SERIES DS58 HAND ANEROIDS

Maintain accurate blood pressure readings with lower lifetime cost with gear-free DuraShock™ technology. Part of our Platinum Series, this premium gauge provides unsurpassed reliability in a traditional handheld design. Super shock-resistant — can withstand up to 60° drop (twice the AAMI “Shock Resistant” standard) and remain in calibration. Jewel movement for long life. Laser-engraved dial face for accuracy. Premium inflation system for comfort. Ergonomic inflation bulb enhances user comfort. Lifetime calibration warranty. Lighter weight than traditional models — won’t weigh down your lab coat. Premium aesthetics. Latex-free.

DS58-11	Aneroid, Gauge w/adult duable 2 piece cuff & nylon zipper case (replaces 5098-02)
DS58-MCCB	Aneroid, Gauge w/family practice kit w/cuff & bladder, Includes Large Adult, Adult & Child Cuffs (replaces 5098-23C)



ADC ADTOON™ PRO'S COMBO II POCKET ANEROID KIT

Take our best selling aneroid and add an oversized 2 compartment matching nylon case with color coordinated Sprague type scope and you have the ultra-popular Adtoon™ Pro's Combo. Contemporary black enamel 300mmHg no-pin stop manometer. Adtoon™ nylon cuff with ADC's proprietary Size Guide™ marking system prevents mis-cuffing. Latex inflation bladder and bulb. Chrome-plated deflation valve. Complete aneroid, matching case, and color-matched Sprague stethoscope Sprague colors: Peanuts/Frosted Glacier, Garfield/Purple, Betty Boop/Royal Blue, Hello Kitty/Frosted Lilac. Assembled, inspected, and packaged in the U.S.A. from foreign components.

768-641B00	Combo 768/641 Kit, Adult, Betty Boop
768-641B00LF	Combo 768/641 Kit, Adult, Betty Boop, LF
768-641GAR	Combo 768/641 Kit, Adult, Garfield
768-641GARLF	Combo 768/641 Kit, Adult, Garfield, LF
768-641HK	Combo 768/641 Kit, Adult, Hello Kitty
768-641HKLF	Combo 768/641 Kit, Adult, Hello Kitty, LF
768-641PEA	Combo 768/641 Kit, Adult, Peanuts
768-641PEALF	Combo 768/641 Kit, Adult, Peanuts, LF

ADC ADTOON™ CARRY CASES

Choose from standard or premium zippered carry cases in choice of pattern. 210 denier nylon construction. Rugged self repairing nylon zipper with oversized pull.

880B00	Zipper Bag Standard, Betty Boop
880GAR	Zipper Bag Standard, Garfield
880HK	Zipper Bag Standard, Hello Kitty
880PEA	Zipper Bag Standard, Peanuts
888HK	Dix Nylon Zipper Case 10 x 6 x 3, Hello Kitty

ADC ADVANTAGE™ 6012 SEMI-AUTOMATIC BP MONITOR

Compact and easy-to-use. Measures systolic, diastolic pressure and pulse. Manual inflation. Self adjusting latex free D-bar cuff. Automatic deflation valve. Auto off.

6012	Advantage™ 6012 BP Monitor
------	----------------------------

ADC ADVANTAGE™ 6013 AUTOMATIC BP MONITOR

Smart Logic™ Technology determines ideal inflation level. Measures systolic, diastolic pressure, and pulse. Automatic inflation and deflation control. Self adjusting latex free D-bar cuff. Recalls last 14 readings with date and time stamp. Auto off. Optional AC adapter (sold separately).

6013	Advantage™ 6013 BP Monitor, 9" to 13" Limb Range
6013SA	Advantage™ 6013 BP Monitor, 7.5" to 9.4" Limb Range
6013X	Advantage™ 6013 BP Monitor, 13" to 17" Limb Range

ADC ADVANTAGE™ BP MONITOR ACCESSORIES

6013ZAC	AC Adapter For 6013, 6014, 6014P
6014P	Printer For 6014 & 6016 Monitors
6014PAPER	Paper For 6014P Printer, 5/pkg
850-6013	Cuff & Bladder, Adult For 6013 BP Monitor, Navy, Latex Free
850-6013SA	Cuff and Bladder, Adult for 6013SA BP Monitor, Navy, Latex Free
850-6013X	Cuff & Bladder, Large Adult For 6013 BP Monitor, Navy, Latex Free

ADC ADVANTAGE™ 6014 ADVANCED BP MONITOR

Smart Logic™ Technology determines ideal inflation level. Measures systolic, diastolic pressure, and pulse. Automatic inflation and deflation control. Average mode automatically averages three readings for more meaningful results. Self adjusting latex free D-bar cuff. Advanced two zone memory with date and time stamp recalls last 30 readings for two different people. Auto off. Optional thermal printer (sold separately). Optional AC adapter (sold separately).

6014	Advantage™ 6014 BP Monitor
------	----------------------------

ADC ADVANTAGE™ 6015 DIGITAL WRIST BP MONITOR

Smart Logic™ Technology determines ideal inflation level. Measures systolic, diastolic pressure, and pulse. Latex free wrist cuff fits 5" to 7" wrists. Recalls last 90 readings. Auto off. Compact storage case.

6015	Advantage™ 6015 BP Monitor
------	----------------------------

ADC ADVANTAGE™ 6016 DIGITAL WRIST BP MONITOR

Smart Logic™ Technology determines ideal inflation level. Measures systolic, diastolic pressure, and pulse. New 8 bit microprocessor and advanced algorithm for more accurate readings. Average mode automatically averages three readings for more meaningful results. Latex free wrist cuff fits 5" to 7" wrists. Advanced two zone memory with date and time stamp recalls last 30 readings for two different people. Auto off. Compact storage case. Optional thermal printer (sold separately).

6016	Advantage™ 6016 BP Monitor
------	----------------------------



ADC DIAGNOSTIX™ 700 SERIES POCKET ANEROID

Heavily chrome plated precision crafted 300mmHg no-pin stop manometer. Luminescent dial features bold white numerals and extended graduation marks on contrasting black face. ADCUFF™ nylon cuff with ADC's proprietary Size Guide™ marking system ensures proper cuff positioning and use of correct cuff size. Cuff includes convenient gauge holder. ADFLOW™ chrome plated brass air release valve with filter screen protection permits precise deflation control and years of reliable service. Complete with leatherette zippered carrying case with nylon zipper. Assembled, inspected, and packaged in the U.S.A. Two year inflation system warranty. Lifetime calibration warranty. Latex free units are completely free of any latex.

- | | |
|---------|---|
| 700 | Adult Pocket Aneroid, Black, Latex |
| 700BD | Adult Pocket Aneroid, Burgundy, Latex |
| 700BDLF | Adult Pocket Aneroid, Burgundy, Latex Free |
| 700C | Child Pocket Aneroid, Black, Latex |
| 700CLF | Child Pocket Aneroid, Black, Latex Free |
| 700DB | Adult Pocket Aneroid, Navy, Latex |
| 700DBLF | Adult Pocket Aneroid, Navy, Latex Free |
| 700DG | Adult Pocket Aneroid, Dark Green, Latex |
| 700DGLF | Adult Pocket Aneroid, Dark Green, Latex Free |
| 700I | Infant Pocket Aneroid, Black, Latex |
| 700ILF | Infant Pocket Aneroid, Black, Latex Free |
| 700LF | Adult Pocket Aneroid, Black, Latex Free |
| 700M | Adult Pocket Aneroid, Magenta, Latex |
| 700MLF | Adult Pocket Aneroid, Magenta, Latex Free |
| 700N | Newborn Pocket Aneroid, Black, Latex |
| 700RB | Adult Pocket Aneroid, Royal, Latex |
| 700RBLF | Adult Pocket Aneroid, Royal, Latex Free |
| 700T | Thigh Pocket Aneroid, Black, Latex |
| 700TL | Adult Pocket Aneroid, Teal, Latex |
| 700TLF | Thigh Pocket Aneroid, Black, Latex Free |
| 700TLLF | Adult Pocket Aneroid, Teal, Latex Free |
| 700V | Adult Pocket Aneroid, Purple, Latex |
| 700VLF | Adult Pocket Aneroid, Purple, Latex Free |
| 700X | Large Adult Pocket Aneroid, Black, Latex |
| 700XLF | Large Adult Pocket Aneroid, Black, Latex Free |
| 711 | Adult Pocket Aneroid, Gray, Latex |
| 711LF | Adult Pocket Aneroid, Gray, Latex Free |
| 714 | Adult Pocket Aneroid, Green, Latex |
| 714LF | Adult Pocket Aneroid, Green, Latex Free |
| 715 | Adult Pocket Aneroid, Red, Latex |
| 715LF | Adult Pocket Aneroid, Red, Latex Free |
| 716 | Adult Pocket Aneroid, Orange, Latex |
| 716LF | Adult Pocket Aneroid, Orange, Latex Free |

Accessories

- | | |
|-----|--|
| 800 | Gauge For DIAGNOSTIX 700 & 778 Series |
| 893 | Gauge Crystal For 800 Gauge |
| 895 | Gauge Retaining Ring For 800 Gauge |
| 898 | Spring/Clip/Pin Assembly For 800 Gauge |



ADC DIAGNOSTIX™ 703 SERIES SPHYGMOMANOMETER

Revolutionary palm style manometer (#804) with integral latex free bulb and trigger style release valve for one hand convenience. Precision crafted 300mmHg no-pin stop German mechanism tested to 200,000 cycles. Mechanism housed in a patented double shell ABS impact polymer casing. Ambidextrous infinite control trigger release air valve. Quick release luer slip connector. Six clinical cuff sizes available. ADCUFF™ nylon cuff with Size Guide™ marking system ensures proper cuff positioning and use of correct cuff size. Dip molded inflation bladder withstands heavy use. Complete with leatherette zippered carrying case with nylon zipper. Assembled, inspected, and packaged in the U.S.A from foreign components. Two year inflation system warranty. Lifetime calibration warranty. Aneroids completely latex free have a LF in their number.

- | | |
|---------|--|
| 703 | Adult Aneroid, Black, Latex |
| 703BD | Adult Aneroid, Burgundy, Latex |
| 703BDLF | Adult Aneroid, Burgundy, Latex Free |
| 703C | Child Aneroid, Black, Latex |
| 703CLF | Child Aneroid, Black, Latex Free |
| 703DB | Adult Aneroid, Navy, Latex |
| 703DBLF | Adult Aneroid, Navy, Latex Free |
| 703DG | Adult Aneroid, Dark Green, Latex |
| 703DGLF | Adult Aneroid, Dark Green, Latex Free |
| 703G | Adult Aneroid, Gray, Latex |
| 703GLF | Adult Aneroid, Gray, Latex Free |
| 703GR | Adult Aneroid, Green, Latex |
| 703GRLF | Adult Aneroid, Green, Latex Free |
| 703I | Infant Aneroid, Black, Latex |
| 703ILF | Infant Aneroid, Black, Latex Free |
| 703LF | Adult Aneroid, Black, Latex Free |
| 703M | Adult Aneroid, Magenta, Latex |
| 703MLF | Adult Aneroid, Magenta, Latex Free |
| 703N | Newborn Aneroid, Black, Latex |
| 703OR | Adult Aneroid, Orange, Latex |
| 703ORLF | Adult Aneroid, Orange, Latex Free |
| 703R | Adult Aneroid, Red, Latex |
| 703RB | Adult Aneroid, Royal Blue, Latex |
| 703RBLF | Adult Aneroid, Royal Blue, Latex Free |
| 703RLF | Adult Aneroid, Red, Latex Free |
| 703T | Thigh Aneroid, Black, Latex |
| 703TL | Adult Aneroid, Teal, Latex |
| 703TLF | Thigh Aneroid, Black, Latex Free |
| 703TLLF | Adult Aneroid, Teal, Latex Free |
| 703V | Adult Aneroid, Purple, Latex |
| 703VLF | Adult Aneroid, Purple, Latex Free |
| 703X | Large Adult Aneroid, Black, Latex |
| 703XLF | Large Adult Aneroid, Black, Latex Free |

Accessories

- | | |
|---------|--|
| 804 | Gauge For 703, 705, 731, 732, 740 & 788 Series |
| 804-100 | Gauge Crystal For 804 |
| 804-103 | Crystal Retaining Ring For 804 |
| 804-109 | Bulb For 804 Palm Aneroid Only |
| 804C | Screw Connector For 804 Gauge Only |



ADC DIAGNOSTIX™ 720 SERIES SPHYGMOMANOMETER

Offering more features than any other sphyg in its class, the 720 provides out finest value. Precision crafted 300mmHg no-pin stop manometer with classic black baked enamel finish, exceeds industry standards. Extended scaleplate graduation marks reduce parallax for easier viewing from virtually any angle. Adcuff™ nylon cuff with ADC's propriety Size Guide™ marking system prevents mis-cuffing. Dip molded latex or latex-free inflation bladder withstands heavy use. Latex or latex-free inflation bulb, fitted with filter screen end valve to reduce dust build-up. Adflow™ chrome-plated brass air release valve for precise deflation control. Leatherette carrying case with durable nylon zipper. Two year inflation system warranty. Lifetime calibration warranty. Assembled, inspected, and packaged in the U.S.A. from foreign components.

720BD	Adult Aneroid, Burgundy, Latex
720BDLF	Adult Aneroid, Burgundy, Latex Free
720C	Child Aneroid, Black, Latex
720CLF	Child Aneroid, Black, Latex Free
720DB	Adult Aneroid, Navy, Latex
720DBLF	Adult Aneroid, Navy, Latex Free
720DG	Adult Aneroid, Dark Green, Latex
720DGLF	Adult Aneroid, Dark Green, Latex Free
720I	Infant Aneroid, Black, Latex
720ILF	Infant Aneroid, Black, Latex Free
720LF	Adult Aneroid, Black, Latex Free
720M	Adult Aneroid, Magenta, Latex
720MLF	Adult Aneroid, Magenta, Latex Free
720N	Newborn Aneroid, Black, Latex
720RB	Adult Aneroid, Royal Blue, Latex
720RBLF	Adult Aneroid, Royal Blue, Latex Free
720T	Thigh Aneroid, Black, Latex
720TL	Adult Aneroid, Teal, Latex
720TLF	Thigh Aneroid, Black, Latex Free
720TLF	Adult Aneroid, Teal, Latex Free
720V	Adult Aneroid, Purple, Latex
720VLF	Adult Aneroid, Purple, Latex Free
720X	Large Adult Aneroid, Black, Latex
720XLF	Large Adult Aneroid, Black, Latex Free
721	Adult Aneroid, Gray, Latex
721LF	Adult Aneroid, Gray, Latex Free
724	Adult Aneroid, Green, Latex
724LF	Adult Aneroid, Green, Latex Free
725	Adult Aneroid, Red, Latex
725LF	Adult Aneroid, Red, Latex Free
726	Adult Aneroid, Orange, Latex
726LF	Adult Aneroid, Orange, Latex Free

Accessories

802	Gauge Only, Latex Free
893-1	Gauge Crystal For 802 Gauge
895-1	Gauge Retaining Ring For 802 Gauge
898-1	Spring/Clip/Pin Assembly For 802 Gauge



750CW



752CM



752M

ADC DIAGNOSTIX™ 750 SERIES ANEROID

Large, easy to read 6" dial with white scale on contrasting black face for high visibility. Luminescent dial for visibility in low light conditions. Lifetime calibration warranty. Contemporary Euro-style black ivory casing complements any decor. Rear mounting bracket doubles as an inflation system storage compartment. ADCUFF™ inflation system with black nylon cuff, Size Guide™ marking system, premium latex bladder and bulb and 8' (when extended) coiled tubing with luer connectors. Includes all necessary hardware and instructions. Wall bracket swivels through 110° arc for enhanced visibility. Includes an ABS cuff storage compartment in main unit.

750CW	Child Wall-Mounted Aneroid, Black, Latex
750CWLF	Child Wall-Mounted Aneroid, Black, Latex Free
750IW	Infant Wall-Mounted Aneroid, Black, Latex
750IWL	Infant Wall-Mounted Aneroid, Black, Latex Free
750NW	Newborn Wall-Mounted Aneroid, Black, Latex
750TW	Thigh Wall-Mounted Aneroid, Black, Latex
750TWLF	Thigh Wall-Mounted Aneroid, Black, Latex Free
750W	Adult Wall-Mounted Aneroid, Black, Latex
750WLF	Adult Wall-Mounted Aneroid, Black, Latex Free
750XV	Large Adult Wall-Mounted Aneroid, Black, Latex
750XWLF	Large Adult Wall-Mounted Aneroid, Black, Latex Free
752CM	Child Mobile Aneroid, Black, Latex
752CMLF	Child Mobile Aneroid, Black, Latex Free
752IM	Infant Mobile Aneroid, Black, Latex
752IMLF	Infant Mobile Aneroid, Black, Latex Free
752M	Adult Mobile Aneroid, Black, Latex
752MLF	Adult Mobile Aneroid, Black, Latex Free
752NM	Newborn Mobile Aneroid, Black, Latex
752TM	Thigh Mobile Aneroid, Black, Latex
752TMLF	Thigh Mobile Aneroid, Black, Latex Free
752XM	Large Adult Mobile Aneroid, Black, Latex
752XMLF	Large Adult Mobile Aneroid, Black, Latex Free

Accessories

805	Gauge For 750 Series
896	Gauge Crystal For 805 Gauge

**Please ask before
ordering a product based
on the pictured item.**



ADC DIAGNOSTIX™ 922 SERIES SPHYGMOMANOMETER

Rugged diecast aluminum housing with textured black baked enamel finish complements any decor. Fold down cover with spring lock mechanism. Graduated unbreakable plastic cartridge tube features 4.00mm inside bore for unrestricted, friction-free mercury flow. High visibility red graduations. Filter system keeps mercury clean for reliable performance. Locking reservoir secures mercury during storage, transport, or maintenance. ADCUFF™ black nylon cuff with ADC's proprietary Size Guide™ marking system ensures proper cuff positioning and use of correct cuff size. Dip molded latex inflation bladder withstands heavy use. Latex inflation bulb fitted with filter screen end valve reduces dust build-up. ADFLOW™ chrome plated brass air release valve with filter screen protection permits precise deflation control and years of reliable service. Comprehensive owner's manual. Assembled, inspected, and packaged in the U.S.A. from foreign components. Two year inflation system warranty. Lifetime warranty on cartridge tube.

- 922 Adult Sphygmomanometer, Black, Latex
- 922C Child Sphygmomanometer, Black, Latex
- 922CLF Child Sphygmomanometer, Black, Latex Free
- 922I Infant Sphygmomanometer, Black, Latex
- 922ILF Infant Sphygmomanometer, Black, Latex Free
- 922LF Adult Sphygmomanometer, Black, Latex Free
- 922N Newborn Sphygmomanometer, Black, Latex
- 922T Thigh Sphygmomanometer, Black, Latex
- 922TLF Thigh Sphygmomanometer, Black, Latex Free
- 922X Large Adult Sphygmomanometer, Black, Latex
- 922XLF Large Adult Sphygmomanometer, Black, Latex Free

Accessories

- 922-00 Manometer Only For 922, Latex Free
- 922-126 Plastic Cartridge Tube For 922, Latex Free

ADC DIAGNOSTIX™ 932 SERIES SPHYGMOMANOMETER

Rugged housing constructed from a combination of virtually indestructible ABS and diecast aluminum. Striking black finish complements any decor. Contemporary upright design with weighted base and integral wire inflation system basket. Graduated unbreakable plastic cartridge tube features a massive 5.00mm inside bore for unrestricted, friction-free mercury flow. White oversized numerals on contrasting black scale combined with high visibility red graduations for easy reading. EZ-Tube™ system allows safe, simplified maintenance of the cartridge tube or top cap filters. Additional safety provided by the locking reservoir which secures mercury for transport or maintenance. ADCUFF™ black nylon cuff with ADC's proprietary Size Guide™ marking system ensures proper cuff positioning and use of correct cuff size. Dip molded latex inflation bladder withstands heavy use. Latex inflation bulb fitted with filter screen end valve reduces dust build-up. ADFLOW™ chrome plated brass air release valve with filter screen protection permits precise deflation control. Comprehensive owner's manual. Assembled, inspected, and packaged in the U.S.A. from foreign components. Two year inflation system warranty. Lifetime warranty on cartridge tube.

- 932 Adult Sphygmomanometer, Black, Latex
- 932C Child Sphygmomanometer, Black, Latex
- 932CLF Child Sphygmomanometer, Black, Latex Free
- 932I Infant Sphygmomanometer, Black, Latex
- 932ILF Infant Sphygmomanometer, Black, Latex Free
- 932LF Adult Sphygmomanometer, Black, Latex Free
- 932N Newborn Sphygmomanometer, Black, Latex
- 932T Thigh Sphygmomanometer, Black, Latex
- 932TLF Thigh Sphygmomanometer, Black, Latex Free
- 932X Large Adult Sphygmomanometer, Black, Latex
- 932XLF Large Adult Sphygmomanometer, Black, Latex Free



ADC DIAGNOSTIX™ 952B SERIES SPHYGMOMANOMETER

Rugged diecast aluminum housing. Striking black finish complements any decor. Graduated unbreakable plastic cartridge tube (recessed for safety) features 5.00mm inside bore for unrestricted, friction-free mercury flow. Wall bracket swivels through 110° arc for enhanced visibility and viewer comfort. EZ-Tube™ system allows safe, simplified maintenance of the cartridge tube or top cap filters. Locking reservoir secures mercury during transport or maintenance. ADCUFF™ nylon cuff with ADC's proprietary Size Guide™ marking system ensures proper cuff positioning and use of correct cuff size. Complete with vinyl coated wire cuff basket, 8 ft length (when extended) of coiled tubing, all mounting hardware and comprehensive owner's manual. Assembled, inspected and packaged in the U.S.A. Two year inflation system warranty. Lifetime warranty on cartridge tube.

- 952B Adult Sphygmomanometer, Black, Latex
- 952BC Child Sphygmomanometer, Black, Latex
- 952BCLF Child Sphygmomanometer, Black, Latex Free
- 952BI Infant Sphygmomanometer, Black, Latex
- 952BILF Infant Sphygmomanometer, Black, Latex Free
- 952BLF Adult Sphygmomanometer, Black, Latex Free
- 952BN Newborn Sphygmomanometer, Black, Latex
- 952BT Thigh Sphygmomanometer, Black, Latex
- 952BTLF Thigh Sphygmomanometer, Black, Latex Free
- 952BX Large Adult Sphygmomanometer, Black, Latex
- 952BXLF Large Adult Sphygmomanometer, Black, Latex Free

Accessories

- 952-025 Cuff Storage Basket For 952
- 952-129 Plastic Cartridge Tube For 952
- 952B-00 Manometer Only

**Your sales representative
can assist you with
product information and
current pricing.**



ADC DIAGNOSTIX™ 972 SERIES SPHYGMOMANOMETER

Rugged housing constructed of a combination of virtually indestructible ABS and diecast aluminum. Striking black finish complements any decor. Graduated unbreakable plastic cartridge tube features a massive 5.00mm inside bore for unrestricted, friction-free mercury flow. White oversized numerals on contrasting black scale combined with high visibility red graduations for easy reading. EZ-Tube™ system allows safe, simplified maintenance of the cartridge tube or top cap filters. Additional safety provided by the locking reservoir which secures mercury for transport or maintenance. Spider-Leg™, 5 leg weighted base for stability. 2" casters for easy mobility. Height adjustable stand from 40" to 54" (from bottom of base to top of unit). Scale angled back 15° for improved readability. ADCUFF™ black nylon cuff with ADC's proprietary Size Guide™ marking system ensures proper cuff positioning and use of correct cuff size. Dip molded latex inflation bladder. Latex inflation bulb fitted with filter screen end valve reduces dust build-up. ADFLOW™ chrome plated brass air release valve with filter screen protection permits precise deflation control and years of reliable service. Complete with 8 foot length (when extended) of coiled latex tubing. Includes all assembly tools and hardware. Comprehensive owner's manual. Inspected and packaged in the U.S.A. from foreign components. Two year inflation system warranty. Lifetime warranty on cartridge tube.

972	Adult Sphygmomanometer, Black, Latex
972C	Child Sphygmomanometer, Black, Latex
972CLF	Child Sphygmomanometer, Black, Latex Free
972I	Infant Sphygmomanometer, Black, Latex
972ILF	Infant Sphygmomanometer, Black, Latex Free
972LF	Adult Sphygmomanometer, Black, Latex Free
972N	Newborn Sphygmomanometer, Black, Latex
972T	Thigh Sphygmomanometer, Black, Latex
972TLF	Thigh Sphygmomanometer, Black, Latex Free
972X	Large Adult Sphygmomanometer, Black, Latex
972XLF	Large Adult Sphygmomanometer, Black, Latex Free

Accessories

972-00	Manometer Only, Latex Free
972-129	Plastic Cartridge For 972, Latex Free

ADC E-SPHYG 2™ DIGITAL MERCURY SPHYG

The unique backlit LCD display mimics the appearance of a traditional mercury column, but can be easily read in low light conditions. A second numeric LCD displays pressure, pulse, and a host of other vital information. The e-sphyg™ 2 features auto/manual settings. In manual mode, blood pressure is measured using the traditional, time-tested auscultatory method. Auto mode can be used with child, adult, and large adult size cuffs to automatically obtain systolic/diastolic pressure and pulse in about 1 minute.

9002D	Desk Unit, Adult, Black, 4/cs
9002DK	Desk Wall Unit, Adult, Black, This Product Contains Latex, 4/cs
9002DKLF	Desk Unit, Adult, Black, Latex Free, Multicuff, 4/cs
9002DLF	Desk Unit, Adult, Black, Latex Free, 4/cs
9002M	Mobile Unit, Adult, Black
9002MK	Mobile Unit, Multicuff, Black
9002MKLF	Mobile Unit, Multicuff, Black, Latex Free
9002MLF	Mobile Unit, Adult, Black, Latex Free
9002W	Wall Unit, Adult, Black, 4/cs
9002WK	Wall Unit, Multicuff, Black, 4/cs
9002WKLF	Wall Unit, Multicuff, Black, Latex Free, 4/cs
9002WLF	Wall Unit, Adult, Black, 4/cs



ADC E-SPHYG DIGITAL ANEROID SPHYGMOMANOMETER

Virtually indestructible design can withstand repeated drops of 5 feet or more. Extra large backlit LCD with 7/8" digits, is easy to read in virtually any light. Splash resistant housing for use in harsh environments. Swivel cuff clip allows the manometer to be re-positioned for easy viewing. Auto off function conserves battery strength. Dual low battery warnings. Recalibration reminder after 10,000 cycles (recalibration is free for the life of the instrument). Systolic assist alerts practitioner to the onset of Korotkoff sounds - makes a great training aid. Deflation rate display promotes proper technique in accordance with AHA guidelines. Pulse rate display at completion of measurement. Manometer works with virtually every cuff on the market. Requires familiar and trusted manual auscultation to obtain blood pressure readings (use of stethoscope). 2 "AAA" batteries (included). May be ordered as a complete sphygmomanometer or gauge only for use with existing inflation systems. Lifetime calibration warranty.

7002	Digital Aneroid, Adult, Black
7002C	Digital Aneroid, Child, Black
7002CLF	Digital Aneroid, Child, Latex Free, Black
7002DB	Digital Aneroid, Adult, Navy
7002DBLF	Digital Aneroid, Adult, Latex Free, Navy
7002I	Digital Aneroid, Infant, Black
7002LF	Digital Aneroid, Adult, Latex Free, Black
7002OR	Digital Aneroid, Adult, Orange
7002ORLF	Digital Aneroid, Adult, Latex Free, Orange
7002RB	Digital Aneroid, Adult, Royal Blue
7002RBLF	Digital Aneroid, Adult, Latex Free, Royal Blue
7002V	Digital Aneroid, Adult, Purple
7002VLF	Digital Aneroid, Adult, Latex Free, Purple
7002X	Digital Aneroid, Large Adult, Black
7002XLF	Digital Aneroid, Large Adult, Latex Free, Black
8002	Digital Aneroid, Gauge Only

ADC GAUGE GUARDS

Contains latex. Weighs 4 oz.

899BK	Gauge Guard Manometer Cover, Black
899O	Gauge Guard Manometer Cover, Orange



ADC NURSE BAG

1026B00	Nurse Bag, Betty Boop
1026GAR	Nurse Bag, Garfield
1026PEA	Nurse Bag, Peanuts



ADC GENERAL PRACTICE MULTICUFF KIT

Adult, child, and large adult ADCUFF™ calibrated nylon cuffs with one tube latex inflation bladders and palm style manometer in a compact storage tray. Rugged gauge features precision crafted German mechanism housed in a patented double shell ABS impact polymer casing. Ambidextrous trigger release air valve. Quick release luer slip connectors. Four section smoke gray plexiglass storage tray features a small 14" x 3" footprint to save on counter space or may be wall mounted with included hardware. Assembled, inspected, and packaged in the U.S.A. from foreign components. Two year inflation system warranty. Lifetime calibration warranty.

- 705DBGPK Multicuff Kit, Navy, Latex
- 705GPK Multicuff Kit, Black, Latex
- 705GPKLF Multicuff Kit, Black, Latex-Free

ADC PRO'S COMBO IV FANNY PACK KIT

Premium aneroid manometer with black enamel finish that exceeds ANSI SP10 specifications for accuracy and is backed by a 20 year calibration warranty. Adcuff™ nylon cuff with ADC's proprietary Size Guide™ marking system prevents mis-cuffing. Color matched to the scope and case. Color coordinated matching professional Adscope™ 641 Sprague type stethoscope with ADC proprietary valve mechanism and gasket sealed system. Color coordinated Medicut™ 7 1/4" shears with one serrated edge. Adlite™ disposable diagnostic penlight. Color matched 600 denier nylon fanny pack with 3 zippered compartments, 2 interior mesh pockets, and elastic restraining straps. Measures 10 1/4" x 6" x 3". Five year quality performance guarantee on Sprague, 20 year calibration warranty, and two year warranty on Adcuff™ inflation system. Assembled, inspected, and packaged in the U.S.A. from foreign components.

- 769-641BK Pro's Combo IV Fanny, Black
- 769-641BKLF Pro's Combo IV Fanny, Black, Latex-Free
- 769-641DB Pro's Combo IV Fanny, Navy
- 769-641DBLF Pro's Combo IV Fanny, Navy, Latex-Free
- 769-641O Pro's Combo IV Fanny, Orange
- 769-641OLF Pro's Combo IV Fanny, Orange, Latex-Free
- 769-641RB Pro's Combo IV Fanny, Royal Blue
- 769-641RBLF Pro's Combo IV Fanny, Royal Blue, Latex-Free

ADC PRO'S COMBO V POCKET ANEROID KIT

Premium aneroid manometer that exceeds ANSI SP10 specifications for accuracy backed by a lifetime calibration warranty. Adcuff™ nylon cuff with ADC's proprietary Size Guide™ marking system prevents mis-cuffing. Color matched to the scope and case. Color coordinated matching professional Adscope-lite™ 609 stethoscope with 5 year quality performance warranty. Extra large, color-matched dual pocket nylon carry case. Ideal for nurses, PAs, and EMT's. Five year quality performance guarantee on Adscope-lite™, lifetime calibration warranty, and two year warranty on Adcuff™ inflation system. Assembled, inspected, and packaged in the U.S.A. from foreign components.

- 728-609BD Pro's Combo V, Pocket-Lite, Burgundy
- 728-609BDLF Pro's Combo V, Pocket-Lite, Burgundy, Latex-Free
- 728-609BK Pro's Combo V, Pocket-Lite, Black
- 728-609BKLF Pro's Combo V, Pocket-Lite, Black, Latex-Free
- 728-609DB Pro's Combo V, Pocket-Lite, Navy
- 728-609DBLF Pro's Combo V, Pocket-Lite, Navy, Latex-Free
- 728-609DG Pro's Combo V, Pocket-Lite, Dark Green
- 728-609DGLF Pro's Combo V, Pocket-Lite, Dark Green, Latex-Free
- 728-609G Pro's Combo V, Pocket-Lite, Gray
- 728-609GLF Pro's Combo V, Pocket-Lite, Gray, Latex-Free
- 728-609R Pro's Combo V, Pocket-Lite, Red
- 728-609RB Pro's Combo V, Pocket-Lite, Royal Blue
- 728-609RBLF Pro's Combo V, Pocket-Lite, Royal Blue, Latex-Free
- 728-609RLF Pro's Combo V, Pocket-Lite, Red, Latex-Free
- 728-609TL Pro's Combo V, Pocket-Lite, Teal
- 728-609TLF Pro's Combo V, Pocket-Lite, Teal, Latex-Free
- 728-609V Pro's Combo V, Pocket-Lite, Purple



ADC PROSPHYG HOMECARE™ 780

Black enamel 300mmHg no-pin stop manometer. Navy blue nylon D-Ring self-adjusting cuff for one-handed cuff application. Latex inflation bladder and bulb. Chrome plated deflation valve. Diaphragm only blood pressure scope with black PVC tubing. Complete with leatherette zippered carrying case, and operating instructions. Assembled, inspected and packaged in the U.S.A. Ten year calibration warranty.

- 780 Adult Aneroid
- 780C Child Aneroid
- 780X Large Adult Aneroid

ADC PROSPHYG HOMECARE™ 785

Black enamel 300mmHg no-pin stop manometer. Navy blue nylon D-ring self-adjusting cuff for one-handed cuff application. Latex inflation bladder and bulb. Chrome plated deflation valve. Complete with leatherette zippered carrying case and operating instructions. Assembled, inspected and packaged in the U.S.A. Ten year calibration warranty.

- 785 Adult Aneroid
- 785C Child Aneroid
- 785X Large Adult Aneroid



ADC PROSPHYG HOMECARE™ 790

Black enamel 300mmHg no-pin stop manometer. Navy blue nylon D-ring self-adjusting cuff with attached blood pressure scope for one-handed use. Latex inflation bladder and bulb. Chrome plated deflation valve. Scope features adjustable aluminum binaurals and black 22" PVC tubing. Complete with leatherette zippered carrying case, and operating instructions. Assembled, inspected and packaged in the U.S.A. Ten year calibration warranty.

- 790 Adult Aneroid
- 790C Child Aneroid
- 790X Large Adult Aneroid



ADC PROSPHYG™ 760 SERIES ANEROID

760	Adult, Black Aneroid, Latex
760BD	Adult, Burgundy Aneroid, Latex
760BDLF	Adult, Burgundy Aneroid, Latex Free
760BOOQ	Adult, Aneroid, Betty Boop
760C	Child, Black Aneroid, Latex
760CLF	Child, Black Aneroid, Latex Free
760DB	Adult, Navy Aneroid, Latex
760DBLF	Adult, Navy Aneroid, Latex Free
760DG	Adult, Dark Green Aneroid, Latex
760DGLF	Adult, Dark Green Aneroid, Latex Free
760I	Infant, Black Aneroid, Latex
760ILF	Infant, Black Aneroid, Latex Free
760LF	Adult, Black Aneroid, Latex Free
760M	Adult, Magenta Aneroid, Latex
760MLF	Adult, Magenta Aneroid, Latex Free
760N	Newborn, Black Aneroid, Latex
760RB	Adult, Royal Blue Aneroid, Latex
760RBLF	Adult, Royal Blue Aneroid, Latex Free
760T	Thigh, Black Aneroid, Latex
760TL	Adult, Teal Aneroid, Latex
760TLF	Thigh, Black Aneroid, Latex Free
760TLLF	Adult, Teal Aneroid, Latex Free
760V	Adult, Purple Aneroid, Latex
760VLF	Adult, Purple Aneroid, Latex Free
760X	Large Adult, Black Aneroid, Latex
760XLF	Large Adult, Black Aneroid, Latex Free
761	Adult, Gray Aneroid, Latex
761LF	Adult, Gray Aneroid, Latex Free
764	Adult, Green Aneroid, Latex
764LF	Adult, Green Aneroid, Latex Free
765	Adult, Red Aneroid, Latex
765LF	Adult, Red Aneroid, Latex Free
766	Adult, Orange Aneroid, Latex
766LF	Adult, Orange Aneroid, Latex Free

Accessories

808N	Gauge For 760 & 768 Series
893-4N	Gauge Crystal For 808N Gauge
895-4N	Gauge Retaining Ring For 808N Gauge
898-4N	Spring/Clip/Pin Assembly For 808N Gauge



ADC PROSPHYG™ 770 SERIES ANEROID

Black enamel 300mmHg no-pin stop manometer. Gray cotton cuff with artery label and gauge holder. Latex inflation bladder and bulb. Chrome plated deflation valve. Complete with leatherette zippered carrying case and operating instructions. Assembled, inspected and packaged in the U.S.A. Ten year calibration warranty.

770	Adult, Gray Aneroid
-----	---------------------

Accessories

809N	Gauge For 770, 775, 780, 785 & 790 Series
893-5N	Gauge Crystal For 809N Gauge
895-5N	Gauge Retaining Ring For 809N Gauge
898-5N	Spring/Clip/Pin Assembly For 809N Gauge



ADC PROSPHYG™ 775 SERIES ANEROID SPHYGMOMANOMETER

Black enamel 300mmHg no-pin stop manometer. Navy blue nylon cuff with range markings to facilitate selection of correct cuff size; artery label and gauge holder. Latex inflation bladder and bulb. Chrome plated deflation valve. Complete with leatherette zippered carrying case and operating instructions. Assembled, inspected and packaged in the U.S.A. Ten year calibration warranty.

775	Adult Aneroid
775C	Child Aneroid
775I	Infant Aneroid
775X	Large Adult Aneroid

ADC SPECIALTY CUFFS

Individually boxed.

830-770	Standard Cotton Cuff, Gray, Adult
830-780	D-Ring Cuff, Navy, Adult
830-780C	D-Ring Cuff, Navy, Child
830-780X	D-Ring Cuff, Navy, Large Adult
830-790	D-Ring Cuff w/660-01 Chestpiece, Navy, Adult
830-790C	D-Ring Cuff w/660-01 Chestpiece, Navy, Child
830-790X	D-Ring Cuff w/660-01 Chestpiece, Navy, Large Adult

ADC SPECIALTY CUFFS & BLADDERS

Latex inflation bladder with two 55cm tubes. Individually boxed.

840-770	Standard Cotton Cuff w/bladder, Gray, Adult
840-780	D-Ring Cuff w/bladder, Navy, Adult
840-780C	D-Ring Cuff w/bladder, Navy, Child
840-780X	D-Ring Cuff w/bladder, Navy, Large Adult
840-790	D-Ring Cuff w/bladder & 660-01 Chestpiece, Navy, Adult
840-790C	D-Ring Cuff w/bladder & 660-01 Chestpiece, Navy, Child
840-790X	D-Ring Cuff w/bladder & 660-01 Chestpiece, Navy, Large Adult

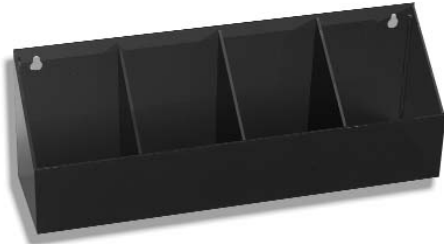

ADC SPHYG STAND

For ADC pediatric and general practice Multicuff kits. Made of formed, smoke gray plexiglass with four compartments (to hold 3 cuffs and palm aneroid, or 4 cuffs). Measures 14" long, 3 1/4" deep. Counter top or wall mount. Mounting hardware included.

884 Sphyg Stand, Smoke Gray



ADC SYSTEM 5™ BLOOD PRESSURE SYSTEM

A multipocketed, heavy duty 1000D nylon attachÉ style case that keeps each component securely in place yet instantly accessible. Dual zipper closure permits rapid access to the contents, protects against the elements. Measures a compact 10" x 9" x 4" when closed, weighs just 1 1/2 lbs. Compact enough to fit in most emergency bags or trauma boxes. Reinforced carry handle doubles as a hang tab for wall mounting in the open position. Includes infant, child, adult, large adult and thigh ADCUFF™ nylon cuffs featuring the Size Guide™ marking system with a one tube latex inflation bladder. Cuffs equipped with quick release luer slip connector to permit rapid and secure selection of the appropriate cuff. Both systems utilize the revolutionary DIAGNOSTIX™ 804 palm style manometer with precision crafted German mechanism housed in a patented double shell ABS impact polymer casing. Ambidextrous trigger release air valve. Case and cuffs available in color coordinated navy or orange. Assembled, inspected and packaged in the U.S.A. Two year inflation system warranty. Lifetime calibration warranty.

- 740 5 Cuff Blood Pressure System, Navy
- 740LF 5 Cuff Blood Pressure System, Navy, Latex Free
- 746 5 Cuff Blood Pressure System, Orange
- 746LF 5 Cuff Blood Pressure System, Orange, Latex Free



ADC PRO'S COMBO II SERIES

Black enamel 300mmHg no-pin stop manometer. ADCUFF™ calibrated nylon cuff with proprietary Size Guide™ marking system. Latex inflation bladder and bulb. Chrome plated deflation valve. Extra large, color matched dual pocket carry case measures 10" x 6" x 3". Assembled, inspected and packaged in the U.S.A. from foreign parts. Two year inflation system warranty. 20 year calibration warranty. The Pro's Combo II D.H. kit features the complete aneroid, matching case and color matched dualhead stethoscope. The Pro's Combo II S.R. kit features the complete aneroid matching case and color matched Sprague type stethoscope.

- 768-641BD Burgundy S.R. Kit, Latex
- 768-641BDLF Burgundy S.R. Kit, Latex Free
- 768-641BK Black S.R. Kit, Latex
- 768-641BKLF Black S.R. Kit, Latex Free
- 768-641DB Navy S.R. Kit, Latex
- 768-641DBLF Navy S.R. Kit, Latex Free
- 768-641DG Dark Green S.R. Kit, Latex
- 768-641DGLF Dark Green S.R. Kit, Latex Free
- 768-641M Magenta S.R. Kit, Latex
- 768-641MLF Magenta S.R. Kit, Latex Free
- 768-641O Orange S.R. Kit, Latex
- 768-641OLF Orange S.R. Kit, Latex Free
- 768-641R Red S.R. Kit, Latex
- 768-641RB Royal Blue S.R. Kit, Latex
- 768-641RBLF Royal Blue S.R. Kit, Latex Free
- 768-641RLF Red S.R. Kit, Latex Free
- 768-641TL Teal S.R. Kit, Latex
- 768-641TLF Teal S.R. Kit, Latex Free
- 768-641V Purple S.R. Kit, Latex
- 768-641VLF Purple S.R. Kit, Latex Free
- 768-670BD Burgundy D.H. Kit, Latex
- 768-670BDLF Burgundy D.H. Kit, Latex Free
- 768-670BK Black D.H. Kit, Latex
- 768-670BKLF Black D.H. Kit, Latex Free
- 768-670DB Navy D.H. Kit, Latex
- 768-670DBLF Navy D.H. Kit, Latex Free
- 768-670DG Dark Green D.H. Kit, Latex
- 768-670DGLF Dark Green D.H. Kit, Latex Free
- 768-670M Magenta D.H. Kit, Latex
- 768-670MLF Magenta D.H. Kit, Latex Free
- 768-670O Orange D.H. Kit, Latex
- 768-670OLF Orange D.H. Kit, Latex Free
- 768-670R Red D.H. Kit, Latex
- 768-670RB Royal Blue D.H. Kit, Latex
- 768-670RBLF Royal Blue D.H. Kit, Latex Free
- 768-670RLF Red D.H. Kit, Latex Free
- 768-670TL Teal D.H. Kit, Latex
- 768-670TLF Teal D.H. Kit, Latex Free
- 768-670V Purple D.H. Kit, Latex
- 768-670VLF Purple D.H. Kit, Latex Free

ADC PRO'S COMBO II ANEROID

Contemporary black enamel 300mmHg no-pin stop manometer. Adcuff™ calibrated nylon cuff with ADC's proprietary Size Guide™ marking system prevents mis-cuffing. Latex or Latex-free inflation bladder and bulb. Chrome-plated deflation valve. Extra large, color-matched dual pocket carry case, measures 10" x 6" x 3". Two year inflation system warranty. Twenty year calibration warranty. Assembled, inspected, and packaged in the U.S. A. from foreign components.

768BD	Burgundy Aneroid, Latex
768BDLF	Burgundy Aneroid, Latex Free
768BK	Black Aneroid, Latex
768BKLF	Black Aneroid, Latex Free
768DB	Navy Aneroid, Latex
768DBLF	Navy Aneroid, Latex Free
768DG	Dark Green Aneroid, Latex
768DGLF	Dark Green Aneroid, Latex Free
768G	Gray Aneroid, Latex
768GLF	Gray Aneroid, Latex Free
768M	Magenta Aneroid, Latex
768MLF	Magenta Aneroid, Latex Free
768O	Orange Aneroid, Latex
768OLF	Orange Aneroid, Latex Free
768R	Red Aneroid, Latex
768RB	Royal Blue Aneroid, Latex
768RBLF	Royal Blue Aneroid, Latex Free
768RLF	Red Aneroid, Latex Free
768TL	Teal Aneroid, Latex
768TLLF	Teal Aneroid, Latex Free
768V	Purple Aneroid, Latex
768VLF	Purple Aneroid, Latex Free



ADC PRO'S COMBO III PALM ANEROID

The 804 palm style manometer with integral latex-free bulb and trigger style air release valve for one-handed convenience. Precision crafted 300mmHg no-pin stop German movement tested to 200,000 cycles. Adcuff™ nylon cuff with ADC's proprietary Size Guide™ marking system. Quick release luer slip connector. Extra large, color-matched dual pocket carry case (measures 10" x 6" x 3"). Ideal for nurses, PA's, and EMT's. Two year inflation system warranty. Lifetime calibration warranty. Assembled, inspected, and packaged in the U.S.A. from foreign components.

788BD	Burgundy Aneroid, Latex
788BDLF	Burgundy Aneroid, Latex Free
788BK	Black Aneroid, Latex
788BKLF	Black Aneroid, Latex Free
788DB	Navy Aneroid, Latex
788DBLF	Navy Aneroid, Latex Free
788DG	Dark Green Aneroid, Latex
788DGLF	Dark Green Aneroid, Latex Free
788G	Gray Aneroid, Latex
788GLF	Gray Aneroid, Latex Free
788M	Magenta Aneroid, Latex
788MLF	Magenta Aneroid, Latex Free
788O	Orange Aneroid, Latex
788OLF	Orange Aneroid, Latex Free
788R	Red Aneroid, Latex
788RB	Royal Blue Aneroid, Latex
788RBLF	Royal Blue Aneroid, Latex Free
788RLF	Red Aneroid, Latex Free
788TL	Teal Aneroid, Latex
788TLLF	Teal Aneroid, Latex Free
788V	Purple Aneroid, Latex
788VLF	Purple Aneroid, Latex Free

ADC PRO'S COMBO III PALM ANEROID KIT

The 788 palm style manometer and color coordinated matching professional ADCSCOPE™ Sprague Rappaport type stethoscope. #804 with integral latex free bulb and trigger style air release valve for one-hand convenience. Precision crafted 300mmHg no-pin stop German mechanism designed to withstand 200,000 cycles. ADCUFF™ nylon cuff with ADC's proprietary Size Guide™ marking system. Quick release luer slip connector. Extra large, color-matched, dual pocket carry case measures 10" x 6" x 3". Ideal for nurses, PA's, and EMT's. Assembled, inspected, and packaged in the U.S.A. from foreign components. Two year inflation system warranty. Lifetime calibration warranty.

788-641BD	Burgundy S.R. Kit, Latex
788-641BDLF	Burgundy S.R. Kit, Latex Free
788-641BK	Black S.R. Kit, Latex
788-641BKLF	Black S.R. Kit, Latex Free
788-641DB	Navy S.R. Kit, Latex
788-641DBLF	Navy S.R. Kit, Latex Free
788-641DG	Dark Green S.R. Kit, Latex
788-641DGLF	Dark Green S.R. Kit, Latex Free
788-641M	Magenta S.R. Kit, Latex
788-641MLF	Magenta S.R. Kit, Latex Free
788-641O	Orange S.R. Kit, Latex
788-641OLF	Orange S.R. Kit, Latex Free
788-641R	Red S.R. Kit, Latex
788-641RB	Royal Blue S.R. Kit, Latex
788-641RBLF	Royal Blue S.R. Kit, Latex Free
788-641RLF	Red S.R. Kit, Latex Free
788-641TL	Teal S.R. Kit, Latex
788-641TLLF	Teal S.R. Kit, Latex Free
788-641V	Purple S.R. Kit, Latex
788-641VLF	Purple S.R. Kit, Latex Free

ADC PRO'S COMBO III POCKET ANEROID

Chrome-plated pocket aneroid (Diagnostix™ 700) with luminescent dial provides day-in, day-out dependability. Adcuff™ nylon cuff with ADC's proprietary Size Guide™ marking system prevents mis-cuffing. Extra large, color-matched dual pocket carry case measures 10" x 6" x 3" with handy key ring. Ideal for nurses, PA's, and EMT's. Two year inflation system warranty. Lifetime calibration warranty. Assembled, inspected, and packaged in the U.S.A. from foreign components.

778BD	Burgundy Aneroid, Latex
778BDLF	Burgundy Aneroid, Latex Free
778BK	Black Aneroid, Latex
778BKLF	Black Aneroid, Latex Free
778DB	Navy Aneroid, Latex
778DBLF	Navy Aneroid, Latex Free
778DG	Dark Green Aneroid, Latex
778DGLF	Dark Green Aneroid, Latex Free
778G	Gray Aneroid, Latex
778GLF	Gray Aneroid, Latex Free
778M	Magenta Aneroid, Latex
778MLF	Magenta Aneroid, Latex Free
778O	Orange Aneroid, Latex
778OLF	Orange Aneroid, Latex Free
778R	Red Aneroid, Latex
778RB	Royal Blue Aneroid, Latex
778RBLF	Royal Blue Aneroid, Latex Free
778RLF	Red Aneroid, Latex Free
778TL	Teal Aneroid, Latex
778TLLF	Teal Aneroid, Latex Free
778V	Purple Aneroid, Latex
778VLF	Purple Aneroid, Latex Free



ADC PRO'S COMBO III POCKET ANEROID KIT

Heavily chrome plated pocket aneroid (DIAGNOSTIX™ 700) with luminescent dial provides day-in day-out dependability. ADCUFF™ nylon cuff with ADC's proprietary Size Guide™ marking system. Color coordinated matching professional ADSCOPE™ 603 stethoscope. Combination adult size chestpiece precisely machined to exacting tolerance from surgical stainless steel for outstanding performance and rugged durability. Extra large, color-matched, dual pocket carry case measures 10" x 6" x 3". Ideal for nurses, PAs, and EMT's. Lifetime quality performance guarantee on ADSCOPE™ 603. Assembled, inspected, and packaged in the U.S.A. from foreign components. Two year inflation system warranty. Lifetime calibration warranty.

778-603BD	Burgundy D.H. Kit, Latex
778-603BDLF	Burgundy D.H. Kit, Latex Free
778-603BK	Black D.H. Kit, Latex
778-603BKLF	Black D.H. Kit, Latex Free
778-603DB	Navy D.H. Kit, Latex
778-603DBLF	Navy D.H. Kit, Latex Free
778-603DG	Dark Green D.H. Kit, Latex
778-603DGLF	Dark Green D.H. Kit, Latex Free
778-603R	Red D.H. Kit, Latex
778-603RB	Royal Blue D.H. Kit, Latex
778-603RBLF	Royal Blue D.H. Kit, Latex Free
778-603RLF	Red D.H. Kit, Latex Free
778-603TL	Teal D.H. Kit, Latex
778-603TLF	Teal D.H. Kit, Latex Free



ADC MANUAL HOME BLOOD PRESSURE KIT

Self-adjusting D-ring ADCUFF For Home™ for one-hand application. Attached nursescope. Size Guide™ marking system ensures optimal accuracy. Latex free materials. Automatic deflation valve. Accurate to +/- 3mmHg of reading. Two year limited warranty.

6005	Manual Home Blood Pressure Kit
------	--------------------------------

Accessories

808CN	Gauge For 6005
878	Bulb & Valve Assembly For 6005



7051DBPMK



705PMK

ADC PEDIATRIC MULTICUFF KIT

Newborn, infant and child ADCUFF™ calibrated nylon cuffs with one tube latex inflation bladders and ADC's rugged #804 palm style aneroid gauge in a compact storage tray. Rugged gauge features precision crafted German mechanism housed in a patented double shell ABS impact polymer casing. Ambidextrous trigger release air valve. Quick release luer slip connectors. Four section smoke gray plexiglass storage tray features a small 14" x 3" footprint to save on counter space or may be wall mounted with included hardware. Assembled, inspected and packaged in the U.S.A from foreign components. Two year inflation system warranty. Lifetime calibration warranty.

705DBPMK	Navy Pediatric Multicuff Kit
705PMK	Black Pediatric Multicuff Kit

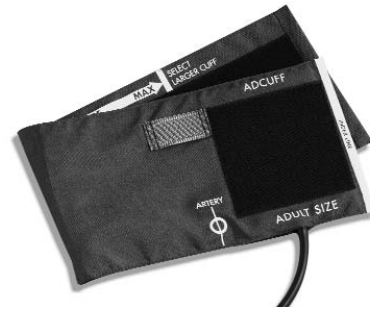

ADC ADCUFF™ & BLADDERS, 1-TUBE

Durable nylon construction. Exclusive Size Guide™ marking system. Latex or latex free inflation bladder with one 55cm tube. For use with most palm style aneroid instruments. Individually boxed. Two-year warranty.

850	ADCUFF™ & Bladder, 1-Tube, Latex, Black, Adult
850BD	ADCUFF™ & Bladder, 1-Tube, Latex, Burgundy, Adult
850BDLF	ADCUFF™ & Bladder, 1-Tube, Latex Free, Burgundy, Adult
850C	ADCUFF™ & Bladder, 1-Tube, Latex, Black, Child
850CLF	ADCUFF™ & Bladder, 1-Tube, Latex Free, Black, Child
850DB	ADCUFF™ & Bladder, 1-Tube, Latex, Navy, Adult
850DBC	ADCUFF™ & Bladder, 1-Tube, Latex, Navy, Child
850DBCLF	ADCUFF™ & Bladder, 1-Tube, Latex Free, Navy, Child
850DBI	ADCUFF™ & Bladder, 1-Tube, Latex, Navy, Infant
850DBILF	ADCUFF™ & Bladder, 1-Tube, Latex Free, Navy, Infant
850DBL	ADCUFF™ & Bladder, 1-Tube, Latex Free, Navy, Adult
850DBN	ADCUFF™ & Bladder, 1-Tube, Latex, Navy, Newborn
850DBT	ADCUFF™ & Bladder, 1-Tube, Latex, Navy, Thigh
850DBTLF	ADCUFF™ & Bladder, 1-Tube, Latex-Free, Navy, Thigh
850DBX	ADCUFF™ & Bladder, 1-Tube, Latex, Navy, Large Adult
850DBXLF	ADCUFF™ & Bladder, 1-Tube, Latex Free, Navy, Large Adult
850DG	ADCUFF™ & Bladder, 1-Tube, Latex, Dark Green, Adult
850DGLF	ADCUFF™ & Bladder, 1-Tube, Latex Free, Dark Green, Adult
850I	ADCUFF™ & Bladder, 1-Tube, Latex, Black, Infant
850ILF	ADCUFF™ & Bladder, 1-Tube, Latex Free, Black, Infant
850LF	ADCUFF™ & Bladder, 1-Tube, Latex Free, Black, Adult
850M	ADCUFF™ & Bladder, 1-Tube, Latex, Magenta, Adult
850MLF	ADCUFF™ & Bladder, 1-Tube, Latex Free, Magenta, Adult
850N	ADCUFF™ & Bladder, 1-Tube, Latex, Black, Newborn
850RB	ADCUFF™ & Bladder, 1-Tube, Latex, Royal Blue, Adult
850RBLF	ADCUFF™ & Bladder, 1-Tube, Latex Free, Royal Blue, Adult
850T	ADCUFF™ & Bladder, 1-Tube, Latex, Black, Thigh
850TL	ADCUFF™ & Bladder, 1-Tube, Latex, Teal, Adult
850TLF	ADCUFF™ & Bladder, 1-Tube, Latex Free, Black, Thigh
850TLF	ADCUFF™ & Bladder, 1-Tube, Latex Free, Teal, Adult
850V	ADCUFF™ & Bladder, 1-Tube, Latex, Purple, Adult
850VLF	ADCUFF™ & Bladder, 1-Tube, Latex Free, Purple, Adult
850X	ADCUFF™ & Bladder, 1-Tube, Latex, Black, Large Adult
850XLF	ADCUFF™ & Bladder, 1-Tube, Latex Free, Black, Large Adult
851	ADCUFF™ & Bladder, 1-Tube, Latex, Gray, Adult
851LF	ADCUFF™ & Bladder, 1-Tube, Latex Free, Gray, Adult
854	ADCUFF™ & Bladder, 1-Tube, Latex, Green, Adult
854LF	ADCUFF™ & Bladder, 1-Tube, Latex Free, Green, Adult
855	ADCUFF™ & Bladder, 1-Tube, Latex, Red, Adult
855LF	ADCUFF™ & Bladder, 1-Tube, Latex Free, Red, Adult
856	ADCUFF™ & Bladder, 1-Tube, Latex, Orange, Adult
856C	ADCUFF™ & Bladder, 1-Tube, Latex, Orange, Child
856CLF	ADCUFF™ & Bladder, 1-Tube, Latex Free, Orange, Child
856I	ADCUFF™ & Bladder, 1-Tube, Latex, Orange, Infant
856ILF	ADCUFF™ & Bladder, 1-Tube, Latex Free, Orange, Infant
856LF	ADCUFF™ & Bladder, 1-Tube, Latex Free, Orange, Adult
856T	ADCUFF™ & Bladder, 1-Tube, Latex, Orange, Thigh
856TLF	ADCUFF™ & Bladder, 1-Tube, Latex Free, Orange, Thigh
856X	ADCUFF™ & Bladder, 1-Tube, Latex, Orange, Large Adult
856XLF	ADCUFF™ & Bladder, 1-Tube, Latex Free, Orange, Large Adult



ADC ADCUFF™ & BLADDERS, 2-TUBE

Durable nylon construction. Exclusive Size Guide™ marking system. Latex or latex free inflation bladder with two 55cm tubes. For use with most aneroid or mercurial blood pressure instruments. Individually boxed. Two-year warranty.

840	ADCUFF™ & Bladder, 2-Tube, Latex, Black, Adult
840BD	ADCUFF™ & Bladder, 2-Tube, Latex, Burgundy, Adult
840BDLF	ADCUFF™ & Bladder, 2-Tube, Latex Free, Burgundy, Adult
840C	ADCUFF™ & Bladder, 2-Tube, Latex, Black, Child
840CH	ADCUFF™ & Bladder, 2-Tube, Latex, Black, Child, 10/pkg
840CHLF	ADCUFF™ & Bladder, 2-Tube, Latex Free, Black, Child, 10/pkg
840CLF	ADCUFF™ & Bladder, 2-Tube, Latex Free, Black, Child
840DB	ADCUFF™ & Bladder, 2-Tube, Latex, Navy, Adult
840DBC	ADCUFF™ & Bladder, 2-Tube, Latex, Navy, Child
840DBCLF	ADCUFF™ & Bladder, 2-Tube, Latex Free, Navy, Child
840DBI	ADCUFF™ & Bladder, 2-Tube, Latex, Navy, Infant
840DBILF	ADCUFF™ & Bladder, 2-Tube, Latex Free, Navy, Infant
840DBLF	ADCUFF™ & Bladder, 2-Tube, Latex Free, Navy, Adult
840DBN	ADCUFF™ & Bladder, 2-Tube, Latex, Navy, Newborn
840DBT	ADCUFF™ & Bladder, 2-Tube, Latex, Navy, Thigh
840DBTLF	ADCUFF™ & Bladder, 2-Tube, Latex Free, Navy, Thigh
840DBX	ADCUFF™ & Bladder, 2-Tube, Latex, Navy, Large Adult
840DBXLF	ADCUFF™ & Bladder, 2-Tube, Latex Free, Navy, Large Adult
840DG	ADCUFF™ & Bladder, 2-Tube, Latex, Dark Green, Adult
840DGLF	ADCUFF™ & Bladder, 2-Tube, Latex Free, Dark Green, Adult
840H	ADCUFF™ & Bladder, 2-Tube, Latex, Black, Adult, 10/pkg
840HLF	ADCUFF™ & Bladder, 2-Tube, Latex Free, Black, Adult, 10/pkg
840I	ADCUFF™ & Bladder, 2-Tube, Latex, Black, Infant
840IH	ADCUFF™ & Bladder, 2-Tube, Latex, Black, Infant, 5/pkg
840IHLF	ADCUFF™ & Bladder, 2-Tube, Latex Free, Black, Infant, 5/pkg
840ILF	ADCUFF™ & Bladder, 2-Tube, Latex Free, Black, Infant
840LF	ADCUFF™ & Bladder, 2-Tube, Latex Free, Black, Adult
840M	ADCUFF™ & Bladder, 2-Tube, Latex, Magenta, Adult
840MLF	ADCUFF™ & Bladder, 2-Tube, Latex Free, Magenta, Adult
840N	ADCUFF™ & Bladder, 2-Tube, Latex, Black, Newborn
840NH	ADCUFF™ & Bladder, 2-Tube, Latex, Black, Newborn, 5/pkg
840RB	ADCUFF™ & Bladder, 2-Tube, Latex, Royal Blue, Adult
840RBLF	ADCUFF™ & Bladder, 2-Tube, Latex Free, Royal Blue, Adult
840T	ADCUFF™ & Bladder, 2-Tube, Latex, Black, Thigh
840TH	ADCUFF™ & Bladder, 2-Tube, Latex, Black, Thigh, 5/pkg
840THLF	ADCUFF™ & Bladder, 2-Tube, Latex Free, Black, Thigh, 5/pkg
840TL	ADCUFF™ & Bladder, 2-Tube, Latex, Teal, Adult
840TLF	ADCUFF™ & Bladder, 2-Tube, Latex Free, Black, Thigh
840TLFL	ADCUFF™ & Bladder, 2-Tube, Latex Free, Teal, Adult
840V	ADCUFF™ & Bladder, 2-Tube, Latex, Purple, Adult
840VLF	ADCUFF™ & Bladder, 2-Tube, Latex Free, Purple, Adult
840X	ADCUFF™ & Bladder, 2-Tube, Latex, Black, Large Adult
840XH	ADCUFF™ & Bladder, 2-Tube, Latex, Black, Large Adult, 10/pkg
840XHLF	ADCUFF™ & Bladder, 2-Tube, Latex Free, Black, Large Adult, 10/pkg
840XLF	ADCUFF™ & Bladder, 2-Tube, Latex Free, Black, Large Adult
841	ADCUFF™ & Bladder, 2-Tube, Latex, Gray, Adult
841LF	ADCUFF™ & Bladder, 2-Tube, Latex Free, Gray, Adult
844	ADCUFF™ & Bladder, 2-Tube, Latex, Green, Adult
844LF	ADCUFF™ & Bladder, 2-Tube, Latex Free, Green, Adult
845	ADCUFF™ & Bladder, 2-Tube, Latex, Red, Adult
845LF	ADCUFF™ & Bladder, 2-Tube, Latex Free, Red, Adult
846	ADCUFF™ & Bladder, 2-Tube, Latex, Orange, Adult
846C	ADCUFF™ & Bladder, 2-Tube, Latex, Orange, Child
846CLF	ADCUFF™ & Bladder, 2-Tube, Latex Free, Orange, Child
846I	ADCUFF™ & Bladder, 2-Tube, Latex, Orange, Infant
846ILF	ADCUFF™ & Bladder, 2-Tube, Latex Free, Orange, Infant
846LF	ADCUFF™ & Bladder, 2-Tube, Latex Free, Orange, Adult
846T	ADCUFF™ & Bladder, 2-Tube, Latex, Orange, Thigh
846TLF	ADCUFF™ & Bladder, 2-Tube, Latex Free, Orange, Thigh
846X	ADCUFF™ & Bladder, 2-Tube, Latex, Orange, Large Adult
846XLF	ADCUFF™ & Bladder, 2-Tube, Latex Free, Orange, Large Adult

ADC ADCUFF™ 1-TUBE BLADDERS

Dip molded latex or latex free. 55cm tubing length. Size and model number printed on bladder. For use with most palm style aneroids. Individually boxed. Two year warranty.

820	One-Tube Bladder, Latex, Adult
820C	One-Tube Bladder, Latex, Child
820CLF	One-Tube Bladder, Latex Free, Child
820I	One-Tube Bladder, Latex, Infant
820ILF	One-Tube Bladder, Latex Free, Infant
820LF	One-Tube Bladder, Latex Free, Adult
820N	One-Tube Bladder, Latex, Newborn
820T	One-Tube Bladder, Latex, Thigh
820TLF	One-Tube Bladder, Latex Free, Thigh
820X	One-Tube Bladder, Latex, Large Adult
820XLF	One-Tube Bladder, Latex Free, Large Adult

ADC ADCUFF™ 2-TUBE BLADDERS

Dip molded latex or latex free. 55cm tubing length. Size and model number printed on bladder. For use with most aneroid and mercurial blood pressure instruments. Individually boxed. Two year warranty.

810	Two-Tube Bladder, Latex, Adult
810C	Two-Tube Bladder, Latex, Child
810CH	Two-Tube Bladder, Latex, Hospital Pack, Child, 10/pkg
810CHLF	Two-Tube Bladder, Latex Free, Hospital Pack, Child, 10/pkg
810CLF	Two-Tube Bladder, Latex Free, Child
810E	Two-Tube Bladder, Latex, Adult, Standard
810H	Two-Tube Bladder, Latex, Hospital Pack, Adult, 10/pkg
810HLF	Two-Tube Bladder, Latex Free, Hospital Pack, Adult, 10/pkg
810I	Two-Tube Bladder, Latex, Infant
810IH	Two-Tube Bladder, Latex, Hospital Pack, Infant, 5/pkg
810IHLF	Two-Tube Bladder, Latex Free, Hospital Pack, Infant, 5/pkg
810ILF	Two-Tube Bladder, Latex Free, Infant
810LF	Two-Tube Bladder, Latex Free, Adult
810N	Two-Tube Bladder, Latex, Newborn
810NH	Two-Tube Bladder, Latex, Hospital Pack, Newborn, 5/pkg
810T	Two-Tube Bladder, Latex, Thigh
810TH	Two-Tube Bladder, Latex, Hospital Pack, Thigh, 5/pkg
810THLF	Two-Tube Bladder, Latex Free, Thigh, 5/pkg
810TLF	Two-Tube Bladder, Latex Free, Thigh
810X	Two-Tube Bladder, Latex, Large Adult
810XH	Two-Tube Bladder, Latex, Hospital Pack, Large Adult, 10/pkg
810XHLF	Two-Tube Bladder, Latex Free, Hospital Pack, Large Adult, 10/pkg
810XLF	Two-Tube Bladder, Latex Free, Large Adult



875PLF-10



8971-10



8972-10

ADC ADCUFF™ BLOOD PRESSURE CUFF ACCESSORIES

611-20-10	Y Adaptor, No Fittings For Use w/two tube cuffs, 10/pkg
875PLF-10	Bulb & Valve, S.P.U., 10/pkg
891	Luer Connector Set, Metal, Includes 891F & 891M
891F	Luer Connector, Female, Aluminum
891F-10	Female Luer Slip Connector w/barbed end for use w/ADC & Baum (metal), 10/pkg
891M	Luer Connector, Male, Metal
891M-10	Male Luer Slip Connector w/barbed end for use w/ADC & Baum (metal), 10/pkg
8971-10	Screw Adaptor w/barbed end for use w/Dynamap, 10/pkg
8972-10	Male luer slip connector w/barbed end (plastic), 10/pkg
8973-10	Female Locking Luer Connector w/barbed end (plastic), 10/pkg
8974-10	Bayonet Connector For Use w/Hewlett Packard & Siemens Monitors, 10/pkg
8975-10	Neonatal Cuff Connector, Male Luer Slip Fitting For 3/32" ID Tubing, 10/pkg
920-011	Double Male Connector
920-011-10	Double Male Connector For 5/32" ID Tubing (plastic), 10/pkg
920-039	Filter/Diaphragm/Gasket Set



ADC ADCUFF™ INFLATION SYSTEMS

Includes ADCUFF™ nylon cuff featuring the Size Guide™ marking system. Latex or latex free inflation bladder with two 55cm tubes. ADFLOW™ bulb and valve with filter screen protection. For use with most aneroid or mercurial blood pressure instruments. Individually boxed. Two-year warranty.

- 860 Inflation System, Latex, Black, Adult
- 860BD Inflation System, Latex, Burgundy, Adult
- 860BDLF Inflation System, Latex Free, Burgundy, Adult
- 860C Inflation System, Latex, Black, Child
- 860CLF Inflation System, Latex Free, Black, Child
- 860DB Inflation System, Latex, Navy, Adult
- 860DBC Inflation System, Latex, Navy, Child
- 860DBCLF Inflation System, Latex Free, Navy, Child
- 860DBI Inflation System, Latex, Navy, Infant
- 860DBILF Inflation System, Latex Free, Navy, Infant
- 860DBLF Inflation System, Latex Free, Navy, Adult
- 860DBN Inflation System, Latex, Navy, Newborn
- 860DBT Inflation System, Latex, Navy, Thigh
- 860DBTLF Inflation System, Latex Free, Navy, Thigh
- 860DBX Inflation System, Latex, Navy, Large Adult
- 860DBXLF Inflation System, Latex Free, Navy, Large Adult
- 860DG Inflation System, Latex, Dark Green, Adult
- 860DGLF Inflation System, Latex Free, Dark Green, Adult
- 860I Inflation System, Latex, Black, Infant
- 860ILF Inflation System, Latex Free, Black, Infant
- 860LF Inflation System, Latex Free, Black, Adult
- 860M Inflation System, Latex, Magenta, Adult
- 860MLF Inflation System, Latex Free, Magenta, Adult
- 860N Inflation System, Latex, Black, Newborn
- 860RB Inflation System, Latex, Royal Blue, Adult
- 860RBLF Inflation System, Latex Free, Royal Blue, Adult
- 860T Inflation System, Latex, Black, Thigh
- 860TL Inflation System, Latex, Teal, Adult
- 860TLF Inflation System, Latex Free, Black, Thigh
- 860TLLF Inflation System, Latex Free, Teal, Adult
- 860V Inflation System, Latex, Purple, Adult
- 860VLF Inflation System, Latex Free, Purple, Adult
- 860X Inflation System, Latex, Black, Large Adult
- 860XLF Inflation System, Latex Free, Black, Large Adult
- 861 Inflation System, Latex, Gray, Adult
- 861LF Inflation System, Latex Free, Gray, Adult
- 864 Inflation System, Latex, Green, Adult
- 864LF Inflation System, Latex Free, Green, Adult
- 865 Inflation System, Latex, Red, Adult
- 865LF Inflation System, Latex Free, Red, Adult
- 866 Inflation System, Latex, Orange, Adult
- 866C Inflation System, Latex, Orange, Child
- 866CLF Inflation System, Latex Free, Orange, Child
- 866I Inflation System, Latex, Orange, Infant
- 866ILF Inflation System, Latex Free, Orange, Infant
- 866LF Inflation System, Latex Free, Orange, Adult
- 866T Inflation System, Latex, Orange, Thigh
- 866TLF Inflation System, Latex Free, Orange, Thigh
- 866X Inflation System, Latex, Orange, Large Adult
- 866XLF Inflation System, Latex Free, Orange, Large Adult

ADC ADCUFF™ NYLON CUFF

Featuring the Size Guide™ marking system. For use with most aneroid or mercurial blood pressure instruments. Two year warranty.

- 830 Nylon Cuff, Black, Adult
- 830BD Nylon Cuff, Burgundy, Adult
- 830C Nylon Cuff, Burgundy, Child
- 830CH Nylon Cuff, Black, Child, 10/pkg
- 830DB Nylon Cuff, Navy, Adult
- 830DBC Nylon Cuff, Navy, Child
- 830DBI Nylon Cuff, Navy, Infant
- 830DBN Nylon Cuff, Navy, Newborn
- 830DBT Nylon Cuff, Navy, Thigh
- 830DBX Nylon Cuff, Navy, Large Adult
- 830DG Nylon Cuff, Dark Green, Adult
- 830H Nylon Cuff, Black, Adult, 10/pkg
- 830I Nylon Cuff, Black, Infant
- 830IH Nylon Cuff, Black, Infant, 5/pkg
- 830M Nylon Cuff, Magenta, Adult
- 830N Nylon Cuff, Black, Newborn
- 830NH Nylon Cuff, Black, Newborn, 5/pkg
- 830RB Nylon Cuff, Royal Blue, Adult
- 830T Nylon Cuff, Black, Thigh
- 830TH Nylon Cuff, Black, Thigh, 5/pkg
- 830TL Nylon Cuff, Teal, Adult
- 830V Nylon Cuff, Purple, Adult
- 830X Nylon Cuff, Black, Large Adult
- 830XH Nylon Cuff, Black, Large Adult, 10/pkg
- 831 Nylon Cuff, Gray, Adult
- 834 Nylon Cuff, Green, Adult
- 835 Nylon Cuff, Red, Adult
- 836 Nylon Cuff, Orange, Adult
- 836C Nylon Cuff, Orange, Child
- 836I Nylon Cuff, Orange, Infant
- 836T Nylon Cuff, Orange, Thigh
- 836X Nylon Cuff, Orange, Large Adult

**Everything you need
for your
state-of-the-art
facility.**

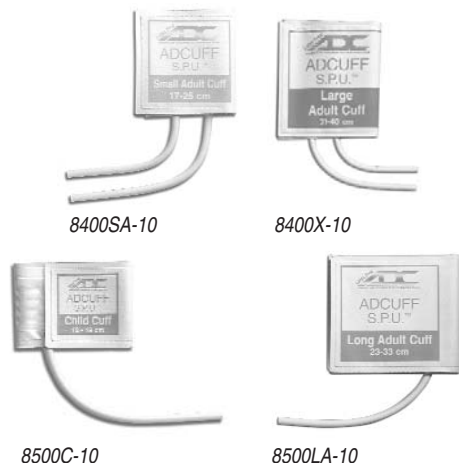

ADC ADCUFF™ S.P.U.™ BLOOD PRESSURE CUFF

Index and range marking to assure use of correct size. Artery mark simplifies correct positioning. Color coded sizes facilitate cuff selection. Latex free construction reducing risk of allergic reaction. Ultra-soft lining for patient comfort. Individually leak tested to assure dependability. Durable enough for repeated use, economical enough for single patient applications. Vinyl material treated with antibacterial agent. One and two tube configuration for versatility. A wide selection of connectors and adaptors for use with most blood pressure instruments.

- 8400A-10 Adult Blood Pressure Cuff, 2 Tubes, No Connector, Range 23-33cm, Navy/White, 10/pkg
- 8400A1-10 Adult Blood Pressure Cuff, 2 Tube For Screw Connector, Range 23-33cm, Navy/White, 10/pkg
- 8400A2-10 Adult Blood Pressure Cuff, 2 Tube For Slip Connector, Range 23-33cm, Navy/White, 10/pkg
- 8400A3-10 Adult Blood Pressure Cuff, 2 Tube For Female Connector, Range 23-33cm, Navy/White, 10/pkg
- 8400C-10 Child Blood Pressure Cuff, 2 Tubes, No Connector, Range 12-19cm, Lavender/White, 10/pkg
- 8400C1-10 Child Blood Pressure Cuff, 2 Tube For Screw Connector, Range 12-19cm, Lavender/White, 10/pkg
- 8400C2-10 Child Blood Pressure Cuff, 2 Tube For Slip Connector, Range 12-19cm, Lavender/White, 10/pkg
- 8400C3-10 Child Blood Pressure Cuff, 2 Tube For Female Connector, Range 12-19cm, Lavender/White, 10/pkg
- 8400I-10 Infant Blood Pressure Cuff, 2 Tubes, No Connector, Range 8-13cm, Light Blue/White, 10/pkg
- 8400I1-10 Infant Blood Pressure Cuff, 2 Tube For Screw Connector, Range 8-13cm, Light Blue/White, 10/pkg
- 8400I2-10 Infant Blood Pressure Cuff, 2 Tube For Slip Connector, Range 8-13cm, Light Blue/White, 10/pkg
- 8400I3-10 Infant Blood Pressure Cuff, 2 Tube For Female Connector, Range 8-13cm, Light Blue/White, 10/pkg
- 8400LA-10 Adult Long Blood Pressure Cuff, 2 Tubes, No Connector, Range 23-33cm, Orange/White, 10/pkg
- 8400LA1-10 Adult Long Blood Pressure Cuff, 2 Tube For Screw Connector, Range 23-33cm, Orange/White, 10/pkg
- 8400LA2-10 Adult Long Blood Pressure Cuff, 2 Tube For Slip Connector, Range 23-33cm, Orange/White, 10/pkg
- 8400LA3-10 Adult Long Blood Pressure Cuff, 2 Tube For Female Connector, Range 23-33cm, Orange/White, 10/pkg
- 8400SA-10 Small Adult Blood Pressure Cuff, 2 Tubes, No Connector, Range 17-25cm, Green/White, 10/pkg
- 8400SA1-10 Small Adult Blood Pressure Cuff, 2 Tube For Screw Connector, Range 17-25cm, Green/White, 10/pkg
- 8400SA2-10 Small Adult Blood Pressure Cuff, 2 Tube For Slip Connector, Range 17-25cm, Green/White, 10/pkg
- 8400SA3-10 Small Adult Blood Pressure Cuff, 2 Tube For Female Connector, Range 17-25cm, Green/White, 10/pkg
- 8400X-10 Large Adult Blood Pressure Cuff, 2 Tubes, No Connector, Range 31-40cm, Pink/White, 10/pkg

ADC ADCUFF™ S.P.U.™ BLOOD PRESSURE CUFF (Continued)

- 8400X1-10 Large Adult Blood Pressure Cuff, 2 Tube For Screw Connector, Range 31-40cm, Pink/White, 10/pkg
- 8400X2-10 Large Adult Blood Pressure Cuff, 2 Tube For Slip Connector, Range 31-40cm, Pink/White, 10/pkg
- 8400X3-10 Large Adult Blood Pressure Cuff, 2 Tube For Female Connector, Range 31-40cm, Pink/White, 10/pkg
- 8500A-10 Adult Blood Pressure Cuff, 1 Tube, No Connector, Range 23-33cm, Navy/White, 10/pkg
- 8500A1-10 Adult Blood Pressure Cuff, 1 Tube For Female Connector, Range 23-33cm, Navy/White, 10/pkg
- 8500A2-10 Adult Blood Pressure Cuff, 1 Tube For Bayonet Connector, Range 23-33cm, Navy/White, 10/pkg
- 8500A3-10 Adult Blood Pressure Cuff, 1 Tube For Slip Connector, Range 23-33cm, Navy/White, 10/pkg
- 8500C-10 Child Blood Pressure Cuff, 1 Tube, No Connector, Range 12-19cm, Lavender/White, 10/pkg
- 8500C1-10 Child Blood Pressure Cuff, 1 Tube For Female Connector, Range 12-19cm, Lavender/White, 10/pkg
- 8500C2-10 Child Blood Pressure Cuff, 1 Tube For Bayonet Connector, Range 12-19cm, Lavender/White, 10/pkg
- 8500C3-10 Child Blood Pressure Cuff, 1 Tube For Slip Connector, Range 12-19cm, Lavender/White, 10/pkg
- 8500I-10 Infant Blood Pressure Cuff, 1 Tube, No Connector, Range 8-13cm, Light Blue/White, 10/pkg
- 8500I1-10 Infant Blood Pressure Cuff, 1 Tube For Female Connector, Range 8-13cm, Light Blue/White, 10/pkg
- 8500I2-10 Infant Blood Pressure Cuff, 1 Tube For Bayonet Connector, Range 8-13cm, Light Blue/White, 10/pkg
- 8500I3-10 Infant Blood Pressure Cuff, 1 Tube For Slip Connector, Range 8-13cm, Light Blue/White, 10/pkg
- 8500LA-10 Adult Long Blood Pressure Cuff, 1 Tube, No Connector, Range 23-33cm, Orange/White, 10/pkg
- 8500LA1-10 Adult Long Blood Pressure Cuff, 1 Tube For Female Connector, Range 23-33cm, Orange/White, 10/pkg
- 8500LA2-10 Adult Long Blood Pressure Cuff, 1 Tube For Bayonet Connector, Range 23-33cm, Orange/White, 10/pkg
- 8500LA3-10 Adult Long Blood Pressure Cuff, 1 Tube For Slip Connector, Range 23-33cm, Orange/White, 10/pkg
- 8500SA-10 Small Adult Blood Pressure Cuff, 1 Tube, No Connector, Range 17-25cm, Green/White, 10/pkg
- 8500SA1-10 Small Adult Blood Pressure Cuff, 1 Tube For Female Connector, Range 17-25cm, Green/White, 10/pkg
- 8500SA2-10 Small Adult Blood Pressure Cuff, 1 Tube For Bayonet Connector, Range 17-25cm, Green/White, 10/pkg
- 8500SA3-10 Small Adult Blood Pressure Cuff, 1 Tube For Slip Connector, Range 17-25cm, Green/White, 10/pkg
- 8500X-10 Large Adult Blood Pressure Cuff, 1 Tube, No Connector, Range 31-40cm, Pink/White, 10/pkg
- 8500X1-10 Large Adult Blood Pressure Cuff, 1 Tube For Female Connector, Range 31-40cm, Pink/White, 10/pkg
- 8500X2-10 Large Adult Blood Pressure Cuff, 1 Tube For Bayonet Connector, Range 31-40cm, Pink/White, 10/pkg
- 8500X3-10 Large Adult Blood Pressure Cuff, 1 Tube For Slip Connector, Range 31-40cm, Pink/White, 10/pkg
- 8600A-10 Adult Blood Pressure Cuff, Inflation System For Slip Connector, Range 23-33cm, Navy/White, 10/pkg
- 8600C-10 Child Blood Pressure Cuff, Inflation System For Slip Connector, Range 12-19cm, Lavender/White, 10/pkg
- 8600I-10 Infant Blood Pressure Cuff, Inflation System For Slip Connector, Range 8-13cm, Light Blue/White, 10/pkg
- 8600LA-10 Adult Long Blood Pressure Cuff, Inflation System For Slip Connector, Range 23-33cm, Orange/White, 10/pkg
- 8600SA-10 Small Adult Blood Pressure Cuff, Inflation System For Slip Connector, Range 17-25cm, Green/White, 10/pkg
- 8600X-10 Large Adult Blood Pressure Cuff, Inflation System For Slip Connector, Range 31-40cm, Pink/White, 10/pkg

Sphygmomanometers



ADC ADCUFF™ S.P.U.™ NEONATAL BLOOD PRESSURE CUFF

Index and range marking to assure use of correct size. Artery mark simplifies correct positioning. Color coded sizes facilitate cuff selection. Latex free construction reducing risk of allergic reaction. Ultra-soft lining for patient comfort. Individually leak tested to assure dependability. Durable enough for repeated use, economical enough for single patient applications. Vinyl material treated with antibacterial agent. One and two tube configuration for versatility. Equipped with male luer slip connectors - additional connectors available.

8401N-10	Size #1 Blood Pressure Cuff, 2 Tube For Slip Connector, Range 3-6cm, Light Blue/White, 10/pkg
8402N-10	Size #2 Blood Pressure Cuff, 2 Tube For Slip Connector, Range 4-8cm, Lavender/White, 10/pkg
8403N-10	Size #3 Blood Pressure Cuff, 2 Tube For Slip Connector, Range 6-11cm, Green/White, 10/pkg
8404N-10	Size #4 Blood Pressure Cuff, 2 Tube For Slip Connector, Range 7-13cm, Navy/White, 10/pkg
8405N-10	Size #5 Blood Pressure Cuff, 2 Tube For Slip Connector, Range 8-15cm, Pink/White, 10/pkg
8501N-10	Size #1 Blood Pressure Cuff, 1 Tube For Slip Connector, Range 3-6cm, Light Blue/White, 10/pkg
8502N-10	Size #2 Blood Pressure Cuff, 1 Tube For Slip Connector, Range 4-8cm, Lavender/White, 10/pkg
8503N-10	Size #3 Blood Pressure Cuff, 1 Tube For Slip Connector, Range 6-11cm, Green/White, 10/pkg
8504N-10	Size #4 Blood Pressure Cuff, 1 Tube For Slip Connector, Range 7-13cm, Navy/White, 10/pkg
8505N-10	Size #5 Blood Pressure Cuff, 1 Tube For Slip Connector, Range 8-15cm, Pink/White, 10/pkg

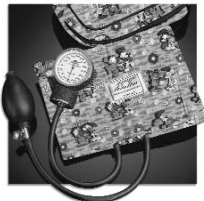

ADC ADTOON™ 760 SERIES

Our most popular aneroid with character cuff. Select models with matching zipper carry case. Contemporary black enamel 300mmHg no-pin stop manometer, provides day-in, day-out dependability. Adtoon™ nylon cuff with ADC's proprietary Size Guide™ marking system, prevents mis-cuffing. Chrome-plated brass air release valve. Matching Adtoon™ nylon carrying case with durable nylon zipper (Adult only). Assembled, inspected, and packaged in the U.S.A. from foreign components.

760BOOLFQ	Sphyg, Adult, Betty Boop, LF
760GARCLFQ	Sphyg, Child, Garfield, LF
760GARCO	Sphyg, Child, Garfield
760GARLFQ	Sphyg, Adult, Garfield, LF
760GARQ	Sphyg, Adult, Garfield
760GARXLFQ	Sphyg, Lrg Adult, Garfield, LF
760GARXQ	Sphyg, Lrg Adult, Garfield
760HKCLFQ	Sphyg, Child, Hello Kitty, LF
760HKCCQ	Sphyg, Child, Hello Kitty
760HKLFQ	Sphyg, Adult, Hello Kitty, LF
760HKQ	Sphyg, Adult, Hello Kitty
760PEACLQ	Sphyg, Child, Peanuts, LF
760PEACQ	Sphyg, Child, Peanuts
760PEALFQ	Sphyg, Adult, Peanuts, LF
760PEAQ	Sphyg, Adult, Peanuts
760PEAXLFQ	Sphyg, Lrg Adult, Peanuts, LF
760PEAXQ	Sphyg, Lrg Adult, Peanuts

ADC ADTOON™ INFLATION SYSTEM ACCESSORIES

Durable nylon construction. Proprietary ADCUFF™ Size Guide™ Marking system. Latex or Latex-Free inflation bladder with 55cm tube length. ADFLOW™ bulb and valve with filter screen protection. For use with virtually any aneroid or mercurial instrument. Available in 3 sizes. Luer connector (#891F) included. Individually boxed. 2 year warranty.

830BOO	Nylon Cuff, Adult, Betty Boop
830GAR	Nylon Cuff, Adult, Garfield
830GARC	Nylon Cuff, Child, Garfield
830GARX	Nylon Cuff, Lrg Adult, Garfield
830HK	Nylon Cuff, Adult, Hello Kitty
830HKC	Nylon Cuff, Child, Hello Kitty
830PEA	Nylon Cuff, Adult, Peanuts
830PEAC	Nylon Cuff, Child, Peanuts
830PEAX	Nylon Cuff, Lrg Adult, Peanuts
840BOO	Cuff & 2 Tube Bladder, Adult, Betty Boop
840BOOLF	Cuff & 2 Tube Bladder, Adult, Betty Boop, LF
840GAR	Cuff & 2 Tube Bladder, Adult, Garfield
840GARC	Cuff & 2 Tube Bladder, Child, Garfield
840GARCLF	Cuff & 2 Tube Bladder, Child, Garfield, LF
840GARLF	Cuff & 2 Tube Bladder, Adult, Garfield, LF
840GARX	Cuff & 2 Tube Bladder, Lrg Adult, Garfield
840GARXLF	Cuff & 2 Tube Bladder, Lrg Adult, Garfield, LF
840HK	Cuff & 2 Tube Bladder, Adult, Hello Kitty
840HKC	Cuff & 2 Tube Bladder, Child, Hello Kitty, LF
840HKCLF	Cuff & 2 Tube Bladder, Child, Hello Kitty, LF
840HKLF	Cuff & 2 Tube Bladder, Adult, Hello Kitty, LF
840PEA	Cuff & 2 Tube Bladder, Adult, Peanuts
840PEAC	Cuff & 2 Tube Bladder, Child, Peanuts
840PEACL	Cuff & 2 Tube Bladder, Child, Peanuts, LF
840PEALF	Cuff & 2 Tube Bladder, Adult, Peanuts, LF
840PEAX	Cuff & 2 Tube Bladder, Lrg Adult, Peanuts
840PEAXLF	Cuff & 2 Tube Bladder, Lrg Adult, Peanuts, LF
860BOO	Inflation System Adult, Betty Boop
860BOOLF	Inflation System Adult, Betty Boop, LF
860GAR	Inflation System Adult, Garfield
860GARC	Inflation System Child, Garfield
860GARCLF	Inflation System Child, Garfield, LF
860GARLF	Inflation System Adult, Garfield, LF
860GARX	Inflation System Large Adult, Garfield
860GARXLF	Inflation System Large Adult, Garfield, LF
860HK	Inflation System Adult, Hello Kitty
860HKC	Inflation System Child, Hello Kitty
860HKCLF	Inflation System Child, Hello Kitty, LF
860HKLF	Inflation System Adult, Hello Kitty, LF
860PEA	Inflation System Adult, Peanuts
860PEAC	Inflation System Child, Peanuts
860PEACL	Inflation System Child, Peanuts, LF
860PEALF	Inflation System Adult, Peanuts, LF
860PEAX	Inflation System Adult, Peanuts
860PEAXLF	Inflation System Large Adult, Peanuts, LF

ADC INFLATION BULBS & VALVES

Dip molded latex or latex free. For use with most aneroid or mercurial blood pressure instruments. End valve included. Individually boxed. Two-year warranty.

870	ADFLOW™ Bulb w/filter screen end valve, Latex
870-1	Filter Screen End Valve Only
870H	ADFLOW™ Bulb w/filter screen end valve, Latex, 10/pkg
870HLF	ADFLOW™ Bulb w/filter screen end valve, Latex Free, 10/pkg
870L	Large ADFLOW™ Bulb w/filter screen end valve, Latex
870LF	ADFLOW™ Bulb w/filter screen end valve, Latex Free
870LH	Large ADFLOW™ Bulb w/filter screen end valve, Latex, 10/pkg
872	ADFLOW™ Bulb & Valve (870 & 871), Latex
872H	ADFLOW™ Bulb & Valve (870 & 871), Latex, 10/pkg
872HLF	ADFLOW™ Bulb & Valve (870 & 871), Latex Free, 10/pkg
872L	ADFLOW™ Bulb & Valve (870 & 871), Large, Latex
872LF	ADFLOW™ Bulb & Valve (870 & 871), Latex Free
872LH	ADFLOW™ Bulb & Valve (870 & 871), Large, Latex, 10/pkg
873	Standard Bulb w/regular end valve, Latex
873-1	Standard End Valve
873LF	Standard Bulb w/regular end valve, Latex Free
875	Standard Bulb & Valve, Latex
875LF	Standard Bulb & Valve, Latex Free



LF1468



LF1478



LF1512

RIESTER ANEROID SPHYGMOMANOMETER

Latex bulb for pumping up the cuff. Precision air release valve with fine adjustment and wear-free. Microfilter protects air release valve and measuring system. Specially tempered copper-beryllium diaphragm with precision movement and almost non-aging. Diaphragm pressure-loading capacity up to 600mmHg. Easily legible scale up to 300mmHg. Maximum error tolerance +/-3mmHg.

LF1312	Mobile Model w/adult size velcro cuff, Latex Free, Minimus® II
LF1342	Mobile Model w/adult size velcro cuff, Latex Free, Minimus® III
LF1350	Mobile Model w/adult size velcro cuff, Latex Free, Black, Exacta® Metal
LF1360-107	Mobile Model w/adult size velcro cuff, Latex Free, Precisa® N, 1 Tube Plastic/Metal
LF1362	Mobile Model w/adult size velcro cuff, Latex Free, Precisa® N, 1 Tube Aluminum
LF1441	Mobile Model w/child, baby & infant size velcro cuff, Latex Free, Babyphon® Plastic/Metal
LF1453	Desk Model w/adult size velcro cuff, Latex Free, Big Ben® Round
LF1456	Desk Model w/adult size velcro cuff, Latex Free, Big Ben® Square
LF1459	Wall Model w/adult size velcro cuff, Latex Free, Big Ben® Round
LF1465	Wall Model w/adult size velcro cuff, Latex Free, Big Ben® Square
LF1468	Floor Model 15" w/adult size velcro cuff, Latex Free, Big Ben® Round
LF1475	Floor Model 21.5" w/adult size velcro cuff, Latex Free, Big Ben® Round
LF1478	Floor Model 15" w/adult size velcro cuff, Latex Free, Big Ben® Square
LF1485	Floor Model 21.5" w/adult size velcro cuff, Latex Free, Big Ben® Square
LF1512	Mobile Model w/adult size velcro cuff, Latex Free, Slate-Grey, Ri-san®
LF1517	Mobile Model w/adult size velcro cuff, Latex Free, Blue, Ri-san®
LF1522	Mobile Model w/adult size velcro cuff, Latex Free, Saffron, Ri-san®
LF1527	Mobile Model w/adult size velcro cuff, Latex Free, Green, Ri-san®

RIESTER BLOOD PRESSURE UNITS ACCESSORIES

10373	Tube Connector Part II Long, Chrome Plated
10375	Tube Connector Part II, Long, Black Chrome Plated, Ri-Mega®
10376	Tube Connector Part II, Long, Chrome Plated, Ri-Med®
10387	Pin Connector Part I Long, Grey Plastic
LF10350	Bulb w/air release valve, Latex Free
LF10351	Latex Bulb, Black
LF10382	Coiled Latex Tubing, Black
LF107	Velcro Cuff 1 Tube, Adult, Latex Free
LF122	Velcro Cuff 1 Tube, Obese, Latex Free
LF123.004	Velcro Cuff Obese Size 23.03 x 7.28", 2 Tubes, Black w/connector
LF129	Velcro Cuff 1 Tube, Children, Latex Free
LF130.003	Velcro Cuff Child Size 13.97 x 3.93", 2 Tubes, Blue w/connector
LF132	Velcro Cuff 1 Tube, Infant, Latex Free
LF133.002	Velcro Cuff Infant Size 9.05 x 2.83", 2 Tubes, Blue w/connector
LF134	Velcro Cuff 1 Tube, Newborn, Latex Free
LF135.002	Velcro Cuff Newborn Size 6.10 x 2", 2 Tubes, Blue w/connector

OMRON AUTOMATIC BLOOD PRESSURE MONITOR WITH COMFIT™ CUFF

Comfit™ cuff is pre-formed for quick and proper fit (9" to 17" arms). Clinically proven accuracy. Technology offers personalized inflation for maximum comfort. Blood pressure and pulse rate displayed on a large digital panel. Large, clear digital display. Five-year warranty.

HEM-711DLX	BP Monitor w/Comfit™ Cuff, 60 memory recall w/time & date stamp, Carry Case, AC Adapter & English/Spanish Manual
HEM-780N	BP Monitor w/Comfit™ Cuff, 90 Memory Recall w/date & time stamp, Plastic Case for Storage, AC Adapter, 4 AA Batteries
HEM-790IT	BP Monitor w/Comfit™ Cuff, 2 user 200 total memory recall w/time-date stamp, CD ROM, USB Cable, Carry Case, AC Adapter, 4 "AA" Batteries & English/Spanish Manual

OMRON COMBINATION SET SPHYGMOMANOMETERS

Combo set includes: Sprague Rappaport and Aneroid Sphygmomanometer.

FP-BLK-COMBO	Combo Set Sprague Rappaport & Aneroid Sphygmomanometer w/fanny pack, Black
FP-BURG-COMBO	Combo Set Sphygmomanometer w/fanny pack, Burgundy
FP-PURP-COMBO	Combo Set Sphygmomanometer w/fanny pack, Purple
FP-TEAL-COMBO	Combo Set Sprague Rappaport & Aneroid Sphygmomanometer w/fanny pack, Teal

OMRON CUFF AND BLADDER REPLACEMENTS

21-071	Calibrated Nylon Cuff, Blue, Adult
21-071C	Calibrated Nylon Cuff, Blue, Child
21-0711	Calibrated Nylon Cuff, Blue, Infant
21-071L	Calibrated Nylon Cuff, Blue, Thigh
21-071X	Calibrated Nylon Cuff, Blue, Large Adult
21-081	Double Tube Bladder, Adult
21-081NL	Double Tube Bladder, Adult, Latex Free (Neoprene)
21-082	Double Tube Bladder, Infant
21-082NL	Double Tube Bladder, Infant, Latex Free (Neoprene)
21-083	Double Tube Bladder, Child
21-083NL	Double Tube Bladder, Child, Latex Free (Neoprene)
21-084	Double Tube Bladder, Large Adult
21-084NL	Double Tube Bladder, Large Adult, Latex Free (Neoprene)
21-085	Double Tube Bladder, Thigh
21-085NL	Double Tube Bladder, Thigh, Latex Free (Neoprene)
21-091	Single Tube Bladder, Adult
21-094	Single Tube Bladder, Large Adult

OMRON CUFF AND BLADDER SETS

21-031	Calibrated Blue Nylon Cuff w/double-tube bladder, Adult
21-031C	Calibrated Blue Nylon Cuff w/double-tube bladder, Child
21-031CNL	Calibrated Blue Nylon Cuff w/double-tube bladder, Child, Latex Free (Neoprene)
21-031I	Calibrated Blue Nylon Cuff w/double-tube bladder, Infant
21-031INL	Calibrated Blue Nylon Cuff w/double-tube bladder, Infant, Latex Free (Neoprene)
21-031L	Calibrated Blue Nylon Cuff w/double-tube bladder, Thigh
21-031LNL	Calibrated Blue Nylon Cuff w/double-tube bladder, Thigh, Latex Free (Neoprene)
21-031NB	Calibrated Blue Nylon Cuff w/double-tube bladder, Newborn
21-031NL	Calibrated Blue Nylon Cuff w/double-tube bladder, Adult, Latex Free (Neoprene)
21-031X	Calibrated Blue Nylon Cuff w/double-tube bladder, Large Adult
21-031XNL	Calibrated Blue Nylon Cuff w/double-tube bladder, Large Adult, Latex Free (Neoprene)
21-053	Calibrated Gray Nylon Cuff w/single-tube bladder, Adult
21-053C	Calibrated Gray Nylon Cuff w/single-tube bladder, Child
21-053I	Calibrated Gray Nylon Cuff w/single-tube bladder, Infant
21-053L	Calibrated Gray Nylon Cuff w/single-tube bladder, Thigh
21-053X	Calibrated Gray Nylon Cuff w/single-tube bladder, Large Adult
21-201	Calibrated Blue Nylon Cuff w/double-tube bladder, inflation bulb, air release valve, Adult
21-201C	Calibrated Blue Nylon Cuff w/double-tube bladder, inflation bulb, air release valve, Child
21-201I	Calibrated Blue Nylon Cuff w/double-tube bladder, inflation bulb, air release valve, Infant
21-201L	Calibrated Blue Nylon Cuff w/double-tube bladder, inflation bulb, air release valve, Thigh
21-201X	Calibrated Blue Nylon Cuff w/double-tube bladder, inflation bulb, air release valve, Large Adult



OMRON DIGITAL BP MONITOR WITH EZ WRAP CUFF

In the clinical setting, the EZ Wrap Cuff (9"-17") allows the unit to be used on a wider range of arm sizes, often negating the need for separate, larger sized cuffs. For home use, the EZ Wrap Cuff makes applying the cuff much easier for an individual without assistance. The IntelliSense technology allows for comfortable, personalized inflation and accurate results. Two person, 21 memory recall with date and time stamped for each person. AC adapter and 4 "AA" batteries included. Five-year warranty.

HEM-773AC Digital BP Monitor w/EZ Wrap Cuff



H-003D



HEM-907-STAND

OMRON DIGITAL BLOOD PRESSURE PARTS & ACCESSORIES

0080AGRAY	D-Ring Contour Cuff For HEM-412C, HEM-712C & HEM-703CP, Gray
0090TRP	Replacement Roll of Thermal Paper For HEM-705CP, 5 rl/bx
0094AGRAY	D-Ring Curved Contour Cuff, Gray
0097RP	Replacement Roll Paper For HEM-703CP & 97, 5/bx
0146GRAY	Gray Bulb & Valve For HEM-412C & HEM-425C
H-003D	Large Adult Cuff, Gray
H-003DS	Small Size Cuff For IntelliSense Monitors
H-CL22	Replacement Cuff For HEM-711AC
HCG-801	Portable ECG Monitor
HEM-780-1N	Replacement Cuff For HEM-780
HEM-907-BLDRL	Bladder Large Cuff For HEM-907 & 907XL
HEM-907-BLDRM	Bladder Medium Cuff For HEM-907 & 907XL
HEM-907-BLDRS	Bladders Small Cuff For HEM-907 & 907XL
HEM-907-CL19	Cuff & Bladder Set, Large 32-42cm For HEM-907 & 907XL
HEM-907-CR19	Cuff & Bladder Set, Medium 22-32cm For HEM-907 & 907XL
HEM-907-CS19	Cuff & Bladder Set, Small 17-22cm For HEM-907 & 907XL
HEM-907-CUFFL	Cuff For Large Bladder 32-42cm For HEM-907 & 907XL
HEM-907-CUFFM	Cuff For Medium Bladder 22-32cm For HEM-907 & 907XL
HEM-907-CUFFS	Cuff For Small Bladder 17-22cm For HEM-907 & 907XL
HEM-907-CX-19	Cuff & Bladder Set, X-Large 42-50cm For HEM-907XL
HEM-907-CX-BLDRX	Bladder, X-Large 42-50cm For HEM-907XL
HEM-907-PBAT	Battery Pack For HEM-907 & 907XL BP Unit
HEM-907-PKIT	Pole Mount For HEM-907 & 907XL BP Unit
HEM-907-STAND	Stand For HEM-907 & 907XL BP Unit
HEM-907-WKIT	Wall Mount Kit For HEM-907 & 907XL BP Unit
HEM-AC-J	HEM-907 & 907XL Adapter
HEM-ADPTW5	AC Adapter For Omron & Marshall Auto Inflate Monitors
HEM-TUBE-100	Air Tube 1.0m WL For HEM-907
HEM-TUBE-100XL	Air Tube 1.0m WL For HEM-907XL
HEM-TUBE-130	Air Tube 1.3m WL For HEM-907
HEM-TUBE-130XL	Air Tube 1.3m WL For HEM-907XL
NE-C30BP	CompAir Elite Portable Compressor Nebulizer w/AC, Nebulizer Kit & Pediatric Mask

OMRON DIGITAL WRIST BP MONITOR WITH APS

APS (Advanced Positioning Sensor) technology means that unless the wrist is held in the proper position, slightly above the heart, it will not provide a reading, eliminating mixed results due to user technique. 90 memory recall. IntelliSense technology offers personalized inflation for maximum comfort, graphing capabilities with date and time stamp. Five-year warranty.

HEM-650 Compact Wrist Monitor w/ A.P.S.™, & Irregular Heartbeat Detector

OMRON INTELLISENSE™ AUTOMATIC PLUS BLOOD PRESSURE MONITOR

IntelliSense™ technology offers automated level setting and electronic deflation control. Completely automatic, operates with the push of a button. Large, clear digital display. 14 memory storage with AC adapter and illustrated instruction manual included. Quickly and accurately measures blood pressure and pulse. Tailored arm cuff is durable and fits for arms 9"-13" in circumference (large cuff, 13" to 17" available). Five year warranty.

HEM-711ACN Automatic Inflation Monitor w/fuzzy logic & AC adapter

OMRON MANOMETER PARTS & ACCESSORIES

0148	Standard Aneroid Gauge, Gray
0156	Marshall® Professional Gauge For 108M
0179	Calibration Tool For Standard Aneroids
21-001	Exactus II Gauge, Blue
21-150	Crystal For Standard Aneroids

OMRON REGENCY ANEROID

Large, easy-to-read, 6" faceplate with white numerals on blue background with blue nylon adult cuff. ABS plastic casing encloses a no stop pin 300mmHg gauge. Lifetime calibration warranty ± 3 mm Hg.

- 11-675D Square Faced Wall Mounted Aneroid w/nylon cuff
- 11-675DNL Square Faced Wall Mounted Aneroid w/latex free nylon cuff
- 11-685 Large Face Sphygmomanometer Floor Stand w/nylon cuff, Square Face w/field calibration tool



OMRON REGENCY SERIES MANUAL INFLATION BLOOD PRESSURE MONITOR

Large digital panel with 14 reading memory. Easy squeeze inflation bulb quickly fills cuff with air. Complete with zippered carrying case. Operates on 4 AA batteries (not included).

- 422CRLCN Manual Inflation Monitor w/large adult cuff
- HEM-432CN Manual Inflation Monitor



OMRON SELF-TAKING BLOOD PRESSURE KIT

Long-lasting cotton D-ring cuff. One-hand operation. Easy-to-read gauge. Professional stethoscope attached to cuff. Includes vinyl carrying case, illustrated instructions, and blood pressure chart. One year warranty.

- 0104 Adult Blood Pressure Kit, Black
- 0104MAJ Large Adult Blood Pressure Kit, Blue
- 0116 Adult Blood Pressure Kit, Two-Party, Black
- HEM-18 Self Taking Manual Blood Pressure
- HEM-18S Self Taking Manual Blood Pressure Kit w/vinyl bladder

OMRON ZIPPER CASES FOR MANOMETERS

- 0151 Standard Vinyl Manometer Case, Black
- 0151LA Large Vinyl Manometer Case, Black

OMRON AUTOMATIC BLOOD PRESSURE MONITOR WITH SPOTARM™ CUFF

- 1500PRO BP Monitor w/SpotArm Cuff, 2-Users/200 Total Memory Detect Irregular Heartbeat, Detect Morning Hypertension, Advanced Averaging

OMRON WOMEN'S ADVANCED BLOOD PRESSURE MONITOR

- ELITE7300W Women's Advanced BPM w/standard & large size cuffs, 84 Memory + Guest Mode, Hypertension Indicator, Detects Irregular Heartbeat



PRO ADVANTAGE® SPRAGUE STETHOSCOPE

Features a double-tube configuration for improved stereo separation as well as a patented chestpiece valve stem which delivers outstanding acoustics. An accessory kit contains five interchangeable chestpiece fittings - an adult and pediatric diaphragm, and three bells (1 1/4", 1", 3/4"), deluxe eartips, and a chestpiece key. 22" tubing length. Five year warranty. Latex free.

- P542202 Sprague Stethoscope, 22", Black
- P542204 Sprague Stethoscope, 22", Navy
- P542206 Sprague Stethoscope, 22", Neon Orange
- P542208 Sprague Stethoscope, 22", Neon Pink
- P542210 Sprague Stethoscope, 22", Red
- P542212 Sprague Stethoscope, 22", Royal Blue



PRO ADVANTAGE® NURSE STETHOSCOPE

The Pro Advantage nurse stethoscope features a diaphragm only nurse style chestpiece with a non-chill rim, lightweight adjustable binaurals, flexible PVC 22" Y tubing, and choice of eartips. One year warranty. Latex free.

- P542002 Stethoscope, Nurse, Black
- P542007 Stethoscope, Nurse, Gray
- P542012 Stethoscope, Nurse, Navy
- P542017 Stethoscope, Nurse, Red
- P542022 Stethoscope, Nurse, Royal Blue
- P542027 Stethoscope, Nurse, Teal



PRO ADVANTAGE® DUAL HEAD STETHOSCOPE

Features a combination diaphragm/bell chestpiece with a non-chill rim, lightweight adjustable binaurals, flexible PVC 22" Y tubing and choice of eartips. One year warranty. Latex free.

- P542010 Dualhead Stethoscope, Black
- P542015 Dualhead Stethoscope, Gray
- P542020 Dualhead Stethoscope, Navy
- P542025 Dualhead Stethoscope, Red
- P542030 Dualhead Stethoscope, Royal Blue
- P542035 Dualhead Stethoscope, Teal



PRO ADVANTAGE® BOWLES STETHOSCOPE

Features a diaphragm only chestpiece with a traditional raised stem design, lightweight adjustable binaurals, flexible PVC 22" Y tubing and choice of eartips. One year warranty. Latex free.

P542029 Bowles Stethoscope, Black



PRO ADVANTAGE® INFANT STETHOSCOPE

The Pro Advantage infant stethoscope features a combination chestpiece with a 22mm diaphragm and bell, slip on gray non-chill bell ring, lightweight adjustable binaurals, flexible PVC 22" Y tubing and choice of eartips. One year warranty. Latex free.

P542131 Infant Stethoscope, Black

P542141 Infant Stethoscope, Gray



PRO ADVANTAGE® PEDIATRIC STETHOSCOPE

Features a combination chestpiece with 1 1/4" diaphragm and 3/4" non-chill bell and rim, lightweight adjustable binaurals, flexible PVC 22" Y tubing and choice of eartips. One year warranty. Latex free.

P542111 Pediatric Stethoscope, Black

P542121 Pediatric Stethoscope, Gray



ADC ADSCOPE™ 600 CARDIOLOGY STETHOSCOPE

Unique design that combines the acoustic response of a traditional bell and diaphragm into a convenient one-sided chestpiece. Bell-type low frequency response is achieved by simply holding the chestpiece in place with light pressure. Firm pressure will produce diaphragm-type frequency performance. A rubber gasket recessed into the chestpiece alters the diaphragm permitting the scope to achieve multi-frequency response. Custom molded extra thick bilumen 19" PVC tubing stays soft and flexible. Extra thick tubing walls minimize extraneous noise. Includes one pair of plastic eartips and two pairs of ADSOFT™ PVC eartips (small and large). Overall length 28". Weight 8.5 oz. Scope ID tag included. Lifetime quality performance guarantee. Latex free.

600BD ADSCOPE™ 600 Cardiology Stethoscope, Burgundy

600BK ADSCOPE™ 600 Cardiology Stethoscope, Black

600DG ADSCOPE™ 600 Cardiology Stethoscope, Dark Green

600GP ADSCOPE™ 600 Cardiology Stethoscope, Gold Plated, Black

600N ADSCOPE™ 600 Cardiology Stethoscope, Navy

Accessories

600-01BD Chestpiece For 600, Burgundy

600-01BK Chestpiece For 600, Black

600-01DG Chestpiece For 600, Dark Green

600-01GP Chestpiece For 600GP, Black

600-01N Chestpiece For 600, Navy

600-03 Diaphragm For 600

600-05GP Binaural/Tubing For 600GP

600-06BK Eartips, Black

ADC ADSCOPE™ 601 CARDIOLOGY STETHOSCOPE

Threaded chestpiece drum allows rapid conversion from a pediatric diaphragm to an adult bell. Chestpiece precisely machined to exacting tolerance from surgical stainless steel for outstanding performance and rugged durability. Extra deep bell for unsurpassed low frequency response. Ultra-sensitive diaphragms for greater amplification and crisper high frequency transmission. Non-chill bell and diaphragm retaining rims for patient comfort. Large internal bore stainless steel binaurals are fixed at a 15° angle for greater comfort. Custom molded bilumen 19" PVC tubing stays soft and flexible. Latex free. Extra thick tubing walls minimize extraneous noise. Double leaf internal spring construction reduces bulk and prevents kinking when folded. Complete with one pair of PVC eartips and ADSOFT™ deluxe PVC eartips in small and large sizes for the ultimate in wearing comfort and acoustic seal. Complete with an accessory case containing the adult bell, 2 spare diaphragms, and two sets of eartips. Scope ID tag included. Weighs 9 oz (adult bell) and 10 oz (pediatric diaphragm). Overall length 28". Lifetime warranty.

601BD Burgundy Stethoscope

601BK Black Stethoscope

601DG Dark Green Stethoscope

601N Navy Stethoscope

Accessories

601-01BD Chestpiece For 601, Burgundy

601-01BK Chestpiece For 601, Black

601-01DG Chestpiece For 601, Dark Green

601-01N Chestpiece For 601, Navy

601-05BD Binaural/Tubing For 600 & 601, Burgundy

601-05BK Binaural/Tubing For 600 & 601, Black

601-05DG Binaural/Tubing For 600 & 601, Dark Green

601-05N Binaural/Tubing For 600 & 601, Navy

601-11BD Bell For 601, Burgundy

601-11BK Bell For 601, Black

601-11DG Bell For 601, Dark Green

601-11N Bell For 601, Navy

601-15BD Diaphragm Assembly For 601, Burgundy

601-15BK Diaphragm Assembly For 601, Black

601-15DG Diaphragm Assembly For 601, Dark Green

601-15N Diaphragm Assembly For 601, Navy

601-18 Accessories 2/26/2008 Case For 600 & 601



ADC ADSCOPE™ 602 CARDIOLOGY STETHOSCOPE

Stainless steel construction for rugged durability. Combination chestpiece precisely machined to exacting tolerances for outstanding acoustic performance. Extra deep bell for unsurpassed low frequency response. Non-chill bell and diaphragm ring for patient comfort. Custom molded 16" bilumen PVC tubing improves acoustic separation. Internal spring construction reduces bulk. Binaurals fixed at 15° angle for greater comfort. Includes one pair of plastic eartips and two pair of PVC eartips with threaded metal inserts for the ultimate in wearing comfort and acoustic seal. Weighs 9 oz. Overall length 25". Latex free. Lifetime warranty.

602BD	Burgundy Stethoscope
602BK	Black Stethoscope
602DG	Dark Green Stethoscope

ADC ADSCOPE™ 602 CARDIOLOGY STETHOSCOPE ACCESSORIES

602-01BD	Chestpiece For 602, Burgundy
602-01BK	Chestpiece For 602, Black
602-01DG	Chestpiece For 602, Dark Green
602-02BD	Burgundy Diaphragm Rim For 600, 601, 602, 603, 609, 612
602-02BK	Black Diaphragm Rim For 600, 601, 602, 603, 609, 612
602-02DG	Dark Green Diaphragm Rim For 600, 601, 602, 603, 609, 612
602-02FG	Frosted Glacier Diaphragm Rim For 603 & 609
602-02FL	Frosted Lilac Diaphragm Rim For 603 & 609
602-02FS	Frosted Seafoam Diaphragm Rim For 603 & 609
602-02G	Gray Diaphragm Rim For 602, 603, 609, 612
602-02LV	Lavender Diaphragm Rim For 603, 609, 612
602-02N	Navy Diaphragm Rim For 600, 601, 602, 603, 609, 612
602-02R	Red Diaphragm Rim For 603, 609, 612
602-02RB	Royal Blue Diaphragm Rim For 602, 603, 609, 612
602-02TL	Teal Diaphragm Rim For 603, 609, 612
602-02V	Purple Diaphragm Rim For 603 & 609
602-03	Diaphragm For 600GP, 601, 602, 603, 612
602-04BD	Burgundy Non-Chill Rings For 601, 602
602-04BK	Black Non-Chill Rings For 601, 602
602-04DG	Dark Green Non-Chill Rings For 601, 602
602-04N	Navy Non-Chill Rings For 601, 602
602-05BD	Binaural/Tubing For 602, Burgundy
602-05BK	Binaural/Tubing For 602, Black
602-05DG	Binaural/Tubing For 602, Dark Green
602-07BK	ADSOFT Eartips, Black, Large
602-07G	ADSOFT Eartips, Gray, Large
602-08BK	ADSOFT Eartips, Black, Small
602-08G	ADSOFT Eartips, Gray, Small
602-09	ADSOFT Eartips, White

Accessories

600-17	Case For 602, 603, 604, 605, 612, 655
--------	---------------------------------------



ADC ADSCOPE™ 603 ADULT STETHOSCOPE

Combination adult size chestpiece precisely machined to exacting tolerances from surgical stainless steel for outstanding performance and rugged durability. Extra large bell (1 3/8" diameter) for unsurpassed low frequency response. Ultra sensitive diaphragm (1 7/8" diameter) for greater amplification and crisper high frequency response. Color coordinate non-chill bell and diaphragm retaining rim for patient comfort. Stainless steel binaurals with double leaf internal spring fixed at 15° angle for greater comfort. Reinforcing yoke molded into flexible 22" PVC "Y" tubing. ADSOFT™ deluxe PVC eartips. Spare diaphragm and scope ID tag included. Weights 6.5 oz. Overall length 31 1/2". Lifetime quality performance guarantee. Latex free.

603BD	Burgundy Stethoscope
603BK	Black Stethoscope
603DG	Dark Green Stethoscope
603FG	Frosted Glacier Stethoscope
603FL	Frosted Lilac Stethoscope
603FS	Frosted Seafoam Stethoscope
603G	Gray Stethoscope
603LV	Lavender Stethoscope
603N	Navy Stethoscope
603R	Red Stethoscope
603RB	Royal Blue Stethoscope
603TL	Teal Stethoscope

ADC ADSCOPE™ 603 ADULT STETHOSCOPE ACCESSORIES

603-01BD	Burgundy Chestpiece
603-01BK	Black Chestpiece
603-01DG	Dark Green Chestpiece
603-01FG	Frosted Glacier Chestpiece
603-01FL	Frosted Lilac Chestpiece
603-01FS	Frosted Seafoam Chestpiece
603-01G	Gray Chestpiece
603-01LV	Lavender Chestpiece
603-01N	Navy Chestpiece
603-01R	Red Chestpiece
603-01RB	Royal Blue Chestpiece
603-01TL	Teal Chestpiece
603-04BD	Burgundy Non-Chill Ring For 603 & 609
603-04BK	Black Non-Chill Ring For 603 & 609
603-04DG	Dark Green Non-Chill Ring For 603 & 609
603-04FG	Frosted Glacier Non-Chill Ring For 603 & 609
603-04FL	Frosted Lilac Non-Chill Ring For 603 & 609
603-04FS	Frosted Seafoam Non-Chill Ring For 603 & 609
603-04G	Gray Non-Chill Ring For 603 & 609
603-04LV	Lavender Non-Chill Ring For 603 & 609
603-04N	Navy Non-Chill Ring For 603 & 609
603-04R	Red Non-Chill Ring For 603 & 609
603-04RB	Royal Blue Non-Chill Ring For 603 & 609
603-04TL	Teal Non-Chill Ring For 603 & 609
603-05BD	Burgundy Binaural/Tubing
603-05BK	Black Binaural/Tubing
603-05DG	Dark Green Binaural/Tubing
603-05FG	Frosted Glacier Binaural/Tubing
603-05FL	Frosted Lilac Binaural/Tubing
603-05FS	Frosted Seafoam Binaural/Tubing
603-05G	Gray Binaural/Tubing
603-05LV	Lavender Binaural/Tubing
603-05N	Navy Binaural/Tubing
603-05R	Red Binaural/Tubing
603-05RB	Royal Blue Binaural/Tubing
603-05TL	Teal Binaural/Tubing



ADC ADSCOPE™ 604 PEDIATRIC STETHOSCOPE

Combination pediatric chestpiece precisely machined to exacting tolerances from surgical stainless steel for outstanding performance and rugged durability. Extra large bell (1 3/8" diameter) for unsurpassed low frequency response. Ultra sensitive diaphragm (1 3/4" diameter) for greater amplification and crisper high frequency transmission. Color coordinated non-chill bell and diaphragm retaining rim for patient comfort. Reinforcing yoke molded into flexible 22" PVC Y tubing. ADSOFT™ deluxe PVC eartips. Spare diaphragm included. Weighs 5.5 oz. Overall length 31". Lifetime quality performance guarantee. Latex free.

- 604BK Black Pediatric Stethoscope
- 604G Gray Pediatric Stethoscope
- 604LB Lt. Blue Pediatric Stethoscope
- 604P Pink Pediatric Stethoscope

Accessories

- 604-01BK Black Chestpiece
- 604-01G Gray Chestpiece
- 604-01LB Lt. Blue Chestpiece
- 604-01P Pink Chestpiece
- 604-02BD Burgundy Diaphragm Rim
- 604-02BK Black Diaphragm Rim
- 604-02DG Dark Green Diaphragm Rim
- 604-02G Gray Diaphragm Rim
- 604-02LB Lt. Blue Diaphragm Rim
- 604-02N Navy Diaphragm Rim
- 604-02P Pink Diaphragm Rim
- 604-03 Diaphragm For All
- 604-04BD Burgundy Non-Chill Ring
- 604-04BK Black Non-Chill Ring
- 604-04DG Dark Green Non-Chill Ring
- 604-04G Gray Non-Chill Ring
- 604-04LB Lt. Blue Non-Chill Ring
- 604-04N Navy Non-Chill Ring
- 604-04P Pink Non-Chill Ring

ADC ADSCOPE™ 605 INFANT STETHOSCOPE

Combination infant chestpiece precisely machined to exacting tolerances from surgical stainless steel for outstanding performance and rugged durability. 7/8" diameter bell provides unsurpassed low frequency response. Ultra sensitive diaphragm (1 1/8" diameter) for greater amplification and crisper high frequency transmission. Non-chill bell and diaphragm retaining rim for patient comfort. Reinforcing yoke molded into flexible 22" PVC Y tubing. ADSOFT™ deluxe PVC eartips. Spare diaphragm and scope ID tag included. Weighs 5 oz. Overall length 31". Lifetime quality performance guarantee. Latex free.

- 605BK Black Infant Stethoscope
- 605G Gray Infant Stethoscope
- 605LB Lt. Blue Infant Stethoscope
- 605P Pink Infant Stethoscope

Accessories

- 605-01BK Black Chestpiece
- 605-01G Gray Chestpiece
- 605-02BK Black Diaphragm Rim
- 605-02G Gray Diaphragm Rim
- 605-03 Diaphragm For All
- 605-04BK Black Non-Chill Ring
- 605-04G Gray Non-Chill Ring



The right equipment, at the right price.

You may not know our brands, but you most likely use our products **EVERY DAY**.



For over 2 decades healthcare professionals have relied on ADC manufactured scopes, sphygs, thermometers, laryngoscopes, and a number of other indispensable tools of the trade.

In fact, ADC is the **LEADING** manufacturer of these instruments.



You can count on our equipment to help you get the job done under the most demanding conditions. *Unrivalled quality + fair price = VALUE!*

After all, what good is the right equipment... if you can't afford it?





ADC ADSCOPE™ 609 ADSCOPE-LITE™ STETHOSCOPE

Combination adult chestpiece precisely machined to exacting tolerances from lightweight aluminum is remarkably durable, yet extraordinarily comfortable. Extra large 1 3/8" diameter bell. High sensitivity 1 3/4" diaphragm. Non-chill bell and diaphragm retaining rim for patient comfort. Double leaf internal spring binaurals are fixed at 15° angle for greater comfort. Custom molded 22" PVC tubing. ADSOFT™ PVC eartips and spare diaphragm included. Weighs 4.5 oz. Overall length 31 1/2". Five year quality performance guarantee. Latex free.

609BD	Burgundy Stethoscope
609BK	Black Stethoscope
609DG	Dark Green Stethoscope
609FG	Frosted Glacier Stethoscope
609FL	Frosted Lilac Stethoscope
609FS	Frosted Seafoam Stethoscope
609G	Gray Stethoscope
609LV	Lavender Stethoscope
609N	Navy Stethoscope
609R	Red Stethoscope
609RB	Royal Blue Stethoscope
609TL	Teal Stethoscope

Accessories

609-01BD	Burgundy Chestpiece
609-01BK	Black Chestpiece
609-01DG	Dark Green Chestpiece
609-01FG	Frosted Glacier Chestpiece
609-01FL	Frosted Lilac Chestpiece
609-01FS	Frosted Seafoam Chestpiece
609-01G	Gray Chestpiece
609-01LV	Lavender Chestpiece
609-01N	Navy Chestpiece
609-01R	Red Chestpiece
609-01RB	Royal Blue Chestpiece
609-01TL	Teal Chestpiece
609-03	Diaphragm For All
609-05BD	Burgundy Binaural/Tubing
609-05BK	Black Binaural/Tubing
609-05DG	Dark Green Binaural/Tubing
609-05FG	Frosted Glacier Binaural/Tubing
609-05FL	Frosted Lilac Binaural/Tubing
609-05FS	Frosted Seafoam Binaural/Tubing
609-05G	Gray Binaural/Tubing
609-05LV	Lavender Binaural/Tubing
609-05N	Navy Binaural/Tubing
609-05R	Red Binaural/Tubing
609-05RB	Royal Blue Binaural/Tubing
609-05TL	Teal Binaural/Tubing

ADC NURSE COMBO-ONE

Pal™ Sprague-One single tube Sprague scope with 5 interchangeable chestpiece fittings for the ultimate in versatility. Pocket Pal II kit complete with Velcro® tabs color-matched to the scope. Kit features 5 slide-in and one covered pocket in front, 1 in rear, 5 1/2" Lister scissors, three color pen, and Adlite™ disposable diagnostic penlight included. Assembled, inspected, and packaged in the U.S.A.

116-647BKQ	Nurse Combo-One, Black
116-647DGQ	Nurse Combo-One, Dark Green
116-647NQ	Nurse Combo-One, Navy
116-647RBQ	Nurse Combo-One, Royal Blue
116-647VQ	Nurse Combo-One, Purple



ADC ADSCOPE™ 655 VISTASCOPE™ STETHOSCOPE

Diaphragm only type chestpiece fabricated from lightweight acrylic provides up to twice the amplification of conventional acoustic scopes. No electronics to malfunction, no batteries to wear out. Stainless steel binaural with double leaf internal spring fixed at 15° angle for greater comfort. Reinforcing yoke molded into flexible 22" PVC Y tubing. ADSOFT™ deluxe PVC eartips in small and large size. Scope ID tag included. Weighs 5 oz. Overall length 31". Lifetime quality performance guarantee. Latex free.

655BD	Burgundy Stethoscope
655BK	Black Stethoscope
655DG	Dark Green Stethoscope
655N	Navy Stethoscope
655R	Red Stethoscope
655RB	Royal Blue Stethoscope

ADC ADSCOPE™ 655 AMPLIFYING STETHOSCOPE ACCESSORIES

655-01	Chestpiece For 655
655-02	Retaining Ring For 655
655-03K	Diaphragm Kit For 655

ADC ADSCOPE™ ADVANCED ELECTRONIC SCOPE

The next generation in electronic stethoscopy combining impressive acoustic amplification, electronic noise filtering, and comfortable ergonomic design. Amplifies up to 16x (24db) over traditional acoustic scopes. Patented piezopolymer film contact microphone provides wider frequency response than acoustic mikes used in competing models. Three frequency modes: Bell (15-200Hz) for cardiac sounds, Diaphragm: 100-500Hz for lung sounds, Extended Range: 15-1000Hz allows the practitioner widest frequency response). 8 level volume control. Holds last mode and volume setting for convenience. Auto-shut off after 3 minutes extends battery life. Battery warning LED signals when replacement is needed. Binaurals fixed at 15° angle for snug anural fit. Specially constructed Adsoft™ PVC eartips for the ultimate in wearing comfort and acoustic seal. Lightweight and compact-weighs under 6oz., measures just 28". Uses AAA Lithium battery (included). Two year warranty. Made in Korea, Inspected in U.S.A.

657BK	Advanced Electronic Scope, Black
-------	----------------------------------



ADC PROSCOPE™ NURSESCOPE

Diaphragm only aluminum chestpiece. Adjustable aluminum binaurals. Flexible 22" PVC Y tubing. White plastic eartips. Overall length 31". Latex free.

660BD	Burgundy Nursescope
660BK	Black Nursescope
660DG	Dark Green Nursescope
660G	Gray Nursescope
660GD	Gold Nursescope
660GR	Green Nursescope
660LB	Light Blue Nursescope
660LV	Lavender Nursescope
660M	Magenta Nursescope
660N	Navy Nursescope
660NO	Neon Orange Nursescope
660NP	Neon Pink Nursescope
660NY	Neon Yellow Nursescope
660OD	Orchid Nursescope
660P	Pink Nursescope
660R	Red Nursescope
660RB	Royal Blue Nursescope
660TL	Teal Nursescope
660V	Purple Nursescope
660W	White Nursescope
660Y	Yellow Nursescope

Accessories

660-01	Chestpiece For 660 & 661
660-05	Binaurals For PROSCOPES
660-05S	Binaural Spring For 660-05 Only
660-05TBD	Y Tubing For PROSCOPES, Burgundy
660-05TBK	Y Tubing For PROSCOPES, Black
660-05TDG	Y Tubing For PROSCOPES, Dark Green
660-05TG	Y Tubing For PROSCOPES, Gray
660-05TGD	Y Tubing For PROSCOPES, Gold
660-05TGR	Y Tubing For PROSCOPES, Green
660-05TLB	Y Tubing For PROSCOPES, Light Blue
660-05TLV	Y Tubing For PROSCOPES, Lavender
660-05TM	Y Tubing For PROSCOPES, Magenta
660-05TN	Y Tubing For PROSCOPES, Navy
660-05TNO	Y Tubing For PROSCOPES, Neon Orange
660-05TNP	Y Tubing For PROSCOPES, Neon Pink
660-05TNY	Y Tubing For PROSCOPES, Neon Yellow
660-05TOD	Y Tubing For PROSCOPES, Orchid
660-05TP	Y Tubing For PROSCOPES, Pink
660-05TR	Y Tubing For PROSCOPES, Red
660-05TRB	Y Tubing For PROSCOPES, Royal Blue
660-05TTL	Y Tubing For PROSCOPES, Teal
660-05TV	Y Tubing For PROSCOPES, Purple
660-05TW	Y Tubing For PROSCOPES, White
660-05TY	Y Tubing For PROSCOPES, Yellow
660-06	Eartips For PROSCOPES, White



ADC PROSCOPE™ TEACHING STETHOSCOPE

Choice of diaphragm only (660 Series) or combination diaphragm/bell (670 Series) PROSCOPE™ chestpiece. Two sets of adjustable aluminum binaurals. Two sets of flexible 22" and one straight 10" length of black PVC tubing. Two spare pairs of black mushroom eartips included. Overall length 39". Inspected and packaged in the U.S.A. One year quality performance guarantee. Latex free.

661	PROSCOPE™ 661 Teaching Scope, Nurse Style
671	PROSCOPE™ 671 Teaching Scope, Dualhead

Accessories

661-02	Diaphragm Retaining Ring For 660, 661, 670, 671
661-03	Diaphragm For 660, 661, 670, 671



ADC PROSCOPE™ 662 BOWLES STETHOSCOPE

Chrome plate zinc diaphragm only chestpiece with traditional raised stem design. Adjustable aluminum binaurals. Flexible 22" black PVC tubing. Overall length 31". Inspected and packaged in the U.S.A. One year quality performance guarantee. Latex free.

662	PROSCOPE™ 662 Scope, Black
-----	----------------------------

Accessories

662-01	Chestpiece For 662
662-02	Diaphragm Retaining Ring For 662
662-03	Diaphragm For 662

ADC PROSCOPE™ 664Y DISPOSABLE STETHOSCOPE

Diaphragm only disposable ABS chestpiece with non-chill rim for patient comfort. 22" PVC Yellow Y-tubing. Aluminum binaurals. Weighs 2.5 oz, measures 32".

664Y	Proscope™ 664Y, Disposable Scope
------	----------------------------------



ADC PROSCOPE™ DUAL-HEAD STETHOSCOPES

Combination diaphragm/bell chestpiece for wide frequency response. Bell and diaphragm equipped with non-chill ring for patient comfort. Lightweight, durable construction. Adjustable aluminum binaurals. Flexible 22" PVC tubing. Plastic eartips. Weighs 4 oz. Overall length 31 1/2". Latex free.

670BD	Burgundy Stethoscope
670BK	Black Stethoscope
670DG	Dark Green Stethoscope
670G	Gray Stethoscope
670GD	Gold Stethoscope
670GR	Green Stethoscope
670LB	Light Blue Stethoscope
670LV	Lavender Stethoscope
670M	Magenta Stethoscope
670N	Navy Stethoscope
670NO	Neon Orange Stethoscope
670NP	Neon Pink Stethoscope
670NY	Neon Yellow Stethoscope
670OD	Orchid Stethoscope
670P	Pink Stethoscope
670R	Red Stethoscope
670RB	Royal Blue Stethoscope
670TL	Teal Stethoscope
670V	Purple Stethoscope
670W	White Stethoscope
670Y	Yellow Stethoscope

Accessories

670-01	Chestpiece For 670 & 671
670-04	Non-Chill Ring For 670 & 671

ADC PROSCOPE™ INFANT STETHOSCOPES

Infant sized, combination diaphragm/bell chestpiece for wide frequency response. 25mm diaphragm/bell equipped with non-chill ring for patient comfort. Chrome-plated brass chestpiece. Adjustable aluminum binaurals. Flexible 22" PVC Y tubing. White plastic eartips. Weighs 4 oz. Overall length 31". Latex free system.

676BD	Burgundy Stethoscope
676BK	Black Stethoscope
676DG	Dark Green Stethoscope
676G	Gray Stethoscope
676GD	Gold Stethoscope
676GR	Green Stethoscope
676LB	Light Blue Stethoscope
676LV	Lavender Stethoscope
676M	Magenta Stethoscope
676N	Navy Stethoscope
676NO	Neon Orange Stethoscope
676NP	Neon Pink Stethoscope
676NY	Neon Yellow Stethoscope
676OD	Orchid Stethoscope
676P	Pink Stethoscope
676R	Red Stethoscope
676RB	Royal Blue Stethoscope
676TL	Teal Stethoscope
676V	Purple Stethoscope
676W	White Stethoscope
676Y	Yellow Stethoscope

ADC NURSE COMBO-LITE

Combines the Pocket Pal II™ Kit complete with three instruments and choice of 8 Velcro® tag colors with a PROSCOPE™ 670 dualhead scope with lightweight aluminum construction and 22" PVC tubing color coordinated to the Velcro® tags.

116-670BDQ	Nurse Combo-Lite, Burgundy
116-670BKQ	Nurse Combo-Lite, Black
116-670DGQ	Nurse Combo-Lite, Dark Green
116-670NQ	Nurse Combo-Lite, Navy
116-670NYQ	Nurse Combo-Lite, Neon Yellow
116-670RBQ	Nurse Combo-Lite, Royal Blue
116-670TLQ	Nurse Combo-Lite, Teal
116-670VQ	Nurse Combo-Lite, Purple

Personal Attention Local Service



ADC PROSCOPE™ PEDIATRIC STETHOSCOPES

Pediatric sized, combination diaphragm/bell chestpiece for wide frequency response. 1 1/4" diaphragm 3/4" bell equipped with non-chill ring for patient comfort. Non-chill rim. Lightweight aluminum construction. Adjustable aluminum binaurals. Flexible 22" PVC Y tubing. White plastic eartips. Overall length 30". Latex free.

675BD	Burgundy Stethoscope
675BK	Black Stethoscope
675DG	Dark Green Stethoscope
675G	Gray Stethoscope
675GD	Gold Stethoscope
675GR	Green Stethoscope
675LB	Light Blue Stethoscope
675LV	Lavender Stethoscope
675M	Magenta Stethoscope
675N	Navy Stethoscope
675NO	Neon Orange Stethoscope
675NP	Neon Pink Stethoscope
675NY	Neon Yellow Stethoscope
675OD	Orchid Stethoscope
675P	Pink Stethoscope
675R	Red Stethoscope
675RB	Royal Blue Stethoscope
675TL	Teal Stethoscope
675V	Purple Stethoscope
675WV	White Stethoscope
675Y	Yellow Stethoscope

Accessories

675-01	Chestpiece For 675
675-02	Diaphragm Retaining Ring For 675
675-03	Diaphragm For 675
675-04	Non-Chill Ring For 675

ADC PROSCOPE™ INFANT STETHOSCOPE ACCESSORIES

676-01	Chestpiece For 676
676-02	Diaphragm Retaining Ring For 676
676-03	Diaphragm For 676
676-04G	Non-Chill ring For 676

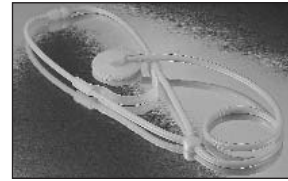

ADC ADSCOPE™ 665 DISPOSABLE STETHOSCOPE

Nurse style diaphragm only single patient use scope. Acrylresin construction throughout is super-lightweight. Non-toxic. ETO sterilizable. May be safely incinerated. Weighs about 1.5 oz for comfort, yet is remarkably durable. Ultra sensitive diaphragm for outstanding acoustic performance. Individually packaged in a sealed polybag. Available in yellow and royal blue. Latex free.

665RB-10	Single Patient Use Scope, Royal Blue, 10/ctn
665RB-100	Single Patient Use Scope, Royal Blue, 100/cs
665Y-10	Single Patient Use Scope, Yellow, 10/ctn
665Y-100	Single Patient Use Scope, Yellow, 100/cs
697BK	Premium Stethoscope ID Tag
698BK	Stethoscope ID Tag



5079-135



5079-149

WELCH ALLYN SPECTRUM™ DOUBLE-HEAD STETHOSCOPES

The full-range Spectrum stethoscope is for professionals who demand the best in auscultation and comfort. Superior acoustics mean accurate auscultation of heart, lung and blood pressure sounds. Binaurals adjust to angle of ear. Stainless steel chestpiece. Portable and durable. Five year warranty.

5079-135	28" Adult Black Stethoscope
5079-137	28" Adult Navy Stethoscope
5079-139	28" Adult Burgundy Stethoscope
5079-145	28" Pediatric Black Stethoscope
5079-147	28" Pediatric Navy Stethoscope
5079-149	28" Pediatric Burgundy Stethoscope
5079-285	28" Adult Forest Green Stethoscope
5079-287	28" Pediatric Forest Green Stethoscope
5079-289	28" Adult Blue Stethoscope
5079-291	28" Pediatric Blue Stethoscope

WELCH ALLYN SPECTRUM™ ACCESSORIES & PARTS

5079-170	Comfort Sealing Eartips, Large
5079-172	Hard Eartips, Medium
5079-173	Hard Eartips, Large
5079-180	Adult Bell, Non-Chill Rim, Black
5079-181	Adult Bell, Non-Chill Rim, Gray
5079-182	Pediatric Bell, Non-Chill Rim, Black
5079-183	Pediatric Bell, Non-Chill Rim, Gray
5079-195	Binaural/Spring Assembly & Tubing, 28", Black
5079-196	Binaural/Spring Assembly & Tubing, 28", Gray
5079-197	Binaural/Spring Assembly & Tubing, 28", Navy
5079-199	Binaural/Spring Assembly & Tubing, 28", Burgundy
5079-210	Double-Head Chestpiece Assembly, Adult, Gray
5079-211	Double-Head Chestpiece Assembly, Adult, Black
5079-214	Double-Head Chestpiece Assembly, Pediatric, Black
5079-215	Double-Head Chestpiece Assembly, Pediatric, Gray
5079-313	Comfort Sealing Eartips, Small

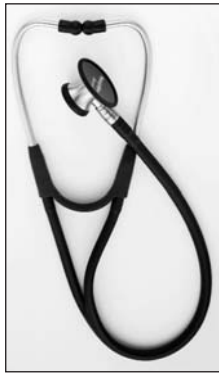

WELCH ALLYN ELITE® STETHOSCOPE

Stainless steel chestpiece and binaurals designed for optimal weight and durability. Dual-channel PVC tubing provides separate sound pathways to each ear. Triple-leaf binaural spring encased in polyurethane permits size adjustment while preventing breakage. Ten year warranty.

5079-122	28" Stethoscope, Black
5079-125	28" Stethoscope, Black
5079-125P	28" Stethoscope, Pediatric, Black
5079-270	28" Stethoscope, Burgundy
5079-271	28" Stethoscope, Navy
5079-284	28" Stethoscope, Forest Green



WELCH ALLYN ELITE® STETHOSCOPE ACCESSORIES

5079-108	Nametag
5079-115	Pediatric Diaphragm Assembly, Black
5079-116	Adult Diaphragm Assembly, Black
5079-117	Pediatric Bell, Non-Chill Rim, Black
5079-118	Adult Bell, Non-Chill Rim, Black
5079-119	22" Tubing, Black
5079-120	28" Tubing, Black
5079-121	Binaural/Spring Assembly, Black
5079-123	Adult Diaphragm Disc Only
5079-124	Pediatric Diaphragm Disc Only
5079-126	Adult Diaphragm, Non-Chill Rim, Black
5079-127	Pediatric Diaphragm, Non-Chill Rim, Black
5079-184	Adult Diaphragm, Non-Chill Rim, Gray
5079-185	Pediatric Diaphragm, Non-Chill Rim, Gray
5079-232	Accessory Kit, Black, Includes a Pediatric Diaphragm, Bell Ring & 3 Additional Set of Eartips
5079-233	Comfort Sealing Eartips, Gray
5079-272	25" Tubing, Burgundy
5079-273	28" Tubing, Navy
5079-274	Binaural/Spring Assembly, Burgundy, 28"
5079-275	Binaural/Spring Assembly, Navy
5079-276	Pediatric Bell, Non-Chill Rim, Gray
5079-277	Adult Bell, Non-Chill Rim, Gray
5079-278	Pediatric Diaphragm Assembly, Gray
5079-279	Adult Diaphragm Assembly, Gray
5079-280	Elite Accessory Kit, Gray, Includes Pediatric Diaphragm, Bell Ring & 3 Additional Sets of Eartips
5079-305	25" Tubing, Forest Green
5079-307	Binaural/Spring Assembly, Forest Green, 28"
5079-314	Comfort Sealing Eartips, Small
5079-66	Hard Eartips, Large



5079-321



5079-325

WELCH ALLYN HARVEY DELUXE DOUBLE AND TRIPLE HEAD STETHOSCOPES

The Harvey™ DLX Stethoscope is our most prestigious and durable model with dual-lumen PVC tubing, brass chestpieces and binaurals, and triple-leaf binaural springs. Optimized for listening to higher frequency and critically important sounds like murmurs, clicks, and ejection sounds. Provides clear transmission of the first and second heart sounds. Ideally sized bell bridges intercostal space between the ribs. Tightly constrained diaphragm provides superior response at large frequencies. Additional corrugated diaphragm for detecting mid-range and low frequencies.

5079-321	Harvey Deluxe Triple Head Stethoscope, Black, 28"
5079-322	Harvey Deluxe Triple Head Stethoscope, Burgundy, 28"
5079-323	Harvey Deluxe Triple Head Stethoscope, Navy, 28"
5079-324	Harvey Deluxe Triple Head Stethoscope, Forest Green, 28"
5079-325	Harvey Deluxe Double Head Stethoscope, Black, 28"
5079-326	Harvey Deluxe Double Head Stethoscope, Burgundy, 28"
5079-327	Harvey Deluxe Double Head Stethoscope, Navy, 28"
5079-328	Harvey Deluxe Double Head Stethoscope, Forest Green, 28"



WELCH ALLYN ORIGINAL HARVEY DOUBLE & TRIPLE HEAD STETHOSCOPE ACCESSORIES

5079-05	Corrugated Diaphragm Only
5079-09	Flat Pediatric Chestpiece
5079-102	Tubing, 2 Tubes Joined For Use w/two-piece spindle
5079-103	Name Clip For Use w/5079-102 & 105
5079-104	Flat Diaphragm Only
5079-105	Tubing, 2 Tubes Joined For Use w/single-piece spindle
5079-11	Pediatric Diaphragm Only
5079-20	Accessory Kit, Includes 1 Pediatric Chestpiece, 1 Flat Diaphragm, 2 Corrugated Diaphragms, 1 Pair Soft Rubber Eartips, 1 Pair Small Delrin Eartips
5079-315	Accessory Kit
5079-318	Bell Chestpiece Assembly
5079-33	Eartips, Small, White, Pair
5079-61	Corrugated Adult Chestpiece
5079-62	Flat Adult Chestpiece
5079-63	Tubing, 2 Separate Tubes For Use w/two-piece spindle
5079-65	Bell Chest Piece

WELCH ALLYN MEDITRON™ ELECTRONIC STETHOSCOPE SYSTEM

Welch Allyn has teamed up with Meditron AS of Norway to provide the first computer power and Auscultation combination. A unique, patented listening system that dramatically enhances sound clarity. Ideal educational tool. Records sounds and images and speeds consultant review and future analysis (based on Microsoft™ wav files). Should be used by any physical examination where additional amplification is required, including doctor's offices, EMS sites, veterinarian's office, tele-medicine site, hospitals, and medical schools. Reimbursement is the same as regular physical examination (multiple codes). 200 hours or four years of use from the battery. Excellent for use with difficult patients (weak sounds, obese patients, children). May be cleaned with a lightly moistened cotton wipe using chlorhexidine or alcohol. Does not contain any latex.

5079-401	Accessory Package
5079-414	Headset For Additional Users
5079-430	Analyzer Software Accessory

WELCH ALLYN TYCOS® UNISCOPE DISPOSABLE STETHOSCOPE

17461	Adult Stethoscope, Yellow
17462P	Pediatric Stethoscope, Lt. Blue



3M™ LITTMANN® SELECT STETHOSCOPES

A convenient tunable diaphragm in a single-sided coated alloy chestpiece providing reliable and clear acoustics.

2290	Select Stethoscope, 28" Black Tubing
2291	Select Stethoscope, 28" Caribbean Blue
2293	Select Stethoscope, 28" Burgundy Tubing
2294	Select Stethoscope, 28" Purple Tubing
2296	Select Stethoscope, 28" Raspberry Tubing
2298	Select Stethoscope, 28" Royal Blue Tubing
2301	Select Stethoscope, 28", Ciel Blue Tubing
2302	Select Stethoscope, 28", Seafoam Green Tubing
2303	Select Stethoscope, 28", Lilac Tubing
2305	Select Stethoscope, 28", Pine Green Tubing
2306	Select Stethoscope, 28", Ocean Blue Tubing
2310	Select Stethoscope, 28", Peach Tubing



3M™ LITTMANN® CLASSIC II S.E. STETHOSCOPE

Features a two-sided chestpiece that offers high acoustic sensitivity for superior performance. The tunable diaphragm on one side augments the traditional bell function of the opposite side. Single-lumen tubing.

2201	S.E. Stethoscope, 28" Black Tubing
2203	S.E. Stethoscope, 28" Gray Tubing
2205	S.E. Stethoscope, 28" Navy Blue Tubing
2206	S.E. Stethoscope, 28" Caribbean Blue Tubing
2208	S.E. Stethoscope, 28" Hunter Green Tubing
2209	S.E. Stethoscope, 28" Purple Tubing
2210	S.E. Stethoscope, 28" Raspberry
2211	S.E. Stethoscope, 28" Burgundy Tubing
2218BE	S.E. Stethoscope, Classic II, Black
2812	S.E. Stethoscope, 28", Orange Tubing
2813	S.E. Stethoscope, 28", Blue Tubing
2814	S.E. Stethoscope, 28", Seafoam Green Tubing
2815	S.E. Stethoscope, 28" Pink Tubing
2818	Classic II S.E. Stethoscope, 28", Pine Green Tubing

3M™ LITTMANN® LIGHTWEIGHT II S.E. STETHOSCOPES

A general-purpose stethoscope that offers a traditional bell and diaphragm with an aluminum chestpiece to provide acoustic sensitivity.

2450	Lightweight Stethoscope, 28" Black Tubing
2451	Lightweight Stethoscope, 28" Burgundy Tubing
2452	Lightweight Stethoscope, 28" Caribbean Blue Tubing
2453	Lightweight Stethoscope, 28" Lilac Tubing
2454	Lightweight Stethoscope, 28" Ceil Blue Tubing
2455	Lightweight Stethoscope, 28" Sea Foam Green Tubing



3M™ LITTMANN® CLASSIC II PEDIATRIC & INFANT STETHOSCOPES

Two-sided models with traditional bell/diaphragm chestpieces are designed, sized and acoustically precise for children and infants. Feature patented Littmann Snap Tight soft-sealing eartips plus patient-friendly nonchill rim. Three-year warranty plus a lifetime service and repair policy.

2113	Pediatric Stethoscope, 28" Black Tubing
2113R	Pediatric Stethoscope, 28" Red Tubing
2114	Infant Stethoscope, 28" Black Tubing
2114R	Infant Stethoscope, 28" Red Tubing
2119	Pediatric Stethoscope, 28" Caribbean Blue Tubing
2122	Pediatric Stethoscope, 28" Raspberry Tubing
2123	Pediatric Stethoscope, 28", Navy Blue Tubing
2124	Infant Stethoscope, 28" Caribbean Blue Tubing
2125	Infant Stethoscope, 28" Raspberry Tubing
2126	Infant Stethoscope, 28", Lilac Tubing
2131	Pediatric Stethoscope, 28", Pine Green Tubing
2132	Infant Stethoscope, 28", Pine Green Tubing



3M™ LITTMANN® MASTER CLASSIC II STETHOSCOPE

The excellent acoustic sensitivity of a patented tunable diaphragm is the hallmark of the low-profile Littmann Master Classic II. Award-winning design combines high performance with portable convenience in this single-sided stethoscope. Features patented Littmann Snap Tight soft-sealing eartips, patient friendly, nonchill rim and diaphragm. Three-year warranty, plus lifetime service and repair policy.

- 2141 Master Classic II Stethoscope, 27" Black Plated Chestpiece & Ear tubes
- 2142G Master Classic II Stethoscope, 27" Gold-Plated Chestpiece & Ear tubes
- 2143 Master Classic II Stethoscope, 27" Purple Tubing
- 2144L Master Classic II Stethoscope, 27" Black Tubing
- 2146 Master Classic II Stethoscope, 27" Burgundy Tubing
- 2147 Master Classic II Stethoscope, 27" Navy Blue Tubing
- 2630 Master Classic II Stethoscope, 27" Caribbean Blue Tubing
- 2632 Master Classic II Stethoscope, 27" Hunter Green Tubing
- 2633 Master Classic II Stethoscope, 27", Ceil Blue Tubing
- 2634 Stethoscope, Master Classic II, 27", Pine Green Tubing



3M™ LITTMANN® MASTER CARDIOLOGY STETHOSCOPE

A patented tunable diaphragm and superb craftsmanship offer the ultimate performance in a superior-single sided stethoscope meets the exacting standards of health care professionals who demand the highest acoustic response. Features patented Littmann Snap Tight soft-sealing eartips, patient-friendly, nonchill rim and diaphragm and special procedures adapter. Seven-year warranty, plus lifetime service and repair policy.

- 2159 Cardiology Stethoscope, 22" Black Tubing
- 2160 Cardiology Stethoscope, 27" Black Tubing
- 2161 Cardiology Stethoscope, 27" Black Plated Chestpiece & Ear tubes
- 2163 Cardiology Stethoscope, 27" Burgundy Tubing
- 2164 Cardiology Stethoscope, 27" Navy Blue Tubing
- 2165 Cardiology Stethoscope, 27" Hunter Green Tubing
- 2167 Cardiology Stethoscope, 27" Plum Tubing
- 2168 Stethoscope, Cardiology, 27" Gray Tubing
- 2169 Stethoscope, Cardiology, 27" Chocolate Tubing



3M™ LITTMANN® CARDIOLOGY III STETHOSCOPE

Offers two tunable diaphragms which allows the user to conveniently alternate between low- and high-frequency sounds without turning over the chest piece. The large side can be used for adult patients, while the small side is especially useful for pediatric or thin patients, around bandages, and for carotid assessment. Recommended for cardiology and high performance adult and pediatric use. Dual-lumen tubing.

- 3127 Cardiology Stethoscope, 22" Black Tubing
- 3128 Cardiology Stethoscope, 27" Black Tubing
- 3129 Cardiology Stethoscope, 27" Burgundy Tubing
- 3130 Cardiology Stethoscope, 27" Navy Blue Tubing
- 3131BE Stethoscope, Cardiology & High Performance, Adult & Pediatric Use, Black
- 3134 Cardiology Stethoscope, 27" Hunter Green Tubing
- 3135 Cardiology Stethoscope, 27", Plum Tubing
- 3136 Stethoscope, Cardiology III, 27" Gray Tubing
- 3137 Stethoscope, Cardiology III, 27" Chocolate Tubing

3M™ LITTMANN® CARDIOLOGY S.T.C. STETHOSCOPES

Outstanding acoustics are combined with a unique and easy to grasp chestpiece that allows easy movement between auscultation sites. Single-sided chestpiece provides both bell and diaphragm frequency responses. Dual lumen design helps to eliminate noise artifact. Comfortably angled, anatomically correct headset. Patient-friendly, nonchill rim. Six-year warranty.

- 4471 27" Black Cardiology S.T.C. Stethoscope
- 4472 27" Burgundy Cardiology S.T.C. Stethoscope
- 4473 27" Navy Blue Cardiology S.T.C. Stethoscope
- 4475 27" Plum Cardiology S.T.C. Stethoscope
- 4476 Stethoscope, 27", Gray Tube, Cardiology S.T.C.
- 4477 Stethoscope, 27", Chocolate Tube, Cardiology S.T.C.

3M™ LITTMANN® ELECTRONIC STETHOSCOPE MODEL 3000

Ambient Noise Reduction (ANR) reduces distracting room noise by an average of 75% (-12dB) without eliminating critical body sounds. Amplification up to 18 times greater than the best non-electronic stethoscopes. Ergonomic, one-button control allows you to adjust volume and frequency mode with one finger. Traditional cardiology tube set allows scope to easily fold and be placed in pocket. Single AAA battery provides up to 200 hours (approximately 6 months) of use. Two-year warranty.

- 3000BK29 Electronic Stethoscope Model 3000 w/ambient noise reduction, 29", Black Tube
- 3000BU Electronic Stethoscope Model 3000 w/ambient noise reduction, 29", Burgundy Tube
- 3000CH Electronic Stethoscope Model 3000 w/ambient noise reduction, 29", Chocolate Tube
- 3000GR Electronic Stethoscope Model 3000 w/ambient noise reduction, 29", Gray Tube
- 3000HG Electronic Stethoscope Model 3000 w/ambient noise reduction, 29", Hunter Green Tube
- 3000NB Electronic Stethoscope Model 3000 w/ambient noise reduction, 29", Navy Tube
- 3000PL Electronic Stethoscope Model 3000 w/ambient noise reduction, 29", Plum Tube

Stethoscopes

3M™ LITTMANN® ELECTRONIC STETHOSCOPE MODEL 4100WS

Amplification up to 18 times greater than the best non-electronic stethoscopes. 3 frequency modes: bell, diaphragm and extended range. Recording, storage and playback on six distinct tracks of eight seconds, each without any PC connection. Instant playback of recordings at normal and half speed. Permits infrared transmission of digital recordings to another Model 4000 or 4100, or IBM-compatible PC or Pocket PC. Twenty hours of continuous use from just two AAA alkaline batteries. Two-year warranty.

4100WS Electronic Stethoscope Model 4100WS w/sound analysis software, Version 2.0 for Heart Sounds, 27", Black Tube



3M™ LITTMANN® TEACHING STETHOSCOPES

A stethoscope with two headsets which allow instructor and student to perform simultaneous auscultation. Patented tunable diaphragms.

- 2138 Classic II S.E. Teaching Stethoscope, Bell & Diaphragm w/2 headsets, 40" 1 Tube Black, 1 Tube Burgundy
- 2139 Master Classic II Teaching Stethoscope, Single-Sided Chestpiece w/2 headsets, 40" 1 Tube Black, 1 Tube Burgundy

3M™ LITTMANN® VETERINARIAN STETHOSCOPES

- 1392 Vet Stethoscope, Master Classic II, Single-Sided Chestpiece, 32" Navy Tubing



3M™ LITTMANN® STETHOSCOPE NONCHILL BELL SLEEVES

For use with traditional two-sided chestpieces on 3M Littmann™ stethoscopes.

- 36544 Stethoscope Nonchill Bell Sleeves For Classic II S.E., Classic II & Lightweight, Black, 10/bg
- 36545 Stethoscope Nonchill Bell Sleeves For Classic II S.E., Classic II & Lightweight, Gray, 10/bg
- 36546 Stethoscope Nonchill Bell Sleeves For Classic II Pediatric, Black, 5/bg
- 36547 Stethoscope Nonchill Bell Sleeves For Classic II Infant, Black, 5/bg
- 36568 Stethoscope Nonchill Bell Sleeves For Classic II Pediatric, Gray, 5/bg
- 36569 Stethoscope Nonchill Bell Sleeves For Classic II Infant, Gray, 5/bg
- 36570 Stethoscope Nonchill Bell Sleeves For Cardiology III, Cardiology II S.E. & Cardiology II, Black, 10/bg
- 36571 Stethoscope Nonchill Bell Sleeves For Cardiology III, Cardiology II S.E. & Cardiology II, Gray, 10/bg
- 51162 Stethoscope Nonchill Bell Sleeve For Littmann Lightweight II S.E. Stethoscope, Black, 10/bg
- 51163 Stethoscope Nonchill Bell Sleeve For Littmann Lightweight II S.E. Stethoscope, Light Brown, 10/bg

3M™ LITTMANN® STETHOSCOPE REPAIR KIT CASE

- 44525 Stethoscope Repair Kit Case

3M™ LITTMANN® STETHOSCOPE SNAP-ON RIMS

- 36548 Stethoscope Snap-On Rims For Cardiology III (large side), Cardiology II S.E., Classic II S.E., Select & Lightweight, Black, 10/bg
- 36549 Stethoscope Snap-On Rims For Cardiology III (large side), Cardiology II S.E., Classic II S.E., Select & Lightweight, Gray, 10/bg
- 36550 Stethoscope Snap-On Rims For Cardiology III (small side) & Classic II Pediatric, Black, 5/bg
- 36551 Stethoscope Snap-On Rims For Cardiology III (small side) & Classic II Pediatric, Gray, 5/bg
- 36552 Stethoscope Snap-On Rims For Classic II Infant, Black, 5/bg
- 36553 Stethoscope Snap-On Rims For Classic II Infant, Gray, 5/bg

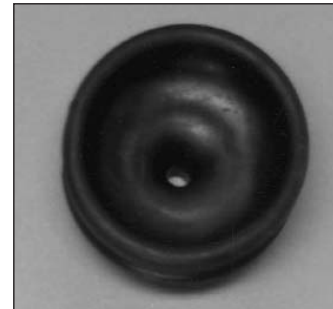

3M™ LITTMANN® STETHOSCOPE SPECIAL PROCEDURE ADAPTORS

- 36563 Stethoscope Adaptors For Cardiology II S.E. & Cardiology II, Black, 3/bg
- 36564 Stethoscope Adaptors For Cardiology II S.E. & Cardiology II, Gray, 3/bg
- 36565 Stethoscope Adaptors For Master Cardiology, Black, 3/bg
- 36566 Stethoscope Adaptors For Master Cardiology, Gray, 3/bg



3M™ LITTMANN® TUNABLE DIAPHRAGM & RIM ASSEMBLY

- 36554 Diaphragm & Rim Assembly For Master Cardiology, Black Rim, 5/bg
- 36555 Diaphragm & Rim Assembly For Master Cardiology, Gray Rim, 5/bg
- 36556 Diaphragm & Rim Assembly For Cardiology III (large side), Cardiology II S.E., Master Classic II, Classic II S.E. & Select, Black Rim, 5/bg
- 36557 Diaphragm & Rim Assembly For Cardiology III (large side), Cardiology II S.E., Master Classic II, Classic II S.E. & Select, Gray Rim, 5/bg
- 36572 Diaphragm & Rim Assembly For Cardiology III (small side), Black Rim, 5/bg
- 36573 Diaphragm & Rim Assembly For Cardiology III (small side), Gray Rim, 5/bg
- 51159 Diaphragm & Rim Assembly For Littmann Lightweight II S.E. Stethoscope, Black Rim, 5/bg
- 51160 Diaphragm & Rim Assembly For Littmann Lightweight II S.E. Stethoscope, Light Brown Rim, 5/bg
- 51185 Diaphragm & Rim Assembly For Littmann Cardiology S.T.C., Black Rim, 5/bg

3M™ LITTMANN® STETHOSCOPE BINAURALS

Includes eartips, eartubes and tubing.

1223761252	Binaurals For Select & Lightweight, 28" Light Blue
1223768527	Binaurals For Classic II S.E., Classic II & Classic II Pediatric & Infant, 28" Black
1223768528	Binaurals For Classic II S.E., Classic II & Classic II Pediatric & Infant, 28" Gray
1223768532	Binaurals For Classic II S.E., Classic II & Classic II Pediatric & Infant, 28" Red
1223768533	Binaurals For Classic II S.E., Classic II & Classic II Pediatric & Infant, 28" Burgundy
78806297442	Binaurals For Master Classic II, 27" Navy
78806297459	Binaurals For Master Classic II, 27" Burgundy
78806299273	Binaurals For Master Classic II, 27" Black
78806311375	Binaurals For Master Classic II, 27" Black, Black Plated Ear tubes
78806311425	Binaurals For Master Classic II, 27" Black, 23 Karat Gold-Plated Ear tubes
78807802844	Binaurals For Teaching Stethoscope, 40" Black w/2 headsets For Classic II S.E.
78807802851	Binaurals For Teaching Stethoscope, 40" Black w/2headsets For Master Classic II
78807833831	Binaural Assembly For Littmann Master Classic II Veterinarian Stethoscope, 32" Navy Blue
78807845165	Binaurals For Classic II S.E., Classic II & Classic II Pediatric & Infant, 28" Royal Blue
78807858465	Binaurals For Master Classic II, 27" Purple
78807865023	Binaurals For Classic II S.E., Classic II & Classic II Pediatric & Infant, 28" Hunter Green
78807865031	Binaurals For Classic II S.E., Classic II & Classic II Pediatric & Infant, 28" Purple
78807865825	Binaurals For Master Cardiology, Cardiology III & Cardiology II S.E., 22" Black, Short
78807865833	Binaurals For Master Cardiology, Cardiology III & Cardiology II S.E., 27" Black
7880786584	Stethoscope, Binaurals For Master Cardiology™ Cardiology III & Cardiology II SE, 27", Gray Tube, Gray Eartips
78807865858	Binaurals For Master Cardiology, Cardiology III & Cardiology II S.E., 27" Navy
78807865866	Binaurals For Master Cardiology, Cardiology III & Cardiology II S.E.,
78807865874	Binaurals For Master Cardiology, Cardiology III & Cardiology II S.E., 27" Hunter Green
78807866211	Binaurals For Master Cardiology, Cardiology III & Cardiology II S.E., 27" Black, Black Plated Ear tubes
78807886359	Binaurals For Classic II S.E., Classic II & Classic II Pediatric & Infant, 28" Raspberry
78807886367	Binaurals For Classic II S.E., Classic II & Classic II Pediatric & Infant, 28" Caribbean Blue
78807886508	Binaurals For Master Classic II, 27" Caribbean Blue
78807886516	Binaurals For Master Classic II, 27" Hunter Green
78808303578	Binaural Assembly for Littmann® Master Cardiology and Cardiology III, Plum Tubing, 27"
78808303586	Binaural Assembly for Littmann® Master Classic II, Ceil Blue Tubing, 27"
78808303594	Binaural Assembly for Littman® Classic II S.E., Ceil Blue Tubing, 28"
78808303602	Binaural Assembly for Littmann® Classic II S.E., Seafoam Green Tubing, 28"
78808303610	Binaural Assembly for Littmann® Classic II Infant, Lilac Tubing, 28"
78808303628	Binaural Assembly for Littmann® Classic II S.E., Orange Tubing, 28", ea

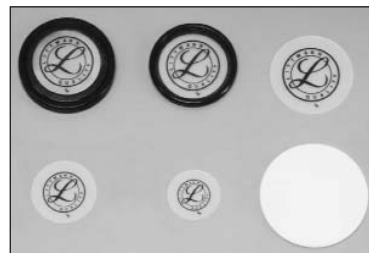
**3M™ LITTMANN® STETHOSCOPE DIAPHRAGMS**

36559	Stethoscope Diaphragms For the Cardiology II, Cardiology, Classic II, Classic, Lightweight, Blood Pressure & Differential Stethoscope, Printed w/Littmann Logo, 10/bg
36560	Stethoscope Diaphragms For Classic II Pediatric Stethoscope, Printed w/Littmann Logo, 10/bg
36561	Stethoscope Diaphragms For Classic II Infant Stethoscope, Printed w/Littmann Logo, 10/bg
7880830322	Diaphragm For Littmann® Electronic Model 3000 Stethoscope
7880830334	Diaphragm For Littmann® Electronic Model 4100WS Stethoscope

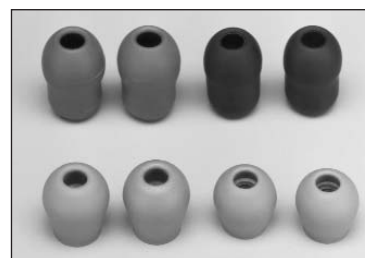
**3M™ LITTMANN® STETHOSCOPE EARTIPS**

37808	Snap-Tight Stethoscope Eartips, Firm, Gray, Large, 10 pr/bg
37809	Snap-Tight Stethoscope Eartips, Soft-Sealing, Black, Small, 10 pr/ctn
37810	Snap-Tight Stethoscope Eartips, Soft-Sealing, Gray, Small, 10 pr/ctn
37811	Snap-Tight Stethoscope Eartips, Soft-Sealing, Black, Large, 10 pr/ctn
37812	Snap-Tight Stethoscope Eartips, Soft-Sealing, Gray, Large, 10 pr/ctn
38742	Snap-Tight Stethoscope Eartips, Firm, Gray, Small, 10 pr/bg
51161	Soft-Sealing Eartips, Light Brown, Large, 10 pr/ctn

**3M™ LITTMANN® STETHOSCOPE IDENTIFICATION TAGS**

Fits all sizes.

2170	Stethoscope Identification Tags, Black, 5/cs
2171	Stethoscope Identification Tags, Gray, 5/cs

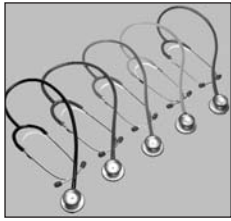

4001-01



4081



4131-01

RIESTER DOUBLE HEADED STETHOSCOPES

CNC-produced precision chest pieces with fibre-reinforced Riester special membranes and particularly flat and soft non-chill rims for improved adaptation on the skin. Extra-soft, replaceable ear-tips with metal screw thread for comfortable and effective sealing of the external auditory canal. Comfortable and flexible binaural. High quality tube systems with outstanding sound-conducting characteristics. All Riester stethoscopes are supplied with replacement parts and instructions for use. Latex-free. There is a 24 month guarantee on all Riester stethoscopes.

- 4001-01 Double-Headed Chest-Piece, Aluminum, Black, Duplex®
- 4001-02 Double-Headed Chest-Piece, Aluminum, Slate Grey, Duplex®
- 4031-03 Double-Headed Chest-Piece, Aluminum, Blue, Duplex®
- 4033-05 Double-Headed Chest-Piece, Aluminum, Green, Duplex®
- 4035-04 Double-Headed Chest-Piece, Aluminum, Saffron, Duplex®
- 4081 Double-Headed Chest-Piece, Stainless Steel, Slate Grey, Duplex® De Luxe®
- 4081-01 Double-Headed Chest-Piece, Stainless Steel, Black, Duplex® De Luxe®
- 4081-03 Double-Headed Chest-Piece, Stainless Steel, Blue, Duplex® De Luxe®
- 4081-04 Double-Headed Chest-Piece, Stainless Steel, Saffron, Duplex® De Luxe®
- 4081-05 Double-Headed Chest-Piece, Stainless Steel, Green, Duplex® De Luxe®
- 4131-01 Double-Headed Chest-Piece, Stainless Steel, Black, Cardiophon®
- 4131-02 Double-Headed Chest-Piece, Stainless Steel, Grey, Cardiophon®
- 4131-03 Double-Headed Chest-Piece, Stainless Steel, Blue, Cardiophon®

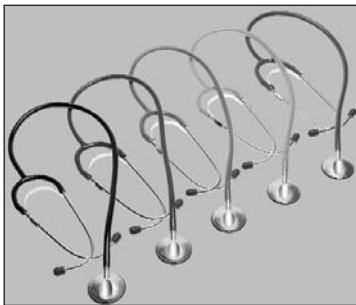

RIESTER STETHOSCOPES

Considerable acoustic improvement. Large selection. CNC-produced precision chest-pieces. Extra-soft, replaceable ear-tips with metal screw thread. Comfortable and flexible binaural. High quality tube systems. Replacement parts and instructions for use. Latex-free. 24 months guarantee. Development and production in Germany.

- 4177-01 Stethoscope, Aluminum Flat-Headed, Black, Anestophon®
- 4177-02 Stethoscope, Aluminum Flat-Headed, Slate-Grey, Anestophon®
- 4177-03 Stethoscope, Aluminum Flat-Headed, Blue, Anestophon®
- 4177-04 Stethoscope, Aluminum Flat-Headed, Saffron, Anestophon®
- 4177-05 Stethoscope, Aluminum Flat-Headed, Green, Anestophon®
- 4191 Stethoscope For The Embryo in the Womb, Aluminum, Pinard®



RIESTER 3 CHESTPIECE STETHOSCOPE

The high quality stethoscope Tristar® with three different sized double chest-pieces for adults, children/babies and new-born children is outstandingly suitable for perfect auscultation in all frequency ranges. Considerable improved acoustic performance in all areas of application.

- 4091 3 Chestpieces For Adult, Baby & Neonatal, Aluminum, Slate-Grey, Tristar®
- 4093 3 Chestpieces For Adult, Baby & Neonatal, Aluminum, Blue, Tristar®



4041



4042



4051

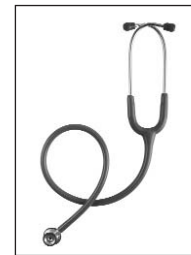

4052

RIESTER DOUBLE HEADED CHILD STETHOSCOPE

- 4041 Baby, Double-Headed Chest-Piece, Aluminum, Blue, Duplex® Baby
- 4042 Baby, Double-Headed Chest-Piece, Stainless Steel, Blue, Duplex® De Luxe® Baby
- 4051 Neonatal, Double-Headed Chest-Piece, Aluminum, Blue, Duplex® Baby
- 4052 Neonatal, Double-Headed Chest-Piece, Stainless Steel, Blue, Duplex® De Luxe® Baby

RIESTER STETHOSCOPES ACCESSORIES

11008	Double Head Chestpiece, Aluminum, Duplex®
11012	Double Head Chestpiece, Stainless Steel, Duplex® De Luxe®
11022	Double Head Chestpiece, Stainless Steel, Cardiophon
11032	Single Head Chestpiece, Aluminum, Anestophon®
11035	Double Head Chestpiece, Adult Size, Aluminum, Tristar®
11036	Double Head Chestpiece, Child Size, Aluminum, Tristar®
11038	Double Head Chestpiece, Infant Size, Aluminum, Tristar®
11042	Membranes 1.77 in, Cardiophon, Duplex® (De Luxe®), Anestophon®, Tristar®, 10/pk
11050	Membranes 1.33 in w/hole, Cardiophon®, Duplex® (De Luxe®), 10/pk
11051	Membranes 1.02 in, Duplex® (De Luxe®) Neonatal, Tristar®, 10/pk
11052	Membranes 1.33 in, Duplex® (De Luxe®) Baby, Tristar®, 10/pk
11080	Binaural Duplex®, Anestophon®
11094-02	Latex Free Slate Grey Y-Tubing, Duplex®, Anestophon®
11095-01	Latex Free Black Y-Tubing, Duplex®, Anestophon®
11096-03	Latex Free Blue Y-Tubing, Duplex®, Anestophon®
11097-05	Latex Free Green Y-Tubing, Duplex®, Anestophon®
11098-04	Latex Free Saffron Y-Tubing, Duplex®, Anestophon®
11110	White Hard Ear Tips, Duplex® (De Luxe®) Anestophon®, Tristar®, 10 pairs/pk
11139	Grey Soft Ear Tips, Cardiophon, Duplex® (De Luxe®) Anestophon®, Tristar®, 10 pairs/pk
11140	Non-Chill Ring 1.88 in, Grey, Cardiophon, Duplex® (De Luxe®), Tristar®
11141	Non-Chill Ring 1.40 in, Grey, Cardiophon, Duplex® (De Luxe®) Baby, Tristar®
11143	Non-Chill Ring 1.10 in, Grey, Duplex® (De Luxe®) Baby, Neonatal, Tristar®
11144	Non-Chill Ring .86 in, Grey, Duplex® (De Luxe®), Neonatal, Tristar®
11147	Name Plates, 10/pk

MILTEX DE LEE OBSTETRICAL STETHOSCOPES

Chrome. Complete with binaurals.

30-2205	Stethoscope w/padded head support, Rigid Metal Arm
30-2210	Stethoscope w/padded head support, Flexible Arm

MILTEX FORD STETHOSCOPE

Shallow bell and plastic ear tips. Chrome.

1-4	Ford Stethoscope
-----	------------------

MILTEX PINARD FETAL HEART STETHOSCOPE

Aluminum.

30-2200	Fetal Heart Stethoscope
---------	-------------------------



OMRON LIGHTWEIGHT DUAL HEAD STETHOSCOPES

Lightweight stethoscopes feature adjustable binaurals for a comfortable fit, one-piece molded PVC tubing for good sound transmission, and built-in rubber non-chill rings. Includes extra pair of eartips and diaphragm.

412BLK	Dual Head Stethoscope, Silver Chestpiece w/black tubing
412BLUE	Dual Head Stethoscope, Blue Chestpiece w/blue tubing
412GRAY	Dual Head Stethoscope, Silver Chestpiece w/gray tubing
412GREN	Dual Head Stethoscope, Green Chestpiece w/green tubing
412RED	Dual Head Stethoscope, Red Chestpiece w/red tubing



OMRON LIGHTWEIGHT SINGLE HEAD NURSE STETHOSCOPES

Match a favorite uniform with one of eleven brightly colored nurse stethoscopes. Silver chestpiece. These colorful stethoscopes are useful for color coding departments or identifying contagious areas.

411BLK	Nurse Stethoscope w/black tubing
411BLUE	Nurse Stethoscope w/blue tubing
411RED	Nurse Stethoscope w/red tubing

OMRON NEONATAL STETHOSCOPE

Chrome-plated brass chestpiece with screw-on retaining ring and slip-on non-chill ring. Quality sound transmission. Chrome-plated binaurals and 22" Y-tubing. Overall length, 30".

13-310	Gray Neonatal Stethoscope
13-311B	Light Blue Neonatal Stethoscope
13-315P	Pink Neonatal Stethoscope



OMRON SPRAGUE RAPPAPORT-TYPE STETHOSCOPES

5-in-1 multipurpose Quintscope™ has approximately 22" long tubing (except #416) and silver chestpiece. Accessories include three different size open bells, two different size replacement diaphragms, and two pairs of eartips in a vinyl storage case.

416-22-BLK	Black Stethoscope
416-22-DB	Dark Blue Stethoscope
416-22-DKGN	Dark Green Stethoscope



OMRON BOWLES STETHOSCOPE

Most economical professional stethoscope features a chrome-plated binaural and black PVC tubing. Standard single stem.

0407	Black Bowles Stethoscope
------	--------------------------



OMRON DISPOSABLE NURSE STETHOSCOPE

Lightweight plastic scopes are ideal for single-patient use in contagious areas. Sound transmission is comparable to a standard nurse scope.

0300BLUE	Blue Nurse Stethoscope
0300RED	Red Nurse Stethoscope
0300YELLOW	Yellow Nurse Stethoscope
13-176H	Yellow Nurse Stethoscope w/aluminum binaurals, 50/cs
HSS-490	Lightweight Nurse Stethoscope



OMRON DUAL-HEAD TRAINING SCOPE

Two-channel stethoscope provides accurate sound transmission to both student and instructor. Dual-head chest piece converts from diaphragm to an open bell head with a single turn of the stem.

0405	Dual-Head Training Scope
------	--------------------------

OMRON FETAL STETHOSCOPE

Designed for superior auscultation of the fetal heart. Stethoscope is equipped with chrome-plated brass binaurals and stem. 22" tubing can be easily shortened to facilitate use of the headrest.

13-570	Black Fetal Stethoscope
--------	-------------------------

ADC PLATINUM EDITION ADSCOPE-LITE™

Unique design that combines the acoustic response of a traditional bell and diaphragm into a convenient one-sided chestpiece. Bell-type low frequency response is achieved by simply holding the chestpiece in place with light pressure. Firm pressure will produce diaphragm-type high frequency performance. A rubber gasket recessed into the chestpiece alters the diaphragm permitting the scope to achieve multi-frequency response. Chestpiece made from lightweight zinc alloy plated with an attractive satin finish. Non-chill diaphragm retaining rim for patient comfort. Large bore chrome plated brass binaurals with matching satin finish. Double leaf internal spring fixed at 15° angle for greater comfort. Reinforcing yoke molded into flexible 22" PVC Y tubing. ADSOFT™ deluxe PVC eartips in small and large size for the ultimate in wearing comfort and acoustic seal. Spare diaphragm included. Scope ID tag included. Weighs 6 oz. Overall length 31". Lifetime warranty.

612BK	Black Adscope-Lite™
612DG	Dark Green Adscope-Lite™
612N	Navy Adscope-Lite™
612RB	Royal Blue Adscope-Lite™
612TL	Teal Adscope-Lite™
614BK	Black, Child Adscope-Lite™
614G	Gray, Child Adscope-Lite™
614LB	Light Blue, Child Adscope-Lite™
614P	Pink, Child Adscope-Lite™

Accessories

612-01BK	Chestpiece For 612, Black
612-01DG	Chestpiece For 612, Dark Green
612-01N	Chestpiece For 612, Navy
612-01RB	Chestpiece For 612, Royal Blue
612-01TL	Chestpiece For 612, Teal
612-05BK	Binaural Assembly For 612, Black
612-05DG	Binaural Assembly For 612, Dark Green
612-05N	Binaural Assembly For 612, Navy
612-05RB	Binaural Assembly For 612, Royal Blue
612-05TL	Binaural Assembly For 612, Teal



ADC ADSCOPE™ 615 PLATINUM PROFESSIONAL EDITION

Combines the acoustic response of a traditional bell and diaphragm into a convenient one-sided chestpiece. New gasketed diaphragm enables the scope to achieve multi-frequency response simply by altering pressure. Light pressure produces bell-type low frequency response. Firm pressure will produce diaphragm-type high frequency performance. New ovoid shaped chestpiece improves ergonomics. Chestpiece made from lightweight zinc alloy plated with an attractive satin finish. Non-chill diaphragm retaining rim for patient comfort. Large bore chrome-plated brass binaurals in satin finish. Double leaf internal spring fixed at 15° angle for greater comfort. Reinforcing yoke molded into flexible 22" PVC "Y" tubing. Adsoft™ deluxe PVC eartips in small and large size for the ultimate in wearing comfort and acoustic seal. Spare diaphragm included. Scope ID Tag included. Weighs 5.4 oz. Overall length 30.5". Lifetime Warranty.

615BD	Multifrequency Scope, Burgundy
615BK	Multifrequency Scope, Black
615DG	Multifrequency Scope, Dark Green
615N	Multifrequency Scope, Navy
615RB	Multifrequency Scope, Royal Blue
615ST	Multifrequency Scope, Ninja
615V	Multifrequency Scope, Purple

ADC ADSCOPE™ 617/618 ADIMAL STETHOSCOPE

Distinctive molded resin animal face chestpiece in choice of adult or pediatric size. Perfectly compliments our Adtoons™ line of character print aneroid sphygs. Multi-frequency design combines the acoustic response of a traditional bell and diaphragm into a single sided chestpiece. Gasketed diaphragm switches between bell-like low frequency and diaphragm-like high frequency performance simple by altering pressure. Lightweight aluminum binaurals in satin finish. Double leaf internal spring fixed at 15 for greater comfort. Reinforcing yoke molded into the flexible 22" PVC tubing. New Ultra Adsoft™ deluxe eartips with threaded insert for the ultimate in wearing comfort and acoustic seal. Seven interchangeable animal face snap ons included: panda, frog, koala, deer, monkey, tiger and bear. Adult chestpiece 1 7/8" diameter diaphragm. Pediatric chestpiece 1 1/2" diameter diaphragm. Overall length 30". Weight: adult 4 oz., pediatric 3 oz. Five year warrant.

617P	Stethoscope, Adscope Animal Scope, Adult, 22", Pink, Latex Free
617SF	Stethoscope, Adscope Animal Scope, Adult, 22", Seafoam, Latex Free
617W	Stethoscope, Adscope Animal Scope, Adult, 22", White, Latex Free
618P	Stethoscope, Adscope Animal Scope, Pediatric, 22", Pink, Latex Free
618SF	Stethoscope, Adscope Animal Scope, Pediatric, 22", Seafoam, Latex Free
618W	Stethoscope, Adscope Animal Scope, Pediatric, 22", White, Latex Free

Accessories

617-01P	Chestpiece For 617, Adult, Pink, Latex Free
617-01SF	Chestpiece For 617, Adult, Seafoam, Latex Free
617-01W	Chestpiece For 617, Adult, White, Latex Free
617-05P	Tubing, Binaural For 617 or 618, 22", Pink
617-05SF	Tubing, Binaural For 617 or 618, 22", Seafoam
617-05W	Tubing, Binaural For 617 or 618, 22", White
617-KIT	Chestpiece Snap-Ons Kit For 617, Animal Face, Set of 6
618-01P	Chestpiece For 618, Pediatric, Pink, Latex Free
618-01SF	Chestpiece For 618, Pediatric, Seafoam, Latex Free
618-01W	Chestpiece For 618, Pediatric, White, Latex Free
618-KIT	Chestpiece Snap-Ons Kit For 618, Animal Face, Set of 6

**ADC ADSCOPE™ SPRAGUESCOPES**

Threaded chestpiece drum of chrome plated zinc permits the use of five interchangeable chestpiece fittings. 22" tubing length; overall length 30" (except #640 has 16" tubing length with overall length 24"). Latex free, double tube configuration for improved acoustic separation. Proprietary valve mechanism eliminates acoustic leakage. Adjustable chrome plated brass binaurals. Complete with an accessory pouch containing the bell chestpieces, chestpiece key, 2 spare diaphragms, one pair of mushroom eartips and one pair of silicon eartips. Weighs 6 oz. Inspected and packaged in the U.S.A. Five year warranty. Latex free.

640BK	16", Black Spraguescope
641BB	Boysenberry Spraguescope
641BD	Burgundy Spraguescope
641BK	Black Spraguescope
641CA	Caribbean Blue Spraguescope
641FG	Frosted Glacier Spraguescope
641FL	Frosted Lilac Spraguescope
641FS	Frosted Seafoam Spraguescope
641G	Gray Spraguescope
641GR	Green Spraguescope
641LB	Light Blue Spraguescope
641LV	Lavender Spraguescope
641M	Magenta Spraguescope
641N	Navy Spraguescope
641NB	Neon Blue Spraguescope
641NGR	Neon Green Spraguescope
641NO	Neon Orange Spraguescope
641NP	Neon Pink Spraguescope
641NY	Neon Yellow Spraguescope
641P	Pink Spraguescope
641R	Red Spraguescope
641RB	Royal Blue Spraguescope
641TL	Teal Spraguescope
641V	Purple Spraguescope

ADC NURSE COMBO

Combines the Pocket Pal II™ Kit complete with three instruments and choice of 8 Velcro® tag colors with an ADSCOPE™ 641 Sprague Rappaport scope with 22" tubing color coordinated to the Velcro® tags and a nine piece accessory kit.

116-641BDQ	Nurse Combo, Burgundy
116-641BKQ	Nurse Combo, Black
116-641DGQ	Nurse Combo, Dark Green
116-641NQ	Nurse Combo, Navy
116-641NYQ	Nurse Combo, Neon Yellow
116-641RBQ	Nurse Combo, Royal Blue
116-641TLQ	Nurse Combo, Teal
116-641VQ	Nurse Combo, Purple

**Can't find what you
are looking for?
Give us a call for fast,
personal service.**

Stethoscopes

ADC SPRAGUE RAPPAPORT STETHOSCOPE ACCESSORIES

640-01	Chestpiece For 640 & 641
640-01D	Chestpiece Drum For 640 & 641
640-02	Retaining Ring For 640 & 641, Adult
640-02S	Retaining Ring For 640 & 641, Pediatric
640-03	Diaphragm For All Spragues, Adult
640-03S	Diaphragm For All Spragues, Pediatric
640-05	Binaurals For 640 & 641
640-05S	Binaural Spring For 640 & 641
640-05TBK	Tubing For 640, 16" Black
640-06	Tubing Caps For 640 & 641, Black
640-09	Eartips, Black, For 640 & 641
640-10	Eartips, Clear
640-11	Bell, 1 1/4", For 640, 641 & 645
640-12	Bell, 1", For 640, 641 & 645
640-13	Bell, 3/4", For 640, 641 & 645
640-14	Aluminum Disc For 640 & 641, Adult
640-14A	Diaphragm Assembly For 640 & 641, Adult
640-15	Aluminum Disc For 640 & 641, Pediatric
640-15A	Diaphragm Assembly For 640 & 641, Pediatric
640-16	Tubing Clip For 640 & 641
640-17	Accessory Kit For 640 & 641
640-19	Chestpiece Key For All Spragues
641-05TBB	Boysenberry 22" Tubing For 641 Stethoscope
641-05TBD	Burgundy 22" Tubing For 641 Stethoscope
641-05TBK	Black 22" Tubing For 641 Stethoscope
641-05TCA	Caribbean Blue 22" Tubing For 641 Stethoscope
641-05TDG	Dark Green 22" Tubing For 641 Stethoscope
641-05TFG	Frosted Glacier 22" Tubing For 641 Stethoscope
641-05TFL	Frosted Lilac 22" Tubing For 641 Stethoscope
641-05TFS	Frosted Seafoam 22" Tubing For 641 Stethoscope
641-05TG	Gray 22" Tubing For 641 Stethoscope
641-05TGR	Green 22" Tubing For 641 Stethoscope
641-05TLB	Light Blue 22" Tubing For 641 Stethoscope
641-05TLV	Lavender 22" Tubing For 641 Stethoscope
641-05TM	Magenta 22" Tubing For 641 Stethoscope
641-05TN	Navy 22" Tubing For 641 Stethoscope
641-05TNB	Neon Blue 22" Tubing For 641 Stethoscope
641-05TNGR	Neon Green 22" Tubing For 641 Stethoscope
641-05TNO	Neon Orange 22" Tubing For 641 Stethoscope
641-05TNP	Neon Pink 22" Tubing For 641 Stethoscope
641-05TNY	Neon Yellow 22" Tubing For 641 Stethoscope
641-05TP	Pink 22" Tubing For 641 Stethoscope
641-05TR	Red 22" Tubing For 641 Stethoscope
641-05TRB	Royal Blue 22" Tubing For 641 Stethoscope
641-05TTL	Teal 22" Tubing For 641 Stethoscope
641-05TV	Purple 22" Tubing For 641 Stethoscope
640-18	Pouch For 640 & 641

ADC NURSE COMBO PLUS

Combines the Pocket Pal III™ Kit complete with three instruments and choice of 3 Velcro® tag colors with an ADSCOPE™ 641 Sprague Rappaport scope with 22" tubing color coordinated to the Velcro® tags and a nine piece accessory kit.

117-641BKQ	Nurse Combo Plus, Black
117-641TLQ	Nurse Combo Plus, Teal
117-641VQ	Nurse Combo Plus, Purple

ADC ADSCOPE™ 645 STETHOSCOPE

Extraordinary design for outstanding acoustic performance and rugged durability. Chestpiece drum, retaining rings, tubing clip and binaurals generously plated with 5 microns of 18 karat gold, then polished to a brilliant shine. Complete with an accessory pouch containing two extra pairs of eartips, spare diaphragms and the three bell chestpieces. Weighs 8 oz. Overall length 30". Inspected and packaged in the U.S.A. One year warranty on finish, lifetime on performance. Latex free.

645 ADSCOPE™ 645 18 Karat Gold Plated Stethoscope

Accessories

645-01	Chestpiece
645-01D	Chestpiece Drum
645-02	Retaining Ring, Adult
645-02S	Retaining Ring, Pediatric
645-05	Binaurals, Adult
645-05S	Binaural Spring, Pediatric
645-14A	Diaphragm Assembly, Adult
645-15A	Diaphragm Assembly, Pediatric
645-16	Tubing Clip Assembly

ADC ADSCOPE™ NINJA SPRAGUE

Threaded chestpiece drum permits the use of five interchangeable chestpiece fittings an adult and pediatric diaphragm, and three bells (1 1/4", 1", 3/4") - for complete diagnostic capability in most patients. All metal parts finished in black chrome for a striking appearance. Latex-free double tube configuration. Proprietary valve mechanism eliminates acoustic leakage. Adjustable binaurals. Complete with an accessory pouch containing the bell chestpieces, chestpiece key, 2 spare diaphragms, one pair of mushroom eartips, and one pair of silicon eartips. Weighs 8 oz, measures 30". Inspected and packaged in the U.S.A.

646ST Adscope™ Ninja Sprague, 22", Black

ADC ADSCOPE™ SPRAGUE-1

Threaded chestpiece drum permits the use of five interchangeable chestpiece fittings - an adult and pediatric diaphragm, and three bells (1 1/4", 1", 3/4") - for complete diagnostic capability in most patients. Latex-free extra thick "y" tubing. Proprietary valve mechanism eliminates acoustic leakage. Adjustable chrome-plated brass binaurals. Complete with an accessory pouch containing the bell chestpieces, chestpiece key, 2 spare diaphragms, one pair of mushroom eartips, and one pair of silicon eartips. Inspected and packaged in the U.S.A.

647BK	Adscope™ 647, 22", Black
647DG	Adscope™ 647, 22", Dark Green
647N	Adscope™ 647, 22", Navy
647RB	Adscope™ 647, 22", Royal Blue
647V	Adscope™ 647, 22", Purple

ADC ADSCOPE™ 617/618 ADIMAL STETHOSCOPE

Distinctive molded resin animal face chestpiece in choice of adult or pediatric size. Perfectly compliments our Adtoons™ line of character print aneroid sphygs. Multi-frequency design combines the acoustic response of a traditional bell and diaphragm into a single sided chestpiece. Gasketed diaphragm switches between bell-like low frequency and diaphragm-like high frequency performance simple by altering pressure. Lightweight aluminum binaurals in satin finish. Double leaf internal spring fixed at 15 for greater comfort. Reinforcing yoke molded into the flexible 22" PVC tubing. New Ultra Adsoft™ deluxe eartips with threaded insert for the ultimate in wearing comfort and acoustic seal. Seven interchangeable animal face snap ons included: panda, frog, koala, deer, monkey, tiger and bear. Adult chestpiece 1 7/8" diameter diaphragm. Pediatric chestpiece 1 1/2" diameter diaphragm. Overall length 30". Weight: adult 4 oz., pediatric 3 oz. Five year warrant.

617P	Stethoscope, Adscope Animal Scope, Adult, 22", Pink, Latex Free
617SF	Stethoscope, Adscope Animal Scope, Adult, 22", Seafoam, Latex Free
617W	Stethoscope, Adscope Animal Scope, Adult, 22", White, Latex Free
618P	Stethoscope, Adscope Animal Scope, Pediatric, 22", Pink, Latex Free
618SF	Stethoscope, Adscope Animal Scope, Pediatric, 22", Seafoam, Latex Free
618W	Stethoscope, Adscope Animal Scope, Pediatric, 22", White, Latex Free

ADC ADSCOPE™ 617/618 ADIMAL STETHOSCOPE ACCESSORIES

617-01P	Chestpiece For 617, Adult, Pink, Latex Free
617-01SF	Chestpiece For 617, Adult, Seafoam, Latex Free
617-01W	Chestpiece For 617, Adult, White, Latex Free
617-05P	Tubing, Binaural For 617 or 618, 22", Pink
617-05SF	Tubing, Binaural For 617 or 618, 22", Seafoam
617-05W	Tubing, Binaural For 617 or 618, 22", White
617-KIT	Chestpiece Snap-Ons Kit For 617, Animal Face, Set of 6
618-01P	Chestpiece For 618, Pediatric, Pink, Latex Free
618-01SF	Chestpiece For 618, Pediatric, Seafoam, Latex Free
618-01W	Chestpiece For 618, Pediatric, White, Latex Free
618-KIT	Chestpiece Snap-Ons Kit For 618, Animal Face, Set of 6



P371000

P371015

PRO ADVANTAGE® DIAGNOSTIC PENLIGHT

Penlight has high-intensity prefocused bulb powered by two AAA batteries. Aluminum contact strip assures good contact for brighter light. Has a unique V-clip. One year shelf life. Available with or without pupil gauge.

P371000	Disposable Penlight, 6/pk
P371015	Disposable Penlight w/pupil gauge, 6/pk



WELCH ALLYN PROFESSIONAL PENLITE

Halogen light for true tissue color and consistent, long lasting illumination. Brass with black matte finish for durability.

76600	PenLite
-------	---------



AARON DIAGNOSTIC LIGHT EXAM KITS

Disposable. Two AAA batteries. Cobalt blue with Wratten #47A cobalt filter. For use with fluorescein dye. One-year shelf life.

6303	Penlights w/cobalt filter, 3/pk
------	---------------------------------

AARON FLURO-DOT™ PENLIGHT

Battery-operated penlight designed for use with fluorescein dye. Excellent for diagnosing abrasions and fitting contact lenses. Constant on/off switch. Contains two AA alkaline batteries. Penlight has a 4-year shelf life and a 4-hour burn time.

6802	Fluro Dot™ Penlight w/wratten cobalt blue filter
6803	Fluro Slit™ Penlight

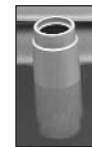

7156

AARON PENLIGHTS

1125	Disposable Penlight
1135	Reusable Penlight

Accessories

222	Replacement Bulb For 1135
7156	Cobalt Filter Only



AARON PHYSICIAN'S PENLIGHT

Penlight has high-intensity prefocused bulb powered by two AAA batteries. Aluminum contact strip assures good contact for brighter light. Extruded case has a unique V-clip. 1-year shelf life. Useful life is 3- to 6-months with intermittent use.

6666	Dr. Pack Disposable Penlight, 6/pk
666R	Doctors' Replaceable Battery Penlight, 6/pk
66RN	RN Pack Disposable Penlight w/pupil gauge, 6/pk



ADC ADLITE™ DISPOSABLE PENLIGHT

Sealed concentric beam activated by depressing pocket clip. Available with or without pupil gauge. 5" long, 1/2" diameter.

351	Disposable Penlight, 6/pk
351P	Disposable Penlight w/pupil gauge, 6/pk



ADC ADLITE™ PLUS PENLIGHT

Sealed concentric beam, disposable diagnostic penlight. Activated by depressing pocket clip. Measures 5" long, 1/2" diameter. Sold individually or in display cylinder of 22.

356BK	ADLITE™ Disposable Penlight, Black
356OR	ADLITE™ Disposable Penlight, Orange
356R	ADLITE™ Disposable Penlight, Red
356TL	ADLITE™ Disposable Penlight, Teal
356V	ADLITE™ Disposable Penlight, Purple
356W	ADLITE™ Disposable Penlight, White
356WP	ADLITE™ Disposable Penlight, White w/pupil gauge
358AST	Disposable Penlight, Assorted Colors, 22/cylinder
358TVB	Disposable Penlight, Black, Purple & Teal, 22/cylinder
358W	Disposable Penlight, White, 22/cylinder
358WP	Disposable Penlight, White w/pupil gauge, 22/cylinder



ADC ADLITE II™ PENLIGHT

Reusable penlight with attractive tapered barrel. Activated by depressing pocket clip. Two AAA batteries included. Measures 5" long, 1/2" diameter.

354 Reusable Penlight

ADC METALITE™ PENLIGHT

Reusable with brushed aluminum housing. Activated by push button. Two AAA batteries included. Measures 6" long, 1/2" diameter.

352 Penlight



5070



5070-01

RIESTER DIAGNOSTIC PENLIGHT

With 2.2V vacuum lamp. Aluminum outer casing with sterilizable special lacquer. With practical metal clip for attaching to the physician's coat. Simple on/off function through contact with the metal clip.

5070 Diagnostic Penlight w/vacuum light, 2.2V, Assorted Colors, Fortelux® N, 6/pk

5070-01 Diagnostic Penlight w/vacuum light 2.2V, Fortelux® N

OMRON HIGH INTENSITY DIAGNOSTIC PENLIGHTS

Focused beam lens-end lamps. Each light has a clip to prevent accidental discharge of the batteries when carried in a pocket. Lights weigh less than one ounce.

24-100 Reusable Pen Light, 6/pk

24-150 Reusable Pen Light, 100/bx



WELCH ALLYN KLEENSPEC® DISPOSABLE LARYNGOSCOPES

Designed for single use. Light source inserts in the handle. After use, remove the light source and discard the blade and handle.

Accessories

60500 Illuminator For Laryngoscope



60200



60300



60305



60400



60710



60713



60813

WELCH ALLYN LARYNGOSCOPE HANDLES

Knurled finish for sure grip.

60200 Standard Laryngoscope Handle D - Size Battery

60300 Standard Laryngoscope Handle C - Size Battery

60305 Standard Stubby Laryngoscope Handle

60400 Standard Laryngoscope Handle AA - Size Battery

60710 Standard 2.5V Rechargeable Laryngoscope Handle Only

60713 2.5V Rechargeable Laryngoscope Handle Only For Fiber Optic Blades

60715 Standard Rechargeable Battery Handle & Transformer

60813 Laryngoscope Handle For Fiber Optic Blades, Uses C - Size Batteries

60814 Laryngoscope Handle For Fiber Optic Blades, Uses AA - Size Batteries

60815 Stubby Laryngoscope Handle For Fiber Optic Blades

We offer:

- Great Service
- Great Pricing
- Great Products

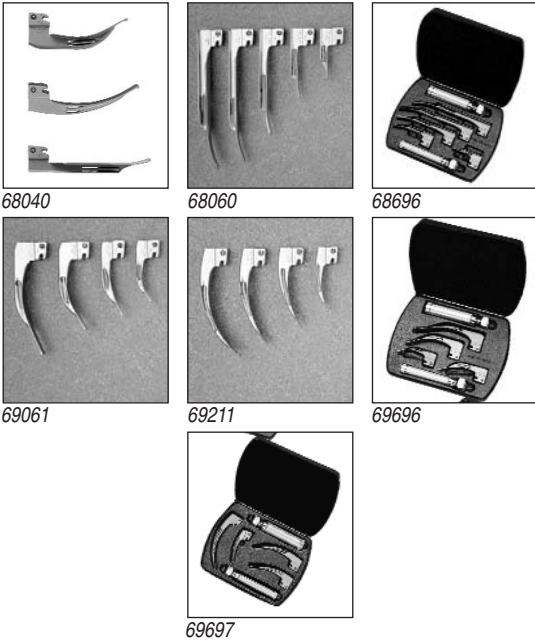

WELCH ALLYN LARYNGOSCOPE BLADES

One-piece stainless steel construction.

- 05681-U Fiber Optic - Miller Blade Case
- 05691-U Fiber Optic - MacIntosh Blade Case
- 05701-U Fiber Optic - English MacIntosh Blade Universal Case
- 05791-U Fiber Optic - English MacIntosh Blade Standard Case
- 68040 Miller Blade, Size 0
- 68041 Miller Blade, Size 1
- 68042 Miller Blade, Size 2
- 68043 Miller Blade, Size 3
- 68044 Miller Blade, Size 4
- 68060 Fiber Optic - Miller Blade, Size 0
- 68061 Fiber Optic - Miller Blade, Size 1
- 68062 Fiber Optic - Miller Blade, Size 2
- 68063 Fiber Optic - Miller Blade, Size 3
- 68064 Fiber Optic - Miller Blade, Size 4
- 68470 Miller Blade, Size 0 (Neonatal)
- 68696 Fiber Optic - Miller Blade, Complete Set w/medium & small handles, 05681 Case
- 69041 MacIntosh Blade, Size 1
- 69042 MacIntosh Blade, Size 2
- 69043 MacIntosh Blade, Size 3
- 69044 MacIntosh Blade, Size 4
- 69061 Fiber Optic - MacIntosh Blade, Size 1
- 69062 Fiber Optic - MacIntosh Blade, Size 2
- 69063 Fiber Optic - MacIntosh Blade, Size 3
- 69064 Fiber Optic - MacIntosh Blade, Size 4
- 69211 Fiber Optic - English MacIntosh Blade, Size 1
- 69212 Fiber Optic - English MacIntosh Blade, Size 2
- 69213 Fiber Optic - English MacIntosh Blade, Size 3
- 69214 Fiber Optic - English MacIntosh Blade, Size 4
- 69242 English MacIntosh Blade, Size 2
- 69243 English MacIntosh Blade, Size 3
- 69244 English MacIntosh Blade, Size 4
- 69696 Fiber Optic - MacIntosh Blade, Complete Set w/medium & small handles, 05691 Case
- 69697 Fiber Optic - English MacIntosh Blade, Complete Set w/medium & small handles, 05791 Case



WELCH ALLYN RL-150 RHINOLARYNGOSCOPE

For upper-respiratory exams. Procedure time is less than 5 minutes and easy to master. High patient acceptance rate. Simple one-step disinfection system. Free lifetime loaner guarantee policy. Short payback period. Reimbursable. Eliminates unnecessary referrals.

65050 RL-150 Rhinolaryngoscope

Accessories

- 65002 Disinfection Tray
- 65003 Hanger
- 65006 LX-150 Adaptor For 65051 Rhinolaryngoscope/LX-150 Light Source



WELCH ALLYN LARYNX & NASOPHARYNX ILLUMINATORS

Halogen illumination and fiber optics light transmission provide cool, intense light. Wide-angle mirror. Light aperture assists in positioning mirror. Ready for immediate use. Compatible with any Welch Allyn power source.

- 27010 2.5V or 3.5V Halogen Larynx Mirror Section Only
- 27050 2.5V or 3.5V Halogen Nasopharynx Illuminator, Complete

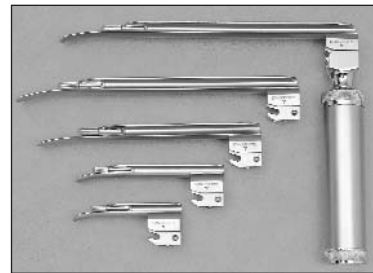

ADC FIBEROPTIC LARYNGOSCOPE BLADES

Fiberoptic light transmission provides cool obstruction free viewing. 2.5V halogen illumination for true tissue color and consistent long lasting lamp performance. Stainless steel. Satin, non-glare finish. Lightweight design. Fully compatible with all fiberoptic hook on handles that conform to ASTM (F965) and ISO (7376-1). Color coded green to signify compatibility and differentiate from standard hook on models.

- 4070F Size 0 Macintosh Blade, Premie
- 4071F Size 1 Macintosh Blade, Infant
- 4072F Size 2 Macintosh Blade, Child
- 4073F Size 3 Macintosh Blade, Medium Adult
- 4074F Size 4 Macintosh Blade, Large Adult
- 4080F Size 0 Miller Blade, Premie
- 4081F Size 1 Miller Blade, Infant
- 4082F Size 2 Miller Blade, Child
- 4083F Size 3 Miller Blade, Medium Adult
- 4084F Size 4 Miller Blade, Large Adult

ADC LARYNGOSCOPE SET

Choose from either a 4 blade Macintosh or 5 blade Miller set with both AA and C battery handles. Foam lined fitted hard case with carry handle. Batteries included.

4079	Standard Macintosh Laryngoscope Set
4079F	Fiberoptic Macintosh Laryngoscope Set
4089	Standard Miller Laryngoscope Set
4089F	Fiberoptic Miller Laryngoscope Set

**ADC STANDARD LARYNGOSCOPE BATTERY HANDLES**

Satin chrome plated brass with a knurled finish for a positive grip. Fully compatible with all standard hook-on blades that conform to ASTM (F965) and ISO (7376-1). Batteries not included.

4065	Laryngoscope Battery Handle, Medium "C" Size
4066	Laryngoscope Battery Handle, Small "AA" Size
4067	Laryngoscope Battery Handle, Stubby "AA" Size

ADC STANDARD LARYNGOSCOPE BLADES

Stainless steel construction with satin, non-glare finish. Brass electrical contacts enhance conductivity. Lightweight design. Fully compatible with all standard hook on handles that conform to ASTM (F965) and ISO (7376-1).

4070	Size 0 Macintosh Blade, Preemie
4071	Size 1 Macintosh Blade, Infant
4072	Size 2 Macintosh Blade, Child
4073	Size 3 Macintosh Blade, Medium Adult
4074	Size 4 Macintosh Blade, Large Adult
4080	Size 0 Miller Blade, Preemie
4080-0	Size 00 Miller Blade, Small Preemie
4081	Size 1 Miller Blade, Infant
4082	Size 2 Miller Blade, Child
4083	Size 3 Miller Blade, Medium Adult
4084	Size 4 Miller Blade, Large Adult
4090	Size 0 Wisconsin Blade, Preemie
4091	Size 1 Wisconsin Blade, Infant
40915	Size 1.5 Wisconsin Blade, Small Child
4092	Size 2 Wisconsin Blade, Child
4093	Size 3 Wisconsin Blade, Medium Adult
4094	Size 4 Wisconsin Blade, Large Adult

ADC FIBEROPTIC LARYNGOSCOPE BATTERY HANDLES

Lightsource in handle simplifies blade cleaning, allows for use of brighter, whiter light. Satin chrome plated brass handle with a knurled finish for a positive grip. Fully compatible with all standard hook-on blades that conform to ASTM (F965) and ISO (7376-1). Color coded green to signify compatibility ONLY with fiberoptic blades. Batteries not included.

4065F	Laryngoscope Fiberoptic Battery Handle, Medium "C" Size
4066F	Laryngoscope Fiberoptic Battery Handle, Small "AA" Size
4067F	Laryngoscope Fiberoptic Battery Handle, Stubby "AA" Size

ADC DIAGNOSTIC REPLACEMENT LARYNGOSCOPE LAMPS

Manufactured to provide extra long life and reliable illumination. Unconditionally guaranteed to be free from defects and give trouble free service. Rated for 20 hours continuous use. Packaged individually in ziplock poly bags.

4500-1	Lamp, WA#00110
4501-1	Lamp, WA#00400
4502-1	Lamp, WA#00200
4504-1	Lamp, WA#00800
4507-1	Lamp, WA#01300
4513-1	Lamp, WA#03000
4514-1	Lamp, WA#03100
4516-1	Lamp, WA#03400
4518-1	Lamp, WA#03900
4522-1	Lamp, WA#04900
4523-1	Lamp, WA#06000
4530-1	Lamp, 2.5V Halogen For 5120
4531-1	Lamp, 2.5V Halogen For 5140
4532-1	Lamp, 2.5V Halogen For 4065F to 4067F

RIESTER LARYNGOSCOPES

Reliable quality products. They are excellently finished and guarantee extreme durability. All handles and blades are made of high quality materials and are subjected to strict quality controls. All conventional laryngoscope models with excellent XL 3.5V or 2.5V xenon illumination and fiber optics or with tired and tested 2.7V vacuum illumination. Exceptionally high light intensity thanks to XL xenon illumination technology and the extra-strong fiber bundles of the F.O. blade. Macintosh and Miller blades with innovative blade design for optimum visibility of the epiglottis and vocal chords, simple insertion of the endotracheal tube. Large choice of power sources: Manoeuvrable and sturdy battery handles and practical charging bases. Wide selection of laryngoscope sets for pediatrics and adults with particularly convincing cost effectiveness. All handles and blades are supplied single and each can be individually combined within the fiber optics or standard model ranges.

8040	Macintosh, Integrated F.O. Conductor, Xenon Light 2.5V, C-Handle & Blades 2, 3, 4, Ri-Integral®
8046	Macintosh, Integrated F.O. Conductor, Xenon Light 3.5V, C-Handle & Blades 2, 3, 4, Rechargeable Battery (Ri-Accu®) & Charger (Ri-Charger®) 120V, Ri-Integral®
8050	Macintosh Baby, Integrated F.O. Conductor, Xenon Light 2.5V, AA-Handle & Blades 0, 1, 2, Ri-Integral®
8052	Macintosh, Integrated F.O. Conductor, Xenon Light 2.5V, AA-Handle & Blades 0, 1, 2, Rechargeable Battery (Ri-Accu®) & Charger (Ri-Charger®) 120V, Ri-Integral®
8060	Miller, Integrated F.O. Conductor, Xenon Light 2.5V, C-Handle & Blades 2, 3, 4, Ri-Integral®
8066	Miller, Integrated F.O. Conductor, Xenon Light 3.5V, C-Handle & Blades 2, 3, 4, Rechargeable Battery (Ri-Accu®) & Charger (Ri-Charger®) 120V, Ri-Integral®
8070	Miller Baby, Integrated F.O. Conductor, Xenon Light 2.5V, AA-Handle & Blades 0, 1, 2, Ri-Integral®
8072	Miller Baby, Integrated F.O. Conductor, Xenon Light 2.5V, AA-Handle & Blades 0, 1, 2, Rechargeable Battery (Ri-Accu®) & Charger (Ri-Charger®) 120V, Ri-Integral®
8080	Macintosh, Removable Light Conductor, Xenon Light 2.5V, C-Handle & Blades 2, 3, 4, Ri-Modul®
8086	Macintosh, Removable Light Conductor, Xenon Light 3.5V, C-Handle & Blades 2, 3, 4, Rechargeable Battery (Ri-Accu®) & Charger (Ri-Charger®) 120V, Ri-Modul®
8090	Macintosh, Removable Light Conductor, Xenon Light 2.5V, AA-Handle & Blades 0, 1, 2, Ri-Modul®
8092	Macintosh, Removable Light Conductor, Xenon Light 2.5V, AA-Handle & Blades 0, 1, 2, Rechargeable Battery (Ri-Accu®) & Charger (Ri-Charger®) 120V, Ri-Modul®
8100	Miller, Removable Light Conductor, Xenon Light 2.5V, C-Handle & Blades 2, 3, 4, Ri-Modul®
8106	Miller, Removable Light Conductor, Xenon Light 3.5V, C-Handle & Blades 2, 3, 4, Rechargeable Battery (Ri-Accu®) & Charger (Ri-Charger®) 120V, Ri-Modul®
8110	Miller Baby, Removable Light Conductor, Xenon Light 2.5V, AA-Handle & Blades 0, 1, 2, Ri-Modul®
8112	Miller Baby, Removable Light Conductor, Xenon Light 1.5V, AA-Handle & Blades 0, 1, 2, Rechargeable Battery (Ri-Accu®) & Charger (Ri-Charger®) 120V, Ri-Modul®

RIESTER LARYNGOSCOPES ACCESSORIES

- 11428 Bulbs XL 2.5V, 6/pk
- 11429 Bulbs XL 3.5V, 6/pk

RUSCH STANDARD/CONVENTIONAL BLADE

Constructed of stainless steel. Non-sterile.

- 008600000 Miller Blade, Size 00, Small Premature
- 008601100 MacIntosh Blade, Size 1, Infant
- 008602200 MacIntosh Blade, Size 2, Child
- 008603300 MacIntosh Blade, Size 3, Medium Adult
- 008603350 MacIntosh Blade, Size 3 1/2, Medium Adult
- 008604400 MacIntosh Blade, Size 4, Large Adult
- 008607100 Phillip Blade, Size 1
- 008608200 Phillip Blade, Size 2
- 008611100 Wisconsin Blade, Size 1, Infant
- 008612200 Wisconsin Blade, Size 2, Child
- 008613300 Wisconsin Blade, Size 3, Medium Adult
- 008614400 Wisconsin Blade, Size 4, Large Adult
- 008615050 Miller Blade, Size 0, Premature
- 008616100 Miller Blade, Size 1, Infant
- 008617200 Miller Blade, Size 2, Child
- 008618300 Miller Blade, Size 3, Medium Adult
- 008619400 Miller Blade, Size 4, Large Adult
- 008622300 Lamp Blade, Large, Frosted, 6/bx
- 008623100 Lamp Blade, Small, Frosted, 6/bx

MILTEX BRUENING MAGNIFIER OTOSCOPE

Chrome. 3.5x magnification with 3 specula, small, medium and large sizes. Complete with inflation bulb and tubing in a fitted case.

- 19-70 Otoscope Set
- 19-71 Set of 3 Specula: Small, Medium & Large Sizes For Otoscope
- 19-71-1 Small Speculum
- 19-71-2 Medium Speculum
- 19-71-3 Large Speculum

MILTEX SIEGEL MAGNIFIER OTOSCOPE

Chrome. 3.15x magnification with 3 specula: small, medium and large sizes. Complete with inflation bulb and tubing.

- 19-75 Rubber Bulb w/tubing For Otoscope



22820



22821

WELCH ALLYN 2.5V POCKETSCOPE™ OTOSCOPE/THROAT ILLUMINATOR

Halogen light for true tissue color and consistent, long lasting illumination. Fiber optics for cool light with no reflection, no obstruction. Wide angle viewing lens. Sealed system for pneumatic otoscopy. Built-in throat illuminator/penlight for added versatility.

- 21111 PocketScope Otoscope/Throat Illuminator w/o handle
- 22800 PocketScope Otoscope/Throat Illuminator w/handle & rechargeable battery
- 22811 PocketScope Otoscope/Throat Illuminator w/handle, rechargeable battery & soft case
- 22820 PocketScope Otoscope/Throat Illuminator w/AA alkaline battery handle
- 22821 PocketScope Otoscope/Throat Illuminator w/AA alkaline battery handle & soft case

Accessories

- 211005 Replacement Lens



WELCH ALLYN 2.5V/3.5V HALOGEN DIAGNOSTIC OTOSCOPE ACCESSORIES

- 21504 Insufflator Bulb & Tube w/tip



21600



21700

WELCH ALLYN 2.5V/3.5V HALOGEN OPERATING OTOSCOPE

Open system for procedures with fully rotatable 5/16" (7.9 mm) diameter magnifying lens and rotatable speculum. Halogen illumination with fiber optic light transmission.

- 21600 2.5V Otoscope w/5 polypropylene specula (sizes 2, 3, 4, 5 & 9mm)
- 21601 2.5V Otoscope w/o specula
- 21700 3.5V Otoscope w/5 polypropylene specula (sizes 2, 3, 4, 5, 9 mm)
- 21701 Same as No. 21700, w/o specula

Accessories

- 209026-501 Lens and Attachable Arm



20100



20200



20201

WELCH ALLYN 2.5V/3.5V HALOGEN PNEUMATIC OTOSCOPE

Closed system, with insufflator fitting for pneumatic otoscopy. Large magnifying lens can be easily rotated to facilitate use of swabs, currettes, etc. Halogen illumination with fiber optic light transmission.

- 20100 2.5V Otoscope w/5 polypropylene specula (sizes 2, 3, 4, 5 & 9 mm)
- 20101 2.5V Otoscope w/o specula
- 20200 3.5V Otoscope w/5 polypropylene specula (sizes 2, 3, 4, 5, 9 mm)
- 20201 Same as No. 20200, w/o specula
- 20250 3.5V Pneumatic Otoscope w/12 Diopter Lens & Specula (head only)

Accessories

- 21501 Insufflator Bulb & Tube w/o tip

WELCH ALLYN DIGITAL MACROVIEW™ OTOSCOPE SETS

Clear, digital image for live view and image capture — great for patient and student education, patient record documentation and supporting information for referrals. Ability to focus and fine tune view. Insufflation port for pneumatic otoscopy. Works with all existing Welch Allyn 3.5V power sources (handles and wall transformer). Plug and play — no special software necessary (requires computer running Windows XP Service Pack 2.0 or higher and an available USB 2.0 port)

- 23920 Otoscope, Digital, 3.5V, Set Includes: Head, USB Cable, Set of 4 Reusable Tips

Accessories

- 23900-10 Replacement USB Cable, 10 ft

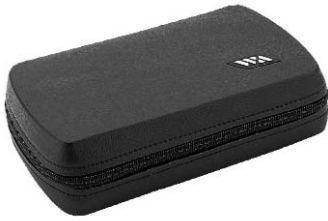

WELCH ALLYN 3.5V HALOGEN OTOSCOPE SETS

20270 20200 Otoscope, 71000 Handle, 05251 Hard Case

Accessories

05252-U Hard Case For 20270
05257-U Hard Case For 21770

WELCH ALLYN 3.5V MACROVIEW OTOSCOPE SETS

25070-M 23810 Otoscope, 71000 Handle, 05251 Hard Case
25270-M 23820 Otoscope, 71000 Handle, 05251 Hard Case

WELCH ALLYN 3.5V HALOGEN PNEUMATIC OTOSCOPE/THROAT ILLUMINATOR

Dual-purpose instrument allows practitioner to examine the ears, then detach otoscope head and have an instant, high-intensity throat illuminator. Wide angle viewing lens slides left or right. Halogen illumination with fiber optic light transmission.

25257 Illuminator Section Only

WELCH ALLYN MACROVIEW™ OTOSCOPE

30% higher magnification over standard otoscopes. Nearly a full view of the tympanic membrane. Ability to focus to fine tune the view. Greater tip retention and easier tip removal.

23810 3.5V Otoscope w/specula (head only)
23814 3.5V Otoscope (23810) w/insufflation bulb
23820 3.5V Otoscope w/throat illuminator
23824 3.5V Otoscope (23820) w/insufflation bulb

WELCH ALLYN MACROVIEW™ OTOSCOPE ACCESSORIES

05215-M Soft Case For 3.5V Set
05258-M Hard Case For PanOptic Ophthalmoscope 3.5V Set
05259-M Hard Case For 3.5V Set
05815-M Soft Case For PanOptic Ophthalmoscope 3.5V Set
06500-U 3.5V Halogen Lamp For Otoscope
23804 Insufflation Bulb For Otoscope
23857 3.5V Throat Illuminator Section Only For Otoscope
26038 Bivalve Nasal Speculum For MacroView™ Complete
26538 Nasal Illuminator For MacroView™ Complete



2056-201



3010

RIESTER POCKET OTOSCOPE

- 2056-201 Pocket Otoscope, AA-Handle w/direct illumination halogen light 2.5V, Black w/pouch, Pen-Scope®
- 2058-201 Pocket Otoscope, AA-Handle w/direct illumination halogen light 2.5V, Slate-Grey w/pouch, Pen-Scope®
- 2060-201 Pocket Otoscope, AA-Handle w/direct illumination halogen light 2.5V, Blue w/pouch, Pen-Scope®
- 2066-201 Pocket Otoscope, AA-Handle w/direct illumination halogen light 2.5V, Saffron w/pouch, Pen-Scope®
- 2068-201 Pocket Otoscope, AA-Handle w/direct illumination halogen light 2.5V, Green w/pouch, Pen-Scope®
- 3000 Pocket Otoscope, AA-Handle w/F.O. Halogen Light 2.5V, Slate-Grey w/case, Ri-Mini®
- 3003 Pocket Otoscope, AA-Handle w/F.O. Halogen Light 2.5V, Blue w/case, Ri-Mini®
- 3004 Pocket Otoscope, AA-Handle w/F.O. Halogen Light 2.5V, Saffron w/case, Ri-Mini®
- 3005 Pocket Otoscope, AA-Handle w/F.O. Halogen Light 2.5V, Green w/case, Ri-Mini®
- 3010 Pocket Otoscope, AA-Handle w/F.O. Halogen Light 2.5V, Black w/case, Ri-Mini®

ADC POCKET OTOSCOPE

Otoscope features fiberoptics for cool, obstruction free light transmission; wide angle, removable lens and disposable polypropylene ear specula. Features a 2.5V halogen light source, interchangeable metal handles and a lifetime quality performance guarantee on optics. Includes fitted case. Latex free system.

5111 Pocket Otoscope

SPECLINC OTREC® DISPOSABLE OTOSCOPE SPECULA WALL DISPENSERS

- 7000 Wall Dispenser for Diagnostic: 7250, 7300, 7400, 7500 5/pk (includes Wall Bracket), 10pk/cs
- 7777 Wall Dispenser for Operating and Consulting: 7225, 7333, 7555, 7666 and 7999, 5/pk (includes Wall Bracket), 10pk/cs

Brand names you can trust.

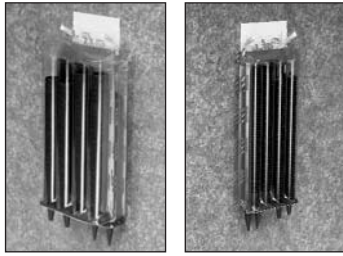

7225

7250

SPECTINC OTREC® DISPOSABLE OTOSCOPE SPECULA

Complete speculum is disposable, providing a clean tip for each use. No covers or adapters are needed. Black color for less reflection and greater clarity.

- 7225 2.5 mm Otoscope Specula, 500/pk, 10 pk/cs (5000/cs)
- 7250 Pediatric, 2.5 mm Otoscope Specula, (cross reference #52432), 1000/pk, 10 pk/cs (10,000/cs)
- 7300 Youth, 3 mm Otoscope Specula, 1000/pk, 10 pk/cs (10,000/cs)
- 7333 3 mm Otoscope Specula (cross reference #52133), 500/pk, 10 pk/cs (5000/cs)
- 7400 Med. Adult, 4 mm Otoscope Specula (cross reference #52434), 1000/pk, 10 pk/cs (10,000/cs)
- 7444 4 mm Otoscope Specula (cross reference #51234), 500/pk, 10 pk/cs (5000/cs)
- 7500 Lg. Adult, 5 mm Otoscope Specula, 1000/pk, 10 pk/cs (10,000/cs)
- 7555 5 mm Otoscope Specula (cross reference #52135), 500/pk, 10 pk/cs (5000/cs)
- 7666 6 mm Otoscope Specula, 500/pk, 10 pk/cs (5000/cs)
- 7999 9 mm Otoscope Specula, 500/pk, 10 pk/cs (5000/cs)



52100

52101

52400

52401

WELCH ALLYN OTOSCOPE SPECULA DISPENSERS

Wall mount dispensers for KleenSpec disposable specula.

- 52100 Dispenser For Specula Nos. 52133, 53134 & 52135, 10/cs
- 52101 Dispenser For Specula Nos. 52133, 53134 & 52135, w/storage compartment, 10/cs
- 52400 Dispenser For Specula Nos. 52432, 52434, 10/cs
- 52401 Dispenser For Specula Nos. 52432, 52434, w/storage compartment, 10/cs



WELCH ALLYN KLENSPEC® DISPOSABLE OTOSCOPE SPECULA

Make of nontoxic plastic; to be used once then discarded. No adapter required. Black.

- 52133 3 mm Specula, For Use With Pneumatic, Operating & Consulting Oscopes, 500/bg, 10 bg/cs
- 52134 4 mm Specula, For Use With Pneumatic, Operating & Consulting Oscopes, 500/bg, 10 bg/cs
- 52135 5 mm Specula, For Use With Pneumatic, Operating & Consulting Oscopes, 500/bg, 10 bg/cs
- 52432-U 2.75mm Universal KleenSpec Disposable Otoscope Specula, 850/bg, 10 bg/cs
- 52434-U 4.25mm Universal KleenSpec Disposable Otoscope Specula, 850/bg, 10 bg/cs



WELCH ALLYN POLYPROPYLENE REUSABLE SPECULUM

Material is lightweight and durable. Can be autoclaved, boiled or cleaned with standard germicides.

- 22002 2 mm Speculum, For Use With Pneumatic, Operating & Consulting Oscopes, Dark Green
- 22003 3 mm Speculum, For Use With Pneumatic, Operating & Consulting Oscopes, Dark Green
- 22004 4 mm Speculum, For Use With Pneumatic, Operating & Consulting Oscopes, Dark Green
- 22005 5 mm Speculum, For Use With Pneumatic, Operating & Consulting Oscopes, Dark Green
- 22009 9 mm Speculum (nasal), For Use With Pneumatic, Operating & Consulting Oscopes, Dark Green
- 22100 Set of 5 Specula (2, 3, 4, 5, 9mm), For Use With Pneumatic, Operating & Consulting Oscopes, Dark Green
- 24302-U 2 mm Speculum, Universal Poly Reusable
- 24303-U 3 mm Speculum, Universal Poly Reusable
- 24304-U 4 mm Speculum, Universal Poly Reusable
- 24305-U 5 mm Speculum, Universal Poly Reusable
- 24400-U Set of 4 Speculum, Universal Poly Reusable



WELCH ALLYN SOFSPEC™ OTOSCOPE SPECULA

Polypropylene base with soft, flexible tip provides improved seal for pneumatic otoscopy. Can be autoclaved, boiled or cleaned with standard germicides.

- 22023 3 mm Speculum, For Use With Pneumatic, Operating and Consulting Oscopes
- 22025 5 mm Speculum, For Use With Pneumatic, Operating and Consulting Oscopes
- 22027 7 mm Speculum, For Use With Pneumatic, Operating and Consulting Oscopes
- 22120 Set of Above 3 Specula, For Use With Pneumatic, Operating and Consulting Oscopes
- 24323 3 mm Speculum, For Use With Diagnostic Oscopes
- 24325 5 mm Speculum, For Use With Diagnostic Oscopes
- 24327 7 mm Speculum, For Use With Diagnostic Oscopes
- 24420 Set of Above 3 Specula, For Use With Diagnostic Oscopes



ADC POCKET OPHTHALMOSCOPE

Ophthalmoscope features five aperture selections for general and specialist use; 17 lenses from -20 to +20 diopters; illuminated dial and built-in lens dust cover. Features a 2.5V halogen light source, interchangeable metal handles and a lifetime quality performance guarantee on optics. Includes fitted case. Latex free system.

- 5110 Pocket Otoscope/Ophthalmoscope Set
- 5112 Pocket Ophthalmoscope



12800

12820

WELCH ALLYN 2.5V POCKETSCOPE™ OPHTHALMOSCOPE

Halogen light for true tissue color and consistent, long lasting illumination. Five aperture selections. 48 lenses for better resolution. Polarized filter to reduce corneal reflection. Compact size fits in pocket.

- 12800 PocketScope Ophthalmoscope w/handle & rechargeable battery
- 12811 PocketScope Ophthalmoscope w/handle, rechargeable battery & soft case
- 12820 PocketScope Ophthalmoscope w/AA alkaline battery handle
- 12821 PocketScope Ophthalmoscope w/AA alkaline battery handle & soft case
- 13000 PocketScope Ophthalmoscope w/o handle

Accessories

- 05280-1 Compact Zipper Case
- 05928-U Soft Case



WELCH ALLYN 2.5V/3.5V HALOGEN OPHTHALMOSCOPE

Features high-intensity halogen illumination and mirror optical system. 28 lenses with illuminated lens dial. Apertures (microspot, small spot, large spot, fixation, red-free, and slit) for all diagnostic applications.

- 11710 3.5V Halogen Ophthalmoscope, Head Only



WELCH ALLYN 3.5V HALOGEN OPHTHALMOSCOPE SETS

- 11750 11710 Ophthalmoscope, 71000 Handle, 05251 Hard Case
- 11751 11710 Ophthalmoscope, 71000 Handle, 05214 Soft Case
- 11770 11720 Ophthalmoscope, 71000 Handle, 05251 Hard Case
- 11771 11720 Ophthalmoscope, 71000 Handle, 05214 Soft Case
- 11790 11730 Ophthalmoscope, 71000 Handle, 05251 Hard Case
- 11791 11730 Ophthalmoscope, 71000 Handle, 05214 Soft Case

Accessories

- 05214-U Soft Case



WELCH ALLYN HALOGEN COAXIAL AUTOSTEP OPHTHALMOSCOPE

Provides 68 viewing lenses with continuous single diopter steps or automatic progression from -30 to +38. Wide range of diopter steps facilitates precise focusing. Lens values fully displayed, no mathematical calculations required. Advanced halogen coaxial optics for high intensity illumination.

- 11730 3.5-V Halogen Coaxial Autostep Ophthalmoscope



WELCH ALLYN HALOGEN COAXIAL OPHTHALMOSCOPE

23 lenses. Illuminated lens dial. Sealed optics provide better dust protection. Coaxial optical system eliminates shadows and facilitates exam through virtually any size pupil or vitreous disorder. Special contoured mirror and matching lamp filament allow axis of illumination to be practically coincidental with axis of physician's vision. Apertures include microspot, small spot, large spot, fixation, cobalt blue, and slit.

- 11720 3.5V Halogen Coaxial Ophthalmoscope, Head Only

WELCH ALLYN PANOPTIC™ OPHTHALMOSCOPE

Patented new Axial PointSource™ Optics. Illumination system converges the light to a point at the cornea, allowing easy entry into small, undilated pupils. The illumination pathway then diverges to the retina, illuminating a very wide area of the fundus. Viewing system enables the operator to view the illuminated area on virtually the same axis, creating the widest field-of-view attainable. Provides a five-times larger view of the fundus than every before achieved with a standard ophthalmoscope in an undilated eye. Increases magnification by 26% over a standard ophthalmoscope. Patented Glare Extinguishment System prevents interference from unwanted glare and reflections. Works with all existing Welch Allyn 3.5v power sources (battery handle or wall transformer) saving additional investment. The patient eyecup establishes and maintains proper viewing distance, provides stabilization for the view, is a pivoting point for leverage in panning around the retina, occludes ambient light, and helps with orientation. The dynamic focusing wheel adjusts the focus in a continuous, smooth action for more precise control and the optimum view with a focusing range of -20 to +20 diopters. The aperture dial has micro, small, and large spot sizes, a slit aperture, and red-free filter, and cobalt blue filter with add-on corneal magnifying lens (Model 11820 only).

- 11810 PanOptic Ophthalmoscope w/o Blue Filter
- 11820 PanOptic Ophthalmoscope w/Blue Filter & Lens

Accessories

- 03800-U PanOptic Lamp
- 05258-MBX PanOptic Diagnostic Case
- 05815-MBX PanOptic Diagnostic Soft Case
- 11870 Patient Eye Cup, 5/set
- 11875 Corneal Lens



RIESTER POCKET OPHTHALMOSCOPE

- 3001 Pocket Ophthalmoscope, AA-Handle w/F.O. halogen light 2.5V, Slate-Grey w/case, Ri-Mini®
- 3006 Pocket Ophthalmoscope, AA-Handle w/F.O. halogen light 2.5V, Blue w/case, Ri-Mini®
- 3007 Pocket Ophthalmoscope, AA-Handle w/F.O. halogen light 2.5V, Saffron w/case, Ri-Mini®
- 3008 Pocket Ophthalmoscope, AA-Handle w/F.O. halogen light 2.5V, Green w/case, Ri-Mini®
- 3011 Pocket Ophthalmoscope, AA-Handle w/F.O. halogen light 2.5V, Black w/case, Ri-Mini®

ADC COMPLETE 2.5V INSTRUMENT SET

Five different instruments in a fitted case. Features: bayonet locking mounts for each instrument head. C cell powered, satin finish chrome-plated battery handle with knurled finish. Rheostatic on/off switch. Complete in zippered case with fitted foam insert that is scuff and scratch resistant and cleans easily

- 5215 Complete Diagnostic Set

ADC COMPLETE 2.5V INSTRUMENT SET ACCESSORIES

- 5215-M3 #3 Laryngeal Mirror
- 5215-M4 #4 Laryngeal Mirror
- 5215-NS Nasal Speculum
- 5215-TD Metal Tongue Depressor
- 5215-TH Illuminated Tongue Blade Holder
- 5215-TO Tongue Depressor Attachment For Disposable
- 5215-ZC Black Zipper Case
- 5220 Otoscope Head Only
- 5240 Ophthalmoscope Head Only
- 5260 Battery Handle
- 5312 Dermoscope

WELCH ALLYN PANOPTIC™ OPHTHALMOSCOPE AND MACROVIEW™ OTOSCOPE COMBO

- 23810-PAN Combination of 11820 PanOptic/23810 MacroView Oto Combo Heads
- 23820-PAN Combination of 11820 PanOptic/23820 MacroView w/Throat Illuminator/Oto Combo Heads

ADC POCKET OTOSCOPE/OPHTHALMOSCOPE SET ACCESSORIES

- 5120 Otoscope Head Only For 5111
- 5121 Insufflator For Otoscope
- 5122 Insufflator Bulb For Otoscope
- 5140 Ophthalmoscope Head Only For 5112
- 5160 Battery Handle For Pocket Instruments
- 5182 2.75mm Disposable Specula, 850/pkg
- 5185 4.25mm Disposable Specula, 850/pkg
- 925110-00 Hard Case Only For 5110
- 925111-00 Hard Case Only For 5111
- 925112-00 Hard Case Only For 5112



92821



72600

WELCH ALLYN POCKETSCOPE SETS - AA

Set includes PocketScope Ophthalmoscope and Otoscope along with a PocketScope AA alkaline battery handle for each instrument. Delivers performance in a slightly smaller package with slightly less light than the larger, full-size diagnostic instruments. Halogen illumination provides bright, white light for true tissue color rendition.

- 92820 PocketScope Set Includes Ophthalmoscope, Otoscope/Throat Illuminator, 2 "AA" Alkaline Battery Handles, Hard Case (w/o charger)
- 92821 PocketScope Set Includes Ophthalmoscope, Otoscope/Throat Illuminator, 2 "AA" Alkaline Battery Handles, Soft Case w/o charger)

Accessories

- 72600 2.5V Rechargeable Battery
- 72800 PocketScope Set Handle w/rechargeable battery
- 72801 PocketScope Set Handle w/o batteries

WELCH ALLYN 3.5V COAXIAL MACROVIEW OTOSCOPE/OPHTHALMOSCOPE SETS

- 97200-M 23820 Otoscope, 11720 Ophthalmoscope, 71000 Handle & Hard Case
- 97200-MC 11720 Ophthalmoscope, 23820 Otoscope w/hard case and Convertible

WELCH ALLYN 3.5V MACROVIEW OTOSCOPE/OPHTHALMOSCOPE SETS

- 97100-M 23820 Otoscope, 11710 Ophthalmoscope, 71000 Handle, and Hard Case
- 97110-M 23820 Otoscope, 11710 Ophthalmoscope, 26550 Nasal Illuminator, 71000 Handle, and Hard Case
- 97150-M 23810 Otoscope, 11710 Ophthalmoscope, 71000 Handle and Hard Case

Ask your sales representative for updated pricing.

Illuminators/Scopes

WELCH ALLYN INTEGRATED DIAGNOSTIC SYSTEMS & WALL TRANSFORMER SETS

A convenient modular package that puts everything needed for fast, accurate diagnoses at arm's length. By combining a wall aneroid, ophthalmoscope, otoscope, specula dispenser and thermometer (optional). Customize your wall set to match your individual needs.

76791-1MPX	Wall Transformer Set, PanOptic Ophthalmoscope, MacroView Otoscope, 767 Tycos Wall Aneroid, KleenSpec Specula Dispenser For Diagnostic Oscopes & SureTemp Plus
76791-22MPX	Wall Transformer Set w/clock, 11820 PanOptic Ophthalmoscope, MacroView Otoscope, 767 Tycos Wall Aneroid, SureTemp Plus Thermometer, KleenSpec Specula Dispenser & Wall Board
76791-2MPX	Wall Transformer Set, 11820 PanOptic Ophthalmoscope, MacroView Otoscope, 767 Tycos Wall Aneroid, SureTemp Plus Thermometer, KleenSpec Specula Dispenser & Wall Board
76791-MX	Wall Transformer Set, Standard Ophthalmoscope, MacroView Otoscope, 767 Tycos Wall Aneroid, KleenSpec Specula Dispenser For Diagnostic Oscopes & SureTemp Plus Wall Thermometer
76792-1MP	Wall Transformer Set, PanOptic Ophthalmoscope, MacroView Otoscope, 767 Tycos Wall Aneroid, KleenSpec Specula Dispenser For Diagnostic Oscopes & Wall Board
76792-2MP	Wall Transformer Set, 11820 PanOptic Ophthalmoscope, MacroView Otoscope, 767 Tycos Wall Aneroid, KleenSpec Specula Dispenser & Wall Board
76792-M	Wall Transformer Set, Standard Ophthalmoscope, MacroView Otoscope, 767 Tycos Wall Aneroid, KleenSpec Specula Dispenser For Diagnostic Oscope & Wall Board
76792-MNOBP	Wall Transformer Set, Standard Ophthalmoscope, MacroView Otoscope, KleenSpec Specula Dispenser For Diagnostic Oscope & Wall Board
76793-MX	Wall Transformer Set, Coaxial Ophthalmoscope, MacroView Otoscope, SureTemp Plus Thermometer, 767 Tycos Wall Aneroid, KleenSpec Specula Dispenser For Diagnostic Oscope & Wall Board
76794-2MPXLI	Wall Transformer Set, 11820 PanOptic Ophthalmoscope, MacroView Otoscope, 52401 KleenSpec Specula Dispenser, Mounting Screws Only For Spot Vital Signs LXI & Wall Board
76794-2MPSPOT	Wall Transformer Set, 11820 PanOptic Ophthalmoscope, MacroView Otoscope, 52401 KleenSpec Specula Dispenser, Mounting Screws Only For Spot Vital Signs & Wall Board
76794-M	Wall Transformer Set, Coaxial Ophthalmoscope, MacroView Otoscope, 767 Tycos Wall Aneroid, KleenSpec Specula Dispenser For Diagnostic Oscope & Wall Board
76794-MLXI	Wall Transformer Set, Coaxial Ophthalmoscope, MacroView Otoscope, 52401 KleenSpec Specula Dispenser, Mounting Screws Only For Spot Vital Signs LXI & Wall Board
76794-MSPOT	Wall Transformer Set, Coaxial Ophthalmoscope, MacroView Otoscope, 52401 KleenSpec Specula Dispenser, Mounting Screws Only For Spot Vital Signs & Wall Board
76795-1MPX	Wall Transformer Set, PanOptic Ophthalmoscope, 23820 MacroView Otoscope, 767 Tycos Wall Aneroid, 52401 KleenSpec Specula Dispenser, SureTemp Plus Thermometer & Wall Board
76795-2MPX	Wall Transformer Set, 11820 PanOptic Ophthalmoscope, 23820 MacroView Otoscope, 767 Tycos Wall Aneroid, 52401 KleenSpec Specula Dispenser, SureTemp Plus Thermometer & Wall Board
76796-1MP	Wall Transformer Set, PanOptic Ophthalmoscope, MacroView Otoscope w/throat illuminator, 767 Tycos Wall Aneroid, 52401 KleenSpec Specula Dispenser & Wall Board
76796-2MP	Wall Transformer Set, 11820 PanOptic Ophthalmoscope, MacroView Otoscope w/throat illuminator, 767 Tycos Wall Aneroid, KleenSpec Specula Dispenser For Diagnostic Oscope & Wall Board
76796-M	Wall Transformer Set, Coaxial Ophthalmoscope, MacroView Otoscope w/throat illuminator, 767 Tycos Wall Aneroid, KleenSpec Specula Dispenser For Diagnostic Oscope & Wall Board
76797-X	Wall Transformer Set, Standard Ophthalmoscope, Pneumatic Otoscope, 767 Tycos Wall Aneroid, 52101 KleenSpec Specula Dispenser, SureTemp Plus Thermometer & Wall Board
76798-2P	Wall Transformer Set, 11820 PanOptic Ophthalmoscope, Pneumatic Otoscope, 767 Tycos Wall Aneroid, KleenSpec Specula Dispenser For Diagnostic Oscope & Wall Board



97120



97220



05215-MBX

WELCH ALLYN 3.5V HALOGEN DIAGNOSTIC SETS

Performing a physical diagnosis is easier with the medical diagnostic instruments featuring our exclusive Halogen HPX™ lamps provide brighter, whiter light than standard halogen lamps for true tissue color and long lasting illumination. Built for durability, ease of use and comfort, these instruments will provide you with lasting satisfaction.

96220	Set, Includes: 1 each Ophthalmoscope 11720, Otoscope 20260, Power Handle 71000-A, & Hard Case 05966-U
97120	Key Components: Standard Ophthalmoscope (head only) #11710; Halogen Lamp #03000-U; Pneumatic Otoscope w/out specula (head only) #20201; Halogen Lamp #03100-U; 5 Specula Set #22100; Direct Plug-In Handle #71000-A; Replacement NiCad Battery #72300; Hard Case
97121	Key Components: Standard Ophthalmoscope (head only) #11710; Halogen Lamp #03000-U; Pneumatic Otoscope w/out specula (head only) #20201; Halogen Lamp #03100-U; 5 Specula Set #22100; Direct Plug-In Handle #71000-A; Replacement NiCad Battery #72300; Soft Case
97170	Key Components: Standard Ophthalmoscope (head only) #11710; Halogen Lamp #03000-U; Pneumatic Otoscope w/out specula (head only) #21701; Halogen Lamp #03100-U; 5 Specula Set #22100; Direct Plug-In Handle #71000-A; Replacement NiCad Battery #72300; Hard Case
97171	Key Components: Standard Ophthalmoscope (head only) #11710; Halogen Lamp #03000-U; Pneumatic Otoscope w/out specula (head only) #20201; Halogen Lamp #03100-U; 5 Specula Set #22100; Direct Plug-In Handle #71000-A; Replacement NiCad Battery #72300; Soft Case
97220	Key Components: Coaxial Ophthalmoscope (head only) #11720; Halogen Lamp #04900-U; Pneumatic Otoscope w/out specula (head only) #20201; Halogen Lamp #03100-U; 5 Specula Set #22100; Direct Plug-In Handle #71000-A; Replacement NiCad Battery #72300; Hard Case
97270	Key Components: Coaxial Ophthalmoscope (head only) #11720; Halogen Lamp #04900-U; Operating Otoscope w/out specula (head only) #21701; Halogen Lamp #03100-U; 5 Specula Set #22100; Direct Plug-In Handle #71000-A; Replacement NiCad Battery #72300; Hard Case
97320	Key Components: AutoStep® Coaxial Ophthalmoscope (head only) #11730; Halogen Lamp #04900-U; Pneumatic Otoscope w/out specula (head only) #20201; Halogen Lamp #03100-U; 5 Specula Set #22100; Direct Plug-In Handle #71000-A; NiCad Battery #72300; Hard Case

Accessories

05215-MBX	Soft Case for 3.5 Volt Sets Boxed
05259-MBX	Hard Case for 3.5 Volt Sets Boxed

WELCH ALLYN 3.5V DIAGNOSTIC SETS

Performing a physical diagnosis is easier with these medical diagnostic instruments featuring our exclusive Halogen HPX™ lamps that provide brighter, whiter light than standard halogen lamps for true tissue color and long-lasting illumination. Built for durability, ease-of-use and comfort, these instruments will provide you with lasting satisfaction.

- 97101-M Diagnostic Set, Includes: Standard Ophthalmoscope (Head Only), Halogen Lamp, MacroView™ Otoscope/Throat Illuminator w/specula (Head Only), Direct Plug-in Rechargeable Handle, NiCad Rechargeable Battery for 71000A/71000C & Soft Case
- 97111-M Diagnostic Set, Includes: Standard Ophthalmoscope (Head Only), Halogen Lamp, MacroView™ Otoscope/Throat Illuminator w/specula (Head Only), Nasal Illuminator Section Only, Plug-In Rechargeable Handle, NiCad Rechargeable Battery for 71000A/71000C & Soft Case
- 97151-M Diagnostic Set, Includes: Standard Ophthalmoscope (Head Only), Halogen Lamp, MacroView™ Otoscope w/specula (Head Only), Direct Plug-in Rechargeable Handle, NiCad Rechargeable Battery for 71000A/71000C & Soft Case
- 97200-MS Diagnostic Set, Includes: Coaxial Ophthalmoscope (Head Only), Halogen Lamp, MacroView™ Otoscope/Throat Illuminator w/specula (Head Only), Lithium Ion Smart Handle w/removable AC adapter, Lithium Ion Battery & Hard Case
- 97201-M Diagnostic Set, Includes: Coaxial Ophthalmoscope (Head Only), Halogen Lamp, MacroView™ Otoscope/Throat Illuminator w/specula (Head Only), Direct Plug-in Rechargeable Handle, NiCad Rechargeable Battery for 71000A/71000C & Soft Case
- 97201-MS Diagnostic Set, Includes: Coaxial Ophthalmoscope (Head Only), Halogen Lamp, MacroView™ Otoscope/Throat Illuminator w/specula (Head Only), Lithium Ion Smart Handle w/removable AC adapter, Lithium Ion Battery & Soft Case
- 97210-M Diagnostic Set, Includes: Coaxial Ophthalmoscope (Head Only), Halogen Lamp, MacroView™ Otoscope/Throat Illuminator w/specula (Head Only), Nasal Illuminator Section Only, Plug-In Rechargeable Handle, NiCad Rechargeable Battery for 71000A/71000C & Hard Case
- 97210-MS Diagnostic Set, Includes: Coaxial Ophthalmoscope (Head Only), Halogen Lamp, MacroView™ Otoscope/Throat Illuminator w/specula (Head Only), Nasal Illuminator Section Only, Lithium Ion Smart Handle w/removable AC adapter, Lithium Ion Battery & Hard Case
- 97211-M Diagnostic Set, Includes: Coaxial Ophthalmoscope (Head Only), Halogen Lamp, MacroView™ Otoscope/Throat Illuminator w/specula (Head Only), Nasal Illuminator Section Only, Plug-in Rechargeable Handle, NiCad Rechargeable Battery for 71000A/71000C & Soft Case
- 97211-MS Diagnostic Set, Includes: Coaxial Ophthalmoscope (Head Only), Halogen Lamp, MacroView™ Otoscope/Throat Illuminator w/specula (Head Only), Nasal Illuminator Section Only, Lithium Ion Smart Handle w/removable AC adapter, Lithium Ion Battery & Soft Case
- 97250-M Diagnostic Set, Includes: Coaxial Ophthalmoscope (Head Only), Halogen Lamp, MacroView™ Otoscope w/specula (Head Only), Direct Plug-in Rechargeable Handle, NiCad Rechargeable Battery for 71000A/71000C & Hard Case
- 97250-MS Diagnostic Set, Includes: Coaxial Ophthalmoscope (Head Only), Halogen Lamp, MacroView™ Otoscope w/specula (Head Only), Lithium Ion Smart Handle w/removable AC adapter, Lithium Ion Battery & Hard Case
- 97251-M Diagnostic Set, Includes: Coaxial Ophthalmoscope (Head Only), Halogen Lamp, MacroView™ Otoscope w/specula (Head Only), Direct Plug-in Rechargeable Handle, NiCad Rechargeable Battery for 71000A/71000C & Soft Case
- 97251-MS Diagnostic Set, Includes: Coaxial Ophthalmoscope (Head Only), Halogen Lamp, MacroView™ Otoscope w/specula (Head Only), Lithium Ion Smart Handle w/removable AC adapter, Lithium Ion Battery & Soft Case

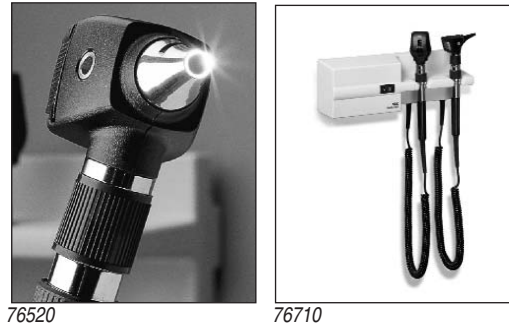

76520

76710

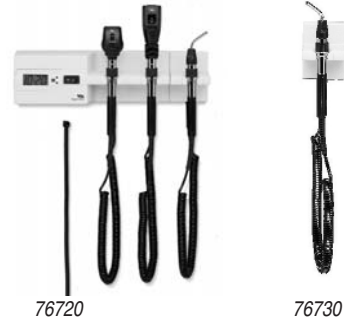

76720

76730

WELCH ALLYN 767 WALL TRANSFORMERS

Puts everything needed for fast, accurate diagnoses at arm's length. Convenient, modular package. Handle-based rheostats for quick light-intensity adjustments. Comfortable, contoured handles are easy to hold and maneuver. Modular coiled cords are guaranteed for 10 years. High-impact ABS housing is durable and easy to clean. Improved cradle design featuring OptiSense™, a reliable optical sensor that automatically turns handles on when they are removed from the cradles. New Halogen HPX™ Lamp provides 30% more light output. Optional digital clock and pulse timer. KleenSpec® Plus Dispenser with a large, 200-specula capacity and integral storage area. Optional third handle module makes expansion a snap.

- 76520 76720 Wall Transformer & 52401 KleenSpec Plus Dispenser
- 76710 3.5V Wall Transformer w/o clock
- 76720 3.5V Wall Transformer w/clock
- 76730 Third Handle Module



WELCH ALLYN COMPACSET™ PORTABLE DIAGNOSTIC SET

Integrates both a full-featured ophthalmoscope and fiber-optic otoscope into one durable, easy-to-use instrument. Small enough to fit in any pocket, weighs just 8.5 ounces. Fully protected by a durable ABS plastic housing. Halogen illumination provides brighter, whiter, longer-lasting light. Instrument heads swivel to allow access from any position.

- 92000 2.5V CompactSet w/AA batteries
- 92100 2.5V CompactSet w/rechargeable batteries

Accessories

- 72610 2.5V Rechargeable Battery



2076



3748.003



3750.001

RIESTER DIAGNOSTIC SETS

- 2010 Otoscope, C-Handle & Vacuum Light 2.7V, Uni®
- 2020 Ophthalmoscope, C-Handle & Vacuum Light 2.7V, Uni® II May
- 2030 Otoscope & Ophthalmoscope, C-Handle & Vacuum Light 2.7V, Uni® III
- 2050 Diagnostic Set, Otoscope & Ophthalmoscope Heads, C-Handle, Vacuum Light 2.7V, Econom®
- 2052-201 Diagnostic Set, Otoscope & Ophthalmoscope Heads, Plug-In Style Handle, Halogen Light 2.5V, Econom®
- 2052-202 Diagnostic Set, Otoscope & Ophthalmoscope Heads, Plug-In Style Handle, Xenon Light 3.5V, Econom®
- 2056-200 Pocket Otoscope, AA-Handle, Direct Illumination Vacuum Light 2.7V, Black, In Pouch, Pen-Scope®
- 2058-200 Pocket Otoscope, AA-Handle, Direct Illumination Vacuum Light 2.7V, Slate-Grey, In Pouch, Pen-Scope®
- 2060-200 Pocket Otoscope, AA-Handle, Direct Illumination Vacuum Light 2.7V, Blue, In Pouch, Pen-Scope®
- 2066-200 Pocket Otoscope, AA-Handle, Direct Illumination Vacuum Light 2.7V, Saffron, In Pouch, Pen-Scope®
- 2068-200 Pocket Otoscope, AA-Handle, Direct Illumination Vacuum Light 2.7V, Green, In Pouch, Pen-Scope®
- 2070 Pocket Ophthalmoscope, AA-Handle, Vacuum Light 2.7V, Blue, In Pouch, Pen-Scope®
- 2076 Pocket Ophthalmoscope, AA-Handle, Vacuum Light 2.7V, Black, In Pouch, Pen-Scope®
- 2078 Pocket Ophthalmoscope, AA-Handle, Vacuum Light 2.7V, Slate-Grey, In Pouch, Pen-Scope®
- 2086 Pocket Ophthalmoscope, AA-Handle, Vacuum Light 2.7V, Saffron, In Pouch, Pen-Scope®
- 2088 Pocket Ophthalmoscope, AA-Handle, Vacuum Light 2.7V, Green, In Pouch, Pen-Scope®
- 3025-524 Pocket Otoscope, Ophthalmoscope & Diagnostic Lamp Fortelux® H, F.O. Halogen Light 2.5V, AA-Handle w/halogen light 2.5V, Black, In Case, Ri-Mini®
- 3026-524 Pocket Otoscope, Ophthalmoscope & Diagnostic Lamp Fortelux® H, F.O. Halogen Light 2.5V, AA-Handle w/halogen light 2.5V, Slate-Grey, In Case, Ri-Mini®
- 3027-524 Pocket Otoscope, Ophthalmoscope & Diagnostic Lamp Fortelux® H, F.O. Halogen Light 2.5V, AA-Handle w/halogen light 2.5V, Blue, In Case, Ri-Mini®
- 3028-524 Pocket Otoscope, Ophthalmoscope & Diagnostic Lamp Fortelux® H, F.O. Halogen Light 2.5V, AA-Handle w/halogen light 2.5V, Saffron, In Case, Ri-Mini®
- 3029-524 Pocket Otoscope, Ophthalmoscope & Diagnostic Lamp Fortelux® H, F.O. Halogen Light 2.5V, AA-Handle w/halogen light 2.5V, Green, In Case, Ri-Mini®
- 3746.011 Otoscope L3 w/LED light 3.5V, Ophthalmoscope L2 w/xenon light 3.5V, C-Handle w/rheostat for 2 Li Batteries, Ri-Scope® L
- 3748.003 Otoscope L2 w/LED light 3.5V, Ophthalmoscope L1 w/xenon light 3.5V, AA-Handle w/rheostat for 2 Li Batteries, Ri-Scope® L
- 3750.001 Otoscope L3 w/LED light 3.5V, Ophthalmoscope L2 w/xenon light 3.5V, Plug-in Handle, Rheostat for Ri-Accu, Ri-Scope® L
- 3750.002 Otoscope L1 w/XL light 3.5V, Ophthalmoscope L1 w/xenon light 3.5V, Plug-in Handle, Rheostat for Ri-Accu, Ri-Scope® L
- 3750.003 Otoscope L2 w/LED light 3.5V, Ophthalmoscope L2 w/xenon light 3.5V, Plug-in Handle, Rheostat for Ri-Accu, Ri-Scope® L
- 3750.004 Otoscope L3 w/LED light 3.5V, Ophthalmoscope L3 w/xenon light 3.5V, Plug-in Handle, Rheostat for Ri-Accu, Ri-Scope® L
- 3777.001 Dermatoscope w/LED light 3.5V, C-Handle w/rheostat for 2 Li Batteries
- 3779 Dermatoscope, LED Light 3.5V, Plug-In Style Handle w/rheostat for 2 Li Batteries
- 3794.001 Slit Retinoscope w/xenon light 3.5V, C Handle w/rheostat for 2 Li Batteries, Ri-Vision®



3651.300.300.5L 3653-300.300.1WOC

RIESTER INTEGRATED WALL DIAGNOSTIC SYSTEM

The diagnostic station ri-former® can be fitted to meet all needs. It is available with two handles and extendable up to maximum five handles as well as with or without clock, connected to the power circuit and therefore independent of conventional or rechargeable batteries.

- 3651-300.300.1L Diagnostic System w/clock, 2 Handles 3.5V/120V, Otoscope L1 w/xenon light 3.5V, Ophthalmoscope L1 w/xenon light 3.5V, R-Former® L
- 3651-300.300.2L Diagnostic System w/clock, 2 Handles 3.5V/120V, Otoscope L2 w/LED light 3.5V, Ophthalmoscope L1 w/xenon light 3.5V, R-Former® L
- 3651-300.300.3L Diagnostic System w/clock, 2 Handles 3.5V/120V, Otoscope L2 w/LED light 3.5V, Ophthalmoscope L2 w/xenon light 3.5V, R-Former® L
- 3651-300.300.4L Diagnostic System w/clock, 2 Handles 3.5V/120V, Otoscope L3 w/LED light 3.5V, Ophthalmoscope L2 w/xenon light 3.5V, R-Former® L
- 3651.300.300.5L Diagnostic System w/clock, 2 Handles 3.5V/120V, Otoscope L3 w/LED light 3.5V, Ophthalmoscope L3 w/xenon light 3.5V, R-Former® L
- 3653-300.300.1WOC Diagnostic System w/o clock, 2 Handles 3.5V/120V, Otoscope L1 w/xenon light 3.5V, Ophthalmoscope L1 w/xenon light 3.5V, R-Former® L
- 3653-300.300.2WOC Diagnostic System w/o clock, 2 Handles 3.5V/120V, Otoscope L2 w/LED light 3.5V, Ophthalmoscope L1 w/xenon light 3.5V, R-Former® L
- 3653-300.300.3LWOC Diagnostic System w/o clock, 2 Handles 3.5V/120V, Otoscope L2 w/LED light 3.5V, Ophthalmoscope L2 w/xenon light 3.5V, R-Former® L
- 3653-300.300.4LWOC Diagnostic System w/o clock, 2 Handles 3.5V/120V, Otoscope L3 w/LED light 3.5V, Ophthalmoscope L2 w/xenon light 3.5V, R-Former® L
- 3653-300.300.5LWOC Diagnostic System w/o clock, 2 Handles 3.5V/120V, Otoscope L3 w/LED light 3.5V, Ophthalmoscope L3 w/xenon light 3.5V, R-Former® L

Personal Attention Local Service



RIESTER INTEGRATED WALL DIAGNOSTIC SYSTEM ACCESSORIES

- 105069-301 Ophthalmoscope Head L1 w/xenon light 3.5V, Anti-Theft Proof, Ri-Scope® L
- 10561-301 Human Operation Otopscope Head w/xenon light 3.5V, Anti-Theft Proof, Ri-Scope®
- 10563-301 Otopscope Head L1 w/xenon light 3.5V, Anti-Theft Proof, Ri-Scope® L
- 10565-301 Otopscope Head L2 w/LED light 3.5V, Anti-Theft Proof, Ri-Scope® L
- 10567-301 Otopscope Head L3 w/LED light 3.5V, Anti-Theft Proof, Ri-Scope® L
- 10571-301 Ophthalmoscope Head L2 w/xenon light 3.5V, Anti-Theft Proof, Ri-Scope® L
- 10573-301 Ophthalmoscope Head L3 w/xenon light 3.5V, Anti-Theft Proof
- 10574-301 Tongue Blade Holder Head w/LED light 3.5V, Anti-Theft Proof, Ri-Scope® L
- 10575-301 Nasal Speculum Head w/F.O. LED Light 3.5V, Anti-Theft Proof, Ri-Scope® L
- 10577-301 Dermatoscope Head w/LED light 3.5V, Anti-Theft Proof, Ri-Derma® L
- 300 Extension Module, 1 Handle 3.5V/120V, Ri-Former® L
- 3651-300.300L Integrated Wall Diagnostic System, 2 Handles 3.5V/120V w/clock, Ri-Former® L
- 3653-300.300L Integrated Wall Diagnostic System, 2 Handles 3.5V/120V w/o clock, Ri-Former® L
- 3654 Extension Module Ear Specula Dispenser Ri-Spec®, Ri-Former® L
- 3656-301 Extension Module Thermometer, Anti-Theft Device, Ri-Thermo® N
- LF3655-109 Extension Module Aneroid Sphygmomanometer w/adult size velcro cuff Big Ben® Square, Ri-Former® L

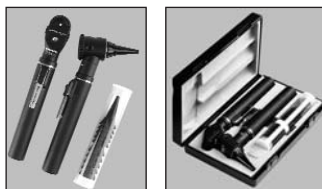

2090-200

3012

RIESTER POCKET OTOSCOPE & OPHTHALMOSCOPE

- 2080-200 Pocket Otopscope & Ophthalmoscope, AA-Handle w/vacuum light 2.7V, Blue w/pouch, Pen-Scope®
- 2090-200 Pocket Otopscope & Ophthalmoscope, AA-Handle w/vacuum light 2.7V, Black w/pouch, Pen-Scope®
- 2092-200 Pocket Otopscope & Ophthalmoscope, AA-Handle w/vacuum light 2.7V, Slate-Grey w/pouch, Pen-Scope®
- 2094-200 Pocket Otopscope & Ophthalmoscope, AA-Handle w/vacuum light 2.7V, Saffron w/pouch, Pen-Scope®
- 2096-200 Pocket Otopscope & Ophthalmoscope, AA-Handle w/vacuum light 2.7V, Green w/pouch, Pen-Scope®
- 3002 Pocket Otopscope & Ophthalmoscope, AA-Handle w/F.O. halogen light 2.5V, Slate-Grey w/case, Ri-Mini®
- 3009 Pocket Otopscope & Ophthalmoscope, AA-Handle w/F.O. halogen light 2.5V, Blue w/case, Ri-Mini®
- 3012 Pocket Otopscope & Ophthalmoscope, AA-Handle w/F.O. halogen light 2.5V, Black w/case, Ri-Mini®
- 3013 Pocket Otopscope & Ophthalmoscope, AA-Handle w/F.O. halogen light 2.5V, Saffron w/case, Ri-Mini®
- 3014 Pocket Otopscope & Ophthalmoscope, AA-Handle w/F.O. halogen light 2.5V, Green w/case, Ri-Mini®



RUSCH STANDARD CONVENTIONAL HANDLE

Non-sterile. Fits any standard blade and FOCS fiber-optic blades. Battery size as indicated.

- 008620100 Small Chrome Plated Brass Handle, Pediatric, 2 x "AA"
- 008621000 Medium/Standard Chrome Plated Brass Handle, 2 x "C"



WELCH ALLYN 2.5V/3.5V DESK CHARGERS WITH RECHARGEABLE HANDLES

Compact units provide constant, automatic recharging. Can not be overcharged. Heads must be ordered separately.

- 71500 2.5V Rechargeable Handle
- 71670 Rechargeable 3.5V Handle Only



WELCH ALLYN 719 SERIES POWER HANDLE

Half the weight of current 3.5v handles. Average 110 minutes of on-time between charging. Smallest diameter of any 3.5v power handle. Made from Cylcoloy® resin from GE plastics. Low-battery indicator. Lithium ion battery technology.

- 71900 719 Series Power Handle
- 71910 Handle, Lithium Ion Rechargeable



70000

70500

70700



71000-A



71000-C

WELCH ALLYN HANDLE FOR 3.5-V HALOGEN INSTRUMENTS

Rechargeable, high-performance handles provide constant 3.5V output. Use rechargeable nickel-cadmium batteries. Heads must be ordered separately.

- 70000 Standard Battery Handle "D" Size
- 70500 Standard Battery Handle "C" Size
- 70700 2.5-V Handle
- 71000-A 3.5V Handle
- 71000-C 3.5-V Handle, Can Convert to C Battery Use in Emergencies
- 71050-C Extra Bottom Section Only For 71000-C, 110-130V, 50/60 Hz



WELCH ALLYN REPLACEMENT LAMPS

00200-U	Vacuum Replacement Lamp For 41000
00900-U	2.5V Vacuum Lamp for OBS17600
01300-U	2.5V Vacuum Replacement Lamp
01400-U	2.5V Vacuum Replacement Lamp For 77800
02000-U	7V Vacuum Replacement Lamp For 45003
02500-U	Replacement Lamp
02600-U	Replacement Lamp
02900-U	2.5V Halogen Replacement Lamp For 290S
03000-U	Halogen Replacement Lamp, 3.5V for Item #s 11710 & 18000
03100-U	Halogen 3.5V Replacement Lamp
03300-U	2.5V Halogen Replacement Lamp
03400-U	2.5V Halogen Replacement Lamp
03600-U	Vacuum Replacement Lamp For 60500
03700-U	3.5V Halogen Replacement Lamp For 18100
03900-U	Halogen Replacement Lamp For 12810
04050-U	150-W Halogen Replacement Lamp
04100-U	Halogen Replacement Lamp
04200-U	Halogen Replacement Lamp
04400-U	Halogen Replacement Lamp For 11470
04430-U	Halogen Replacement Lamp For LS135 Light
04450-U	Halogen Replacement Bulb
04700-U	2.5V Vacuum Lamp for Laryngoscope
04800-U	2.5V Vacuum Lamp For Laryngoscope
04900-U	3.5V Halogen Replacement Lamp
06000-U	Halogen Replacement Lamp
06200-U	Halogen Replacement Lamp
06300-U	Halogen Replacement Lamp
06400-U	Halogen Replacement Lamp
07200-U	Halogen Replacement Lamp For 17200
07600-U	Halogen Replacement Lamp For 76600
07800-U	6V Halogen Replacement Lamp
08200-U	Halogen Replacement Lamp For 18200
08300-U	Halogen Replacement Lamp For 18300
08800-U	4.6V Halogen Replacement Lamp For 78810 Illumination System
DA-ARC	Lamp Replacement For DLS100
DA-L400	Lamp Replacement For DLS400 & DCU2000



WELCH ALLYN REPLACEMENT RECHARGEABLE BATTERIES

Nickel-cadmium rechargeable batteries for Welch Allyn handles. Color coded by voltage.

72000	2.5V Rechargeable Batteries For Nos. 70700, 70710, 70715, 70720, 70750, 70751, 70754, 70755, 71500 & Discontinued 60700 Handles, Color-Coded Red
72200	3.5V Rechargeable Batteries For Nos. 71000, 71010, 71015, 71020, 71050, 71051, 71054, 71055 & 71670 Handles, Color-Coded Black

WELCH ALLYN UNIVERSAL CHARGER

Accepts all Welch Allyn 2.5V, 3.5V, and PocketScope™ (requires adapter) well rechargeable handles. Has a green LED indicating power on. Has a yellow LED under each well indicating the handles are seated and charging. Sports an updated design to fit with our old and new products. Meets all new Agency standards.

71630	Universal Charger w/o instrument heads, Two 71670 NiCad Handles
71640	Universal Charger w/o instrument heads, Two 71900 I-ion Handles
71641-M	Universal Charger, (2) 71670 NiCad Handles, 11720 Ophthalmoscope & 23810 MacroView Otoscope
71641-MS	Universal Charger, (2) 71900 L-ion Handles, 11720 Ophthalmoscope & 23810 MacroView Otoscope
71811-MP	Universal Charger, (2) 71670 NiCad Handles, 11810 Ophthalmoscope & 23810 MacroView Otoscope
71811-MPS	Universal Charger, (2) 71900 L-ion Handles, 11810 Ophthalmoscope & 23810 MacroView Otoscope

Accessories

71140	Universal Charger Only
71249	Pocket Scope Adapter Sleeve Only
71310	Specula Tray
71420	Wall Mount Kit



RIESTER DIAGNOSTIC CHARGER SETS

10701.1	Diagnostic Set w/charger (Ri Charger®), Otoscope Head L1 w/halogen light 2.5V, Ophthalmoscope Head L1 w/halogen light 2.5V, Two AA-Handles & Two Rechargeable Battery NiMH (Ri Accu®)
10701.2	Diagnostic Set w/charger (Ri Charger®), Otoscope Head L1 w/halogen light 2.5V, Ophthalmoscope Head L1 w/halogen light 2.5V, Two C-Handles & Two Rechargeable Battery NiMH (Ri Accu®)
10702.1	Diagnostic Set w/charger (Ri Charger® L), Otoscope Head L1 w/xenon light 3.5V, Ophthalmoscope Head L1 w/xenon light 3.5V, Two AA-Handles & Two Rechargeable Battery Li-ion (Ri Accu®)
10702.2	Diagnostic Set w/charger (Ri Charger® L), Otoscope Head L1 w/xenon light 3.5V, Ophthalmoscope Head L1 w/xenon light 3.5V, Two C-Handles & Two Rechargeable Battery Li-ion (Ri Accu®)
10703.1	Diagnostic Set w/charger (Ri Charger® L), Otoscope Head L2 w/LED light 3.5V, Ophthalmoscope Head L2 w/xenon light 3.5V, Two AA-Handles & Two Rechargeable Battery Li-ion (Ri Accu®)
10703.2	Diagnostic Set w/charger (Ri Charger® L), Otoscope Head L2 w/LED light 3.5V, Ophthalmoscope Head L2 w/xenon light 3.5V, Two C-Handles & Two Rechargeable Battery Li-ion (Ri Accu®)
10704.1	Diagnostic Set w/charger (Ri Charger® L), Otoscope Head L3 w/LED light 3.5V, Ophthalmoscope Head L2 w/xenon light 3.5V, Two AA-Handles & Two Rechargeable Battery Li-ion (Ri Accu®)
10704.2	Diagnostic Set w/charger (Ri Charger® L), Otoscope Head L3 w/LED light 3.5V, Ophthalmoscope Head L2 w/xenon light 3.5V, Two C-Handles & Two Rechargeable Battery Li-ion (Ri Accu®)
10705.1	Diagnostic Set w/charger (Ri Charger® L), Otoscope Head L3 w/LED light 3.5V, Ophthalmoscope Head L3 w/xenon light 3.5V, Two AA-Handles & Two Rechargeable Battery Li-ion (Ri Accu®)
10705.2	Diagnostic Set w/charger (Ri Charger® L), Otoscope Head L3 w/LED light 3.5V, Ophthalmoscope Head L3 w/xenon light 3.5V, Two C-Handles & Two Rechargeable Battery Li-ion (Ri Accu®)

RIESTER DIAGNOSTIC LAMPS

5090	Diagnostic Penlight Fortelux N w/vacuum light 2.2V, Laryngeal Mirror, Tongue Blade Holder & Red Open Filter in a Plastic Case w/2 AAA-Batteries, Ri-Light® Set
------	--

RIESTER E.N.T. INSTRUMENTS ACCESSORIES

10416	Ophthalmoscope Head Uni® HL 3.5V
10417	Ophthalmoscope Head Uni® HL 2.5V
10418	Otoscope Head, Uni® HL 3.5V
10419	Otoscope Head, Uni® HL 2.5V
10420	Otoscope Head, Uni® Vacuum 2.7V
10421	2.7V Vacuum Bulbs, Otoscope Uni®, 6/pk
10423	Ophthalmoscope Head Uni® Vacuum 2.7V
10424	2.7V Vacuum Bulbs, May-Ophthalmoscope Uni®, 6/pk
10425	C Type Battery Handle, Rheostat, Chrome Plated w/o Bore For 2 C Cell Batteries
10426	Upper Handle Part w/rheostat, Chrome Plated
10431	Plug-In-Style Handle 2.5V/120V, Rheostat, Chrome Plated, Ri-Accu® Included
10433	Plug-In-Style Handle 3.5V/120V, Rheostat, Chrome Plated, Ri-Accu® Included
10440	Nasal Speculum, Chrome Plated
10447	1 Pair of Laryngeal Mirrors
10448	Swivel Magnifying Glass Uni® Otoscope, Pin Contact
10460	Specula For Otoscope Uni® 2mm
10461	Specula For Otoscope Uni® 3mm
10462	Specula For Otoscope Uni® 4mm
10463	Specula For Otoscope Uni® 5mm
10464	Specula For Otoscope Uni® 9mm (Nasal Speculum)
10472	2.7V Vacuum Bulbs, Pen-Scope® Otoscope, 6/pk
10473	2.7V Vacuum Bulbs, Pen-Scope® Ophthalmoscope, 6/pk
10477	Magnifying Glass, Otoscope, Blue, Ri-Mini®, Pen-Scope®
10488	Lamps Vacuum 2.7V, 6/pk
10489	Lamps Halogen HL 2.5V, 6/pk
10562	Otoscope Head L1 w/halogen light 2.5V, Ri-Scope® L
10563	Otoscope Head L1 w/halogen light 3.5V, Ri-Scope® L
10565	Otoscope Head L2 w/LED light 3.5V, Ri-Scope® L
10567	Otoscope Head L3 w/LED light 3.5V, Ri-Scope® L
10568	Ophthalmoscope Head L1 w/halogen light 2.5V, Ri-Scope® L
10569	Ophthalmoscope Head L1 w/xenon light 3.5V, Ri-Scope® L
10571	Ophthalmoscope Head L2 w/LED light 3.5V, Ri-Scope® L
10573	Ophthalmoscope Head L3 w/LED light 3.5V, Ri-Scope® L
10590	HL 2.5V Bulbs, Otoscope Uni® L1, 6/pk
10591	HL 2.5V Bulbs, May-Ophthalmoscope Uni®, 6/pk
10592	XL 3.5V Bulbs, Otoscope Uni®, 6/pk
10593	XL 3.5V Bulbs, May-Ophthalmoscope Uni®, 6/pk
10599	LED 3.5V For Ri-Scope® F.O. Otoscope L2/L3, Ri-Derma, Light Conductor, Nasal Speculum & Tongue Blade Holder, 6/pk
10600	Ri-Scope® F.O. Otoscope L2/L3, Ri-Derma®, Light Conductor, Nasal Speculum & Tongue Blade Holder, 6/pk
10605	Ri-Scope® Ophthalmoscope, 6/pk
10608	XL 3.5V Bulbs, Ri-Scope® Ophthalmoscope, 6/pk
10609	XL 3.5V Bulbs, Ri-Scope® Operation Otoscope, 6/pk
10610	XL 3.5V Slit Bulbs, 6/pk
10611	XL 3.5V Spot Bulbs, 6/pk
10630	Battery C-Handle w/rheostat w/o Batteries For 2 Li-Ion Batteries
10639	Plug-In-Style Handle, Rheostat For Halogen Light 2.5V, XL 3.5V or LED 3.5V, Ri-Accu® L
10642	Battery AA-Handle w/rheostat w/o Batteries For AA Batteries For Alkaline or Li-Ion Batteries
10669	Combi Handle 2.5V/120V, Rheostat, Chrome Plated, Ri-Accu® Included
10670	Battery C-Handle w/rheostat w/o Batteries For Alkaline Battery, Li-Ion Battery & NiMH Battery
10675	Plug-In-Style Handle 3.5V/120V, Sensomataic®, Black Chrome Plated, Ri-Accu® Included
10675-528	Plug-In-Style Handle 3.5V/120V, Rheostat, Black Chrome Plated, Ri-Accu® Included
10680	Rechargeable Battery (Ri-Accu®) For Halogen Light 2.5V NiMH For AA-Handles
10681	Rechargeable Battery (Ri-Accu®) For Halogen Light 2.5V NiMH For C-Handles
10683	Rechargeable Battery For Halogen Light 2.5V NiMH Plug-In-Handles, Ri-Accu®

RIESTER E.N.T. INSTRUMENTS ACCESSORIES (Continued)

10690	Rechargeable Battery (Ri-Accu®) For Xenon or LED Light 3.5V Li-Ion For AA-Handles
10691	Rechargeable Battery (Ri-Accu®) For Xenon or LED Light 3.5V Li-Ion For C-Handles
10692	Rechargeable Battery (Ri-Accu®) For Xenon or LED Light 3.5V Li-Ion For Plug-In Style Handles
10701	Charger (Ri-Charger®) Complete, w/wall holder, For All Rechargeable Handles 2.5V & 3.5V w/NiMH or NiCd Batteries 120V
10706	Charger (Ri-Charger®) Complete, w/wall holder, For All Rechargeable Handles 2.5V & 3.5V w/Li-Ion Batteries 120V
10774-531	Disposable Ear Specula For L1/L2, Ri-Mini® Pen-Scope® F.O. Otoscopes 2.5mm, 1000/pk
10774-532	Disposable Ear Specula For L1/L2, Ri-Mini® Pen-Scope® F.O. Otoscopes 2mm, 1000/pk
10774-533	Disposable Ear Specula For L1/L2, Ri-Mini® Pen-Scope® F.O. Otoscopes 3mm, 1000/pk
10774-534	Disposable Ear Specula For L1/L2, Ri-Mini® Pen-Scope® F.O. Otoscopes 4mm, 1000/pk
10774-535	Disposable Ear Specula For L1/L2, Ri-Mini® Pen-Scope® F.O. Otoscopes 5mm, 1000/pk
10775	Reusable Ear Specula For L1/L2, Ri-Mini® Pen-Scope® F.O. Otoscopes 2mm, 10/pk
10779	Reusable Ear Specula For L1/L2, Ri-Mini® Pen-Scope® F.O. Otoscopes 2.5mm, 10/pk
10783	Reusable Ear Specula For L1/L2, Ri-Mini® Pen-Scope® F.O. Otoscopes 3mm, 10/pk
10789	Reusable Ear Specula For L1/L2, Ri-Mini® Pen-Scope® F.O. Otoscopes 4mm, 10/pk
10795	Reusable Ear Specula For L1/L2, Ri-Mini® Pen-Scope® F.O. Otoscopes 5mm, 10/pk
10800-532	Reusable Ear Specula 2.0mm, Black, Ri-Scope L3®, 10/pk
10800-533	Reusable Ear Specula 3.0mm, Black, Ri-Scope L3®, 10/pk
10800-534	Reusable Ear Specula 4.0mm, Black, Ri-Scope L3®, 10/pk
10800-535	Reusable Ear Specula 5.0mm, Black, Ri-Scope L3®, 10/pk
10800-539	Reusable Ear Specula 9.0mm, Black, Ri-Scope L3®, 10/pk
10803-532	Disposable Ear Specula 2.0mm, Blue, Ri-Scope L3®, 1000/pk
10803-533	Disposable Ear Specula 3.0mm, Blue, Ri-Scope L3®, 1000/pk
10803-534	Disposable Ear Specula 4.0mm, Blue, Ri-Scope L3®, 1000/pk
10803-535	Disposable Ear Specula 5.0mm, Blue, Ri-Scope L3®, 1000/pk
10803-539	Disposable Ear Specula 9.0mm, Blue, Ri-Scope L3®, 1000/pk
10960	Bulb For Pneumatic Test
10961	Connector For Pneumatic Test
10962	Magnifying Glass, Otoscope, Slate Grey, Ri-Mini®, Pen-Scope®
10963	Magnifying Glass, Otoscope, Black, Ri-Mini®, Pen-Scope®
10964	Magnifying Glass, Otoscope, Saffron, Ri-Mini®, Pen-Scope®
10966	Magnifying Glass, Otoscope, Green, Ri-Mini®, Pen-Scope®
10967	Swivel Magnifying Glass, Ri-Scope® Otoscope
10968	Skin Contact Disc w/o Graduation
10969	Graduated Skin Contact Disc
11287	Li-Battery 2.5V, 2/pk
11449	Operations Lens, Otoscope, Ri-Scope® L
11504	Ring w/coupling

RIESTER LAMP ACCESSORIES

11177	2.2V Bulbs, Fortelux® N, 6/pk
11178	HL 2.5V Bulbs, Fortelux® H, 6/pk
11305	Head Band Black, Ziegler
11321	Halogen Bulb 8V, Ri-Focus®, Ri-Focus® Reverse, Ri-Magic®

ADC 2.5V DERMASCOPE ACCESSORIES

5312-1	Plain Contact Plate
5312-2	Graduated Contact Plate
5312-3	Dermascope Head
5312-4	Lamp 2.5V Halogen
5312-ZC	Black Zipper Case

AARON SPECIALTY LIGHTS

Individually packaged. Two AA batteries. All lights have a 4-year shelf life.

- 6800 Tech Light™ w/concentric beam
- 6801 White Slit Beam For Cataract Screening
- 6804 1mm Light (for muscle tests)



AARON WOODS LIGHT

UV59 Hand-Held Ultra-Violet Light

Accessories

UV59B Replaceable Black Lamp For UV59

WELCH ALLYN 3.5V HALOGEN NASAL ILLUMINATOR

When attached to throat illuminator section of No. 20000 otoscope/throat illuminator, provides illumination of the nasal passages through a 9mm speculum.

- 26530 3.5-V Halogen Nasal Illuminator, Complete w/9mm polypropylene speculum
- 26535 Nasal Illuminator Section Only

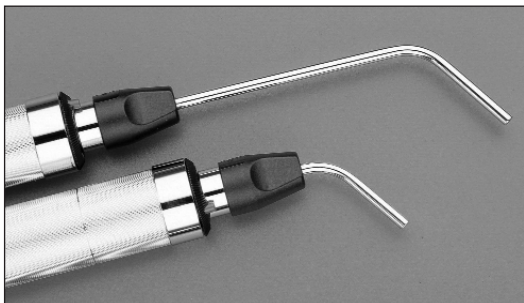

WELCH ALLYN 3.5V HALOGEN TRANSILLUMINATORS

These instruments use halogen illumination transmitted through fiber optics for brilliant, yet cool illumination. Fits any Welch Allyn 3.5V power source. May be sterilized by steam, gas, or some germicidal solutions.

- 41100 3.5V Finnoff Transilluminator (Cobalt Blue Filter Optional 41002)
- 43300 Curved All Purpose Transilluminator



WELCH ALLYN EPISCOPE™

For examining the entire skin surface and making accurate measurements of skin lesions. Bright, 3.5-V halogen illumination and 10x optics system ensure true tissue color and accurate identification of suspicious lesions. Attaches to rechargeable handle. Reticule contact plate allows easy measurement in millimeters. Removable contact plate is autoclavable to eliminate the possibility of cross-contamination. Easy to focus, large knurled focusing ring. Comfortable eyepiece with soft rubber eyewear protector. Fully portable. Soft carrying case accommodates handle and includes pouch for extra front cover. Handles must be ordered separately.

- 47300 EpiScope Skin Surface Microscope w/reticule contact plate
- 47351 EpiScope Set Includes EpiScope, Reticule Contact Plate, Rechargeable Handle, Nickel Cadmium Battery & Soft Carrying Case

Accessories

- 05232-U Soft Carrying Case
- 47310 Reticule Contact Plate
- 47320 Plano Contact Plate



37019



37023



37027

WELCH ALLYN FIBER OPTIC ANOSCOPES

Fiber optics provide cool distal ring of light, no reflections, no obstructions. Autoclavable stainless steel. 45° bevel tip (90° available on request). Set includes speculum, obturator, light handle and transformer.

- 37019 19mm x 7cm Speculum Only w/obturator
- 37023 23mm x 7cm Speculum Only w/obturator
- 37027 27mm x 7cm Speculum Only w/obturator

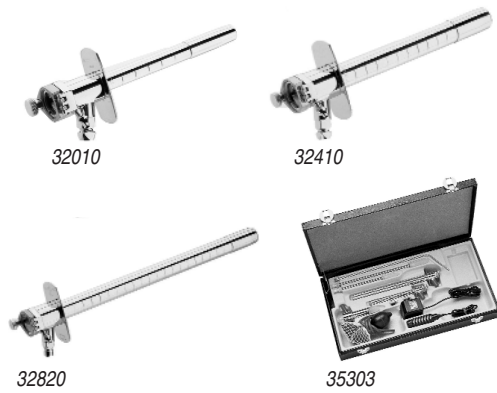

WELCH ALLYN FIBER OPTIC SIGMOIDOSCOPIES

Halogen light. Fiber optics provide cool distal ring of light, no reflections, no obstructions. Autoclavable stainless steel. Hinged window with neoprene seal. Graduated tube with removable tip. Complete set includes: sigmoidoscope speculum, obturator, light handle, insufflation bulb & transformer

- 32010 11mm x 10cm Sigmoidoscope Speculum Only w/obturator
- 32020 11mm x 25cm Sigmoidoscope Speculum Only w/obturator
- 32410 15mm x 15cm Sigmoidoscope Speculum Only w/obturator
- 32420 15mm x 25cm Sigmoidoscope Speculum Only w/obturator
- 32810 19mm x 15cm Sigmoidoscope Speculum Only w/obturator
- 32820 19mm x 25cm Sigmoidoscope Speculum Only w/obturator
- 32830 19mm x 35cm Sigmoidoscope Speculum Only w/obturator
- 33220 23mm x 25cm Sigmoidoscope Speculum Only w/obturator
- 33830 19mm x 30cm Sigmoidoscope Speculum Only w/obturator
- 35303 Set Includes: 32410 Sigmoidoscope, 32820 Sigmoidoscope, 37023 Anoscope, 73210 Light Handle w/cord, 73305 Transformer, 30200 Insufflation Bulb Complete, 07800 Extra Halogen Lamps (2), 30130 Suction Tube, 05391 Case

Accessories

- 05391-U Hard Case



WELCH ALLYN KLENSPEC® DISPOSABLE ANOSCOPE

45° bevel end. Individually wrapped. 19mm x 10cm with orburators.

- 53110 Disposable Anoscope, 25/bx, 4 bx/cs

WELCH ALLYN KLENSPEC® FIBER OPTIC DISPOSABLE SIGMOIDOSCOPE

Speculum attaches to fiber optic light head; no delicate or protruding light carriers to obstruct vision. Brilliant distal illumination is shadow free, without color distortion. For use with any Welch Allyn 3.5V or 2.5V power source and handle adapter or 6.5V handle and transformer.

- 36103 Complete Illumination System includes Fiber Optic Light Head, Light Handle, Transformer & Insufflation Bulb



WELCH ALLYN KLENSPEC® FIBER OPTIC DISPOSABLE SIGMOIDOSCOPE ACCESSORIES

- 30130 30cm Suction Tube
- 30140 40cm Suction Tube
- 30200 Rectal Insufflation Bulb, Bladder Net & Tubing
- 36019 Fiber Optic Light Head
- 38300 Incandescent Light Carrier
- 38700 Fiber Optic Light Carrier
- 53130 Disposable Specula (19 mm x 25 cm) w/obturators, 25/bx, 4 bx/cs
- 73210 Light Handle w/3 ft cord
- 73500 Halogen 3.5-V Handle Adapter
- 73550 Halogen 2.5-V Handle Adaptor



WELCH ALLYN STANDARD ANOSCOPES

Halogen light for true tissue color and consistent, long-lasting illumination. Autoclavable. Comes with obturator.

- 38108 8mm Aperture, Anoscope Only
- 38114 14mm Aperture, Anoscope Only, Standard Speculum, 89mm Length
- 38119 19mm Aperture, Anoscope Only, Standard Speculum, 89mm Length
- 38122 22mm Aperture, Anoscope Only, Standard Speculum, 89mm Length
- 38614 14mm Aperture, Anoscope Only, Operating (Cut-Out) Speculum, 89mm Length
- 38619 19mm Aperture, Anoscope Only, Operating (Cut-Out) Speculum, 89mm Length
- 38622 22mm Aperture, Anoscope Only, Operating (Cut-Out) Speculum, 89mm Length
- 38900 20mm ID, 22mm OD, 68mm Length to Taper, Anoscope Only, Rotating Speculum
- 39614 14mm Aperture, Anoscope Only, Long Speculum, 127mm Length
- 39619 19mm Aperture, Anoscope Only, Long Speculum, 127mm Length
- 39622 22mm Aperture, Anoscope Only, Long Speculum, 127mm Length



SUMMIT REIMBURSABLE ABI SYSTEM

The LifeDop 250 ABI System meets Medicare reimbursement criteria and is economical and portable. The hand-held doppler and 8 MHz bi-directional doppler probe with accompanying printer for fast, bi-directional waveform printout on adhesive-backed label paper for easy placement on report forms.

- L250AB Reimbursable Vascular Doppler, Printer, 2 Cuff & Aneroid
- L250ABSD5B Reimbursable Vascular Doppler, Printer, Aneroid, 2 Cuffs & 5MHz Bi-Directional Probe
- L250ABSD8B Reimbursable Vascular Doppler, Printer, Aneroid, 2 Cuffs & 8MHz Bi-Directional Probe
- L250AC Reimbursable Vascular Doppler, Printer, 4 Cuff & Aneroid
- L250ACSD5B Reimbursable Vascular Doppler, Printer, Aneroid, 4 Cuffs & 5MHz Bi-Directional Probe
- L250ACSD8B Reimbursable Vascular Doppler, Printer, Aneroid, 4 Cuffs & 8MHz Bi-Directional Probe
- L250NC Reimbursable Vascular Doppler, Printer & No Cuffs



C250CB



C250CC



C250CM

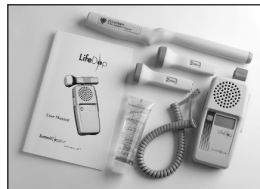

C250CP



C250CV

SUMMIT LIFEDOP HAND-HELD DOPPLER COMBINATION SYSTEMS

- C250CB Obstetrical Combination, L250 Display Doppler w/2 probes (2 & 3MHz)
- C250CC Obstetrical/Vascular Combination, L250 Display Doppler w/2 probes (3 & 8MHz)
- C250CM Obstetrical Combination, L250 Display Doppler w/2 probes (3MHz & EchoHeart)
- C250CP Obstetrical Combination, L250 Display Doppler w/3 probes (2, 3MHz & EchoHeart)
- C250CV Vascular Combination, L250 Display Doppler w/2 probes (5 & 8MHz)



L150SD2



L150SD3



L150SD4



L150SD5



L150SD8

SUMMIT L150 HAND-HELD NON-DISPLAY DOPPLER

The L150 features a non-display unit with superior sound quality, extended battery life, enhanced probe sensitivity, interchangeable probes, and a one-year full warranty.

- L150SD2 Non-Display Hand-Held Doppler w/2MHz obstetrical probe
- L150SD3 Non-Display Hand-Held Doppler w/3MHz obstetrical probe
- L150SD4 Non-Display Hand-Held Doppler w/4MHz vascular probe
- L150SD5 Non-Display Hand-Held Doppler w/5MHz vascular probe
- L150SD8 Non-Display Hand-Held Doppler w/8MHz vascular probe
- L150SDW Non-Display Hand-Held Doppler w/2MHz waterproof obstetrical probe



L150ASD3



L150ASDE

SUMMIT L150A HAND-HELD NON-DISPLAY DOPPLER

The L150A features a non-display unit with superior sound quality, extended battery life, enhanced probe sensitivity, interchangeable probes, and a one-year full warranty. It includes a built-in Audio Recorder (A First in the Market).

- L150ASD2 Non-Display Hand-Held Doppler w/2MHz obstetrical probe & audio recorder
- L150ASD3 Non-Display Hand-Held Doppler w/3MHz obstetrical probe & audio recorder
- L150ASD4 Non-Display Hand-Held Doppler w/4MHz vascular probe & recorder
- L150ASD5 Non-Display Hand-Held Doppler w/5MHz vascular probe & recorder
- L150ASD8 Non-Display Hand-Held Doppler w/8MHz vascular probe & recorder
- L150ASDE Non-Display Hand-Held Doppler w/5MHz EchoHeart Transvaginal Probe & Audio Recorder
- L150ASDW Non-Display Hand-Held Doppler w/2MHz waterproof obstetrical probe & audio recorder



L150RSD2

L150RSD3

L150RSD4



L150RSD5

L150RSD8

L150RSDE

SUMMIT L150R HAND-HELD NON-DISPLAY DOPPLER WITH RECHARGER

The L150R features a non-display unit with superior sound quality, extended battery life, enhanced probe sensitivity, interchangeable probes, and a one-year full warranty. It includes a charging system where you don't have to worry about overcharging or draining the batteries.

- L150RSD2 Non-Display Hand-Held Doppler w/2MHz OB probe & recharger
- L150RSD3 Non-Display Hand-Held Doppler w/3MHz obstetrical probe & recharger
- L150RSD4 Non-Display Hand-Held Doppler w/4MHz vascular probe & recharger
- L150RSD5 Non-Display Hand-Held Doppler w/5MHz vascular probe & recharger
- L150RSD8 Non-Display Hand-Held Doppler w/8MHz vascular probe & recharger
- L150RSDE Non-Display Hand-Held Doppler w/5MHz EchoHeart transvaginal probe & recharger
- L150RSDW Non-Display Hand-Held Doppler w/2MHz waterproof obstetrical probe & recharger



L250SD4

L250SD5



L250SD8

L250SDE

SUMMIT L250 HAND-HELD DISPLAY DOPPLER

The L250 features a display unit with superior sound quality, extended battery life, enhanced probe sensitivity, interchangeable probes, and a one-year full warranty. The large informative display shows battery life, signal quality, and extended 50 to 220 bpm heart rate.

- L250SD4 Display Doppler w/4MHz vascular probe
- L250SD5 Display Doppler w/5MHz vascular probe
- L250SD8 Display Doppler w/8MHz vascular probe
- L250SDE Display Doppler w/5MHz EchoHeart transvaginal probe
- L250SDW Display Doppler w/2MHz waterproof obstetrical probe



Your patients depend on you...
for early detection of peripheral arterial disease (P.A.D.)
to prevent heart attack, stroke and amputation.

The Vista AVS™, a full-featured system for performing the ABI exam for P.A.D. diagnosis, includes:

- 3 modality options for obtaining either pressures or waveforms
- Automated cuff control and indices calculation
- Graphic waveform display with step-by-step instructions
- Software for PC download capability (allows for interface with EMR systems)
- Many more advanced features make the ABI and other arterial exams faster and easier to conduct, interpret and document!

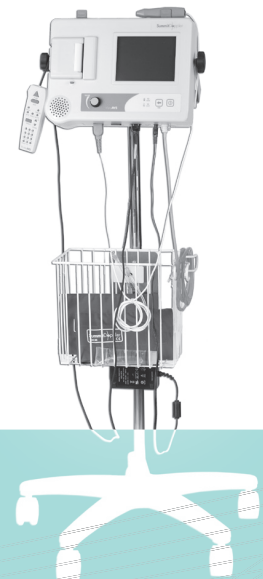

MKT0161A

SummitDoppler
Listening to Life™

Contact your NDC rep or Summit Doppler today for more information!

Quick Return on Investment - \$121/exam!

The Vista AVS can pay for itself in just a few weeks!

The ABI exam for P.A.D. diagnosis is reimbursable under CPT code 93922 at an average of \$121/exam*.

SUMMIT L250AR HAND-HELD DISPLAY DOPPLER WITH AUDIO RECORDER & RECHARGER

The L250AR has it all, a display unit with superior sound quality, extended battery life, enhanced probe sensitivity, interchangeable probes, and a one-year full warranty. The large informative display shows battery life, signal quality, and extended 50 to 220 bpm heart rate. It includes a charging system where you don't have to worry about overcharging or draining the batteries, and includes a built-in Audio Recorder (A First in the Market).

- L250ARSD2 Display Doppler w/2MHz obstetrical probe, audio recorder & recharger
- L250ARSD3 Display Doppler w/3MHz obstetrical probe, recharger & audio recorder
- L250ARSD4 Display Doppler w/4MHz vascular probe, recharger & audio recorder
- L250ARSD5 Display Doppler w/5MHz vascular probe, recharger & audio recorder
- L250ARSD8 Display Doppler w/8MHz vascular probe, recharger & audio recorder
- L250ARSDE Display Doppler w/5MHz EchoHeart transvaginal probe, recharger, & audio recorder
- L250ARSDW Display Doppler w/2MHz waterproof obstetrical probe, recharger & audio recorder



L250SD2



L250SD3

SUMMIT L250R HAND-HELD DISPLAY DOPPLER WITH RECHARGER

The L250R features a display unit with superior sound quality, extended battery life, enhanced probe sensitivity, interchangeable probes, and a one-year full warranty. The large informative display shows battery life, signal quality, and extended 50 to 220 bpm heart rate. It includes a charging system where you don't have to worry about overcharging or draining the batteries.

- L250RSD2 Display Doppler w/2MHz obstetrical probe & recharger
- L250RSD3 Display Doppler w/3MHz obstetrical probe & recharger
- L250RSD4 Display Doppler w/4MHz vascular probe & recharger
- L250RSD5 Display Doppler w/5MHz vascular probe & recharger
- L250RSD8 Display Doppler w/8MHz vascular probe & recharger
- L250RSDE Display Doppler w/5MHz EchoHeart transvaginal probe & recharger
- L250RSDW Display Doppler w/2MHz waterproof obstetrical probe & recharger
- L250SD2 Display Doppler w/2MHz obstetrical probe
- L250SD3 Display Doppler w/3MHz obstetrical probe



L350RSD3



L350RSD8

SUMMIT L350R TABLE TOP DOPPLER WITH RECHARGER

The L350R features a table-top display unit with superior sound quality, pc cable locking system, extended battery life, enhanced probe sensitivity, interchangeable probes, and a one-year full warranty. The large informative display shows battery life, signal quality, and extended 50 to 220 bpm heart rate. It includes a charging system where you don't have to worry about overcharging or draining the batteries.

- L350RSD2 Table-Top Doppler w/2MHz Obstetrical Probe & Recharger
- L350RSD3 Table-Top Display Hand-Held Doppler w/3MHz obstetrical probe & recharger
- L350RSD4 Table-Top Display Doppler w/4MHz Vascular probe & recharger
- L350RSD5 Table-Top Display Doppler w/5MHz Vascular probe & recharger
- L350RSD8 Table-Top Display Doppler w/8MHz Vascular probe & recharger
- L350RSDE Table Top Display Doppler w/5MHz EchoHeart transvaginal probe & recharger
- L350RSDW Table-Top Display Doppler w/2MHz waterproof obstetrical probe & recharger

**Everything you need
for your
state-of-the-art
facility.**



B150



B155



G150



G155



H150

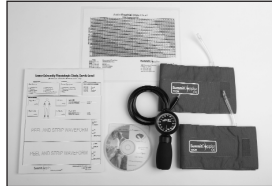

K150



K160



K170



K180



K200



K220



K230



K240

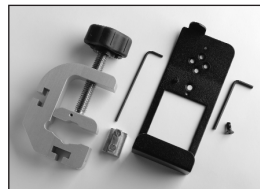

K250



K260



SD5B



SD8B

SUMMIT BI-DIRECTIONAL PROBES

SD5B 5MHz Bi-Directional Vascular Probe
SD8B 8MHz Bi-Directional Vascular Probe



SD2

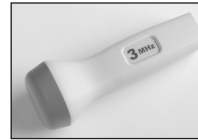

SD3



SD4



SD5



SD8



SDW

SUMMIT NON-DIRECTIONAL PROBES

All LifeDop non-directional probes are durable and interchangeable - accepted by all LifeDop non-directional dopplers.

SD2 2MHz Obstetrical Probe
SD3 3MHz Obstetrical Probe
SD4 4MHz Vascular Probe
SD5 5MHz Vascular Probe
SD8 8MHz Vascular Probe
SDE 5MHz EchoHeart Transvaginal Obstetrical Probe
SDW 2MHz Waterproof Obstetrical Probe

SUMMIT DOPPLER ACCESSORIES

B150 Rechargeable Battery, 3/pk
B155 Alkaline Battery, 3/pk
G150 Aquasonic Clean Ultrasound Gel, 60 gm
G155 Aquasonic Clean Ultrasound Gel, 250 gm
H150 Headphones
K150 ABI Kit Includes: Aneroid, 2 Cuffs, 50 Forms, Chart & Video
K160 ABI 2 Cuff Package: Trigger Release Aneroid, 1-10cm & 1-12cm Cuff
K170 ABI 4 Cuff Package: Trigger Release Aneroid, 2-10cm & 2-12cm Cuffs
K180 Adhesive Backed Printer Label Paper, 5 r/pk
K185 ABI Printer Paper, Thermal Transfer, 5 r/pk
K200 LifeDop Hand-Held Stand w/storage basket, 5 Castor
K220 Pinnacle Table-Top Stand w/storage basket, 5 Castor
K230 LifeDop Hand-Held Stand w/out storage basket, 5 Castor
K240 Pinnacle Table-Top Stand w/out storage basket, 5 Castor
K250 LifeDop Universal Clamp
K260 LifeDop Carrying Case

HUNTLEIGH DOPPLEX® PRINTA™ II DOPPLER

Small, compact, portable, thermal printer for use with MD2 and FD2. Battery or AC operated for high quality print out on 112mm width paper.

PRINTA2/ACC76 Dopplex® Printa™ II w/buffer box

HUNTLEIGH DOPPLEX® REPORTER™ DOPPLER

Software program designed to run on the Windows™ operating system. The upper/lower limb program enables complete arterial and venous assessment documentation and data storage. Interfaces with MD2 Doppler only.

DR3 Dopplex® Reporter™



HUNTLEIGH FETAL DOPPLEX® I PLUS DOPPLER

Fetal dopplex with LCD display of fetal heart rate, fixed 2 MHz transducer and built-in loudspeaker. Waterproof.

FD1+-P-USA Fetal Dopplex® I Plus



HUNTLEIGH FETAL DOPPLEX® II POCKET DOPPLER

Advanced pocket Doppler offers three Fetal Heart Rate (FHR) modes, LCD display, auto-correlation, active noise reduction, digital interface to Dopplex® Printa™ to produce FHR tracings. Supplied with one transducer of choice.

FD2PUSA/OP2HS	Fetal Dopplex® II w/2 MHz Probe
FD2PUSA/OP3HS	Fetal Dopplex® II w/3 MHz Probe
FD2PUSA/VP10HS	Fetal Dopplex® II w/10 MHz Probe
FD2PUSA/VP4HS	Fetal Dopplex® II w/4 MHz Probe
FD2PUSA/VP5HS	Fetal Dopplex® II w/5 MHz Probe
FD2PUSA/VP8HS	Fetal Dopplex® II w/8 MHz Probe



HUNTLEIGH FLEXI DOPPLEX® DOPPLER

Dedicated fetal Doppler with fixed 3 MHz transducer and integral loudspeaker. Waterproof. Includes carry case, headphones, alkaline battery (9V) and gel.

D930-P-USA Flexi Dopplex®



HUNTLEIGH AUDIO DOPPLEX® DOPPLER (WITHOUT DISPLAY)

Dedicated fetal Doppler with fixed 2 MHz transducer and internal loudspeaker. Waterproof. Includes carry case, headphones, alkaline battery (9V) and gel.

D920-P-USA Audio Dopplex® w/o display



HUNTLEIGH MINI DOPPLEX® DOPPLER (WITHOUT DISPLAY)

Non-directional pocket Doppler with internal loudspeaker. Supplied with one transducer of choice, carry case, headphones, alkaline battery (9V), gel and operating instructions.

D900USA/EZ8	Mini Dopplex w/EZ8 Widebeam Probe
D900USA/OP2HS	Mini Dopplex w/2 MHz Probe
D900USA/OP3HS	Mini Dopplex w/3 MHz Probe
D900USA/VP10HS	Mini Dopplex w/10 MHz Probe
D900USA/VP4HS	Mini Dopplex w/4 MHz Probe
D900USA/VP5HS	Mini Dopplex w/5 MHz Probe
D900USA/VP8HS	Mini Dopplex w/8 MHz Probe

Accessories

ACC47 Clamp (Currently available for hospital use only)



MD2PUSA/EZ8



MD2PUSA/OP2HS



MD2PUSA/VP4HS



MD2PUSA/VP8HS

HUNTLEIGH MULTI DOPPLEX® II DOPPLER

Sophisticated pocket Doppler with bi-directional indication of blood flow velocity, 4 level gain control, LCD display, outputs and true separated audio signals, active noise reduction, digital interface to Dopplex® Printa/EKG/or Dopplex® Reporter software package for printout of waveforms (RS232). Supplied with one transducer of choice.

MD2PUSA/EZ8	Multi Dopplex II Pocket w/EZ8 Widebeam Probe
MD2PUSA/OP2HS	Multi Dopplex II Pocket w/2 MHz Probe
MD2PUSA/OP3HS	Multi Dopplex II Pocket w/3 MHz Probe
MD2PUSA/VP10HS	Multi Dopplex II Pocket w/10 MHz Probe
MD2PUSA/VP4HS	Multi Dopplex II Pocket w/4 MHz Probe
MD2PUSA/VP5HS	Multi Dopplex II Pocket w/5 MHz Probe
MD2PUSA/VP8HS	Multi Dopplex II Pocket w/8 MHz Probe



SD2PUSA/EZ8



SD2PUSA/OP2HS

HUNTLEIGH SUPER DOPPLEX® II DOPPLER

Sophisticated pocket Doppler with bi-directional indication of blood flow velocity, LC display, true separated audio signals, clear visual indication of forward and reverse flow, 4 level gain control, active noise reduction. Supplied with one transducer of choice.

SD2PUSA/EZ8	Super Dopplex 2 w/EZ8 Widebeam Probe
SD2PUSA/OP2HS	Super Dopplex 2 w/2 MHz Probe
SD2PUSA/OP3HS	Super Dopplex 2 w/3 MHz Probe
SD2PUSA/VP10HS	Super Dopplex 2 w/10 MHz Probe
SD2PUSA/VP4HS	Super Dopplex 2 w/4 MHz Probe
SD2PUSA/VP5HS	Super Dopplex 2 w/5 MHz Probe
SD2PUSA/VP8HS	Super Dopplex 2 w/8 MHz Probe



EZ8-HS



VP5-HS



VP8-HS

HUNTLEIGH TRANSDUCERS

For FD2, MD2, SD2, and D900.

EZ8-HS	EZ8 Widebeam Probe
OP2-HS	2 MHz Probe For Fetal Heart Detection, High Sensitivity
OP3-HS	3 MHz Probe For Fetal Heart Detection, High Sensitivity
VP10-HS	10 MHz Probe For Very Superficial Vascular Applications, High Sensitivity
VP4-HS	4 MHz Probe For Very Deep Vessels, High Sensitivity
VP5-HS	5 MHz Probe Moderately Deep Vessels, High Sensitivity
VP8-HS	8 MHz Transducer For Peripheral/Superficial Vessels, High Sensitivity



HUNTLEIGH BABY DOPPLEX® DOPPLER 3000 - USA

The advanced electronic design enables accurate data to be produced using autocorrelation signal processing techniques, and displayed and recorded on the thermal paper trace. The pulsed Doppler, 7 Crystal Array Ultrasound Transducer provides excellent fetal heart pick-up and wrap-around bumpers provide additional impact protection. The standard monitor also includes: ultrasound channel, contractions measurement (Toco), automatic fetal movement detection with adjustable sensitivity, patient event marker, clinical event marker and annotation facility, clear LED indication of FHR and UA, high quality audio FHR reproduction, signal quality indicator (dual for twins), internal thermal printer.

BD3000 Baby Dopplex® 3000 USA

Accessories

ACC-15	Printer Paper, Plain, No Grid, 10/bx
ACC-30	Carry Case/Shoulder Bag
ACC-31	Wall Bracket
ACC-53	Trolley Cart



HUNTLEIGH DOPPLER ACCESSORIES

ACC-14	Thermal Dopplex® Printa™ Paper, Plain, No Grid
ACC10	Ultrasonic Gel, 12/bx
DP100	Dopplex® Stand To Help Prevent The Doppler From Being Mishandled, Dropped or Stolen



CT20+



CT30+



CT50+

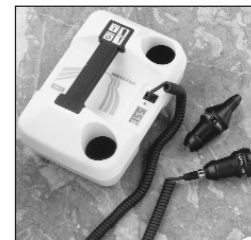

CT80+

NICOLET IMEXDOP CT+™ DOPPLER SYSTEM

Counter top/wall mount Doppler designed for hospitals, clinics and heavy volume offices. Features interchangeable probes, convenient recharging stand and a fetal heart rate display in easy-to-read digital numbers. Supplied with recharging stand, gel, battery pack, monaural earphone and mounting kit. Includes a five-year parts, one-year labor warranty against manufacture defects.

CT20+	Unit w/2 MHz OB Probe
CT23+	Unit w/2 & 3 MHz Probes
CT25+	Unit w/2 & 5 MHz Probes
CT28+	Unit w/2 & 8 MHz Probes
CT30+	Unit w/3 MHz OB Probe
CT35+	Unit w/3 & 5 MHz Probes
CT38+	Unit w/3 & 8 MHz Probes
CT50+	Unit w/5 MHz Vascular Probe
CT58+	Unit w/5 & 8 MHz Probes
CT80+	Unit w/8 MHz Vascular Probe
CTWP	Unit w/2 MHz Waterproof OB Probe



NICOLET IMEX FREEDOP™ DOPPLER SYSTEM

Unique cordless Doppler that allows freedom of movement anywhere in the room during obstetrical or vascular exams. One-hand operation with on/off and volume controls on the probe. Available with interchangeable 5 MHz or 8 MHz vascular probes, 2 MHz or 3 MHz obstetrical probes. Supplied with recharging stand, gel, battery pack and earphone. Includes a five-year parts, one-year labor warranty against manufacture defects.

FR20	Imex FreeDop™ w/2 MHz Obstetrical Probe
FR23	Imex FreeDop™ w/2 & 3 MHz Obstetrical Probes
FR25	Imex FreeDop™ w/2 & 5 MHz Probes
FR28	Imex FreeDop™ w/2 & 8 MHz Probes
FR30	Imex FreeDop™ w/3 MHz Obstetrical Probe
FR35	Imex FreeDop™ w/3 & 5 MHz Probes
FR38	Imex FreeDop™ w/3 & 8 MHz Probes
FR50	Imex FreeDop™ w/5 MHz Vascular Probe
FR58	Imex FreeDop™ w/5 & 8 MHz Probes
FR80	Imex FreeDop™ w/8 MHz Vascular Probe

NICOLET IMEX POCKET-DOP 3™ DOPPLER SYSTEM

A valuable aid in detecting pregnancy and monitoring the fetal heartbeat. Features interchangeable probes: the 3 MHz probe is for early fetal heartbeat detection and the 2 MHz probe is for use in later pregnancy or with larger patients. Also features auto-correlation which is a pattern recognition technique that quickly acquires and accurately tracks the complex signal of the fetal heart rate. Comes with a convenient recharging stand to be placed on a counter or mounted to a wall. Covered by a 5-year parts and 1-year labor warranty.

J200	Doppler w/2 MHz OB Probe
J230	Doppler w/2 & 3 MHz OB Probes
J300	Doppler w/3 MHz OB Probe



NICOLET IMEX POCKET-DOP II™ DOPPLER SYSTEM

Hand-held ultrasonic Doppler features interchangeable probes and built-in speaker for vascular and obstetrical applications. Supplied in soft sided case with 1 or 2 probes, recharger, walkman style headset, gel, batteries and CD ROM of pulse sounds. Includes a five-year parts and one-year labor warranty.

P200	Unit w/2 MHz OB Probe
P230	Unit w/2 & 3 MHz Probes
P250	Unit w/2 & 5 MHz Probes
P280	Unit w/2 & 8 MHz Probes
P2WP	Unit w/2 MHz Waterproof OB Probe
P300	Unit w/3 MHz OB Probe
P350	Unit w/3 & 5 MHz Probes
P380	Unit w/3 & 8 MHz Probes
P500	Unit w/5 MHz Vascular Probe
P580	Unit w/5 & 8 MHz Probes
P800	Unit w/8 MHz Vascular Probe
PAD5	Unit w/5 MHz Probe & ABI Kit
PAD8	Unit w/8 MHz Probe & ABI Kit

NICOLET IMEX DOPPLER ACCESSORIES

A100	Aquasonic Gel, 2 oz Tubes, 12/bx
A120	Aquasonic Gel, .25L Dispenser, 12/bx
A130	Gel, 1 Gram Gel Packs, 200/bx
A140	T-Spray Ultrasound Disinfectant
A210	Personal "Walkman Style" Headset
A410	StethoDop Carrying Pouch
A420	Nylon Soft-Sided Carrying Case
A600	StethoDop Accessory Pack
C610	110V AC Battery Charger (Pocket-Dop OB & II)
C619	220V Battery Charger (Pocket-Dop OB & II)
C620	Rechargeable Batteries, Ni-Cad, AA Size (For Pocket-Dop II & OB), 2/pkg
C622	Battery, 9V Rechargeable For Pocket-Dop 3 & Elite
C623	CareDop & Elite Battery 9V Alkaline
C630	Recharging Stand For Imex Dop CT+ & FreeDop
C630I	220V Replacement Charger & Stand For CT+ & Free Dop
C631	Replacement Main Unit Battery For Imex Dop CT+ * FreeDop
C632	Replacement Probe Battery For Imex FreeDop
C640	Replacement Charger For Pocket-Dop 3 & Elite
C640I	220V Replacement Charger For Elite 100R & 200R
C641	Recharging Stand For Pocket-Dop 3
C643	Replacement Charger & Stand For CT+ & Free Dop
F200	2 MHz Obstetrical Probe For Imex FreeDop
F300	3 MHz Obstetrical Probe For Imex FreeDop
F500	5 MHz Vascular Probe For Imex FreeDop
F800	8 MHz Vascular Probe For Imex FreeDop
H200	2 MHz Obstetrical Probe For Pocket-Dop 3
H300	3 MHz Obstetrical Probe For Pocket-Dop 3
N200	2 MHz OB Probe For Imex CareDop & Elite
N300	3 MHz OB Probe For Imex CareDop & Elite
N500	5 MHz Vascular Probe For Imex CareDop & Elite
N800	8 MHz Pointed Vascular Probe For Imex CareDop™ & Elite™
NW20	2 MHz Waterproof Probe For CareDop & Elite
S100	Non-Sterile Doppler Sheaths, 24/cs
S300	3 1/2" Sterile Doppler Sheaths w/20ml of Ultrasound Gel, 24/cs
T200	2 MHz Obstetrical Probe For Pocket-Dop II, OB & CT+
T300	3 MHz Obstetrical Probe For Pocket-Dop II, OB & CT+
T500	5 MHz Vascular Probe For Pocket-Dop II, OB & CT+
T800	8 MHz Vascular Probe For Pocket-Dop II, OB & CT+
V100	IV Pole Mount For Imex Dop CT+/Imex FreeDop
WP200	2 MHz Waterproof Probe For Pocket-Dop II, OB & CT+



NICOLET IMEX STETHODOP™ DOPPLER SYSTEM

Mounts to most bell-style stethoscopes using a custom non-chill ring. Easy one-hand operation. Momentary on/off actuator operates only when depressed to save battery life. Sliding volume control to adjust to individual user comfort level. Super sensitive Doppler. Custom pager style carrying case. Includes one-year labor and parts warranty against manufacture defects.

SD50	Imex StethoDop w/5 MHz Probe
SD52	Imex StethoDop w/Cardiology Style Stethoscope
SS10	Imex Cardiology Stethoscope
SS20	Imex Classic Stethoscope



VLS48

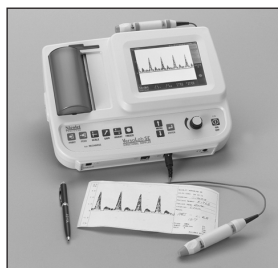

VLS80

NICOLET IMEX VERSALAB BI-DIRECTIONAL DOPPLER SYSTEM

Continuous wave doppler transducers optimized for detecting blood flow throughout peripheral parts of the body. Optional color display feature allows quantification, documentation and qualification of blood flow using a color frequency distribution spectral analysis for accurate determination of direction and velocity of blood flow. Fast, built-in printer for quality documentation of all information obtained. A variety of industry standard calculations and indices calculated to complement the diagnostic capabilities of the VersaLab. Includes a one-year parts and labor warranty against manufacture defects.

VLL40	Unit w/4 MHz LE Bi-Directional Probe
VLL48	Unit w/4 & 8 MHz LE Bi-Directional Probes
VLL80	Unit w/8 MHz LE Bi-Directional Probe
VLS40	Unit w/2 MHz LE Bi-Directional Probe
VLS48	Unit w/4 & 8 MHz LE Bi-Directional Probes
VLS80	Unit w/8 MHz LE Bi-Directional Probe

Accessories

A220	Personal Stereo Headset
A350	Versalab Printer Paper Roll
A355	VersaLab Printer Paper, 5 rl/cs
A430	Soft-Sided Carrying Case
BD40	4 MHz Bi-Directional Probe
BD80	8 MHz Bi-Directional Probe
C633	Battery Pack
C644	Power Supply 110-250V
C644I	Power Supply 220V
C645	Power Cord, 110V
C645I	Power Cord 220V
DV100	VersaLab APM/APM2 Event Marker
DV400	VersaLab Toco Probe Covers, 5/pk
ST30	Tilt Stand
TV100	VersaLab APM/APM2 Toco Probe
TV180	VersaLab APM2, 1.8 MHz Doppler Probe
TV200	VersaLab APM/APM2, 2MHz Doppler Probe
V200	VersaLab IV Pole Mount



NICOLET IMEX ELITE™ 100 DOPPLER

Non-digital (no display) ultrasound Doppler used to determine fetal viability and to assist in monitoring peripheral arterial and venous blood flow. Options include interchangeable obstetric, vascular and waterproof obstetric probes. The system comes with the choice of probe(s), alkaline battery, gel, belt clip and operators manual. Includes one year labor warranty and five year parts warranty against manufacture defects.

EN20	Elite 100 Doppler, Non-Digital Display w/alkaline batteries & 2 MHz OB Probe
EN23	Elite 100 Doppler, Non-Digital Display w/alkaline batteries & 2 & 3 MHz OB Probes
EN25	Elite 100 Doppler, Non-Digital Display w/alkaline batteries & 2 & 5 MHz Probes
EN28	Elite 100 Doppler, Non-Digital Display w/alkaline batteries & 2 & 8 MHz Probes
EN2W	Elite 100 Doppler, Non-Digital Display w/alkaline batteries & 2 MHz Waterproof Probe
EN30	Elite 100 Doppler, Non-Digital Display w/alkaline batteries & 3 MHz OB Probe
EN35	Elite 100 Doppler, Non-Digital Display w/alkaline batteries & 3 & 5 MHz Probes
EN38	Elite 100 Doppler, Non-Digital Display w/alkaline batteries & 3 & 8 MHz Probes
EN50	Elite 100 Doppler, Non-Digital Display w/alkaline batteries & 5 MHz Vascular Probe
EN58	Elite 100 Doppler, Non-Digital Display w/alkaline batteries & 5 & 8 MHz Vascular Probes
EN5A	Elite 100 Doppler, Non-Digital Display w/alkaline batteries, 5 MHz Probe & ABI Kit
EN80	Elite 100 Doppler, Non-Digital Display w/alkaline batteries & 8 MHz Vascular Probe
EN8A	Elite 100 Doppler, Non-Digital Display w/alkaline batteries, 8 MHz Probe & ABI Kit

Your sales representative can assist you with product information and current pricing.



NICOLET IMEX ELITE™ 100R DOPPLER

Non-digital (without display) rechargeable ultrasound Doppler used to determine fetal viability and to assist in monitoring peripheral arterial and venous blood flow. Options include interchangeable obstetric, vascular and waterproof obstetric probes. The system comes with the choice of probe(s), rechargeable battery, battery charger, headset, gel, belt clip and operators manual. Includes one year labor warranty and five year parts warranty against manufacture defects.

- EN20R Elite 100R Doppler, Non-Digital Display w/rechargeable batteries & 2 MHz OB Probe
- EN23R Elite 100R Doppler, Non-Digital Display w/rechargeable batteries & 2 & 3 MHz OB Probes
- EN25R Elite 100R Doppler, Non-Digital Display w/rechargeable batteries & 2 & 5 MHz Probes
- EN28R Elite 100R Doppler, Non-Digital Display w/rechargeable batteries & 2 & 8 MHz Probes
- EN2WR Elite 100R Doppler, Non-Digital Display w/rechargeable batteries & 2 MHz Waterproof Probe
- EN30R Elite 100R Doppler, Non-Digital Display w/rechargeable batteries & 3 MHz OB Probe
- EN35R Elite 100R Doppler, Non-Digital Display w/rechargeable batteries & 3 & 5 MHz Probes
- EN38R Elite 100R Doppler, Non-Digital Display w/rechargeable batteries & 3 & 8 MHz Probes
- EN50R Elite 100R Doppler, Non-Digital Display w/rechargeable batteries & 5 MHz Vascular Probe
- EN58R Elite 100R Doppler, Non-Digital Display w/rechargeable batteries & 5 & 8 MHz Vascular Probes
- EN80R Elite 100R Doppler, Non-Digital Display w/rechargeable batteries & 8 MHz Vascular Probe
- EN8AR Elite 100R Doppler, Non-Digital Display w/rechargeable batteries, 8 MHz Probe & ABI Kit



NICOLET IMEX ELITE™ 200 DOPPLER

A digital display ultrasound Doppler used to determine fetal viability and to assist in monitoring peripheral arterial and venous blood flow. Options include interchangeable obstetric, vascular and waterproof obstetric probes. The system comes with the choice of probe(s), alkaline battery, gel, belt clip, headset for private monitoring, soft-sided carrying case and operator's manual. Includes one year labor warranty and five year parts warranty against manufacture defects.

- ED20 Elite 200 Doppler, Digital Display w/alkaline batteries & 2 MHz OB Probe
- ED25 Elite 200 Doppler, Digital Display w/alkaline batteries & 2 & 5 MHz Probes
- ED28 Elite 200 Doppler, Digital Display w/alkaline batteries & 2 & 8 MHz Probes
- ED2W Elite 200 Doppler, Digital Display w/alkaline batteries & 2 MHz Waterproof Probe
- ED30 Elite 200 Doppler, Digital Display w/alkaline batteries & 3 MHz OB Probe
- ED35 Elite 200 Doppler, Digital Display w/alkaline batteries & 3 & 5 MHz Probes
- ED38 Elite 200 Doppler, Digital Display w/alkaline batteries & 3 & 8 MHz Probes
- ED50 Elite 200 Doppler, Digital Display w/alkaline batteries & 5 MHz Vascular Probe
- ED58 Elite 200 Doppler, Digital Display w/alkaline batteries & 5 & 8 MHz Probes
- ED80 Elite 200 Doppler, Digital Display w/alkaline batteries & 8 MHz Vascular Probe
- ED8A Elite 200 Doppler, Digital Display w/alkaline batteries, 8 MHz Probe & ABI Kit



NICOLET IMEX ELITE™ 200R DOPPLER

A digital display ultrasound Doppler used to determine fetal viability and to assist in monitoring peripheral arterial and venous blood flow. Options include interchangeable obstetric, vascular and waterproof obstetric probes. The system comes with the choice of probe(s), rechargeable battery, battery charger, gel, belt clip, headset for private monitoring, soft-sided carrying case and operator's manual. Includes one year labor warranty and five year parts warranty against manufacture defects.

- ED20R Elite 200R Doppler, Digital Display w/rechargeable batteries & 2 MHz OB Probe
- ED23 Elite 200 Doppler, Digital Display w/alkaline batteries & 2 & 3 MHz OB Probes
- ED23R Elite 200R Doppler, Digital Display w/rechargeable batteries & 2 & 3 MHz OB Probes
- ED25R Elite 200R Doppler, Digital Display w/rechargeable batteries & 2 & 5 MHz Probes
- ED28R Elite 200R Doppler, Digital Display w/rechargeable batteries & 2 & 8 MHz Probes
- ED2WR Elite 200R Doppler, Digital Display w/rechargeable batteries & 2 MHz Waterproof Probe
- ED30R Elite 200R Doppler, Digital Display w/rechargeable batteries & 3 MHz OB Probe
- ED35R Elite 200R Doppler, Digital Display w/rechargeable batteries & 3 & 5 MHz Probes
- ED38R Elite 200R Doppler, Digital Display w/rechargeable batteries & 3 & 8 MHz Probes
- ED50R Elite 200R Doppler, Digital Display w/rechargeable batteries & 5 MHz Vascular Probe
- ED58R Elite 200R Doppler, Digital Display w/rechargeable batteries & 5 & 8 MHz Vascular Probes
- ED80R Elite 200R Doppler, Digital Display w/rechargeable batteries & 8 MHz Probe

HUNTLEIGH TWIN BABY DOPPLEX® DOPPLER 3002

Having all of the features of the 3000 Mark 2 version, the 3002 has a unique and extremely useful feature. Ultrasound FHR traces are produced on "Double Width" paper allowing two completely separate traces to be viewed. This avoids possible confusion which can occur, if conventional twins monitors which superimpose one trace on top of another, are used. A carry case is available to transport the products from clinic to clinic.

- BD3002 Baby Dopplex® 3002



MVAPM

MVAPT

NICOLET IMEX VERSALAB ANTEPARTUM MONITOR™

Easy-to-use antepartum monitor designed for the office or the antepartum testing area of the hospital. Pulsed, directional 1.5 MHz ultrasound locks into the fetal heart rate; sensitive toco transducer tracks maternal contractions. Trace prints out on Z-fold paper for easy scanning and storage. Supplied with chart paper, belt, plastic membrane for toco, gel and patient event marker. Includes a one-year parts and labor warranty against manufacture defects.

- MVAPM Single APM Unit w/toco & 2 MHz Doppler Transducer
- MVAPT Twin APM Unit w/toco 1.8 & 2 MHz Doppler Transducers

NICOLET IMEX ANTEPARTUM MONITOR ACCESSORIES

- D200 Z-Fold Chart Paper
- D300 Belts, Pre-Cut, 2/pk

HUNTLEIGH INTRAOPERATIVE PROBE

Provides confirmation of blood flow following vascular reconstructive procedures. Potential post-operative complications can be minimized by confirming blood flow prior to closing, including the need for re-opening the surgical site. Sterilizable by Autoclave or Ethylene Oxide. Audible confirmation of blood flow; visual and hardcopy confirmation depending on Dopplex® system used. 8MHz operation for reliable flow detection in native vessels and some prosthetic grafts. Simple operation - special electronic adaptor resists diathermy interference and allows connection to any Vascular Dopplex® Advanced Pocket Doppler. A unique easy clean connector system. Bi-directional velocity waveform printouts - when used with the Multi Dopplex® II and the Dopplex® Printa II or Dopplex® Reporter software package. A Dopplex main unit and Adaptor are required to operate your Intraoperative Probe.

- IPP3-USA Probe Pack, 3/pk (Currently available for hospital use only)
- ISP3-D900 Starter Pack, Includes: D900 Doppler, Adaptor, Clamp & 3 Probes (Currently available for hospital use only)
- ISP3-MD2 Starter Pack, Includes: MD2 Doppler, Adaptor, Clamp & 3 Probes (Currently available for hospital use only)
- ISP3-SD2 Starter Pack, Includes: SD2 Doppler, Adaptor, Clamp & 3 Probes (Currently available for hospital use only)
- ISP3-USA Starter Pack, Includes: Adaptor, Clamp & 3 Probes (Currently available for hospital use only)

Accessories

- PA8 Adaptor (Currently available for hospital use only)

HUNTLEIGH DIABETIC FOOT ASSESSMENT KIT

The Diabetic Foot Assessment Kit is ideal for assessing the neuropathic and ischemic foot of the diabetic patients. The complete kit allows the clinician to: Measure the Ankle Brachial Index (ABI), Measure toe pressures TBI, Detect neuropathy, and Record Doppler waveforms (using the optional Dopplex Printa2 or Reporter Software Package).

- DFK1/MD2 Diabetic Foot Assessment Kit
- DFK2-USA-D900 Diabetic Foot Assessment Kit w/D900 mini doppler, includes: Sphygmomanometer, 8MHz Doppler Probe, Arm/Ankle Cuff, Large & Small Toe Cuff, 10g Monofilament, Educational Video, ABI Guide, TBI Guide, Tube of Gel, Headphones, large Polypropylene Case.

GE MEDICAL FETAL CHART PAPERS

Designed for GE Corometrics monitors. Serialized pages for case documentation. Thermal array provides accurate, vivid tracings.

- 4305CAO Fetal Chart Paper, Red Grid, 30-240 BPM, Serialized Pages, Z-Fold, 160 sheets/pk, 40 pk/cs
- 4305DAO Fetal Chart Paper, Red Grid, 50-210 BPM, Serialized Pages, Z-Fold, 160/pk, 40 pk/cs
- 4305FAO Fetal Chart Paper, Red Grid, 50-210 BPM, Serialized Pages, Additional 1 Minute Time Marks, Z-Fold, 160/pk, 40 pk/cs
- 4306CAO Fetal Chart Paper, Green Grid, 50-210 BPM, Serialized Pages, Z-Fold, 150/pk, 40 pk/cs
- 4482AAO Fetal Chart Paper, 30-240 BPM, Serialized Pages, Pre-Loaded on Cartridges, Z-Fold, 17 cart/cs
- 4483AAO Fetal Chart Paper, Light Red Grid, 30-240 BPM, Serialized Pages, 350 sheets/rl, 6 rl/cs
- 4483BAO Fetal Chart Paper, Light Red Grid, 50-210 BPM, Serialized Pages, 350 sheets/rl, 6 rl/cs
- 4528AAO NST Patient Record Forms, For Recording From GE Corometrics Fetal Monitor Model 140, Compatible w/4482AAO recording paper, 300/cs
- 4528BAO Antepartum NST Patient Record Forms, For Recording From GE Corometrics Fetal Monitors Models 145 & 155, Compatible w/4483AAO & 4483BAO recording paper, 150/cs
- 4914AAO Chart Guard Label Packer For Model 115, 116, 118, 170, 150, 151, 120 Series Fetal Monitor Recordings, 200/cs
- 5231AAO Fetal Chart Paper, Red Grid, Serialized Pages, Z-Fold, 20 pk/cs
- 9801-012 Hewlett-Packard Fetal Chart Paper Equivalent M1910A, 2 Fetal Channels, Red Grid, Black Trace, 5.97" x 3.81", Z-Fold, 40 pk/cs
- 9801-058 Hewlett-Packard Fetal Chart Paper Equivalent M1910A, 2 Fetal Channels, Red Grid, Black Trace, 5.96" x 46 ft, Z-Fold, 40 pk/cs

P301008 P301105

PRO ADVANTAGE ULTRASOUND TRANSMISSION GEL

Thick, no-slip formula eliminates air between the transducer and skin offering exceptional coupling efficiency for more effective treatment and diagnosis. Formulated to be acoustically correct for the broad range of frequencies used in medical ultrasound applications. Non-irritating hypoallergenic formula will not sting or chafe patient tissue. Description Salt-free and formaldehyde-free. Water soluble formula prevents damage to equipment or clothing.

- P301008 8 oz. bottle w/ flip cap , 12/CS
- P301105 5 liter collapsible container w/empty bottle , 4/CS



PARKER LABS AQUASONIC® 100 ULTRASOUND TRANSMISSION GEL

The most widely used gel for diagnostic and therapeutic medical ultrasound. Recommended for all procedures where a viscous gel is required. Completely aqueous, will not stain clothing or damage transducers. Hypoallergenic, bacteriostatic, non-sensitizing and non-irritating. No formaldehyde. Not a spermicide.

- 01-02 Ultrasound Transmission Gel, Non-Sterile, 60g Doppler® Size Tube, 12/bx, 12 dz/cs
- 01-08 Ultrasound Transmission Gel, Non-Sterile, 0.25 Liter Bottle, 6 dz/cs
- 01-34 Ultrasound Transmission Gel, Non-Sterile, 1 Liter dispenser bottle, 6/bx, 2/cs
- 01-50 Ultrasound Transmission Gel, Non-Sterile, 5 Liter Sonicpac® w/dispenser bottle, 4/cs



PARKER LABS AQUASONIC® CLEAR ULTRASOUND GEL

Based on the same "can't be copied" formula as Aquasonic 100 Ultrasound Transmission Gel, without fragrance or color. Acoustically correct for a broad range of frequencies. Hypoallergenic, non-irritating and bacteriostatic. Water soluble. No formaldehyde. Not a spermicide.

- 03-02 Ultrasound Gel, 60g Doppler® Size Tube, 12/bx, 12 dz/cs
- 03-08 Ultrasound Gel, .25 Liter Bottle, 6 dz/cs
- 03-34 Ultrasound Gel, 1 Liter w/dispenser cap, 6/bx, 2 bx/cs
- 03-50 Ultrasound Gel, 5 Liter SONICPAC® w/disposable bottle, 4/cs
- 03-54 Ultrasound Gel, 5 Liter ECONOPAC w/2 dispensers, 4/cs



PARKER LABS STERILE AQUASONIC® 100 ULTRASOUND TRANSMISSION GEL

Recommended for diagnostic and therapeutic ultrasound applications when sterility is indicated. Overwrapped, sterilized foil pouches. Acoustically correct for the broad range of frequencies used in medical ultrasound. Non-irritating, hypoallergenic. Completely aqueous, will not stain clothing or damage equipment. Not a spermicide.

- 01-01 Ultrasound Transmission Gel, Sterile, 20g Overwrapped Sterilized Foil Pouches, 48/bx, 6 bx/cs



TRIAD ULTRASOUND GEL

Conducts a broad range of frequencies, does not allow air to intrude between the transducer and skin and requires only minimal pressure to make contact. It is water soluble, non-irritating and hypoallergenic. It will not stain skin or clothing.

- 10-9208 8 oz Ultrasound Gel, 12/cs
- 10-9228 Gallon Ultrasound Gel w/dispenser, 4/cs



PARKER LABS ECLIPSE® PROBE COVER

A soft, latex free, disposable probe cover for medical ultrasound probes/transducers, pre-gelled inside with Aquasonic® 100 Ultrasound Transmission Gel. Fits most endocavity ultrasound probes. Non-irritating and non-sensitizing.

- 30-00 Probe Cover, 7.1"L x 2" W (180mm x 52mm), 100/bx, 12 bx/cs
- 38-01 Probe Cover, 2.5"/1.75"W x 9.5"L (64mm/44mm x 241 mm), 100/bx, 6 bx/cs



PARKER LABS TRANSEPTIC® CLEANSING SOLUTION

Multi-purpose spray for professional use in cleansing ultrasound transducer/probe surfaces between procedures. Will not cause transducer membrane swelling. Does not contain phenol or glutaraldehyde.

- 09-25 Cleansing Solution, 250ml (8.5 fl oz) Clear Spray Bottle, 12/bx, 4 bx/cs

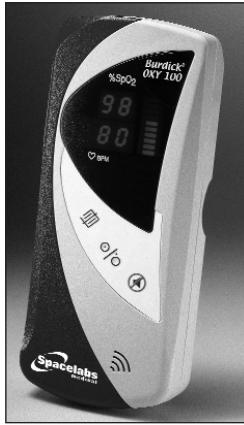

BURDICK OXY 100 PULSE OXIMETER BY CARDIAC SCIENCE

Fast, accurate SpO₂ levels whenever and wherever needed. Displays SpO₂ level, pulse rate and pulse strength on an easy to read LED screen. Uses 3 "C" cell batteries and automatically switches off when not in use. Compact, portable and durable. Up to 99 individual tests can be stored for printout using the optional printer.

92521-1A Burdick Oxy 100 w/finger sensor



COVIDIEN/RESPIRATORY & MONITORING N20 SERIES HANDHELD PULSE OXIMETERS

Rugged, durable construction with protective boot. 32 to 37 hours long battery life. Easy-to-see day/night display. Three-year warranty. Comes with four C alkaline batteries, a finger clip sensor, a sensor extension cable, protective boot and moisture-resistant jacket. All models have a constant-pitch beep tone that sounds with each detected pulse. Displays oxygen saturation, pulse rate, vertical bar graph pulse amplitude indicator/battery meter, pulse search indicator, low battery indicator.

N20PA N-20PA Handheld Pulse Oximeter, Includes: 4-C Size Batteries, 1-Finger-Clip Sensor (DS-1000A), DEC-4 Sensor Extension Cable, Integral Thermal Printer w/12 rolls paper (901624), Protective Boot (024605), Moisture-Resistant Jacket & Manual Pulse Oximeter w/continuous operation, Printer & Alarms (Vet Only)

N20PAV

Accessories

024605 Protective Boot, N-20P Series
 024607 Soft Carrying Case for N-20 Series Pulse Oximeters
 029043 Dual Soft Carrying Case for Pulse Oximeters
 901624 Printer Paper, 12 rolls/box



D20



D25



I20



N25

COVIDIEN/RESPIRATORY & MONITORING OXIMAX®/OXISENSOR® II ADHESIVE SENSORS

D20 Oxisensor II Sensor, Pediatric, 24/cs
 D25 Oxisensor II Sensor, Adult, 24/cs
 D25L Oxisensor II Adult Sensor w/36" cable, 24/cs
 I20 Oxisensor II Sensor, Infant, 24/cs
 MAXA Oximax Sensor, Adult, 24/cs
 MAXFAST Oximax Sensor, Adult Forehead, 24/cs
 MAXI Oximax Sensor, Infant, 24/cs
 MAXN Oximax Sensor, Neonate/Adult, 24/cs
 MAXP Oximax Sensor, Pediatric, 24/cs
 N25 Oxisensor II Sensor, Neonate Adult, 24/cs
 R15 Oxisensor II Sensor, Adult Nasal, 24/cs

Accessories

DEC4 Oximax 4 ft Extension Cable, 1/bx
 DEC8 OxiMax 8 ft Sensor Extension Cable, 1/bx
 DOC10 Oximax 10 ft Sensor/Patient Cable

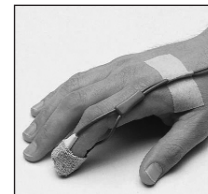

D-YS



DS100A-1

COVIDIEN/RESPIRATORY & MONITORING REUSABLE SENSORS

For spot checks or short-term monitoring. Non-sterile and easy-to-use design. Built-in shielding protects signal from electronic noise. High quality LEDs maximize tracking capabilities. Sensor head design optimizes signal and shields detector from ambient light.

D-YS Dura-Y Multisite Sensor, 1/bx
 D-YSE Dura-Y Ear clip For Use with the Dura-Y Sensor
 D-YSPD Pedi Check Pediatric Spot-Check Clip for the Dura-y Sensor, 1/bg
 DS100A-1 DuraSensor Adult Finger Clip Sensor, 1/bx
 I OxiCliq Sensor, Infant, 24/cs
 N OxiCliq Sensor, Neonatal/Adult, 24/cs
 OXI-A/N Oxiband Adult/Neonatal Sensor, 1/bx
 OXI-P/I Oxiband Pediatric/Infant Sensor, 1/bx
 P OxiCliq Sensor, Pediatric, 24/cs
 PDSLVS Pedi Check Replacement Sleeve
 RS10 Reflectance Sensor, 6/cs
 V-SAT Veterinary Sensor
 VSC-L Veterinary Sensor Clip, Large
 VSC-S Veterinary Sensor Clip, Small

Accessories

ADH-A/N Adhesive Wrap for Reusable Sensors, Adult/Neonatal, 100/bx
 ADH-P/I Adhesive Wrap for Reusable Sensors, Pediatric Infant, 100/bx
 FOAM A/N Foam Wrap for Reusable Sensors, Adult/Neonatal, 12/pk
 FOAM P/I Foam Wrap for Reusable Sensors, Pediatric/Infant, 100/bx
 OC-3 OxiCliq Sensor Cable, 3 ft, 1/bx
 POSEY Velcro Wrap for Reusable Sensors, 12/pk

Pulse Oximeters

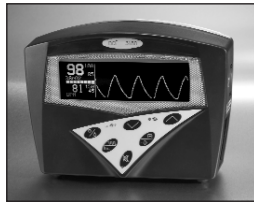

BCI 3180 PULSE OXIMETER

Provides an exceptional value for everyday oximetry needs. This compact, stand-alone monitor delivers fast, reliable SpO₂, pulse rate and pulse strength measurements, complete with a plethysmographic waveform and up to 30 hours of on-screen trending. Plus, the bright liquid crystal display, easy-to-use menu and audible and visible alarms enhance clinical efficiency and quality of care for patients ranging from neonate to adult.

3180 3180 Pulse Oximeter

BCI AUTOCORR™ DIGITAL PULSE OXIMETER

Uses refined noise-reducing hardware and a unique patented software algorithm. Instead of relying on a voltage threshold to determine a pulse, it analyzes a digitized signal at a rate of 120 times per second, and compares it to previous pulse data. These pulses are constantly stored and updated, and used as dynamic templates to determine the validity or invalidity for newly-encountered pulsatile signals. Patented Serial Autocorrelation (SAC) technology provides reliable monitoring.

3304 Autocorr® Pulse Oximeter
 3304LS Autocorr® Pulse Oximeter w/loud alarms
 3404-000 Autocorr® Plus SpO₂ Pulse Oximeter
 3404-001 Autocorr® Plus SpO₂ Pulse Oximeter/ECG/Respiration



BCI DIGIT™ FINGER OXIMETER

Combines monitor and sensor into one unit that provides fast, reliable SpO₂, pulse rate, and pulse strength measurements on patients from pediatric to adult. Ideal for use within emergency settings, in hospital or clinical environments, or for home use. Portable, lightweight pocket-size monitor. One-button keypad. Large LED display. Pulse-strength display bar indicates relative perfusion at the measurement site. Auto power shutdown after 8 seconds. Low battery indicator flashes when 30 minutes of battery time remains.

3420Y Finger Oximeter, Yellow



BCI FINGERPRINT® HAND-HELD PULSE OXIMETER

Portable pulse oximetry monitoring system with built-in printer includes: 3401 Monitor (with 3 rolls of paper); 1884 Operation Manual; 3418 Protective Rubber Boot; 3044 Oximetry Finger Sensor; (4) Alkaline AA Cell Batteries.

3401-000 FingerPrint® Hand-Held Pulse Oximeter
 3403-000 FingerPrint® Sleep Hand-Held Pulse Oximeter/Summary Printer



BCI 3301 HAND-HELD PULSE OXIMETER

Portable pulse oximetry monitoring system includes: 3301 Monitor; 1818 Operation/Service Manual; (3) Alkaline C Cell Batteries.

3301 Hand-Held Pulse Oximeter, with Oximetry Finger Sensor



BCI 3303 HAND-HELD PULSE OXIMETER WITH ALARMS

Portable continuous or spot check pulse oximetry monitoring system with alarms and internal rechargeable battery includes: 3303 Monitor; 3311 Oximetry Cable, 5 ft; 3044 Oximetry Finger Sensor; 1850 Clinician's Operation Manual; 1854 Home-Use instruction Book; 8210 AC Charger, 105-125V 60Hz; 3353 Protective Rubber Boot with Carrying Strap and Tilt Stand.

3303 Hand-Held Pulse Oximeter w/alarms



BCI MINICORR DIGITAL HAND-HELD PULSE OXIMETER

Designed to provide fast, reliable measurements on challenging patients. The device rejects spontaneous motion and other artifacts. Informs the operator of excess artifacts and improper sensor positioning and processes low perfusion signals. Designed for spot-checking or bedside monitoring. This portable unit is ideal for use in home care and clinical environments, as well as during sleep screening. Easy to use, 5-key operation. Infrared link to printer. Battery or charger. Boot is available. System includes 3402 Monitor; 3311 Oximetry Cable, 5 ft.; 3044 Oximetry Finger Sensor; 1896 Operation Manual.

3402 MiniCorr Digital Hand-Held Pulse Oximeter

BCI PULSE OXIMETER ACCESSORIES

1101A	Adult Divided CO ₂ /O ₂ Nasal Cannula {E4707} (8200, 8400, 8401, 9004, & 9200), 10/pkg
1102	Pediatric O ₂ Nasal Cannula + Sample Line (8200, 8400, 8401, 9004, & 9200), 10/pkg
1102P	Pediatric Divided CO ₂ /O ₂ Nasal Cannula {E4707} (8200, 8400, 8401, 9004, & 9200), 10/pkg
1105	Airway Adapter, Straight w/filter (8400), 10/pkg
1121	Adult Oral/Nasal CO ₂ Cannula + Sample Line (8200, 8400), 10/pkg
1123	Adult Oral/Nasal CO ₂ Sample Line (8200, 8400), 10/pkg
1151	Airway Adapter, Pediatric w/o filter (8200, 8400), 10/pkg
1152	Airway Adapter, Pediatric w/filter (8200, 8400), 10/pkg
1178	Moisture Trap (9004), 5/pkg
1179	External CO ₂ Absorber (9004), 2/pkg
1187	Moisture Trap Adapter (1178)
1300	Adult Disposable Oximetry Finger Sensor, 10/bx
1301	Pediatric Disposable Oximetry Finger Sensor, 10/bx
1302	Neonate Disposable Oximetry Finger Sensor, 10/bx
1303	Infant Disposable Oximetry Finger Sensor, 10/bx
1606	Oximeter/ECG Simulator (3303, 8400)
1606HH	Oximeter Simulator & 5 ft Cable (3301, 3301, 3401, 3402)
1611	115V AC Power Supply (3402)
1614	AC Charger, 115V, 60Hz (6004, 9004)
1617	105-125V AC Power Supply (3404, 3408)
1818R	3301 Operation/Service Manual
1850	3303 Clinician Operation Manual
1851	3303 Service Manual
1854	3303 Home-Use Instruction Book
1857	Autocorr [®] Oximeter Clinician Operation Manual (3304)
1858	Autocorr [®] Oximeter Service Manual (3304)
1861	Autocorr [®] Oximeter Home-Use Instruction Book (3304)
1872E	Capnocheck [®] Plus/Capnocheck Sleep Operation Manual (9004)
1873	Capnocheck [®] Plus/Capnocheck Sleep Service Manual (9004)
1876E	Mini-Torr Plus [®] NIBP Monitor Operation Manual (6004)
1877	Mini-Torr Plus [®] NIBP Monitor Service Manual (6004)
1884	3401 FingerPrint [®] Operation Manual
1884SS	FingerPrint [®] Sleep Oximeter Operation Manual (3403)
1884SSHU	FingerPrint [®] Sleep Oximeter Home-Use Instruction Note (3403)
1885	3401 FingerPrint [®] Service Manual
1888	Autocorr [®] Plus Oximeter/ECG Monitor Clinician Operation Manual (3404)
1889	Autocorr [®] Plus Oximeter/ECG Monitor Service Manual (3404)
1892	Graphics Printer Operation Manual (3408)
1893	Graphics Printer Service Manual (3408)
1894	Capnocheck [®] II Monitor Operation Manual (8400)
1895	Capnocheck [®] II Monitor Service Manual (8400)
1896	MiniCorr Pulse Oximeter Operation Manual (3402)
1897	MiniCorr Pulse Oximeter Service Manual (3402)
1898	MiniCorr Pulse Oximeter Home Use Instruction Book (3402)
1900	Digit [®] Operation Manual (3420)
1904	3180 Oximeter Clinician Operation Manual
1905	3180 Oximeter Service Manual
3025	Infant Oximetry Wrap Sensor
3026	Neonate Oximetry Wrap Sensor
3043	Universal "Y" Oximetry Sensor
3044	Standard Oximetry Finger Sensor
3049	Adhesive Strip Tape, 40/pkg
3106	ECG Shielded Safety Type Cable, 3-Lead (3404, 9100, 9200)
3107	ECG Shielded Leads, 40", Safety Type Wires, 3-Lead (3404, 9100, 9200), 3/pkg
3134	Neonate Attachment Tape, 50/pkg
3135	Infant Attachment Tape, 50/pkg
3136	Neonate Attachment Tape, 100/pkg
3137	Infant Attachment Tape, 100/pkg
3178	Pediatric Finger Sensor
3311	Oximetry Cable, 5 ft (3301, 3303, 3401, 3402, 8400)
3311L	Oximetry Extension Cable, 15 ft (3403, 9004-051)
3315	3301 Carrying Case w/belt clip/shoulder strap, No Logo

BCI PULSE OXIMETER ACCESSORIES (Continued)

3318	3301 Protective Rubber Boot w/carrying strap
3322	3303 Carrying Case w/belt clip/shoulder strap
3339	PC Adapter Cable (3301, 3303, 3401, 3402, 8200)
3351	Analog Output Adapter (3304)
3352NC	Digital Output Adapter (Nurse Call - Closed Circuit) (3304, 3404)
3352NO	Digital Output Adapter (Nurse Call - Open Circuit) (3304, 3404)
3354	Pole Mount Bracket (3303, 3402, & 8200)
3361	Printer Interface Cable (3304)
3362	PC Interface (3304/3404)/Graphics Printer Interface (6004)
3365	Printer Interface Cable (9004)
3366	PC Interface (9004)/Graphics Printer Interface (9004)
3369	Clarity [®] Series Carrying Case w/shoulder strap (3304, 3404, 6004)
3371	Graphics Printer Interface (3404)
3388	Clarity [®] Series GCX Roll Stand w/mounting bracket, Basket, Handle, & Power Supply Clamp (3304, 3404, 6004, & 9004)
3389	Interface Cable (1621)
3392	Clarity [®] Series MedVed Roll Stand w/mounting bracket, Basket, Handle, & Power Supply Clamp (3304, 3404, 6004, & 9004)
3406	ECG Shielded Safety Type Cable, 5-Lead (3404, 9200)
3407	ECG Shielded Leads, 40" Safety Type Wires, 5-Lead (3404, 9200), 5/pkg
3408	Graphics Printer
3409	Printer Paper (3402, 8400), 4/bx
3410A	DC Power Cable (3404, 3408)
3414	Analog Output Cable (3404)
3415	3401 FingerPrint Carrying Case
3418	3401 FingerPrint Protective Rubber Boot w/carrying strap
3419	MiniCorr Oximeter Protective Rubber Boot w/carrying strap (3402)
3426	Digit [®] Lanyard (3420)
3427	Digit [®] Carrying Case (3420)
3444	Comfort-Clip [®] Oximetry Finger Sensor (3303, 8400)
3445	Sensor, Finger, Comfort-Clip [®] - Compatible with Nellcor [®] Plus Oximeters or Vital Sign Monitor that use Nellcor [®] Plus Oximetry Technology, WILL NOT WITH Oxi-Max [®] Version of Nellcor [®] Oximeters
3446	Sensor, Finger, Comfort-Clip [®] - Compatible with Nonin [®] Pulse Oximeters or Vital Sign Monitor that use that use Nonin [®] Pulse Oximetry Technology
5093	ETCO ₂ Calibration Gas (8200, 8400)
6007	Mini-Torr Plus [®] NIBP Monitor Printer Upgrade Kit (6004)
6008	Mini-Torr Plus [®] NIBP Monitor Oximetry Upgrade Kit (6004)
6012	3401 FingerPrint [®] Printer Paper, 4/pkg
6014	Electronic Thermometry Temperature Probe Covers (6004), 1000/ctn
6015L	Electronic Thermometry Oral Temperature Probe w/9' cable (6004)
6015R	Electronic Thermometry Rectal Temperature Probe w/9' cable (6004)
6016	Electronic Thermometry Calibration Key (6004)
6110	NIBP Cuff Supply Line (Luer-Lock), 10' (may need Transition Supply Line)
6110S	NIBP Cuff Supply Line (Luer-Lock), 5' (may need Transition Supply Line)
6111	Printer Paper (9100, 9200), 4/bx
6120A	Adult (25.3-34.3cm) Non-Disposable NIBP Cuff
6120C	Child (15.8-21.3cm) Non-Disposable NIBP Cuff
6120I	Infant (9.8-13.3cm) Non-Disposable NIBP Cuff
6120LA	Large Adult (32.1-43.4cm) Non-Disposable NIBP Cuff
6120N	Newborn (7.7-10.5cm) Non-Disposable NIBP Cuff
6120SA	Small Adult (20.0-27.0cm) Non-Disposable NIBP Cuff
6120SC	Small Child (12.4-16.8cm) Non-Disposable NIBP Cuff
6121	NIBP Cuff Transition Supply Line, 10'
6121S	NIBP Cuff Transition Supply Line, 5'
6122	10 ft NIBP Cuff Supply Line (Quick Connect)
6122S	5 ft NIBP Cuff Supply Line (Quick Connect)
6123	NIBP Cuff Neonate Transition Supply Line, 5'

Pulse Oximeters

BCI PULSE OXIMETER ACCESSORIES (Continued)

6124	5 ft NIBP Cuff Neonate Supply Line (Quick Connect)
6140	Neonate (3-6cm) Single Use NIBP Cuff, 3/pkg
6141	Neonate (4-8cm) Single Use NIBP Cuff, 3/pkg
6142	Neonate (6-11cm) Single Use NIBP Cuff, 3/pkg
6143	Neonate (7-13cm) Single Use NIBP Cuff, 3/pkg
6144	Neonate (8-15cm) Single Use NIBP Cuff, 3/pkg
6145	Neonate Variety Pack Single Use NIBP Cuff (2 of each size), 10/pkg
8044	8 ft CO2 Sample Line (8200, 8400), 10/pkg
8061	Calibration Gas Flow Regulator w/gauge (8200, 8400)
8208	Gas Manifold Filters (8200, 8400), 10/pkg
8210	AC Charger, 105-125V, 60Hz (3303, 8200)
8211	4 ft CO2 Sample Line (8200, 8400), 10/pkg
8217	Capnocheck Calibration Kit (8200, 8400)
8223	Calibration Adapter (9004)
8403	Battery Eliminator 105-15VAC, 60Hz (8400)
8404	Battery Charger (8400)
8408	Battery 7.4V Lithium-Ion Rechargeable (8400)
8409	Pole Mount Bracket (3303, 3402, 8200, 8400, & 8401)
8411	Laser Printer (Martel MCP8850B (3180, 3402, 8400, & 8401)
8412	Capnocheck® II Monitor Protective Rubber Boot (8400)
8416	Printer Paper (8411 - Martel MCP8850B), 4/bx
9007	Capnocheck® Plus/Capnocheck Sleep Oximetry Upgrade Kit (9004)
9008	Capnocheck® Plus Serial Autocorrelation (SAC) Digital Oximetry Upgrade Kit
9008S	Capnocheck® Sleep Serial Autocorrelation (SAC) Digital Oximetry Upgrade Kit
9014	3 Channel Analog Output Cable (polysomnography) (9004)
9015	4 Channel/Distance Analog Output Cable (polysomnography) (9004)
9047	Capnocheck® Plus Capnograph Filter Upgrade Kit (9004)
9048	External 3.5 Micron Filter (9004), 2/pkg
9189	FiO ₂ Adapter T (9004), 10/pkg
9190	FiO ₂ Sensor (9004)
9191	FiO ₂ Cable (9004)
9193T	Capnocheck® Plus Capnograph FiO ₂ Upgrade Kit (9004)
WW1100	Airway Adapter, Straight w/o filter (8200, 8400), 10/pkg
WW1101	Adult O ₂ Nasal Cannula + Sample Line (8200, 8400), 10/pkg
WW1124	Pediatric Oral/Nasal CO ₂ Sample Line (8200, 8400), 10/pkg
WW1129	Adult Nasal CO ₂ Sample Line (8200, 8400), 10/pkg
WW1130	Pediatric Nasal CO ₂ Sample Line (8200, 8400), 10/pkg
WW1131	Infant Nasal CO ₂ Sample Line (8200, 8400), 10/pkg
WW1140	15 ft Co ₂ Sample Line Extension (8200, 8400), 10/pkg
WW3005	Power Cord (3180, 9100, 9200)
WW3078	Ear Oximetry Probe Sensor
WW3138	Universal "Y" Posey Wrap Cover, 10/pkg
WW3350	Printer Interface Cable
WW3353	3303 Protective Rubber Boot w/carrying strap/tilt stand
WW3356	Clarity® Series IV Pole Bracket (3304, 3404, 6004, 9004)
WW3394	Clarity® Series Wall Mount Bracket (3304, 3404, 6004 & 9004)
WW8030	Airway Adapter, Elbow (8200, 8400, 8401, 9004 & 9200), 10/pkg
WW8214	Patient Attachment Kit: 1100, 8211, 8208 (8200, 8400), 10/pkg
WW8414	Capnocheck® II Capnograph/Oximeter Carrying Case (8400, 8401)

GE MEDICAL NELLCOR DISPOSABLE PULSE OXIMETRY SENSORS (PROBES)

Single patient use reduces potential for cross-contamination. Sensor placement indexes printed on wrap for easy alignment. Latex free.

407705-001	Nellcor OxiSensor Neonatal Disposable Probes, Patient Range
407705-002	Nellcor OxiSensor Infant Disposable Probes, Digital Probe, Patient Range 3-20 KG, 24/cs
407705-003	Nellcor OxiSensor Pediatric Disposable Probes, Digital Probe, Patient Range 10-50 KG, 24/cs
407705-004	Nellcor OxiSensor Adult Disposable Probes, Digital Probe, Patient Range > 30 KG, 24/cs

GE MEDICAL NELLCOR REUSABLE PULSE OXIMETRY SENSORS & CABLES

Hinged shell accommodates a wide range of digits. Soft vinyl padding holds probe in place. Latex free.

2006644-001	12 ft Nellcor Interface Cable OxiSmart
2008773-001	Nellcor Interface Cable, OxiSmart DOC10 Cable
4033CAX	Intermediate Cables For Nellcor Sensors
407705-006	Nellcor DuraSensor Reusable Finger Probe

GE MEDICAL NONIN PULSE OXIMETER SENSORS & CABLES

Latex free.

412926-001	8" Apex S Nonin Pulse Oximetry Interface Cable
412926-002	12" Apex S Nonin Pulse Oximetry Interface Cable
418497-001	8" ApexPro Nonin Pulse Oximetry Interface Cable
420970-001	Reusable Adult Articulated Finger Clip, 36", Patient Range > 30 Kg
420970-004	Reusable Ear Finger Clip, 18", Patient Range > 40 Kg

GE MEDICAL SENSORMEDICS PULSE OXIMETRY PROBES & CABLES

Latex free.

008731	Sensormedics Interconnect Cable
009084	OMNI-Sat Finger Sensor
009120	OMNI-Sat Ear Clip Sensor
009130	Neonatal Sensor, Semi-Disposable
009136	Adult Sensor, Semi-Disposable

**DEVON C1 FINGERTIP PULSE OXIMETER**

Measure SPO₂ (percentage of oxygen saturation in the blood) and pulse rate with accuracy and ease. Widely used in all healthcare facilities, including hospitals, nursing homes, outpatient surgery centers, physicians' offices, emergency and ambulatory situations, as well as inside the home. Key features: FDA and CE approved; lightweight, compact and easy to carry; accurately measures SPO₂ value and pulse rate; auto shut-off after idle for 8 seconds; low voltage indicator; high-quality LED display; 1 year limited warranty.

300C1	Pulse Oximeter, C1 Fingertip w/2 AAA Batteries, Carrying Pouch, Rubber Case, Lanyard & User Manual
-------	--

**DEVON C202 FINGERTIP PULSE OXIMETER**

Measure SPO₂ (percentage of oxygen saturation in the blood) and pulse rate with accuracy and ease. Widely used in all healthcare facilities, including hospitals, nursing homes, outpatient surgery centers, physicians' offices, emergency and ambulatory situations, as well as inside the home. Key features: FDA and CE approved; lightweight, compact and easy to carry; accurately measures SPO₂ value and pulse rate; auto shut-off after idle for 8 seconds; low voltage indicator; high-quality OLED display; multiple display modes; 1 year limited warranty.

300C202	Pulse Oximeter, C202 Fingertip w/2 AAA Batteries, Carrying Pouch, Lanyard & User Manual
---------	---

GE Healthcare

When fast, accurate, portable performance is vital.

Dash® 2500 and CARESCAPE™ V100 Vital Signs Monitors

The rugged, affordable Dash 2500 bedside or mobile monitor sets a standard of excellence for lower-acuity monitoring. Leveraging the same parameters and algorithms of GE's clinically advanced, higher-acuity monitors, the Dash 2500 helps you treat every patient with exceptional quality, speed and precision.

The compact, portable CARESCAPE V100 monitor can go with you from one patient to the next, capturing vital signs quickly and accurately. Wireless connectivity to your EMR creates a seamless patient record wherever care is being delivered.

Visit www.gehealthcare.com for more details.

Connecting hearts and minds.



imagination at work

© 2009 General Electric Company - All rights reserved.
 GE Medical Systems Information Technologies,
 a General Electric company, doing business as GE Healthcare.



DEVON C3 FINGERTIP PULSE OXIMETER

Measure SPO₂ (percentage of oxygen saturation in the blood) and pulse rate with accuracy and ease. Widely used in all healthcare facilities, including hospitals, nursing homes, outpatient surgery centers, physicians' offices, emergency and ambulatory situations, as well as inside the home. Key features: FDA and CE approved; lightweight, compact and easy to carry; accurately measures SPO₂ value and pulse rate; auto shut-off after idle for 8 seconds; low voltage indicator; high-quality OLED display; pulse signal strength indicator; pulse rate tone modulation adjustable brightness; 1 year limited warranty.

300C3 Pulse Oximeter, C3 Fingertip w/2 AAA Batteries, Carrying Pouch, Rubber Case, Lanyard & User Manual



DEVON C5 PEDIATRIC FINGERTIP PULSE OXIMETER

Measure SPO₂ (percentage of oxygen saturation in the blood) and pulse rates of children with accuracy and ease. Widely used in hospitals, pediatricians' offices, emergency and ambulatory situations, as well as inside the home. Key features: FDA and CE approved; lightweight, compact and easy to carry; accurately measures SPO₂ value and pulse rate; auto shut-off after idle for 8 seconds; low voltage indicator; high-quality OLED display; multiple display modes; anti-artifact. 1 year limited warranty.

300C5 Pulse Oximeter, C5 Fingertip w/2 AAA Batteries, Carrying Case, Lanyard & User Manual

Pulse Oximeters



DEVON 300I HANDHELD PULSE OXIMETER

Measure SPO₂ (percentage of oxygen saturation in the blood) and pulse rate with accuracy and ease. It's durable lightweight design and superior performance makes it suitable for use in any healthcare facility including hospitals, outpatient surgery centers, nursing homes, emergency and ambulatory situations, as well as inside the home. Key features: FDA and CE approved; lightweight, compact and easy to carry; accurately measures SPO₂ value and pulse rate; auto shut-off after idle for 8 seconds; low voltage indicator; high-quality OLED display; multiple display modes; 1 year limited warranty.

300I Pulse Oximeter, 300I Handheld w/2 AA Batteries, User Manual, BCI Compatible Adult Finger Sensor



DEVON PC60A FINGERTIP PULSE OXIMETER

Measure SPO₂ (percentage of oxygen saturation in the blood) and pulse rate with accuracy and ease. Widely used in all healthcare facilities, including hospitals, nursing homes, outpatient surgery centers, physicians' offices, emergency and ambulatory situations, as well as inside the home. Key features: FDA and CE approved; lightweight, compact and easy to carry; accurately measures SPO₂ value and pulse rate; auto shut-off after idle for 8 seconds; low voltage indicator; high-quality LCD display.

PC-60A Pulse Oximeter, PC60A Fingertip w/2 AAA Batteries, Lanyard, User Manual, Carrying Pouch & Quality Certificate



DEVON PC60C FINGERTIP PULSE OXIMETER

Measure SPO₂ (percentage of oxygen saturation in the blood), pulse rate, and Perfusion Index with accuracy and ease. Widely used in all healthcare facilities, including hospitals, nursing homes, outpatient surgery centers, physicians' offices, emergency and ambulatory situations, as well as inside the home. Key features: FDA and CE approved; lightweight, compact and easy to carry; accurately measures SPO₂ value and pulse rate; and PI%; auto on and auto shut-off after idle for 8 seconds; low voltage indicator; high-quality OLED multi-color display; multiple display modes; audio and visual alarm functions; measures perfusion index.

PC-60C Pulse Oximeter, PC60C Fingertip w/2 AAA Batteries, Lanyard, Carrying Pouch & User Manual



DEVON PC60D PEDIATRIC FINGERTIP PULSE OXIMETER

Measure SPO₂ (percentage of oxygen saturation in the blood) and pulse rates of children with accuracy and ease. Widely used in hospitals, pediatricians' offices, emergency and ambulatory situations, as well as inside the home. Key features: FDA and CE approved; lightweight, compact and easy to carry; accurately measures SPO₂ value and pulse rate; auto on and auto shut-off after idle for 8 seconds; low voltage indicator; high-quality OLED multi-color display; audio and visual alarm functions; measures perfusion index. 1 year limited warranty.

PC-60D Pulse Oximeter, PC60D Pediatric Fingertip w/2 Rechargeable Lithium Batteries, Lanyard, Battery Charger, Power Adapter, Charger Cable, Carrying Pouch, User Manual & Quality Certificate



DEVON PC60E ADULT/PEDIATRIC PULSE OXIMETER

Measure SPO₂ (percentage of oxygen saturation in the blood) and pulse rate with accuracy and ease. Widely used in all healthcare facilities, including hospitals, nursing homes, outpatient surgery centers, physicians' offices, emergency and ambulatory situations, as well as inside the home. Key features: FDA and CE approved; lightweight, compact and easy to carry; auto on and auto shut-off after idle for 8 seconds; low voltage indicator; audio and visual alarms, high-quality color OLED display; automatic 180° display change by built in orientation sensor; includes external pediatric SPO₂ probe; 1 year limited warranty.

PC-60E Pulse Oximeter, PC60E Fingertip, Adult & Pediatric w/2 AAA Batteries, External Pediatric Probe, Lanyard, Carrying Pouch, User Manual & Quality Certificate



DEVON PC66/PC66C HANDHELD PULSE OXIMETER

Measure SPO₂ (percentage of oxygen saturation in the blood) and pulse rate with accuracy and ease. Widely used in hospitals, pediatricians' offices, emergency and ambulatory situations, as well as inside the home. Also available for pediatric and infant use with addition probes. Key features: FDA and CE approved; lightweight, compact and easy to carry; accurately measures SPO₂ value, pulse rate and perfusion index; LCD display; stores up to 70 hours of continuous SPO₂ and pulse rate readings; recalls previous SPO₂ measurements and pulse rate readings in real-time; audio and visual alarms; manual power on/off features. Adjustable alarm based on desired SpO₂ and Pulse rate level. 1 year limited warranty.

PC-66 Pulse Oximeter, PC66 Handheld w/3 AA Batteries, User Manual, Stand, Extension Cable & Adult Probe
PC-66C Pulse Oximeter, PC66C Handheld Combo w/3 AA Batteries, User Manual, Stand, Extension Cable, Adult Probe, Pediatric Probe & Infant Probe

Into the EMR. In a heartbeat.

ECG-to-EMR Connectivity Solutions

EMR Gateway seamlessly transfers a patient's ECG into the EMR using industry-standard formats and protocols. This easy-to-install software utility runs in the background, transmitting ECGs from the acquisition device to your EMR in seconds without user intervention, so they are immediately ready for review.

The CardioSoft™ (CS) Cardiac Testing and Data Management System software transforms your laptop or PC into a sophisticated cardiac data acquisition and analysis system – complete with Marquette® ECG analysis programs. And with full connectivity, you're just a click away from sending ECG data and interpretation to your EMR.

Visit www.gehealthcare.com for more details.

Connecting hearts and minds.



imagination at work

© 2009 General Electric Company – All rights reserved.
 GE Medical Systems Information Technologies,
 a General Electric company, doing business as GE Healthcare.



DEVON PC68B WRIST PULSE OXIMETER

Continuously monitors and records SPO2 (percentage of oxygen saturation in the blood), pulse rate readings, and perfusion index with accuracy and ease. Its durable, lightweight design and superior performance make it suitable for sleep centers, hospitals, nursing homes, in-home use. Key features: FDA and CE approved; continuously monitors and records SPO2 value and pulse rate; allows user to measure SPO2 in intervals of 1/2/4/8; auto power-on; lightweight, compact and easy to carry; measures perfusion index; high-quality OLED multi-color display; audible and visible alarm functions; records up to 72 hours of data; reviews and manages stored data; transmits data to a PC; autoshut-off after idle for 20 seconds; measures and records in power save mode, to extend battery life; date/time settings. 1 year limited warranty.

PC-68B Pulse Oximeter, PC68B Wrist w/2 AAA Batteries, User Manual, Quality Certificate, USB Cable, Data Management Software & Wrist Band

MIDMARK IQECG® DIGITAL ECG

An easy-to-use, 12-lead, digital ECG and software solution that helps you to quickly administer testing and access the patient information you need to make informed cardiac assessments and provide more efficient patient care. Lightweight, portable design, weighing less than 11 oz. Interpret and analyze data for neonate, pediatric, and adult patients. Review and edit ECG results on-screen with free text or customizable quick edit statements. Save time and reduce data entry errors by populating patient information directly from your EHR/EMR software.

4-000-0060 Digital ECG System w/12-lead, Serial Version w/o software
 4-000-0061 Digital ECG System w/12-lead, USB Version w/o software

Accessories

4-100-1200 IQmanager™ Diagnostic Software



MIDMARK IQMARK® DIGITAL ECG

4-000-0005 IQmark® Digital ECG, Serial Version w/o software
 4-000-0057 IQmark® Digital ECG, USB Version w/o software

MIDMARK IQMARK® ECG SUPPLIES

2-100-0205 Disposable ECG EZ-Trodes, 500/bx
 2-100-0206 Disposable ECG EZ-Trodes, 500/bx, 10 bx/cs
 3-047-0001 Universal ECG Clips (3mm, 4mm & Snap)
 3-100-0200 IQmark® Patient Cable, Standard

MIDMARK IQECG ACCESSORIES

3-100-0199 Patient Cable, Blue



BURDICK UNIVERSAL ECG BY CARDIAC SCIENCE

Portable and easy to use. Patient data is instantly and accurately obtained, viewing up to 12 channels. Unlimited data analysis including the ability to reanalyze data if system parameters are modified. Compatible with your favorite off-the-shelf PC, laptop, tablet PC or Compaq iPAQ. Connect with HeartCentrix for bi-directional communications. Download patient demographics and orders, perform tests, and upload test results to your EMR.

92309-01	Burdick Universal ECG Non-Interpretive, AHA, English
92309-02	Burdick Universal ECG Interpretive, AHA, English

BURDICK ECG CARTS BY CARDIAC SCIENCE

Designed to accommodate all Burdick ECG products. Electrocardiographs mount securely to the carts. Their sturdy design makes these carts a functional and attractive addition to the physician office. Shipped fully assembled. Mar-resistant finish.

008008	Cart, Light Duty, For Use w/any Burdick ECG
010-0001-001	Cable Hanger For Atria Carts 010-1639-01 & 010-1728-00
010-1639-01	Standard Duty Atria Cart
010-1728-00	Cart Heavy Duty, Atria

GE MEDICAL CARDIOSOFT ECG NON-INVASIVE MONITOR

Basic ECG resting modality+CAM14 with USB+EMR-AHA. English language manual. 12SL+ECG measurements+full disclosure+ECG hisotry. PDF and auto export. Technical support.

CSF65-AXAGXC-BXXXXX	CardioSoft ECG Monitor w/LAN-Storage to Network
CSF65-AXAGXC-XXXXXX	CardioSoft ECG Monitor

GE MEDICAL CARDIOSMART, CARDIOSYS, MAC CABLES & LEADWIRES

Easy to clean, wipe with damp cloth. Built for durability. Latex free. One year warranty. Coaxial cable reduces potential noise.

22341802	7 ft ECG Cable for CardioSmart, MAC 1000, CardioSys, AHA Uses CAM 14 Leadwires
22341809	10 ft ECG Cable For MAC 1100/1200/1200ST, AHA, Uses CAM 14 Leadwires
38401742	Leadwire Set, Banana/Cardiosmart, 0.156" Banana, AHA, 10/set

Accessories

086063	Operators Manual For EK-10
--------	----------------------------

BURDICK ELITE II INTERPRETIVE ECG BY CARDIAC SCIENCE

Simultaneously acquires 10 seconds of ECG data for all 12 leads. Menu displays guide user through all functions. Stores up to 30 ECGs in memory. Includes 10 lead accessory group and 12.5-V nickel cadmium battery. Compact and portable. A powerful interpretation algorithm based on five clinically significant criteria we well as pediatric analysis and pacemaker enhancement is also available. Internal fax and communication modem.

Accessories

007697	Elite II Factory Installed Fax Option
086136	Elite II Operators Manual
086175	Elite II Service Manual
086245	Elite II ECG Interpretation Criteria, GRI

BURDICK EQUIPMENT CARRYING CASS BY CARDIAC SCIENCE

007039	Soft Shelled Carrying Case For EK-10, Elite & Spirotouch
007160	Soft Shell Carry Case For Eclipse LE/LEI
007771	Soft Shell Carry Case For Eclipse 8, 800, 850

BURDICK ATRIA 3100 ECG BY CARDIAC SCIENCE

Compact yet powerful. Our technology assures high quality and accuracy while giving protocol choices, helping eliminate transcription errors and improving workflow. This ECG offers high quality 12-channel ECG tracings. Ethernet communications included on all models, wireless 802.11g and BlueTooth available. A powerful interpretation algorithm based on five clinically significant criteria, as well as pediatric analysis and pacemaker enhancement, is also available. Connect with HeartCentrix for be-directional communications. Download patient demographics and orders, perform tests and upload test results to your EMR.

A31-1EI01	Burdick Atria 3100 ECG w/interpretation & 50 Storage & Basic Communications
A31-1EK01	Burdick Atria 3100 ECG w/measurements, 50 Storage & Basic Communications
A31-1FI01	Burdick Atria 3100 ECG w/interpretation, 50 Storage & Modem
A31-1FK01	Burdick Atria 3100 ECG w/measurements, 50 Storage & Basic Communications, & Modem
A31-1HI01	Burdick Atria 3100 ECG w/interpretation, 50 Storage & Basic Communications, Modem & 802.11g
A31-1HK01	Burdick Atria 3100 ECG w/measurements, 50 Storage & Basic Communications, Modem & 802.11g
A31-1RI01	Burdick Atria 3100 ECG w/interpretation, 50 Storage & Basic Communications, & 802.11g
A31-1RK01	Burdick Atria 3100 ECG w/measurements, 50 Storage & Basic Communications, & 802.11g

BURDICK ATRIA 3100 & 6100 UPGRADE KITS BY CARDIAC SCIENCE

040-1500-00	Upgrade Kit - Storage for 300 Tests
040-1501-00	Upgrade Kit - Base Communications Plus Bluetooth For Burdick Atria 3100 & 6100
040-1503-00	Upgrade Kit - Base Communications Option For Burdick Atria 3100 & 6100 (wired Ethernet, USB, RS-232, analog out)
040-1504-00	Upgrade Kit - Base Communications Option For Burdick Atria 3100 & 6100 Plus 802.11g
040-1505-00	Upgrade Kit - Interpretation For Burdick Atria 3100 & 6100
A61-1EI01	Burdick Atria 6100 w/interpretation, 150 Storage, & Basic Communications
A61-1EK01	Burdick Atria 6100 w/measurements, 150 Storage, & Basic Communications
A61-1FI01	Burdick Atria 6100 w/interpretation, 150 Storage, Modem, & Basic Communications
A61-1FK01	Burdick Atria 6100 w/measurements, 150 Storage, Modem, & Basic Communications
A61-1HI01	Burdick Atria 6100 w/interpretation, 150 Storage, Modem, Basic Communications, & 802.11g
A61-1HK01	Burdick Atria 6100 w/measurements, 150 Storage, Modem, Basic Communications, & 802.11g
A61-1RI01	Burdick Atria 6100 w/interpretation, 150 Storage, Basic Communications, & 802.11g
A61-1RK01	Burdick Atria 6100 w/measurements, 150 Storage, Basic Communications, & 802.11g

GE Healthcare

Rest assured, there's a MAC to match your need.



MAC® Resting ECG Systems

Whether you need on-the-go portability or a system designed for high-volume ECG environments, GE Healthcare's MAC electrocardiograph systems offer advanced analysis capabilities along with connectivity to your office EMR through CardioSoft™ (CS), EMR Gateway, or MUSE® networking solutions. Our proven Marquette® ECG analysis programs deliver the diagnostic accuracy clinicians have come to rely on. Visit www.gehealthcare.com for more details.

Connecting hearts and minds.



imagination at work



© 2009 General Electric Company – All rights reserved.
GE Medical Systems Information Technologies,
a General Electric company, doing business as GE Healthcare.

BURDICK ECG ACCESSORIES BY CARDIAC SCIENCE

007153	Plastic Cardiogram Mount Inserter
007154	ECG Caliper w/case, For Use w/all ECGs
007157	Adult Limb Plate Sensor, 4 electrodes/pk
007158	Limb Strap For Sensor, Single Hole, 18", Adult
007159	Limb Strap For Sensor, 2 Holes, 16", Adult
007161	Infant Limb Plate Sensor, 4/pk
007162	Limb Strap For Sensor, Infant, Single Hole
007163	Welsh Suction Cup Sensor, Self-Retaining, Adult
007264	Alligator (Veterinary) Adapter Clip
007364	Welsh Suction Cup Sensor, Spring-Clip, Infant
007374	Stress Cable Belt, Black Buckle, 5 ft
007463	Lead Adapter For Snap End
007469	Lead Adapter For Grabber End
007517	Patient Cable, Stress, 10 Lead, Stress, Non-replaceable Leads, AHA, For Use w/Elite, EK-10, E350, E350i, E550, E560, Eclipse LE/Lei
007519	Patient Cable, Stress, Non-replaceable, EK-8, E100, E200, E310, E320, E600
007526	Stress Belt, 4 ft, White, Velcro
007550	Adult Limb Plate Sensor, 4mm, Set of 4
007557	How To Operate The Burdick EK-10
007558	A Guide To Good ECG Technique
007690	Welsh Suction Cup Sensor 4mm, Set of 6
007704	ECG Patient Cable, 10 Lead, AHA, Replaceable Leads, For Use w/Eclipse 4, 400, 8, 800, 850, Plus & Premier, LEII & Atria Systems
007705	ECG Patient Cable, 10 Lead, Resting, Replaceable Leads, AHA, For Use w/EK10, Elite, E350, E350i, E550, E560, Eclipse LE/Lei
007707	Patient Cable, Resting, 10 Lead, Replaceable (IEC), Eclipse 4, 400, 8, 800, 850, Plus
007710	Patient Cable, Three Lead Wires (Replacement Kit) For 007704, 007704, Includes: one 20", one 30", one 40" Lead Wire & 10 Lead Identifiers
007711	Patient Cable, Three Lead Wires (Replacement Kit) For 007706, 007725, Includes: One 20", One 30", One 20" Lead Wire & 10 Lead Identifiers

BURDICK ECG ACCESSORIES BY CARDIAC SCIENCE (Continued)

007725	Patient Cable, 10 Lead, Stress, Replaceable Leads, AHA, Eclipse Connector, For Use w/Eclipse, 8, 800, 850, 850i, Plus, LEII, LEI2
007751	EKS-95 Electronic Patient
007797	Lead Adapter, 0.158" (4mm) diameter to snap end
008003	How To Operate The Burdick Eclipse
012-0700-00	ECG Patient Cable, 10 Lead, AHA, Non-Replaceable Leads, For Use w/EK-10, Elite, E350, E350i, E550, E560, Eclipse LE/Lei
012-0701-00	ECG Patient Cable, 10 Lead, Non-Replaceable Leads, AHA, For Use w/EK-8, E100, E200, E300, E310, E320, E600
012-0702-00	Patient Cable, Resting, 5 Lead, Non-Replaceable, EK10, Elite
012-0844-00	ECG Patient Cable, 10 Lead, AHA, Non-Replaceable Leads For Use w/Eclipse 4, 400, 8, 800, 850, Plus & Premier, LEII & Atria Systems
013-0150-00	30" Replacement Stress Leads, Green and Brown
047246	DC Input Cable (1V to 1mV)
047254	Patient Cable, Twist-Lock Connector For PA-101 Preamp
047262	Power Cord DC 200, Medic-5
086061-01	Electrocardiography: A Better Way Workbook
107067	Welsh Sensor Kit, Infant Plates/Straps & Bulbs
107068	Welsh Sensor Kit, Adult Plates/Straps, Infant Bulbs
107546	4mm Sensor Kit, Adult Plates/Straps, Infant Bulbs
146-0126-00	Replacement Battery for Burdick Atria ECGs
147235	5-Lead Wire Kit For 047236 Cable Only, Snap
860062	Retaining Strap Only For 107155 Set
860403	Bulb Only For Welsh Infant Sensor (007364)
860404	Bulb Only For Welsh Adult Sensor (007163)
862278	Battery Pack For ELITE, EK-10
863696	Battery Pack, 16.8V, 0.7A HR For Burdick Eclipse 850 ECG



GE MEDICAL MAC 1200 STANDARD RESTING ECG

A 12-lead electrocardiograph with a full-size paper, alphanumeric keypad and waveform display. Optional Marquette® 12SL™ ECG analysis program, data storage, and bi-directional data transmission capability. AC line or battery operation from NiCd battery. All models listed include: Printed measurements and starter kit (Silver Mactrode® electrodes, grabber adapters, paper, patient cable, power cord).

MAC1200-AAX-CXX-XXX MAC 1200 'Plus' Interpretive Electrocardiograph w/12SL ECG Analysis Program & Waveform Display

Accessories
901168-001 MAC 1200 Office Cart

GE MEDICAL CARDIOLOGY LEADWIRE ADAPTERS

Latex free. 90 day warranty.

- 38401804 Set Leadwire Adapters Grabber/Banana, 10/set
- 9459-901 Set Adapters Grabber/Banana, 6" Wire, 10/set
- 9490-105 Set Adapter Grey/Black Alligator/Banana Socket, 4mm, 10/set
- 9490-106 Set Adapter Grey/Blue Alligator/Banana Pin, 3mm, 10/set
- 9490-111 Set Adapter Clip Black Alligator/Banana Socket, 4mm, 10/set
- 9490-112 Set Adapter Clip Black Alligator/Banana Pin, 3mm, 10/set
- 9490-114 Set Adapter Clip Black Alligator/Banana Socket, 4mm, 14/set
- 9490-115 Set Adapter Grey/Black Alligator/Banana Socket, 4mm, 14/set
- 9490-210 Set Adapter GE Wide-Mouth Universal Alligator/Banana Socket/Snap, 10/set

GE MEDICAL ECG CABLES & LEADWIRES

- 107230 Leadwire Set, Snap, 3 LD, Gray, 100cm AHA, 3/set
- 107231 Leadwire Set, Grab, 3 LD, Gray, 100cm AHA, 3/set
- 107235 Leadwire Set, Grab, 6 LD, Gray, 100/130cm AHA, 6/set
- 107289 Leadwire Set, Grab, 6 LD, Gray, 100 AHA, 6/set
- 107290 Leadwire Set, Snap, 6 LD, Gray, 100 AHA, 6/set
- 107314 Leadwire Set, Grab, 3 LD, Gray, Pediatric, AHA, 3/set
- 107320 ECG Cable, 6 LD, AHA
- 107326 ECG Cable, 3 LD, AHA
- 107328 Leadwire Set, Snap, 3 LD, AHA, 3/set
- 107331 ECG Cable, 3 LD w/ESU Filter For OR, AHA
- 107333 ECG Cable, 6 LD w/ESU Filter For OR, AHA
- 107384 ECG Cable, 3 LD, Safety, AHA

WELCH ALLYN CP100 & CP200 SERIES ECG UNITS

CP 100 and CP 200 series ECG's include the following accessory items standard: Digital ECG Patient Cable, 10-lead replaceable lead set, AHA; 100 disposable tab electrodes; 10 resting electrode adaptors; 1 pack of paper - 200 sheets; Power cord; Directions of Use Manual Printed; Product Information CD includes Directions for Use, Physician's guide to the MEANS ECG analysis program on CD and Interactive Product Training Guide.

- CP1-1E1 CP100, AHD, D, ENG, US PC - Non-Interpretive 12 Lead Multichannel ECG, Non Graphical Preview Screen, Alphanumeric Keyboard & AHA Patient Cable
- CP1A-1E1 CP100, Interp, AHD, D, ENG, US PC - Interpretive 12 Lead Multichannel ECG, Non Graphical Preview Screen, Alphanumeric Keyboard & AHA Patient Cable
- CP2-1E1 CP200, AHD, D, ENG, US PC - Non-Interpretive 12 Lead Multichannel ECG, ECG Color Preview Screen, Alphanumeric Keyboard & AHA Patient Cable
- CP2A-1E1 CP200, Interp, AHD, D, ENG, US PC - Interpretive 12 Lead Multichannel ECG, ECG Color Preview Screen, Alphanumeric Keyboard & AHA Patient Cable
- CPE-CN-UB-D CER-100 Hand Resting ECG Non-Interpretive Software For PDA
- CPR-UI-UB-D PCR-100 PC Based Resting ECG Interpretive Software
- CPR-UN-UB-D PCR-100 PC Based Resting ECG Non-Interpretive Software

WELCH ALLYN CP200 SERIES ECG COMBO UNITS

Each combo unit includes the following accessory items standard: Digital ECG Patient Cable, 10-lead replaceable lead set, AHA; 100 disposable tab electrodes; 10 resting electrode adaptors; 1 pack of paper - 200 sheets; Power cord; Directions of Use Manual; CD includes Directions for Use, Physician's guide to the MEANS ECG analysis program on CD and interactive Product Training Guide; Serial Spirometer Sensor; 1 pressure tubing; 1 nose clip; 4 disposable flow transducers; 1 - 3L calibration syringe; Spirometry reference chart; Effort acceptability chart; Spirometry quick start instructions.

- CP2AS-1E1 CP200, Interp, Spiro, AHD, D, ENG, US PC - Interpretive 12 Lead Multichannel ECG w/spirometry option, Graphical Color Preview Screen, Alphanumeric Keyboard & AHA Patient Cable
- CP2S-1E1 CP200, Spiro, AHD, D, ENG, US PC - Non-Interpretive 12 Lead Multichannel ECG w/spirometry option, Graphical Color Preview Screen, Alphanumeric Keyboard & AHA Patient Cable

WELCH ALLYN ECG ACCESSORIES

- 08265-0000 ECG Utility Cart
- 100680 Nose Clip, 25/pk
- 25254-0000 Cable Separators, 10/set
- 400293 Digital ECG Patient Cable, 10 Lead w/replaceable leads, AHA, CP100 & CP200
- 401123 10-Lead Replaceable Lead Set, AHA, Pinch Clip, CP100 & CP200, For Use w/400293, 4 Limb Leads & 6 Precordial
- 401129 10-Lead Replaceable Lead Set, AHA, Banana, CP100 & CP200, For Use w/400293, 4 Limb Leads & 6 Precordial
- 401150 CP100 Product Info CD, Includes ECG Directions for Use, Physician Guide to MEANS ECG Analysis Program on CD & Interactive Product Training Guide
- 401151 CP200 Product Info CD, Includes ECG & Spirometry Directions for Use, Physician Guide to MEANS ECG Analysis Program on CD & Interactive Product Training Guide
- 401161 Cable Arm & Shelf Option for CP100 or CP200 Carts
- 401393 CP100 & CP200 Office Cart w/out cable arm/shelf
- 401394 CP100 & CP200 Hospital Cart w/out cable arm/shelf
- 45003-0000 Electrode, Exercise, 50/cs
- 45008-0000 Resting Tab Electrodes, 1000/bx
- 701557 CP200 Directions for Use - Manual
- 701586 Dust Cover for CP100 & CP200
- 703228 CP100 Directions for Use - Manual
- 703337 Effort Acceptability Poster
- 703411 CP200 Directions for Use Manual, Spirometry Option
- 703415 Pressure Tubing, CPWS, CP200, 2m
- 703418 Disposable Flow Xducers, CPWS, CP200, 25/pk
- 703419 Disposable Flow Xducers, CPWS, CP200, 100/pk
- 703480 Syringe, Calibration, 3L, CPWS, CP200, Spiro
- 71038-3000 Spirometry Reference Chart
- 71300-0000 ECG Hookup Wall Chart - English
- 80141-0000 Hospital Grade Power Cable
- 9293-032-60 10-Lead Patient Cable, Resting ECG, AHA CP 10/CP 20
- 9293-032-61 10-Lead Patient Cable, Resting ECG, IEC CP 10/CP 20
- 94016-0000 8.25" x 11" Paper For CP 10 & CP 20, 200 sheets/pk, 5 pk/cs
- 94018-0000 Paper: CP100 & CP200, 200 sheets/pk, 5 pk/cs
- SE-PRO-600 Digital ECG Module
- Accessories**
- 58581-0000 Universal Adapter Clip, 10/pk



NIHON KOHDEN CARDIOFAX V ELECTROCARDIOGRAPH

What you see is truly what you get as the screen display and waveforms are the same size as the internal high-resolution thermal array printout. The display even has a background of grid lines exactly like the recording paper. The most recent five minutes of all 12-lead ECG waveforms are stored in memory. This decreases the chance of losing important data. Averaged waveforms of the latest 5 exams can be compared on the same screen and ECG changes are viewed on a time interval basis. The standard internal memory stores approximately 400 12-lead resting ECGs with the optional flash card, another 2,500 resting ECGs can be stored. Stored data can be transferred to a PC via flash card, LAN, or Wireless LAN interface. The optional QB-903E ECG viewer software resides on the PC and allows the clinician to take additional measurements and modify the interpretation if necessary. The optional PC viewer software allows the clinician to print reports to PDF files that many EMR systems will accept.

- ECG-1550A-S Cardiofax V Electrocardiograph, Includes All Accessories Except For The Cart, Cable Arm & Extended Memory Card
- ECG-1550A-STR Cardiofax V Stress w/o Treadmill, Includes All Accessories Except For The Cart, Cable Arm & Extended Memory Card

BURDICK VISION HOLTER SYSTEM BY CARDIAC SCIENCE

For practices performing routine Holter monitoring, the Burdick Vision Holter System provides a practical diagnostic tool ideal for today's tightly managed health care environment. Highly accurate and easy to use, the system is available in a variety of configurations. 99.95% accurate, data collection for up to 48 hours of three-channel ECG recordings, download full disclosure report in less than two minutes. Windows-based software is easy to learn and easy to use. All our optional HeartCentrix connectivity software for bi-directional communications with your EMR.

- 010-1640-00 Compact Flash Card, 128MB, Use w/Vision 5L Recorder
- V53-1DG Burdick Vision Software w/PC card interface. Vision 5L recorder and English language Single user license
- V53-1EG Burdick Vision Holter System Software w/Card Reader & 2 Burdick Vision 5L Recorders, English Language
- V53-1FG Burdick Vision Holter System Software w/Card Reader & 5 Burdick Vision 5L Recorders, English Language
- V53-1GI Burdick Vision Holter System Software w/Card Reader, Pacemaker Analysis Software, English Language
- V53-1GIJ Burdick Vision Holter System Software w/Card Reader, Heart Rate Variability & Pacemaker Analysis Software, English Language
- V53-1GIJW Burdick Vision Holter System Software w/Card Reader, Heart Rate Variability, Pacemaker Analysis & Research Mode Software, English Language

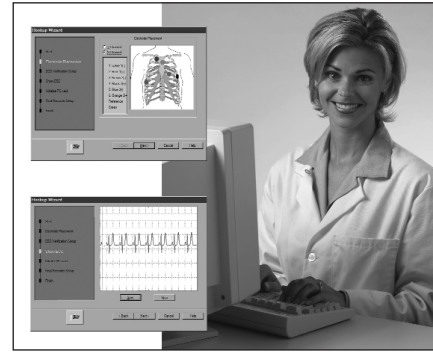

BURDICK VISION PREMIER HOLTER SYSTEM BY CARDIAC SCIENCE

For practices that needs an advanced Holter monitoring solution, the Burdick Vision Premier Holter System provides a powerful diagnostic tool. The Vision Premier adds expanded viewing choices and a more comprehensive list of diagnostic codes to the easy to use software. 99.95% accurate, data collection for up to 48 hours of three-channel ECG recordings. Download full disclosure report in less than two minutes. Windows-based software is easy to learn and easy to use. Add our optional HeartCentrix connectivity software for bi-directional communications with your EMR.

- V51-1DG Burdick Vision Premier Holter System Software w/Card Reader & 1 Burdick Vision 5L Recorder, English Language
- V51-1EG Burdick Vision Premier Holter System Software w/Card Reader & 2 Burdick Vision 5L Recorder, English Language
- V51-1FG Burdick Vision Premier Holter System Software w/Card Reader & 5 Burdick Vision 5L Recorder, English Language
- V51-1G Burdick Vision Premier Holter Software w/card reader, English Language
- V51-1GI Burdick Vision Premier Holter System Software w/Card Reader & Pacemaker Analysis Software, English Language
- V51-1GIJ Burdick Vision Premier Holter System Software w/Card Reader, Pacemaker Analysis Software & Heart Rate Variability Software, English Language
- V51-1GIJV Burdick Vision Premier Holter System Software w/Card Reader, Pacemaker Analysis Software, Heart Rate Variability Software & HL7 Communications, English Language
- V51-1GIJWW Burdick Vision Premier Holter System Software w/Card Reader, Pacemaker Analysis Software, Heart Rate Variability Software, Research Mode Software & HL7 Communications, English Language
- V51-1GIJW Burdick Vision Premier Holter System Software w/Card Reader, Pacemaker Analysis Software, Heart Rate Variability Software & Research Mode Software, English Language
- V51-1GIV Burdick Vision Premier Holter System Software w/Card Reader, Pacemaker Analysis Software & HL7 Communications, English Language
- V51-1GJ Burdick Vision Premier Holter System Software w/Card Reader, Heart Rate Variability Software, English Language
- V53-1G Burdick Vision Holter Software w/card reader, English Language

Ask about our new products.



BURDICK HOLTER MONITORING SYSTEM ACCESSORIES BY CARDIAC SCIENCE

- 012-0439-00 5-Lead Bonded Cable/Lead Set For 90205 & 90208
- 012-0440-00 7-Lead Bonded Cable/Lead Set For 90205 & 90208
- 016-5066-00 Nylon Adjustable Shoulder Strap For 90205 & 90208
- 043092 Test Box For Impedance Check
- 043113 Interface Kit For 6300 Cassette Recorder
- 043139 2 Channel Lead Set, 5 Safety Wires For 92510 (6632) PC Card Recorder
- 043140 3 Channel Lead Set, 7 Safety Wires For 92510 (6632) PC Card Recorder
- 043253 3 Channel Lead Set For Use w/92513 (6732) Compact Digital Recorder
- 043255 2 Channel Lead Set For Use w/92512/3 Holter Recorders
- 086412 SAECG Operators Manual
- 086421 6500 DISC Recorder Operators Manual
- 086487 6600 Series PC Card Recorder Operators Manual
- 086531 Holter Card Operating Instructions
- 086568 Operating Instructions For 6732
- 143207 Interface Kit For 6732 & 6632 PC Card Recorder
- 175-1401-00 Patient Cable For 3 Channel Holter Recording, 30"L, For Use w/92510 Holter Recorder
- 685-0200-00 24- or 48-Hour Compact Flash Card For Digital Recorder
- 92513 For Standard Mode Operations
- 92514-01 Vision 5L Digital Holter Recorder Kit

BURDICK BASELINE HOLTER CASSETTE PREP KIT BY CARDIAC SCIENCE

Each kit contains: 1 Hook-Up Guide, 1 Surgical Prep Razor, 1 Skin Prep Scrub, 3 Alcohol Prep Pads, 12 Stress Loop Tape, 1 60 Minute Audio Cassette, 1 9V Battery, 1 Patient Diary.

- 043084 2 Channel Cassette Prep Kit, w/5 Holter Electrodes, 30/cs
- 043085 3 Channel Cassette Prep Kit, w/7 Holter Electrodes, 30/cs



BURDICK BASELINE HOLTER DISC PREP KIT BY CARDIAC SCIENCE

Each kit contains: 1 Hook-Up Guide, 1 Surgical Prep Razor, 1 Skin Prep Scrub, 3 Alcohol Prep Pads, 12 Stress Loop Tape, 1 Patient Diary, 1 Patient ID Card, 2 9V Batteries.

- 043101 2 Channel 6532 Prep Kit, w/5 Holter Electrodes, 30/cs
- 043104 3 Channel 6532 Prep Kit, w/7 Holter Electrodes, 30/cs

BURDICK HOLTER PATIENT CABLE

010-1642-00 Replacement Cable, 5 Lead, Use w/Vision 5L Recorder

BURDICK PC CARD RECORDER PREP KIT BY CARDIAC SCIENCE

Each kit contains: 1 Surgical Prep Razor, 3 Alcohol Prep Pads, 7 Holter Electrodes, 1 Patient ID Card, 1 Hook-Up Guide, 1 Skin Prep Scrub, 12 Stress Loop Tape, 1 Patient Diary, 4 "AA" Batteries

043202 PC Card Recorder Prep Kit, 30/cs



BURDICK HOLTER PREP KITS BY CARDIAC SCIENCE

Item 043250 Kit contains: 1 Surgical Prep Razor, 3 Alcohol Prep Pads, 5 Holter Electrodes, 1 Patient ID Card, 1 Hook-Up Guide, 1 Skin Prep Scrub, 12 Stress Loop Tape, 1 Patient Diary, 2 "AA" Batteries. Item 043272 Kit contains everything above except it has 7 Holter Electrodes instead of 5.

043250 Holter Prep Kit For 2-Channel Compact Digital Recorder, 30/cs

MIDMARK IQHOLTER™

Small and lightweight, making it easy and comfortable for your patient to wear. The readable, well-lit display and intuitive keypad make clinician navigation and menu control simple. Lightweight and comfortable, weights only 2.8 oz. On-screen leads and channel identification for speed and simplicity during patient hookup. Automatic pacemaker detection eliminates setting changes between patients. Automatic startup self-test with warning alarm ensures reliable recording. 5-lead hookup for 3-channel recording, 7-lead option available. Removable Secure Digital (SD) Card allows for immediate patient turnaround.

- 4-000-0110 IQholder Holter w/recorder w/o software
- 4-000-0113 IQholder EX Holter w/recorder w/o software (Advanced)
- 4-000-0116 IQholder EP Holter w/pacemaker w/o software
- 4-000-0119 IQholder Digital Recorder

Accessories

- 1-370-0010 Secure Digital Memory Card
- 90-30-0205 Calbe, 5-Lead, Blue
- 90-30-0206 Cable, 7-Lead, Blue



MIDMARK IQMARK® ADVANCED HOLTER

- 4-000-0156 IQmark® Advanced Holter® w/recorder w/o software
- 4-000-0157 IQmark® Advanced Holter® w/pacemaker w/o software

cardiofaxS

The World's Smallest
Full-Featured EKG!



- Interpretation
- 3x4+1 Printing
- 12-lead display
- Network-Ready
- Patient Memory
- Industry-leading
4 year warranty



Need 15-Lead or Stress Testing?

With an incredible combination of simultaneous high-end 12-lead, 15-lead, Treadmill and Adenosine Stress, the Cardiofax V meets all your needs in a single device, at half the cost.



A global leader in medical electronics for over 57 years, Nihon Kohden has more than \$1 Billion in annual sales and is the world's second largest supplier of EKG equipment.



NIHON KOHDEN

www.nkekg.com

MIDMARK IQMARK® MANUALS

3-100-1021	IQmark® Digital ECG Manual
3-100-1025	IQmark® Digital Spirometer Manual
3-100-1038	IQmark® Diagnostic Workstation Manual
3-100-1044	IQmark® EZ Holter Manual
3-100-1050	IQmark® Advanced Holter Manual
3-100-1060	IQmark® EZ Stress® Operations Manual

**MIDMARK IQMARK® EZ/ADVANCED HOLTER® SUPPLIES**

1-370-0002	Compact Flash Card
2-100-0060	Lead-Lok Electrodes, 50/bx
2-100-0080	Prep Kit - IQmark® Holter, 5-Lead, 2AAs
2-100-0081	Prep Kit - IQmark® Holter, 5-Lead 2 AAs, 30/cs
2-100-0090	Prep Kit - IQmark® Holter, 7-Lead, 2AAs
2-100-0091	Prep Kit - IQmark® Holter, 7-Lead, 2AAs, 30/cs
3-370-0001	Lead Wire, 5-Lead, IQmark® Digital Recorder CF
3-370-0002	Lead Wire, 7-Lead, IQmark® Digital Recorder CF
3-370-0003	Pouch w/belt for IQmark™ Digital Recorder CF

**MIDMARK IQMARK® EZ HOLTER®**

4-000-0151	IQmark® EZ Holter® w/recorder w/o software
------------	--

MIDMARK IQMARK® DIGITAL RECORDER KIT

Kit includes: IQmark® Digital Recorder, lead wire set, recorder pouch and belt, compact flash card and operation manual.

4-000-0170	IQmark® Digital Recorder Kit For EZ & Advanced Holter®
------------	--

GE MEDICAL CARDIODAY HOLTER SYSTEM KIT

2034411-001	CardioDay Holter System Software & 1 Recorder w/2 channel cable
-------------	---

GE MEDICAL CARDIOMEM RECORDERS

CardioMem offers a genuine data storage without reduction or preanalysis as well as easy and field-proven handling procedures. The integrated graphical display allows an easy and quick check of the electrode application before the recording is started. The recorder features user-friendly, menu-guided operations visible directly on the display. A continuous open-lead monitoring detects bad or detached electrodes and prevents errors during subsequent analysis.

2014606-211	Recorder Kit: 1 Recorder CardioMem300, Pouch & 128mb SD Card
-------------	--

GE MEDICAL HOLTER 12-LEAD AMBULATORY CABLES

Ribbon cable design with strategic electrode snap placement. No need for separate leadwires; one piece design. Cable can be cleaned or disinfected. Lightweight wire can be used on a large cross section of patients. Latex free. 90 day warranty.

421825-001	Cable SEER MC Recorder, 12-Ld Ambulatory, AHA, 36", Includes Electrode Snap Connections
421825-002	Cable SEER MC Recorder, 12-Ld Ambulatory, IEC, 36", Includes Electrode Snap Connections

GE MEDICAL HOLTER 5 & 7 LEAD SNAP-LOCK CABLES & LEADWIRES

Locks leadwires in place to ensure a good connection. Release button allows the leadwires to be removed when depressed. Snap end of leadwire provides secure connection to snap style electrodes. Latex free. 90 day warranty.

409106-001	Cable 8500 Holter, Snap-lock, 5-Ld, DIN, 42"
409106-002	Cable 8500 Holter, Snap-lock, 7-Ld, DIN, 42"
409106-003	Cable SEER Holter, Snap-lock, 5-Ld, DIN, 42"
409106-004	Leadwire Set, 8500/SEER/SEER MC Holter, 5-Ld, 18", 5/set
409106-005	Leadwire Set, 8500/SEER MC Holter, 7-Ld, 18", 7/set
409106-006	Leadwire Set, 8500/SEER/SEER MC Holter, 5-Ld, 24", 5/set
409106-201	Cable 8500 Holter, Snap-lock, 5-Ld, DIN, 15"
419598-005	Cable SEER MC, Snap-lock, 5-Ld, DIN, 42"
419598-007	Cable SEER MC, Snap-lock, 7-Ld, DIN, 42"

GE MEDICAL HOLTER DOWNLOAD CABLES

Download patients data quickly and easily from SEER to Holter scanner. Durable flex cable. Latex free. 90 day warranty.

80784-001	20" Cable Download SEER Recorder
-----------	----------------------------------

GE MEDICAL HOLTER MULTI-LINK 12-LEAD CABLES & LEADWIRES

Shielded leadwires with multi-link connectors. Provides 12-lead monitoring capability. Latex free. One year warranty.

411200-001	Multi-Link Leadwire Set, 5-Ld, Snap, AHA, 29", RA, LA, RL, LL, V, 5/set
411200-003	Multi-Link Leadwire Set, 5-Ld, Snap, IEC, 29", R, L, N, F, C, 5/set
419598-010	Cable SEER MC, Multi-Link, 12-Ld, AHA, 36"
419598-011	Cable SEER MC, Multi-Link, 12-Ld, IEC, 36"

GE MEDICAL HOLTER SUPPLIES

400068-002	Holter Kits 5-Lead Kit Contents: 5 Vinyl Tape Electrodes, 24-Hour Cassette, 9V Battery, 2 Prep Pads & Patient Diary, 24 kits/cs
400068-003	Holter Kits 7-Lead Kit Contents: 7 Vinyl Tape Electrodes, 24-Hour Cassette, 9V Battery, 2 Prep Pads & Patient Diary, 24 kits/cs
400068-004	Holter Kits 7-Lead Kit Contents: 7 Vinyl Tape Electrodes, 48-Hour Cassette, 9V Battery, 2 Prep Pads & Patient Diary, 24 kits/cs
400068-009	Holter Kits 5-Lead Kit Contents: 5 Vinyl Tape Electrodes, 4 AA Batteries, 2 Prep Pads & Patient Diary, 24 kits/cs
400068-016	Holter Kits 5-Lead Kit Contents: 5 Foam Oval Electrodes, 4 AA Batteries, 2 Prep Pads & Patient Diary, 24 kits/cs
400068-021	Holter Kits 5-Lead Kit Contents: 5 Vinyl Tape Electrodes, 48-Hour Cassette, 9V Battery, 2 Prep Pads, Patient Diary & Prep Razor, 24 kits/cs
400068-024	Holter Kits 7-Lead Kit Contents: 7 Vinyl Tape Electrodes, 4 AA Batteries, 2 Prep Pads & Patient Diary, 24 kits/cs
400068-025	Holter Kits 12-Lead Kit Contents: 10 Vinyl Tape Electrodes, 4 AA Batteries, 2 Prep Pads & Patient Diary, 24 kits/cs
57995-002	8500 Holter Recorder Belt For Pouch 57995-005
57995-003	8500 Holter Recorder Shoulder Pouch w/strap
57995-005	8500 Holter Recorder Pouch w/o straps & belt
57995-901	8500 Holter Recorder Pouch w/strap & belt
90026-902	Holter Patient Diary, 50/pk
9435-001	24-Hour Capacity Cassette Tapes, 10/bx
9435-002	48-Hour Capacity Cassette Tapes, 10/bx
9435-003	24-Hour Capacity Cassette Tapes, 20/bx
9435-004	48-Hour Capacity Cassette Tapes, 20/bx

GE MEDICAL HOLTER VALUE LINE CABLES & LEADWIRES

Easy insertion of leadwire into cable. Latex free. 90 day warranty.

2014788-001	Set Leadwire Holter, 5-Ld, DIN, 20", Value Line, 5/set
2014789-001	Set Leadwire Holter, 7-Ld, DIN, 20", Value Line, 7/set
2014790-001	Cable 8500 Holter Recorder, 5-Ld, DIN, 42", Value Line
2014791-001	Cable 8500 Holter Recorder, 7-Ld, DIN, 42", Value Line
2014792-001	Cable SEER Recorder, 5-Ld, DIN, 42", Value Line
2014793-001	Cable 8500 Holter Recorder, 5-Ld, DIN, 15", Value Line
2014794-001	Cable 8500 Holter Recorder, 7-Ld, DIN, 15", Value Line
2014795-001	Cable SEER Recorder, 5-Ld, DIN, 15", Value Line

WELCH ALLYN PHC-100 HOLTER SYSTEM

100710	Office Holter Software Kit, Includes: Office Holter Software, HR-100 Holter Recorder w/carrying case, 7 Lead Patient Cable Replacement HR-100, & USB SD Card Reader
100711	Office Holter Office System Includes: Office Holter Software, HR-100 Holter Recorder, 7 Lead Patient Cable Replacement HR-100, Pentium III PC, 17" Flat Monitor, & Laser Printer

WELCH ALLYN HOLTER ACCESSORIES

08113-0002	3 Channel Holter Hook-Up Kit Includes: 2 - 1.5 Volt AA Batteries, Patient Diary, Razor, Abrading Pad, Alcohol Prep Pads, 7 Disposable Holter Electrodes, & Disposable Pouch Holter Electrodes, 500/cs
45002-0000	
704545	5 Lead Patient Cable, AHA, & HR-100
704547	7 Lead Patient Cable, AHA, & HR-100
704549	7 Lead Patient Cable, AHA, HR-300 & 1200
704551	10 Lead Patient Cable, AHA, & HR-1200
704553	HR-100 Carrying Case, & Straps
704555	USB Bluetooth Adapter

WELCH ALLYN PHC-200 HOLTER SYSTEM

100712	Expert Holter Software Kit Includes: Expert Holter Software, HR-300 Holter Recorder w/Carrying Case, 7 Lead Patient Cable For HR-300, USB SD Card Reader, & USB Bluetooth
100713	Expert Holter System Includes: Expert Holter Software, HR-300 Holter Recorder w/Carrying Case, 7 Lead Patient Cable For HR-300, Pentium III PC, 17" Flat Panel Display, & Laser Printer

WELCH ALLYN CUSTOM HOLTER CONFIGURATIONS

101510	PCH100 Stand-alone Holter Software w/out recorder
101511	PCH100 Lan-3 user Holter Software w/out recorder
101512	PCH200 Stand-alone Holter Software w/o recorder
101513	PCH200 Lan-3 User Holter Software w/out recorder
401700	HR-100 Holter Recorder w/5 Lead Patient Cable, AHA, Carrying Case, Belt, & SD Card
401701	HR-100 Holter Recorder w/ 7 Lead Patient Cable, AHA, Carrying Case, Belt, & SD Card
401704	HR-300 Holter Recorder w/ 7 Lead Patient Cable/Leadwire, Carrying Case, Belt, & SD Card
704529	PCH-100 LAN - 5 Additional Users Licenses
704540	PCH-200 LAN - 5 Additional Users Licenses

WELCH ALLYN HOLTER SYSTEM 2000 ACCESSORIES

08241-0000	Holter Hook-Up Kit, Includes 1.5V AA Batteries, Patient Diary, Razor, Abrading Pad, Alcohol Prep Pads, 5 Disp. Holter Electrodes
80188-0000	Patient Cable, Short, MT-100
80189-0000	Fiber Optic Transfer Cable, MT-200



BURDICK QUEST® EXERCISE STRESS SYSTEM BY CARDIAC SCIENCE

Features easy, intuitive touch screen. Lets you focus on the patient. Performs both resting 12-lead ECGs and stress tests on one system. Accurate ECG data acquired at the patient eliminating non-cardiac electrical noise. Flexible programming means you choose the protocol. Generous storage, enhanced online data editing and several data management options. Full-range reporting offers over 15 different report configurations. Optional treadmill not included. See TM55 or TM65. Optional T-Wave Alternans helps predict Sudden Cardiac Death (SCD). Add our optional HeartCentrix connectivity software for bi-directional communications with your EMR.

B24-1ALMP	Exercise Stress System Quest, English Language w/resting ECG, Aha Accessories Kit & Communications (XML, HL7 & PDF) Options, 120V
B24-1AP	Burdick Quest System w/o treadmill. Includes standard US Thermal Paper and AHA Patient Cable, English Language (120V)
B24-1AP01	Burdick Quest Exercise Stress System, English Language w/AHA accessories kit and TM55 Treadmill
B24-1APM01	Burdick Quest Exercise stress system, English language, with AHA accessories kit, TM55 treadmill and network communications option (120V)

Accessories

004219	Patient Data Acquisition Cable
007772	Patient Module
214-1022-01	Belt & Pouch w/quick buckle for Quest
214-1023-00	Belt Extender w/quick buckle for Quest

BURDICK QUINTON Q-STRESS® EXERCISE STRESS SYSTEM BY CARDIAC SCIENCE

Q-Stress now in its ninth generation was designed to provide superior clinical data while meeting your procedural needs. Start by importing your patients' demographics. It will streamline your work, eliminate unnecessary keying, and minimize documentation errors and mishandled billing. Run our proprietary algorithm, baseline wander, and motion artifact filters for better ECG tracings with less noise. Display 3-, 6-, or 12-leads of data and easily view, print, save, or email in-tests or final reports. Be confident knowing the system alerts you to significant ECG changes. It updates analyses and displays anomalies, including ST anomalies and ectopic beats. Append significant data to the final report or export the complete full disclosure to your electronic medical record (EMR) systems. Configured with our TM55 or TM65 treadmill, you'll be full equipped for to performance. Our medical treadmills have been the industry's gold standard for more than three decades and are among the test selling in the world.

037225-001	Patient Cable Pouch For Q-Stress
60-00180-01	Patient Cable For Q-Stress or HeartStride, AHA 25" Leadwires w/pinch connection
60-00181-01	Patient Cable For Q-Stress or HeartStride, AHA 25" Leadwires w/snap connection
60-00184-01	Patient Cable For Q-Stress or HeartStride, AHA 43" Leadwires w/pinch connection
60-00185-01	Patient Cable For Q-Stress or HeartStride, AHA 43" Leadwires w/snap connection
Q40-1AEKM	Exercise Stress System Q-Stress w/Networking & Thermal Printer, English Language, 120V, AHA Patient Cable
Q40-1AEKM01	Exercise Stress System Q-Stress w/Networking, Thermal Printer & TM55 Treadmill, English Language, 120V, AHA Patient Cable
Q40-1AELM01	Exercise Stress System Q-Stress w/Networking, Freeze Frame, Thermal Printer & TM55 Treadmill, English Language, 120V, AHA Patient Cable
Q40-1AELNM01	Exercise Stress System Featuring Networking, Freeze Frame, Risk Scoring Thermal Printer & TM55 Treadmill
Q40-1AELNP01	Exercise Stress System Featuring Networking, Freeze Frame, Risk Scoring Laser Printer & TM55 Treadmill
Q40-1AFDM01	Exercise Stress System Advanced Q-Stress w/Networking, Advanced Software Options Kit (including full disclosure, re-analysis, freeze frame & risk scoring), Thermal Printer & TM55 Treadmill, English Language, 120V, AHA Patient Cable
Q40-1AFDP	Advanced Exercise Stress System Featuring Networking, Q-Exchange, Advanced Software Options Kit (Including Full Disclosure, Re-analysis, Freeze Frame & Risk Scoring) & Laser Printer
Q40-1AFDP01	Advanced Exercise Stress System Featuring Networking, Q-Exchange, Advanced Software Options Kit (Including Full Disclosure, Re-analysis, Freeze Frame & Risk Scoring), Laser Printer & TM55 Treadmill
Q40-1AFKP	Basic Exercise Stress System Featuring Networking, Q-Exchange, Laser Printer
Q40-1AFLM01	Exercise Stress System Featuring Networking, Q-Exchange, Freeze Frame, Thermal Printer & TM55 Treadmill
Q40-1AFNM01	Exercise Stress System Featuring Networking, Q-Exchange, Risk Scoring, Thermal Printer & TM55 Treadmill
Q40-1AGKM01	Exercise Stress System Q-Stress w/Thermal Printer & TM55 Treadmill, English Language, 120V, AHA Patient Cable

BURDICK TM55 AND TM65 TREADMILLS BY CARDIAC SCIENCE

Thousands of clinicians worldwide rely on the TM55 and TM65 to deliver the accuracy and reliability required for exercise stress tests. Proven design maximizes system reliability. Controlled "soft start" for patient safety. Digitally controlled AC-drive system provides high torque for accurate speed and grade, regardless of weight. Quiet Operation through entire speed range calms patients and eliminates office disruption. Fully integrated into the Burdick Quest & Quinton Q-Stress exercise stress system.

TM55HEXRCE	Treadmill, TM55 w/E-Stop, Rapid Deceleration, High Voltage
TM55LEXCE	Treadmill, TM55 w/E-Stop, Low Voltage
TM55LXXRCE	Treadmill, TM55 w/rapid deceleration, low voltage
TM55LXXCE	Treadmill, TM55 w/low voltage
TM65HEXRCE	Treadmill, TM65 w/E-Stop, Rapid Deceleration, High Voltage
TM65LEXCE	Treadmill, TM65 w/E-Stop, Low Voltage
TM65LXXRCE	Treadmill, TM65 w/rapid deceleration, Low Voltage
TM65LXXCE	Treadmill, TM65, Low Voltage

Accessories

037080-001	Emergency Stop Option For TM55 & TM65
------------	---------------------------------------

BURDICK HEARTSTRIDE EXERCISE STRESS SYSTEM BY CARDIAC SCIENCE

Enjoy the HeartStride's simple graphical user interface while knowing you have access to enhanced clinical features and optional connectivity capabilities. Change testing protocols with a simple mouse click. Use the full range of in-test and final report configurations to document exactly what you want. Save time with the QuickList feature that provides conventional words or phrases for final report preparation. Easily connect the HeartStride to your echo or nuclear system, selecting the output channel you want. Store virtually unlimited data and reports on the hard drive or export information to your EMR. Add our optional HeartCentrix connectivity software for bi-directional communications with your EMR.

70-00282-01	Manual, User & Service, Provides Easy Instruction On Operation of New Stress System, Service Manual is For Troubleshooting Issues
H4-1AEPT01	Exercise Stress System, Features High Performance ECG, Package Includes: AHA Patient Cable Accessories Kit, Networking Capabilities, Laser Printer, Cart & TM55 Treadmill
H4-1AFPT01	Exercise Stress System, Features High Performance ECG, Package Includes: AHA Patient Cable Accessories Kit, Networking Capabilities, Q-Exchange, Laser Printer, Cart & TM55 Treadmill
H4-1AKPT	Exercise Stress System, Features High Performance ECG, Package Includes: AHA Patient Cable Accessories Kit, Laser Printer & Cart
H4-1AKPT01	Exercise Stress System, Features High Performance ECG, Package Includes: AHA Patient Cable Accessories Kit, Laser Printer, Cart & TM55 Treadmill
H4S-1AKT	Exercise Stress System, HeartStride Software Only, 120V w/AHA Patient Cables, Cart
H4S-1AKT01	Exercise Stress System, HeartStride Software Only, 120V, AHA Patient Cables, Cart & TM55
H4S-1AKV	Exercise Stress System, HeartStride Software Only, 120V w/AHA Patient Cables
H4S-1AKV01	Exercise Stress System, HeartStride Software Only, 120V w/AHA Patient Cables & TM55 Treadmill

BURDICK BASELINE STRESS PREP KIT BY CARDIAC SCIENCE

Each kit contains: 10 Stress Electrodes, Foam, 1 Skin Scrub, 1 Instruction Sheet, 3 Alcohol Prep Pads, 1 Bacitracin Ointment, 1 Moist Wipe, 1 Surgical Prep Razor.

015-0629-00	Blue Max Stress Prep Kit, 30 kit/cs
097008	Baseline Stress Prep Kit, 30/cs

MIDMARK IQSTRESS™

An easy-to-use system that combines sophisticated cardiac testing with straightforward features. Includes a lightweight, digital ECG, integrated stress analysis software, stress cart and a medical grade treadmill. Everything is just a click away with a user-friendly, one-level menu. Customizable user profiles make procedure setup fast and easy. Quick access to customized test protocols, measurement parameters, display formats and reports. Seven protocols preprogrammed to begin testing immediately, including the Bruce and Modified Bruce. Easily review up to four stress tests for side-by-side comparison of a patient's progress. Correct, ergonomic patient testing orientation. Summarize and review test results with detailed rhythm strips and averaged beats immediately after the test is completed, either locally or from any network. The medical grade treadmill is reliable, quiet and runs smoothly for assured patient comfort.

- 4-000-0332 IQstress w/treadmill & cart
- 4-000-0334 IQstress w/treadmill, cart, computer, printer, UPS

Accessories

- 3-100-0202 Patient Cable, Blue
- 3-370-0010 Pouch & Belt Set



MIDMARK IQMARK® TREADMILL

- 1-050-1000 IQmark® Medical Grade Exercise Stress Treadmill, 220VAC

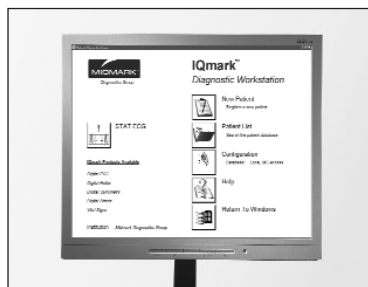

MIDMARK IQMARK® SOFTWARE

- 4-100-1004 IQmark® Diagnostic Workstation Software
- 4-100-1409 IQmark® Data Management System (DMS) Software, CD



2-100-0095



2-100-1202



2-244-0001



3-003-0010



3-047-0005

MIDMARK IQMARK® ACCESSORIES

- 1-136-0005 USB to Serial Port Adapter
- 1-370-0004 USB External Compact Flash Card Reader
- 2-100-0095 Stress Prep Kit, 5/pk
- 2-100-1202 Pneumotach Mouthpieces, Disposable, Bulk, 1000/cs
- 2-100-1400 Stress Pouch w/belt
- 2-244-0001 Nose Clips, Disposables, 25/bx
- 3-003-0010 IQmark Stress® Cart
- 3-047-0005 ECG Clips, Clear (4mm & snap), 10/pk
- 3-100-0500 Patient Cable, Pinch Type, Iqmark

MIDMARK IQMARK® STRESS

- 4-000-0320 IQmark® Stress Output Module Kit



MIDMARK IQMARK® EZ STRESS®

- 4-000-0300 Option Kit
- 4-000-0314 IQmark® EZ Stress® w/ECG w/o software

NIHON KOHDEN TRACKMASTER TREADMILL

- NK-TREADMILL Trackmaster Treadmill

A full line of accessories and supplies are also available from Cardiac Science. Contact your NDC sales representative for more information.



**Burdick
Universal
ECG**

Burdick® Universal ECG by Cardiac Science™

- Full disclosure with end-user reviews and analysis.
- EMR connectivity via HeartCentrix® by Cardiac Science™.

92309-02, AHA, Interpretive



**Burdick Atria
6100 ECG**

Burdick® Atria® 6100 ECG by Cardiac Science™

- Large, full-color preview screen with 3-, 6-, or 12-lead display.
- Includes Ethernet communications.
- EMR connectivity via HeartCentrix® by Cardiac Science™.

A61-1EI01, Interpretive, 150 record storage and basic communications

Also available: Burdick® Atria® 3100 ECG by Cardiac Science™
A31-1EI01, Interpretive, 50 record storage and basic communications

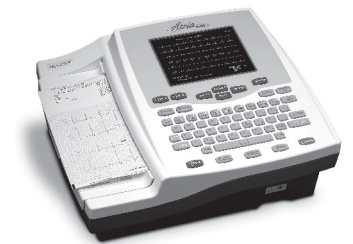

**Burdick Vision™
Holter Analysis
Software
System**

Burdick® Vision™ Holter Analysis Systems by Cardiac Science™

- High-quality ECG digital recording with 99.95% accuracy.
- EMR connectivity via HeartCentrix® by Cardiac Science™.
- Patient-friendly, pocket-sized digital recorder.

V53-1DG, Vision Holter Software with PC-Card interface and one Vision 5L Recorder

V51-1G, Vision Premier Holter Software with PC-Card interface



**Quinton®
Q-Stress®
Cardiac Stress
System**

Quinton® Q-Stress® Cardiac Stress System by Cardiac Science™

- Superior clinical data from the gold standard in physician stress systems.
- EMR connectivity via HeartCentrix® by Cardiac Science™.

Q40-1AFKM01, with networking, Q-Exchange, thermal printer and TM55 treadmill.

Also available: Burdick® HeartStride™ Cardiac Stress System by Cardiac Science™
H4-1AEP01, basic stress systems with AHA accessories and TM 55 treadmill





WELCH ALLYN AED-10 AUTOMATED EXTERNAL DEFIBRILLATOR

Comes with an illuminated defib pad placement illustration on the device front panel, backlit display to provide the user with test prompts - battery status - number of shocks and energy settings, concise voice prompts and CPR timer. Includes the following standard accessory package: (1) non-rechargeable lithium battery (90+ shocks at 360 joules or 5 hours of continuous use), user's manual, quick reference card, defibrillation pads and five-year limited warranty program.

- 970302E AED-10 w/carrying case & standard accessories
- 970308E AED-10 w/lead out pads
- 970311E AED-10 RAPID RESPONSE KIT incl: AED-10 w/new expanded carrying case, 2 AED-10 Lithium Batteries, 2 sets of Defib Pads, 1 Pediatric Energy Reducer, 1 1st Responder Prep Kit, Quick Ref Card, In-Svc Video, and Operator Manual
- WEL 970302E AED-10 w/carrying case & standard accessories

WELCH ALLYN AED AUTOMATED EXTERNAL DEFIBRILLATOR ACCESSORIES

- 00185-2 AED-10 Non-Rechargeable (Lithium) Battery
- 00185-3 AED Defibrillation Pads, 2/pouch
- 001851-U AED Trainer, Adult Pads
- 001855-U JumpStart Adult Defibrillation Pads, 10 pr/bx
- 001857-E Lead Out Pads For AED10 & 20
- 001962-U SmartLink Software Program
- 00211-9 AED-20 Parallel Printer Communications Kit
- 00213-7 AED Quick Response Prep Kit
- 00214-3 AED IR Communication Kit
- 90021-6E Rugged AED-20 Carrying Case w/quick reference instruction placard, storage space for 1 battery & storage pockets for other supplies
- 970205 AED-20 Upgrade ECG to Manual
- 00183-0E AED-20 Non-Rechargeable (Lithium) Battery
- 00213-0 Cable: AED-20 ECG (AHA)
- 981125E PowerStick Battery Charging Station, 1 Bay

WELCH ALLYN PIC™ RESCUER AED/MONITOR/DEFIBRILLATOR ACCESSORIES

- 001647-U SuperPak Rechargeable Battery
- 001726-U 10-Pack Disposable Electrodes, 10 pk/bx
- 001950-U Adult Airway Adapter, 5/bx
- 900323 PIC30 Carrying Case
- 971091 Reliable Integral External Pacing
- 980132 PIC 12V Power Adapter
- 999895 PIC EMS Service Plus Program (per year)
- 001537-U PIC Pediatric Electrode
- 001739-U Chart Plain White Paper, 40mm, 3 rl/bx
- 001790-U Cable: 3-Lead ECG (AHA) 6 ft
- 001795-U PIC 5-Lead Patient Cable
- 001934-U CO2 Sensor Kit
- 560640 PIC Clear Lens Package
- 90021-4 PIC Soft Carrying Case
- 971029-E PIC Paddle Tray
- 971107 PIC Hands Free Adapter, Grey
- 971108-E PIC Deluxe External Paddle Set, Grey

BURDICK POWERHEART AED G3 AUTO DEFIBRILLATOR BY CARDIAC SCIENCE

Clear voice prompts guide the user through the entire process and a text screen provides helpful information. Simplifies the rescue process by eliminating the need to press a shock button. Once the defibrillation pads are attached to the patient, the device detects the person's heart rhythm, analyzes the rhythm using the patented RHYTHMx® software, and if a life-threatening rhythm is detected, instructs the user to stand clear and automatically delivers a defibrillation shock. Patented RescueReady® technology verifies functionality daily. Industry leading 7 year product warranty. 4 year battery warranty.

- 9300A-501PPC AED G3 Auto Pkg Includes: AHA 2005 Guidelines Compliance, 2 pr Adult Electrodes, 1 ea: Quick Start Tool Kit, AED Carry Bag, Ready Kit, Serial Communication Cable, 9146 Battery

BURDICK POWERHEART AED G3 PRO DEFIBRILLATOR BY CARDIAC SCIENCE

Powerheart G3 Pro AED offers the industry's first ECG color display, provides manual override features, multiple rescue capability, and the most advanced technology available to provide healthcare and rescue professionals extended capabilities for emergency treatment of sudden cardiac arrest and continuous cardiac monitoring. Patented RescueReady® technology verifies functionality daily. Industry leading 7 year product warranty.

- 9300P-501PPC AED G3 Pro® Pkg Includes: AHA 2005 Guidelines Compliance, 2 pr Adult Electrodes, 1 ea: Quick Start Tool Kit, AED Carry Bag, Ready Kit, Serial Communication Cable, 9145 Battery

BURDICK POWERHEART AED G3 SEMI-AUTO DEFIBRILLATOR BY CARDIAC SCIENCE

Clear voice prompts guide the user through the entire process and a text screen provides helpful information. Once the defibrillation pads are attached to the patient, the device detects the person's heart rhythm, analyzes the rhythm using the patented RHYTHMx® software, and if a life-threatening rhythm is detected, instructs the user to press the shock button. Patented RescueReady® technology verifies functionality daily. Industry leading 7 year product warranty. 4 year battery warranty.

- 9300E-501PPC AED Package Includes: 2 pair Adult Electrodes, 1 ea: Quick Start Tool Kit, AED Carry Bag, Ready Kit, Serial Communication Cable, 9146 Battery

BURDICK DEFIBRILLATOR ACCESSORIES BY CARDIAC SCIENCE

- 067112 5-Lead Patient Cable For Medic 4 & Medic 5
- 086144 Operators Manual For DC-200
- 086194 Operators Manual For Medic 5

Fast, easy access to the products you need.



ZOLL AED PLUS

The AED Plus is the first and only Full-Rescue AED that helps with both defibrillation and CPR. ZOLL's Real CPR Help® technology provides real-time feedback on both rate and depth of chest compressions during CPR. This ensures that the rescuer is providing the best manual CPR possible during a rescue, giving the victim a better chance of survival. This technology, being the first of its kind, is what makes the AED Plus the only AED that will help make a difference during an SCA rescue.

21000010102011010 AED Plus Defibrillator

ZOLL RECORDER PAPER

8000-0060 40mm, 10r/cs

ZOLL M SERIES BLS AED

High contrast display, 3-lead patient cable with integral lead wires, multiple application printer, manual override, universal cable, one rechargeable lead acid battery, AC mains power cord, RS232 data transfer capabilities, operator's manual, Xtreme Pack II and standard five (5) year warranty for hospital use.

40110011100063011 BLS AED w/AC Power
 40110011100163011 BLS AED w/Noninvasive Pacing
 40110211100163011 BLS w/SPO2 w/reusable sensor & 8 ft cable, Multiple Application Printer, Non-Invasive Pacing, High Contrast, 3-Lead, Pack of Paper, Rechargeable Battery, AC Cord, User CD Manual

ZOLL M SERIES ACLS MANUAL/ADVISORY DEFIBRILLATOR

High contrast display, 3-lead patient cable with integral lead wires, universal cable, one rechargeable lead acid battery, AC mains power cord, one package of recorder paper, integral diagnostic frequency response for 12-lead (requires 5-lead or 1 Step Patient Cable), two PCMCIA card slots, RS232 data transfer capabilities, operator's manual and standard five (5) year warranty for hospital use.

40510011100123010 ACLS w/Noninvasive Pacing
 40521011100123010 ACLS w/printer, 12-Lead & SPO2 w/reusable sensor & 8 ft cable, NIBP, External Pacing, Pack of Paper, Rechargeable Battery, AC Cord, User CD Manual
 40521211100023010 ACLS w/printer, 12-Lead & SPO2 w/reusable sensor & 8 ft cable, Pack of Paper, Rechargeable Battery, AC Cord, User CD Manual
 40610511100123010 ACLS w/NIBP w/adult cuff & hose, SPO2 w/reusable sensor & 8' Cable (ORDER DISPOSABLES SEPERATELY) & Noninvasive Pacing
 40621711100123010 ACLS w/printer, 12-Lead & SPO2 w/reusable sensor & 8 ft cable, NIBP w/adult-plus cuff & hose, AC Power, Code Marker

ZOLL AED PRO DEFIBRILLATORS

AED Pro Semi-auto/Manual includes backlit LCD screen, ECG display, soft carry case, rugged over-molded outer housing, multi-patient internal memory, IrDA port, operators guide, five year factory warranty.

90110200499991010 AED Pro Defibrillator (Electrodes & Battery ordered separately)

A Defibrillator for Every Rescuer...



Look to ZOLL® for your next defibrillator and give your patients yet another reason to put their trust in you and your services. Whether it is a professional device such as the M Series®, or an AED, such as the AED Plus® or AED Pro®, ZOLL has earned the respect of users of all skill levels.

With more than 20 years of experience in defibrillation, ZOLL is a pioneer in resuscitation solutions. ZOLL develops technologies to help advance the practice of resuscitation. With products for pacing, defibrillation, circulation, ventilation, data management, and fluid resuscitation, ZOLL provides a comprehensive set of technologies that can help clinicians and lay rescuers resuscitate sudden cardiac arrest and trauma victims.



ZOLL AED DEFIBRILLATOR ACCESSORIES

0-02181	Wall Bracket, Metal, L-Shaped, White, Use w/AED-20
001516-U	Internal Electrodes, 50mm (2"), 2/set
001794-U	PIC 3-Lead Patient Cable (INTL)
001796-U	PIC 5-Lead Patient Cable (INTL)
001798-U	PIC 3-Lead Patient Cable (AHA) For Use w/12-lead PIC 50
001829-E	AED 20 Rechargeable Battery
001835-U	PIC 3-Lead Patient Cable (AHA) For Use w/12-lead PIC 50
001836-U	Patient Cable, Detachable 6 Leadwire Set (AHA) For 001834, Breakaway 12-Lead (AHA)
001838-U	PIC 4-Lead Patient Cable IEC 12 Pole
001932-U	Sensor Cable, 10 ft, For All Disposable Sensors
001951-U	Disposable Airway Adapter, Adult, 50/bx
001954-U	CO2 Sensor Adapter
001957-U	Invasive Blood Pressure Adapter
001966-E	Nellcor Brand Sensor Adapter Cable
001971-E	Smartlink Wireless Serial Connector Kit
001974-U	Non-Invasive Blood Pressure Cuff Hose, 10 ft Extension To Use w/Welch Allyn Single Hose Blood Pressure Cuffs w/female locking connector
002128-U	AED-20 Single Channel Monitoring ECG Cable
002170-E	AED-20 Serial Communication Kit w/smartlink software program
002174-U	Energy Reducer, Pediatric For Use w/AED 20
1000-0113-01	Replacement Trainer Remote Control
8000-0053	Defibrillation Gel Tube, 12/bx
8000-0301	80mm Fanfold Paper Use Only w/M-Series Defibrillator, 20/cs
8000-0800-01	Simulator/Tester For Functional Testing
8000-0802-01	Replacement Soft Case
8000-0804-01	Universal Simulator Cable
8000-0807-01	Type 123 Lithium Batteries, 10/pk
8000-0808-01	Replacement PASS Cover
8000-0809-01	Wall Mounting Bracket
8000-0811-01	Flush Mount Wall Cabinet
8000-0813-01	Zoll Data Review
8000-0814-01	Recessed Mount Wall Cabinet
8000-0815-01	USB IRDA Adapter
8000-0816-01	RS-232 IRDA Adapter
8000-0817-01	Surface Mount Wall Cabinet
8000-0821	Replacement Trainer Phone Cord
8000-0822	Replacement Trainer AC Adapter
8000-0855	Wall Cabinet w/alarm, Metal
8008-0104-01	AED Trainer w/4 pre-programmed AED scenarios & remote control
810-2484-02	Multilingual User Manual & Inservice CD For AED-20
810-2558-00	PIC Multilingual User Manual & Inservice CD
8900-0800-01	CPR-D Padz w/compression, Use w/AED Plus or AED Pro
8900-0802-01	Electrode, Stat-Padz II HVP, Multi-Function
8900-0803-01	Replacement Adhesive Gels for CPR-D Padz - Training Electrode replacements, 5pair/bx
8900-0804-01	CPR-D Padz Training Electrodes, reusable "z-design" electrode with CPR Hand Placement Indicator and 1 pair of Disposable Adhesive Gels
8900-0805-01	Stat Padz II (reusable for Training)
8900-2055	Adult Multi Function Electrode, 12/cs
8900-2061	Pediatric Multi Function Electrode
8900-2065	Pediatric Multi Function Electrode, 6/cs
8900-4003	HVP Multi Function Electrodes, stat-padz, 24 month shelf life, 12pr/cs
8900-4004	Stat-padz HVP Multi-Function Electrodes, Shelf Life 24 Months, 1 pair
8900-4005	Solid Gel Multi Function Electrodes, pro-padz, 24 month shelf life, 12pr/cs
8900-4012	Multi-Function Electrode, Shelf-Life 9 mo, Sterile, 6 pr/cs
9310-0737	8 1/2" x 11" Wall Sign
9310-0738	V-Shape Wall Sign
9650-0300-01	Operator's Guide/Wall Poster
9650-0301-01	Administration Guide
9650-0304-01	Replacement Trainer Operator's Guide
981122E	Battery Charger w/battery dual slot PIC
Accessories	
8900-0810-01	Pedi-padz II, Pediatric Multi-Function Electrodes, Use w/AED Plus or AED Pro, 1 pair

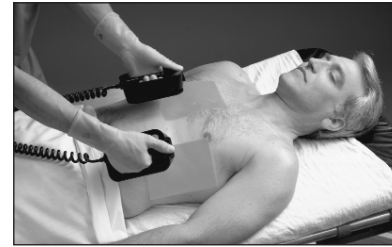

3M™ DEFIB PADS

Ready-to-use, conductive gel pads for use in defibrillation. Self-contained to eliminate inadvertent gel bridging which can cause skin trauma to patient or operator. Bright orange solid gel pads are easy to see, require no cleanup, and leave no slippery residue that can interfere with CPR.

2345N	4 1/2" x 4 1/2" Defib Pads, 2/pk, 10 pk/bx, 10 bx/cs
2346N	4 1/2" x 6" Defib Pads, 2/pr, 10 pr/bx, 10 bx/cs

3M™ EKG ALLIGATOR CLIP

J5	EKG Alligator Clip, J-Style, 5/bg
----	-----------------------------------

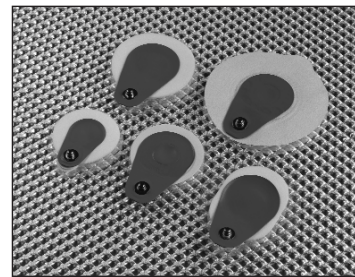

BURDICK BLUEMAX ELECTRODES, HOLTER/STRESS BY CARDIAC SCIENCE

Offset snap.

015-0630-00	Blue Max SUPATAB Resting ECG Electrode, Wet Gel, 100/pk, 24 pk/cs
097001	40mm Dia. Electrodes, Vinyl, 25/pch, 40 pch/cs
097002	50mm Dia. Electrodes, Foam, 25/pch, 40 pch/cs
097004	50mm Dia. Electrodes, Foam, 10/pch, 100 pch/cs
097010	68mm Dia. Electrodes, Micropore, 25/pch, 40 pch/cs
097014	30mm Dia. Electrodes, Foam, 10/pch, 200 pch/cs



BURDICK CARDIOSENS™ DISPOSABLE ELECTRODES BY CARDIAC SCIENCE

Three styles of disposable electrodes: CardioSens™/Ultra II has aggressive adhesive. Fast signal stabilization with rapid defibrillator recovery and superior conductivity. CardioSens™/K has exceptionally high conductive performance with natural Karaya adhesive. CardioSens™/Advantage has a narrow design with special formulation adhesive and high conductivity tin backing.

047029	CardioSens/Ultra II, 500/bx, 10 bx/cs
047866	CardioSens/K, 500/bx, 10 bx/cs
047881	CardioSens/Advantage (replaces 047057), 500/bx, 10 bx/cs

Accessories

704-0102-00	Clear Choice Adapter Universal Clip, 10/pk
-------------	--



BURDICK HEARTLINE® MONITORING ELECTRODES BY CARDIAC SCIENCE

Designed to deliver high quality, easy-to-read tracings and long-lasting adhesion for consistent, dependable performance.

- 007778 HeartLine Comfort Tape Wet Gel Electrodes, 48mm, 30/pouch, 600/cs
- 007781 HeartLine DuraFoam Wet Gel Electrodes, 48mm, 30/pouch, 20 Pouches/cs
- 007782 HeartLine Radiolucent Universal Electrode, 30/pouch, 600/cs
- 007784 HeartLine SensaCloth Electrodes, 30mm, 30/pouch, 600/cs

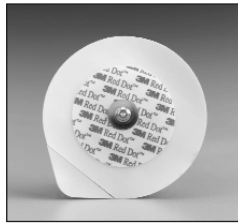

3M™ RED DOT™ CLEAR PLASTIC MONITORING ELECTRODES

A tear-drop style monitoring electrode with clear plastic backing that is ideal for situations when immediate skin assessment is required without the need to remove the electrode. The gel's low chloride content minimizes skin irritation for increased patient comfort.

- 2235 5.1cm Dia. Monitoring Electrodes w/o abrader, 50/bg, 20 bg/cs
- 9642 5.1cm Dia. Monitoring Electrodes w/o abrader, 50/bg, 20 bg/cs



3M™ RED DOT™ DIAPHORETIC FOAM MONITORING ELECTRODES

A rectangular-shaped electrode that offers a high-tack adhesive and foam backing designed for diaphoretic clinical situations. Patented solid gel penetrates the skin quickly allowing high quality. Low chloride content minimizes skin irritation.

- 2230 5.1cm x 5.5cm Monitoring Electrodes w/o abrader, 50/bg, 20bg/cs
- 2270-3 5.1cm x 5.5cm Monitoring Electrodes w/abrader, 3/bg, 20 bg/bx, 10 bx/cs
- 2270-5 5.1cm x 5.5cm Monitoring Electrodes w/abrader, 5/bg, 20 bg/bx, 10 bx/cs
- 2270-50 5.1cm x 5.5cm Monitoring Electrodes w/abrader, 50/bg, 20bg/cs



3M™ RED DOT™ DIAPHORETIC SOFT CLOTH MONITORING ELECTRODES

A rectangular-shaped electrode that offers a high-tack adhesive and soft cloth backing designed for diaphoretic clinical situations. Patented solid gel penetrates the skin quickly allowing high quality. Low chloride content minimizes skin irritation.

- 2231 5.1cm x 5.5cm Monitoring Electrodes w/o abrader, 50/bg, 20 bg/cs
- 2271-3 5.1cm x 5.5cm Monitoring Electrodes w/abrader, 3/bg, 20 bg/bx, 10 bx/cs
- 2271-5 5.1cm x 5.5cm Monitoring Electrodes w/abrader, 5/bg, 20 bg/bx, 10 bx/cs
- 2271-50 5.1cm x 5.5cm Monitoring Electrodes w/abrader, 50/bg, 20 bg/cs

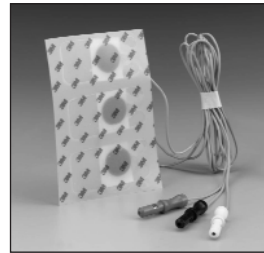

2269T

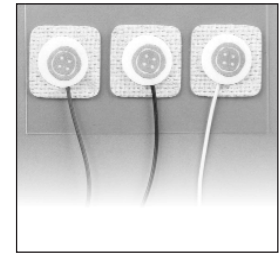

2280

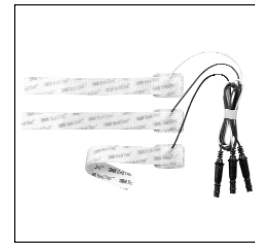

2284

3M™ RED DOT™ ECG MONITORING ELECTRODES WITH PRE-ATTACHED LEAD WIRE

- 2269T Neonatal, 2cm x 4cm, Pre-Wired Radiolucent Electrode w/clear tape, 3/bg, 10 bg/bx, 10 bx/cs
- 2280 Neonatal, 22mm x 22mm, Pre-Wired Non-Radiolucent Electrode w/soft cloth, 3/bg, 100 bg/cs
- 2282 Neonatal, 22mm x 22mm, Pre-Wired Radiolucent Electrode w/soft cloth, 3/bg, 100 bg/cs
- 2282L Neonatal, 2.2mm x 2.2mm, Pre-Wired Radiolucent Monitoring Electrode w/soft cloth, 26" Leadwire Length, 3/bg, 100 bg/cs
- 2283 Infant, 33mm x 22mm, Pre-Wired Radiolucent Electrode, 3/bg, 100 bg/cs
- 2284 Neonatal, 17mm x 22mm, Pre-Wired Radiolucent Limb Band Electrode, 3/bg, 100 bg/cs



3M™ RED DOT™ FOAM MONITORING ELECTRODES

Tear-drop style monitoring electrodes with foam backing. Patented solid gel penetrates the skin quickly allowing high quality, uninterrupted traces. Low chloride content minimizes skin irritation.

- 2237 4.4cm Dia. Monitoring Electrodes w/o abrader, 50/bg, 20 bg/cs
- 2237-3 4.4cm Dia. Monitoring Electrodes w/o abrader, 3/bg, 20 bg/bx, 10 bx/cs
- 2237-5 4.4cm Dia. Monitoring Electrodes w/o abrader, 5/bg, 20 bg/bx, 10 bx/cs
- 2259-3 5.1cm Dia. Monitoring Electrodes w/abrader, 3/bg, 20 bg/bx, 10 bx/cs
- 2259-5 5.1cm Dia., Monitoring Electrodes w/abrader 50/bg, 20 bg/cs
- 9640 5.1cm Dia. Monitoring Electrodes w/o abrader, 50/bg, 20 bg/cs



3M™ RED DOT™ INFANT SOFT CLOTH MONITORING ELECTRODES

- 2258-3 Infant, 3.2cm Dia., Soft Cloth Electrode w/o abrader, 3/bg, 20 bg/bx, 10 bx/cs

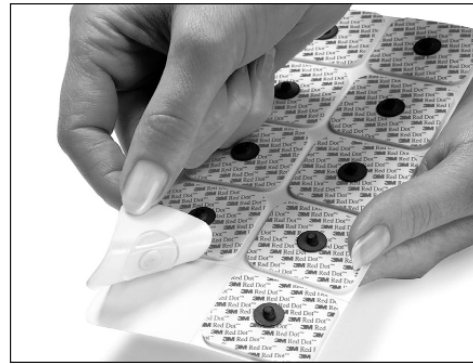

3M™ RED DOT™ MONITORING ELECTRODES WITH FOAM TAPE & STICKY GEL

Multi-purpose monitoring electrodes with foam backing and sticky gel are ideally suited for the OR, ER and diagnostic stress testing applications. Conveniently packaged in individual strips of ten electrodes for easy use and less waste. Remains fresh for 30 days out of the bag.

- 2560 Monitoring Electrode w/o abrader, 10/strip, 5 strips/bg, 20 bg/cs
- 2570 Monitoring Electrode w/abrader, Radiolucent Stud, 50/bg, 20 bg/cs
- 2570-3 4cm x 3.5cm Monitoring Electrodes w/abrader, Radiolucent Stud, 3/bg, 200 bg/cs
- 2570-5 4cm x 3.5cm Monitoring Electrodes w/abrader, Radiolucent Stud, 5/bg, 200 bg/cs

3M™ Red Dot™ Electrodes

Excellent trace
and patient
comfort
GUARANTEED*



Improved 9643 3M™ Red Dot™ Electrodes are more flexible and conformable for your clinician and their patients. Feedback from evaluators viewed it as a substantial improvement over the old design. This change is a major reason why you should choose 3M™ Red Dot™ Electrodes. Our electrodes have been a trusted choice of health care providers for more than 32 years. And, as you will see, 3M continues to find ways to improve electrode performance and convenience.

- Product features include:**
- Standard 5-day wear
 - Strip Delivery
 - Outstanding Trace Quality
 - Facility Wide Standardization

* Good as Gold Guarantee: If at any time and for any reason you are dissatisfied with 3M™ Red Dot™ Monitoring EKG Electrodes, we will replace the unexpired, unused product or, if you prefer, refund the purchase price.

3M and Red Dot are trademarks of 3M © 2009





3M™ RED DOT™ MONITORING ELECTRODES WITH MICROPORE™ TAPE BACKING

A round-style monitoring electrode with 3M Micropore™ Surgical Tape backing. Patented solid gel penetrates the skin quickly allowing high quality. Low chloride content minimizes skin irritation. Radiolucent to minimize the need to replace or remove electrodes in most radiological imaging applications.

- 2239 6cm Dia. Monitoring Electrodes w/o abrader, 50/bg, 20 bg/cs
- 2249-50 6cm Dia. Monitoring Electrodes w/abrader, 50/bg, 20 bg/cs
- 2248-50 Pediatric, 4.4cm Dia., Micropore Paper Tape Electrode, 50/bg, 20 bg/cs

3M™ RED DOT™ REPOSITIONABLE MONITORING ELECTRODES

- 2660-3 Repositionable Monitoring Electrodes, 1.56" x 1.25", 3/bg, 200 bg/cs
- 2660-5 Repositionable Monitoring Electrodes, 1.56" x 1.25", 5/bg, 200 bg/cs
- 2670-3 Repositionable Monitoring Electrodes, 1.56" x 1.25", 3/bg, 200 bg/cs
- 2670-5 Repositionable Monitoring Electrodes, 1.56" x 1.25", 5/bg, 200 bg/cs



3M™ RED DOT™ RESTING MONITORING ELECTRODES

Resting electrodes for 12-lead EKG applications.

- 2330 2.2cm x 2.2cm Monitoring Electrodes , Tab Style, 10/strip, 10 strips/bg, 10 bg/bx, 4 bx/cs
- 2352 1 3/4" x 7/8" Monitoring Electrodes , Snap Style, 10/bg, 100 bg/cs
- 2360 2cm x 2cm, Monitoring Electrode w/conductive adhesive, Tab Style, 10/card, 10 cards/bg, 40 bg/cs
- 2364 2cm x 2cm, Monitoring Electrode w/conductive adhesive, Tab Style, 10/card, 10 cards/bg, 40 bg/cs
- 9650 2.2cm x 2.2cm Monitoring Electrodes , Tab Style, 100/bg, 10 bg/bx, 4 bx/cs



3M™ RED DOT™ SOFT CLOTH MONITORING ELECTRODES

A round-style monitoring electrode with soft cloth backing for general ECG monitoring. Patented solid gel penetrates the skin quickly allowing high quality. Low chloride content minimizes skin irritation.

- 2238 6cm Dia. Monitoring Electrodes w/o abrader, 50/bg, 20 bg/cs
- 2238-3 6cm Dia. Monitoring Electrodes w/o abrader, 3/bg, 20 bg/bx, 10 bx/cs
- 2238-5 6cm Dia. Monitoring Electrodes w/o abrader, 5/bg, 20 bg/bx, 10 bx/cs
- 2255-50 6cm Dia. Monitoring Electrodes w/abrader, 50/bg, 20 bg/cs
- 9641 6cm Dia. Monitoring Electrodes w/o abrader, 50/bg, 20 bg/cs



3M™ RED DOT™ TRACE PREP

A gentle abrasive material designed to remove the non-conductive skin layer to achieve a better trace quality.

- 2236 3/4" x 196" Trace Prep w/dispenser, 36/cs



3M™ RED DOT™ WET GEL FOAM MONITORING ELECTRODES

Tear-drop style monitoring electrodes with wet gel. Low chloride content minimizes skin irritation.

- 2256-50 5.1cm Dia. Monitoring Electrodes w/abrader, 50/bg, 20 bg/cs

GE MEDICAL DISPOSABLE RESTING ECG ELECTRODES

Latex free. Rapid, stable baseline. Reduces potential for cross-contamination. Secure adhesion. Silver/silver chloride construction.

- 2014778-001 SilverTRACE® Plug Disposable Resting ECG Electrodes, Plug B4MO Foam Rectangle, Banana Socket, 30/pch, 10 pch/bx
- 402207-210 BabyMAC® Pediatric Disposable Resting ECG Electrodes, Tab, 10/card, 10 card/pk, 5 pk/cs
- 900703-310 SilverTRACE® Disposable Resting ECG Electrodes, Adult Foam Rectangle, Wet Gel, Snap, 5/strip, 2 strip/pch, 160 pch/cs
- 9623-003 Silver Mactrode® Disposable Resting ECG Electrodes, Tab, 10/card, 10 card/pk, 10 pk/cs
- 9623-003P Silver Mactrode® Plus Disposable Resting ECG Electrodes, Tab, 10/card, 10 card/pk, 10 pk/cs
- 9623-103P Silver Mactrode® Plus Disposable Resting ECG Electrodes, Tab, 14/card, 10 card/pk, 10 pk/cs

GE MEDICAL EXERCISE/STRESS, HOLTER, TELEMETRY SNAP ELECTRODES

Latex free foam and vinyl tape electrodes Two-piece snap connectors. Silver/silver chloride electrodes with wet or solid gel.

- 2014768-001 SilverTRACE® Multi P21MO, Disposable Adult ECG Electrodes, Foam Oval w/tab, Solid Gel, 30/pch, 10 pch/bx
- 2014775-001 SilverTRACE® First P28MO, Disposable Adult ECG Electrodes, Wet Gel, 30/pch, 10 pch/bx
- 2014777-001 SilverTRACE® Soft P55MO, Disposable Adult ECG Electrodes, Foam Round, Wet Gel, 30/pch, 10 pch/bx
- 2014780-001 SilverTRACE® Soft Stress PS50MO, Disposable Adult ECG Electrodes, Foam Round, Wet Gel, 30/pch, 10 pch/bx
- 2014783-001 SilverTRACE® Window P50TR, Disposable Adult ECG Electrodes, Vinyl Tape Round, Solid Gel, 30/pch, 10 pch/bx
- 2014784-001 SilverTRACE® Window P50TR, Disposable Adult ECG Electrodes, Vinyl Tape Round, Solid Gel, 5/strip, 60 strip/bx
- 2014785-001 SilverTRACE® Window P50TR, Disposable Adult ECG Electrodes, Vinyl Tape Round, Solid Gel, 7/pch, 50 pch/bx
- 900703-205 SilverTRACE® Disposable Adult ECG Electrodes, Foam Oval, Wet Gel, 5/strip, 30 strip/bx, 4 bx/cs
- 900703-230 SilverTRACE® Disposable Adult ECG Electrodes, Foam Oval, Wet Gel, 30/pch, 10 pch/cs
- 9653-305 SilverTRACE® Disposable Adult ECG Electrodes, Clear Vinyl Tape, Solid Gel, 5/pch, 60 pch/cs
- 9653-507 SilverTRACE® Disposable Adult ECG Electrodes, Clear Vinyl Tape, Solid Gel, 7/pch, 50 pch/cs

GE MEDICAL QWIK CONNECT® PLUS FETAL SPIRAL ELECTRODES

Locking mechanism secures the electrode during attachment. Electrode wires stabilized inside the guide tube until unlocked by the clinician. Latex free. Sterile.

- 7000AAO Fetal Spiral Electrode, 50/cs

GE MEDICAL RADIOTRANSLUCENT ELECTRODES

Latex free polyethylene foam base. Carbon snap is x-ray translucent and non-magnetic. Conductive wet gel provides clear ECG traces.

- 2014786-001 SilverTRACE® First Carbon P28MO, Disposable Radiotranslucent ECG Electrodes, Foam Rectangle, Wet Gel, 30/pch, 10 pch/bx
- 2014787-001 SilverTRACE® First Carbon P28MO, Disposable Radiotranslucent ECG Electrodes, Foam Rectangle, Wet Gel, 5/strip, 60 strip/bx
- 9408-401 SilverTRACE® Disposable Adult Radiotranslucent ECG Electrodes, Foam Oval, Wet Gel, 5/strip, 60 strip/cs

GE MEDICAL QWIK CONNECT® PLUS DISPOSABLE ATTACHMENT PADS

Reduces potential for cross-contamination. Nickel-plated stud insures good conductivity. Eliminates the need for uncomfortable leg plate adapter straps. Latex free. Secure adhesive.

- 2464AAO Spiral Leg Plate Attachment Pads, 1" x 3", 50/cs

GE MEDICAL REUSABLE RESTING ECG ELECTRODES & ACCESSORIES

German silver electrodes minimize baseline drift and reduce contact resistance. GE suction electrode perfect fit for 0.156" (4mm) banana plug leadwires. Limb clamps that are latex free, easy to apply, and accepts both banana plug and snap leadwires.

- 5608-003 GE Gray Suction Bulb
- 9033-014 GE Suction Electrode
- 9033-015 GE Suction Electrode & Gray Bulb

Accessories

- 9033-006 Rubber Limb Strap, Latex Free
- 9033-401 Limb Clamps, 4/set

Welch Allyn has a broad range of devices that connect today.

Now you can automatically transfer patient information and test data into your EMR without redundant work steps, misidentified patients, transcription errors or delay.

With a broad range of devices that connect today, Welch Allyn can tailor a solution that's perfect for your office workflow. Using the Welch Allyn CardioPerfect™ Workstation Software and our vital signs software integration kit, you can transfer both cardiopulmonary and vital signs information directly into your Electronic Medical Records system. This eliminates the need for manual data entry, improves accuracy and enables immediate access to patient diagnostic information, enhancing your practice's efficiency.

For a personal demonstration or for more information, please contact your local representative.



WelchAllyn®

Advancing Frontline Care™

GE MEDICAL SKIN PREP PRODUCTS & ELECTRODE ACCESSORIES

3704-901	Prep Razors, 100/pk
4828-004	Alcohol Pumice Prep Pads, 100/bx
4828-005	Sandpaper Prep Strips, 100/bx
4829-002	Pre-Cut Tape Strips For Stress Loops, 6/card, 100 card/pk
9386-001	Dry Skin Prep Pads, 200/pk

GE MEDICAL MONITORING/TELEMETRY ELECTRODES

Latex free. Conductive gel.

2014779-001	SilverTRACE® Micro P55MI Disposable Adult ECG Electrodes, Paper Round, Wet Gel, 30/pch, 10 pch/bx
2014781-001	SilverTRACE® Soft Stress PS50MO Disposable Adult ECG Electrodes, Foam Round, Wet Gel, 5/strip, 120 strip/bx
2014782-001	SilverTRACE® Tissair P40CL Disposable Adult ECG Electrodes, Cloth Round, Solid Gel, 30/pch, 10 pch/bx
900690-030	SilverTRACE® Disposable Adult ECG Electrodes, Foam Round w/tab, Solid Gel, 30/pch, 10 pch/cs
900690-403	SilverTRACE® Disposable Pediatric ECG Electrodes, Cloth Rectangle, Solid Gel, 3/bg, 15 bg/pch, 10 pch/cs
900690-404	SilverTRACE® Disposable Neonatal ECG Electrodes, Cloth w/preattached leadwires, Solid Gel, 3/bg, 100 bg/cs
9431-004	SilverTRACE® Disposable Adult ECG Electrodes, Foam Round, Wet Gel, 30/pch, 10 pch/cs

COVIDIEN/KENDALL TELEMETRY/HOLTER POUCHES & KITS

Kendall offers a variety of Holter and Telemetry pouches, kits and accessories.

30951514	Telemetry Kit, MPK-MOD5, Contains 535 Electrode, Prep Pad, (2) 1.5 Alkaline Batteries and Pouch, 50/cs
30951555	Telemetry Pouch, TMY-BLUE-50, Small, 50/cs
30951746	Holter Kit, HMPK-HOLTR1, Contains 535 & 533 Electrodes, Tape, Prep Pad, Abrasive Pad, 9V Battery, Razor and Diary, 50/cs
30951811	Telemetry Pouch, TMY-BLUE-2-100, Large, 100/cs
31098448	Telemetry Kit, MPK-MOD4, Contains 535 Electrode, Prep Pad, 9V Battery & Pouch, 50/cs
MK05140	Holter Kit, SK7828, Contains 535 Electrode, 9V Battery, Tape & Diary, 20/cs
MK06200	Holter Kit, Digial, Contains 535 & 533 Electrodes, (2) AA Batteries, Razor, Prep Pad, Abrasive Pad & Diary, 20/cs

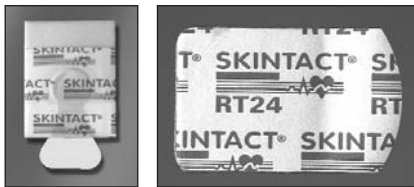

FSWA00

RT-24



RT-41

LEONHARD LANG SKINTACT® DIAGNOSTIC RESTING ECG ELECTRODES

Designed for resting 12 lead diagnostic ECG's. Easitabs are disposable eliminating the spread of cross infection associated with older style suction cups. The C-LINE technology ensures that every electrode will be fresh providing exceptional consistency in quality of recordings at very affordable prices.

FSWA00	Diagnostic ECG Electrodes, Foam, Ultra-Tack Adhesive, Wet Gel, 500/bx
RT-24	Diagnostic ECG Electrodes, All-Purpose, 1000/bx
RT-41	Diagnostic ECG Electrodes, Ultra-Tack Adhesive, Oversize, 1000/bx, 4 bx/cs

Accessories

58100	EasiClip (Universal Alligator Clip), 10/bx
58727	EasiPrep (FingerTip Abrasion Strips), 500/bx



FS-40

FS-50

FS-50C

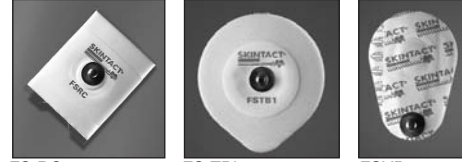

FS-RC-4

FS-TBI

FSVB01

LEONHARD LANG SKINTACT® STRESS TEST & HOLTER ECG ELECTRODES

Designed to provide the highest quality tracings for stress test procedures. The offset design and Aqua-Set gel significantly reduce any motion artifacts ensuring a very clear stable trace even under the most strenuous conditions. The C-LINE technology ensures that every electrode will be fresh providing exceptional consistency in quality of recordings at very affordable prices.

FS-40	40mm Stress Test ECG Electrode, Aqua-Wet Gel, Foam Backing, Diaphoretic, Hypoallergenic, 1200/bx
FS-50	50mm Stress Test ECG Electrode, Aqua-Wet Gel, Snap Connector, Foam Backing, Enhanced Adhesive, 1200/bx
FS-50C	50mm Stress Test ECG Electrode, Radio Translucent, Foam w/carbon stud, Diaphoretic, Hypoallergenic, 1200/bx
FS-RC-3	35 x 45mm Stress Test ECG Electrode, Aqua-Wet Gel, Foam Backing, Diaphoretic, Hypoallergenic, 3/strip, 1200/bx
FS-RC-4	35 x 45mm Stress Test ECG Electrode, Aqua-Wet Gel, Foam Backing, Diaphoretic, Hypoallergenic, 600/bx
FS-RC-5	35 x 45mm Stress Test ECG Electrode, Aqua-Wet Gel, Foam Backing, Diaphoretic, Hypoallergenic, 5/strip, 1200/bx
FS-TB	Electrode, High Performance, Wet Gel, Foam Backing, Stress/Holter/Echo/Monitoring, 30/Pouch, 40 Pouches/bx, 4 bx/cs
FS-TBI	50mm Stress Test ECG Electrode, Solid Gel, Lift Tab, Foam Backing, Diaphoretic, Hypoallergenic, 1500/bx
FSVB01	36 x 53 mm Stress Test ECG Electrode, Aqua-Wet Gel, Offset Snap Connector, Foam Backing, Enhanced Adhesive, 1200/bx
FSVB011	35 x 53 mm Stress Test ECG Electrode, Solid Gel, Offset Snap Connector, Foam Backing, Enhanced Adhesive, 1500/bx



0315

0515

0615

0815

NIKOMED DIAGNOSTIC TAB ELECTRODES

The Nikotab System with Nikomed diagnostic ECG is easy. Unique design allows for quick and easy prep. The highest quality adhesive and innovative shape prevent twisting and deliver the greatest percentage of first time recordings. Wide-body design holds Nikotab absolutely flat, securing it in place to eliminate the twist. This product is latex free.

0315	Adult, 21 x 34mm, 5000/cs
0515	Adult, 23 x 34mm, 5000/cs
0615	Adult, 25.8 x 35.8mm, Z-Fold Tab, 5000/cs
0715	Adult, 26 x 34mm, 5000/cs
0815	Pediatric, 13 x 34mm, 5000/cs



2121



EZ-123

NIKOMED ECG ACCESSORIES

- 2121 Niko-Prep, 10/card, 500/cs
- 2121-E Niko-Prep, Individual, 500/cs
- EZ-123 Diagnostic Enhancement Kit (1 pk NIK-20 [choice of 0315, 0515, 0715], 1 pk NIKOtabs, 1 card 2121)
- NIK-20 NikoClip Adapter Clip Fits 3-4mm, 10/pk

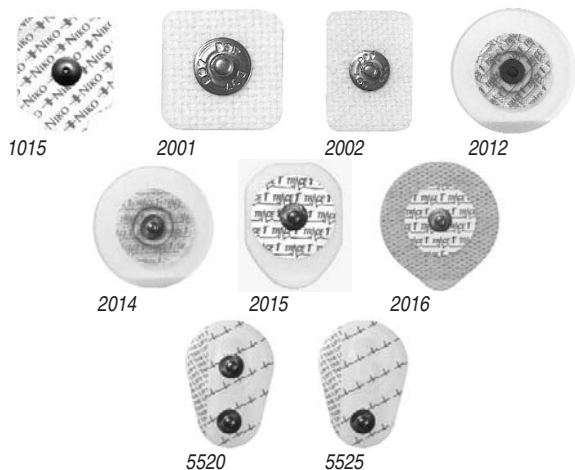

NIKOMED TRACE1™ SOLID GEL MONITORING ELECTRODES

This product is latex free.

- 1015 Foam, Stress/Holter, Super Tack Adhesive, 300/bx
- 2001 Specialty Bio-Feedback, Nonwoven, 7/8" x 7/8", 300/bx
- 2002 Specialty Bio-Feedback, Nonwoven, 1 7/8" x 7/8", 300/bx
- 2010 Foam, Stress/Holter, Super Diaphoretic Adhesive, 300/bx
- 2012 Clear Tape, Thallium Stress, Cardiac Catheter, Radio, 300/bx
- 2014 Clear Tape, General-Purpose, Breathable, 300/bx
- 2015 Foam, Stress/Holter, Super Tack Diaphoretic Adhesive, 300/bx
- 2015-3S Foam, Stress/Holter, Super Tack Diaphoretic Adhesive, 300/bx
- 2016 Cloth, ICU/CCU, Breathable, 300/bx
- 2054 Clear Tape, General Purpose, Kidney Shape, Breathable, 300/bx
- 5520 Foam, Multi-Snap, Specialty Dual Monitoring, One Sensing Area, 300/bx
- 5525 Foam, Stress/Holter/ER, Off Center, 300/bx

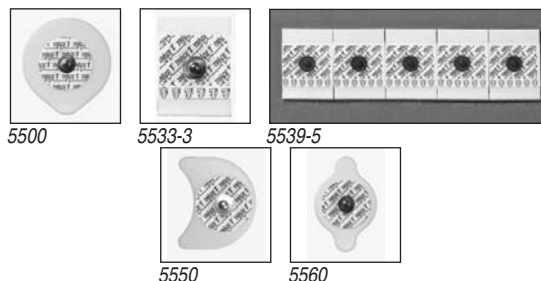

NIKOMED TRACE1™ WET GEL MONITORING ELECTRODES

This product is latex free.

- 4540 Foam, Diagnostic Resting ECG, Direct Connection to 4mm Receptor, 300/bx
- 5500 Stress/Holter Monitoring Electrodes, 50mm, Super-Tack Diaphoretic Adhesive, Eyeball Shape, 300/bx
- 5511 General Purpose Monitoring Electrodes, Clear Tape, Diaphoretic Adhesive, 50mm, 300/bx
- 5533-3 General Purpose Monitoring Electrodes, 32 x 44mm, Super-Tack Diaphoretic Adhesive, 3 Per Strip, 300/bx
- 5533-5 General Purpose Monitoring Electrodes, 32 x 44mm, Super-Tack Diaphoretic Adhesive, 5 Per Strip, 300/bx
- 5535 Diagnostic Resting ECG Monitoring Electrodes, Pediatric Monitoring, 32 x 44mm, Easy-Tack Patient-Friendly Adhesive, 300/bx
- 5539-5 Thallium Stress Monitoring Electrodes, Cardiac Cath., 28 x 45mm, Super-Tack Diaphoretic Adhesive, Radio-Translucent X-Ray Opaque Snap/Sensor System, 5 Per Strip, 300/bx
- 5550 Foam, Stress/Holter, Kidney Shape, Super Tack Diaphoretic Adhesive, 5 per Strip, 300/bx
- 5550-3S Foam, Stress/Holter, Kidney Shape, Super Tack Diaphoretic Adhesive, 3 per Strip, 300/bx
- 5559 Foam, Thallium Stress, Cardiac Catheter, Kidney Shape, Radio Translucent, 3 per Strip, 300/bx
- 5560 Stress Monitoring Electrodes, 38 x 59mm, Super-Tack Diaphoretic Adhesive, 30/pk, 300/bx



BURDICK ASSURANCE 50™ ECG RECORDING PAPER BY CARDIAC SCIENCE

Guaranteed to hold a trace for 50 years. Single and multi-channel formats. Special thermal paper resists effects of alcohol, sunlight, plastics and other common contaminants that degrades image quality on standard thermal papers.

- 716-0233-00 Assurance Paper, Red Grid Use w/ Burdick EK10, Elite II, SUB FOR 007957 & 007975, 100r/cs
- 716-0234-00 Assurance Paper, Z-Fold Pad Red Grid, Perforated No Header use w/Burdick Eclipse LE, LEII, E550, E560, E350, E600, ExTOL 200 sheets/pd, 10pd/cs
- 716-0235-00 Assurance Paper, Z-Fold Pad Red Grid, Perforated w/blank header use w/Burdick Eclipse8, 800, 300 sheets/pd, 10pd/cs
- 716-0237-00 Assurance Paper, For Use w/Burdick Atrias, Burdick Quest, Burdick Eclipse Plus & Eclipse Premier, 200 sheet/pad, 10 pad/cs
- 716-0239-00 Assurance Paper, Z-Fold Pad Red Grid, Perforated w/blank header use w/Burdick Eclipse 850, 300 sheets/pd, 10pd/cs

BURDICK HEARTLINE® THERMAL PAPER BY CARDIAC SCIENCE

- 007868 Heartline Thermal Paper Pads, 5.910" (150mm) Red Grid, Perforated w/no header, 8.5" (216mm) x 11" (279mm) Format, Z-Fold, For Use w/Eclipse LE, LEII, E550, E560, E350, E600 EXTOL, 200 sheets/pad, 10 pd/cs
- 007940 Heartline Thermal Paper Roll, 1.773" (45mm) Red Traditional Grid, 1.970" (50mm) x 100 ft (30.48m) Long, For Use w/Medic 3, Medic 4, Medic 6, WWR-1, REC-8, DC190, DC185, 100ft/roll, 100 rl/cs
- 007941 Heartline Thermal Paper Roll, 1.970" (50mm) Orange Traditional Grid, 2.443" (62mm) x 150 ft (45.72m) Long, For Use w/Ek4, Ek5/5A, E8, E100, E200, Must Order in Increments of 20
- 007958 Heartline Thermal Paper Roll, 1.773" (45mm) Red Matrix Grid, 1.970" (50mm) x 150 ft (45.72m) Long, For Use w/EK10, Elite, Elite II, Medic 5, 150ft/roll, 80 rl/cs
- 007966 Heartline Thermal Paper Pads, 5.910" (150mm) Red Matrix Grid, Perforated w/header, 8.5" (216mm) x 11" (279mm) Format, Z-Fold, For Use w/E350, 200 sheets/pad, 10 pd/cs
- 007971 Heartline Thermal Paper Pads, 3.543" (90mm) Red Matrix Grid, Perforated w/blank header, 4" (102mm) x 5.5" (140mm) Format, Z-Fold, For Use w/Eclipse 4/400, 200 sheets/pad, 40 pd/cs
- 007979 Heartline Thermal Paper Pads, 5.910" (150mm) Red Matrix Grid, Perforated w/blank header, 8.5" (216mm) x 5.5" (140mm) Format, Z-Fold, For Use w/Eclipse 8, 800, 300 sheets/pad, 10 pd/cs
- 007983 Heartline Thermal Paper Pads, 5.910" (150mm) Red Matrix Grid, Perforated w/blank header, 8.5" (216mm) x 11" (279mm) Format, Z-Fold, For Use Quest, Eclipse Plus & Atria, 200 sheets/pad, 10 pd/cs
- 007988 Heartline Thermal Paper Pads, 5.910" (150mm) Red Matrix Grid, Perforated w/blank header, 8.5" (216mm) x 5.5" (140mm) Format, Z-Fold, For Use Eclipse 850, 300 sheets/pad, 10 pd/cs

GE MEDICAL LASER PRINTER PAPERS

Quality paper stock minimizes wear on laser printers. Save time printing traces on preprinted grid paper. Red grids improve trace legibility.

- 9402-053 Laser Printer Paper, Red Grid w/blank interpretation area, 8.5" x 11", 500 sheets/pk, 5 pk/cs
- 9402-054 Laser Printer Paper, Full Page Red Grid, 8.5" x 11", 500 sheets/pk, 5 pk/cs

GE MEDICAL PREMIUM THERMAL RECORDING PAPERS

Exclusive chemical composition resists trace fading for 5-7 years following recommended storage procedures. Clear, precise trace. Designed for reading ease.

- 22613001 Premium Thermal Paper, 55mm x 40M
- 22616606 Premium Thermal Paper, Full Page Brown Grid, Queue Mark, 8.5" x 11", Z-Fold, 150 sheets/pk, 10 pk/cs
- 22616802 Premium Thermal Paper, Brown Dot Grid, 3.54" x 115 ft, 10/cs
- 385-1000-015 Premium Thermal Paper, Brown Grid, 8.5" x 11", Z-Fold, 400 sheets/pk, 10 pk/cs
- 9402-018 Premium Thermal Paper, Red Grid, 4" DDW 4.25" x 150 ft, 32/cs
- 9402-020 Premium Thermal Paper, Full Page Red Grid, 8.5" x 11", Z-Fold, Queue Hole, 300 sheets/pk, 8 pk/cs
- 9402-021 Premium Thermal Paper, Full Page Red Grid, A-4 Modified, 8.26" x 11", Z-Fold, Queue Hole, 300 sheets/pk, 8 pk/cs
- 9402-023 Premium Thermal Paper, Red Grid, 4.25" x 75 ft, 2/pk, 9 pk/cs
- 9402-024 Premium Thermal Paper, Red Grid w/blank interpretation area, 8.5" x 11", Z-Fold, Queue Hole, 300 sheets/pk, 8 pk/cs
- 9402-028 Premium Thermal Paper, All White, 2" x 100 ft, 48/cs
- 9402-029 Premium Thermal Paper, All White, Queue Hole, 8.5" x 11", Z-Fold, 300 sheets/pk, 8 pk/cs
- 9402-030 Premium Thermal Paper, All White, Black Queue Mark, 8.5" x 11", Z-Fold, 300 sheets/pk, 8 pk/cs
- 9402-031 Premium Thermal Paper, Green Grid w/blank interpretation area, 8.5" x 11", Z-Fold, Queue Hole, 300 sheets/pk, 8 pk/cs
- 9402-046 Premium Thermal Paper, 2" x 100 ft, 48/cs
- 9402-050 Premium Thermal Paper, Red Grid w/blank interpretation area, 8.5" x 11", Z-Fold, Queue Hole, 500 sheets/pk, 5 pk/cs
- 9402-060 Premium Thermal Paper, Full Page Red Grid, Queue Hole, 8.5" x 11", Z-Fold, 150 sheets/pk, 16 pk/cs
- 9402-061 Premium Thermal Paper, Red Grid w/blank interpretation area, Queue Hole, 8.5" x 11", Z-Fold, 150 sheets/pk, 16 pk/cs
- 9402-324 Premium Thermal Paper, Red Grid w/blank interpretation area, 3-Hole Punch, 8.5" x 11", Z-Fold, Queue Hole, 300 sheets/pk, 8 pk/cs
- 9472-103 Premium Thermal Paper, All White, 2" x 100 ft, 4/bx

GE MEDICAL UNIVERSAL THERMAL RECORDING PAPERS

Bright white paper offers excellent trace legibility. Best choice for MUSE customers. Electronic record reduces need for more expensive, long-term trace retention.

- 9902-020 Universal Thermal Paper, Full Page Red Grid, 8.5" x 11", Z-Fold, Queue Hole, 300 sheets/pk, 8 pk/cs
- 9902-021 Universal Thermal Paper, Full Page Red Grid, A-4 Modified, 8.26" x 11", Z-Fold, Queue Hole, 300 sheets/pk, 8 pk/cs
- 9902-024 Universal Thermal Paper, Red Grid w/blank interpretation area, 8.5" x 11", Z-Fold, Queue Hole, 300 sheets/pk, 8 pk/cs
- 9902-024GY Universal Thermal Paper, Gray Grid w/blank interpretation area, 8.5" x 11", Z-Fold, Queue Hole, 300 sheets/pk, 8 pk/cs
- 9902-030 Universal Thermal Paper, All White, Black Queue Mark, 8.5" x 11", Z-Fold, 300 sheets/pk, 8 pk/cs
- 9902-031 Universal Thermal Paper, Green Grid w/blank interpretation area, 8.5" x 11", Z-Fold, Queue Hole, 300 sheets/pk, 8 pk/cs
- 9902-324 Universal Thermal Paper, Red Grid w/blank interpretation area, 3-Hole Punch, 8.5" x 11", Z-Fold, Queue Hole, 300 sheets/pk, 8 pk/cs
- 9902-920 Universal Thermal Paper, Full Page Red Grid, 8.5" x 11", Z-Fold, Queue Hole, 300 sheets/pk, 10 pk/cs
- 9902-924 Universal Thermal Paper, Red Grid w/blank interpretation area, 8.5" x 11", Z-Fold, Queue Hole, 300 sheets/pk, 10 pk/cs
- 9902-931 Universal Thermal Paper, Green Grid w/blank interpretation area, 8.5" x 11", Z-Fold, Queue Hole, 300 sheets/pk, 10 pk/cs

We offer:

- Great Service
- Great Pricing
- Great Products

COVIDIEN/KENDALL CHART PAPERS

Kendall-LTP manufactures one of the largest offerings of recording chart papers in the industry. With more than 40 years of manufacturing experience, our customers can expect consistent trace quality as well as a product that is designed to meet or exceed the instrument specifications.

- 20608594 Recording Chart Paper, Compatible to Spacelabs/Burdick 007868, 10 pads/cs
- 30015682 Recording Chart Paper, Compatible to Spacelabs 307438, 50 r/cs
- 30540499 Recording Chart Paper, Compatible to Spacelabs 307568, 20 pad/cs
- 30561354 Recording Chart Paper, Compatible to Quinton 16211-002, 20 pad/cs
- 30597226 Recording Chart Paper, Compatible to GE/Corometrics 4305AAO, 40 pad/cs
- 30659745 Recording Chart Paper, Compatible to Nihon Kohden FQW50-3-100, 100 pad/cs
- 30718970 Recording Chart Paper, Compatible to Physio-Control 804700, 50 r/cs
- 30725389 Recording Chart Paper, Compatible to Philips 40477A, 80 r/cs
- 30729225 Recording Chart Paper, Compatible to Quinton 18416-001, 20 pad/cs
- 30748696 Recording Chart Paper, Compatible to Philips M1910A, 40 pad/cs
- 30763711 Recording Chart Paper, Compatible to Spacelabs 006-0196-00, 100 pad/cs
- 30768678 Recording Chart Paper, Compatible to Philips M1707A, 8 pad/cs
- 30781747 Recording Chart Paper, Compatible to GE/Marquette 9402-046, 50 r/cs
- 31002176 Recording Chart Paper, Compatible to GE/Marquette 9402-020, 8 pad/cs
- 31002184 Recording Chart Paper, Compatible to GE/Marquette 9402-024, 8 pad/cs
- 31091427 Recording Chart Paper, Compatible to Physio-Control 805319-03, 18 r/cs

TECH-MED ECG PAPER

- 3306 ECG Roll Paper For 3 Channel, 183mm x 30mm, Red Grid

BURDICK SINGLE CHANNEL ECG MOUNTS BY CARDIAC SCIENCE

- 007036 ECG Mounts, Elite Folder, Pressure-Sensitive, Full Information, 100/bx, 5 bx/cs
- 007037 ECG Mounts, Card, Pressure-Sensitive, 100/bx, 5 bx/cs
- 007857 ECG Mounts, Card, Pressure-Sensitive, 12-Lead, 100/bx, 5 bx/cs
- 007909 ECG Mounts, Card, Pressure-Sensitive, 3 Sec., 12-Lead, 100/bx, 5 bx/cs
- 007911 ECG Mounts, Folder, Pressure-Sensitive, 3 Sec., 12-Lead, 100/bx, 5 bx/cs

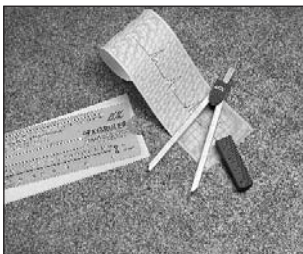

ADC EKG CALIPER

A precision crafted instrument of hardened steel for accurate measurement of tracing intervals. Point protector has built-in 40mm metric scale. Measures 4 3/4"

- 395 EKG Caliper



PARKER LABS REDUX® ELECTROLYTE CRÈME

For routine ECG. Cosmetic quality, pleasing to patients. Non-irritating. Highly conductive electrode cream.

- 66-04 Electrolyte Creme, 114g (4 oz) Tube, 10/bx, 5 bx/cs



PARKER LABS REDUX® ELECTROLYTE GEL

Non-abrasive, water-based gel for routine ECG and defibrillation. Highly conductive. Water soluble, non-staining, non-gritty.

- 65-04 Electrolyte Gel, 114g (4 oz) Tube, 10/bx, 5 bx/cs



PARKER LABS REDUX® ELECTROLYTE PASTE

Water-based, abrasive gel for short term monitoring, ECG and defibrillation. Highly conductive and water soluble.

- 67-05 Electrolyte Paste, 142g (5 oz) Tube, 10/bx, 5 bx/cs



PARKER LABS SIGNACREME® ELECTRODE CREAM

Highly conductive cream electrolyte for use in electromedical procedures. Bacteriostatic, non-irritating and hypoallergenic. Cosmetic quality; pleasing to patients.

- 17-05 Electrode Cream, 5 oz Dispenser, 12/bx, 6 dz/cs
- 17-20 Electrode Cream, 2 Liter (70 oz) w/2 dispensers & 1 Dispenser Pump, 4 bx/cs



PARKER LABS SIGNAGEL® ELECTRODE GEL

Highly conductive, multi-purpose electrolyte is an ideal saline electrode gel. Recommended for all electromedical procedures. Bacteriostatic, non-irritating, non-gritty. Water-soluble and non-staining.

- 15-25 Electrode Gel, 250g Tube, 6 dz/cs
- 15-60 Electrode Gel, 60g Tube, 12 dz/cs



PARKER LABS SIGNASPRAY® ELECTRODE SOLUTION & SKIN PREP

Highly conductive, multi-purpose spray electrolyte and non-gritty skin prep which provides superior conduction between skin and electrodes. For ECG and muscle stimulation. Assures clean, artifact-free ECG tracings. Bacteriostatic, hypoallergenic, non-staining. No residue build-up.

- 18-04 Signaspray Pac® Electrode Solution w/4 gallon containers, 2 Spray Dispenser Bottles, 1 Pump, 1/cs
- 18-25 Electrode Solution, 250-ml Spray Dispenser Bottle, 12/bx, 6 dz/cs
- 18-28 Electrode Solution, Gallon w/spray dispenser bottle, 4/cs

MIDMARK IQSPIRO™

Combines a digital spirometer with innovative software solutions that make it fast and easy to capture, interpret and retrieve patient information. The digital spirometer also features correct patient positioning that can optimize testing and an eject lever that saves time and alleviates handling of used mouthpieces. View real-time flow/volume loop and volume/time graphs with fully customizable parameters. Pre- and post-bronchodilator testing with automatic interpretation. New eject lever alleviates handling of used mouthpiece. Accurate and precise; meets or exceeds ATS 2005 standards. Lightweight, portable design weighs only 9 oz. Correct, ergonomic patient testing orientation. Easy grasp, new T-shaped handle design for patient support and stability during testing. Improved mouthpiece stability and protection with new easy-latch door design. Easy to print full page reports on standard paper.

- 4-000-0020 IQspiro, Serial Version w/o software
- 4-000-0021 IQspiro w/syringe, Serial Version w/o software
- 4-000-0025 IQspiro Digital Spirometer, USB Version w/o software
- 4-000-0026 IQspiro w/syringe, USB Version w/o software

MIDMARK IQSPIRO™ ACCESSORIES

- 2-100-1205 Disposable Spirometer Mouthpiece, 25/bx
- 2-100-1206 Disposable Spirometer Mouthpiece, 25/bx, 4 bx/cs
- 2-100-1207 Mouthpiece, Individually Bagged, 500/cs



MIDMARK IQMARK® DIGITAL SPIROMETER

- 4-000-0006 IQmark® Digital Spiro w/syringe, Serial Version w/o software
- 4-000-0010 IQmark® Digital Spiro w/syringe, USB Version w/o software
- 4-000-0012 IQmark® Digital Spiro, Serial Version w/o software
- 4-000-0013 IQmark® Digital Spiro, USB Version w/o software



MIDMARK IQMARK® SPIROMETRY SUPPLIES

- 1-100-0003 IQmark® 3-Liter Calibration Syringe
- 2-100-1200 Disposable Pneumotach Mouthpieces, 25/bx
- 2-100-1201 Disposable Pneumotach Mouthpieces, 25/bx, 8 bx/cs
- 3-100-8500 Syringe Adapter



BURDICK SENAIRE HANDHELD SPIROMETER BY CARDIAC SCIENCE

Full functioning ATS compliant spirometer that weighs less than 13 ounces. User friendly touch screen provides quick navigation and easy interpretation. Base station allows easy battery recharging and data transfer. Print reports by connecting the spirometer or base station to a computer.

- 92524-01 Burdick Sensaire Handheld Spirometer, English Version, 120V



BURDICK SPIROCARD SPIROMETER BY CARDIAC SCIENCE

Performs all the tests you would expect from a conventional device. Features patented, pre-calibrated, disposable patient filters. Interface to Office Medic software for real-time data access, reporting and archival. Compatible with your favorite off-the-shelf PC, laptop, tablet PC or Compaq iPAQ.

- 92526-01 Burdick SpiroCard PC Card Spirometer, English

BURDICK SPIROMETRY ACCESSORIES BY CARDIAC SCIENCE

010-1600-00	Sensaire Rechargeable Battery Pack
010-1601-00	Sensaire User's Manual
010-1604-00	Sensaire Mouthpieces, 100/bx
010-1605-00	SpiroCard/SpirOxCard Mouthpieces, 100/bx
010-1606-00	SpiroCard/SpirOxCard Pressure Tubes, 25/bg
010-1607-00	OxiCard Adult Fingerclip Sensors
010-1615-00	Sensaire Pressure Tube For Calibration Use Only, 10/pkg
010-1616-00	Sensaire Stylus, 10/pkg
086613	Spirometry Book: A Better Way Mouthpiece Adapter For Calibration Syringe SpiroTouch, Sensaire, SpirOxCard & SpiroCard
100049	Spirotouch & Presto™ Thermal Paper, 6 rl/cs
100161	Plastic Mouthpieces, 100/pk
100162	Noseclips, 5/pkg
100243	Cardboard Mouthpieces (Presto & SpiroSense), 100/pkg
100362	Flash Cardboard Mouthpieces, 100/pk
100612	Mouthpiece, 25/pk
100613	Flow Sensor Insert For Spirotouch
103-0208-00	Mouthpiece Adapter for Calibration Syringe SpiroTouch, Sensaire, SpirOxCard & SpiroCard

**BURDICK SPIROX CARD SPIROMETER/PULSE OXIMETER BY CARDIAC SCIENCE**

Combines a spirometer and a pulse oximeter on a single PCMCIA card providing two diagnostic tests in one portable package. Performs all measurements performed on conventional devices. Features patented, disposable and biodegradable patient filters. Devices interface to Office Medic software for real-time data access, reporting and archival. Compatible with your favorite off-the-shelf PC, laptop, tablet PC or Compaq iPAQ.

92525-01 Burdick SpirOx Card PC Card Spirometer/Pulse Oximeter, English

WELCH ALLYN ECG PC SPIROMETRY

101442	CPWS Resting ECG, Interpretive & Spirometry Bundle
101444	CPWS Resting ECG, Interpretive & ABPM-6100S Module Bundle
101447	CPWS SpiroPerfect & ABPM-6100S Module Bundle
101448	CPWS Resting ECG, Non- Interpretive & Spirometry Bundle
101450	CPWS Resting ECG, Non-Interpretive & ABPM-6100S Module Bundle
101452	CPWS Resting ECG, Non-Interpretive, SpiroPerfect & ABPM-6100S Module Bundle
101455	CPWS Resting ECG, Interpretive, Plus SpiroPerfect & ABPM-6100S Module Bundle
703733	CPWS Quick Start Guide
SPIRO-NS	SpiroPerfect Module, CPWS w/out 3L calibration syringe, Includes: Sensor, Pressure Tubing, 4 Flow Transducers, Electronic Operator's Manual, Latest CPWS SW CD, 2 Training Posters & Quick Reference Card
SPIRO-S	SpiroPerfect Module, CPWS w/3L calibration syringe, Includes: Sensor, Pressure Tubing, 4 Flow Transducers, Electronic Operator's Manual, Latest CPWS SW CD, 2 Training Posters & Quick Reference Card

WELCH ALLYN SPIROMETER FLOW TUBES

26001-0000	Disposable Flow Tubes, SP-150/SP-160, 10/bx
26001-0001	Disposable Flow Tubes, SP-150/SP-160, 100/bx

WELCH ALLYN PNEUMOCHECK SPIROMETER ACCESSORIES

Easy to use. PnuemoCheck will automatically calculate and display the best effort and five most needed values on its LCD screen. For your records, the printer/charger will print the data in either flow/volume or volume/time formats in as little as 20 seconds. The printer/charger recharges the PnuemoCheck.

56100	Thermal Paper, 5 rl/bx, 12 bx/cs
56120	Pediatric Mouthpieces, 100/bg, 5 bg/cs
56121	Adult Mouthpieces, 100/bg, 5 bg/cs
56130	Disposable Nose Clips, 100/bg, 4 bg/cs
61030	3-L Calibration Syringe & Hose
72500	7.2-V Rechargeable Batteries (2) - Replacement

NDD EASYONE™ DIAGNOSTIC SPIROMETRY SYSTEM

Ultrasonic flow measurement assures fast, accurate, reliable results. No moving parts, No codes to enter. Single patient use spirette has hygienic mouthpiece that reduces risk of cross infection. Alpha numeric keypad/graphic display makes navigation and data entry fast and easy. Graphic curve display allows to review curves without waiting for a printout. Meets ATS 1994 diagnostic standards. Meets NIOSH/OSHA and SSD guidelines. Customizable configuration. Automated coaching messages and QC. Automated interpretation. Two AA batteries. Stores up to 700 test sessions. Optional 8.5 x 11 or A4 printout. PC data transfer. Toll free technical support. Three-year exchange warranty. If your spirometer fails, we will replace if overnight without charge. Extended warranties are activated upon receipt of end-user information and must be received within six months of invoice date.

1000-1	EasyOne™ Diagnostic Spirometry System II Includes: #2001-2 Diagnostic Spirometry System I, #3104-4 Four Year Extended Warranty, #2040-2 EasyWare Software, #2050-1 Case of 50 Spirettes™
2000-1	EasyOne™ Frontline Spirometer Includes: Calibration Adapter & 10 Spirettes™
2000-2	EasyOne™ Frontline Spirometry System Includes: #2000-1 Frontline Spirometer, #2010-4 Cradle, #2020-1Color InkJet Printer
2000-2EW	EasyOne™ Diagnostic Spirometry System Includes: #2000-1 Frontline Spirometer, #2010-4 Cradle, #2040-2 EasyWare Software
2001-1	EasyOne™ Diagnostic Spirometer Includes: Calibration Adapter & 10 Spirettes™
2001-2	EasyOne™ Diagnostic Spirometry System I Includes: #2001-1 Diagnostic Spirometer, #2010-4 Cradle, #2020-1Color InkJet Printer
2001-2EW	EasyOne™ Diagnostic Spirometry System 1 Includes: #2001-1 Diagnostic Spirometer, #2010-4 Cradle, #2040-2 EasyWare Software
2010-4	EasyOne™ Cradle Includes: USB Cable
Accessories	
2030-4	Nose Clips, 25/bg

NDD EASYONE™ DIAGNOSTIC SPIROMETRY SYSTEM ACCESSORIES

2000-2NP	EasyOne™ Frontline Spirometry System Includes: #2000-1 Frontline Spirometer, #2010-4 Cradle, Does not include Printer
2001-2NP	EasyOne™ Diagnostic Spirometry System I Includes: #2001-1 Diagnostic Spirometer, #2010-4 Cradle, Does not include Printer
2001-2S	EasyOne™ Screen Spirometry System Includes: #2001-1 Diagnostic Spirometer, 2010-6S, EasyOne screen
2010-6S	EasyOne™ Screen, Includes: Screen Connector & #2040-2 EasyWare
2020-1	Color InkJet Printer
2030-1	Calibration Adapter for Spirometer Serial #'s Below 46000
2030-2	3-Liter Calibration Syringe
2030-3	Calibration Adapter for Spirometer Serial #'s 46000 and above
2031-1	EasyOne™ Carry Case
2040-1	EasyWare Software for use with Parallel/Serial Cradle #2010-1
2040-2	EasyWare Software for use with USB Cradle p/n 2010-4
2050-1	Spirettes™, 50/cs
2050-5	Spirettes™, 200/cs
2060-2	Parallel Cable
3101-1	1 Year Warranty Extension EasyOne™ Diagnostic Spirometer (cradle included at no charge) *Extended Warranties are activated upon receipt of end-user information and must be received within 6 months of invoice date.
3101-2	2 Year Warranty Extension EasyOne™ Diagnostic Spirometer (cradle included at no charge) *Extended Warranties are activated upon receipt of end-user information and must be received within 6 months of invoice date.
3101-3	3 Year Warranty Extension EasyOne™ Diagnostic Spirometer (cradle included at no charge) *Extended Warranties are activated upon receipt of end-user information and must be received within 6 months of invoice date.
3101-4	4 Year Warranty Extension EasyOne™ Diagnostic Spirometer (cradle included at no charge) *Extended Warranties are activated upon receipt of end-user information and must be received within 6 months of invoice date.
3105-1	1 Year Warranty Extension EasyOne™ Frontline Spirometer (cradle included at no charge) *Extended Warranties are activated upon receipt of end-user information and must be received within 6 months of invoice date.
3105-2	2 Year Warranty Extension EasyOne™ Frontline Spirometer (cradle included at no charge) *Extended Warranties are activated upon receipt of end-user information and must be received within 6 months of invoice date.
3105-3	3 Year Warranty Extension EasyOne™ Frontline Spirometer (cradle included at no charge) *Extended Warranties are activated upon receipt of end-user information and must be received within 6 months of invoice date.
3105-4	4 Year Warranty Extension EasyOne™ Frontline Spirometer (cradle included at no charge) *Extended Warranties are activated upon receipt of end-user information and must be received within 6 months of invoice date.

GE MEDICAL DISPOSABLE AIRWAY FLOW SENSORS

No sensor calibration required. Minimal dead space, Auto-zero feature. Single patient use reduces risk of patient cross-contamination. Combination CO2 sensor also monitors EtCO2. Latex free.

420687-002	Airway Flow Sensor, Ped/Adult, 10/cs
420687-003	Airway Comb/CO2 Flow Sensor, Ped/Adult, 10/cs

GE MEDICAL DINAMAP® PROCARE PATIENT MONITORS

More than 3 million times every single day critical patient care decisions are made based on blood pressure determinations using DINAMAP® technology. With the ProCare Series, you can take BP measurements that are fast, accurate and comfortable. Get reliable temperature readings in seconds and get oxygen saturation readings with your choice of leading SpO2 technologies.

DPC220X-US	DINAMAP ProCare 220 Monitor, NIBP, Heart Rate, IVAC® TurboTemp®, & Printer; Typical Accessories Included At No Additional Charge; Two (2) Year Parts & Labor Warranty
DPC320N-US	DINAMAP ProCare 320 Monitor w/Nellcor SpO2, NIBP, Heart Rate, Nellcor® OxiMax® SpO2 & Printer; Typical Accessories Included At No Additional Charge; Two (2) Year Parts & Labor Warranty

Accessories

633178CR	12 Volt Lead Acid Battery For Use w/DPC420N-US
----------	--

GE MEDICAL MONITOR POLES & MOUNTS

For securing DINAMAP monitors. 1" steel pole.

2009762-001	Pole Mount For GE DINAMAP ProCare
CR-0008-01	Wall Mount, Channel, Pivot, Swivel & Mounting Plate For GE DINAMAP PRO 100-400 Series
CR-0013-02	Wall Mount, Channel, Pivot, Swivel & Mounting Plate For GE DINAMAP PRO 1000



GE MEDICAL DINAMAP TEMPERATURE PROBES & PROBE COVERS

Reusable temperature probes. Accurate temperature reading. Probe covers reduce potential for cross-contamination between patients. Latex free.

088012	Oral Temperature Probe, Blue
088015	Electronic Probe Cover, 20/bx, 250 bx/cs
088016	Rectal Temperature Probe, Red
2008774-001	TurboTemp Oral Probe, Blue
2008775-001	TurboTemp Rectal Probe, Red

GE MEDICAL BLOOD PRESSURE TUBING

107363	12 ft Adult/Pediatric Air Hose, Gray, Submin
107365	Air Hose, Adult-Pediatric, 12' Gray Shroud to Screw Connector
107366	Air Hose, Adult-Pediatric, 24' Gray Shroud to Screw Connector
107368	Air Hose, Neonatal, 12' Gray Shroud to Female Slip Luer, Lt Blue
414876-001	Blood Pressure Tubing Adult/Ped Cuffs, Use w/Dash & Tram Modules
9461-216	Dual Tube BP Tubing, Dual Connector for Monitor, Single Female Connector for Single Lumen Cuffs, Rectangular Connector, 12', Use w/Eagle 3000, Dash, Tram or Solar
9461-217	Blood Pressure Tubing Plug, Male Luer, Rectangle Connector, Screw Connectors for Critikon Cuffs
9461-218	Blood Pressure Tubing Plug, Female Luer, Round Connector

GE MEDICAL CRITIKON CLASSIC-CUF® BLOOD PRESSURE CUFFS

Easy to fit, easy to clean, the original Critikon blood pressure cuff remains a time-tested favorite with healthcare professionals worldwide. Durable, easy cleaning vinyl construction. Strong enough for repeated inflations. Economical enough for single-patient use.

2357	Adult, 23-33cm Circumference, 2-Tube Sub-min, Navy/White, 20/bx
2358	Large Adult, 31-40cm Circumference, 2-Tube Sub-min, Rose/White, 20/bx

GE MEDICAL CRITIKON DURA-CUF® BLOOD PRESSURE CUFFS

Gentle nylon, strong enough for repeated inflation. Reusable. Convenient and easy to clean. Color-coded by size. Sized to meet AHA, AAMI/ANSI/SP9 and EN1060 requirements. Easy-to-use range markers and index line. Extra hook and loop. Latex free, PVC-free.

002297	Adult Assorted, Includes: (1) Small Adult, (2) Adult, (1) Adult Long, (1) Large Adult, (1) Large Adult Long, 2-Tube, Sub-Miniature, 6/bx
002299	Assorted, 2-Tube Sub-Miniature, Includes 1 Each: Infant, Child Small/Regular/Large; Adult; Thigh, 6/bx
002697	Child Assorted, 2-Tube Screw Connector, Assorted Colors, Includes: (2) Infant, (3) Child, (1) Small Adult, 2-Tube Screw, 6/bx
002698	Adult Assorted, 2-Tube Screw, Includes: (1) Small Adult, (2) Adult, (1) Adult Long, (1) Large Adult, (1) Large Adult Long, 6/bx
002699	Assorted, 2-Tube Screw, Includes: (1) Infant, (1) Child, (1) Small Adult, (1) Adult, (1) Large Adult, (1) Thigh, 6/bx
002774	Adult Blood Pressure Cuff, 2-Tube Screw, Navy, 23-33cm, 5/bx
002781	Child Blood Pressure Cuff, 2-Tube Screw, Green, 12-19cm, 5/bx
002783	Infant Blood Pressure Cuff, 2-Tube Screw, Rust, 8-13cm, 5/bx
002791	Large Adult Blood Pressure Cuff, 2-Tube Screw, Wine, 31-40cm, 5/bx

GE MEDICAL CRITIKON SENA-CUF® BLOOD PRESSURE CUFFS

Extra strong, extra sensitive, highly versatile solution for a wide range of extended-care settings. Designed to maximize patient comfort. Soft, breathable, easy-to-clean material. Durable enough for multi-patient use. Economical enough for single-patient use.

2464	Adult, 23-33cm Circumference, 2-Tube Screw-Connector, Navy/Gray, 5/bx
2466	Large Adult, 31-40cm Circumference, 2-Tube Screw-Connector, Navy/Gray, 5/bx

GE MEDICAL CRITIKON SOFT-CUF® BLOOD PRESSURE CUFFS

The ultimate in patient comfort, Soft-Cuf® solutions are designed to help you maintain high-quality care and patient satisfaction. Soft, absorbent material with rounded corners enhances patient comfort. Economical enough for pairing with single patient throughout hospital stay. Single patient use increases infection control at an affordable price.

2404	Adult, 23-33cm Circumference, 2-Tube Sub-min, Navy/White, 20/bx
2405	Large Adult, 31-40cm Circumference, 2-Tube Sub-min, Rose/White, 20/bx

GE MEDICAL UTILITY BASKET

Made of steel.

WM-0001-02C	Utility Basket For GE DINAMAP Pro 100-400 Series
-------------	--

GE MEDICAL ROLLING STANDS

Offers mobility for our DINAMAP monitors. Rollerblade wheels provide smooth movement over multiple surfaces. 1" steel pole. Latex free.

2032382-001	Rolling Stand For GE DINAMAP Pro Series
2033297-001	Rolling Stand w/pole mount, Includes Basket, ProCare

Accessories

107476	Rolling Stand w/basket for DINAMAP Pro 1000
--------	---

GE MEDICAL CARESCAPE™ V100 VITAL SIGN MONITOR

This monitor can go with you from one patient to the next, enabling you to capture vital signs on all your patients using a single, mobile vital signs monitor. With speed, accuracy and connectivity, it helps you manage Clinical Information Logistics™ by collecting the right information at the point of care, and presenting it wherever it is needed. So you can make fast, quality care decisions informed by relevant, current clinical intelligence.

V100-ABAX-AXAA-XX	Vital Sign Monitor w/Temp Printer, SuperStat NIBP, Alaris Turbo Temp, Language: English, Power Cord: US, Bracket: Standard
V100-BBAX-AXAA-XX	Vital Sign Monitor w/Temp No Printer, SuperStat NIBP, Alaris Turbo Temp, Language: English, Power Cord: US, Bracket: Standard
V100-CBXX-AXAA-XX	Vital Sign Monitor, No Temp, No Printer, w/SuperStat NIBP, Language: English, Power Cord: US, Bracket: Standard
V100-DBXX-AXAA-XX	Vital Sign Monitor w/Printer, No Temp, w/SuperStat NIBP, Language: English, Power Cord: US, Bracket: Standard
V100-EBAD-AXAA-XX	Vital Sign Monitor w/Printer/Temp/DO, w/SuperStat NIBP, Alaris Turbo Temp, SpO2 Cable: Ohmeda, Language: English, Power Cord: US, Bracket: Standard
V100-FBXD-AXAA-XX	Vital Sign Monitor w/Printer/No Temp/DO, w/SuperStat NIBP, SpO2 Cable: Ohmeda, Language: English, Power Cord: US, Bracket: Standard
V100-GBAD-AXAA-XX	Vital Sign Monitor No /Printer w/Temp/DO, w/SuperStat NIBP, Alaris Turbo Temp, SpO2 Cable: Ohmeda, Language: English, Power Cord: US, Bracket: Standard
V100-HBXD-AXAA-XX	Vital Sign Monitor No Printer No Temp w/DO, w/SuperStat NIBP, SpO2 Cable: Ohmeda, Language: English, Power Cord: US, Bracket: Standard
V100-JBAC-AXAA-XX	Vital Sign Monitor w/Printer/Temp/Masimo, w/SuperStat NIBP, Alaris Turbo Temp, SpO2 Cable: Masimo LNCS, Language: English, Power Cord: US, Bracket: Standard
V100-KBXC-AXAA-XX	Vital Sign Monitor w/Printer/No Temp/Masimo, w/SuperStat NIBP, SpO2 Cable: Masimo LNCS, Language: English, Power Cord: US, Bracket: Standard
V100-LBAC-AXAA-XX	Vital Sign Monitor No Printer w/Temp/Masimo, w/SuperStat NIBP, Alaris Turbo Temp, SpO2 Cable: Masimo LNCS, Language: English, Power Cord: US, Bracket: Standard
V100-MBXC-AXAA-XX	Vital Sign Monitor NoPrinter No Temp w/Masimo, w/SuperStat NIBP, SpO2 Cable: Masimo LNCS, Language: English, Power Cord: US, Bracket: Standard
V100-NBAA-AXAA-XX	Vital Sign Monitor w/Printer/Temp/NellCore, w/SuperStat NIBP, Alaris Turbo Temp, SpO2 Cable: Nellcore, Language: English, Power Cord: US, Bracket: Standard
V100-NBAA-AXAX-XX	Monitor w/printer, Temp & Nellcor SPO2, SuperStat NIBP Blood Pressure, Alaris Turbo Temp, Nelcor Cable & Sensor, English Language Kit, US IEC Line Cord, No Mount
V100-PBXA-AXAA-XX	Vital Sign Monitor w/Printer/No Temp/NellCore, w/SuperStat NIBP, SpO2 Cable: Nellcore, Language: English, Power Cord: US, Bracket: Standard
V100-QBAA-AXAA-XX	Vital Sign Monitor No Printer w/Temp/NellCore, w/SuperStat NIBP, Alaris Turbo Temp, SpO2 Cable: Nellcore, Language: English, Power Cord: US, Bracket: Standard

GE MEDICAL DASH 2500 PATIENT MONITORS

Provides flexibility in a single platform. With a comprehensive set of clinical parameters, the monitors capture vital patient measurements while sophisticated algorithms help prevent false alarms. Highly configurable, enabling you to add features and parameters accommodating varying acuity levels for patients across the entire care continuum. From presentation in the Emergency Department to surgery in the OR to recovery in the PACU, treatment in the ICU and transfer to the Stepdown unit, the monitor is the right choice for every point of care.

DASH3-AEAG-AAXX-XAXX	DASH3 Includes: 8.4" Color Display, ECG, Nelcore SPO2, Dinamap BP Temperature & CO2
DASH3-AEAG-AAXX-XXXX	DASH3 Includes: 8.4" Color Display, ECG, Nelcore SPO2, Dinamap BP & Temperature
DASH4-AEAG-AAXX-XAXX	DASH4 Includes: 10.4" Color Display, ECG, Nelcore SPO2, Dinamap BP Temperature & CO2
DASH4-AEAG-AAXX-XXXX	DASH4 Includes: 10.4" Color Display, ECG, Nelcore SPO2, Dinamap BP & Temperature
DSH25-AAAA-AAXX	DASH2500 Includes: 10.4" Display, Transport w/Masimo SpO2, ECG, NIBP, Standalone Non-Network Patient Monitor, Battery Inside, Turbo Temp, 2-Channel Integrated Thermal Printer, US Power Cord
DSH25-AAXA-AAXX	DASH2500 Includes: 10.4" Display, Transport w/Masimo SpO2, ECG, NIBP, Standalone Non-Network Patient Monitor, Battery Inside, Turbo Temperature, US Power Cord
DSH25-AXAA-AAXX	DASH2500 Includes: 10.4" Display, Transport w/Masimo SpO2, ECG, NIBP, Standalone Non-Network Patient Monitor, Battery Inside, 2-Channel Integrated Thermal Printer, US Power Cord
DSH25-AXXA-AAXX	DASH2500 Includes: 10.4" Display, Transport w/Masimo SpO2, ECG, NIBP, Standalone Non-Network Patient Monitor, Battery Inside, US Power Cord
DSH25-BAAA-ACXX	DASH2500 Includes: 10.4" Display, Transport w/Nellcor SpO2, ECG, NIBP, Standalone Non-Network Patient Monitor, Battery Inside, Turbo Temp, 2-Channel Integrated Thermal Printer, US Power Cord
DSH25-BAXA-ACXX	DASH2500 Includes: 10.4" Display, Transport w/Nellcor SpO2, ECG, NIBP, Standalone Non-Network Patient Monitor, Battery Inside, Turbo Temperature, US Power Cord
DSH25-BXAA-ACXX	DASH2500 Includes: 10.4" Display, Transport w/Nellcor SpO2, ECG, NIBP, Standalone Non-Network Patient Monitor, Battery Inside, 2-Channel Integrated Thermal Printer, US Power Cord
DSH25-BXXA-ACXX	DASH2500 Includes: 10.4" Display, Transport w/Nellcor SpO2, ECG, NIBP, Standalone Non-Network Patient Monitor, Battery Inside, US Power Cord

We offer:

- Great Service
- Great Pricing
- Great Products



98-0128-00



98-0129-00



99-0061-00



99-0065-00



99-0066-00



99-0067-00



99-0068-00



99-0069-00

SUNTECH 247 DIAGNOSTIC SYSTEMS

Expandable Diagnostic Station with BP, Temperature & SpO₂. Start with Blood Pressure & add additional parameters as needed.

98-0128-00	247 Temperature Module
98-0129-00	247 SpO ₂ Module
99-0061-00	247 Battery Mobile System, BP, Temperature, SpO ₂
99-0062-00	247 Battery Mobile System, BP
99-0063-00	247 Battery Mobile System, BP, Temperature
99-0064-00	27 Battery Mobile System, BP, SpO ₂
99-0065-00	247 Wall System, BP, Temperature, SpO ₂
99-0066-00	247 Wall System, BP
99-0067-00	247 Wall System, BP, Temperature
99-0068-00	247 Wall System, BP, SpO ₂
99-0069-00	247 Tabletop System, BP, Temperature, SpO ₂
99-0070-00	247 Tabletop System, BP
99-0071-00	247 Tabletop System, BP, Temperature
99-0072-00	247 Tabletop System, BP, SpO ₂

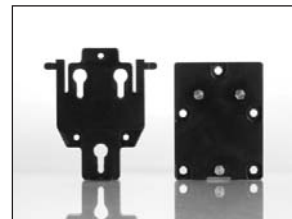

98-0148-00



98-0149-00



98-0150-00

SUNTECH MISCELLANEOUS ACCESSORIES

17-0014-00	Battery, Lead Acid, 6V 4.5A, Sealed, Rechargeable
19-0013-00	Power Supply, 6V
19-0014-00	Power Supply, 9V @ 1.7A, Negative To System Ground
80-0041-00	247 Service Manual
91-0003-00	Power Cord, USA Hospital Grade
91-0097-00	247 BP Cable
98-0030-02	247 BP Calibration Check Kit
98-0148-00	247 Wall Mount Kit & Basket
98-0149-00	247 Tabletop Stand
98-0150-00	247 Basket
98-0154-00	247 Mobile Stand & Basket
98-0156-00	BP Calibration Set

SUNTECH 247 PULSE OXIMETRY ACCESSORIES

52-0005-00	Adult Digit Reusable Oximetry Sensor (2010)
52-0005-01	Y Multi-site Reusable Oximetry Sensor (2210)
52-0005-02	Adult Digit Disposable Oximetry Sensor (3311), 24/bx
52-0005-03	Pediatric Digit Disposable Oximetry Sensor, (3312), 24/bx
52-0005-04	6-foot Extension Cable (2411)
52-0005-05	10-foot Extension Cable (2421)



52-0004-00

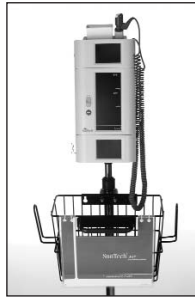

98-0155-00

SUNTECH FILAC FASTEMP THERMOMETRY

- 52-0004-00 Blue Oral/Axillary Probe
- 52-0004-01 Red Rectal Probe
- 52-0004-02 247 Temperature Calibration Plug
- 98-0131-01 Disposable Probe Covers 20/bx, 25 bx/cs
- 98-0146-00 247 Blue Oral/Axillary Temperature Probe Well
- 98-0147-00 247 Red Rectal Temperature Probe Well
- 98-0155-00 247 Temperature Kit, Red (Rectal)



98-0084-22



98-0084-23



98-0084-24



98-0084-25



98-0084-26



98-0084-27



98-0084-28



98-0084-29



98-0084-30

SUNTECH 247 ALL PURPOSE - GENERAL CLINICAL USE CUFFS

Ranging From Infant to Thigh; our color-coded All Purpose cuffs are manufactured with easy to clean high quality nylon, which provides an outstanding combination of comfort and durability. These cuffs are easy to use and maintain in the widest variety of clinical applications. All of our cuffs are designed latex free, feature easily removable bladders to aid in washing and disinfecting, are in compliance with Council Directive 93/42/EEC Medical Devices Directive, and adhere to the recommendations in the AAMI SP10:2002.

- 98-0084-22 All Purpose Cuff, Child (12-19 cm)
- 98-0084-23 All Purpose Cuff, Child LONG (12-19 cm)
- 98-0084-24 All Purpose Cuff, Small Adult (17-25 cm)
- 98-0084-25 All Purpose Cuff, Small Adult LONG (17-25 cm)
- 98-0084-26 All Purpose Cuff, Adult (23-33 cm)
- 98-0084-27 All Purpose Cuff, Adult LONG (23-33 cm)
- 98-0084-28 All Purpose Cuff, Large Adult (31-40 cm)
- 98-0084-29 All Purpose Cuff, Large Adult LONG (31-40 cm)
- 98-0084-30 All Purpose Cuff, Thigh (38-50 cm)
- 98-0144-00 247 All Purpose Cuff Package, Adult, 4/pkg
- 98-0145-00 247 All Purpose Cuff Package, Pediatric, 4/pkg

WELCH ALLYN ATLAS MONITOR

A cost-effective monitor with all the parameters for conscious sedation procedures. Hard-working, easy-to-use, monitor with configuration options to meet your individual needs. All monitors include 3- or 5-lead ECG, Nellcor® pulse oximetry (SpO2), and NIBP. Optional parameters include temperature, respiration, EtCO2, and integrated printer. Bright, crisp waveforms and multicolored LED displays for across-the-room visibility. Simple, straightforward menu operation.

- 621N0-E1 Atlas Monitor w/ECG, Nellcor SpO2, NIBP
- 621NP-E1 Atlas Monitor w/ECG, Nellcor SpO2, NIBP & Printer
- 622NP-E1 Monitor with Printer
- 623NP-E1 Atlas Monitor w/ECG, Nellcor SpO2, NIBP, Temperature, Respiration, Battery, RS-232 & Printer
- 922N0-E1 Atlas Monitor w/ECG, Nellcor SpO2, NIBP, Temperature, Respiration, Battery & RS-232

Accessories

- 008-0370-00 Disposable Water Trap, 10/bx
- 008-0371-00 Disposable Water Trap, 24/bx

WELCH ALLYN PRINTER PAPER

- 6200-40 Printer Paper For Atlas Monitor, 25r/cs
- 94001-0000 Printer Paper For AT-1/Sp-1, 280 sht/pd, 10 pd/cs
- 94002-0000 Printer Paper For AT-2, 150 sheets/pad, 8 pads/cs
- 94010-0000 8.25" x 5.5" Printer Paper For AT10/Sp10, Red Grid, 150 sheets/pad, 10 pads/cs



4200B-E1



4200B-E1-M

WELCH ALLYN SPOT VITAL SIGNS

Standard non-invasive blood pressure (NIBP) as well as pulse rate and MAP. Large LCD display with backlight. Extremely user-friendly and easy to use. Uses the oscillometric method to determine systolic and diastolic pressure, MAP and pulse rate. Lightweight and portable: weights just 4 pounds. Training video included.

- 4200B-E1 Device w/BP, Domestic/English
- 4200B-E1-M Device w/BP & Mobile Stand, Domestic/English
- 420TB-E1 Device w/BP & Temperature, Domestic/English
- 420TB-E1-M Device w/BP & Temperature & Mobile Stand, Domestic/English

WELCH ALLYN SPOT VITAL SIGNS WITH NELLCOR

Standard non-invasive blood pressure (NIBP) as well as pulse rate and MAP. Large LCD display with backlight. Extremely user-friendly and easy to use. Uses the oscillometric method to determine systolic and diastolic pressure, MAP and pulse rate. Lightweight and portable: weights just 4 pounds. Training video included.

- 42N0B-E1 Device w/BP & Pulse Oximeter, Domestic/English
- 42N0B-E1-M Device w/BP & Pulse Oximeter, Mobile Stand, Domestic/English
- 42NTB-E1 Device w/BP, Pulse Oximeter & Temperature, Domestic/English
- 42NTB-E1-M Device w/BP, Pulse Oximeter, Temperature & Mobile Stand, Domestic/English

Patient Monitoring

WELCH ALLYN SPOT VITAL SIGNS WITH MASIMO

Standard non-invasive blood pressure (NIBP) as well as pulse rate and MAP. Large LCD display with backlight. Extremely user-friendly and easy to use. Uses the oscillometric method to determine systolic and diastolic pressure, MAP and pulse rate. Lightweight and portable: weights just 4 pounds. Training video included.

42M0B-E1	Device w/blood pressure & Masimo SpO2
42M0B-E1-M	Device w/blood pressure, Masimo SpO2, & Mobile Stand
42MTB-E1	Device w/blood pressure, Masimo SpO2, & SureTemp
42MTB-E1-M	Device w/blood pressure, Masimo SpO2, SureTemp, & Mobile Stand

WELCH ALLYN VITAL SIGNS MONITOR 300 SERIES

Non-invasive blood pressure (NIBP) pulse rate and MAP. Optional - SureTemp® Plus Thermometry, Masimo or Nellcor pulse oximetry and integrated thermal printer. Supports adult, pediatric and neonatal patients. Simple to use - LDC display facilitates menu navigation. Includes automatic blood pressure mode, programmable alarms, built-in memory capability and intuitive icons. Lightweight and portable with a variety of mounting options.

5300P-E1	Vital Signs Monitor 300 Series, NIBP, Printer, Ear Thermometer
530TP-E1	Vital Signs Monitor 300 Series, NIBP, Printer, SureTemp Plus Thermometer
53N00-E1	Vital Signs Monitor 300 Series, NIBP, Nellcor Pulse Oximetry
53N0P-E1	Vital Signs Monitor 300 Series, NIBP, Nellcor Pulse Oximetry, Printer
53NT0-E1	Vital Signs Monitor 300 Series, NIBP, Nellcor Pulse Oximetry, SureTemp Plus Thermometer
53NTP-E1	Vital Signs Monitor 300 Series, NIBP, Nellcor Pulse Oximetry, Printer, SureTemp Plus Thermometer

WELCH ALLYN MASIMO VITAL SIGNS MONITORS 300 SERIES

53S00-E1	Vital Signs Monitor w/NIBP, & Masimo SpO2
53S0P-E1	Vital Signs Monitor w/NIBP, Masimo SpO2, & Printer
53ST0-E1	NIBP/Masimo Pulse Oximetry/Temperature Monitor
53STP-E1	Vital Signs Monitor w/NIBP, & Masimo SpO2, SureTemp Plus Thermometry, & Printer



02678-000



05031-101

WELCH ALLYN SPOT VITAL SIGNS ACCESSORIES

02678-000	4 ft Cord w/Oral/Axillary Probe
02678-100	9 ft Cord w/Oral/Axillary Probe
02679-000	4 ft Cord w/Rectal Probe
02679-100	9 ft Cord w/Rectal Probe
05031-101	Disposable Probe Covers, 1000/cs
05031-110	Probe Covers For Use w/M031, Clear, Bulk Packaging, 10,000/cs
06137-000	Calibration Key For 767T, M678, M679
4200-100	Carrying Case
4200-60	Mobile Stand
4200-62	Wall Mount
4200-64	IV Pole Mount
4200-70	Anti-Theft Kit
4200-84	Lead Acid Battery, 6V
4200-M0B	Warranty, 1 Year Extended for Model 42M0B
4200-MTB	Warranty, 1 Year Extended for Model 42MTB
5200-01	Adult Cuff Assembly, Latex Free (Cuff, Bladder & Connector)
5200-02	Large Adult Cuff Assembly, Latex Free (Cuff, Bladder & Connector)
5200-03	Child Print Cuff Assembly, Latex Free (Cuff, Bladder & Connector)
5200-10	Thigh Cuff Assembly, Latex Free (Cuff, Bladder & Connector)
D-YSPD	Pedicheck Pediatric Spot Check

Accessories

01802-110	Welch/Braun Black Body Calibration Device
-----------	---

WELCH ALLYN SPOT VITAL SIGNS LXI

SureBP™ technology measures blood pressure in about 15 seconds as the cuff as inflating — resulting in time savings for you and improved comfort for your patients, pulse rate and MAP included. Ability to manually enter weight, height, respiration rate, and pain level; calculates Body Mass Index. 50-reading memory allows retrieval of previous data for review, to print or to download later. Connectivity-ready. Error messages give you descriptions and real solutions — not just error codes. Bigger, brighter LCD display provides greater visibility from farther distances.

450T0-E1	Spot Vital Signs LXI w/SureBP & SureTemp Plus Thermometer
45NE0-E1	Spot Vital Signs LXI w/SureBP, Nellcor SpO2 & Braun ThermoScan 400 Ear Thermometer
45NT0-E1	Spot Vital Signs LXI w/SureBP, Nellcor SpO2 & SureTemp Plus Thermometer

WELCH ALLYN SPOT VITAL SIGNS LXI WITH MASIMO

45ME0-E1	Spot Vital Signs Lxi w/SureBP, Masimo SpO2, & Braun ThermoScan, Pro 4000 Thermometry
45MT0-E1	Spot Vital Signs Lxi w/SureBP, Masimo SpO2, & SureTemp Plus Thermometry

WELCH ALLYN VITAL SIGNS MONITOR III

530T0-E1	Vital Signs Monitor III with NIBP and Temperature, English, 110 Volt, USA
----------	---

WELCH ALLYN SPOT VITAL SIGNS/SPOT MASIMO ACCESSORIES

008-0654-00	LNOP Pediatric/Slender Digit SpO2 Sensors, Disposable, 20/cs
008-0953-00	Ear Sensor, Reusable, (LNOP-TCI)
4200-350	Accessory Kit Pediatric: (Small Child, Child, Small Adult) Cuffs & Masimo SpO2
LNC-10-WA	Cable, 10' w/DB-9 connector for LNCS
LNC-4-WA	Cable, 4' w/DB-9 connector for LNCS
LNCS-ADTX	Sensor, Finger, Adhesive, Adult, 20/cs
LNCS-DCI	Sensor, Finger, Reusable, Adult
LNCS-DCIP	Sensor, Finger, Reusable, Pediatric
LNCS-INF-L	Sensor, Finger, Adhesive, Infant, 20/cs
LNCS-PDXTX	Sensor, Finger, Adhesive, Pediatric, 20/cs
LNOP-ADT	Finger Sensor, Adhesive, Adult, 20/cs
LNOP-DCI	Finger Sensor, Reusable, Adult
LNOP-DCIP	Finger Sensor, Reusable, Pediatric
LNOP-INF-L	Sensor, Finger, Adhesive, Infant, 20/cs
LNOP-NEO	Finger Sensor, Adhesive, Disposable, Neonate, 20/cs
LNOP-NEOPT	Finger Sensor, Sensitive Skin, Adhesive, Disposable, Neonate, 20/cs
LNOP-PDT	Finger Sensor, Adhesive, Pediatric, 20/cs
PC-04	Cable 4' w/sensor connector for Spot Lxi, & Vital Signs Monitor
PC-04-WA	Cable, 4' w/DB-9 connector for LNOP
PC-08	Cable 8' w/sensor connector for Spot LXI, & Vital Signs Monitor
PC-08-WA	Cable, 8' w/DB-9 connector for LNOP
PC-12	Cable 12' w/sensor connector for Spot Lxi, & Vital Signs Monitor

WELCH ALLYN AMBULATORY BLOOD PRESSURE MONITOR

Simple one-button operation improves compliance. Lightweight, small, and quiet. Powerful Windows® based software intuitive, user-friendly. Oscillometric technology allows easy patient hook-up and is comfortable for the patient with unparalleled accuracy. Report content can easily be tailored to meet your practice needs. 100% latex-free cuffs reduce the risk of allergic reactions. Meets or exceeds the latest AAMI, EHS, and BHS standards. 2 Year Warranty. Includes Welch Allyn CardioPerfect™ Workstation Software.

ABPM-6100	ABPM-6100 Recorder w/standard accessories (1 Adult Sleeve Cuff, Computer Interface Cable, USB to Serial Adapter, Reusable Pouch & Straps, 2 AA Batteries & 10 Patient Diaries). No Software Included
ABPM-6100S	Ambulatory Blood Pressure Monitor System, Includes CPWS ABPM SW Module & 1 ABPM-6100 Recorder w/standard accessories (1 Adult Sleeve Cuff, Computer Interface Cable, USB to Serial Adapter, Reusable Pouch & Straps, 2 AA Batteries & 10 Patient Diaries)

**WELCH ALLYN AMBULATORY BLOOD PRESSURE MONITOR ACCESSORIES**

101340	ABPM-6100 Sleeve Cuff, Small Adult (18-27cm), Reusable
101341	ABPM-6100 Sleeve Cuff, Adult (25-35cm), Reusable
101342	ABPM-6100 Sleeve Cuff, Adult Plus (33-40cm), Reusable
101343	ABPM-6100 Sleeve Cuff, Large Adult (39-46cm), Reusable
101490	ABPM-6100 Sleeve Cuff Kit Includes: 1 Small Adult (18-27cm), 1 Adult Plus (33-40cm) & 1 large Adult (39-46cm), Reusable
5082-174	Replacement Connector for ABPM Recorder, BP Fitting, Female Screw Type 5/32 Tube, 10/pk
5100-30	Microphone/Pneumatic Tubing Assembly
5100-31	Large Cuff & Pneumatic System Assembly
5100-34	Large Cuff & Bladder
5100-35	Medium Cuff & Bladder
5100-41E	Patient Hook-Up Kit, 25/bx
5100-42E	Patient Diary, 50/bx
5100-44	Cuff Anchoring Pads, 50/bx
5100-46	Carrying Pouch
5100-47	Waist Belt
5100-48	Shoulder Strap
6100-21	ABPM-6100 Pouch, Black
6100-22	ABPM-6100 Shoulder Strap Black
6100-23	ABPM-6100 Waist Belt Black
6100-24	ABPM-6100 PC Interface Cable
6100-25	ABPM-6100 Y Calibration Fitting
6100-26	ABPM-6100 Clamshell Storage Case

**BURDICK AMBULATORY BLOOD PRESSURE SYSTEMS BY CARDIAC SCIENCE**

Our ABP monitors are among the smallest and lightest weight on the market today, with advanced reporting software that allows rapid analysis of patient information. Extensive testing by independent clinicians has validated ABPM accuracy time and time again, making them widely recognized and the "gold standard" for ABP. Both the 90217 Ultralite and 90207ABP monitors feature a compact, lightweight design that optimizes patient comfort—a key factor in successful ABP monitoring. Comfort helps ensure patient compliance and, consequently, may decrease the number of artifactual readings. Collects measurements for a period of 24 hours or up to 8 days. Lightweight recorder operates quietly for patient comfort. Oscillometry measures systolic, diastolic and mean blood pressure. No chest electrodes or microphones reduce operatory costs. Uses a real-time clock to facilitate diary notations.

143265	Burdick ABP Monitor
90217-1Q	Burdick Ultralite ABP Monitor w/Quick Connect, English

BURDICK AMBULATORY BLOOD PRESSURE SYSTEM ACCESSORIES BY CARDIAC SCIENCE

000-0027-02	Patient Diary For ABP
006-0210-02	Thermal Paper for 90239A ABP Report Generator, 57mm x 32, 6 r/bx
012-0034-03	90239-80 Interface Cable (90239-80 to PC Serial Port)
012-0096-01	Modem Interface Cable (ABP Monitor to Modem)
012-0097-02	ABP Interface Cable (ABP Monitor to PC)
012-0105-02	Base Station Interface Cable (PC to Modem)
015-0067-01Q	Small Adult 17-26cm, Quick Connect
015-0068-02Q	Standard Adult 24-32cm, Quick Connect
015-0070-00	Cuff Support Harness For All Cuffs
015-0118-01Q	Child 12-20cm, Quick Connect
016-0077-01Q	Large Adult Cuff, 32-42cm, Quick Connect
016-0080-00	Waist Belt for ABP
016-0109-01Q	XL Adult Cuff, 38-50cm (includes cuff support harness), Quick Connect
016-0262-00	Strap For Use w/vinyl pouch for model 90207 ABP
016-0340-00	Cloth Pouch for Model 90217 ABP
016-0410-00	Cloth Pouch for Model 90207 ABP (SL logo)
146-0008-00	Lithium Battery, 3-Volt, For Use w/90207 ABP

**Fast, easy access to
the products you need.**



BCI MINI-TORR PLUS® NON-INVASIVE BLOOD PRESSURE MONITOR

Provides a base to build on for your monitoring needs. Offers cost-effective, non-invasive blood pressure monitoring. Options which can be added include pulse oximetry, a built-in printer, oral or rectal temperature, and/or a lightweight roll stand or IV pole mount. The ability to combine the options needed in your clinical environment at an affordable price, makes this monitor an important addition to your equipment needs.

- 6004-000 Mini-Torr Plus® NIBP Monitor
- 6004-001 Mini-Torr Plus® NIBP/Oximeter
- 6004-002 NIBP/Oximeter System w/serial autocorrelation (SAC) Technology
- 6004-003 NIBP/Oximeter System w/Nellcor Technology
- 6004-004 Mini-Torr Plus® NIBP/Electronic Thermometry
- 6004-005 Mini-Torr Plus® NIBP/Printer
- 6004-006 Mini-Torr Plus® NIBP/Oximeter/Printer
- 6004-007 NIBP/Oximeter/Printer System w/SAC Technology
- 6004-008 NIBP/Oximeter/Printer System w/Nellcor Technology
- 6004-009 Mini-Torr Plus® NIBP/Electronic Thermometry/Printer
- 6004-010 NIBP/SPO₂ Electronic Thermometry w/serial autocorrelation (SAC) Technology
- 6004-011 Mini-Torr Plus® NIBP/SpO₂/Electronic Thermometry
- 6004-012 NIBP/SPO₂ Electronic Thermometry w/Nellcor Technology
- 6004-013 Mini-Torr Plus® NIBP/SpO₂/Thermometry/Printer
- 6004-014 NIBP/SPO₂/Electronic Thermometry/Printer w/SAC Technology
- 6004-015 NIBP/SPO₂/Electronic Thermometry/Printer w/Nellcor Technology

WELCH ALLYN KLENSPEC® 790 SERIES ILLUMINATOR SYSTEM

LED: Provides brighter, whiter light, provides enhanced visualization, no heat, no lamp replacement and 5500 degree Kelvin providing true tissue color rendition. Automatic On/Off: for convenient auto on/off when inserted into the specula. Superior Illumination: Results in no glare back/uniform spot. Cordless & Rechargeable: Means no cord to get in the way during procedures, continuous on time of 80 minutes, recharge time 6 hours, lithium ion battery technology.

- 79900 Specula, Vaginal, Disposable, Cordless Illuminator, Kleenspec®
- 79910 Specula, Vaginal, Disposable, Cordless Illuminator w/charging station, Kleenspec®
- 79920 Specula, Vaginal, Disposable, Cordless Illuminator w/charging station, & Auxiliary Power Cord, Kleenspec®

Accessories

- 73910 Charging Station for Cordless Illuminator
- 75910 Auxiliary Power Cord for Cordless Illuminator

Fast, easy access to
the products you need.



WELCH ALLYN KLENSPEC® DISPOSABLE VAGINAL SPECULA ILLUMINATION SYSTEM

Permanent light carrier projects intense beam of light through plastic light guide. No external light source necessary.

- 78810 Complete Vaginal Specula Illumination System w/on-off switch & transformer

Accessories

- 73305 Transformer w/5 ft cord, 110-130V, 50/60 Hz
- 73410 Transformer w/5 ft cord, 110-130V, 50/60 Hz, UL Listed, CSA Certified
- 78800 Permanent 6V Halogen Light Handle w/on-off switch



58600



78600

WELCH ALLYN KLENSPEC® VAGINAL SPECULA

Brilliant halogen illumination system allows diagnostic accuracy. Clear, polystyrene construction. Designed for one-hand operation. Single-use prevents cross-contamination. Expendable light carrier for safety. (Illumination system not included.)

- 58600 Small Specula, 25/bx, 4 bx/cs
- 58601 Medium Specula, 25/bx, 4 bx/cs
- 78600 Expendable Illuminator (can be resterilized 50 times before disposal), 6/bx, 6 bx/cs

WELCH ALLYN KLENSPEC® 590 SERIES DISPOSABLE VAGINAL SPECULA

Scalloped end of light pipe eliminates dark spots, hot spots and GREATLY reduces glare back. Wider handle provides improved ergonomics. 590 Series KlenSpec Vaginal Specula is compatible with the new illuminator system (79910) as well as the current illuminator (78810).

- 59000 Specula, Vaginal, Small, Kleenspec®, 24/bx, 4 bx/cs
- 59000-B Specula, Vaginal, Small, Kleenspec®, 24/bx
- 59001 Specula, Vaginal, Medium, Kleenspec®, 24/bx, 4 bx/cs
- 59001-B Specula, Vaginal, Medium, Kleenspec®, 24/bx
- 59004 Specula, Vaginal, Large, Kleenspec®, 19/bx, 4 bx/cs
- 59004-B Specula, Vaginal, Large, Kleenspec®, 19/bx
- 59005 Specula, Vaginal, w/smoke tube, Small, Kleenspec®, 11/bx, 4 bx/cs
- 59006 Specula, Vaginal, w/smoke tube, Medium, Kleenspec®, 11/bx, 4 bx/cs



WELCH ALLYN KLEENSPEC® 580 DISPOSABLE VAGINAL SPECULA WITH BARRIER

Superior halogen illumination for a whiter, brighter light for truer tissue color rendition. Smooth, one-handed angulation and elevation mechanism with positive locking positions. Light handle is completely sealed when inserted into the speculum. Built-in reservoir prevents fluids from contaminating the outside of the speculum handle. Optional disposable sheath covers the exposed sections of the light handle and cord, virtually eliminating the threat of cross-contamination.

58010 Disposable Sheaths, 25/bx, 5 bx/cs

WELCH ALLYN KLEENSPEC® 580 SERIES DISPOSABLE VAGINAL SPECULA

Halogen light for true tissue color and consistent, long lasting illumination. Disposable for economy, safety and convenience. One-hand operation with angulation and elevation for convenience. Especially narrow blade width available for adolescent and geriatric patients. Individually wrapped specula. Pederson style.

- 58000S Small Specula w/sheath, 20/bx, 4 bx/cs
- 58000S-B Small Specula w/sheath, 20/bx
- 58001S Medium Specula w/sheath, 20/bx, 4 bx/cs
- 58001S-B Medium Specula w/sheath, 20/bx
- 58004S Large Specula w/sheath, 15/bx, 4 bx/cs

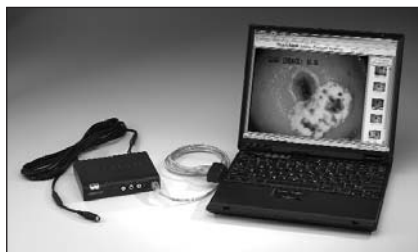

WELCH ALLYN IMAGE CAPTURE SYSTEM FOR VIDEO COLPOSCOPE

A unique software-based documentation system to be used with the Welch Allyn video colposcope. The software can be controlled remotely from the Video Colposcope and enables the user to capture, reiview, store, print and export impages.

- 88801 Image Capture System For Desktop Computer
- 88802 Image Capture System For Laptop Computer

SEILER 985 ZOOM OVER-THE-SHOULDER COLPOSCOPE

Includes the following: Continuous zoom magnification system from 2x through 14x; 300mm working distance objective lens offering continuous zoom magnifications from 2x to 14.5x; Optional magnifications/objective lens combinations are available. Widefield 12.5x eyepieces with diopter locks and fold-down rubber eyecups for eyeglass wearers; Straight binocular head f=160; Fan cooled, **dual-port variable fiber optic coaxial illumination with 15V 150W lamp (bulb EFR 64634, **should a lamp fail during an examination, the dual-port feature allows a quick change; Maximum height from floor to objective lens - 54 inches; Minimum height - 32 inches; Overall distance from the column to the objective lens - 33 inches; Green filter with selector knob; Spare lamp, dust cover and instruction manual; Video accessories available.

30985-OTS Model 985 Over-The-Shoulder Colposcope



SEILER 935 THREE-STEP COLPOSCOPE

Includes the following: Smooth three-step turret magnification changer; 300mm working distance objective lens offering 3x, 7x and 17x magnifications. Optional magnifications/objective lens combinations are available; Widefield 12.5x eyepieces with diopter locks and fold-down rubber eyecups for eyeglass wearers; Straight binocular head f=160; Fan cooled, **dual-port variable fiber optic coaxial illumination with 15V 150W lamp (bulb EFR 64634, **should a lamp fail during an examination, the dual-port feature allows a quick change from one lamp to another resulting in an uninterrupted procedure; Maximum height from floor to objective lens - 46 inches; Minimum height - 34 inches; Green filter with selector knob; Small diameter base on roller casters with adjustable vertical post height; Spare lamp, dust cover and instruction manual; Video accessories available.

- 30935-3 Model 935 Seiler 3-Step Colposcope
- 30935-3-D Model 935 Colposcope w/digital
- 30935-3-V Model 935 Colposcope w/video



SEILER 955 FIVE-STEP COLPOSCOPE

Includes the following: Smooth five-step turret magnification changer; 300mm working distance objective lens offering 3x, 4x, 7x, 11x and 17x magnifications. Optional magnifications/objective lens combinations are available; Widefield 12.5x eyepieces with diopter locks and fold-down rubber eyecups for eyeglass wearers; Straight binocular head f=160; Fan cooled, **dual-port variable fiber optic coaxial illumination with 15V 150W lamp (bulb EFR 64634, **should a lamp fail during an examination, the dual-port feature allows a quick change from one lamp to another resulting in an uninterrupted procedure; Maximum height from floor to objective lens - 54 inches; Minimum height - 32 inches; Overall distance from the column to the objective lens - 33 inches; Green filter with selector knob; Spare lamp, dust cover and instruction manual; Video accessories available.

- 30955-5 Model 955 Colposcope
- 30955-5-D Model 955 Colposcope w/digital
- 30955-5-V Model 955 Colposcope w/video



PRO ADVANTAGE DISPOSABLE VAGINAL SPECULUM

Made of polystyrene with see-through clarity. Smooth one-handed operation for easier insertion. Single patient use eliminates cross-contamination. Self locking feature speeds examination and saves time. Graves Style. Available in Small, Medium and Large.

- P250300 Large Grave Style Vaginal Speculum, 10/bg, 10 bg/cs (100/cs)
- P250200 Medium Grave Style Vaginal Speculum, 10/bg, 10 bg/cs (100/cs)
- P250100 Small Grave Style Vaginal Speculum, 10/bg, 10 bg/cs (100/cs)



PRO ADVANTAGE® INSTRUMENTS GRAVES VAGINAL SPECULA

Manufactured to German standards with exceptional value. Lifetime guarantee against defects in material or workmanship assures years of serviceability from each instrument. Selection of the most popular patterns of surgical instruments.

- N407400 Small Vaginal Specula
- N407410 Large Vaginal Specula

MILTEX MEISTERHAND PEDERSON VAGINAL SPECULA

Manufactured to German standards with exceptional value. Lifetime guarantee against defects in material or workmanship assures years of serviceability from each instrument. Selection of the most popular patterns of surgical instruments.

- MH30-50 Small Vaginal Specula
- MH30-55 Medium Vaginal Specula
- MH30-60 Large Vaginal Specula



AMSINO AMSMOOTH™ DISPOSABLE VAGINAL SPECULUM

Made of polystyrene with see through clarity. Provides smooth, one-handed operation for easier insertion, requires no lubricant except water, and allows for secure positioning without slippage. Single use eliminates cross contamination. The self-locking feature speeds examination and saves time.

- AS032L Large Grave Style Vaginal Speculum, 10/bg, 10 bg/cs
- AS032M Medium Grave Style Vaginal Speculum, 10/bg, 10 bg/cs
- AS032S Small Grave Style Vaginal Speculum, 10/bg, 10 bg/cs
- AS034L Disposable Vaginal Specula, Graves Style, Individually Wrapped, Large, w/Light Source Option, 25/bx, 4bx/cs
- AS034M Disposable Vaginal Specula, Graves Style, Individually Wrapped, Medium, w/Light Source Option, 25/bx, 4bx/cs
- AS034S Disposable Vaginal Specula, Graves Style, Individually Wrapped, Small, w/Light Source Option, 25/bx, 4bx/cs

DUKAL VAGINAL SPECULUMS

The Disposable Vaginal Speculums make an excellent and economical alternative to metal. Made of a heavy grade plastic smooth edges they offer a wide range of adjustability.

- 6650 Vaginal Speculum, Small, Disposable, 10/bg, 10 bg/cs
- 6660 Vaginal Speculum, Medium, Disposable, 10/bg, 10 bg/cs
- 6670 Vaginal Speculum, Large, Disposable, 10/bg, 10 bg/cs

SOLON DISPOSABLE VAGINAL SPECULA

- 20100 Vaginal Specula, Medium, 10/bg, 10 bg/cs

COOPERSURGICAL LIGHTED SPECULA

Single use disposable for patient safety and added convenience. Works with the most common Halogen Speculum light source. Transparent blades provide excellent visibility allowing full visualization of the entire exam area. Designed to deliver light directly to the tip of the speculum. Smooth acrylic design will not pinch or bind tissue for greater patient comfort. Easy one handed operation provides positive locking positions with multiple settings for smooth operation. For use with or without illumination systems.

- 53343 Small, Blue, 25/bx, 4 bx/cs
- 53344 Medium, Green, 25/bx, 4 bx/cs
- 53345 Large, White, 25/bx, 4 bx/cs



MILTEX LEEP GRAVES SPECULUM

Our most popular design for use in electrosurgical procedures. The integrated smoke evacuation tube provides excellent smoke reduction.

- 31-101 Small Graves Speculum
- 31-151 Medium Graves Speculum
- 31-201 Large Graves Speculum
- 31-301 X-Large Graves Speculum



31-62



31-64

MILTEX LEEP OPEN-SIDED SPECULUM

Also known as Weissman-Graves or Weissman-Pederson, this speculum has an opening on the side for better visibility and ease of access. Comes with right side opening; left side opening available as a special order. The integrated smoke evacuation tube provides excellent smoke reduction.

- 31-62 Medium Pederson Open-Sided Speculum
- 31-63 Large Pederson Open-Sided Speculum
- 31-64 Medium Graves Open-Sided Speculum
- 31-65 Large Graves Open-Sided Speculum



31-1351

31-1354

MILTEX LEEP KOGAN ENDOCERVICAL SPECULA

Provides an excellent view of the cervical opening and comes in a large selection of styles.

- 31-1351 Miltex-Kogan Endocervical Speculum, 11" w/narrow tip, grip-lock ratchet & gauge
- 31-1352 Miltex-Kogan Endocervical Speculum, 11" w/regular tip, grip-lock ratchet & gauge
- 31-1353 Kogan Endocervical Speculum w/narrow tip
- 31-1354 Kogan Endocervical Speculum w/regular tip

MILTEX MEISTERHAND GRAVES VAGINAL SPECULA

Manufactured to German standards with exceptional value. Lifetime guarantee against defects in material or workmanship assures years of serviceability from each instrument. Selection of the most popular patterns of surgical instruments.

- MH30-10 Small Vaginal Specula
- MH30-15 Medium Vaginal Specula
- MH30-20 Large Vaginal Specula

GALENICA GYNE-LITE™ SYSTEM ACCESSORIES

- 9220 Adaptor, 10/bg
- 9230 Sheaths, 100/bx, 4 bx/cs
- 9240 Bulb



MILTEX LEEP MAXI-VIEW GRAVES SPECULUM

The rectangular yoke is an extremely wide 2 3/4" for maximum visibility and instrument access. The integrated smoke evacuation tube provides excellent smoke reduction.

- 31-68 Medium Maxi-View Graves Speculum
- 31-69 Large Maxi-View Graves Speculum

**Personal Attention
Local Service**