



METROLOGIC INSTRUMENTS, INC.  
MS7220 ArgusSCAN™ Presentation  
Laser Scanner  
Installation and User's Guide



# LOCATIONS

---

## CORPORATE HEADQUARTERS

---

<b>North America</b>	Metrologic Instruments, Inc. 90 Coles Road Blackwood, NJ 08012-4683	Customer Service: 1-800-ID-METRO Tel: 856-228-8100 Fax: 856-228-6673 Email: info@metrologic.com Internet: www.metrologic.com
----------------------	---	--

## EUROPEAN HEADQUARTERS

---

<b>Germany</b>	Metrologic Instruments GmbH Dornierstrasse 2 82178 Puchheim b. Munich, Germany	Tel: +49 (0) 89 89019 0 Fax: +49 (0) 89 89019 200 Email: info@europa.metrologic.com
<b>Spain</b>	Metrologic Eria Ibérica SL Julián Camarillo, 29 D-1 Edificio Diapasón 28037 Madrid	Tel: +34 91 327 24 00 Fax: +34 91 327 38 29 Email: info@es.metrologic.com
<b>Italy</b>	Metrologic Italia Srl Via Emilia 70 40064 Ozzano dell'Emilia (BO)	Tel: +39 0 51 6511978 Fax: +39 0 51 6521337 Email: info@it.metrologic.com
<b>France</b>	Metrologic Eria France SA 69 Rue de la Belle Etoile ZI Paris Nord II, BP 50057 95947 – ROISSY CDG CEDEX	Tel: +33 (0) 1 48.63.78.78 Fax: +33 (0) 1 48.63.24.94 Email: info@fr.metrologic.com
<b>United Kingdom</b>	Metrologic Instruments UK Limited 58 Tempus Business Centre Kingsclere Road, Basingstoke Hampshire RG21 6XG	Tel: +44 (0) 1256 365900 Fax: +44 (0) 1256 365955 Email: info@uk.metrologic.com

## ASIA

---

<b>Singapore</b>	Metrologic Asia (Pte) Ltd 31 Kaki Bukit Road 3 #05-08 Techlink Singapore 417818	Tel: 65-842-7155 Fax: 65-842-7166 Email: info@sg.metrologic.com
<b>China</b>	Metro (Suzhou) Technologies Co., Ltd. 221 Xing Hai Street Suzhou Industrial Park Suzhou, China 215021	Tel: 86-512-2572511 Fax: 86-512-2571517 Email: info@cn.metrologic.com
<b>Japan</b>	Metrologic Japan Co., Ltd. Matsunoya Building, 6 Floor 3-14-8 Higashiueno Taitou-Ku Tokyo 110-0015, Japan	Tel: 81-3-3839-8511 Fax: 81-3-3839-8519 Email: info@jp.metrologic.com

## SOUTH AMERICA

---

<b>Brazil</b>	Metrologic do Brasil Ltda. Rua Flórida, 1821 - 5º Andar São Paulo, SP, Brasil CEP: 04571-090	Tel: 5511-5505-2396 Fax: 5511-5507-2301 Email: info@br.metrologic.com
<b>Outside Brazil</b>	Metrologic South America Rua Flórida, 1821 - 5º Andar São Paulo, SP, Brasil CEP: 04571-090	Tel: 5511-5505-6568 Fax: 5511-5505-1681 Email: info@sa.metrologic.com

## Copyright

© 2001 by Metrologic Instruments, Inc. All rights reserved. No part of this work may be reproduced, transmitted, or stored in any form or by any means without prior written consent, except by reviewer, who may quote brief passages in a review, or provided for in the Copyright Act of 1976.

Products and brand names mentioned in this document are trademarks of their respective companies.

MLPN 00-02554  
Printed in USA  
April 2001

# TABLE OF CONTENTS

---

Introduction.....	1
Scanner and Accessories.....	2
Getting Started .....	3
Installation for OCIA Interface .....	5
Installation for Keyboard Wedge Interface .....	7
Installation for Stand-Alone Keyboard Interface .....	8
Installation for RS232 or Light Pen Interfaces .....	9
Installation of an Auxiliary Scanner.....	11
Scanner Parts.....	13
The Multi-Function Button.....	14
Audible Indicators.....	15
Failure Modes.....	16
Visual Indicators .....	17
Labels.....	18
Maintenance .....	18
Depth of Field Specifications .....	19
Depth of Field by Minimum Bar Code Element Width .....	20
Troubleshooting Guide .....	22
RS232 Demonstration Program.....	27
Applications and Protocols .....	28
Design Specifications .....	29
Default Settings .....	31
MS7220 Stands	
Vertical Stand Parts [mlpn 46-46405 ] .....	37
Optional Flex Stand Parts [mlpn 46-46404 ] .....	37
Vertical Stand Installation .....	38
Optional Flex Stand Installation .....	39
Scanner and Cable Terminations .....	40
Limited Warranty .....	43
Notices.....	44
Patents .....	45
Index.....	46

## INTRODUCTION

---

ArgusScan™ is an aggressive, omnidirectional laser barcode scanner ideal for retail, convenience, liquor, and specialty store applications. Engineered with a large, easy-to-find optimal scan area, ArgusScan increases the first pass read rate for maximum productivity.

ArgusScan is equipped with a multitude of standard features including:

- ✧ A bright 650 nm laser
- ✧ Programmable depth of field
- ✧ PowerLink user replaceable cables
- ✧ MetroSet®2, MetroSelect® and MetroOPOS® compatible
- ✧ Data editing (parsing) capability using Bits n' Pieces®
- ✧ A 2 year warranty

SCANNER	INTERFACE
7220-12	RS232, Light Pen, Keyboard Wedge, Stand-Alone Keyboard, OCIA, Low Speed Option

## SCANNER AND ACCESSORIES

---

The following is a list of the parts included in the MS7220 kit.

- **MS7220 ArgusScan™ Presentation Scanner**
- **MetroSelect® Programming Guide\*\*** [ MLPN 00-02407 or 00-02561 ]
- **MS7220 User's and Installation Guide\*\*** [ MLPN 00-02554 ]  
\*\*Also Available on the Metrologic Website ([www.metrologic.com](http://www.metrologic.com))
- **Stand**
  - Standard Horizontal Stand [ MLPN 46-46406 ]
  - Standard Vertical Stand [ MLPN 46-46405 ]

The following items are dependent on the type of MS7220 Kit ordered. Some items may not be included in your kit.

- **AC to DC Power Transformer** - Regulated 5.2V@ 650 mA output
  - *One* of the following may be included:
    - 120V United States [ MLPN 45-45593 ]
    - 220V – 240V Continental European [ MLPN 45-45591 ]
    - 220V – 240V United Kingdom [ MLPN 45-45592 ]
- **Stand**
  - Optional Flex Stand [ MLPN 46-46404 ]
- **PowerLink Cable** with built in power jack for use with RS-232, Light Pen, OCIA and 46xx scanners:
  - *One* of the following may be included:
    - Standard: 2.1m (7') straight cord, short strain relief [ MLPN 54-54xxx\* ]
    - Optional: 2.7m (9') coiled cord, long strain relief [ MLPN 53-53xxx\* ]

\* xxx specifies connection to the host
- **Keyboard Wedge PowerLink Cable Kit** for use with Keyboard Wedge scanners [ MLPN 54-54002 ]:
  - A PowerLink "Y" cable with a 5-pin DIN female connector and a 6-pin mini DIN male connector
  - An Adapter Cable with a 5-pin DIN male connector and a 6-pin mini DIN female connector
- **Stand Alone Keyboard Wedge Powerlink Cable** [ MLPN 54-54020 ]

Other items may be ordered for the specific protocol being used. To order additional items, contact the dealer, distributor or call Metrologic's Customer Service Department at 1-800-ID-METRO or 1-800-436-3876.

# GETTING STARTED

Tools needed:

- Phillips head screwdriver
- ¼"-20 wrench
- Drill with a #39 drill bit (*drill for hard-mount installation only*)

**1** Slide off the cable cover.

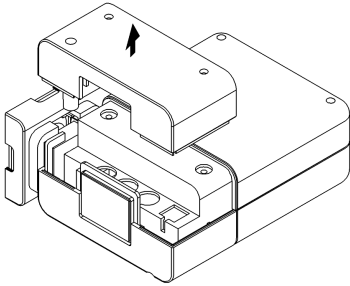

**2** Slide off the horizontal stand.

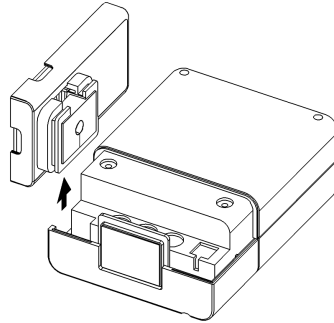

**3** Slide on the cable door and remove the foam insert.

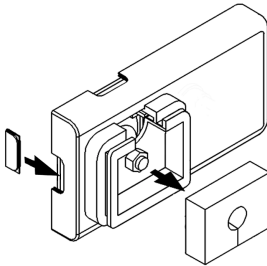

**4** Loosen the lock nut, push back the metal base plate and then slide the cable through the cable opening.

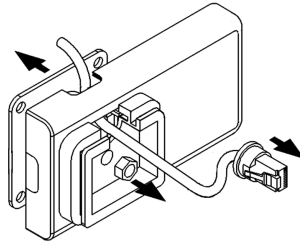

**5** Mounting the MS7220: Peel off the base plate's tape backing and affix it to the countertop or drill four #39 pilot holes and secure the base plate to the countertop with the four #8 wood screws provided.

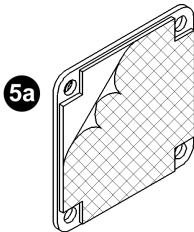

OR

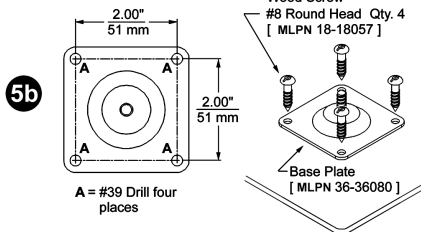

*Continued on next page.*

## GETTING STARTED

- 6** Return the metal base plate to its original position then tighten the lock nut.

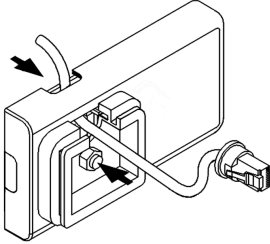

- 7 & 8** Return the foam insert to its original position then slide the horizontal stand back into place on the scanner.

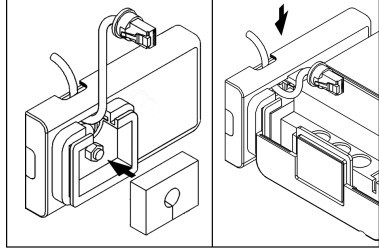

- 9**  Before continuing, determine what communication interface is needed then follow the installation procedure for that interface on pages 5-11.

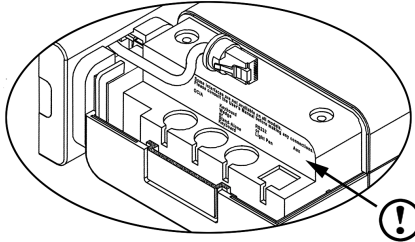

It is important to use the correct communication jack on the back of the scanner (see pages 5-10 for cable the proper connections). Incorrect cable connections can cause communication problems or potential damage to the scanner

- 10** **After the communication cable has been connected properly**, slide the cable cover down then secure in place with the three M3x .5 x 6 mm pan head screws provided.

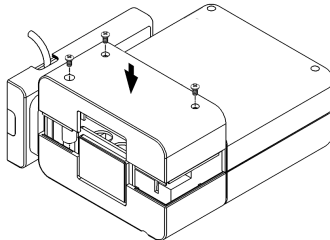

See the "MS720 Stands" section of this guide for additional information on the vertical [ MLPN 46-46405 ] and flexible [ MLPN 46-46406 ] stand options.

# INSTALLATION FOR OCIA INTERFACE

## To power the unit with an external power supply:

1. Follow the “Getting Started” steps on page 3.
2. Turn off the host system.
3. Connect the PowerLink cable to the jack labeled “OCIA” on the MS7220.
4. Connect the other end of the PowerLink cable to the host.



Before continuing verify that the powerlink cable is connected to the proper communication jack on the scanner. Incorrect cable connection can cause communication problems or potential damage to the scanner.

5. Connect the external power supply to the power jack on the Power Link Cable.
6. Check the AC input requirements of the power supply to make sure the voltage matches the AC outlet.
7. Connect AC power to the transformer. The outlet should be near the equipment and easily accessible.
8. Slide the cable cover into place on the back of the scanner then secure it with the three M3 screws provided.
9. Turn on the host system.
10. Scan the bar code to configure the MS7220 for OCIA communication.

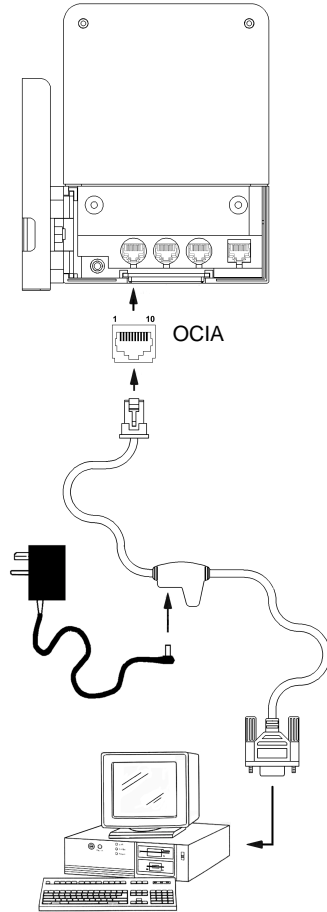

Figure 1: OCIA Interface



### ⚠ Caution:

To maintain compliance with applicable standards, all circuits connected to the scanner must meet the requirements for SELV (Safety Extra Low Voltage) according to EN 60950.

To maintain compliance with standard CSA C22.2 No. 950/UL 1950 and norm EN 60950, the power source should meet applicable performance requirements for a limited power source.



## INSTALLATION FOR OCIA INTERFACE (CONTINUED)

### To power the unit from the host device: (For OCIA only)

1. Follow the "Getting Started" steps on page 3.
2. Turn off the host system.
3. Connect the PowerLink cable to the jack labeled "OCIA" on the MS7220.
4. Connect the other end of the PowerLink cable to the host.



Before continuing verify that the powerlink cable is connected to the proper communication jack on the scanner. Incorrect cable connection can cause communication problems or potential damage to the scanner.

#### Manufacturers Note:

Plugging the scanner into the serial port of the PC does not guarantee that scanned information will appear at the PC. A software driver and correct configuration setting are also required for proper communication to occur.

5. Slide the cable cover into place on the back of the scanner then secure it with the three M3 screws provided.
6. Turn on the host system.
7. Scan the bar code to configure the MS7220 for OCIA communication.

Load OCIA Defaults

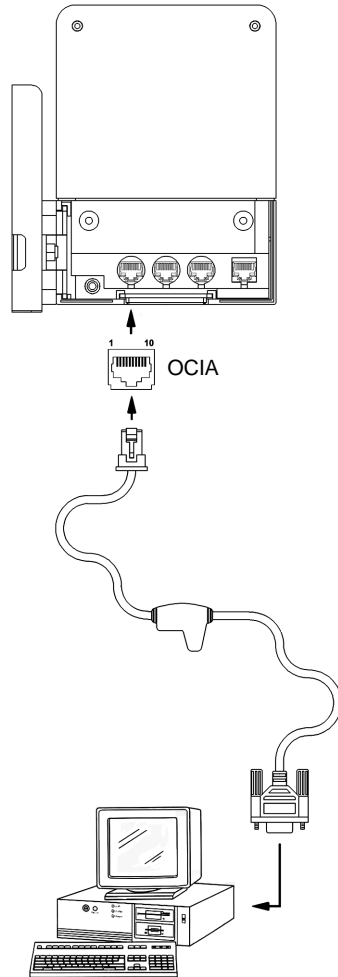

Figure 2: OCIA, Interface powered by the host device

#### ⚠ Caution:

To maintain compliance with applicable standards, all circuits connected to the scanner must meet the requirements for SELV (Safety Extra Low Voltage) according to EN 60950.

To maintain compliance with standard CSA C22.2 No. 950/UL 1950 and norm EN 60950, the power source should meet applicable performance requirements for a limited power source.

## INSTALLATION FOR KEYBOARD WEDGE INTERFACE

1. Follow the “Getting Started” steps on page 3.
2. Turn off the host system.
3. Disconnect the keyboard from the host.
4. Connect the PowerLink cable to the jack labeled “Keyboard Wedge” on the MS7220.
5. Connect the “Y” end of the PowerLink cable to the keyboard and the keyboard port on the host. If necessary use the male/female adapter cable supplied with the scanner for proper connections.



Before continuing verify that the powerlink cable is connected to the proper communication jack on the scanner. Incorrect cable connection can cause communication problems or potential damage to the scanner.

6. Connect the external power supply to the power jack on the PowerLink cable.
7. Check the AC input requirements of the power supply to make sure the voltage matches the AC outlet.
8. Connect AC power to the transformer. The outlet should be near the equipment and easily accessible.
9. Slide the cable cover into place on the back of the scanner then secure it with the three M3 screws provided.
10. Turn on the host system.
11. Scan the bar code below to configure the MS7220 for Keyboard Wedge communication.

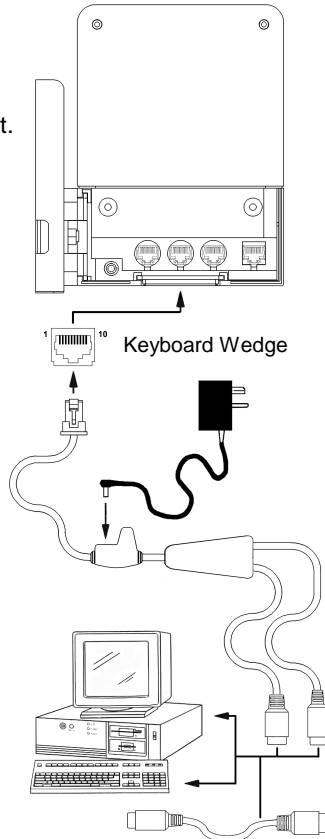

Figure 3: Keyboard Wedge Interfaces

Load Keyboard Wedge Defaults



### ⚠ Caution:

To maintain compliance with applicable standards, all circuits connected to the scanner must meet the requirements for SELV (Safety Extra Low Voltage) according to EN 60950.

To maintain compliance with standard CSA C22.2 No. 950/UL 1950 and norm EN 60950, the power source should meet applicable performance requirements for a limited power source.

## INSTALLATION FOR STAND-ALONE KEYBOARD INTERFACE

1. Follow the “Getting Started” steps on page 3.
2. Turn off the host system.
3. Disconnect the keyboard from the host.
4. Connect the PowerLink cable to the jack labeled “Stand-Alone Keyboard” on the MS7220.
5. Connect the other end of the PowerLink cable to the keyboard port on the host.



Before continuing verify that the powerlink cable is connected to the proper communication jack on the scanner. Incorrect cable connection can cause communication problems or potential damage to the scanner.

6. Connect the external power supply to the power jack on the PowerLink cable.
7. Check the AC input requirements of the power supply to make sure the voltage matches the AC outlet.
8. Connect AC power to the transformer. The outlet should be near the equipment and easily accessible.
9. Slide the cable cover into place on the back of the scanner then secure it with the three M3 screws provided.
10. Turn on the host system.
11. Scan the bar codes below to configure the MS7220 for Stand-Alone Keyboard communication.

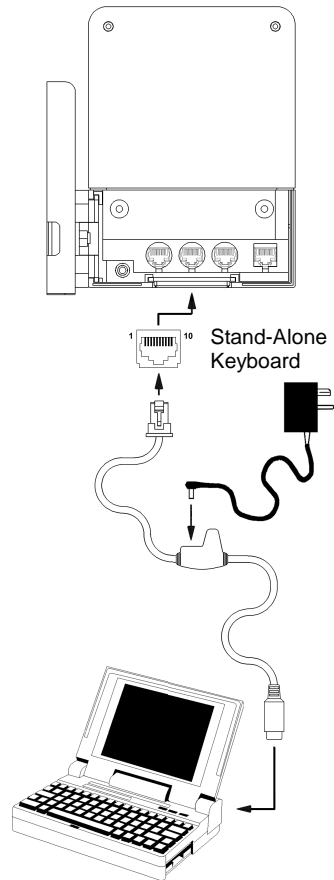

**Figure 4:** Stand-Alone Keyboard Interface

Load Keyboard Wedge Defaults



Scan 1<sup>st</sup> 3 9 9 9 9 9 4

Enable Stand-Alone Keyboard



Scan 2<sup>nd</sup> 3 5 1 5 5 1 5 3

### ⚠ Caution:

To maintain compliance with applicable standards, all circuits connected to the scanner must meet the requirements for SELV (Safety Extra Low Voltage) according to EN 60950.

To maintain compliance with standard CSA C22.2 No. 950/UL 1950 and norm EN 60950, the power source should meet applicable performance requirements for a limited power source.

## INSTALLATION FOR RS232 OR LIGHT PEN INTERFACES

1. Follow the “Getting Started” steps on page 3.
2. Turn off the host system.
3. Connect the PowerLink cable to the jack labeled “RS232 or Light Pen” on the MS7220.
4. Connect the other end of the PowerLink cable to the host.

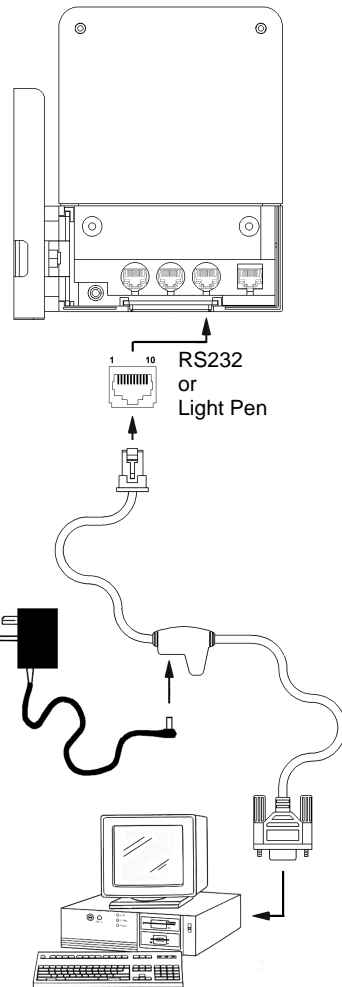

Before continuing verify that the powerlink cable is connected to the proper communication jack on the scanner. Incorrect cable connection can cause communication problems or potential damage to the scanner.

5. Connect the external power supply to the power jack on the Power Link Cable.
6. Check the AC input requirements of the power supply to make sure the voltage matches the AC outlet.
7. Connect AC power to the transformer. The outlet should be near the equipment and easily accessible.
8. Slide the cable cover into place on the back of the scanner then secure it with the three M3 screws provided.
9. Turn on the host system.
10. Scan the appropriate bar codes on page 10 to configure the MS7220 for RS-232 or Light Pen communication.

**Figure 5:** RS232 or Light Pen Interface

### Caution:

To maintain compliance with applicable standards, all circuits connected to the scanner must meet the requirements for SELV (Safety Extra Low Voltage) according to EN 60950.

To maintain compliance with standard CSA C22.2 No. 950/UL 1950 and norm EN 60950, the power source should meet applicable performance requirements for a limited power source.

# INSTALLATION FOR RS232 OR LIGHT PEN INTERFACES

---

Step 10, page 9 continued.

For RS232 Communication:



For Light Pen Communication:



## INSTALLATION OF AN AUXILIARY SCANNER

---

1. Follow the “*Getting Started*” steps on page 3.
2. Turn off the host system.
3. Connect the Master/Slave PowerLink cable to the jack labeled “Aux” on the MS7220 (*see figure 6*).
4. Connect the other end of the Master/Slave PowerLink cable to the slave scanner. The following Metrologic scanners can be used in the “Aux” input of the MS7220: the MS9520, MS9540, MS6220, MS7120, MS6520, MS6720, or another MS7220.



*Important: The MS7220 will only receive full RS232 communication from the slave.*

5. Connect the MS7220/Host PowerLink cable to the appropriate interface jack on the back of the MS7220.
6. Connect the other end of the MS7220/Host PowerLink cable to the Host.
7. Connect the external power supplies for the slave scanner and the MS7220 to the power jacks on the two PowerLink cables.



Before continuing verify that the powerlink cable is connected to the proper communication jack on the scanner. Incorrect cable connection can cause communication problems or potential damage to the scanner.

8. Check the AC input requirements of both power supplies to make sure the voltage matches the AC outlets.
9. Connect AC power to the transformers. The outlets should be near the equipment and easily accessible.
10. Slide the cable cover into place on the back of the scanner then secure it with the three M3 screws provided.
11. Turn on the host system.

*See next page for illustration.*

# INSTALLATION OF AN AUXILIARY SCANNER

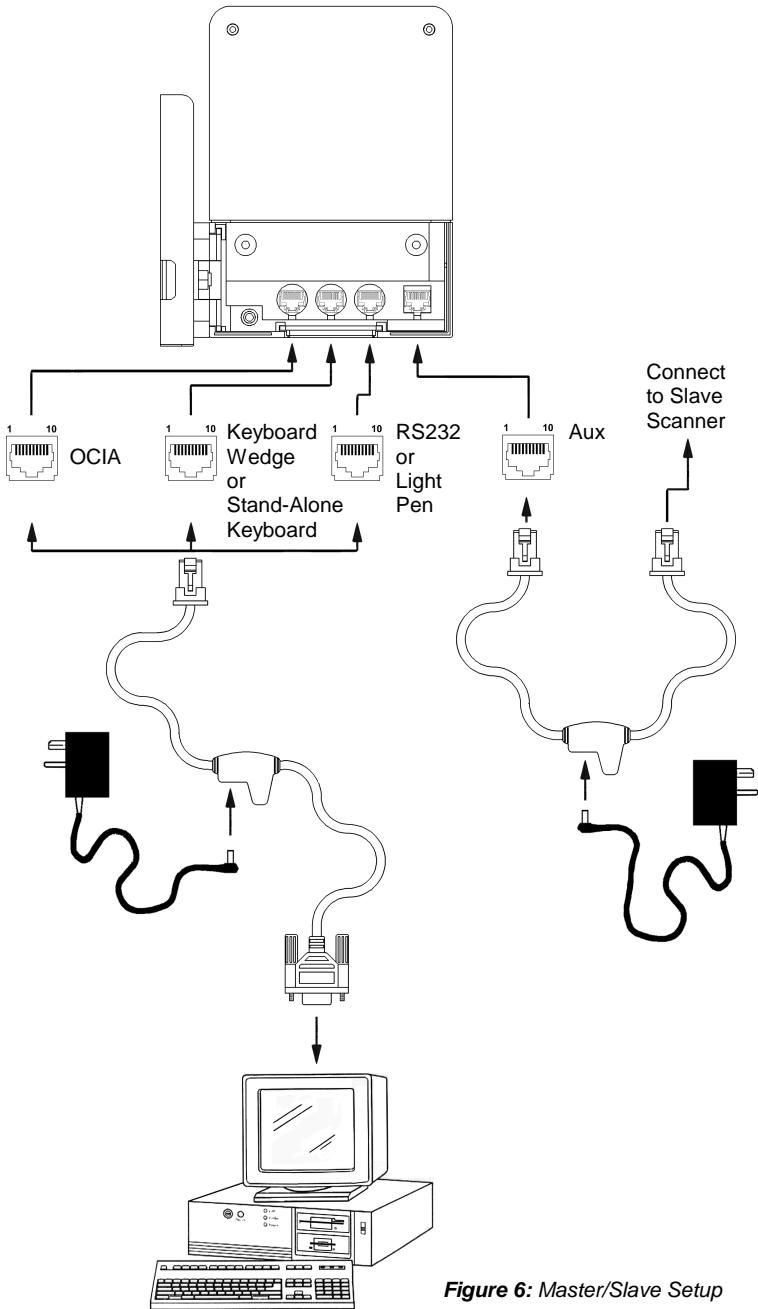

**Figure 6: Master/Slave Setup**

# SCANNER PARTS

---

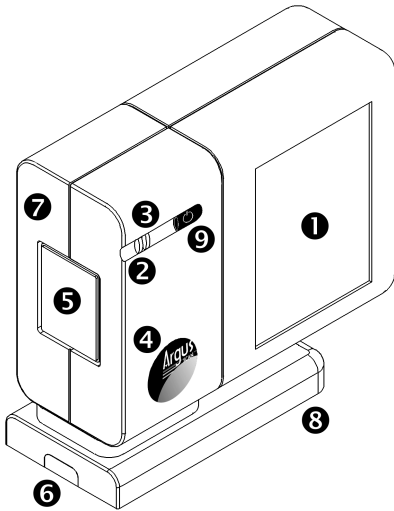

Figure 7a: Scanner Parts

- ❶ Output Window
- ❷ Red LED
- ❸ Green LED
- ❹ Speaker
- ❺ Side Cover
- ❻ Cable Door
- ❼ Cable Jack Cover
- ❽ Horizontal Mount Base
- ❾ Multi-Function Button  
(see page 13)
- ❿ Cable Connection Area
- ⓫ Foam Insert

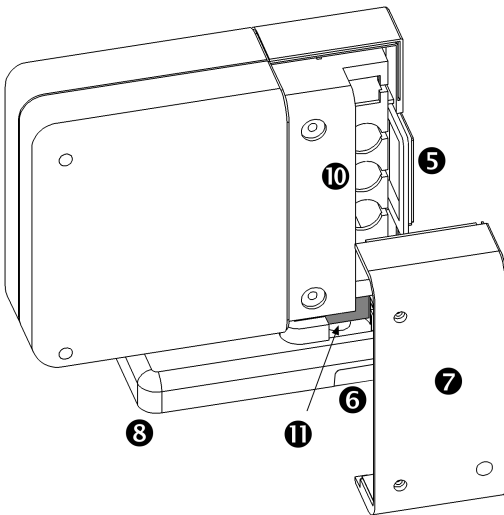
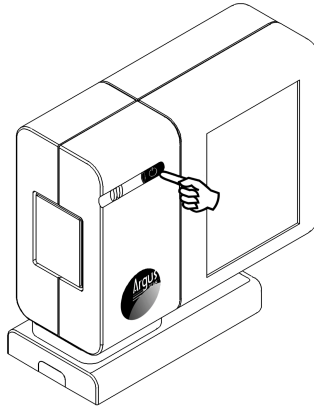

Figure 7b: Scanner Parts



# THE MULTI-FUNCTION BUTTON

---



**Figure 8a:** Multi-Function Button

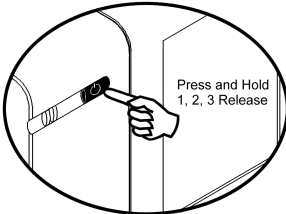

**Figure 8b:** Changing the Beeper Tone

## CHANGING THE BEEPER TONE

A short (<3 second) depression The beeper tone will change. The new tone will be heard, followed by a short pause. Then two more of the new tones will be heard signifying the new setting has been stored in memory. The silent (no beep) tone is also selectable.

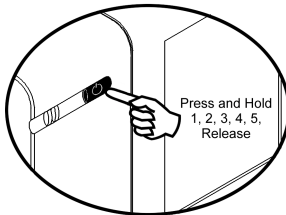

**Figure 8c:** Sleep mode

## PLACING THE UNIT IN SLEEP MODE

Long (>3 seconds) depression  
Puts the scanner in the sleep mode.

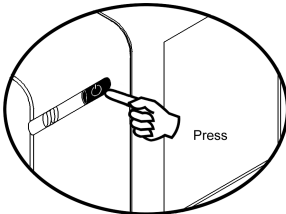

**Figure 8d:** Normal Operation

## WAKING THE UNIT FROM SLEEP MODE

The next button depression will awaken the scanner for normal operation.

## AUDIBLE INDICATORS

---

When the MS7220 scanner is in operation, it provides audible feedback. These sounds indicate the status of the scanner. Eight settings are available for the tone of the beep (normal, 6 alternate tones and no tone). To change the tone, use the *Multi-Function Button* or refer to the MetroSelect® Programming Guide (MLPN 00-02407 or 00-02561).

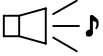

### One Beep

When the scanner *first* receives power, the green LED will turn on, the red LED will flash and the scanner will beep once. (The red LED will remain on for the duration of the beep.) The scanner is now ready to scan.

When the scanner *successfully* reads a bar code, the red LED will flash and the scanner beeps once (if programmed to do so). If the scanner does not beep once and the red light does not flash, then the bar code has *not* been successfully read.



### Razzberry Tone

This is a failure indicator. Refer to failure modes page 15.

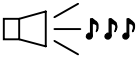

### Three Beeps - during operation

When placing the scanner in program mode, the red LED will flash while the scanner simultaneously beeps three times. The red and green LEDs will continue to flash until the unit exits program mode. Upon exiting program mode, the scanner will beep three times and the red LED will stop flashing.

When configured, 3 beeps can also indicate a communications timeout during normal scanning mode.

When using one-code-programming, the scanner will beep three times (the current selected tone), followed by a short pause, a high tone and a low tone. This tells the user that the single configuration bar code has *successfully* configured the scanner.

Three beeps will also occur during a manual adjustment of the beeper tone. With each short depression of the *Multi-Function Button*, the new tone will be heard, followed by a short pause then two more of the new current tones.

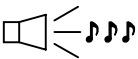

### Three Beeps - on power up

This is a failure indicator. Refer to failure modes page 15.

## FAILURE MODES

---



### Flashing Green and One Razzberry Tone

This indicates the scanner has experienced a laser subsystem failure. Return the unit for repair at an authorized service center.

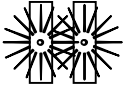

### Flashing Red and Green and Two Razzberry Tones

This indicates the scanner has experienced a motor failure. Return the unit for repair at an authorized service center.

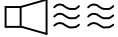

### Continuous Razzberry Tone with both LEDs off

If, upon power up, the scanner emits a continuous razzberry tone, then the scanner has an electronic failure. Return the unit for repair at an authorized service center.

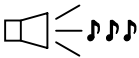

### Three Beeps - on power up

If the scanner beeps 3 times on power up then, the nonvolatile memory that holds the scanner configuration has failed. Return the unit for repair at an authorized service center.

## VISUAL INDICATORS

---

There is a red LED and a green LED on the front of the MS7220. When the scanner is on, the flashing or constant illumination of the LEDs indicates the status of the current scan and the scanner.



### No Red or Green LED

The LEDs will not be illuminated if the scanner is not receiving power from the host or transformer.



### Steady Green

When the laser is active, the green LED is illuminated. The green LED will remain illuminated until the laser is deactivated.

During the power save mode, the laser will turn on and off. During this period, the green LED remains illuminated.



### Steady Green and Single Red Flash

When the scanner successfully reads a bar code, the red LED will flash and the scanner will beep once. If the red LED does not flash or the scanner does not beep once, then the bar code has not been successfully read.



### Steady Green and Steady Red

After a successful scan, the scanner transmits the data to the host device. Some communication modes require that the host inform the scanner when data is ready to be received. If the host is not ready to accept the information, the scanner's red LED will remain on until the data can be transmitted.

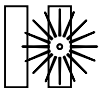

### Flashing Green then Flashing Red

This indicates the scanner is in program mode. A razzberry tone indicates that an invalid bar code has been scanned in this mode.



**or**

If the unit is in sleep mode, each LED will flash once every 15 seconds.



### Steady Red, Green off

This indicates the scanner may be waiting for communication from the host.

## LABELS

---

Each scanner has a label on the back of the unit. The label contains information such as the model number, date of manufacture, and the serial number. The following are examples of these labels:

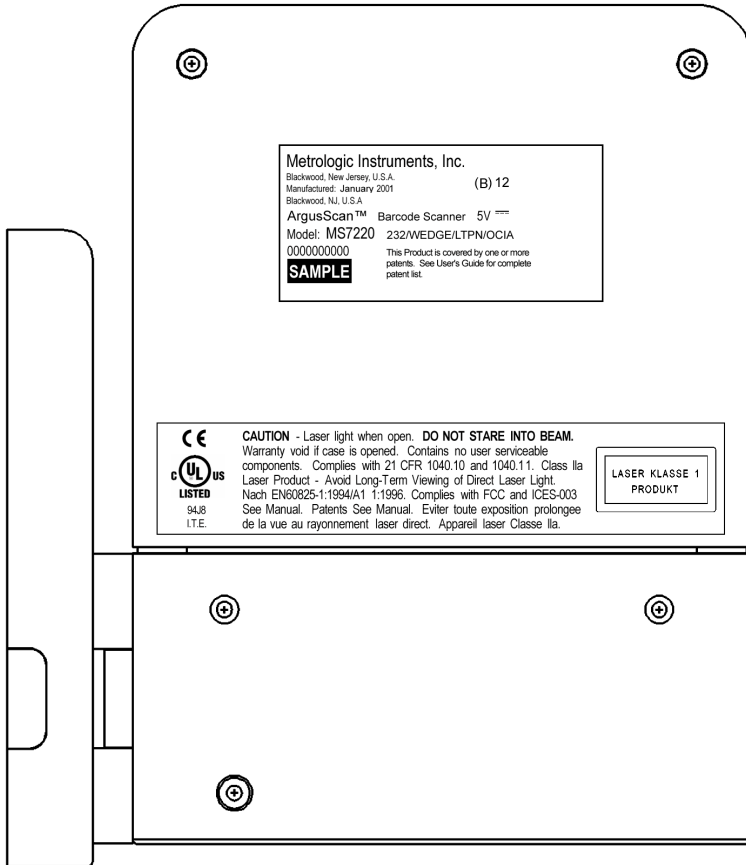

*Figure 9: Labels*

## MAINTENANCE

---

Smudges and dirt can interfere with the proper scanning of a bar code. Therefore, the output window will need occasional cleaning.

1. Spray glass cleaner onto lint free, non-abrasive cleaning cloth.
2. Gently wipe the scanner window.

# DEPTH OF FIELD SPECIFICATIONS

(BASED ON 100% UPC BAR CODES)

## Depth of Field (default)

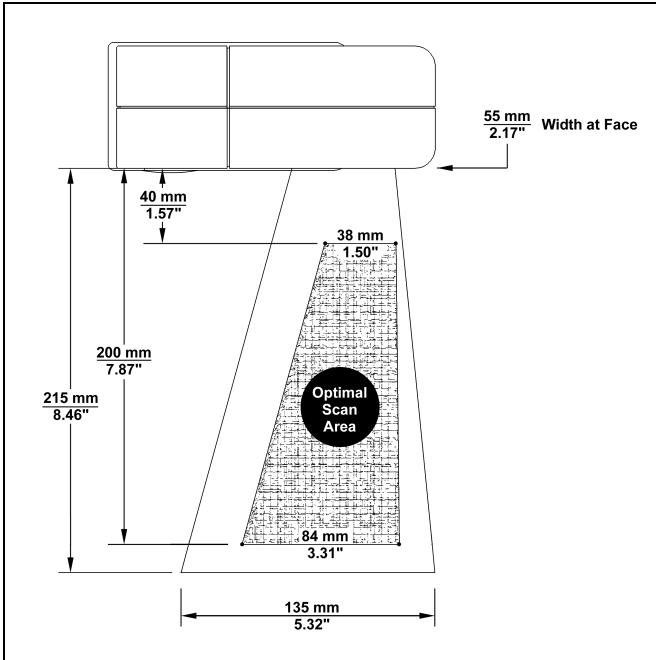

Figure 10: Top View of Depth of Field

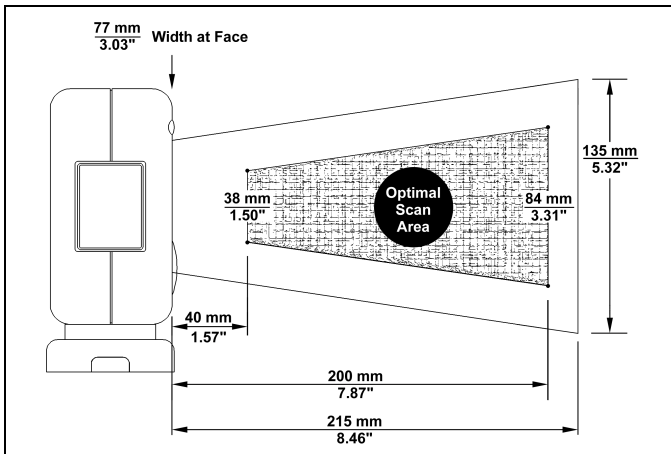

Figure 11: Side View of Depth of Field

Specifications subject to change without notice.

# DEPTH OF FIELD BY MINIMUM BAR CODE ELEMENT WIDTH

(BASED ON 100% UPC BAR CODES)

## Depth of Field (Default)

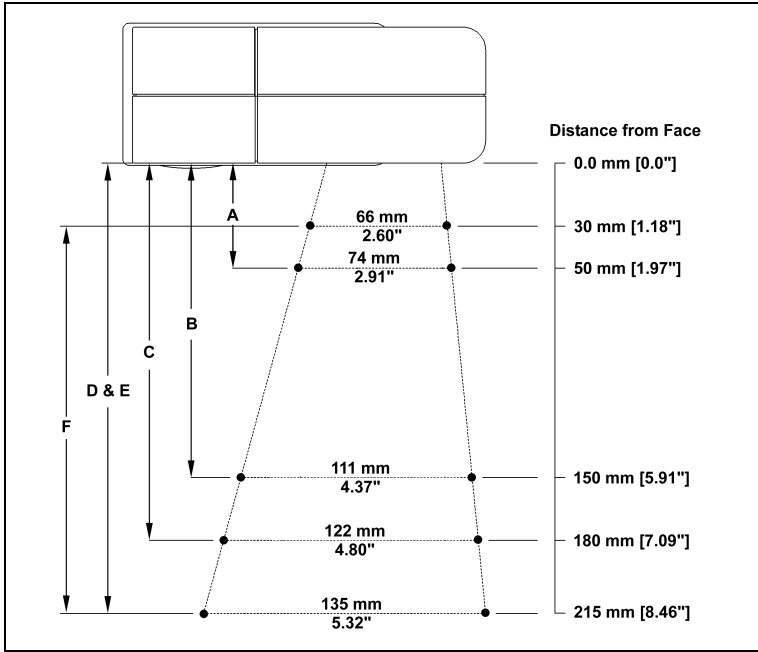

Figure 12: Top View of Depth of Field

Minimum Bar Code Element Width						
	A	B	C	D	E	F
mm	.13	.19	.26	.33	.48	.66
mils	5.2	7.5	10.4	13	19	26

Specifications subject to change without notice.

# DEPTH OF FIELD BY MINIMUM BAR CODE ELEMENT WIDTH

(BASED ON 100% UPC BAR CODES)

## Depth of Field (Default)

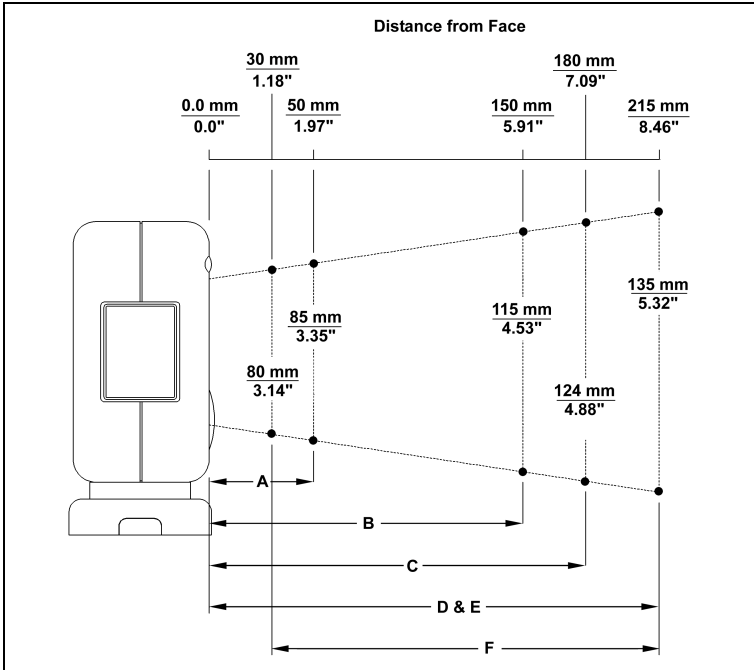

Figure 13: Side View of Depth of Field

Minimum Bar Code Element Width						
	A	B	C	D	E	F
mm	.13	.19	.26	.33	.48	.66
mils	5.2	7.5	10.4	13	19	26

Specifications subject to change without notice.



# TROUBLESHOOTING GUIDE

The following guide is for reference purposes only. Contact a Metrologic representative at 1-800-ID-METRO or 1-800-436-3876 to preserve the limited warranty terms.

<b>MS7220 Series Troubleshooting Guide</b>		
<b>SYMPTOMS</b>	<b>POSSIBLE CAUSE(S)</b>	<b>SOLUTION</b>
<b><i>All Interfaces</i></b>		
No LEDs, beep or motor spin	No power is being supplied to the scanner	Check transformer, outlet and power strip. Make sure the cable is plugged into the scanner
No LEDs, beep	No power is being supplied to the scanner from host	Some host systems cannot supply enough current to power ArgusScan™. Use the power supply included with the scanner.
3 beeps on power up	Non-volatile RAM failure	Contact a Metrologic Representative, if the unit will not hold the programmed configuration
Continuous razz tone on power up	RAM or ROM failure	Contact a Metrologic Representative, if the unit will not function
Razz tone and green LED flash at power up	VLD failure	Contact a Metrologic Representative
Razz tone and both LEDs flash at power up	Scanner motor failure	Contact a Metrologic Representative
Multiple scans upon presentation of code	Same symbol timeout set too short	Adjust same symbol timeout for a longer time
The unit powers up, but does not scan and/or beep	Beeper disabled. No tone selected	Enable beeper. Select tone

## TROUBLESHOOTING GUIDE (CONTINUED)

SYMPTOMS	POSSIBLE CAUSE(S)	SOLUTION
The unit powers up, but does not scan and/or beep	Scanning a particular symbology that is not enabled	UPC/EAN, Code 39, interleaved 2 of 5, Code 93, Code 128 and Codabar are enabled by default. Verify that the type of bar code being read has been selected
The unit powers up, but does not scan and/or beep	The scanner has been programmed for a character length lock, or a minimum length and bar code being scanned does not satisfy the programmed criteria	Verify that the bar code that is being scanned falls into the criteria. (Typical of Non-UPC/EAN codes. <i>The scanner defaults to a minimum of 4 character bar code.</i> )
The unit scans a bar code, but locks up after the first scan (red LED stays on)	The scanner is configured to support some form of host handshaking but is not receiving the signal	If the scanner is setup to support ACK/NAK, RTS/CTS, XON/XOFF or D/E, verify that the host cable and host are supporting the handshaking properly
The unit scans, but the data transmitted to the host is incorrect	The scanner's data format does not match the host system requirements	Verify that the scanner's data format matches that required by the host. Make sure that the scanner is connected to the proper host port
Scanner beeps at some bar codes and NOT for others of the same bar code symbology	The print quality of the bar code is suspect  Also check character length lock.	Check print mode. The type of printer could be the problem. Change print settings. For example change to econo mode or high speed
Scanner beeps at some bar codes and NOT for others of the same bar code symbology	The aspect ratio of the bar code is out of tolerance	Check print mode. The type of printer could be the problem. Change print settings. ie change to econo mode or high speed

## TROUBLESHOOTING GUIDE (CONTINUED)

SYMPTOMS	POSSIBLE CAUSE(S)	SOLUTION
Scanner beeps at some bar codes and NOT for others of the same bar code symbology	The bar code may have been printed incorrectly	Check if it is a check digit/character/or border problem
Scanner beeps at some bar codes and NOT for others of the same bar code symbology	The scanner is not configured correctly for this type of bar code	Check if check digits are set properly
Scanner beeps at some bar codes and NOT for others of the same bar code symbology	The minimum symbol length setting does not work with the bar code	Check if the correct minimum symbol length is set
<b><i>Keyboard Wedge Only</i></b>		
The unit scans the bar code but there is no data	Configuration is not correct	Make sure the scanner is configured for the appropriate mode.
The unit scans but the data is not correct	Configuration is not correct	Make sure that the proper PC type AT, PS2 or XT is selected. Verify correct country code and data formatting are selected. Adjust intercharacter delay SYMPTOM
The unit is transmitting each character	Configuration is not correct	Increase the interscan code delay setting. Adjust whether the F0 break is transmitted. It may be necessary to try this in both settings.

## TROUBLESHOOTING GUIDE (CONTINUED)

SYMPTOMS	POSSIBLE CAUSE(S)	SOLUTION
Alpha characters show as lower case	Computer is in Caps Lock mode	Enable Caps Lock detect setting of the scanner to detect whether the PC is operating in Caps Lock
Everything works except for a couple of characters	These characters may not be supported by that country's key look up table	Try operating the scanner in Alt mode
<b>RS-232 Only</b>		
The unit is transmitting each character	Configuration is not correct	Increase the interscan code delay setting. Adjust whether the F0 break is transmitted. It may be necessary to try this in both settings.
Alpha characters show as lower case	Computer is in Caps Lock mode	Enable Caps Lock detect setting of the scanner to detect whether the PC is operating in Caps Lock
Everything works except for a couple of characters	These characters may not be supported by that country's key look up table	Try operating the scanner in Alt mode
Power-up OK and scans OK but does not communicate properly to the host	Com port at the host is not working or configured properly	Check to make sure that the baud rate and parity of the scanner and the communication port match and the program is looking for "RS-232" data
Power-up OK and scans OK but does not communicate properly to the host	Cable not connected to the proper com port	Check to make sure that the baud rate and parity of the scanner and the communication port match and the program is looking for "RS-232" data

## TROUBLESHOOTING GUIDE (CONTINUED)

SYMPTOMS	POSSIBLE CAUSE(S)	SOLUTION
Power-up OK and scans OK but does not communicate properly to the host.	Com port not operating properly.	Check to make sure that the baud rate and parity of the scanner and the communication port match and the program is looking for "RS-232" data.
The host is receiving data but the data does not look correct.	The scanner and host may not be configured for the same interface font.	Check that the scanner and the host are configured for the same interface font.
Characters are being dropped.	Intercharacter delay needs to be added to the transmitted output.	Add some intercharacter delay to the transmitted output by using the MetroSelect® Programming Guide MLPN 00-02407.
<b>Slave operation with any interface</b>		
Trouble with the Slave Scanner.		Refer to the user guide provided with the slave scanner.
Slave Scanner powers up but data is not relayed to the host.	Cable [MLPN 54-54667] may not be connected to the proper port.	Ensure slave scanner is connected to the MS7220 com port marked "Aux" port.
	The "Aux" com port may not be operating properly.	* The MS7220 must be programmed to enable the "Aux" port. The slave scanner must be configured to send "slave" formatted data (reserve code 32).
<p>* Use MetroSet®.</p> <p>For the Auxiliary interface, choose "HoloTrak Decode". All remaining parameters will be automatically chosen.</p>		

## RS232 DEMONSTRATION PROGRAM

---

If an RS232 scanner is not communicating with your IBM compatible PC, key in the following BASIC program to test that the communication port and scanner are working. This program is for demonstration purposes only. It is only intended to prove that cabling is correct, the com port is working, and the scanner is working. If the bar code data displays on the screen while using this program, it only demonstrates that the hardware interface and scanner are working. At this point, investigate whether the application software and the scanner configuration match. If the application does not support RS-232 scanners, a software wedge program that will take RS-232 data and place it into a keyboard buffer may be needed. This program tells the PC to ignore RTS-CTS, Data Set Ready (DSR) and Data Carrier Detect (DCD) signals. If the demonstration program works and yours still does not, jumper RTS to CTS and Data Terminal Reading (DTR) to DCD and DSR on the back of your PC.

```
10 CLS
20 ON ERROR GOTO 100
30 OPEN "COM1:9600,S,7,1,CS0,DS0,CD0,LF" AS #1
35 PRINT "SCAN A FEW BAR CODES"
40 LINE INPUT #1, BARCODE$
50 PRINT BARCODE$
60 K$ = INKEY$: IF K$ = CHR$(27) THEN GOTO 32766
70 GOTO 40
100 PRINT "ERROR NO. "; ERR; " PRESS ANY KEY TO TERMINATE."
110 K$ = INKEY$: IF K$ = "" THEN GOTO 110
32766 CLOSE: SYSTEM
32767 END
```

## APPLICATIONS AND PROTOCOLS

---

The model number on each scanner includes the scanner number and factory default communications protocol.

Scanner	Version Identifier	Communication Protocol(s)
7220	12	RS232, Light Pen, Keyboard Wedge, Stand-Alone Keyboard, OCIA, Low Speed Option

The MS7220 with Built-in PC Keyboard Wedge Interface is designed to be used for keyboard emulation only. Many RS-232 programmable functions available in other Metrologic scanners are also available as keyboard wedge functions.

The following are the most important selectable options specific to the keyboard wedge.

### Keyboard Type

- \*\* AT (includes IBM® PS2 models 50, 55, 60, 80)
- XT
- IBM PS2 (includes models 30, 70, 8556)

### Keyboard Country Type

- \*\* USA
- French
- Italian
- Belgium
- United Kingdom
- German
- Spanish
- Swiss

\*\* Refer to pages 30-35 for complete information on the factory default settings. Refer to the MetroSelect® Programming Guide (MLPN 00-02407 or 00-02561) or MetroSet® 2's help files for information on how to change the default settings.

## DESIGN SPECIFICATIONS

<b>MS7220 DESIGN SPECIFICATIONS</b>	
<b>OPERATIONAL</b>	
Light Source:	VLD 650 ± 10 nm
Laser Power:	0.678 mW maximum
Depth of Field:	0 mm to 215 mm 8.5" at default (programmable)
Scan Speed:	2000 scans/second
Scan Pattern:	5 fields of 4 parallel lines (omnidirectional)
Scan Lines:	20
Min Bar Width:	0.13 mm (5.2 mil)
Decode Capability:	Autodiscriminates all standard bar codes; for other symbologies call Metrologic
System Interfaces:	PC Keyboard Wedge, RS-232, OCIA, Light Pen, Stand Alone PC Keyboard
Print Contrast:	35% minimum reflectance difference
No. Characters Read:	up to 80 data characters(Maximum number will vary based on symbology and density)
Roll, Pitch, Yaw:	360°, 60°, 60°
Beeper Operation:	7 tones or no beep
Indicators (LED):	green = laser on, ready to scan red = good read, decoding
<b>MECHANICAL</b>	
Height:	123 mm (4.8")
Depth:	65mm (2.6")
Width:	168 mm (6.6")
Weight:	0.91 Kg (2 lbs)
Termination:	Four 10-pin modular RJ45 Jacks
Cable:	Standard 2.1m (7') straight; optional 2.7m (9') coiled; for other cables call Metrologic

*Specifications subject to change without notice*



## DESIGN SPECIFICATIONS

<b>MS7220 DESIGN SPECIFICATIONS</b>	
<b>ELECTRICAL</b>	
Input Voltage:	5.2VDC $\pm$ 0.25V
Power:	1.9 W
Operating Current:	360 mA
DC Transformers:	Class II; 5.2 V @ 650 mA
Laser Class:	CDRH: Class IIa; EN 60825-1: 1994/A11:1996 Class 1
EMC:	FCC, ICES-003 & EN 55022 Class A
<b>ENVIRONMENTAL</b>	
Operating Temperature:	0°C to 40°C (32°F to 104°F)
Storage Temperature:	-40°C to 60°C (-40°F to 140°F)
Humidity:	5% to 95% relative humidity, non-condensing
Light Levels:	4842 LUX (450 foot candles)
Contaminants:	Sealed to resist airborne particulate contaminants
Ventilation:	None required

*Specifications subject to change without notice.*

## DEFAULT SETTINGS

---

Many functions of the scanner can be "programmed" - that is, enabled or disabled. The scanner is shipped from the factory programmed to a set of default conditions. The default parameter of the scanner has an asterisk ( \* ) in the charts on the following pages. If an asterisk is not in the default column then the default setting is Off or Disabled. Every communication does not support every parameter. If the communication supports a parameter listed in the charts on the following pages, a check mark will appear.

Parameter	Default	OCIA	RS-232	Light Pen	IBM 46XX	KBW
UPC/EAN	*	✓	✓	✓	✓	✓
Code 128	*	✓	✓	✓	✓	✓
Code 93	*	✓	✓	✓	✓	✓
Codabar	*	✓	✓	✓	✓	✓
Interleaved 2 of 5 (ITF)	*	✓	✓	✓	✓	✓
MOD 10 Check on ITF		✓	✓	✓	✓	✓
Code 11		✓	✓	✓	✓	✓
Code 39	*	✓	✓	✓	✓	✓
Full ASCII Code 39		✓	✓	✓	✓	✓
MOD 43 Check on Code 39		✓	✓	✓	✓	✓
MSI-Plessey		✓	✓	✓	✓	✓
MSI-Plessey 10/10 Check Digit		✓	✓	✓	✓	✓
MSI-Plessey MOD 10 Check Digit	*	✓	✓	✓	✓	✓
Paraf Support		✓	✓	✓	✓	✓
ITF Symbol Lengths	Variable	✓	✓	✓	✓	✓
Minimum Symbol Length	4	✓	✓	✓	✓	✓
Symbol Length Lock	None	✓	✓	✓	✓	✓
Bars High as Code 39	*			✓		
Spaces High as Code 39				✓		
Bars High as Scanned				✓		
Spaces High as Scanned				✓		
DTS/SIEMENS		✓				

## DEFAULT SETTINGS (CONTINUED)

Parameter	Default	OCIA	RS-232	Light Pen	IBM 46XX	KBW
DTS/NIXDORF	*	✓				
NCR F		✓				
NCR S		✓				
Poll Light Pen Source				✓		
Beeper Tone	Normal	✓	✓	✓	✓	✓
Beep/Transmit Sequence	Before Transmit	✓	✓	✓	✓	✓
Communication Timeout	None	✓	✓	✓	✓	✓
Razzberry Tone on Timeout		✓	✓	✓	✓	✓
Three Beeps on Timeout		✓	✓	✓	✓	✓
No Beeps on Timeout	*	✓	✓	✓	✓	✓
Enter Power Save Mode	10 mins.	✓	✓	✓	✓	✓
Same Symbol Rescan Timeout: 200 msec		✓	✓	✓	✓	✓
Same Symbol Rescan Timeout: 500 msec Programmable in 50 msec steps (MAX 6.35 seconds)	*	✓	✓	✓	✓	✓
Same Symbol Rescan Timeout: 1250 msec		✓	✓	✓	✓	✓
Same Symbol Rescan Timeout: 2000 msec		✓	✓	✓	✓	✓
Intercharacter Delay Programmable in 1 msec steps (MAX 255 msec)	1 msec 10 msec in KBW	✓	✓		✓	✓
Number of Scan Buffers	1	✓	✓	✓	✓	✓
Transmit UPC-A Check Digit	*	✓	✓	✓	✓	✓
Transmit UPC-E Check Digit			✓	✓	✓	✓
Expand UPC-E		✓	✓	✓	✓	✓
Convert UPC-A to EAN-13		✓	✓		✓	✓
Transmit Lead Zero on UPC-E		✓	✓	✓	✓	✓

## DEFAULT SETTINGS (CONTINUED)

Parameter	Default	OCIA	RS-232	Light Pen	IBM 46XX	KBW
Convert EAN-8 to EAN-13		✓	✓		✓	✓
Transmit UPC-A Number System	*	✓	✓	✓	✓	✓
Transmit UPC-A Manufacturer ID#	*	✓	✓	✓	✓	✓
Transmit UPC-A Item ID#	*	✓	✓	✓	✓	✓
Transmit Codabar Start/Stop Characters		✓	✓		✓	✓
CLSI Editing (Enable)		✓	✓		✓	✓
Transmit Mod 43 Check Digit on Code 39		✓	✓		✓	✓
Transmit Code 39 Stop/Start Characters		✓	✓		✓	✓
Transmit Mod 10/ITF		✓	✓		✓	✓
Transmit MSI-Plessey Check Characters		✓	✓		✓	✓
Parity	Space		✓			
Baud Rate	9600		✓			
8 Data Bits			✓			
7 Data Bits	*		✓			
Transmit Sanyo ID Characters			✓			✓
Nixdorf ID			✓			✓
LRC Enabled			✓			✓
UPC Prefix			✓			✓
UPC Suffix			✓			✓
Transmit AIM ID Characters			✓			✓
STX Prefix			✓			✓
ETX Suffix			✓			✓

## DEFAULT SETTINGS (CONTINUED)

Parameter	Default	OCIA	RS-232	Light Pen	IBM 46XX	KBW
Carriage Return	*		✓			✓
Line Feed - disabled by default in KBW	*		✓			✓
Tab Prefix			✓			✓
Tab Suffix			✓			✓
"DE" Disable Command			✓			
"FL" Laser Enable Command			✓			
DTR Handshaking Support			✓			
RTS/CTS Handshaking			✓			
Character RTS/CTS	*		✓			
Message RTS/CTS			✓			
XON/XOFF Handshaking			✓			
ACK/NAK			✓			
Two Digit Supplements		✓	✓	as code 39	✓	✓
Five Digit Supplements		✓	✓	as code 39	✓	✓
Bookland 978		✓	✓	as code 39	✓	✓
Bookland 977 (2 digit) Supplemental Requirement		✓	✓	✓	✓	✓
Supplements are not Required	*	✓	✓	✓	✓	✓
Two Digit Redundancy	*	✓	✓	✓	✓	✓
Five Digit Redundancy		✓	✓	✓	✓	✓
100 msec to Find Supplement Programmable in 100 msec steps (MAX 800 msec)	*	✓	✓	✓	✓	✓

## DEFAULT SETTINGS (CONTINUED)

Parameter	Default	OCIA	RS-232	Light Pen	IBM 46XX	KBW
Coupon Code 128		✓	✓	as code 39	✓	✓
Programmable Code Lengths	7 avail.	✓	✓	✓	✓	✓
Programmable Prefix Characters	10 avail.		✓			
Suffix Characters			✓			
Prefixes for individual Code Types						
Editing		✓	✓	✓	✓	✓
Inter Scan-Code Delay Programmable (100 $\mu$ sec steps)	800 $\mu$ sec					✓
Function/Control Key Support						
Minimum Element Width Programmable in 5.6 $\mu$ sec steps	1 msec			✓		
Depth of Field						
Variable Depth of Field	*	✓	✓	✓	✓	✓
Normal Depth of Field	*	✓	✓	✓	✓	✓
Extended Depth of Field		✓	✓	✓	✓	✓
Long Depth of Field	*	✓	✓	✓	✓	✓
Ultra Close Depth of Field		✓	✓	✓	✓	✓

## DEFAULT SETTINGS (CONTINUED)

---

### Default settings for “Aux” interface

The slave scanner and the MS7220 always communicate via RS232. Data is relayed to the host via various primary interfaces.

Parameter	Default	OCIA	RS-232	Light Pen	IBM 46XX	KBW
Aux Baud Rate	38400	✓	✓	✓	✓	✓
Aux parity	space	✓	✓	✓	✓	✓
Aux data bits	7	✓	✓	✓	✓	✓
Aux stop bits	2	✓	✓	✓	✓	✓
Aux character RTS	*	✓	✓	✓	✓	✓
Aux message RTS		✓	✓	✓	✓	✓
Aux Ack/Nak	*	✓	✓	✓	✓	✓
Aux Xon/Xoff	*	✓	✓	✓	✓	✓
Aux D/E commands		✓	✓	✓	✓	✓
Aux M/O commands		✓	✓	✓	✓	✓
Aux F/L commands		✓	✓	✓	✓	✓
Aux Intercharacter Delay	1 msec	✓	✓	✓	✓	✓
Aux Port Data Format	None (Disabled)	✓	✓	✓	✓	✓

# MS7220 STANDS

## Vertical Stand Kit [ MLPN 46-46405 ]

See page 37 for installation instructions.

Kit Includes:

- |                                 |                   |        |
|---------------------------------|-------------------|--------|
| a. #8 x 1 round head wood screw | [ MLPN 18-18057 ] | Qty. 4 |
| b. M3 x .5 x 6mm pan head screw | [ MLPN 18-18670 ] | Qty. 3 |
| c. Vertical base cover          | [ MLPN 36-00363 ] | Qty. 1 |
| d. Cable door                   | [ MLPN 18-18057 ] | Qty. 2 |

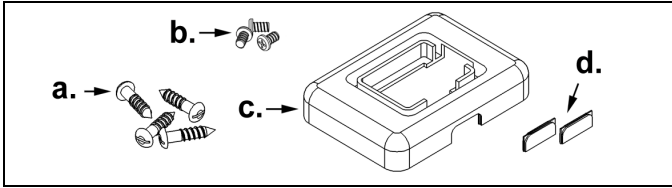

Tools required for installation:

- Flat head screw driver
- Phillips head screw driver
- ¼"-20 wrench
- Drill with #39 drill bit (Needed for hard mount installation only)

## Optional Flex Stand Kit [ MLPN 46-46404 ]

See page 38 for installation instructions.

Kit Includes:

- |                               |                   |        |
|-------------------------------|-------------------|--------|
| a. Long coupler               | [ MLPN 36-00324 ] | Qty. 1 |
| b. Bearing plate              | [ MLPN 36-00501 ] | Qty. 1 |
| c. Bellows                    | [ MLPN 36-36615 ] | Qty. 1 |
| d. Flex pole                  | [ MLPN 36-00351 ] | Qty. 1 |
| e. ¼ -20 x 3/8 pan head screw | [ MLPN 18-18602 ] | Qty. 1 |

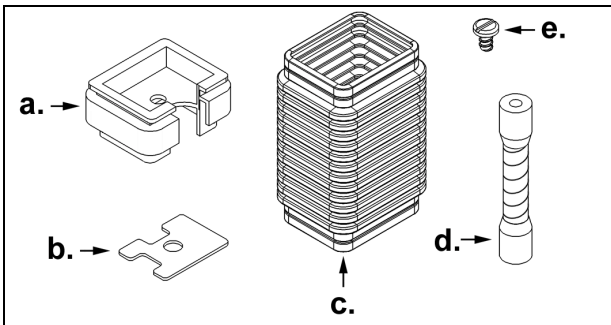

Tools required for installation:

- Flat head screw driver
- Phillips head screw driver
- ¼"-20 wrench
- Drill with #39 drill bit (Needed for hard mount installation only)



# MS7220 STANDS

## Vertical Stand Installation [ MLPN 46-46405 ]

- 1 Remove the three screws securing the cable cover to the unit and slide it up and off the scanner.
- 2 Disconnect the cable and slide the horizontal stand up and off the unit.
- 3 Disassemble the horizontal stand and remove the horizontal cover plate.

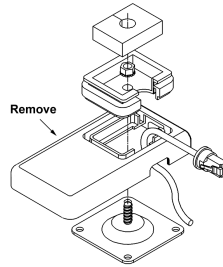
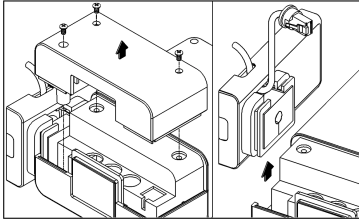

- 4 Mounting the MS7220: Peel off the base plate's tape backing and affix it to the countertop or drill four #39 pilot holes and secure the base plate to the countertop with the four #8 wood screws provided.

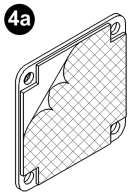

OR

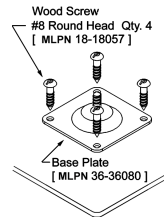
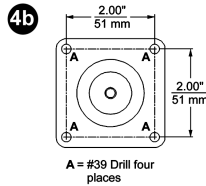

- 5 Replace the horizontal base cover with the vertical base cover [ 36-00363 ] then reassemble.
- 6 Move the side cover from the vertical to the horizontal position on the unit.

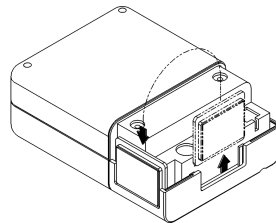
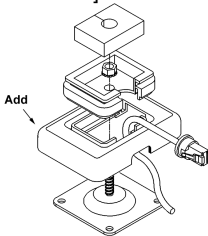

- 7 Slide the vertical stand onto the unit.
- 8 Reattach the cable and secure the cable cover with the three M3 screws.

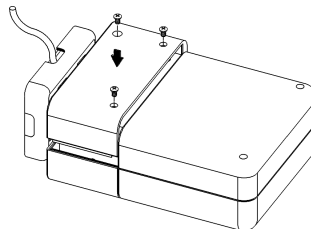
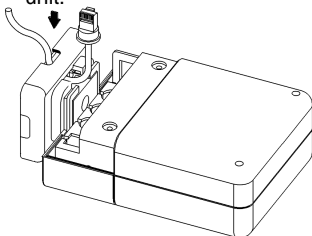

# MS7220 STANDS

## Optional Flexible Stand Installation [ MLPN 46-46404 ]

- 1 Remove the three screws securing the cable cover to the unit and slide it up and off the scanner. Disconnect the cable and slide the horizontal stand up and off the unit.
- 2
- 3 Disassemble the horizontal stand. Remove the lock nut and the short coupler. They will not be used on the flex stand.

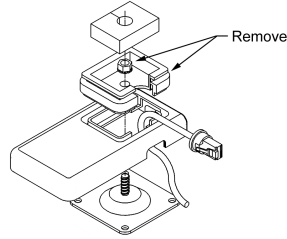
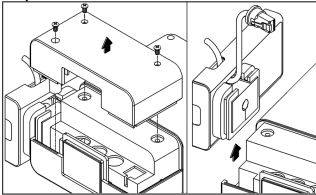

- 4 Mounting the MS7220: Peel off the base plate's tape backing and affix it to the countertop or drill four #39 pilot holes and secure the base plate to the countertop with the four #8 wood screws provided.

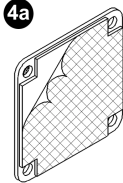

OR

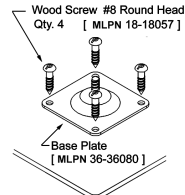
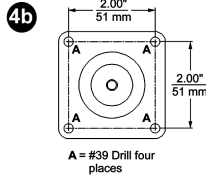

- 5 Slide the bearing plate over the stud on the base plate then attach the flex pole.
- 6 Slide the bellows over the flex pole and cable. Position the long coupler over the top of the bellows. Secure the long coupler in place with the 1/4-20 pan head screw provided then position the foam insert over the screw head.

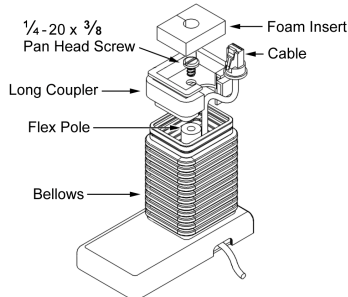
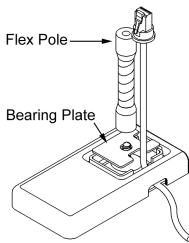

- 7 Slide the flex stand on the unit.
- 8 Reconnect the cable and secure the cable cover with the three M3 screws.

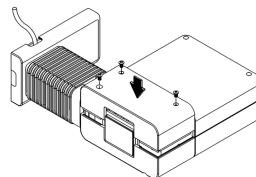
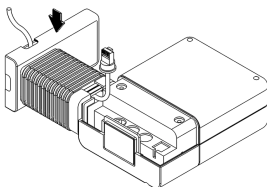

# SCANNER AND CABLE TERMINATIONS

## Scanner Pinout Connections

The MS7220 scanner interfaces terminate to 10-pin modular jacks located on the back of the unit. The serial # label indicates the interface enabled when the scanner is shipped from the factory.

MS7220-12 OCIA	
Pin	Function
1	Ground
2	RS-232 Transmit Output
3	RS-232 Receive Input
4	RDATA
5	RDATA Return
6	Clock in
7	Clock out
8	Clock in Return/Clock out Rtrn
9	+5VDC
10	Shield Ground

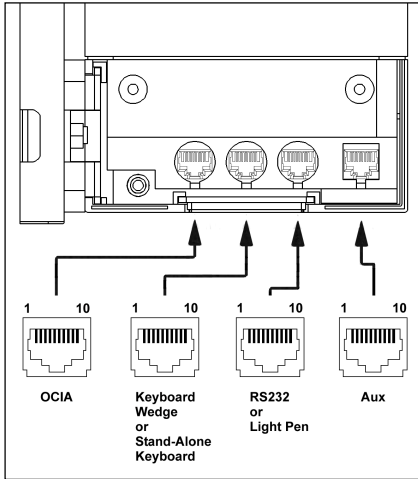

MS7220-12 Keyboard Wedge or Stand-Keyboard	
Pin	Function
1	Ground
2	RS-232 Transmit Output
3	RS-232 Receive Input
4	PC Data
5	PC Clock
6	KB Clock
7	PC +5V
8	KB Data
9	+5VDC
10	Shield Ground

MS7220-12 RS-232 or Light Pen	
Pin	Function
1	Ground
2	RS-232 Transmit Output
3	RS-232 Receive Input
4	RTS Output
5	CTS Input
6	DTR Input/LTPN Source
7	Reserved
8	LTPN Data
9	+5VDC
10	Shield Ground

Continued next page

# SCANNER AND CABLE TERMINATIONS (CONTINUED)

<b>MS7220 Auxiliary Port RS232 IN Only</b>	
<b>Pin</b>	<b>Function</b>
1	Ground
2	RS-232 Receive Input
3	RS-232 Transmit Output
4	RTS in
5	CTS out
6	NC
7	NC
8	NC
9	NC
10	NC

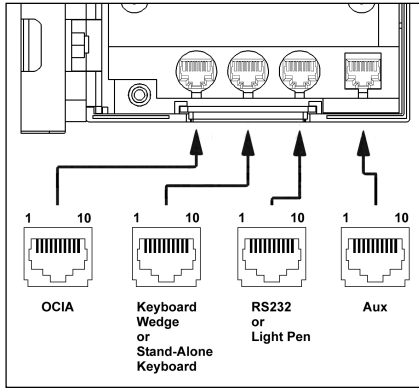

## Cable Connector Configurations

<b>"Standard" PowerLink cable</b>	
<b>Pin</b>	<b>Function</b>
1	Shield Ground
2	RS-232 Transmit Output
3	RS-232 Receive Input
4	DTR Input
5	Power/Signal Ground
6	Reserved
7	CTS Input
8	RTS Output
9	+5VDC

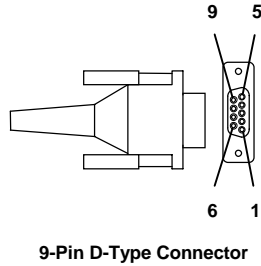

<b>Stand Alone Keyboard Powerlink Cable</b>	
<b>Pin</b>	<b>Function</b>
1	PC Data
2	NC
3	Power Ground
4	+5VDC PC Power to KB
5	PC Clock
6	NC

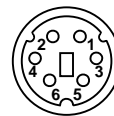

**6-Pin Male Mini-DIN Connector**

**Cable Connector Configuration**

The PowerLink cable is terminated with a 5-pin DIN female connector on one end, and a 6-pin mini DIN male on the other.

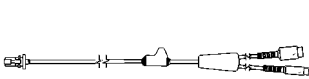

**PowerLink Cable**

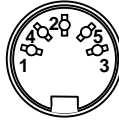

**5-Pin DIN, Female**

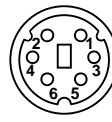

**6-Pin DIN, Male**

Metrologic will supply an adapter cable with a 5-pin DIN male connector on one end and a 6-pin mini DIN female connector on the other.

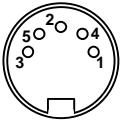

**5-Pin Din, Male**



**Adapter Cable**

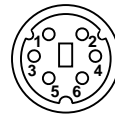

**6-pin Mini Din, Female**

According to the termination required, connect the appropriate end of the adapter cable to the PowerLink cable, leaving the necessary termination exposed for connecting to the keyboard and the keyboard port on the PC. The pin assignments are as follows:

**PowerLink Cable**

<b>5-pin Female DIN</b>	
<b>Pin</b>	<b>Function</b>
1	Keyboard Clock
2	Keyboard Data
3	No Connect
4	Power Ground
5	+5 Volts DC

**Adapter Cable**

<b>5-pin Male DIN</b>	
<b>Pin</b>	<b>Function</b>
1	PC Clock
2	PC Data
3	No Connect
4	Power Ground
5	+5 Volts DC

<b>6-pin Male Mini-DIN</b>	
<b>Pin</b>	<b>Function</b>
1	Keyboard Data
2	No Connect
3	Power Ground
4	+5 Volts DC
5	PC Clock
6	No Connect

<b>6-pin Female Mini-DIN</b>	
<b>Pin</b>	<b>Function</b>
1	Keyboard Data
2	No Connect
3	Power Ground
4	+5 Volts DC
5	Keyboard Clock
6	No Connect

# LIMITED WARRANTY

---

The MS7220 scanners are manufactured by Metrologic at its Blackwood, New Jersey, U.S.A. facility. The MS7220 scanners have a two (2) year limited warranty from the date of manufacture. Metrologic warrants and represents that all MS7220 scanners are free of all defects in material, workmanship and design, and have been produced and labeled in compliance with all applicable U.S. Federal, state and local laws, regulations and ordinances pertaining to their production and labeling.

This warranty is limited to repair, replacement of Product or refund of Product price at the sole discretion of Metrologic. Faulty equipment must be returned to the Metrologic facility in Blackwood, New Jersey, U.S.A. or Puchheim, Germany. To do this, contact Metrologic's Customer Service/Repair Department to obtain a Returned Material Authorization (RMA) number.

In the event that it is determined the equipment failure is covered under this warranty, Metrologic shall, at its sole option, repair the Product or replace the Product with a functionally equivalent unit and return such repaired or replaced Product without charge for service or return freight, whether distributor, dealer/reseller, or retail consumer, or refund an amount equal to the original purchase price.

This limited warranty does not extend to any Product which, in the sole judgement of Metrologic, has been subjected to abuse, misuse, neglect, improper installation, or accident, nor any damage due to use or misuse produced from integration of the Product into any mechanical, electrical or computer system. The warranty is void if the case of Product is opened by anyone other than Metrologic's repair department or authorized repair centers.

THIS LIMITED WARRANTY, EXCEPT AS TO TITLE, IS IN LIEU OF ALL OTHER WARRANTIES OR GUARANTEES, EITHER EXPRESS OR IMPLIED, AND SPECIFICALLY EXCLUDES, WITHOUT LIMITATION, WARRANTIES OF MERCHANTABILITY AND FITNESS FOR A PARTICULAR PURPOSE UNDER THE UNIFORM COMMERCIAL CODE, OR ARISING OUT OF CUSTOM OR CONDUCT. THE RIGHTS AND REMEDIES PROVIDED HEREIN ARE EXCLUSIVE AND IN LIEU OF ANY OTHER RIGHTS OR REMEDIES. IN NO EVENT SHALL METROLOGIC BE LIABLE FOR ANY INDIRECT OR CONSEQUENTIAL DAMAGES, INCIDENTAL DAMAGES, DAMAGES TO PERSON OR PROPERTY, OR EFFECT ON BUSINESS OR PROPERTY, OR OTHER DAMAGES OR EXPENSES DUE DIRECTLY OR INDIRECTLY TO THE PRODUCT, EXCEPT AS STATED IN THIS WARRANTY. IN NO EVENT SHALL ANY LIABILITY OF METROLOGIC EXCEED THE ACTUAL AMOUNT PAID TO METROLOGIC FOR THE PRODUCT. METROLOGIC RESERVES THE RIGHT TO MAKE ANY CHANGES TO THE PRODUCT DESCRIBED HEREIN.

---

## Corporate Headquarters

Metrologic Instruments, Inc.  
90 Coles Road  
Blackwood, NJ 08012-4683

Customer Service: 1-800-ID-METRO  
Tel: 856-228-8100  
Fax: 856-228-6673  
Email: [info@metrologic.com](mailto:info@metrologic.com)  
Website: [www.metrologic.com](http://www.metrologic.com)

---

## Germany

Metrologic Instruments GmbH  
Dornierstrasse 2  
82178 Puchheim b.  
Munich, Germany

Tel: 49-89-89019-0  
Fax: 49-89-89019-200  
Email: [info@europe.metrologic.com](mailto:info@europe.metrologic.com)

# NOTICES

---

## Notice

This equipment has been tested and found to comply with limits for a Class A digital device, pursuant to Part 15 of the FCC Rules. These limits are designed to provide reasonable protection against harmful interference when the equipment is operated in a commercial environment. This equipment generates, uses and can radiate radio frequency energy and, if not installed and used in accordance with the instruction manual, may cause harmful interference to radio communications. Operation of this equipment in a residential area is likely to cause harmful interference, in which case the user will be required to correct the interference at his own expense. Any unauthorized changes or modifications to this equipment could void the users authority to operate this device.

This device complies with Part 15 of the FCC Rules. Operation is subject to the following two conditions: (1) This device may not cause harmful interference, and (2) this device must accept any interference received, including interference that may cause undesired operation.

## Notice

This Class A digital apparatus complies with Canadian ICES-003.

## Remarque

Cet appareil numérique de la classe A est conforme à la norme NMB-003 du Canada.

## Caution

Use of controls or adjustments or performance of procedures other than those specified herein may result in hazardous laser light exposure. Under no circumstances should the customer attempt to service the laser scanner. Never attempt to look at the laser beam, even if the scanner appears to be nonfunctional. Never open the scanner in an attempt to look into the device. Doing so could result in hazardous laser light exposure. The use of optical instruments with the laser equipment will increase eye hazard.

## Attention

L'emploi de commandes, réglages ou procédés autres que ceux décrits ici peut entraîner de graves irradiations. Le client ne doit en aucun cas essayer d'entretenir lui-même le scanner ou le laser. Ne regardez jamais directement le rayon laser, même si vous croyez que le scanner est inactif. N'ouvrez jamais le scanner pour regarder dans l'appareil. Ce faisant, vous vous exposez à une rayonnement laser mortel. L'emploi d'appareils optiques avec cet équipement laser augmente le risque d'endommagement de la vision.

## Achtung

Die Verwendung anderer als der hier beschriebenen Steuerungen, Einstellungen oder Verfahren kann eine lebensgefährliche Laserstrahlung hervorrufen. Der Kunde sollte unter keinen Umständen versuchen, den Laser-Scanner selbst zu warten. Sehen Sie niemals in den Laserstrahl, selbst wenn Sie glauben, daß der Scanner nicht aktiv ist. Öffnen Sie niemals den Scanner, um in das Gerät hineinzusehen. Wenn Sie dies tun, können Sie sich einer lebensgefährlichen Laserstrahlung aussetzen. Der Einsatz optischer Geräte mit dieser Laserausrüstung erhöht das Risiko einer Sehschädigung.

## Attenzione

L'utilizzo di sistemi di controllo, di regolazioni o di procedimenti diversi da quelli descritti nel presente Manuale può provocare dei raggi laser pericolosi per la vita. Il cliente non deve assolutamente tentare di riparare egli stesso lo scanner laser. Non guardate mai nel raggio laser, anche se credete che lo scanner non sia attivo. Non aprite mai lo scanner per guardare dentro l'apparecchio. Se tuttavia lo fate, potete esporvi a dei raggi laser pericolosi per la vita. L'uso di apparecchi ottici con questo equipaggiamento laser aumenta il rischio di danni alla vista.

## NOTICES (CONTINUED)

---

### European Standard

**Warning**

This is a class A product. In a domestic environment this product may cause radio interference in which case the user may be required to take adequate measures.

### Funkstöreigenschaften nach EN 55022:1998

**Warnung!**

Dies ist eine Einrichtung der Klasse A. Diese Einrichtung kann im Wohnbereich Funkstörungen verursachen; in diesem Fall kann vom Betreiber verlangt werden, angemessene Maßnahmen durchzuführen.

### Standard Europeo

**Attenzione**

Questo e' un prodotto di classe A. Se usato in vicinanza di residenze private potrebbe causare interferenze radio che potrebbero richiedere all'utilizzatore opportune misure.

**Attention**

Ce produit est de classe "A". Dans un environnement domestique, ce produit peut être la cause d'interférences radio. Dans ce cas l'utilisateur peut être amené à prendre les mesures adéquates.

## PATENTS

---

### "Patent Information

This METROLOGIC product may be covered by one or more of the following U.S. Patents:

**U.S. Patent No.;**

4,960,985; 5,081,342; 5,216,232; 5,260,553; 5,340,971; 5,343,027; 5,557,093;  
5,627,359; 5,637,852; 5,661,292; 5,686,717; 5,777,315; 5,789,731; 5,828,049;  
6,029,894;

4,360,798; 4,369,361; 4,387,297; 4,460,120; 4,496,831; 4,593,186; 4,607,156;  
4,673,805; 4,736,095; 4,758,717; 4,816,660; 4,845,350; 4,896,026; 4,923,281;  
4,933,538; 4,992,717; 5,081,342; 5,015,833; 5,017,765; 5,059,779; 5,117,098;  
5,124,539; 5,130,520; 5,132,525; 5,140,144; 5,149,950; 5,180,904; 5,200,599;  
5,229,591; 5,247,162; 5,250,790; 5,250,791; 5,250,792; 5,260,553; 5,262,628;  
5,280,162; 5,280,164; 5,304,788; 5,321,246; 5,324,924; 5,340,973; 5,396,053;  
5,396,055; 5,408,081; 5,410,139; 5,424,525; 5,436,440; 5,449,891; 5,468,949;  
5,468,951; 5,479,000; 5,484,992; 5,525,789; 5,528,024; 5,532,469; 5,545,889;  
5,591,953; 5,616,908; 5,627,359

No license right or sublicense is granted, either expressly or by implication, estoppel, or otherwise, under any METROLOGIC or third party intellectual property rights (whether or not such third party rights are licensed to METROLOGIC), including any third party patent listed above, except for an implied license only for the normal intended use of the specific equipment, circuits, and devices represented by or contained in the METROLOGIC products that are physically transferred to the user, and only to the extent of METROLOGIC'S license rights and subject to any conditions, covenants and restrictions therein."

Other worldwide patents pending.



# INDEX

---

## A

Accessories ..... 2  
Adapter ..... 2, 42  
Audible..... 15  
Autodiscriminates ..... 29

## B

Bar Code ..... 19, 20, 21  
Beep ..... 15, 32

## C

Cable ... 2-9, 13, 25-29, 37, 40-42  
Caution ..... 5, 6, 7, 8, 9, 44  
CE..... 44, 45  
Communication..... 28, 32  
Connector ..... 41, 42  
Customer Service ..... 2, 43

## D

Decode Capability ..... 29  
Default Settings ..... 31-36  
Design Specifications ..... 29, 30

## E

Electrical ..... 30  
Extended Depth of Field ..... 35

## F

Failure Modes ..... 16  
Function..... 35, 40, 41, 42

## G

Ground..... 40, 41, 42

## H

Host ..... 11

## I

Indicators ..... 15, 17, 29  
Input Voltage ..... 30  
Installation ..... 2, 5-7, 9-12, 37-39  
Interfaces..... 5, 8, 9, 10, 22

## K

Keyboard Type ..... 28  
Keyboard Wedge1-2, 7, 28-29, 40

## L

Labels ..... 18  
LED..... 13, 15, 17, 22, 23, 29  
Light Levels ..... 30  
Light Pen .... 1, 2, 9, 10, 28-36, 40  
Light Source ..... 29

## M

Maintenance ..... 18  
Mechanical ..... 29  
Min Bar Width..... 29

## N

Normal Depth of Field ..... 35  
Notices ..... 44, 45

## O

OCIA..... 1-6, 28, 29, 31-36, 40  
Operating Current..... 30  
Operation..... 29, 44  
Operational..... 29  
Output Window..... 13

## P

Parts ..... 13  
Patents ..... 45  
Port..... 36, 41  
Programming Guide 2, 15, 26, 28  
Protocols ..... 28

## R

Razberry Tone ..... 15, 16, 32  
RDATA ..... 40  
Repair ..... 43

## S

Scan Lines..... 29  
Scan Pattern..... 29  
Scan Speed..... 29  
Specifications .. 19, 20, 21, 29, 30  
Stand ..... 2, 29, 37, 38, 39  
Storage..... 30  
System Interfaces..... 29

## T

Termination ..... 29  
Transformers ..... 30  
Troubleshooting..... 22-26

## V

Ventilation..... 30  
Visual..... 17  
Voltage ..... 5, 6, 7, 8, 9

## W

Warranty..... 43  
Weight..... 29