

Stop Stealing Sheep, 4th edition

Find out how type works

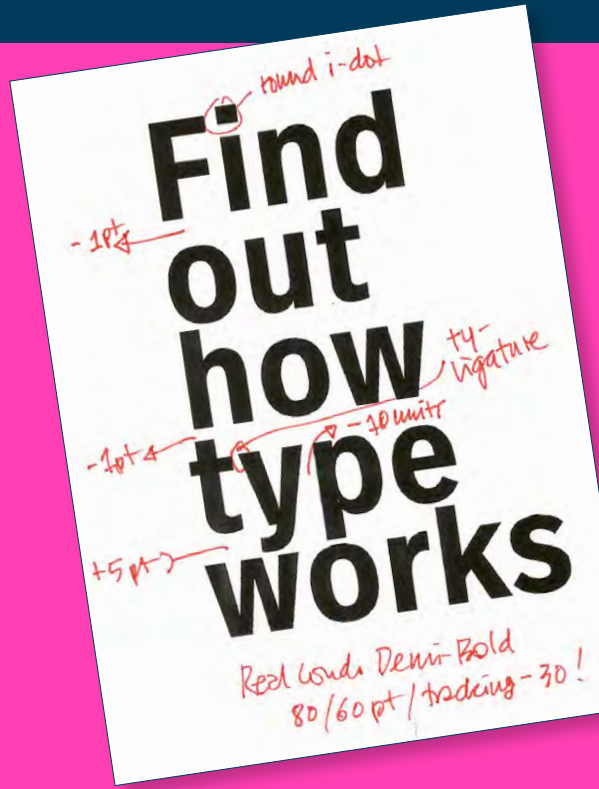

Erik Spiekermann



TOC The
Other
Collection

Layout and typesetting

1ST EDITION Erik Spiekermann, MetaDesign San Francisco

2ND EDITION Erik Spiekermann

3RD AND 4TH EDITION Erik Spiekermann & Ferdinand Ulrich

Type specimens and photographs

Erik Spiekermann, Ferdinand Ulrich, Norman Posselt,
Max Zerrahn, Julie Heumüller, Thomas Nagel

Picture research

Susanna Dulkiny, Ferdinand Ulrich, Norman Posselt, Max Zerrahn

Production management

Daniel Klotz

Index & fact checking

Birgit Schmitz

Typefaces

Primary text typefaces are Equity and **FF Real**.

The pink and black margins are typeset in **FF Real Condensed**, a new family just released, used here for the first time.

Matthew Butterick not only donated his typeface, Equity, but he also indulged us by making some adjustments for the typesetting of this book.

Additional fonts were supplied by Adobe, FontShop, FontBureau, Emigre, House Industries, Gerard Unger, P22, Commercial Type, Terminal Design, ITC International Typeface Corporation, Monotype, Sportsfonts, Google Fonts, and many friends and colleagues.

Paper

Fedrigoni Arena White Smooth FSC

Printed in Italy

Grafiche Antiga, Crocetta del Montello, Italy

© 2022 Erik Spiekermann, p98a.berlin

ISBN 978-3-949164-03-3

Sheep drawing courtesy
of Chuck Anderson
csaimages.com



Stop Stealing Sheep & find out how type works

Fourth Edition: Celebrating 29 years in print!

“Anyone who would letterspace
lower case would steal sheep.”

FREDERIC GOUDY (1865–1947), type designer

AFTER ALMOST THREE DECADES as one of the world’s best-selling introductions to designing with type – including editions in Korean, German, Russian, Portuguese, and even Thai – *Stop Stealing Sheep & find out how type works* continues to educate, entertain, and enlighten design students and type lovers around the globe.

In this fourth edition, Erik Spiekermann brings his type classic fully up-to-date with an all-new chapter on variable typefaces, scores of visual examples on how to effectively communicate with type, and a full selection of new typefaces used and referenced throughout the book.

If you use type – and these days, almost everyone does – Spiekermann’s engaging, commonsense style will help you understand how to look at type, work with type, choose the best typeface for your message, and express yourself more effectively through design. Compact, yet rich with anecdotes and visual examples, the handbook’s multilayered design not only makes for a fun, fast read, but it also invites exploration, ensuring you learn something new each and every time you open it up.

Erik Spiekermann is information architect, type designer and author of numerous books and articles on type & typography. A book about him *Hello, I am Erik* by Johannes Erler was published by Gestalten Verlag in 2014. He now runs p98a.berlin, an experimental letterpress shop.

“Sheepbook” 4.0
The bestselling publication about type & typography since 1993, now in its fourth printing. With new chapters, new typefaces and the same old typographic jokes.

Erik Spiekermann (*1947) studied History of Art and English in Berlin. He is information architect, type designer (FF Meta, FF Meta Serif, ITC Officina, FF Info, FF Unit, FF Unit Slab, FF Real, LoType, Berliner Grotesk, et al), and many corporate typefaces for *The Economist*, Cisco, Bosch, Deutsche Bahn, Heidelberg Printing, Mozilla, etc), and author of books and articles on type and typography.

In 1979 he started MetaDesign, Germany's largest design studio, and in 1989 FontShop, the first independent distributor of electronic fonts. Erik's many awards and medals would be too boring to list.

Apart from being on the board of Edenspiekermann, he now runs p98a.berlin, an experimental letterpress workshop in Berlin whose motto is "Hacking Gutenberg". Spiekermann lives and works in Berlin, London and San Francisco. He owns 15 bicycles and has 290,000 followers on Twitter.

Ferdinand Ulrich (*1987) is a typographer. He teaches design fundamentals at Berlin University of the Arts and pursues doctoral research at the University of Reading, UK. His articles are frequently published in *Eye*, *typographica.org*, et al.

Julie Heumüller (*1993) is a graphic designer. Next to her work as a freelance designer, she is an associate with the research group "Digital Self-Determination" at Berlin University of the Arts, where she also took her Master degree in Visual Communication.

Norman Posselt (*1985) is a commercial photographer and re-toucher; typography is his hobby. By contributing some photographs to this book he mixes both passions. In his spare time he captures antique floor tiles in Berlin and writes for *typefacts.com*

Daniel Klotz (*1971) is a printer and typesetter. His skillset spans from metal typesetting and letterpress to digital pre-press and printing technologies. At *lettertypen.de* he prints on a Heidelberg Cylinder and takes good care of production management for publishers.

This book is published in PDF format under a
Creative Commons Attribution-No Derivatives 4.0 license.
The full text of the license is available at
<https://creativecommons.org/licenses/by-nd/4.0/>

Please Respect the License!

1	Type is everywhere. Type exists. It is a fundamental part of our lives. These simple facts are essential to understanding how to communicate more effectively.	8
2	What is type? Between type's past and its future, our present understanding of type is rooted in who we are and how we communicate. Type is a living entity integrated into society's moods and trends.	26
3	Looking at type. Training the eye to recognize type begins with familiar elements on the page. Looking at type from the basic shapes to the finest details is the first step toward understanding how type works.	38
4	Type with a purpose. Choosing typefaces for a particular purpose need not be more intimidating than planning your wardrobe. Matching an appropriate typeface with the right task is easy.	60
5	Type builds character. Understanding the tone, or feeling, of text is essential in determining what typeface to use, and how it might be arranged on the page.	78
6	Types of type. Once understood, basic characteristics of typefaces, can eliminate difficulty with typeface identification. Simple distinctions among typefaces are best understood by analogy to human counterparts.	102
7	How it works. Legible, readable type depends on a few basic principles: space between individual letters and around words. Choosing the right typeface for the right text also means using the right spacing.	134
8	Putting it to work. Considering where type is going to live and work will determine its effectiveness. Simple rules of placement create practical page layouts.	154
9	Type on screen. Type on screen used to be the poor sister of type for print. While technical constraints remain, there are no more excuses for not choosing the appropriate typeface for any project that will appear on a screen.	172
10	Variable fonts. The variable font format allows a single file to contain <i>all</i> previously separate files (e. g. from Light to Black) in a single, highly efficient one.	180
11	There is no bad type. Type is a basic element of communication. As the means of communicating changes, type evolves in unique and lively ways.	188
12	Final form. Bibliography, list of typefaces, index, partners.	212



STEALING SHEEP? Letterspacing lower case? Professionals in all trades, whether they be dentists, carpenters, or nuclear scientists, communicate in languages that seem secretive and incomprehensible to outsiders; type designers and typographers are no exception. Typographic terminology sounds cryptic enough

We see so much type that we sometimes stop looking. This is not necessarily a bad thing, as in the case of this sign, which tells us that we may not enter this street between eleven and six, nor between eleven and six, and certainly not between eleven and six.

to put off anyone but the most hard-nosed typomaniac. The aim of this book is to clarify the language of typography for people who want to communicate more effectively with type. These days people need better ways to communicate to more diverse audiences. We know from experience that what we have to say is much easier for others to understand if we put it in the right voice; type is that voice, the visible language linking writer and reader. With thousands of typefaces available, choosing the right one to express even the simplest idea is bewildering to most everyone but practiced professionals.

Familiar images are used in this book to show that typography is not an art for the chosen few, but a powerful tool for anyone who has something to say and needs to say it in print or on a screen. You will have ample opportunity to find out why there are so many typefaces, how they ought to be used, and why more of them are needed every day.

This is a sidebar. As you can see by the small type, the copy here is not for the faint of heart, nor for the casual reader. All the information that might be a little heady for novices is in these narrow columns; it is, however, right at hand when one becomes infected by one's first attacks of typomania.

For those who already know something about type and typography and who simply want to check some facts, read some gossip, and shake their heads at our opinionated comments, this is the space to watch.

In 1936, Frederic Goudy was in New York City to receive an award for excellence in type design. Upon accepting a certificate, he took one look at it and declared that "Anyone who would letterspace black letter would steal sheep." (Goudy actually used another expression, one unfit for print.) This was an uncomfortable moment for the man sitting in the audience who had hand lettered the award certificate. Mr. Goudy later apologized profusely, claiming that he said that about everything.

You might have noticed that our book cover reads "lower case," while here it reads "black letter" – two very different things. Lower case letters, as opposed to CAPITAL LETTERS, are what you are now reading; black letter isn't seen very often and looks like this.

We're not sure how "black letter" in this anecdote got changed to "lower case," but we've always known it to be the latter; whichever way, it makes infinite sense. By the time you finish this book we hope you will understand and be amused by Mr. Goudy's pronouncement.



See the changes made to the sign in the last three decades: the small picture on the right is from this book's first edition, printed in 1992; the one on its left is from the second edition in 2003, and the small one on the opposite page from Sheep 3.0 in 2014. Big picture is from 2020.

PAUL WATZLAWICK

You cannot *not*
communicate.

(1922–2007) is author of *Pragmatics of Human Communication*, a book about the influence of media on peoples' behavior. "You cannot not communicate" is known as Watzlawick's First Axiom of Communication.

Typeset in Equity

CHAPTER 1

Type is
everywhere.

FF Real Head Thin

HAVE YOU EVER BEEN to Japan? A friend who went there recently reported that he had never felt so lost in his life. Why? Because he could not read anything: not road signs, not price tags, not instructions of any kind. It made him feel stupid,

Works in most languages, avoiding tasteless mistakes: S for Salt and P for Pepper.

he said. It also made him realize how much we all depend on written communication.

Picture yourself in a world without type. True, you could do without some of the ubiquitous advertising messages, but you wouldn't even know what the packages on your breakfast table contained. Sure enough, there are pictures on them – grazing cows on a paper carton suggest that milk is inside, and cereal packaging has appetizing images to make you hungry. But pick up salt or pepper, and what do you look for? S and P!



Try to find your way around without type and you'll be as lost as most of us would be in Japan, where there is plenty of type to read, but only for those who have learned to read the right sort of characters.



You've hardly got your eyes open when you have to digest your first bite of type. How else would you know how much calcium fits on your spoon?

NIEDERWALL STREET JOURNAL.

e Heft. Handel!
ationen unter
zeitcampus
mpus

DIE ZEIT



LAND 5,50 €

WOCHENZEITUNG FÜR POLITIK WIRTSCHAFT WISSEN UND KULTUR

Frankfurter Allgemeine

ZEITUNG FÜR DEUTSCHLAND

FINANCIAL TIMES

THURSDAY 15 AUGUST 2019 WORLD BUSINESS NEWSPAPER EUROPE

CHIC LOWLY S, SEXY LE



A CITY ABUZZ BERLIN'S PROBLEM: TOO MANY BEES PAGE TWO



OUTSIDE THE GUIDEBOC IN CROATIA, AVOIDING THE SELFIE-STICK CROW PAGE 15 | TRAVEL

The New York Times

INTERNATIONAL EDITION | THURSDAY, AUGUST 15, 2019

mercredi 14 août 2019 LE FIGARO - N° 23 327 - Cahier N° 2 - Ne peut être vendu séparément - www.lefigaro.fr

LE FIGARO économie

lefigaro.fr/economie

> FOCUS TAXES: WASHINGTON

JEUDI 15 AOÛT 2019 75^e ANNÉE - N° 23201 2,80 € - FRANCE METROPOLITAINE WWW.LEMONDE.FR FONDATEUR: HUBERT BEUVE-MÉRY DIRECTEUR: JÉRÔME FENOGLIO

Le Monde L'ÉTÉ

新案閉倒團集海東
二約產資結凍
同取望可主基

ري في مجتمعنا
مع كله وستدور بتكاتف ا
توات ثون نسبة الزيادة ال

What appears frightfully complex and incomprehensible to people who can read only the Latin alphabet brings news to the majority of the world's population. Chinese and Arabic alphabets are read by more than half the people on this planet.

ăâæäàöøçβιζ

Some of the accents, special signs, and characters seen in languages other than English, giving each of them its unique appearance.

Breakfast for some people wouldn't be the same without the morning paper. And here it is again: inevitable type. Most people call it "print" and don't pay too much attention to typographic subtleties. You've probably never compared the small text typefaces in different newspapers, but you do know that some newspapers are easier to read than others. It might be because they have larger type, better pictures, and lots of headings to guide you through the stories. Regardless, all these differences are conveyed by type. In fact, a newspaper gets its look, its personality, from the typefaces used and the way in which they are arranged on the page. We easily recognize our favorite newspapers on the newsstand, even if we see only the edge of a page, just as we recognize our friends by seeing only their hands or their hair. And just as people look different across the world, so do the newspapers in different countries. What looks totally unacceptable to a North American reader will please the French reader at breakfast, while an Italian might find a German daily paper too monotonous.

Type says much more about a newspaper than just the information it carries.

Of course, it's not only type or layout that distinguishes newspapers, it is also the combination of words. Some languages have lots of accents, like French; some have very long words, like Dutch or Finnish; and some use extremely short words, as in a British tabloid. Not every typeface is suited for every language, which also explains why certain type styles are popular in certain countries, but not necessarily anywhere else.



Newspaper design changes very slowly: the picture on the right is from this book's first edition, printed in 1992; the color one in the middle is from the second edition in 2003, and the photograph on the left was taken for the third edition in 2013.



USA TODAY 09.03.13 A GANNETT COMPANY



'Riddick' made for fans

Vin Diesel, director moved by pleas for follow-up to "Chronicles" 1D



The man behind Serena How their complex relationship works 1C

NEWSLINE

'Never too old to chase your dreams'



Diana Nyad, 64, arrives at Key West after swimming 100 miles from Cuba without a shark cage. STORY 4A

Elite college doesn't always mean higher pay

Some graduates with 2-year technical degrees earn more in their first jobs, research shows. 4A

A chance to make Fed history

Janet Yellen could become the first woman to lead the Federal Reserve. 1B

Smartwatches are on the way

Sony, Samsung expected to show off devices in Berlin this week. 2B

Remembering David Frost

How British talk show host, who died Saturday, broke down Nixon. Opinion, 8A

Choose the right school

Find USA TODAY's 112-page guide at newsstans or at college guide.usatoday.com.

NEWS PHOTOS OR READER Scan with a QR reader; AT&T code scanner available at scan.mobi. Get codes for your business at att.com/mcode. Version: ProReader

HOME DELIVERY 1-800-872-4000 USATODAYSERVICE.COM

36 RECYCLED PAPER

USA SNAPSHOTS®

Biking to work Percentage of residents who say bicycling is their main

Verizon's \$130B deal

Finally, telecom giant to wholly own wireless unit; move reflects competition in mobile 1B

CBS blackout over

Ends pay dispute with Time Warner Cable; programming restored in Dallas, LA, NYC 4A

SYRIA SELL BEGINS



"If the Congress were to reject a resolution like this after the president ... has already committed to action, the consequences would be catastrophic."

Sen. John McCain, R-Ariz.



"Mr. President - clear the air. Be decisive, be firm about why it matters to us as a nation to get Syria right."

Sen. Lindsey Graham, R-S.C.



"This provides the president time to make his case to Congress and the American people."

House Speaker John Boehner, R-Ohio



"The Senate will rubber stamp what (Obama) wants but I think the House will be a much closer vote. And there are a lot of questions we have to ask."

Sen. Rand Paul, R-Ky.



"Authorization by Congress for action will make our country and the response in Syria stronger. ... I look forward to the debate."

House Minority Leader Nancy Pelosi, D-Calif.



"People's representatives must be invested in what America does abroad ... (It's time) to show the world that America keeps our commitments."

President Obama

Six key players to watch in debate over authorizing military action

Susan Davis and Aamer Madhani USA TODAY

WASHINGTON A week ago, it seemed the question of whether to take military action against Syria rested solely on the shoulders of President Obama.

But he has turned to Congress to authorize military airstrikes against Syria for using chemical weapons, setting up the most consequential

foreign policy vote since the 2002 authorization of the Iraq War.

Obama and his supporters on Capitol Hill will have to overcome broad skepticism about the merits of military strikes and navigate the political divisions that have left Congress largely paralyzed.

The vote also cast a spotlight on key lawmakers who will be critical in determining whether or not Congress authorizes Obama to use military force. Congress is still on recess, but the arm-twisting has be-

gun and the Syria resolution will be the first order of business in both the House and Senate when they return Sept. 9.

The debate will pit Obama and House Democratic leader Nancy Pelosi against both Republicans and Democrats skeptical of foreign military intervention. The White House will need support from Republican leaders such as Speaker John Boehner, R-Ohio, and Sen. John McCain

► STORY CONTINUES ON 2A

McCain, Graham express optimism on Obama's plan

Paul Singer and Aamer Madhani USA TODAY

President Obama's bid to get congressional support to use military force in Syria received a boost Monday as Republican Sens. John McCain and Lindsey Graham said they have more confidence the White House is developing a better strategy for dealing with Syria.

McCain and Graham are key votes Obama will need to win Senate approval for the United States to launch missile strikes against Syria in response to an Aug. 21 chemical weapons attack that killed more than 1,400 people.

Obama said Saturday that he has concluded the United States should launch a strike in response to the attack, but he said he wants approval first from Congress.

McCain of Arizona and Graham of South Carolina have jointly expressed concerns that a military strike should be part of a broader strategy in Syria, not simply a random attack to punish the regime.

After meeting with Obama on Monday, they both said they believe the White House is developing a strategy that would weaken the regime of President Bashar Assad and boost Syrian opposition forces — though they said Obama has more work to do to explain this plan.

"We still have significant concerns," McCain said, "but we believe there is an opportunity for formulation a strategy to upgrade the capabilities of the Free Syrian Army and to degrade the capabilities of Bashar Assad. Before this meeting, we had not had that indication."

Obama may have weakened presidency By seeking OK from Congress, he reverses precedent. Analysis, 3A

McCain repeatedly said a congressional vote rejecting the use of military force would be "catastrophic" to U.S. interests and would destroy the credibility of the nation in the eyes of both allies and adversaries.

Graham said, "If we don't get Syria right, Iran is surely going to take the signals that we don't care about their nuclear program ... If we lost a vote in Congress dealing with the chemical weapons being used in Syria, what effect would that have on Iran and their nuclear program?"

Both senators criticized the administration for not having a clearer strategy in Syria before now.

In Syria on Monday, Assad told a journalist with the French newspaper Le Figaro that any attack risked opening a wider war in the region.

Syria has challenged the United States and France to provide proof to support allegations that Damascus

This brings us back to type and newspapers. What might look quite obvious and normal to you when you read your daily paper is the result of careful planning and applied craft. Even newspapers with pages that look messy are laid out following complex grids and strict hierarchies.

The artistry comes in offering the information in such a way that the reader doesn't get sidetracked into thinking about the fact that someone had to carefully prepare every line, paragraph, and column into structured pages.

USA Today, one of the leading newspapers in the United States, is designed to a grid.

Design - in this case, at least - has to be invisible. Typefaces used for these hardworking tasks are therefore, by definition, "invisible." They have to look

so normal that you don't even notice you're reading them. And this is exactly why designing type is such an unknown profession; who thinks about people who produce invisible things? Nevertheless, every walk of life is defined by, expressed with, and indeed, dependent on type and typography.

More and more people read the news not on paper, but on TV screens or computer monitors. Type and layout have to be reconsidered for these applications.

Just as the newspaper on the opposite page is laid out according to an underlying structure of some intricacy, this book is designed within its own constraints.

The page is divided into equal parts, each of which has the same proportion as the whole page, i.e., 2:3. The page is made up of 144 rectangles, each one measuring 12 by 18 millimeters, 12 rectangles across and 12 down. This makes the page 144 by 216 millimeters, or roughly 5 23/32 by 8 1/2 inches.

The columns are multiples of the 12-millimeter unit. As there has to be some distance between columns, 3 mm (or more for wider columns) have to be subtracted from these multiples of 12 to arrive at the proper column width.

The distance between lines of type (still archaically referred to as leading - rhymes with heading) is measured in multiples of 1.5 mm.

- All typographic elements are positioned on this baseline grid of 1.5 mm, which is fine enough to be all but invisible to the reader, but which helps layout and production. The discipline offered by this kind of fine grid gives the same sort of coherence to a page as bricks do to a building. They are small enough to allow for all styles of architecture, white serving as the common denominator for all other proportions.

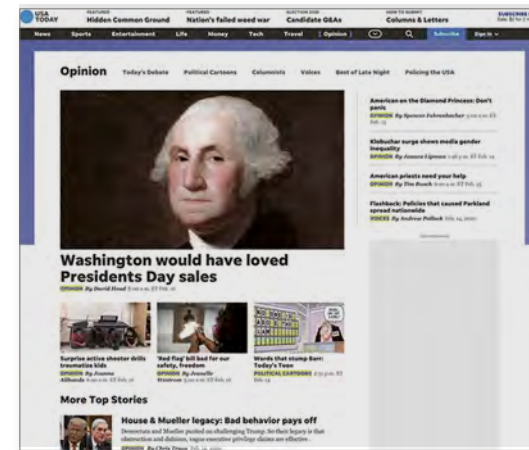

At 64, a swim for the record books

Woman finishes solo Cuba-to-Florida trip

William M. Welch



to everyone," tweeted former Florida congressman and MSNBC morning host Joe Scarborough.

Looking a bit dazed and puffy from her ordeal, Nyad made brief remarks



If you think that the choice of a typeface is something of little importance because nobody would know the difference anyway, you'll be surprised to hear that experts spend an enormous amount of time and effort perfecting details that are invisible to the untrained eye.

It is a bit like having been to a concert, thoroughly enjoying it, then reading in the paper the next morning that the conductor had been incompetent, the orchestra out of tune, and the

piece of music not worth performing in the first place. While you had a great night out, some experts were unhappy with the performance because their standards and expectations were different than yours.

Food and design: how often do we buy the typographic promise without knowing much about the product? Stereotypes abound - some colors suggest certain foods, particular typefaces suggest different flavors and qualities. Without these unwritten rules we wouldn't know what to buy or order.

The same thing happens when you have a glass of wine. While you might be perfectly happy with whatever you're drinking, someone at the table will make a face and go on at length about why this particular bottle is too warm, how that year was a lousy one anyway, and that he just happens to have a case full of some amazing stuff at home that the uncle of a friend imports directly from France.

Does that make you a fool or does it simply say that there are varying levels of quality and satisfaction in everything we do?

Effects that mimic hand lettering, stone carving, sewing, etching or even metal type-setting are all easily achieved electronically.



JEDEM
DAS SEINE
SUUM CUIQUE
Chacun à son goût

As they say in England:
"Different strokes for
different folks."

The kinds of food and drink known to mankind are almost limitless. No single person could be expected to know them all. One guide through this maze of taste and nourishment, of sustenance as well as gluttony, is offered by the labels on products - as long as they are packaged in containers that can carry information. Without typography we wouldn't know which contains what or what should be used which way.

Small wonder that type on food packages is often hand lettered, because standard typefaces don't seem to be able to express this vast a range of tastes and promises. These days, hand lettering sometimes means using software programs, such as Adobe Illustrator, that combine design and artwork at a level unimaginable only a few years ago. Anything a graphic designer can think of can be produced in amazing quality.



While it might be fun to look at wine labels, chocolate boxes, or candy bars in order to stimulate one's appetite for food or fonts (depending on your preference), most of us definitely do not enjoy an equally prevalent form of printed communication: forms.

If you think about it, you'll have to admit that business forms process a lot of information that would be terribly boring to have to write fresh every time. All you do is check a box, sign your name, and *you* get what you ask for. Unless, of course, you're filling out your tax return, when *they* get what they ask for; or unless the form is so poorly written, designed, or printed (or all of the above) that you have a hard time understanding it. Given the typographic choices available, there is no excuse for producing bad business forms, illegible invoices, awkward applications, ridiculous receipts, or bewildering ballots. Not a day goes by without one's having to cope with printed matter of this nature. It could so easily be a more pleasant experience.

While onscreen forms offer a very reduced palette of typographic choices, they at least provide some automatic features to help with the drudgery of typing your credit card number.

Typefaces used for business communications have often been designed for a particular technology - optical character recognition, needle printers, monospaced typewriters, and other equipment.

What was once a technical constraint can today become a trend. The "nondesigned" look of OCR B, the good old honest typewriter faces, even the needle printer, and other low-resolution alphabets have all been exploited by designers to evoke certain effects.

If you want to avoid any discussion about the typefaces you're using in your letters or invoices, you can fall back onto Courier, Letter Gothic, or other monospaced fonts (see page 175), even though they are less legible and take up more space than "proper" typefaces. You could be slightly more courageous and try one of those new designs that were created specifically to address both the question of legibility and space economy, and reader expectations.

The "generic" look of most business forms usually derives from technical constraints. But even when those restrictions no longer exist, the look lingers on, often confirming our prejudice against this sort of standardized communication.

Typefaces designed with technical constraints.

These are some of the new typefaces designed to work well on low-resolution output devices, such as simple printers and small screens.

Handgloves

IA WRITER QUATTRO

Handgloves

LUDICA

Handgloves

ITC OFFICINA SANS

Handgloves

VERDANA

Handgloves

LETTER GOTHIC

Handgloves

COURIER

Handgloves

OCR B

Every PC user today knows what a font is, calls at least some of them by their first name (e.g. Helvetica, Calibri, and Times), and

When each egg has data stamped on it, we wonder how the type got there. Does each chicken have its own little rubber-stamp? Or do all the eggs roll by a machine, which gently impresses onto that most breakable of surfaces? And do different sorts of eggs have different types on them? Brush Script for free-range, (see page 195), Copperplate for the expensive gourmet ones from geese and Helvetica for battery eggs?

appreciates that typefaces convey different emotions. Although what we see on screen are actually little unconnected square dots, that fool the naked eye into recognizing pleasant shapes, we now expect all type to look like “print.”

While there is a tendency to overdesign everything and push technology to do things it was never intended to do, like printing onto raw eggs, at least we can continue our typographic training

even when deciding whether the food we bought is good for nourishing or not.

We don't know whether the makers of Brunello di Montalcino deliberately chose the tall type for the labels on their wine bottles, but the widely spaced figures and the robust caps possess a certain elegance. As Monotype shows with their Andale Mono (which comes free with Microsoft software), there is room for good design even within the constraints of mono-spaced system fonts. Bar codes and ocr numbers are inseparable, but even that generic alphabet has already inspired a whole new type. And if you must imitate the printing on eggshells, FF Atlanta has the blotchy outlines needed to do so convincingly. While the makers of dot matrix printers try to emulate real logos, the designers of real fonts deliver the tools to print your supermarket receipts.

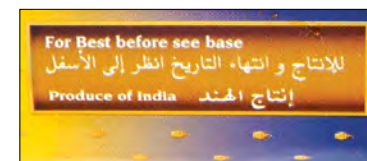

HANDGLOVES

FF ATLANTA

Handgloves

ANDALE MONO

Handgloves

FF OCR F LIGHT

Handgloves

FF OCR F REGULAR

Handgloves

FF OCR F BOLD

Handgloves

FF DOT MATRIX TWO



A Dark type on a light background needs some weight to be legible, but not too much.



B Light type on a dark background has to be a little thinner in order to appear as legible as the other version.

Some of the most pervasive typographical messages have never really been designed, and neither have the typefaces they are set in. Some engineer, administrator, or accountant in some government department had to

Several countries adopted the British Transport alphabet for their road signage. Unfortunately, somebody made the type much fatter: probably an engineer who thought that more weight is more legible. The opposite is true.

decide what the signs on our roads and freeways should look like. This person probably formed a committee made up of other engineers, administrators, and accountants who in turn went to a panel of experts that would have included manufacturers of signs, road safety experts, lobbyists from automobile associations plus more engineers, administrators, and accountants.

You can bet there wasn't one typographer or graphic designer in the group, so the outcome shows no indication of any thought toward legibility, let alone communication or beauty. Nevertheless we're stuck with our road signs. They dominate our open spaces, forming a large part of a country's visual culture.

Traditional type for signs used to be constructed from geometric patterns so that they could be recreated by signmakers everywhere. Type as data travels more easily, so there are no more excuses for not having real type on signs.

Signage systems have to fulfill complex demands. Reversed type (e.g., white type on a blue background) looks heavier than positive type (e.g., black on yellow), and back-lit signs have a different quality than front-lit ones. Whether you have to read a sign on the move (from a car, for example), or white standing still on a well-lit platform, or in an emergency - all these situations require careful typographic treatment. In the past these issues have been largely neglected, partly because it would have been almost impossible to implement and partly because designers chose to ignore these problems, leaving them up to other people who simply weren't aware that special typefaces could help improve the situation.

These have now been designed with a series of closely-related weights to offer just the right one, whether it's for a back-lit dark sign with white type, or for just black words on white, lit by the sun from above. The PostScript™ data generated with these types in drawing and layout applications can be used to cut letters of any size from vinyl, metal, wood, or any other material used for signs.

There are no more excuses for badly designed signs, whether on our roads or inside our buildings.

Handgloves

FRUITIGER

Handgloves

TRANSPORT

Handgloves

CLEARVIEW



C Too much weight makes the counters, the space inside the letters, almost disappear. Letters become blobs.

Handgloves

TERN



D Reversing out increases that effect. Backlit signs would look even worse (see next page).



Engineers are still responsible for the signs on our roads and freeways. And they still think that Arial is the best typeface ever, simply because it is ubiquitous. But there are signs (!) of progress even in those circles: The new German DIN (*Deutsche Industrie Norm* = German Industrial Standard) committee finally acknowledged what a lot of designers have always known: Some characters are easily confused with each other. A figure 1 looking like a lowercase l and a capital I (sic!) are majors offenders. The new DIN 1450 suggests a lowercase l with a loop, a capital I with serifs, and a figure 1 with a horizontal bottom stroke.

Why not use serif faces in the first place, you may ask? Interesting question, and unfortunately one not even discussed amongst the engineers on the committee (although there was a real type designer present). They think that serif faces are old-fashioned and could not possibly be used for signage or any other contemporary purpose.

Since this book was first published in 1993, quite a few type designers have turned their attention to this field, although neither fame nor fortune are likely to be made here.

The US freeways now have Clearview, a typeface designed by James Montalbano, based on the existing Highway Gothic, but actually legible and friendly. Airports the world over have adopted Frutiger, the typeface originally designed for Charles de Gaulle airport in Paris in 1976. It has recently been updated with its signage version featuring that special l, the 1 and a dotted 0.

Berlin Transit has had their special version of Frutiger Condensed, called FF Transit, since 1992. Düsseldorf Airport has signs in FF Info. Ralf Herrmann designed a typeface called Wayfinding Sans. Vialog was developed by Werner Schneider and Helmut Ness for wayfinding projects, as was Arrival by Keith Chi-hang Tam.

FRUTIGER 1450 now legible

Wayfinding Sans

FF Transit Front Positive

FF Info Display

Arrival ↗

Linotype Vialog

Clearview

Information

A Light type on dark shouldn't be too bold.

Information

B When lit from behind, type appears even bolder.

Information

C A thinner version of the typeface needs to be used.

Information

D Now shapes are easier to make out.

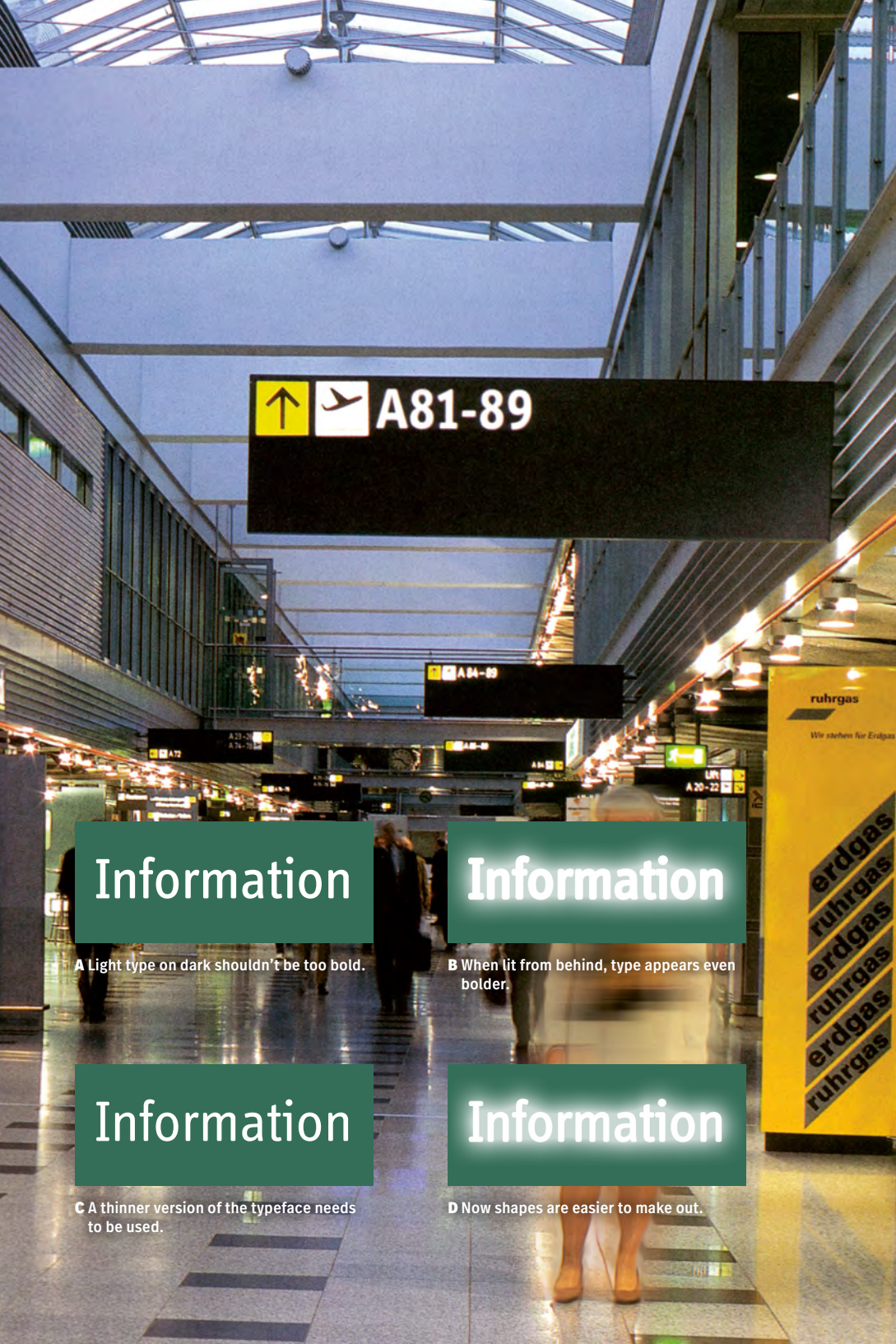

TALLULAH BANKHEAD

There is less
in this than
meets the
eye.

(1903–1968) was a celebrated
international actress and scandalous public figure.
Ms. Bankhead did all the wrong things with consummate
flair and in the best of taste.

Dunbar

CHAPTER 2

What is type?

FF Real Head Ultra Light



EVER SINCE PEOPLE HAVE been writing things down, they have had to consider their audience before actually putting pen to paper: Letters would have to look different depending

The official Roman alphabet, as displayed in this photograph of the Trajan Column in Rome, never went out of fashion.

Below: Many digital typefaces evoke the timeless beauty of ancient inscriptions and early printing types. Adobe Trajan, designed by Carol Twombly in 1990, is a good example.

on whether they were to be read by many other people (in official documents or inscriptions), just one other person (in a letter), or only the writer (in a notebook or a diary).

There would be less room for guesswork if letter shapes were made more formal as the diversity of the readership expanded.

Some of the first messages to be read by a large number of people were rendered not by pens but by chisels.

Large inscriptions on monuments in ancient Rome were carefully planned, with letters drawn on the stone with a brush before they were chiseled. Even if white-out had existed in those days, it would not have helped to remove mistakes made in stone. A bit of planning was also more important then, since stonemasons were sometimes more expendable than slabs of marble or granite.

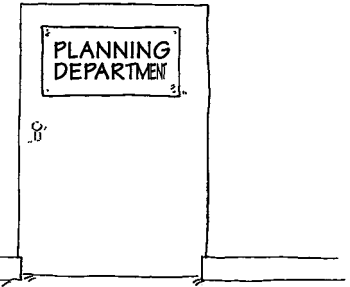

Graphic design and typography are complicated activities, but even simple projects benefit from thinking about the problem, forming a mental picture of the solution, and then carefully planning the production process.

SENATVS · POPVLVSQVE · ROMANVS
IMP · CAESARI · DIVI · NERVAE · F · NERVAE
TRAIANO · PRETTY · LEGIBLE · DACICON
MAXIMO · TRIB · POT · XVIII · IMP · VI · COS · VI · P · P
ADDECLARANDVM · VERY · SPACED · OUT



Page from
Aldus Manutius'
Hypnerotomachia
Poliphili, 1499.

O sanctissima & Enthea Erothea matre pia, & præclaro indefinente & ualido patrocinio degli ardenti & sancti amori, & degli amorosi fochi, & degli suauissimi coniugamenti infatigabile adiutrice. Si al diuino nume tuo da costei le gratie inuocate sono peruenute, Perlequale grati & accepti siano gli sui excessiui ardori & il suo gia uotato core. Rendite pietosa & arende uola alle sue fufe oratione piene de affectuose & religiose spon sione & instante p̄ce. Et ricordati de gli exhortatorii & diuini suasi di Neptuno al furibondo Vulcano, per te sedulamente facti, & da gli mulciberi la quei inuinculata cum lamoroso Marte, soluta illesamente fosti. Et alla tua superna clementia piaque cusi udirne, & præstare propitia di adim pire il determinato uoto, & focoso disio di questi dui. Il perche dal tuo cieco & aligero figliolo effendo in questa sua tenera & florida ætate apta al tuo sancto & laudabile famulato, & ad gli tui amorosi & diuini fochi (cõseruati la natura) cū sũma & itegra diuotioẽ tuta si p̄para. Et gia da q̄llo uulnerabõdo figliolo l'alma sua p̄fossa, & fora dil casto pecto il mollicolo suo core erucato sentitisse egli nõ renuete, ma patiete, & mãsueta mte icliatose, q̄llo

In turn, these “official” styles of writing influenced how handwriting was looked at and how it was taught in schools or other learning centers, such as monasteries.

Today, when we are supposed to write legibly, we’re instructed to “print!” While we might have a hard time reading something written 200 years ago in what was then considered a very “good” hand, we have no problem reading writing from Roman times or even earlier. Likewise, the typefaces designed 500 years ago, shortly after printing with movable type was invented, still look perfectly familiar (if a little quaint) to us. We might not be using the exact same letters reproduced in the identical manner, but the basic shapes and proportions are still valid today.

Vulcano, per te sedu
cum lamoroso Mar
tia piaque cusi udirr
oto, & focoso disio di
o effendo in questa si

Vulcano, pertesedu
cum lamoroso Mar
tia piaque cusi udirr
oto, & focoso disio di
o effendo in questa si

Some typefaces have stood the test of time and appear as contemporary today as they did 500 years ago. Their modern digitized versions have a slight edge when it comes to clean outlines.



Other typefaces were perfectly legible only a few decades ago, but can hardly be read by anybody today. It has to do with cultural perceptions, not the physical properties of the typefaces.

For centuries, *fraktur* (literally, “broken writing”) was the standard typographic style in Northern Europe. Roman typefaces were called Roman because they came from Italy and were used to set Romance languages like Italian, French, Spanish, and, of course, Latin.

When communications became more international, typefaces that were more universal came into demand. Today *fraktur*, gothic, and similar styles are only used to evoke the feeling of a bygone era, for example on the banner of newspapers like *The New York Times*.

They also come in handy when someone has to design a job that has Germanic undertones. The Nazis did indeed sponsor and even order (as was their way) the use of what they called “Germanic” typefaces, making it impossible for generations after World War II to use these types without historical connotations.

Far left: Aldus Manutius' first type design, printed 1499. Bembo from the Monotype Corporation, 1929, is a modern equivalent. Left: Gutenberg's Bible from 1455.

ſi ſp ſt ſſ ſh ſ et v ff

Primieramente' imparerai di fare' que-
sti dui tratti, cioe -
da li quali se' principiano tutte'

Principē de eodem officio. Cornicularium
Comentariensem. Numerarios. Adiutorem
Abactis. A libellis. Exceptores & ceteros
officiales

Primieramente' imparerai di fare'
questi dui tratti, cioe -
da li qualise principiano tutte'

Principe de eodem officio. Cornicularium.
Comentariensem. Numerarios. Adiutorem
Abactis. A libellis. Exceptores & ceteros
officiales

While the basic shapes of our letters haven't changed much in hundreds of years, there have been thousands of variations on the theme. People have designed alphabets from human

Top inset:
Italian manuscript, ca. 1530, shows how people wrote then.

Bottom inset:
From a book of writing instructions by Ludovico degli Arrighi, printed from engraved wood-blocks, ca. 1521. The type on the page below is Adobe Jenson Italic, designed by Robert Slimbach in 1996.

figures, architectural elements, flowers, trees, tools, and all sorts of everyday items, to be used as initials or typographic ornaments (see right). Typefaces for reading, however, are generally derived from handwriting. Gutenberg's types followed the forms of the letters written by professional scribes in fifteenth-century Germany. The printers in Venice, a few decades later, also based their first types on local handwriting.

Over the centuries, cultural differences have been manifested in the way people write. Professional scribes in European courts developed elaborate formal scripts. As literacy spread, people began to care more about expressing their thoughts quickly, and less about style and legibility.

Quills, fountain pens, pencils, and felt-tip pens have all done their part to change the look of handwriting. The common denominator, the Roman alphabet, has survived all these developments remarkably intact.

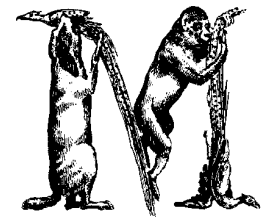
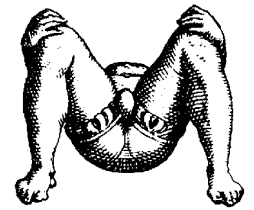

H Gill Floriated Capitals, Eric Gill

A Mythos by Min Wang and Jim Wasco

N Tagliente Initials, Judith Sutcliffe

D Rad, John Ritter

A Bickham Script, Richard Lipton



G Rosewood, Kim Buker Chanler

L Mythos

O Kigali Block, Arthur Baker

V ZebraWood, Kim Buker Chanler

E Studz, Michael Harvey

S Critter, Craig Frazier



By the same token, what was thought to be a fashionable house hundreds of years ago is still a very desirable house today. Fashion has changed remarkably since the 1400s, but people still wear shirts, trousers, socks, and shoes. The process of manufacturing them has changed, but materials such as wool, silk, and leather are still being used, and are often more desirable than their modern alternatives.

After all, the shape of the human body hasn't changed in the last 500 years, nor has the basic way we look at the world around us. Our view of things is still largely shaped by nature - plants, animals, weather, scenery. Most of what we perceive as harmonious and pleasing to the eye follows rules of proportion that are derived from nature. Our classic typefaces also conform to those rules; if they don't, we regard them as strange, at the least fashionable, and at the worst illegible.

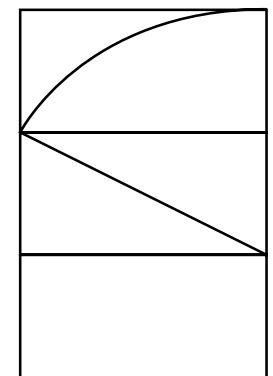
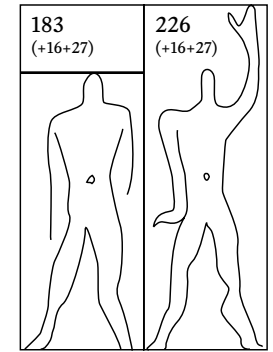

Some people have measured the human body to find what makes certain proportions look more beautiful than others.

Le Corbusier's *Le Modulor* (the system framing his ideas of modern functional architecture) is neatly related to a man with an outstretched arm. Not surprisingly (to anyone who's ever looked into the laws of harmonious proportions), the French architect found that the Golden Section was the underlying principle for all the measurements used in his drawings of the human body.

The human body hasn't changed drastically for centuries, so neither have things like shoes, fashion influences notwithstanding. Here is a collection of some footwear from the fifteenth century until today.

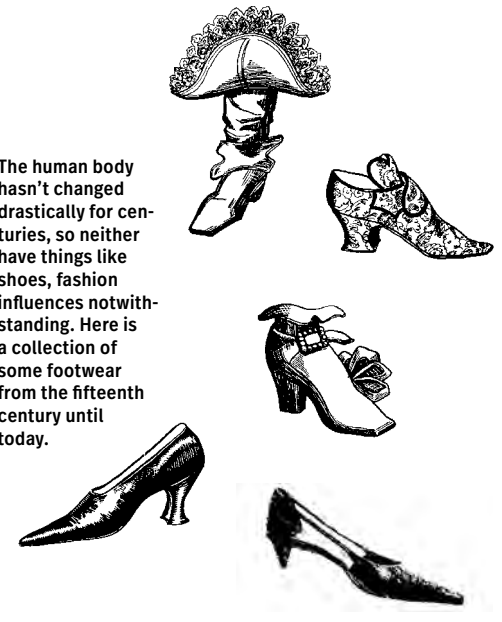

t
hnen

ot wish, if you live
die fasting. If you have
an estate, and if you
u have an office of profit
nen the trade must be

Think big
If time is the most precious of all things,
wasting time must be the greatest sin;
since lost time is never found again, and
what we call enough time always proves
to be too little. Let's be up and doing,
and with a purpose, so by diligence we
can do more with less perplexity.

cult, but industry all things easy. If you
ll day and barely may overtake the bus-
ness travels so slowly that poverty will
like rust, consumes faster than labor
s always bright. Time is the stuff life is
han is necessary do we spend in sleep,
g fox catches no poultry, and that the-
in the grave.

asting time
never found
s proves to
a purpose,
rplexity.
y all things
and barely
laziness tra-
ke you. Slo-

Sloth, like rust, consumes faster than labor wears, while the used
key is always bright. Time is the stuff life is made of; how much more
than is necessary do we spend in sleep, forgetting that the sleeping
fox catches no poultry, and that there will be sleeping enough in the
grave.
Industry need not wish, if you live on hope you will die fasting. If
you have a trade, you have an estate, and if you have a calling you
have an office of profit and honor. But then the trade must be worked
at and the calling well followed.

The mother of good luck

Though you have found no treasure, nor
has any rich relation left you a legacy,
diligence is the mother of good luck, and
all things are given to industry. Plow
deep while sluggards sleep, and you will
have corn to sell and keep; work while
it is called today or you know not how much
you may be hindered tomorrow: one
today is worth two tomorrows, and further-

Think new. Design new
Let's be up and doing, a
a purpose, so by diligen
can do more with less p

THE TIME MACHINE
If you get up late you must trot all c
barely may overtake the business a
while laziness travels so slowly tha
will soon overtake you. Sloth, like ru
mes faster than labor wears, while
key is always bright. Time is the stu
h is ne

*Though you have
any rich relation
is the mother of
given to industry
sleep, and you wi*

The first generation to grow up with tele-
vision (those born in the 1950s) is still imitating
and fantasizing about the lifestyles depicted
on TV. This generation is followed by one grow-
ing up with music videos, virtual reality, and
the internet. The manipulation of sounds
and images, the invention of artificial realities,
and the experience of life inside man-made
surroundings put to question our “natural” rules
of perception. And, as with every technological
and cultural development in the last 2000
years, type and typography reflect this.

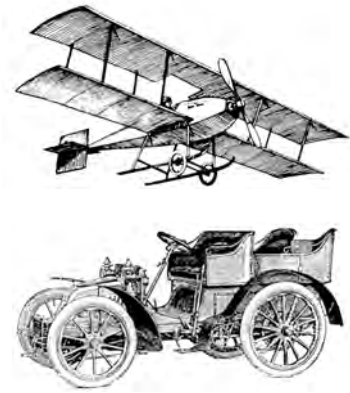

First examples of a new
technology rarely resemble
their modern counterparts,
at least not in appearance.
The underlying principles,
however, were there already.
If they hadn't been, planes
wouldn't fly, TV tubes would
explode, and cars wouldn't
be faster than horse-drawn
carriages.

The present generation of readers appar-
ently does not mind reading tiny type on slabs
of reflective glass. But as resolution on these
screens has become almost as good as paper,
they use modern versions of the same typefaces
that were deemed highly legible a few hundred
years ago, while bitmaps are seen as nostalgic
fashion statements, just like cowboy type from
the 1880s.

“Plus ça change”, as the French say.

Screen fonts for phones
and handheld devices
brought back bitmaps,
just after we had got
used to “real” printing
type on our printers
and computer screens.
At the same time, font
technology enables
designers to re-create
every style of lettering
that ever existed,
from nostalgic Ameri-
cana to primitive pixel
type, which is now
being used as a fashion
statement.

Typefaces are NOT intrinsically legible

Send me a message

Diagnos carissima

Ruf mich zurück.

Learning from Las Vegas World Famous Buffet

From top to bottom:
Zuzanna Licko's bitmap-
inspired typefaces from
1987; Screenfonts for
Nokia, Ericsson and
Sony; Nugget and Jack-
pot by House Industries;
FF Peecol and FF Sub
Mono by Eboys.

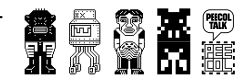

Pixels are cool.
Pixels are way cool.

SIGMUND FREUD

SOMETIMES
A CIGAR
IS JUST
A CIGAR.

(1856–1939), known as the father of psychoanalysis, was an Austrian neurologist who developed techniques of free association of ideas and theorized that dreams are representative of repressed sexual desires. Things said without any forethought sometimes result in what is known as a “Freudian slip”.

Calypso

CHAPTER 3

Looking
at type.

FF Real Head Extra Light

HEADLINES

have to be big and at the top

Display

type is meant to show off the advantages of the product inside the package it is printed on.

TYPE IN BOOKS hasn't changed much over the last five hundred years. Then again, the process of reading hasn't changed that much either. We might have electric lights, reading glasses, and more comfortable chairs, but we still need a quiet corner, a little time on our hands, and a good story. Paperbacks crammed full of poorly spaced type with narrow page margins are a fairly new invention, born out of economic necessities, i.e., the need to make a profit. Chances are the more you pay for a book, the closer it will resemble a good historical model that dates back to the Renaissance. By the time we are adults, we have read so much that is set in what are considered "classic" typefaces that

EDIT SERIF

Newspaper typography has created some of the very worst typefaces, typesetting, and page layouts known to mankind. Yet we put up with bad line breaks, huge word spaces, and ugly type, because that is what we are used to. After all, who keeps a newspaper longer than it takes to read it? And if it looked any better, would we still trust it to be objective?

SWIFT LIGHT

Small print is called small print even though it is actually only the type that is small. To overcome the physical limitations of letters being too small to be distinguishable, designers have gone to all sorts of extremes, making parts of letters larger and/or smaller, altering the space in and around them so ink doesn't blacken the insides of letters and obscure their shapes, or accentuating particular characteristics of individual letters. Another trick is to keep the letters fairly large, while at the same time making them narrower than is good for them or us so more of them will fit into the available space. Often enough, however, type is kept small deliberately, so that we have a hard time reading it – for example, in insurance claims and legal contracts.

FF META BOOK

ANYONE LOOKING AT A printed message will be influenced, within a split second of making eye contact, by everything on the page: the arrangement of various elements as well as the individual look of each one. In other words, an overall impression is created in our minds before we even read the first word. It's similar to the way we respond to a person's presence before we know anything about him or her, and then later find it difficult to revise our first impression.

We read best what we read most, even if it is badly set, badly designed, and badly printed. This is not to suggest there is a substitute for good type, great design, or clean printing, but merely a reminder of the fact that certain images

Handgloves

FUTURA EXTRA BOLD COND.

Handgloves

ANTIQUE OLIVE BLACK

Handglov

FF ZAPATA

Handgloves

HOBO

Handgloves

EDIT SERIF PRO

Handgloves

SWIFT LIGHT

Handgloves

FF META BOOK

are deeply ingrained in the reader's mind.

Graphic designers, typesetters, editors, printers, and other communicators are well advised to be aware of these expectations. Sometimes it may be best to go by the rules; at other times the rules need to be broken to get the point across. Good designers learn all the rules before they start breaking them.

A recurring element on these pages, as first seen on page 19, is the "Handgloves." This word contains enough relevant shapes to judge an alphabet but is a change from the industry standard "Hamburgefons." The Handgloves show off typefaces used in the sample settings or referred to in the text.

Designing typefaces for particular purposes is more widespread than most people think. There is special type for telephone books, small ads, newspapers, and Bibles, and for the exclusive use of corporations. There are also typefaces designed specially to comply with technical constraints, i.e., low-resolution printers, screen displays, mono-spaced typewriters, and optical character recognition. So far, all these typefaces have tried to emulate historical models. Even bitmaps have become such a model, albeit borne of necessity. Below are types that have been designed for special purposes.

Bell Centennial
designed for telephone books.

ITC Weidemann
originally designed for a new edition of the bible.

Spartan Classified
made especially for small ads in newspapers.

Mercedes Serif/Sans
Mercedes Benz corporate typeface.

Sassoon Primary
for teaching handwriting to school children.



<p>a</p> <p>Cooper Black</p>	<p>b</p> <p>MESQUITE</p>
<p>c</p> <p>Arnold Böcklin</p>	<p>d</p> <p>CAMPUS</p>
<p>e</p> <p>Tekton</p>	<p>f</p> <p><i>Snell Roundhand</i></p>

This is a typographic puzzle. Which typeface do you think fits which shoe? The answers are on the next page, but don't look now – that would be cheating. Remember which letter from the boxes on this page goes with which number from the opposite page, then turn the page and check against our personal favorites.

In some cases it is very easy to spot a typographic faux pas.





No one would use the same shoes to go dancing, run a mile, climb the north face of the Eiger, and walk to the office – not many people, anyway. While your feet may pretty much stay in the same shape, they need different types of support, protection or, indeed, enhancement to perform all the above tasks and many more besides.

This also applies to type. Sometimes the letters have to work hard to get across straight facts or numbers, or they may need to dress up the words a little to make them seem more pleasant, more comfortable, or simply prettier.

Some shoes fit your feet better than others, and you get to like them so much that you just want to keep buying the same kind over and over. Your friends, however, might begin to give you a rough time over your taste in footwear, so why not buy a few pairs of the same model but in different colors? Now you have more choices at the same comfort level.

Where's the analogy with type? Well, you can print it in **different colors**, on **different backgrounds**, dark on light, or **light on dark**. It will always appear as if you are actually using more than one typeface.

Your personal choice of typefaces to match the shoes will probably be quite different from the ones shown here. With more fonts to choose from than there are shoes in your typical shoe store, the task is daunting.

Luckily, the intended typographic purpose narrows down the choice as much as where you will be wearing your shoes. Fortunately for the fashion-conscious designer, there are many options to choose from, even for similar design applications.

Cooper Black – see opposite page – is a very popular typeface, and was even more so thirty-five years ago. It has its advantages: nice and cuddly, heavy, and relatively unusual. But if you think it's been used a little too often, you can try Goudy Heavyface, ITC Souvenir Bold, Stempel Schneidler Black, or ITC Cheltenham Ultra. Compare them to each other and you will see they're all quite different, but might do the same job just as effectively.

Not all of us want to be seen wearing the same shoes as everybody else.

Handgloves

GOUDY HEAVYFACE

Handgloves

ITC SOUVENIR BOLD

Handgloves

STEMPEL SCHNEIDLER BLACK

Handgloves

ITC CHELTENHAM ULTRA

So type has its practical uses – it can walk, run, skip, jump, climb, and dance. Can it also express emotions? Of course. If you look closely at a letter, you can see personality expressed in its physical characteristics: light or heavy, round or square, slim or squat. Letters can stand at attention next to each other like soldiers or they can dance gracefully on the line. Just as some words sound better than others, some words look nicer than others. That may be because we don't like the meaning of the word, but often we've formed an opinion before we've even read it. Isn't it nice that the *o* imitates the way we make our lips round to pronounce it? And how could the *i* stand for anything but the pointed sound it has in "pick"?

Dark emotions call for a black typeface with sharp edges; pleasant feelings are best evoked by informal, light characters. Or are they? The trouble is that as soon as you select a typeface that looks appropriate, put it on a page, surround it with space and perhaps other elements, it can take on a totally different look. So for the moment, we'll stick to choosing appropriate typefaces.

Runic Condensed is slightly awkward and definitely not suited for long passages. Its spiky serifs and exaggerated letterforms do not agree with classic ideas of beauty and fine proportion. If unusual letterforms express uneasy feelings, these other condensed types might be a good choice.

Doubt

Doubt?

RUNIC CONDENSED

Doubt

BODEGA SANS LIGHT

Doubt?

BLOCK EXTRA CONDENSED

Doubt?

HARLEM SLANG

Doubt?

BUREAU EMPIRE

Doubt?

BODEGA SERIF LIGHT

Runic Condensed is a typeface from Monotype. Released in 1935, it replicates a late nineteenth-century display type.

Bodega Sans adopts ideas from the high period of Art Deco. It was designed by Greg Thompson in 1990; its serifed companion followed in 1992.

Block is a family of typefaces originally designed by H. Hoffmann in 1908, with many subsequent versions released through 1926. Block simplified the setting of justified display lines with a system of capital and lowercase letters of varying widths that allowed the compositor to use the more extended alternate characters to fill out short lines. Block was the staple jobbing font for German printers well into the 1960s, when phototypesetting replaced hot metal. The irregular "mealy" outlines appeal to a modern audience, who like that recycled, used-before look.

Neville Brody designed the movie titles for *A Rage in Harlem*. In 1996, he was persuaded to turn that design into a full family of typefaces. The informal weight has an unusual name: Harlem Slang.

In 1937 Morris Fuller Benton designed Empire for *Vogue* magazine. David Berlow revived it in 1989, adding an italic and a lowercase, both unavailable in the original.

Some words are much more fun to find an appropriate typographic equivalent for than others. (Surprise, surprise.) It may be fairly difficult to find a majority agreement on the right typeface to spell “doubt,” but this one shouldn’t cause any problems. What’s more unexpected, more surprising, than someone’s handwriting? The best casual typefaces have always managed to carry some of the spontaneity of handwritten letters into the mechanical restrictions of typesetting. Even the names of some typefaces make you want to choose them. How about this one: Mistral – a cool wind blowing from the north into southern France. And indeed, in the South of France it seems to have become the standard typeface for every shopfront and delivery van – at least as long as the old Citroën 2CVs survive, the traditional vehicle for the service trades in that country.

In case you don’t agree that Mistral suggests surprise, here are some alternatives.

The complete freedom offered by computer applications makes type even more flexible – if a word doesn’t look right when first set, you can manipulate the outlines until it does exactly what you want.

In metal typesetting, as in the composing stick shown below, there’s nothing you can do beyond what the original designer, the punchcutter and the foundry provided. Which makes it even more amazing how Excoffon managed to convey his personal style to a lump of lead.

“Surprise” is shown at right in its unaltered form. We didn’t like the join between **S** and **u**, so we created outlines in Adobe Illustrator, cleaned up that detail (and a few others), and placed it in our photograph, where you can see the revised word. Most people would believe that it had been written by someone with a felt-tip pen, not simply set as part of a complete page.

Mistral was designed by Roger Excoffon in 1955. His other typefaces – Antique Olive, Choc, Banco – also show a characteristic Gallic style and have been enormously successful in France and other European countries.

Susanna Dulkyns took Letter Gothic and replaced some characters with others that have similar shapes, but different meaning. The **S** is a dollar sign; the **p** is the Thorn – used in Icelandic, Old English, and phonetics; the second **r** is the Registered sign; the **j** is an upside-down exclamation mark as used in Spanish for quotes; and the **e** is the Euro currency sign.



Surprise



Surprise

MISTRAL

\$urp®ise€

LETTER GOTHIC SLANG

Surprise

DOGMA SCRIPT

Surprise

FB DIZZY

Surprise

OTTOMAT BOLD



The more characters in a word, the more chances there are to find the right letterforms to express its meaning. This word doesn't give us a lot of choices, just three characters: *joy* or *JOY*. Seeing that the lowercase *j* and *y* look so similar, an all-capital setting will work better with this one. All three typefaces here have a generous feel to them – open forms with confident strokes and a sense of movement.

ITC Kabel, Syntax, and Lithos are modern interpretations of classical letterforms; they maintain a chiseled look without formal stroke endings, which are known as serifs.

The letter *Y*, a latecomer to the Latin alphabet, is called *j grec* in French (Greek *i*). Its shape is derived from one of the calligraphic variations of the Greek epsilon.

The original Kabel, designed by Rudolf Koch in 1927, has distinct Art Deco overtones, whereas International Typeface Corporation's 1976 version has a very generous x-height and is more regular and less quirky.

Syntax has the proportions of ancient Roman letters, but no serifs, making it both contemporary and classic looking. It was designed by Hans-Eduard Meier in 1968.

Lithos is Carol Twombly's 1989 rendering of Greek inscriptions – just as elegant as Roman capitals, but less restrained. This face became an instant success and graphic designers have been using it for all sorts of trendy purposes, which goes to show that a classic can also be cheerful and modern.

JOY

KABEL BOOK

JOY

ITC KABEL BOOK

JOY

SYNTAX

JOY

LITHOS REGULAR



It is nice to see that some words carry their own explanation in the letters. These free and easy shapes certainly make you think of a joyful person with arms in the air.

Handgloves

KABEL BOOK

Handgloves

ITC KABEL BOOK

Handgloves

SYNTAX

HANDGLOV

LITHOS REGULAR

Anger, like doubt, can be described as a dark feeling that calls for a black, heavy typeface. Anger is not as narrow as doubt. It needs room to expand, sometimes to shout out loud. It helps if the letters are not perfectly worked out and closed in on themselves, but rather a little irregular, leaving room for our imagination. A well-balanced Univers or Helvetica would not do.

Flyer Extra Black Condensed, designed in 1962 by Konrad Bauer and Walter Baum. Poplar is a 1990 revival from Adobe of an old wood type from the mid-nineteenth century. Block Heavy (1908) is the fattest member of the family. Its outlines are deliberately irregular, which helped prevent damage when metal type was printed on heavy platen presses. You could call it a pre-stressed design.

Angst and Franklstein are both rightly named. Jürgen Huber and Fabian Rottke designed them – respectively – in 1997 for FontFont's Dirty Faces™ group.

Anger!

FLYER EXTRA BLACK CONDENSED

Anger!

POPLAR

Anger!

BLOCK HEAVY

Anger!

ANGST HEAVY

Anger!

FRANKLINSTEIN

Handgloves

FLYER EXTRA BLACK CONDENSED

Handgloves

POPLAR

Handgloves

SOLEX BLACK

Handgloves

ITC OFFICINA BLACK

Handgloves

BLOCK HEAVY

Handgloves

FUTURA EXTRA BOLD

Handgloves

ITC FRANKLIN GOTHIC HEAVY

Handgloves

GIZA NINE THREE

Handgloves

EAGLE BLACK

Handglov

ANTIQUÉ OLIVE NORD

Most really black typefaces have been overused because there aren't enough choices for the designers of posters and tabloid newspapers. These kinds of faces can be set with hardly any space between letters, which makes a large impact in a small space.

Futura Extra Bold and ITC Franklin Gothic Heavy have been favorites for a long time. Inspiration for Solex – designed by Zuzana Licko in 2000 – reportedly came from two principal sources: Alternate Gothic and Bauer Topic (also known as Steile Futura) and is her exploration of the industrial sans serif genre. Eagle is FontBureau's 1989 adaptation of Morris Fuller Benton's famous titling, Eagle Bold, drawn – caps only – in 1933 for the National Recovery Administration. Officina Black adds weight to Erik Spiekermann's sans and serif family, which was first published by ITC in 1990. The new versions were digitized by Ole Schäfer. Giza brings back the glory of the Victorian era. David Berlow based the family (1994) on showings in Figgins' specimen of 1845.

And all the way from the 1960s, Roger Excoffon's Antique Olive Nord shows that good typefaces are indestructible.

Anger

Serif **Handgloves**

LYON TEXT

Sans Serif **Handgloves**

FF BAU

Script *Handgloves*

FF MISTER K

Display **Handgloves**

FANFARE



GLYPHISH



There are seven deadly sins, seven seas, and seventh sons of seventh sons, but thousands of typefaces. Someone had to come up with a system to classify them, since describing how

The unofficial type classification - do not confuse with the official one on this page.

different type designs express different emotions just isn't exact enough. Unfortunately, there is not only one system, but quite a few, all of them too involved for anyone but the most devoted typomaniac. So here's the most rudimentary method of classifying type. It's not historically correct, nor does it give a complete overview of the available choice of fonts. It simply shows that with just a few basic principles, hundreds of ways of designing typefaces become possible, the same way a few basic emotions evoke a million ways to make a face.

In case anyone wants it on record: here's the official Adobe type classification. We have chosen a typical typeface for each category, trying to avoid all the best-known ones.

Venetian **Handgloves**
CENTAUR

Garalde **Handgloves**
SABON

Transitional **Handgloves**
JANSON TEXT

Didone **Handgloves**
WALBAUM

Slab Serif **Handgloves**
MEMPHIS

Sans Serif **Handgloves**
SYNTAX

Glyphic **Handgloves**
FRIZ QUADRATA

Script *Handgloves*
POETICA CHANCERY

Display **HANDGLOVES**
HESSE ANTIQUA

Blackletter **Handgloves**
WILHELM KLINGSPOR GOTISCH

Non-Latin 却協儁兜勳泮
ADOBE MING

Altitudines membrorum Virilium.

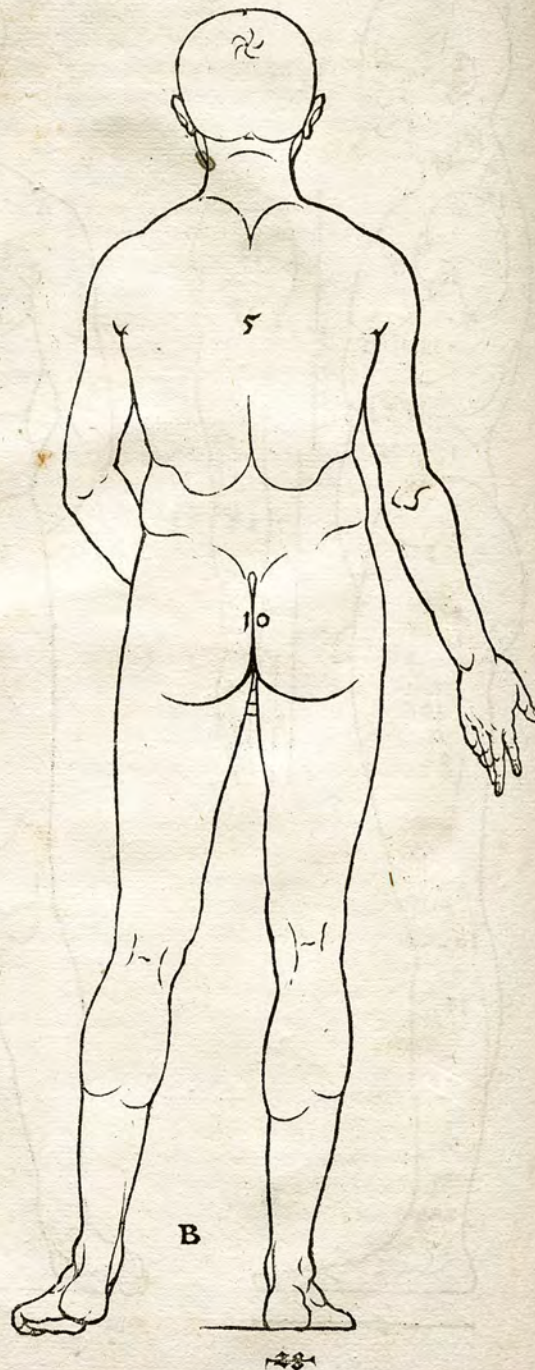
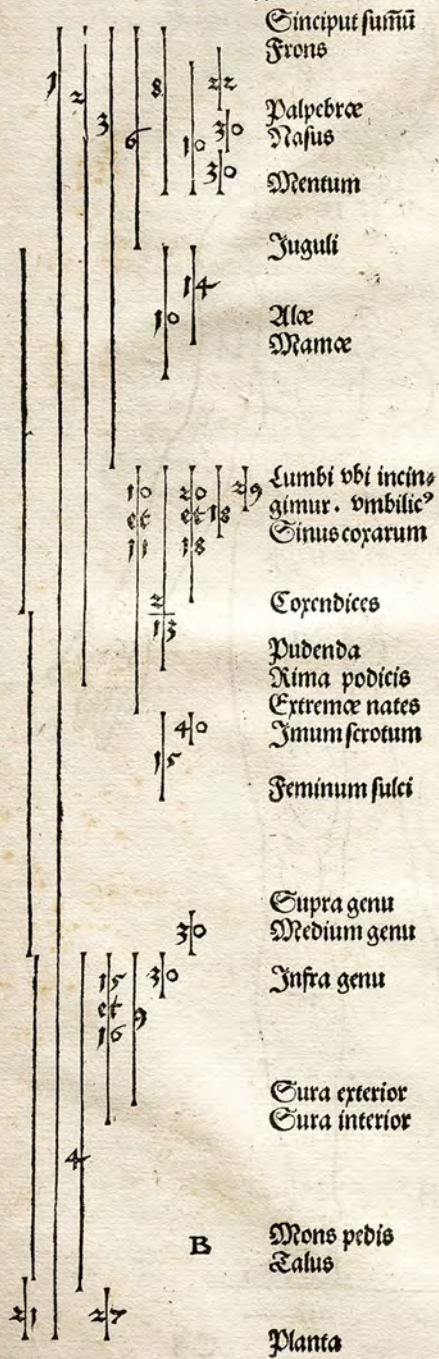

For his book *De symmetria partium humanorum corporum*, printed in 1527, Albrecht Dürer measured every part of the human body.

Scientists have not been content with just calling the human face “beautiful” if it meets certain ideals, or “ugly” if it doesn’t. They have had to go out and measure proportions of nose

to jaw, forehead to chin, and so on, to establish why some faces are more appealing than others. Typographers and graphic designers often choose typefaces for the very same reason they might fancy a person: They just like that person. For more scientifically minded people, however, there are specific measurements, components, details, and proportions describing various parts of a letter. While these won’t tell you what makes a typeface good, they will at least give you the right words to use when you discuss the benefits of a particular face over another. You can say “I hate the x-height on Such-a-Gothic” or “These descenders just don’t work for me” or “Please, may I see something with a smaller cap height?” and you’ll know what you are talking about.

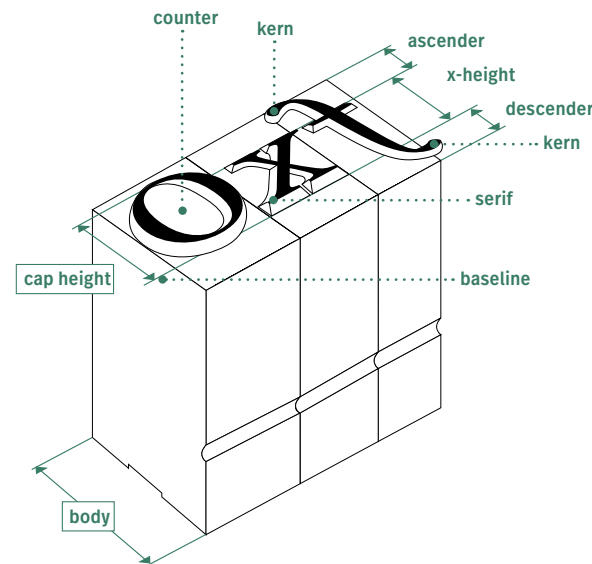

By now you will have noticed that we use the word *typeface* and *type* to describe what people these days refer to as a font. Much of the terminology used today come from the era of metal type. The spaces between lines are still (and not very accurately) described as leading, even though they certainly aren’t made up of strips of lead anymore. A font was a prescribed grouping of letters from one typeface assembled by a typefoundry for sale. These were apportioned to the number of letters used most frequently in any given language. The English printer who bought a French font of type, for instance, soon noticed its lack of sufficient *k* and *w* and its large supply of *q*. Italian demands a larger number of *c* and *z*; Spanish, far more of *d*, *t*, and all the vowels; German, more capital letters and more *z*, but less *y* and plus the *B*.

We design *typefaces* and we produce *fonts*. And throughout this book, we maintain that distinction. While the language of typography still adheres to some rules, there really aren’t any standards for type designers to follow. Typographic features, such as large x-heights, wide counters, and exaggerated ascenders, are no less slaves to fashion than the perpetual changes in skirt lengths determined on Paris runways. The size of type, indicated in points (a point is .01384 inch; 12 points = 1 pica; 6 picas = 1 inch), is only a reminder of a historical convention, when type was cast on a body of metal. The body size of all 12-point type would have been the same, but the actual image on that body could be vastly different. Have a look at the 20-point types below – they don’t have very much in common apart from the baseline.

The moral? *What you see is what you get* – trust your eyes, not the theoretical measurements.

Sizes Sizes Sizes Sizes Sizes



While metal letters could be made to any width and height, digital type has to conform to multiples of the smallest unit: the pixel. That is essentially a tiny black mark on the surface,

A dialog with a washing machine does not have to be an unpleasant experience, at least visually. Even a simple pixel font can appear friendly. Yellow type on a dark screen is also easier on the eye than green on black.

be it screen or paper. Every character has to be a certain number of pixels wide and high. This is not a problem when the letters are made up of 600 pixels per inch (or about 24 pixels per mm), as is the case with modern laser printers. Those pixels are not discernible to our eyes, and we are happy to believe that we are seeing smooth curves instead of little squares fitted into tight grids.

On most screens, only 72 pixels make up one inch (roughly three pixels per mm). We could see each and every one of them, if engineers hadn't already found ways around that (read more on page 133). Computer screens, however, are not where we read most of our type these days. Smart phones, computers, and tablets all have high-resolution screens, but microwave ovens, espresso makers, and all the other gadgets around us all still use small and modest displays. More often than not that means black on greenish gray or green on black. And the type unmistakably consists of bitmaps, which means that an 8-point letter is actually made up of eight pixels. If we allow six pixels above the baseline, including accents, and two below for descenders, that'll leave only three or four pixels for a lowercase character. In spite of these restrictions, there are hundreds of bitmap fonts, all different from one another by only a few pixels, but enough to prove that typographic variety cannot be suppressed by technological restraints.

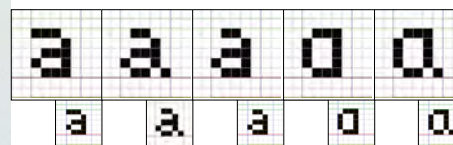

What a difference a dot makes: With only five pixels for the x-height, a type designer has to give up a lot of creative ego and be content moving one pixel at a time.

Editing pixels is like a game of chess: there are only a few black and white squares, and every move has enormous consequences.

Rather than try and imitate Times New Roman or Helvetica on a tiny chessboard, bitmap fonts have to make virtue out of necessity. It is amazing to see how much one can push the critical shape of each letter toward some almost abstract black and white graphic, and still make us think we're reading Roman characters.

Joe Gillespie designed a series of very small bitmap fonts for use on screens, appropriately named Mini 7, which is the size they are supposed to be set in. Another set of bitmap fonts for tiny sizes (only three pixels tall!) comes from Eboys, who have turned the bitmap look into an art form.

The makers of devices with small display screens would be well advised to look at these examples and in the future keep their engineers from making bitmap fonts.

HANDGLOVES
HANDGLOVES
 HANDGLOVES
HANDGLOVES
 HANDGLOVES
HANDGLOVES
 Handgloves
Handgloves

The Mini Series, all at 7pt. In the first six lines, capital letters are five pixels tall, while the mixed words have that many pixels for a lowercase letter.

Handglovee
Handglovee

FF Xscreen uses only three pixels for a lowercase character, but as this is not a true bitmap but actually an outline font, the pixels can be scaled to any size, ranging from sublime to ridiculous.

GERRY MULLIGAN

The best part
about playing
the piano is
that you don't
have to lug
around a
saxophone.

(1927–1996), master of the baritone saxophone, was one of the most versatile figures of modern jazz. He wrote his first arrangements and jazz compositions when he was still in his teens, and was part of the cool jazz scene in the 1940s; especially noteworthy were his pianoless groups in which his intricate and carefully balanced composing and arranging brought improvisation to new heights. He occasionally played the piano.

Erasmus Century Modern

CHAPTER 4

Type with
a purpose.

FF Real Head Light

YOU KNOW WHAT IT'S LIKE. It's late at night, your plane leaves at 6 AM, you're still packing, and you just can't decide what to put into that suitcase.

Picking typefaces for a design job is a very similar experience. There are certain typefaces you are familiar with. You know how they will behave under certain circumstances, and you know where they are. On the other hand, there are those fashionable types that you've always wanted to use, but you're not quite sure if this job is the right one to experiment on. This is just like choosing which shoes to take on your trip – the comfortable ones are not the height of fashion, but the fashionable ones hurt. You might be able to stand them for a short reception, but not for shopping, let alone for a hike into the countryside.

Before you pack your font suitcase, you need to look at the task ahead. Strike a balance between practicality and aesthetics – that's what design is all about.

Gulliver is Gerard Unger's solution for many problems in newspaper design and production. It fits 20% more copy into the columns without sacrificing legibility and is sturdy enough to be carelessly printed on recycled paper. Quite a few newspapers around the world use it to good effect.

Coranto is another one of Unger's typefaces for newspapers. Designed in 2000, it is being used for The Scotsman as well as newspapers in Sweden and Brazil.

Tobias Frere-Jones' work on Poynter was sponsored by the Poynter Institute to answer the same question. He asked himself: how to retain copy without losing readers? As we read best what we read most, the designer stuck to familiar forms and returned to Hendrik van den Keere's seventeenth-century oldstyle roman. As different methods of reproduction and printing may add or reduce weight by a fraction, Poynter Oldstyle Text is offered in four grades.

hand hand hand hand

POYNTER TEXT ONE POYNTER TEXT TWO POYNTER TEXT THREE POYNTER TEXT FOUR

While nobody has ever classified typefaces according to their problem-solving capabilities, many typefaces we use today were originally designed for particular purposes.

Times New Roman was specially produced in 1931 for the London newspaper that gave its name to the typeface. In the late 1930s, Mergenthaler Linotype in the USA (led by Chauncey H. Griffith) developed a group of five typefaces designed to be legible despite the rigors of newspaper printing. They were, not surprisingly, called the "Legibility Group," and two of them are still very popular today: Corona* and Excelsior. It might seem odd that legibility has to be a special concern when designing a typeface, but there are plenty of fonts around that are meant to be seen, not read; those typefaces are very much like clothes that look great but barely protect the wearer from the elements.

Handgloves

TIMES NEW ROMAN

Handgloves

CORONA

Handgloves

EXCELSIOR

Handgloves

GULLIVER

Handgloves

CORANTO

Handgloves

POYNTER OLDSTYLE BOLD

*this typeface was named in the 1920s, well before that word stood for something else ...



Going on vacation doesn't necessarily mean traveling to a warm climate, but it always means we can leave behind many of our conventions, including the way we normally dress—or have to dress, as the case may be. You pick your clothes according to what is practical: easy to pack, easy to clean, and according to what is fun: casual, colorful, loose, and maybe a little more daring than what you would wear in your hometown. The typographic equivalents are those typefaces that are comfortable to read, but which may be a little more idiosyncratic than your run-of-the-mill stuff. Serifs, too, can be casual, and “loose fit” is actually a typesetting term describing letters that have a comfortable amount of space between them. As it happens, quite a few of the very early typefaces from the Renaissance and their modern equivalents fit that description. They still show their kinship with Italian handwriting, which by necessity had to be more casual than rigid metal letters. If you were a scribe in the papal office and had to write hundreds of pages every day, you wouldn't be able to take the time to fuss over formal capitals. So the scribes developed a fluent, cursive handwriting, which today we call italic, because it was invented in Italy. You will have noticed that this whole page is set in a script font, and it feels quite comfortable. A conventional rule says that you can't set whole pages, let alone books, in the italics of a typeface. The only reason it might not work is because we're not used to it. As pointed out on page 41, we read best what we read most. But that's no reason not to take a vacation from our daily habits and look at something different, at least once a year.

To make a typeface look as casually elegant as FF Fontesque takes a lot of experience and effort. Nick Shinn designed Fontesque in 1994. It wasn't his first design, and his experience shows. Cafeteria did indeed start on Tobias Frere-Jones' napkin, and he managed to balance activity with legibility in this freeform sans serif face.

Some typefaces have a leisurely look about them while conforming to everyday typographic expectations. Others were born with unusual, yet casual, shapes and make the best of it.

Stempel Schneider combines friendly letter shapes with high legibility – you can use it every day without it becoming restrictive like a necktie.

A typeface that looks casual, even “nice,” but is still good for real work is ITC Flora. It was designed by the Dutch type designer Gerard Unger in 1980 and named after his daughter. Ellington, released in 1990, is a design by Michael Harvey, the English lettering artist and stone carver. Both typefaces are quite unusual and therefore not often thought of as useful text faces. But they are.

Many typefaces designed to look “friendly” tend to appear patronizing. They can be so nice that you quickly get tired of them. When you're looking for casual typefaces, the obvious candidates are, of course, the scripts. Most, however, are not suited to long spells of reading, just as sandals are very comfortable, but not when walking on rocky roads.

Handgloves

STEMPEL SCHNEIDLER

Handgloves

ITC FLORA

Handgloves

ELLINGTON

Handgloves

FF FONTESQUE

Handgloves

FB CAFETERIA





Most type is used for business communication of one sort or another, so it has to conform to both written and unwritten rules of the corporate world. Just as business people are expected to wear a suit (plus, naturally, a shirt and tie), text set for business has to look fairly serious and go about its purpose in an inconspicuous, well-organized way. Typefaces, such as Times New Roman and Helvetica fit this bill perfectly, not by their particular suitability but more by their lack of individualism.

However, just as it is now permissible in traditional business circles to wear fashionable ties and to even venture into the realm of Italian suits that are not black or dark blue, typographic tastes in those circles has widened to include other typefaces, from Palatino to Frutiger.

Generally, it is very simple to classify a particular business by the typefaces it prefers: the more technical a profession, the cooler and more rigid its typefaces (Univers for architects); the more traditional a trade, the more classical its typefaces (Bodoni for bankers).

The trouble is, that there is no law against speculators employing a true classic, trustworthy typeface in their brochures, lending these unsavory entities typographic credibility, although nothing else.

To show the subtle differences between fonts at this size, we've set the copy at left in a variety of types, one for each paragraph. Handgloves at the bottom of this column show them in sequence.

Frutiger, originally designed in 1976 by Adrian Frutiger for signage at the Charles de Gaulle airport in Paris, has become one of the most popular typefaces for corporate use.

Palatino, designed by Hermann Zapf in 1952, owes its popularity – especially in the USA – largely to its availability as a core font on early PostScript laser printers. It is nevertheless a welcome alternative to other, less suitable, serif fonts.

Adrian Frutiger designed Univers in 1957. It was the first typeface to be planned with a coordinated range of weights and widths, comprising twenty-one related designs, recently expanded to 9 weights (see page 89).

ITC Bodoni is one of many redesigns of Giambattista Bodoni's classic typefaces from the late eighteenth century. It shows more color and stroke variations than other Bodoni revivals, and is available in three versions for different sizes.

Handgloves

FRUTIGER

Handgloves

PALATINO

Handgloves

UNIVERS

Handgloves

ITC BODONI SIX

Handgloves

ITC BODONI TWELVE

Handgloves

ITC BODONI SEVENTYTWO



THE REAL WORKHORSE



FF REAL CONDENSED

If it were just a little heavier, News Gothic by Morris Fuller Benton, 1908, would be a favorite workhorse typeface. ITC Franklin Gothic, a 1980's re-design of Benton's original typeface from 1904, has more weights as well as a condensed and a compressed version with small caps.

Lucas de Groot designed his Thesis from the outset with 144 weights. The Thesis Sans family has become an alternative to Frutiger in corporate circles, as it is both neutral and versatile.

Gotham, by Tobias Frere Jones, 2000, has predictable letter shapes. It is the typeface that looks as if it always existed. His Interstate from 1993 also takes a vernacular face and adapts it to a general purpose.

FF Meta has been called the "Helvetica of the 90s." While that may be dubious praise, Meta is a warm, humanist alternative to the classic sans faces. Lots of detail make it legible in small sizes and "cool" rather than neutral.

You should also look at the condensed weights of Frutiger as useful, but underused alternatives. FF Profil is one of a newer generation of modern sans faces not based on a classic model. Designed by Martin Wenzel in 1999.

PTL Skopex Gothic is Andrea Tinnes' take on the classic Angloamerican genre; it gives News Gothic an interesting twist.

In 1989, Erik Spiekermann wanted to replace typewriter monospace faces in office correspondence with something equally rugged, but more sophisticated.

ITC Officina was the result.



■ Calling a typeface "a real workhorse" doesn't mean that others don't work, it just means that it is one of those that don't look very glamorous and is consequently not likely to be known by name; such types, however, are used every day by designers and typesetters because of their reliability.

● If you set a catalog for machine parts, or instructions for using a fire extinguisher, you're not worried about subtly curved serifs or classicist contrast. You need letters that are: clearly distinguishable; compact, so enough of them fit into a limited space (is there ever enough space?); and sufficiently sturdy to withstand the rigors of printing and copying. Here's what is needed in a hardworking typeface:

① A good regular weight – not so light that it will disappear on a photocopy or print (everything, it seems, gets copied or printed at least once these days), and not so heavy that the letter shapes fill in.

② At least one bold weight, with enough contrast to be noticed, to complement the regular weight.

③ Very legible numerals – these must be particularly robust because confusing figures can be, in the worst of cases, downright dangerous.

④ Economy – it should be narrow enough to fit large amounts of copy into the available space, but not actually compressed beyond recognition. A typeface fitting this description would also fare very well when faxed (yes, faxes still exist).

Handgloves
Handgloves

NEWS GOTHIC

Handgloves
Handgloves

ITC FRANKLIN GOTHIC

Handgloves
Handgloves

THESES SANS

Handgloves
Handgloves

INTERSTATE

Handgloves
Handgloves

GOTHAM

Handgloves
Handgloves

FF META

Handgloves
Handgloves

FF META CONDENSED

Handgloves
Handgloves

FRUTIGER CONDENSED

Handgloves
Handgloves

FF PROFIL

Handgloves
Handgloves

PTL SKOPEX GOTHIC

Handgloves
Handgloves

ITC OFFICINA



*One
of the few sanctuaries for old
aristocratic traditions is
Society.*

SNELL ROUNDHAND

*Top hats, cummerbunds, patent
leather shoes, and coats with tails are all
remnants of the eighteenth century,
when countries were run by
kings and queens who spoke French to
each other and their entourages.*

SNELL ROUNDHAND



NOT

FF SCALA JEWELS

*much of that remains, except for maitres
d'hôtel at posh restaurants who fake French
accents and wear coats with tails.*

KÜNSTLER SCRIPT



OF COURSE

MRS. EAVES

*French is still the official language
of the diplomatic corps. Typographically speaking,
we have reminders of these somewhat
antiquated traditions in the accepted and expected ways
of designing invitations and programs.*

MRS. EAVES ITALIC



**CENTERED TYPE AND
A PREFERENCE FOR FONTS THAT COME
FROM A GOOD BACKGROUND IN
COPPER ENGRAVING OR
UPPER CRUST CALLIGRAPHY.**

COPPERPLATE

And, of course,

MATRIX SCRIPT INLINE

those very familiar four letters, »rsvp«, which mean
»please let us know whether you're going to be there,«
but actually stand for »Répondez s'il vous plaît.«

SUBURBAN LIGHT

There is no category known as "formal fonts," but a number of typefaces come from that background. The text at the left is set in Snell Roundhand, a formal script from the 1700s, redesigned in 1965 by Matthew Carter.

Apart from formal scripts such as Snell, Künstler Script, and others like it, there are the aptly named copperplates. They look formal and distinguished and are even available in a range of weights and versions, but they all lack one important feature: lowercase characters.

Other typefaces that owe their appearance to the process of engraving into steel as opposed to writing with a quill or cutting into wood are Walbaum, Bauer Bodoni, or ITC Fenice. They can look formal and aristocratic enough to make a favorable impression when printed on fine paper.

While FF Scala Jewels is an extension of the FF Scala family by Martin Majoor from 1993, which is a contemporary interpretation of classic book typefaces, Mrs. Eaves is Zuzana Licko's idiosyncratic take on Baskerville, as seen from Berkeley, California in 1996. It is named after Sarah Eaves, the woman who became John Baskerville's wife. Licko's Matrix Script Inline from 1992 gets closer to American vernacular, and Rudy VanderLans' 1993 Suburban connects classic scripts with, well, suburban neon signs. And, as VanderLans proudly proclaims, Suburban is the only typeface in existence today that uses an upside down l as a y.

on the town

Going out of town allows us to do things we don't get to do in the office, and to wear all the trendy stuff that we can never resist buying but don't really need on a day-to-day basis.

FUTURA

LYON TEXT

THEINHARDT

typetrends

FF DIN /

FF DIN CONDENSED

There are typefaces that are only suitable for the more occasional occasion. They might be too hip to be used for mainstream communication, or they could simply be too uncomfortable – a bit like wearing **very tight jeans** rather than admitting that they don't fit us any longer. Very often these offbeat fonts are both – **tight in the crotch** and extroverted.

INTERSTATE BOLD
CONDENSED

FUNFONTS

INTERSTATE LIGHT

The entertainment value of this sort of typographical work is often higher than that of the straightforward corporate stuff, so there's a great deal of satisfaction gained not only from the words, but also from the fun of being able to work with really unusual fonts.

GRAPHIK

NEUE HELVETICA 75

Fashionable faces

One thing leather jackets have on trendy typefaces is that the jackets get better as they get older, which is more than can be said about some of the typefaces we loved in the 1980s but would be too embarrassed to ask for now. Like all fashions, however, they keep coming back. Don't throw away your old fonts – keep them for your kids.

What makes typefaces trendy is almost unpredictable – much to the chagrin of the people who have to market them. A corporation, a magazine, a TV channel can pick a typeface, expose it to the public, and a new typographic fashion can be born. But, like with fashion and pop music, it usually takes more than one designer in the right place at the right time picking the right font off a web site or out of a catalog.

Typography is as much a mirror of what goes on in society as the styling of mobile telephones or car radiators. Cars still take half a dozen years from concept to production, so their designers have to anticipate trends. As cars are the icons of our mobile society, their design, in turn, does create trends. While technology allows us to produce a font in weeks if not hours from rough sketches or ideas, it still takes a few years for a typeface to get to market and to the attention of the font-buying public. Right now, early in the 21st century, we are seeing a return to the time-honored classics and their modern interpretations. We have also learnt to live with bitmaps, both as a necessity and as a fashion statement. Most industrial typestyles have been exploited, from monospaced typewriter faces through electronic font generators to industrial signage. And some of the most used typefaces today were first produced for the signs on our roads. Interstate is Tobias Frere-Jones' interpretation of the white-on-green letters in the USA, while FF Din expands the model used on Germany's Autobahn. Ironically, if a typeface has been designed for one particular purpose, it seems to look really good on anything else.





As long as you print on paper, the choice of typeface is first and foremost governed by the content of the message, then the intended audience, and only lastly by technical constraints.

Architectural type has to compromise between materials and legibility. A mosaic made up of millions of pieces would allow for smoother lettershapes, but would neither be as durable nor as affordable as one with coarser bits.

When we move from almost limitless resolution on paper to images generated by cathod rays or liquid crystals, we enter a world of optical illusions.

Those have to make up for the lack of high fidelity and trick our eyes into seeing life-like images rather than spots of colored light (see page 132). On the screen, colors are not mixed from

CMYK: cyan, yellow, magenta and black (the K really stands for *key*), but are broken down into RGB: red, green and blue; letters are composed of coarse lines or dots, and black is not an ink, but the absence of light. Typefaces have to work very hard under these conditions. There is no room here for leisure fonts, nor for scripts or some of the trendy faces that hide more than they reveal. The workhorses for “old” media work well in the new. Rugged construction, clear counter spaces, easily discernible figures and well defined weights have all been mentioned before as being prerequisites for anything which has to be read under less than ideal circumstances. And whatever progress technology brings in the future – staring into light coming from a screen is not what human eyes were made for.

All those minute details that make a good typeface pleasant to behold and easy to read, actually add noise. The absence of these details would make the type look cold and technical, as if generated by machines and legible only for machines.

The designer of typefaces suitable for on-screen reading has to balance the requirements of the precise but cold medium (light emitted by all sorts of tubes, crystals, diodes and plasmas) against our need for subtle contrast and soft shapes. And as most of what we read on screen eventually gets printed as well, these alphabets have to offer enough traditional beauty for us to accept them against the competition we've grown used to over 500 years.

Slightly extended lettershapes have more open counters and are thus more legible, but need more space. Subtle contrast between thin horizontals and thicker verticals doesn't translate well into single pixels, and tiny serifs may look delicate in displays sizes, but on a screen will only add noise at 10 pixels or less.

The screen fonts offered by Microsoft, Apple and others work well under all circumstances, but by definition have become too ubiquitous to lend an individual note.

Matthew Carter's Verdana has become a very successful face on paper as well, while Bigelow & Holmes' Lucida, initially designed for laser-printers in 1983, looks also great in high-resolution and is one of the best screen fonts around. FF Typestar by Steffen Sauersteig has those rugged shapes reminiscent of typewriter faces and is thus suited for rough conditions on screen or paper.

Handgloves

Look at these faces at very small sizes and you get an idea of how they will perform on screen 5/5pt

Handgloves

Look at these faces at very small sizes and you get an idea of how they will perform on screen 5/5pt

Handglove

Look at these faces at very small sizes and you get an idea of how they will perform on screen 5,5/5,5pt

And if a text is mainly meant for the screen and for very small sizes, pure bitmap fonts work well. If you print them, the pixels are small enough to all but disappear. This is 7pt Tenacity Condensed, a bitmap font from Joe Gillespie.



Brands have to speak their own authentic language. Type is visible language. Using a bland or overused typeface will make the brand and its products or media equally bland and even invisible. Having an exclusive typeface designed or adapted used to be expensive, technically challenging, and difficult to implement. Not anymore. Whether it's just one weight for a packaged product or a large system for everything, corporate fonts have become a major source of work for type designers.

Some companies take an existing face and simply change the name to make it more identifiable – license models exist for that purpose. While they're at it, they often add their logo or other glyphs that can then be accessed via the keyboard. And if the chairman (or his wife) doesn't like the shape of a certain character, that can also be adapted. All with the blessing and preferably the involvement of the original type designer. As a lot of these people are no longer available (think Bodoni, Caslon, or Garamond), the foundry who has the license for the particular typeface will be happy to help.

In 1987, Kurt Weidemann designed a trilogy of faces for Mercedes-Benz that was, in fact, a comprehensive system for all their brands and sub-brands. Corporate A stands for Antiqua; S is Sans; and E is Egyptienne. This was the first typographic tribe, a family of families. It is no longer exclusive to Mercedes-Benz, so every backstreet garage can now have at least a premium name over the door.

Mercedes, meanwhile, have had their typefaces totally redesigned for today's requirements, e.g. small screens and other uses that weren't envisioned back in the late 80s. This time, they'll stay exclusive. (See page 41)

Handgloves

CORPORATE A

Handgloves

CORPORATE S

Handgloves

CORPORATE E

Silicon Valley Bank took the easier route: they chose FF Unit and FF Unit Slab, changed the name for easier recognition, and got a license to distribute it to their suppliers and branches.

Handgloves

SVB SANS

Handgloves

SVB SLAB

When General Electrics started work on their new brand position in 2004, they commissioned an exclusive typeface to express the new direction, perhaps too transparently named GE Inspira. It works well for a large company that makes everything from jet engines to lightbulbs.

Handgloves

GE INSPIRA REGULAR

Handgloves

GE INSPIRA BOLD

svb >
Silicon Valley Bank
Brand Guidelines
Basic Elements

IBM took an unusual approach when they asked Mike Abbink to design a corporate typeface for them. IBM Plex is publically available – for everybody and for free. It is already a large family with lots of weights and styles, and is still being expanded. IBM thus intends to make their typeface and with it their brand a household name, at least in designers' circles.

Handgloves

IBM PLEX SANS REGULAR

Handgloves

IBM PLEX SANS BOLD

Handgloves

IBM PLEX MONO REGULAR

No, Watson,
this was
not done
by accident,
but by design.

is a fictional detective created by Sir Arthur Conan Doyle (1859–1930). Holmes' extraordinary powers of deductive reasoning carry him, along with his somewhat befuddled partner Dr. Watson, through some of the most complex mysteries in detective fiction.

Caslon

Type builds
character.

FF Real Head Semi Light



The Way to Wealth

BENJAMIN FRANKLIN

IF TIME IS OF ALL THINGS the most precious, wasting time must be the greatest prodigality; since lost time is never found again, and what we call time enough always proves too little. Let us then be up and doing, and doing to a purpose, so by diligence we should do more with less perplexity. Sloth makes all things difficult, but industry all things easy. He that riseth late must trot all day and shall scarce overtake the business at night; while laziness travels so slowly that poverty soon overtakes him. Sloth, like rust, consumes faster than labor wears, while the used key is always bright. Do not squander time, for that's the stuff life is made of; how much more than is necessary do we spend in sleep, forgetting that the sleeping fox catches no poultry, and that there will be sleeping enough in the grave.

So what signifies wishing and hoping for better times? We may make these times better if we bestir ourselves. Industry need not wish, and he that lives upon hope will die fasting. There are no gains without pains and he that has a trade has an estate, and he that has a calling has an office of profit and honor. But then the trade must be worked at and the calling well followed. Though you have found no treasure, nor has any rich relation left you a legacy, diligence is the mother of good luck, and all things are given to industry. Plow deep while sluggards sleep, and you will have corn to sell and keep; work while it is called today or you know not how much you may be hindered tomorrow: one today is worth two tomorrows, and farther: have you something to do tomorrow, do it today.

Be ashamed to catch yourself idle. When you have so much to do, be up by the peep of day. Let not the sun look down and say: "Inglorious here he lays." Handle your tools without mittens; remember, that the cat in gloves catches no mice. It is true there is much to be done, and perhaps you are weak-handed, but stick to it steadily, and you will see great effects, for constant dropping wears away stones; and by diligence and patience, the mouse ate in two the cable. If you want a faithful servant, and one

THE WAY BOOKS are read hasn't changed very much over the last 500 years, so the way books look hasn't had to change either. Only the economics have changed, which means that

The left hand pages in this chapter have been reduced to fit into this book; most are about two-thirds their optimum size.

publishers today insist on fitting more type onto a page, and they aren't always prepared to pay for good typesetting, let alone for someone to actually design the inside of a book, and not just its cover. Every additional dollar spent on the manufacture of a book adds seven or more dollars to its retail price.

Cheap paperbacks, therefore, do not usually represent the state of the typographic art. In general they could be nicer than they are because it costs no more to observe the basic rules of book layout using a good, legible typeface than to ignore these rules and set the text in whatever the printer happens to have around.

With the arrival of electronic books, cheap paperbacks are on their way out. Unfortunately, type in e-books follows that bad tradition, although good typography wouldn't cost a penny extra.

Typefaces from the 1700s inspired many contemporary designers.

Fred Smeijers designed his Arnhem for use in newspaper setting, including a Black weight as well as a Fine version for more elegant headlines. "Blond" is perhaps the most unusual name for a slightly more delicate weight.

Genath by François Rappo is a very elegant take by a Swiss designer, based on a typeface first produced for the Genath foundry in Basle around 1720.

Handgloves

ARNHEM NORMAL

Handgloves

ARNHEM BLOND

Handgloves

ARNHEM NORMAL ITALIC

Handgloves

ARNHEM BLACK

Handgloves

ARNHEM BLACK ITALIC

Handgloves

ARNHEM

To show just how much type can accomplish and how versatile it is, we have used the same text, written by Benjamin Franklin in 1733, to set all the samples in this chapter; some liberties have been taken with Mr. Franklin's words to make typographic points (!).

Our example is set in Adobe Caslon Pro, the updated version of Carol Twombly's 1990 redrawing of one of the most popular of all the book faces, originally cut by William Caslon in 1725.

The Irish playwright George Bernard Shaw insisted that all his books be set in Caslon, earning him the title "Caslon man at any rate." For decades the motto of British printers was, "When in doubt, set it in Caslon."

The layout follows the classic model with wide margins, generous space between lines, and a centered title. To achieve a nice, smooth edge on both sides of the column, the punctuation is hung in the right hand margin.

Handgloves

ADOBE CASLON PRO REGULAR

Handgloves

ADOBE CASLON PRO SEMIBOLD

HANDGLOVES

ADOBE CASLON PRO CAPS



ADOBE CASLON ORNAMENTS

Handgloves

ADOBE CASLON PRO ITALIC

Handgloves

GENATH REGULAR

Handgloves

GENATH BOLD

Handgloves

GENATH REGULAR ITALIC

Frugality will never go out of style.

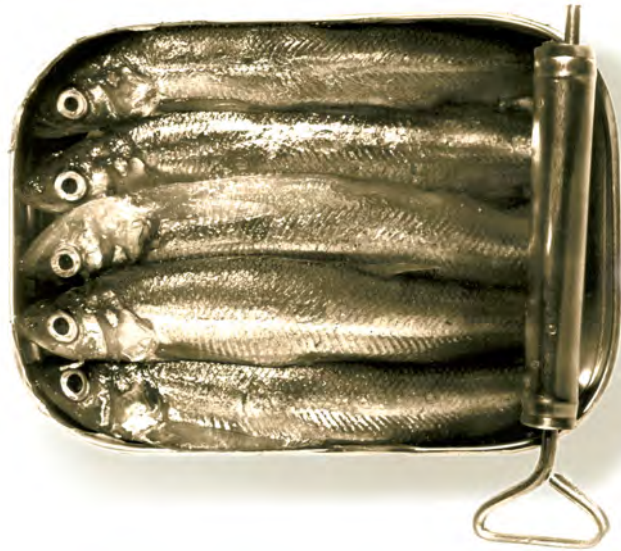

To be secure, certainty and success rely on a dependable financial institution.

It's easy to think that a little tea or a little punch now and then, a diet a little more costly, clothes a little finer, and a little entertainment is no great matter. But at the Bank of Benjamin we think that being aware of small expenses is just as important as the consideration it takes, say, to purchase

a home: small leaks will surely sink a great ship. Our financial advisors will always be available to advise the best ways to put your savings to work. We know that what often appears to be a terrific investment quite frequently turns out otherwise. So when confronted by a great peninsynworth, our advisors will pause a

while: Cheapness is apparent only, and not real. We want our customers to enjoy their hard-earned leisure without having to think about their hard-earned dollars. So be sure to keep this in mind: if you won't listen to reason, it will rap your knuckles.

The Bank of Benjamin

Our advisors are at your service 24 hours a day. Please call us:

1-800-SAVINGS

There also seems to be a generic style for advertisements. Although display advertising does not have a lengthy tradition (it has only been around about 150 years), its style is as established as that of the traditional book. Headline on top, attention-grabbing picture underneath, subhead, main copy, logo, pay-off line, address, URL, or telephone number.

Never more than eight elements! People are able to comprehend at most about that many different components in one message; as soon as there are more, comprehension requires too much effort, and attention goes elsewhere. You can also recognize a serious, idea-based advertisement by the serious typography. No experiments here – take a classic, well-trying typeface, arrange it in a predictable layout, and people may actually read your message.

But why do advertising people insist on justifying even the shortest paragraphs?

When Paul Renner started work on Futura in 1924, it was proclaimed as the “typeface for our time,” alluding to the social democratic reform of German society in the 1920s. The first weight was released in 1927.

Futura’s naming doesn’t follow normal conventions – e. g. Heavy should be heavier than Bold – but betrays the gradual release of weights and versions over years.

Handgloves

FUTURA LIGHT

Handgloves

FUTURA LIGHT OBLIQUE

Handgloves

FUTURA CONDENSED LIGHT

Handgloves

FUTURA CONDENSED LIGHT OBLIQUE

Handgloves

FUTURA BOOK

Handgloves

FUTURA BOOK OBLIQUE

Handgloves

FUTURA CONDENSED MEDIUM

Handgloves

FUTURA CONDENSED MEDIUM OBLIQUE

What is more no-nonsense than Futura, the typeface made respectable in those first VW ads from the 1950s and 1960s? They were truly revolutionary, using this cool, restrained German typeface to promote that strange little car.

Futura is still one of the most popular typeface families, providing art directors all over the world with some of the best bold, extra bold, and condensed fonts available. Advertising certainly wouldn't be the same without Futura.

Handgloves

FUTURA MEDIUM

Handgloves

FUTURA MEDIUM OBLIQUE

Handgloves

FUTURA HEAVY

Handgloves

FUTURA HEAVY OBLIQUE

Handgloves

FUTURA BOLD

Handgloves

FUTURA BOLD OBLIQUE

Handgloves

FUTURA CONDENSED BOLD

Handgloves

FUTURA CONDENSED BOLD OBLIQUE

Handgloves

FUTURA EXTRA BOLD

Handgloves

FUTURA EXTRA BOLD OBLIQUE

Handgloves

FUTURA CONDENSED EXTRA BOLD

Handgloves

FUTURA COND. EXTRA BOLD OBLIQUE

TIME LINE

a lecture by Frank Franklin

If time is the most precious of all things, wasting time must be the greatest sin. Lost time is never found again, and what we call enough time is never enough. Let us then be up and doing, and doing with a purpose, so by diligence we should do more with less perplexity. Sloth makes all things difficult, but industry all things easy. He that riseth late must trot all day and shall scarce overtake the business at night; while laziness travels so slowly that poverty soon overtakes him. Do not squander time, for that's the stuff life is made of; how much more than is necessary do we spend in sleep, forgetting that the sleeping fox catches no poultry, and that there will be sleeping enough in the grave.

7:00 p.m.

Saturday, December 12

PacBell Park

Remember this, however, if you won't be counseled, you can't be helped, and further: If you will not listen to reason, it will surely rap your knuckles.

He that riseth late must trot all day and shall scarce overtake the business at night.

You may think, perhaps, that a little tea, or a little punch now and then, diet a little more costly, clothes a little finer, and a little entertainment now and then, can be no great matter. Watch those little expenses, a small leak will sink a great ship, and moreover, fools make feasts, and wise men eat them. Buy what you have no need for and before long you shall sell your necessities. Many a one, for the sake of finery on the back have gone with a hungry belly. Silks and satins, scarlet and velvets, put out the kitchen fire. By these and other extravagances the genteel are reduced to poverty.

If you won't be counseled you can't be helped.

The computer has given us access to a design language that would have been far too complicated without the aid of sophisticated programs and a page description language such as PostScript. Gradations of color, overlaid images, frames, lines, boxes, background, foreground – all add up to the appearance of the page as one image, rather than a linear sequence of elements. This particular layout at the left can be classified as “New Wave, ca 1987” The availability of millions of images and thousands of fonts (not to mention 16.7 millions of colors) at the click of a mouse seem to make every perceivable style and fashion – past and future – easy to emulate, if not invent.

Luckily for professional designers, this sounds easier than it is. If everybody could be a successful designer by following simple recipes, we'd be out of work tomorrow. But that extra ingredient, a concept, an idea, cannot be formulated as readily as this. The waves may come and go, but graphic design will always be about problem solving first, and style-making afterward.

Comparison of critical letter shapes in Akzidenz Grotesk, the mother of most modern sans serifs; Helvetica, the face without features; Univers, the cool alternative; Frutiger, the friendly sans; and Thesis, the typeface with 144 cousins in one family.



For this exercise, we have not shown everything we could on a page. We haven't gone crazy with sampling images, overlaying them as if there were no tomorrow, or using the weirdest fonts available.

Instead, we've picked the typeface that has pretty much replaced Helvetica as Corporate World Font Number One. Frutiger (see page 67) is now available in a good range of weights and widths, making it suitable for almost every typographic task. It avoids Helvetica's blandness, adding instead a humanist touch. This improves legibility by keeping letter shapes open and more distinct from one another.

The condensed weights are particularly suitable for projects that need a clean-looking, highly legible, relatively neutral, and space-saving typeface.

Handgloves

FRUTIGER 45 LIGHT

Handgloves

FRUTIGER 55 ROMAN

Handgloves

FRUTIGER 65 BOLD

Handgloves

FRUTIGER 75 BLACK

Handgloves

FRUTIGER 95 ULTRABLACK

Handgloves

FRUTIGER 57 ROMAN CONDENSED

Handgloves

FRUTIGER 67 BOLD CONDENSED

Handgloves

FRUTIGER 77 BLACK CONDENSED

Handgloves

FRUTIGER 87 EXTRABLACK COND.

Franklin Corporation

IF TIME IS the most precious of all things, wasting time must be the greatest sin; since lost time is never found again, and what we call enough time always proves to be too little. Let's be up and doing, and with a purpose, so by diligence we can do more with less perplexity.

Sloth makes all things difficult, but industry all things easy. If you get up late you must trot all day and barely may overtake the business at night; while laziness travels so slowly that poverty will soon overtake you. Sloth, like rust, consumes faster than labor wears, while the used key is always bright. Time is the stuff life is made of; how much more than is necessary do we spend in sleep, forgetting that the sleeping fox catches no

Industry need not wish; if you live on hope you will die fasting.

If you have a trade, you have an estate, and if you have a calling you have an office of profit and honor.



SUSANNA M. FRANKLIN
Chief Executive Officer

poultry, and that there will be sleeping enough in the grave.

Industry need not wish, if you live on hope you will die fasting. If you have a trade, you have an estate, and if you have a calling you have an office of profit and honor. But then the trade must be worked at and the calling well followed.

Though you have found no treasure, nor has any rich relation left you a legacy, diligence is the mother of good luck, and all things are given to industry. Plow deep while sluggards sleep, and you will have corn to sell and keep; work while it is called today or you know not how much you may be hindered tomorrow: one today is worth two tomorrows, and furthermore: if you have something to do tomorrow, do it today. If you want a faithful servant, and one that you like, serve yourself. Be circumspect and caring, even in the smallest matters, because sometimes a little neglect breeds great mischief: for want of a nail the shoe was lost, for want of a shoe the horse was lost, being soon overtaken and stolen by the enemy.

Pension Assets Exceed \$12 Billion

So much for industry, and attention to one's own business, but to these we must add frugality, if we would make our industry more successful. We think of saving as well as of getting. You may think, perhaps, that a little tea, or a little punch now and then, a diet that's a little more

Corporations spend a good deal of money to show their shareholders, their customers, and their banks how good they are (the corporations, not the others). So they hire designers or advertising agencies (there is a difference) to design brochures, booklets, and annual reports to make them look as excellent as they wish they were.

Strangely enough, as anyone who's ever been on a design jury judging annual reports or other corporate messages can attest, many of these printed pieces come out looking very similar. Although some designers set trends and others follow them, they all get paid to make their clients look different from the competition.

It is, therefore, easy enough to design a typically corporate page, at least for the U.S.A. In Europe, this page would look quite different, but with definite similarities within certain countries. You can always tell a German report from a Dutch, British, or Italian one, but they all have one thing in common: the picture of the chairman (or – lately – chairwoman).

The Bodonis have grown into a large family – everybody who is anybody in the type world offers a different version. Here are a few of the styles and weights available.

Handgloves

BERTHOLD BODONI LIGHT

Handgloves

BERTHOLD BODONI REGULAR

Handgloves

ITC BODONI SEVENTY TWO

Handgloves

ADOBE BODONI BOOK

Handgloves

BAUER BODONI BOLD

Handgloves

ADOBE BODONI ROMAN

Handgloves

BERTHOLD BODONI MEDIUM

Judging from the typeface used, the page on the left must be for a financial or similar institution. It is set in Bodoni, and the layout combines classic elements, such as the centered sidebar, with traditional advertising conventions and justified text across a column that is far too narrow to achieve reasonable word breaks and word spaces (more about that in chapter 7).

While you can't go wrong with Bodoni, you could, however, try a different version now and again. Berthold, Linotype, and Monotype Bodonis are very much alike, whereas Bauer Bodoni has so much contrast between thick and thin lines that it isn't really suitable for small sizes. ITC Bodoni is much better at small sizes than all the others. Its little quirks become visible only at large sizes, which might be desirable, as they will add a little life to your pages. And if you need swirls, LiebeFonts' Doni has those.

Handgloves

ITC BODONI BOLD SIX

Handgloves

BAUER BODONI BOLD

Handgloves

ADOBE BODONI BOLD

Handgloves

ITC BODONI BOLD TWELVE

Handgloves

BAUER BODONI BLACK

Handgloves

BAUER BODONI BLACK CONDENSED

Handgloves

LIEBE DONI

Sales Tax

We are required to collect sales tax on shipments to the states listed below. Please add the correct percentage amount.

- Alabama
- Alaska
- Arizona
- Arkansas
- California
- Colorado
- Connecticut
- Delaware
- Florida
- Georgia
- Hawaii
- Idaho
- Illinois
- Indiana
- Iowa
- Kansas
- Kentucky
- Louisiana
- Maine
- Maryland
- Massachusetts
- Michigan
- Minnesota
- Mississippi
- Missouri
- Montana
- Nebraska
- Nevada
- New Hampshire
- New Jersey
- New Mexico
- New York
- North Carolina
- North Dakota
- Ohio
- Oklahoma
- Oregon
- Pennsylvania
- Rhode Island
- South Carolina
- South Dakota
- Tennessee
- Texas
- Utah
- Vermont
- Virginia
- Washington
- West Virginia
- Wisconsin
- Wyoming

Time as a Tool. Benny Frank. Philadelphia: Caslon Publishing, 2020. 790 pages. Hardcover. \$49.98

From Time as a Tool: "If time is the most precious of all things, wasting time must be the greatest sin; since lost time is never found again, and what we call time enough always proves too little. Do not squander time, for that's the stuff life is made of; how much more than is necessary do we spend in sleep, forgetting that the sleeping fox catches no poultry, and that there will be sleeping enough in the grave."

Circumspection at Work. Fran Benjamin. Philadelphia: Caslon Publishing, 2020. 145 pages. Softcover. \$29.98

From Circumspection at Work: "So what signifies wishing and hoping for better times? We could make these times better if we bestir ourselves. Industry need not wish, and he that lives upon hope will die fasting. There are no gains without pains. If you have a trade you have an estate, and if you have a calling you have an office of profit and honor."

Ordering Information

Name

Address

City State Zip Country

Telephone E-Mail

Book Title Quantity

Book Title Quantity

Subtotal

Sales Tax

Shipping (please add \$2 per book)

Total Order

Method of Payment

..... Check or money order enclosed, payable to TimeSaving Books Ltd.

..... Please charge my credit card

Credit Card Number Expiration Date

..... Visa/MasterCard American Express

Signature (required for credit card purchases)

One of the areas typographers usually stay well clear of is the design of forms. They are not the easiest things to design, and in that respect should be considered a challenge. They offer enormous rewards – not winning awards or being included in the design annuals, but in terms of achievement.

Forms always have too much copy, so first choose a font that is narrower than your run-of-the-mill ones. Make sure it is clearly legible, has a good bold weight for emphasis, and has readable numerals.

Keep the preprinted information clearly separated from the areas you want people to fill in. These lines should be inviting guides for people's handwriting, and not look like bars on a prison cell window. The same can be said of boxes around text. Who needs them? Some designers seem to be afraid that the type might fall off the page if there isn't a box around it: it won't happen! Without restricting boxes, forms don't look half as forbidding and official. Different areas on the page can be separated by white space, as shown in our example.

140	141	130	131	120	121	110
240	241	230	231	220	221	210
340	341	330	331	320	321	310
440	441	430	431	420	421	410
540	541	530	531	520	521	510
640	641	630	631	620	621	
740	741	730	731	720	721	
840	841	830	831	820	821	
940	941	930	931	920	921	

If any typeface was designed to be neutral, clean, and practical, it is Univers, designed by Adrian Frutiger, 1957.

Forty years later, Linotype started work on a new version of Frutiger's original design. The new condensed versions are now quite legible, considering how much copy can fit into a confined space. The family now includes 59 weights plus four monospaced typewriter weights. While the old system featured a numerical system to distinguish the weights, with Univers 55 being the normal roman weight, the new Linotype Univers needs three digits. Basic regular is now 430. The first digit stands for weight, i.e., 1 is ultralight, 2 thin, etc., and 9 is extra black. The second digit denotes width, i.e., 1 for compressed, 2 for condensed, 3 for basic, and 4 for extended. The third indicates upright roman (0) or italic (1). Not exactly intuitive, but effective once you get used to it. Frutiger, Neue Helvetica, Centennial, and a few other Linotype faces are still classified according to the old system using two digits to signify weight and width or slant.

This table shows how all the weights of Univers relate to each other. The numbering system makes sense – once you've thought about it.

THE TIME IS

NOW!

IF time be of all things the most precious, wasting time must be the greatest prodigality; since lost time is never found again, and what we call time enough always proves little enough. Let us then be up and doing, and doing to a purpose, so by diligence we should do more with less perplexity. Sloth makes all things difficult, but

shall scarce overtake the business at night, while soon overtakes him. Sloth, like rust, consumes faster than labor wears, while the used key is always bright. Do not squander time, for that's the stuff life is made of; how much more than is necessary do we spend in sleep, forgetting that the sleeping fox catches no poultry, and that there will be sleeping enough in the grave.

So what signifies wishing and hoping for better times?

We may make these times better if we stir ourselves. Industry need not wish, and he that lives upon hope will die fasting. There are no gains without pains. If you have a trade you have an estate, and if you have a calling you have an office of profit and honor. But then the trade must be worked at and the calling well followed. Though you have found no treasure, nor has any rich relation left you a legacy, dili-

gence is the mother of good luck, and all things are given to industry.

Plow deep while sluggards sleep, and you

will have corn to sell and keep; work while it is called today or you know not how much you may be hindered tomorrow: one today is worth two tomorrows, and farther: have you something to do tomorrow, do it today. If you want a faithful servant, and one that you like, serve yourself. Be circumspect and caring, even

in the smallest matters, because sometimes a little neglect breeds great mischief: for want of a nail the shoe was lost, for want of a shoe the horse was lost, being soon overtaken and stolen by the enemy, all for want of care of a horse-shoe nail. You may think, perhaps, that a little tea, or a little punch now and then, diet a little more costly, clothes a little finer, and little entertainment now and then, can be no great

“Wise men learn by others’ harms, fools scarcely by their own.”

Magazines are perhaps one of the best indicators of a country’s current typographical taste; most of them get redesigned often enough to be on top of contemporary cultural inclinations. Magazine publishing is a very competitive business, and design plays a significant role in the way magazines present themselves to the general public.

Depending on the readership, magazines can look old-fashioned, conservative, pseudoclassic, trendy, cool, technical, newsy, and noisy. All these signals are conveyed by typography, which may or may not be an adequate representation of the editorial contents.

For our example, we have chosen to combine a very traditional layout with a not-so traditional typeface. The page employs a lot of the paraphernalia of “good” editorial layout: drop capitals, letterspaced headers, scotch rules, large pull-quotes, italic lead-ins, and a contrasting bold sans serif to complement the serif text face. The italic lead-in uses a bit of a gimmick with those diminishing sizes to attract attention and is just trendy enough to appeal to a readership of people between thirtysomething and the mid-life crisis. These people are reportedly willing to read more than a couple of paragraphs in one sitting.

The textface at left is FF Quadraat by Fred Smeijers. Its almost upright italic and overall condensed letterforms give away its Dutch origin. It is unusual enough to convey a difference, but not so silly and overdesigned as to distract from normal reading.

On close inspection at larger sizes, FF Quadraat looks as strange as the double a in its name. Since it was intended to be set in between 7 and 12 point for long copy and continuous reading, those seemingly exaggerated traits add up to character. No slick mechanical precision here, which may look cold to our eyes, but little quirks to delight the tired eye. Smeijers made thorough studies of hand punchcutting techniques and cut punches himself before he used the computer to digitize his drawings. In fact, he has written a book on the subject, called *Counterpunch*.

Franklin Gothic was also cut in steel punches back in 1904 when Morris Fuller Benton first designed the face for ATF. It, too, has kept a liveliness that is often missing from digital fonts. The little eccentricities helped to make Franklin Gothic the proverbial Anglo-Saxon sans serif. Even today, there are not many other typefaces that combine impact and friendliness so well.

Handgloves

QUADRAAT REGULAR

Handgloves

QUADRAAT BOLD

Handgloves

QUADRAAT SANS

Handgloves

QUADRAAT SANS CONDENSED

Handgloves

QUADRAAT DISPLAY

Handgloves

FRANKLIN GOTHIC CONDENSED

Handgloves

FRANKLIN GOTHIC EXTRA CONDENSED

Handgloves

FRANKLIN GOTHIC NO.2



GOOD TIMES, BETTER TIMES!

WISHING AND HOPING FOR BETTER TIMES?

BE ASHAMED TO CATCH YOURSELF IDLE. When you have so much to do, be up by the peep of day. Handle your tools without mittens; remember, that the cat in gloves catches no mice. There is much to be done, and perhaps you are weak-handed, but stick to it, and you will see great effects, for constant dropping wears away stones; and by diligence and patience, the mouse ate in two the cable and allow me to add, little strokes fell great oaks. If you want a faithful servant, and one that you like, serve yourself. Be circumspect and caring, even in the smallest matters, because sometimes a little neglect breeds great mischief.

"Inglorious here he lays."

Francis Franklin

TIMESAVING BOOKS LTD.

23 Book Road, Boston – U.S.A.



TIMESAVING BOOKS LTD.

Today's lifestyle has one thing going for it: it provides tomorrow's nostalgia; as soon as things are far enough down memory lane, we invariably start looking at them with enchanted eyes.

The other good thing about nostalgia is that you can recycle ideas without being accused of petty larceny; people might even admire your interest in things historical. Frederic Goudy once said "The old guys stole all our best ideas"—we could certainly do worse than look to the past for typographic inspiration. After all, most of the typeface styles we now see have been around for a few hundred years, or at least several decades.

Old advertisements are always a source of amusement, and today we have access to digital versions of the typefaces our predecessors used. We can re-create early ads almost faithfully. A note of caution: if you imitate that old look too well, people might not realize that you're actually trying to tell (or sell) them something new.

Rhode is David Berlow's successful attempt to combine early English Grotesques, as made by Figgins at the beginning of the nineteenth century, and American advertising type, like the straight-sided Railroad Gothic, into a complete and large family of sans serifs. Quiet it is not, but it has great presence.

Handgloves

RHODE BLACK CONDENSED

Handgloves

RHODE BOLD CONDENSED

Matthew Butterick rendered four weights of his version of Hermes in 1995. It has the smudges of rough presswork built into the design itself. Hamilton was adapted by Tom Rickner in 1993. He followed the original Bold weight and used it as the basis for his medium and light versions. While Hamilton Bold is already quite condensed, the Medium and the Light have even tighter counters and shorter ascenders and descenders.

Handgloves Handgloves Handgloves

HAMILTON LIGHT, MEDIUM, BOLD

Hand Hand Hand Handgloves

HERMES THIN, REGULAR, BOLD, BLACK

The fonts used in our nostalgic ad all go back to the days of hot metal typesetting, when one typeface would have to serve the printer not only for setting advertisements, but also for things like invitations and stationery. Type was neither cheap nor as easily available as it is today, so a printer's investment had to go a long way. Letterpress printing meant that letters literally got pressed, and that pressure would leave its mark; the finer the type, the more it would show wear and tear. Jobbing fonts, as they were called, had to be strong enough to withstand the mechanical pressure and loud enough to be noticed. And being somewhat condensed to save precious space was certainly a bonus.

Every foundry had their own version of these hardworking typefaces. Hermes from Schriftguss AG was first produced around 1908, as was its twin, Berthold's Block. In the USA, William Hamilton Page patented his wood type in 1887. They all show a similar approach to the problem: blunt corners, low contrast, and soft outlines. If a letter already looked a little worn, one wouldn't notice the effects of bad treatment as obviously as one would with a sharp Bodoni.

Handgloves

BERLINER GROTESK LIGHT

Handgloves

BLOCK REGULAR

Handgloves

BLOCK HEAVY

Handgloves

BLOCK CONDENSED

Handgloves

BLOCK EXTRACONDENSED

IDLE BANKER LOSES SELF-RESPECT

THE **DAILY INTEREST**
Largest Circulation Anywhere

**“I wished
for the
worst!”**

NATIONAL

Boy Raised by Sea Otters Declared Financial Wizard

Be ashamed to catch yourself idle. When you have so much to do, be up by the peep of day. Don't let the sun look down and say: «Inglorious here she lays.» Handle those tools without mittens; remember, that the cat in gloves catches no mice. It is so true there is much to be done, and perhaps you are weak-handed, but stick to it steadily, and you will see great effects, for constant dropping wears away stones; and by diligence and patience, the mouse ate in two the cable, and little strokes fell great oaks. If you want a faithful servant, and one that you like, serve yourself. Be circumspect and caring, even in the smallest matters, because sometimes a little neglect breeds great mischief: for want of a nail the shoe was lost, for want of a shoe the horse was lost, being soon overtaken and stolen by the enemy, all for want of care of a horseshoe nail. *pg. 12*

Aliens Open \$1 Million Account in Tucson

EXCLUSIVE ELVIS SEEN AT BANK

**Woman Faints While Waiting
for Travelers Cheques:
“I thought it was my new diet.”**

Think of saving as well as getting. A person may, if she doesn't know how to save it as she gets it, keep her nose all her life to the grindstone, and die not worth a penny. A fat kitchen does makes a lean will. You may think, perhaps, that a little tea, or a little punch now and then, a diet that's a little more costly, clothes a little finer, and little entertainment now and then, can be no great matter: Many a little makes a mickle; beware of those little expenses – a small leak will sink a great ship, and be reminded again that those who love dainties shall beggars prove, and moreover, fools make feasts, and wise men eat them. Buy what you don't need and before long you will sell your necessities. «At a great pennyworth, pause awhile.» Cheapness is apparent only, and not real; the bargain, by straitening you in business. *continued on pg. 5*

Every society needs a diversion that doesn't do any physical harm, but keeps those people who prefer to live in fantasy worlds occupied. Certain newspapers cater to this segment of the populace, and the typographic styles reflect their journalistic attitude toward the truth. How do you design stories about children born with three heads, or families that glow in the dark, or nine-month-old babies who can bench-press their moms? Easy: take bold, preferably condensed typefaces, randomly distort the shapes electronically, put outlines around them, mix several together, and insert on the same page.

We haven't quite dared to apply the same techniques in this book. Neither have we exposed our readers to the sort of illustrations these sensationalist newspapers use, although image-manipulation has never been so easy with such realistic results: it's almost too simple to depict a UFO hovering over West Virginia.

Once you start looking for really bold condensed fonts, you realize that there can never be enough of these, as every magazine needs headlines that shout and scream.

We mentioned the ever-present Futuras, Franklin Gothics, and Antique Olives on page 53, where we also showed Flyer, Block, and Poplar, as well as some newer alternatives. Most of these, however, are far too well behaved and good-looking to use in a sensationalist way.

Handgloves

AACHEN BOLD

Handgloves

FF SARI EXTRA BOLD

Handgloves

FORMATA BOLD CONDENSED

Handgloves

INTERSTATE ULTRA BLACK COND.

Handgloves

GRIFFITH ULTRA CONDENSED

Handgloves

FF FAGO CONDENSED

Handgloves

IMPACT

Handgloves

TEMPO HEAVY CONDENSED

Handgloves

FF UNIT ULTRA

Handgloves

AMPLITUDE EXTRA COMP. ULTRA

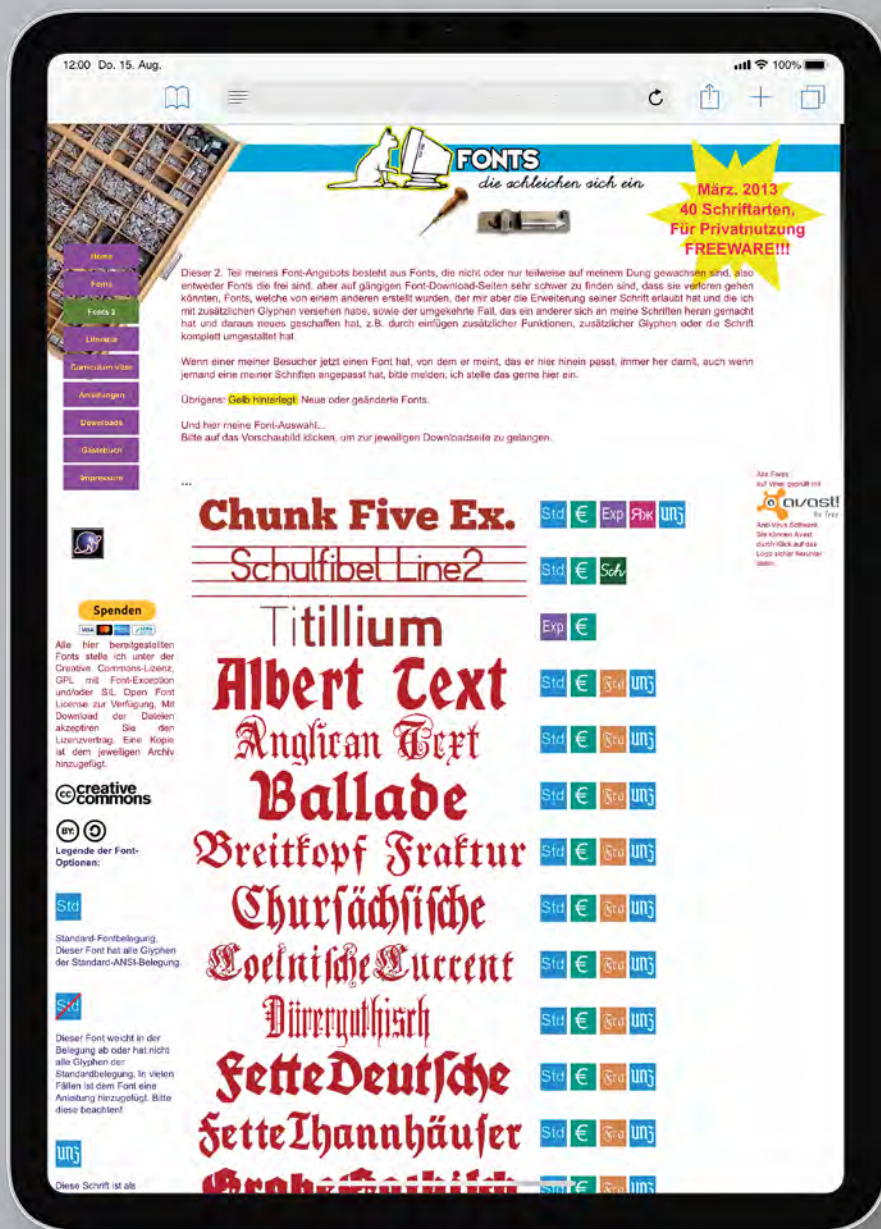

The closest things to UFOs in the type world are those websites that offer pretty much every typeface ever designed – for free. These sites live in their own universe, where someone has unlimited time to either steal font data from strange sources or actually trace specimens, print-outs and other appearances of Unknown Font Objects. Often the pirated fonts are given new phantasy names, sometimes they just use the original names and hope nobody will go after their publishers.

I can understand that not every small design project warrants spending hundreds of dollars on a new font which may then turn out to not be the right one for the job. When the first edition of this book was published in 1993, it was difficult to envisage what a typeface would look like in a project – on a package, a book page or a website. These days, however, most font foundries (as even the digital suppliers of type are still called) offer ways to try out a face on their site. Or you can download a trial version which may have a few characters or features missing but is sufficient to visualise the real thing.

Some sites offering free fonts are run by people who do have enough spare time to “make” their own fonts and give them away, and those may actually resemble the originals that inspired them. But don’t expect those fonts to be produced to professional standards. They will often lack a full character set, the outlines are usually badly drawn, hinting is automatic at best and there is no guarantee that the fonts will show up in all browsers or print properly. You get what you pay for. Or don’t, as it were.

Type design is hard work. Not that type designers don’t have fun, but it takes lots of hours to make sketches, draw hundreds of characters, and to produce reliable working fonts from those drawings.

To make a living designing type and making fonts, users (you and me!) need to pay for licenses, just like we pay for the other tools we use: apps, computers, paper, ink, pens, and coffee.

Giant companies may be able to give away “libre” fonts as they make their money from our data, but designers need to get paid properly. Using fonts without a license is stealing from people in our own business.

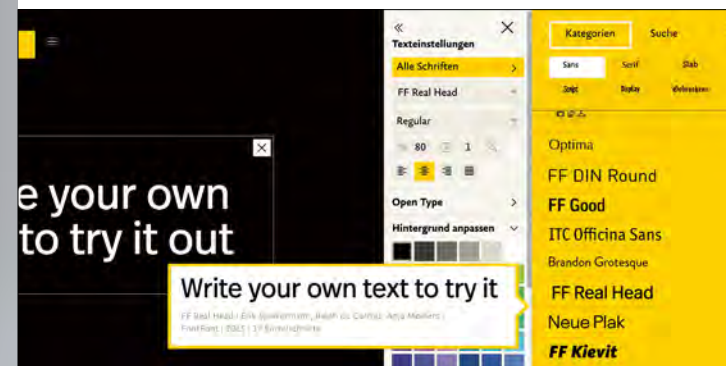
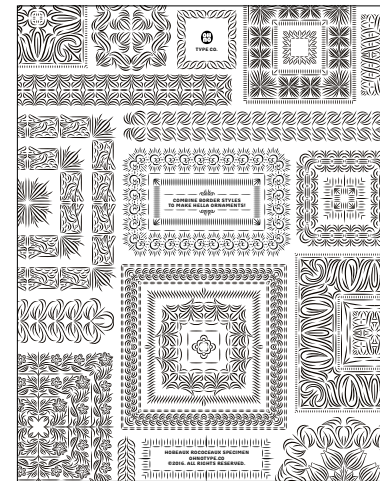

Type designers and foundries produce the most amazing materials to show off their goods and provide tools on their websites to display their fonts before you commit to buying a license.

A specimen PDF for Hobeaux Roccoeaux by Ohnotype.co, above, and the type tester on FontShop’s website, on the left.

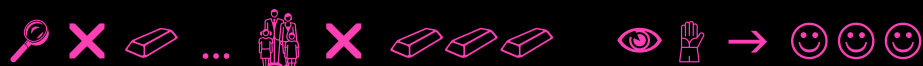

If time be of all things the most precious, wasting time must be the greatest prodigality; |

since lost time is never found again, | and what we call time enough always proves little enough. | Let us then be up and doing, and doing to a purpose,

so by diligence we should do more with less perplexity. | Sloth makes all things difficult, but industry all things easy. |

He that riseth late must trot all day and shall scarce overtake the business at night; while laziness travels so slowly

that poverty soon overtakes him. | Sloth, like rust, consumes faster than labor wears, while the used key is always bright. | Do not squander

time, for that's the stuff life is made of; for how much more than is necessary do we spend in sleep, forgetting that there will be sleeping enough in the grave.

So what signifies wishing and hoping for better times? | We may make these times better if we bestir ourselves. | Industry need not wish, and

he that lives upon hope will die fasting. | There are no gains without pains. | He that hath a trade

hath an estate. | Though you have found no treasure, nor has any rich relation left you a legacy, diligence is the mother

of good luck, and all things are given to industry. | Plow deep while sluggards sleep and you will have corn.

Although symbol sets are not, strictly speaking, actual typefaces, they are still able to depict Ben Franklin's message accurately. They are widely available and can be used for text, just like letters. In fact, our alphabet started out as pictograms, little drawings symbolizing objects, people, activities, or events.

A drawing of a skull and crossbones is internationally understood as a sign of death or (at least) danger; the arrow indicates direction or movement; a bed is a bed, signifying rest; a clock stands for time, the dollar sign for money.

Generally, symbols, signs, and dingbats are used to express an idea that would take up too much room to say in words, especially if it has to be understood by people from different cultures and therefore be written in more than one language. Airport signage is the obvious example.

It might be appropriate to substitute a symbol for a frequently used word or phrase, or just to add sparkle to the text. There are many symbol fonts available. Often a symbol can be used to good effect quite differently from the way it was intended. And if the symbol you want doesn't exist, just draw it for yourself in an illustration program.



CARTA



POPPI



GLYPHISH



FF BOKKA ONE



LIEBE COOK

Since we started reading messages and even long text on small screens, designers of these devices had to cram more and more information into very little space. Words are often too long and also need to be translated into many languages which may use from three to twenty or more characters for the same expression. So they went back to those icons that we used before the alphabet was developed into the incredibly concise system that it is today.

Type designers have turned their attention to these icons and made them either to extend a companion typeface or to exist on their own just for UI (User Interface) applications.

Emoji? I hear you ask? Not in this book.

An arrow can mean anything. It can pierce a heart to represent love, it can be bent in the middle to represent lightning or to warn of high voltage, it can announce a change of direction or confirm the chosen direction, it can denote a relation between sender and receiver.

This usage ignores the accepted logic of signage systems. There, an arrow points in the direction in which we're supposed to move. The arrow serves as a topological symbol, it indicates our relation to a given area. And because it's so simple, we can also understand when it's used in the sense of "from-to." Indicating left in our left-to-right reading direction can only mean that something is going out.

A lot of typefaces come with arrows. They can be had in different weights, styles, and positions.

Without arrows we'd be lost wherever we go. No signage can function without this archaic sign – concrete yet symbolic – which is much older than our alphabet.



ADOBE MINION



FF META PRO

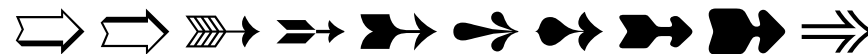
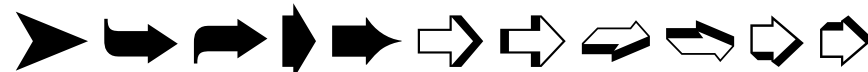

ITC ZAPP DINGBATS

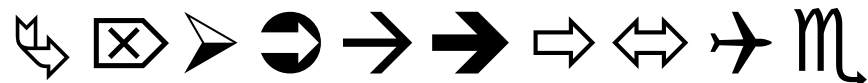

WINGDINGS

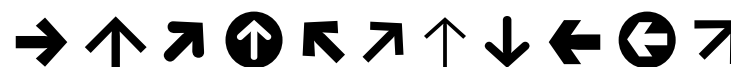

FF DINGBATS ARROWS



LOUIS OPPENHEIM

**Kid gloves,
mild spring breezes
and sharp pencils
were not present
during the creation
of my typefaces.**

(1879–1936), German-Jewish poster artist and graphic designer who worked in Berlin from 1912 to his death, known for his humorous caricatures and advertising work. His typefaces ignore all conventions and have character, to say the least: Magere Block (as co-designer), wobbly Lo-Schrift, expressionist Fanfare, skinny Flamingo.

Funfair

CHAPTER 6

**Types
of type.**

FF Real Head Regular



WHAT DO WE REMEMBER about people? Without the aid of sound and scent, we have to rely on the visual data: the color of their eyes and their hair; are they tall or small, slight or heavy; do they wear glasses, have a beard or crooked teeth?

Many of these features are obscured and thus unavailable for use in identification when somebody steps into your path from the direction of the sun. All you see is a featureless outline. The more clothes this somebody wears, the more the shape is obscured. The worst case is the one illustrated here: we asked John, Paul, George, and Rita to wear hats and jackets for these photographs, and consequently had difficulty telling who was who when we looked at the prints.

But then that was the point. Typographically speaking, this would be like spelling words in capitals only and then putting a box around each letter. You would have to look at each letter individually to be able to spell the word, and there would be no help from the overall word shapes. Unfortunately, many signs that we are supposed to be able to read in passing are designed this way. But words are like faces: the more features we can see, the easier it is to tell who is who.

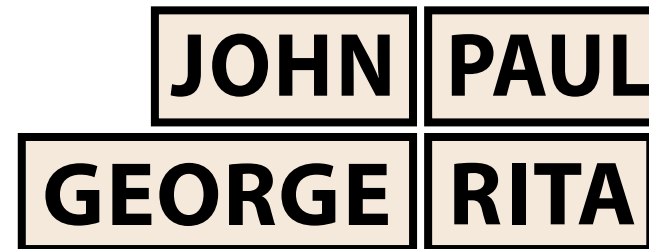

While we have made things difficult by only using capitals and putting those into a box, we at least used a typeface that is easy to read; the letterforms are distinct enough to be told apart, while not so individual that one has trouble reading complete words.

When we read longer text, we don't look at individual characters; we recognize whole word shapes and see what we expect to see. That's why we don't often spot typing errors. But when we are looking for something new or unknown, like the name of a place or a person, we need to look at each letter carefully. This is particularly true for checking names or numbers in lists or other directories. The typefaces designed for these purposes (shown on page 41) give prominence to individual characters. For text fonts, the art is creating clear, distinguishable letterforms that harmonize well in words and sentences.

The big test words in boxes are set in Myriad; below are alternative sans serif capitals.

GEORGE

ITC AVANT GARDE GOTHIC DEMI

GEORGE

GILL SANS SEMIBOLD

GEORGE

FF DIN BOLD

GEORGE

FUTURA HEAVY

GEORGE

THESIS SANS BOLD

GEORGE

HELVETICA BOLD

GEORGE

FF META BOLD

GEORGE

FF KIEVIT BOLD



Since it's polite to take off one's hat when meeting someone, we now have a chance to get a better look at our four well-mannered friends: still no faces, but different hairstyles give us better clues to their identities. Setting the names in capitals and lower case gives each of the words a definite outline.

If you look at them again, you could probably tell them apart just by the shape of the box, at least that is what your unconscious mind will do: if it sees a familiar shape, it will automatically give you the name associated with it.

John
Paul
George
Rita

The outline of a word is determined by which letters jut up from the main body and which hang down. They are called ascenders and descenders, respectively.

Research has shown that our eyes scan the top of the letters' x-heights during the normal reading process, so that is where the primary identification of each letter takes place. The brain assembles the information and compares it with the shape of the word's outline. If we had to consciously look at individual letters all the time, we would read as slowly as children who have not learned to assume a word's meaning from such minimal information.

While ascenders and descenders are vital for easy reading, they have to blend in so they don't attract attention to themselves. Typefaces with exaggerated details may look very attractive word by word, but are their own worst enemies when it comes to unimpeded reading. In typography, everything is connected to everything else; individual elements are noticeable only at the expense of the whole.

The test words on the left are set in capital and lowercase Myriad. Below are ascenders and descenders, as performed by four other typefaces.

George & Paul

Antique Olive (hardly any ascenders or descenders)

George & Paul

ITC Garamond Book (not very explicit)

George & Paul

Garamond ATF Micro (average)

George & Paul

Weiss Italic (pretty obvious ascenders)



The moment of truth, in life as in typography: no more hiding behind hats or coming in from the light. Now we can look at features – eyes, lips, hair – as well as stylistic additions like glasses and haircuts. And our friends have expressions on their faces, although they were all told to look “normal.”

Obviously that meant something different to each of them, as it does when typefaces are described as normal, useful, or sturdy, let alone beautiful, delicate, or handsome.

Most graphic designers and typographers agree that only a handful of typefaces is needed for their daily work; fortunately (at least for the manufacturers and type designers), they could never agree on the same dozen or so typefaces. We need thousands. Then each of us can pick our favorites. Just like shoes: one doesn't need more than half a dozen pairs, but another person will make a different selection, and so on. For individual expression, as well as maximum legibility, we need to pull out all the stops.

Picking the right font for a particular message can be fun, but also extremely difficult. What do you want to express besides the bare facts? How much do you want to interpret, add your own comment, decorate, illustrate? Even if you choose what might be called a “neutral” typeface, you've made a choice that tells people the message *is* neutral.

When you design the visual appearance of a message, you are adding some interpretation to it. John, Paul, George, and Rita would doubtless have a lively discussion about the typefaces chosen to represent their names and thus, them.

The choices were governed not so much by trying to get across their personalities, as by the actual letters appearing in their names. The choice of a typeface can manipulate the meaning of that word.

John Paul

GILL SANS BOLD

TEKTON BOLD

George Rita

FF SCALA CONDENSED BOLD

ITC BENGUIAT GOTHIC BOLD

It is one thing to pick typefaces to represent individual people, and quite another to express similarities as well as differences within the same family. We know that sisters and brothers don't always get along with each other. However, it is easy to tell when people belong to the same family; some take after the father, some after

The Von Trapp family demonstrated old-fashioned family values: live together, sing together.

the mother, and some have a combination of both parents' features.

Type also comes in families.

While some weights might be used more extensively than others (you wouldn't set a whole book in **bold type**), there is no paternal or maternal dominance within typographic families. Each member does its work regardless of age or status. In some respects, the world of type is an ideal one.

Traditionally, typefaces used for setting books had no bold weights, let alone extrabold or condensed versions, or even real display weights. Those more eye-catching additions came about at the beginning of the nineteenth century, when the Industrial Revolution created the need to advertise goods.

Properly applied, however, a complete family gives you enough scope to solve all typographic problems in the setting of text. Nowadays, semibold or bold weights are part of even the most traditional families.

If you find that incestuous typography won't solve your communication problem, you can go outside and bring in some fresh blood from other families. These days, this is quite permissible – more about that on page 121.

The Adobe Garamond family was designed in 1989 by Robert Slimbach. Without its small capitals, and bold and italic children, and its titling cousin, this typographic family wouldn't be large enough to form a choir.

Handgloves

ADOBE GARAMOND REGULAR

Handgloves

ADOBE GARAMOND ITALIC

Handgloves

ADOBE GARAMOND SEMIBOLD

Handgloves

ADOBE GARAMOND SEMIBOLD ITALIC

Handgloves

ADOBE GARAMOND BOLD

Handgloves

ADOBE GARAMOND BOLD ITALIC

HANDGLOVES

ADOBE GARAMOND TITLING

HANDGLOVES

ADOBE GARAMOND SMALL CAPS

Can you tell the difference between a National steel guitar, a square-neck Hawaiian, a Fender Telecaster, a Dreadnought, or an acoustic twelve-string? Look to your left. All of those guitars are there, displayed in the living room of the musician who let us take this photograph. To play a wide variety of music, all of these guitars are used.

Even though only serious musicians could detect the difference between instruments on a recording, the guitarist still has to decide which one will make the particular piece sound perfect, just as a chef will use spices you've never heard of to make your supper taste wonderful. It's the adaptation of one basic, popular tool to serve many different purposes, and the professional needs all the choices available.

When it comes to refinement, type is no exception. Not surprisingly, the fonts providing that extra used to be called "expert sets." Some of them did indeed require an expert to find all the right characters and put them in the proper place, but when you have a complex problem to solve, you cannot expect a simple solution.

Today, most OpenType fonts have these features integrated, and those with a "Pro" in their name have enough to make even the most demanding type nerd happy.

Different figure sets:
Tabular lining,
proportional lining,
tabular old style,
proportional old style.

1234567890

1234567890

1234567890

1234567890

ct fb ffb ff fh ffh fi ffi fj ffj fk ffk fl ffl ft fft st tt

cṭ fḅ ffḅ ff̣ fḥ ffḥ fị ffị fj̣ ffj̣ fḳ ffḳ fḷ ffḷ fṭ ffṭ sṭ tṭ

Before and after ligatures;
Garamond ATF Text

Remember the typewriter? It has fewer keys than a computer keyboard, and the most you could get on your golfball or daisywheel were 96 characters. Considering that the English alphabet only has 26 letters, that isn't bad, but compare it with the full character set of at least 220 characters in a typical digital font.

There are languages other than English, measurements other than inches, feet, and yards. Specialized professions and sciences require their own ways of encoding and decoding messages, and expert sets make this a little easier. Two types of characters that used to be part of standard typeface families for metal setting are now included in most digital typefaces: old style figures and ligatures.

Numerals can be an eyesore when they are set in the middle of regular text. Old style figures, sometimes called lowercase figures, are endowed with features like ascenders and descenders, which allow them to blend right in with the other words on a page. Sometimes, a letter collides with a part of a neighboring one. The most obvious example is the overhang on the f and the dot on the i. Combination characters, called ligatures, prevent that unhappy collision.



Many special characters would deserve a mention in a book about type and typography: the pilcrow, the octothorpe, the ampersand, the @ symbol, asterisk and dagger, hyphen, the en dash, the em dash, &cetera. As it happens, Keith Houston has already written a book about all of them: *Shady Characters*. There is nothing anyone could possibly add to that, so we'll just have to stick with bare essentials here.

When you want to put something into quotes, you usually just press the key with those two short lines on it. On most operating systems, that represents a plain double stroke. Using that instead of proper typographic quotes gives you away as a beginner, a lawyer, a bookkeeper – anything but a professional designer.

Proper quotes look like two commas. Depending on the language being set, these can be at the bottom, looking like 99; at the top like 99; at the top reversed, like 66. The same goes for single quotes.

Mechanical typewriter keyboards used only very few keystrokes: no option/command/alt-shifts there. There were around 96 keys available, so no room for fancy stuff, just the bare essentials. The inch mark had to act as double quotes and the single foot mark as apostrophe. Some keyboards didn't even have a figure 1, so you would have to use the lowercase *l* instead. Likewise there were zero zeros – the plain old *O* would have to do.

Sticking with those conventions would be like listening to an old-fashioned transistor radio from the fifties instead of a proper big stereo. Same music but increased listening pleasure.

The “dumb” quote was one of the glyphs used to keep down the number of keys on a typewriter. It had to do multiple duties and was used for an apostrophe and closing single quotation mark ('), for an opening quotation mark ('), and for a prime mark ('). Real prime and double prime marks are used to represent feet, hours, inches and minutes. They are almost impossible to find on a computer keyboard. On a US Apple keyboard, type alt+E for a single prime and alt+G for a double.

“ ”

DIDOT

///

ADOBE GARAMOND

“ ”

EQUITY

“ ”

FF UNIT

“ ”

LO-TYPE

“ ”

BLOCK

“ ”

NEUE HELVETICA

“ ”

FF DIN

///

UNIVERS

///

FUTURA

///

OPTIMA

///

PALATINO

///

FANFARE

///

REPORTER

“ ”

MARKER FELT



Applications age very quickly and need to be updated or even replaced almost every season. Fonts, however, which were released decades ago, can still be installed and used. Therefore many users still consider OpenType a disruptive new format, although it's been around since 1996.

OpenType is named appropriately. It works across platforms and operating systems, with its technical specs well hidden under the hood. Programs like the Adobe Creative Suite fully exploit whatever the type designer has included, but you need to look a little deeper.

Expanded character sets and layout features can be fun to use, and linguistic support extends to Greek or Cyrillic characters and even beyond. Stylistic sets offer advanced typographic control but are not always easy to get to. Reading the spec sheets provided by most foundries can reveal a treasure of typographic features that will make layouts look amazingly professional at no extra cost except some investment of time. But who wouldn't enjoy pulling all the stops on stuff like *Contextual Alternates* or *Discretionary Ligatures*?

HandHandHandHandHandHandglovesglovesglovesglovesgloves

FF MARK HAIRLINE, THIN, EXTRA LIGHT, LIGHT, REGULAR, BOOK, MEDIUM, BOLD, HEAVY, BLACK

DISCRETIONARY LIGATURES: This feature replaces a sequence of glyphs with a single glyph which, in contrast to the Standard Ligatures feature, may not be desired in all text settings.

ft → ft

HISTORICAL FORMS: This feature replaces the default (current) forms with the historical alternates.

hist → hift

SMALL CAPITALS: Turns lowercase characters into Small Capitals. Forms related to Small Capitals, such as Oldstyle Figures, may be included. The ALL SMALL CAPITALS feature turns all characters into Small Caps.

Small → SMALL

Small → SMALL

ORDINALS: This feature replaces default alphabetic glyphs with the corresponding ordinal forms for use after figures.

1st 2a → 1st 2^a

ALTERNATE FIGURES: This feature containing eleven sets is demonstrated in more detail on p. 171.

1 → 111₁¹

STYLISTIC ALTERNATES: This feature replaces the default forms with stylistic alternates. Many fonts contain alternate glyph designs for a purely aesthetic effect; these don't always fit into a clear category like swash or historical.

ɑ → a J → J

Z → Z 7 → 7

The features shown replace the default forms with stylistic alternates organised in one or more corresponding sets.

Ä Ö Ü → A O U

Typefaces used in Stop Stealing Sheep, 4th ed.

23% serif



31% sans

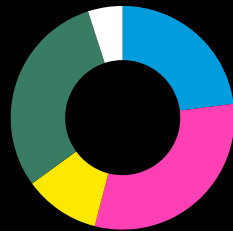

11% script



30% display

5% symbols



Fonts are a useful, space-saving and simple way to access vector data from a keyboard. Charts and graphs represent data in vector form and are cumbersome to use and especially to correct once they have been generated as images.

Driven by the frustration of creating graphs within design applications, Travis Kochel took advantage of OpenType technology to simplify the process.

Primarily suitable for Adobe Creative Suite, FF Chartwell for print uses OpenType ligatures to transform strings of numbers automatically into charts. The data remains in a text box, allowing for easy updates and styling. You simply type a series of numbers like: "10+13+37+40." Turn on ligatures and a graph is created. Turn off ligatures to see the original data.

There is also a web version where all the chart drawing functions are provided as small JavaScript libraries. To create a chart you enter the values in a similar way to the desktop font and use HTML code to determine color and appearance.

This is how the print version is used:

- 1 Letter spacing set to "0" (zero)
- 2 The values 0-100 are typed, then "+" combines them into one chart. If the total is above 100, a new chart will begin. Using the letters A-E defines the grid for *Rose*, *Rings*, and *Radar*. *Bars Vertical* create sparklines and other bar graphs, and *Lines* makes charts. *Layering* creates more complex diagrams.

- 3 Adjust the colors as you wish.
- 4 Turn on *Stylistic Alternates* or *Stylistic Set 1* and bingo!

To see the original data all you need to do is turn off *Stylistic Set* or *Stylistic Alternates*.

10+13+37+40 =



ABCDEFGHIJKLMN

OPQRSTUVWXYZ

abcdefghijklmn

opqrstuvwxyz

01234567890!?!&\$

@#,'":,%,',"' -*

(+) {·} /|\ [...] -<=>

Basic numerals, alphabet and punctuation, to aid in preparing the information, are included in the character set.

What if some members of your family can't sing? What if you need two sopranos, but only have one sister? Maybe you have three sisters and two brothers who can't sing or play an instrument. OK, then find yourself some outsiders, put them in the same sort of outfits, call them a "family" and everybody will believe you've been together all your lives. This is what Lawrence Welk did.

The typographic equivalent does not appear quite so harmonious. In fact, the idea is to bring in outside fonts which do things your basic family can't. Usually this means a few more heavy weights if you're setting text in a classic book typeface that hasn't got a bold, let alone an extrabold weight. Or you might need more contrast – magazine pages all set in one kind of type tend to look very gray. And then, some types look better in certain sizes, so this too has to be considered if you have text that has to be set much smaller or larger.

High-fashion designers call these things accessoires, and typographic equivalents have to be chosen the same way: they have to fulfill a particular function while achieving an aesthetic balance with the main dress.

The best way to add typographic impact is to use extended typeface families such as Lucida, which include a sans serif and a serif; or a family such as ITC Stone, which has a sans serif, a serif, and an informal version.

Rotis, designed in 1989 by Otl Aicher, one of Germany's best-known designers, comes in four versions: Sans, Semisans, Semiserif, and Serif.

Erik Spiekermann's ITC Officina was originally intended to be used for office correspondence; thus a sans and a serif version to replace Letter Gothic or Courier.

A more daring way to add contrast and adventure to a typographic page is to invite members from other typeface families. It is generally alright to mix different types from the same designer (Eric Gill's Joanna and Gill Sans work well together, as do most of Adrian Frutiger's types), or from the same period, or even very different periods. There are almost as many recipes as there are fonts. The pages in this book are themselves examples of mixing different typefaces: Equity for text; and FF Real Condensed, a sans serif in a bold weight at a smaller size (and in another color) for sidebars, captions, lists.

Handgloves

ROTIS SANS SERIF

Handgloves

ROTIS SEMISANS

Handgloves

ROTIS SEMISERIF

Handgloves

ROTIS SERIF

Handgloves

ITC OFFICINA BOOK

Handgloves

ITC OFFICINA ITALIC

Handgloves

ITC OFFICINA BOLD

Handgloves

ITC OFFICINA SERIF BOOK

Handgloves

ITC OFFICINA SERIF ITALIC

Handgloves

ITC OFFICINA SERIF BOLD

Handgloves

JOANNA REGULAR

Handgloves

JOANNA EXTRA BOLD

Handgloves

GILL SANS REGULAR

Handgloves

GILL SANS REGULAR ITALIC

Handgloves

GILL SANS BOLD

Handgloves

GILL SANS BOLD ITALIC



Now that we've begun the music/type comparison, let's use one more example from that world to illustrate another typographic feature.

There is loud music and quiet music, dulcet tones and heavy ones, and there is – did you ever doubt it? – a typographic parallel. Some typefaces are loud by design, some are rather fine and sweet. A good family of fonts will cater to all these moods.

To illustrate the widest possible range within one family, we've chosen a typeface of many weights and versions, Helvetica, beginning with the lightest weights to suggest the tones of a flute. Very light typefaces are for those messages we want to look delicate and elegant.

Helvetica is not the most elegant type design of all time, but it is practical and neutral, and it is seen everywhere. Designed by Max Miedinger in 1957, the family grew in leaps and bounds with different typefoundries (Haas in Switzerland, Stempel and Linotype in Germany) adding weights as their customers created the demand for them. The result was a large family that didn't look very related.

When digital type became the production standard, Linotype decided to reissue the entire Helvetica family, this time coordinating all the versions to cover as many weights and widths as possible. To help distinguish among the fifty of them, they were given the same numbering system as the one originally devised by Adrian Frutiger for Univers (and since revised, as two digits were not enough to explain all the variants – see page 89); here the lightest weight is designated by a "2" in its name. The typeface has been renamed Neue (German for new) Helvetica.

Christian Schwartz redesigned not Neue Helvetica, but its mother, Haas Grotesk, and called it: yes, Neue Haas Grotesk. The first line is Neue Helvetica 95 Black, second line is Neue Haas Grotesk 95 Black.

gestalt
gestalt
gestalt
gestalt
gestalt

H H H H H H H H H H
25 26 35 36 45 46 55 56

The third line shows yet another new version: Helvetica Now, released by Monotype in 2019. There are three families: Display, Text and Micro. The third and fourth line show the Black weights for Display and Text, the fifth line is Micro ExtraBold. As this is intended for small (!) sizes, a Black weight would be too fat altogether. The larger the intended use, the wider the built-in tracking.



The flute makes light, delicate sounds; at the other end of the musical spectrum is the tuba with its undeniably substantial sound. As every music lover knows, a big instrument doesn't always need to be played at full volume, and a tuba will never work in the confines of a small chamber ensemble.

There are also limits to the use of very bold typefaces. At small sizes the spaces inside bold letters start filling in, making most words illegible. So, like writing music for the tuba, the best thing for bold faces is to use them where you need to accentuate rhythm and lend emphasis to the other instruments and voices.

As letters get bolder, the white space inside them decreases, making them appear smaller than lighter counterparts. The type designer allows for this effect by slightly increasing the height of bolder letters. A similar thing occurs with the width of the letter - as the thickness of the stems increases, weight is added to the outsides of the letters, making the bolder weights wider than their lighter cousins.

By the time letters are very bold, they're usually called black or heavy, or even extra black or ultra black. There is no system for naming weights in a family, so for clear communication it is safer to use the number designations when talking about a large family like Neue Helvetica.

Once the weight of a letter has reached a certain critical mass and width, it begins to look extended, as well as extra bold. Extending a design adds white space to the counters (the space inside letters), so some extended black versions may appear lighter than their narrower black counterparts.

In the case of Neue Helvetica, there is one more weight beyond the 95 (black) version: 107, extra black condensed. If you look very closely you will notice, however, that the width of its stems is no greater than those of the black weight. Condensing letter shapes makes the internal spaces smaller and the type much darker.

Handgloves

65 NEUE HELVETICA MEDIUM

Handgloves

75 NEUE HELVETICA BOLD

Handgloves

85 NEUE HELVETICA HEAVY

Handgloves

95 NEUE HELVETICA BLACK

Handgloves

107 NEUE HELVETICA EXTRA BLACK COND.

H H H H H H H H

65 66 73 76 85 86 95 96



Rhythm and contrast keep coming up when discussing good music and good typographic design. They are concepts that also apply to spoken language, as anyone who has had to sit through a monotonous lecture will attest; the same tone, volume, and speed of speech will put even the most interested listener into dreamland. Every now and again the audience needs to be shaken, either by a change in voice or pitch, by a question being posed, or by the speaker talking very quietly and then suddenly shouting. An occasional joke also works, just as the use of a funny typeface can liven up a page.

There's only one thing worse than a badly told joke, and that is a joke told twice. Whatever typographic device you come up with, don't let it turn into a gimmick. A well-coordinated range of fonts will give you the scope for contrast as well as rhythm, and will keep you secure in the bosom of a well-behaved family.

Unlike Univers, Neue Helvetica does not have extremely condensed weights, but within the traditional family of Helveticas there are dozens of other versions, from Helvetica Inserat to compressed or even extra and ultra compressed weights.

Changing the typographic rhythm by the occasional use of a condensed or, indeed, extended typeface can work wonders. Remember, however, that space problems should never be solved by setting lengthy copy in a very condensed face.

Although large families such as Helvetica can make your typographic life easy, it won't be long before they become predictable; the proverb "Jack of all trades, master of none" comes to mind. One would be foolish to ignore the special fonts that have been developed to solve particular problems. If you want ultimate variety within one formal framework, just turn the page.

Helvetica Now was released by Monotype in 2019 and involved several designers. The new version finally acknowledges what typedesigners have known and practised for centuries: letter-shapes and their spacing depend very much on the intended use. Display, Text and Micro are each designed for different applications, as the names suggest. There are 48 weights altogether. Helvetica Micro is the first Helvetica that can actually be read properly on a small display.

Handgloves

HELVETICA NOW DISPLAY

Handgloves

HELVETICA NOW TEXT

Handgloves

HELVETICA NOW MICRO REGULAR

Handgloves

HELVETICA NOW MICRO EXTRABOLD

Handgloves

HELVETICA INSERAT

Handgloves

HELVETICA COMPRESSED

Handgloves

HELVETICA EXTRA COMPRESSED

Handgloves

HELVETICA ULTRA COMPRESSED



23 24 33 34 43 44 53 54 63 64 83 84 27



28 37 38 47 48 57 58 67 68 77 78 87 88 97 98 107 108



You can have as many bands, groups, combos, quartets, and quintets as you like, but nothing surpasses a full orchestra when it comes to producing all the sounds a composer can dream up. Generally, orchestra musicians use instruments that have remained largely unchanged for several hundred years; however, nowadays the odd modern instrument might be included.

Again, all a little like typography. The instruments (our letters) have been around in very much the same shape for several hundred years, and the tunes (our language) haven't changed beyond recognition either. For classical page designs, we have traditional typefaces and our tried and true ways of arranging them on the page. Even new, experimental layouts work well with those types, just as modern composers can realize most of their works with a classical orchestra.

Today's type technology makes it much easier to create closely related weights and widths than ever before. Provided you have good outlines and clean data, software can interpolate and even extrapolate almost infinite steps.

The Multiple Master typefaces we featured in previous editions of this book have been superseded.

Multiple master typefaces were useful because they could be created "on the fly" by the designer or compositor when working in InDesign or other applications that supported the technology. Type design software now has that code built into it, so every type designer can use it to create those in-between weights and widths. That frees the user from making decisions and handling a technology that tended to be delicate, but it means that we are encouraged to buy not just the extremes of a family of faces and make up the members ourselves, but all of them.

Luckily, you can also buy single weights, even out of a large family like FF Clan. Buying a complete family, however, often offers a considerable discount. Beyond outright buying, we now have many new ways of using fonts, like subscribing to a service or renting them for a time or a project.

Near, far, and just about everywhere in between.
More than 370 destinations worldwide.

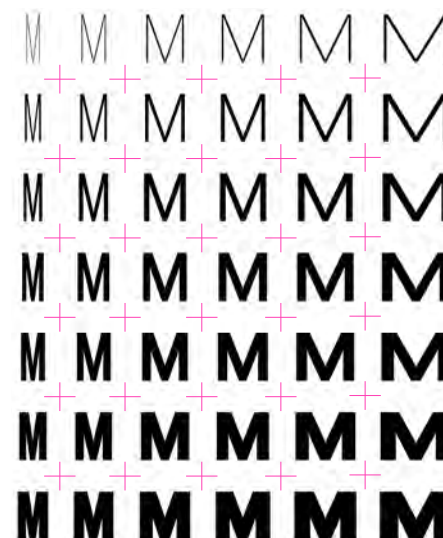

FF Clan is one of those incredibly useful type dynasties, made up of many families and styles. That versatility has led to the face being picked up by United Airlines for all their visual communication.

The most useful regular weight throughout the versions is called "News". The Clan consists of 84 members altogether.

Handgloves

CLAN NEWS

Handgloves

CLAN NARROW NEWS

Handgloves

CLAN CONDENSED NEWS

Handgloves

CLAN COMPRESSED NEWS

Handglove

CLAN WIDE NEWS

Handglo

CLAN EXTENDED NEWS

Ergonomics can be defined as the study of the dynamic interaction between people and their environments, or as the science that seeks to adapt working conditions to better suit the worker. People suffer if chairs are too low, tables too high, lights too dim, or if computer screens have too little contrast or emit too much radiation.

Children could tell stories about having to sit at adult tables, clutching forks that are far too big for them and having to drink from glasses they cannot get their little hands around.

This is similar to what has been done to many typefaces since the introduction of the pantograph in the late 1800s; the practice became even more prevalent with the advent of phototypesetting in the mid-1960s. One size had to fit all. One master drawing was used to generate everything, from very small type to headline-size type and beyond. The multiple master optical size axis made it possible to bring out the variations in design details that allowed a typeface to be optimized for readability at different sizes. 30 years later, that capability has been built into type design software, although plenty of manual intervention is still needed.

Typographic ergonomics at last.

When type was made out of metal (see page 57), each size had to be designed differently and cut separately. The engraver knew from experience what had to be done to make each size highly readable. On very small type, hairlines were a little heavier so they would not only be easier to read, but also not break under pressure from the printing press.

When one master design is used to fit all sizes, as in phototype-setting and digital systems, these subtleties are lost, resulting in compromises that very often give type designs a bad name. This is especially true of the re-creations of classic faces: as originally designed, the types permitted only a limited range of sizes acceptable in terms of readability and aesthetics.

As the amount of novelty typefaces reaches astronomical numbers, some foundries have finally turned to tried and tested classics with the aim to bring back certain qualities we almost lost. Size specific features are back.

In 2018, Charles Nix redesigned Walbaum for Monotype. The versions are named for their intended uses, doing justice to the original designs from the early 1800s.

Compare the differences between the letter shapes and overall weight. The smaller design has heavier stems and serifs, wider characters, and a larger x-height.



Handgloves

MT WALBAUM 6PT

Handgloves

MT WALBAUM 12PT

Handgloves

MT WALBAUM 18PT

Handgloves

MT WALBAUM 60PT

Handgloves

MT WALBAUM 96PT



MT WALBAUM ORNAMENTS

Handgloves

Handgloves

Handgloves

Handglov Handg



When this book first came out, computer screens looked and worked very much like TV sets. Flat screens were desirable but seemed unobtainable and too expensive. Flat LCD screens not only offer higher resolution, but the technology also allowed engineers to come up with more tricks to make bitmaps look acceptable to our eyes. Adobe developed *CoolType*, which uses color anti-aliasing. On old monitors, only whole pixels could be manipulated, but on digital LCD screens, *CoolType* controls the smaller red, green, and blue subpixels, individually adjusting their intensity. This effectively trebles the horizontal grid and achieves more precise smoothing along the edges of characters. A similar technology from Microsoft is called *ClearType*. Better screen resolution still doesn't mean that we can

Our experience with the printed page shapes our expectations for other media. In order to make type on screens look acceptable to our physical requirements and cultural expectations, type designers now have to enlist the help of engineers and programmers. They fit unwieldy bitmaps into strict grids, then instruct the pixels to only appear in certain desired positions, and finally add gray pixels to the jagged outlines to make us see smooth curves where there are only coarse pixels. A lot of effort to overcome the inherent deficiencies of digital media.

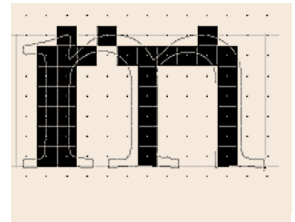

That's what happens when pixels try to fill outlines – some stems are wider than others and details like serifs disappear.

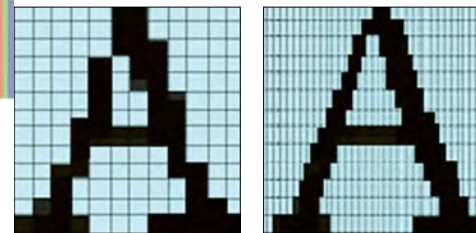

do without these manipulations to get good type on screen.

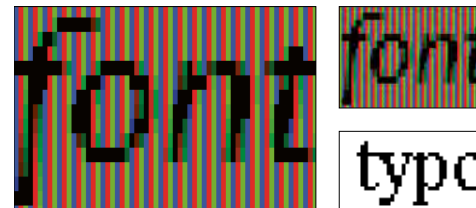

Our eyes can detect minute details that cannot even be measured. But science has become very good at exploiting some weaknesses in our perception. Three colors are enough to paint all possible rainbows, and shades of red, green, and blue make us see smooth curves.

typography

typography

Shades of gray make curves and diagonals appear smooth; this sample is enlarged from a small bitmap.

pack my box with
dog effect coffin
wyvern foxy syryl
Of the greatest ar
look with too mu

pack my box wit
dog effect coffin
wyvern foxy syry
Of the greatest a
look with too mu

Hinting – the instruction of bitmaps to appear in regular, predetermined positions only – overcomes irregular letter shapes and random spacing. See page 177 to see what hinting does to the original outlines.



FREDERIC GOUDY

Anyone
who would
letterspace
lower case
would steal
sheep.

(1865–1947), American typographer and type designer, did not design his first typeface until he was forty-five. He is noted for his profusion of innovative and eclectic type designs and his forthright declarations on typographic issues.

Goudy Old Style

CHAPTER 7

How it
works.

FF Real Head Book



LETTERS WERE ORIGINALLY invented to help communicate not high culture, but mundane things like the amount of goods delivered or their value in barter or currency. What began as individual signs representing real items developed into letters and alphabets.

Different cultures added to the typographic variety. For instance, the most common vowel sound in an ancient language was also the first letter of its alphabet. The Phoenicians (ca. 1000 b.c.) called it *aleph*, the Greeks

Tree farms are to forests what monospaced fonts are to real type.

(ca. 800 b.c.), *alpha*, the Romans (ca. 700 b.c.), *ah*. The Phoenicians had twenty-two letters in their alphabet; the Greeks added vowels, and the Romans developed the letters we still use today. All this time, people wrote either from right to left, or left to right, or top to bottom.

With such a mixed history, no wonder our alphabet looks so unbalanced. Anyone inventing a new alphabet today would doubtless be more practical and make letters more regular. There would be more obvious differences between some shapes, and no narrow letters such as *l* in the same alphabet with wide ones such as *m*.

One consequence of our letters having such complex yet delicate shapes is that we have to respect their space. Every one of them needs enough room on both sides to avoid clashes with its neighbors. The smaller the type, the more space that's needed on the sides. Only big, robust headlines can support the occasional very closely spaced letters.

The history of type is a history of technical constraints. Mechanical typewriters gave us monospaced fonts. Each letter had the same amount of lateral space, regardless of its shape. Later developments led to typewriter fonts with more regular letter shapes; this did not necessarily improve legibility, but these newer alphabets no longer had any gaps between characters. They also appear extremely readable to computers, which don't care that much about tradition.

As soon as typewriters got little computers inside them, they were able to set justified text (lines of the same length), a style which was, and is, largely unnecessary in office communication. But people had learned from reading newspapers, magazines, and books that this was how type should be set.

Now technology allows us to typeset most of the alphabets ever created and actually improve on their appearance, definition, and arrangement. Proportionately spaced fonts are easier to read, occupy less space, allow for more expression, and are nicer to look at. There are only three reasons to still use monospaced fonts: to imitate the time-honored and personal look of typewriters, to write plain emails (see page 175) and to write code.

Himdgloves

H i m d g l o v e s

In monospaced typewriter typefaces, every letter occupies the same lateral space: the *i* is stretched on the rack, while the *m* suffers claustrophobia. The most common measurements are 12 characters to the inch (elite) or 10 to the inch (pica).

Looking at nature, we imagine that God could have designed more practical forests than the ones we know: they are difficult to get around in, full of different kinds of trees in various stages of growth, and there's not enough light. Luckily, we humans are also part of this wonderful, if not entirely perfect, system called nature; we like things that look "human" (less than perfect), but we also like that things conform to a master plan, even if it is indecipherable. We know when something looks "right" without ever having to measure it.

Unfortunately, people have long since begun improving on creation. We won't go into a discussion of inventions like nuclear power or low-fat dog food, but certainly tree farms are a good example of what some people think nature should look like.

If we applied the same logic to type, we wouldn't have any unusual or eccentric designs, where every letter has a different shape and its own individual space. Instead there would only be regularized fonts with nice geometrically defined shapes. How mundane our typographic lives would be.

Unightly character combinations are remedied with kerning.

FF Real Book before kerning (1) and after (2).

1 To·Tr·Ve·Wo·„T·r·y·7·w,

2 To·Tr·Ve·Wo·„T·r·y·7·w,

There are sometimes unsightly gaps that occur between and around particular combinations of letters. Obvious problem letters are V, W, and Y in both capitals and lower case. Other bad gaps appear between numerals and periods or commas, particularly after a 7. (See what I mean?)

Once you look into the relationship of two or more characters in a word, you realize what a mess it can be – not unlike other relationships. One of the most often-spoken words in desktop typography makes its appearance at this point: kerning. To get rid of these unsightly gaps between letters, one simply removes space (or maybe adds it) between the offending pair. A certain number of these problem combinations are adjusted by the type designer; they are known as "kerning pairs" and are included in font programs.

Tracking controls the space between letters globally; this means that equal amounts of space can be added between every letter in your text. It is here that Mr. Goudy's dictum reminds us of the impending danger: as the space between letters increases, so does the difficulty comprehending single words, and thus the thought conveyed in the text.



Letters, like trees, hardly ever appear by themselves. As soon as a bunch of letters are gathered together, they fight for space, for the right to be recognized, to be read. If you plant trees too close to each other, they'll struggle to get light and for space for their roots to expand; the weaker ones will stop growing and eventually die.

Before this turns into a tale of typographic Darwinism, let's look at the practical consequences as far as this book and its subject is concerned. If you know your text is going to be fairly long and that it will require some time to read, you should adjust the layout accordingly. The lines should be long enough to get complete thoughts into them and there ought to be enough space between them to allow readers to finish reading a line before their eye gets distracted by the next.

Marathon runners know they have twentysix miles ahead of them, so it would be foolish to start off like crazy. There is also no need to run in narrow tracks, since by the time everybody gets settled into the race there will be plenty of room, with the first runners miles away from the last ones. With thousands of people in the race, individuals will blend into the crowd, but they still have to give their best.

Long texts need to be read the way a marathon is run. Everything has to be comfortable – once you've found your rhythm, nothing must disturb it again. If you have text that is going to require long-distance reading, design it so the reader has a chance to settle in. The rhythm depends on the spacing contingencies below.

Letters need to be far enough apart to be distinct from one another, but not so far that they separate into individual, unrelated signs. Mr. Goudy knew what he was talking about.

Word spaces have to be gauged so that the reader is able to see individual words, but can also group them together for quick comprehension.

The space between lines of type has to be generous enough to prevent the eye from slipping to the next line before it is finished gathering information in the current one.

The text below has been set for comfortable long-distance reading in 9/12pt Monotype Walbaum, 6pt optical size, 0 tracked, with SMALL CAPS tracked 50 units.

In case you have difficulty reading it: that's not a bug, it's German.

HEINRICH VON KLEIST

*Über die allmähliche Verfertigung
der Gedanken beim Reden*

Wenn du etwas wissen willst und es durch Meditation nicht finden kannst, so rate ich dir, mein lieber, sinnreicher Freund, mit dem nächsten Bekannten, der dir aufstößt, darüber zu sprechen. Es braucht nicht eben ein scharfdenkender Kopf zu sein, auch meine ich es nicht so, als ob du ihn darum befragen solltest: nein! Vielmehr sollst du es ihm selber allererst erzählen. Ich sehe dich zwar große Augen machen und antworten, man habe dir in frühern Jahren den Rat gegeben, von nichts zu sprechen, als nur von Dingen, die

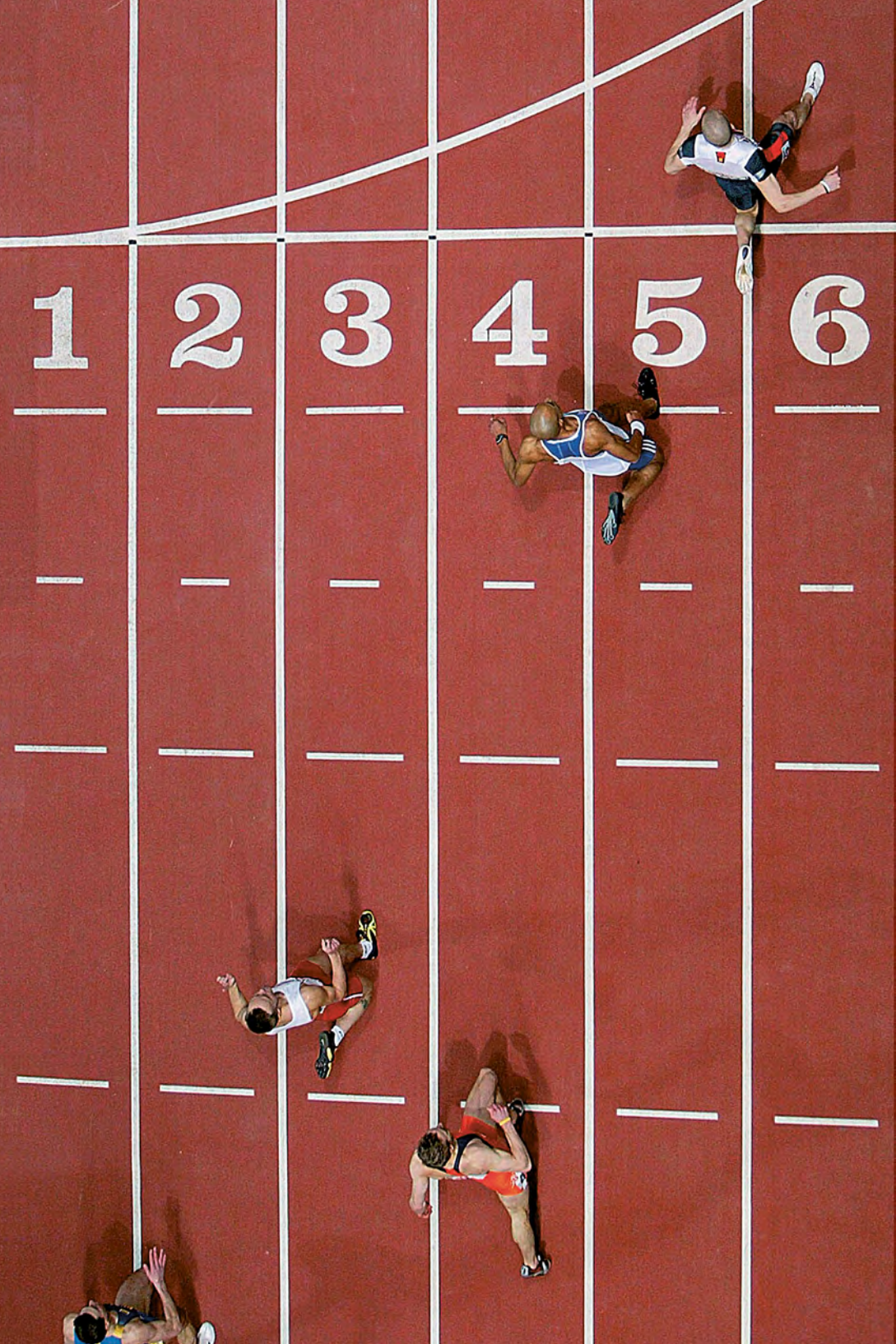

What did people do before there was the instant replay? A 100-yard dash is over in less than ten seconds these days, and spectators can't possibly look at each of the six or more contestants by the time they're across the line. Does that bring to mind the experience of thumbing through a magazine, with all those ads flashing by your eyes in split seconds? That's typography at its most intense. If you want to make an impression in an ad, you can't wait for readers to get settled in, and there is no space to spread your message out in front of their eyes. The sprinter has to hurl forward, staying in a narrow lane. In short-distance text, lines must be short and compact or the reader's eye will be drawn to the next line before reaching the end of its predecessor.

Setting text in short lines for quick scanning requires re-arrangement of all the other parameters, too. Tracking can be tighter, and word spaces and line spaces smaller.

The choice of typefaces is, of course, another consideration. A type that invites you to read long copy has to be inconspicuous and self-effacing, confirming our acquired prejudices about what is readable. A quick look at a short piece of writing could be assisted by a typeface that has a little verve. It shouldn't be as elaborate as a display font used on a label or a poster, but it also doesn't need to be too modest.

If time be of all things the most precious, wasting time must be the greatest prodigality; since lost time is never found again, and what we call time enough always proves little enough. Let us then be up and doing, and doing to a purpose, so by diligence we should do more with less perplexity. Sloth makes all things difficult, but industry all things easy. He that riseth late must trot all day and shall scarce overtake the business at night; while laziness travels so slowly that poverty soon overtakes him. Sloth, like rust,

consumes faster than labor wears, while the used key is always bright. Do not squander time, for that's the stuff life is made of; how much more than is necessary do we spend in sleep, forgetting that the sleeping fox catches no poultry, and that there will be sleeping enough in the grave. So what signifies wishing and hoping for better times? We may make these times better if we bestir ourselves. Industry need not wish, and he that lives upon hope will die fasting. There are no gains without pains.

The above text has been tuned for sprint reading, set in 10/13 Equity, the regular text face in this book.



While driving on freeways isn't quite as exhausting as running a marathon (mainly because you get to sit down in your car), it requires a similar mindset. The longer the jour-

The tricky thing about space is that it is generally invisible and therefore easy to ignore. At night you can see only as far as the headlights of your car can shine. You determine your speed by the size of the visible space in front of you.

ney, the more relaxed your driving style should be. You know you're going to be on the road for a while, and it's best not to get too nervous, but sit back, keep a safe distance from the car in front of you, and cruise.

Long-distance reading needs a relaxed attitude, too. There is nothing worse than having to get used to a different set of parameters every other line: compare it with the jarring effect of a fellow motorist who suddenly appears in front of you, having jumped a lane just to gain twenty yards. Words should also keep a safe, regular distance from each other, so that you can rely on the next one to appear when you're ready for it.

It used to be a rule of thumb for headline settings to leave a space between words that is just wide enough to fit in a lowercase *i*. For comfortable reading of long lines, the space between words should be much wider.

The default settings in most software vary these values, but the normal 100 percent word space seems just fine for lines of at least ten words (or just over fifty characters). Shorter lines always require tighter word space (more about that on the following page spread).

The way to wealth

If time be of all things
the most precious, wasting
time must be the greatest
prodigality; since lost time is
never found again, and what
we call time enough always
proves little enough. Let us
then be up and doing, and
doing to a purpose, so by dili-
gence we should do more

If time be of all things
the most precious, wasting
time must be the greatest
prodigality; since lost time is
never found again, and what
we call time enough always
proves little enough. Let us
then be up and doing, and
doing to a purpose, so
by diligence we should do

A lowercase *i* makes a nice word space for headlines. Short lines should have modest space between the words.

You must have noticed that the lanes on the freeway are wider than those on city streets, even though cars of the same size use both types of road. This is because when traveling at high speeds, every movement of the steering wheel can cause a major deviation from the lane you're supposed to be driving in, posing a threat to other drivers.

This is, in typographic terms, not the space between words, but that between lines – the lanes that words “drive” in. Typographic details and refinement relate to everything else; if you increase your word spacing, you have to have more space between the lines as well.

One rule to remember about line space is that it needs to be larger than the space between words, otherwise your eye would be inclined to travel from the word on the first line directly to the word on the line below. When line space is correct, your eye will make the journey along one line before it continues on to the next.

The rest is very simple: the more words per line, the more space needed between the lines. You can then increase the space ever so slightly between the letters (that is, track them) as the lines get longer.

If time be of all things the most precious, wasting time must be the greatest prodigality; since lost time is never found again, and what we call time enough always proves little enough. Let us then be up and doing, and doing to a purpose, so by diligence we should do more with less perplexity. Sloth makes all things difficult, but industry all things easy. He that riseth late must trot all day and shall scarce overtake the business at night; while laziness travels so slowly that poverty soon overtakes him. Sloth, like rust, consumes faster than labor wears, while the used key is always bright. Do not squander time, for that's the stuff life is made of; how much more than is necessary do we spend in sleep, forgetting that the sleeping fox catches no poultry, and that there will be sleeping enough in the grave. So what signifies wishing and hoping for better times? We may make these times better if we bestir ourselves. Industry need not wish, and he that lives upon hope will die fasting. There are no gains without pains. He that has a trade has an estate, and he that has a calling has an office of profit and honor. But then the trade

The miracle of computers has enabled line spaces to be adjusted in very small increments. In this example, none

of the other parameters has changed – tracking and word space remain the same, but the line space increases.

Notice how the more widely spaced lines cry out for looser tracking and wider word spaces.



In both driving and typography, the object is to get safely and quickly from A to B. What is safe at sixty miles an hour on a straight freeway with four lanes in good daylight would be suicide in city traffic. You have to adjust your driving to the road conditions, and you have to adjust typographic parameters to the conditions of the page and the purpose of the message.

Whether you're driving along looking at the scenery, or stuck in a traffic jam, or slowly moving from one set of lights to the next, you have to be conscious of the drivers around you. If they change their behavior, you have to react. When you learn the rules and have had a little practice, nothing will upset you, not in traffic and not in typography.

Longer lines need wider spaces: in these examples, line space, tracking, and word spaces have all been increased as the lines were widened.

If time be of all things the most precious, wasting time must be the greatest prodigality; since lost time is never found again, and what we call time enough always proves little enough. Let us then be up and doing, and doing to

If time be of all things the most precious, wasting time must be the greatest prodigality; since lost time is never found again, and what we call time enough always proves little enough. Let us then be up and doing, and doing to a purpose, so by diligence we should

If time be of all things the most precious, wasting time must be the greatest prodigality; since lost time is never found again, and what we call time enough always proves little enough. Let us then be up and doing, and doing to a purpose, so by diligence we should do more with less perplexity. Sloth makes all things

Tracking +3, Wordspace 60%

Tracking +5, Wordspace 70%

Tracking +10, Wordspace 80%

One of the best ways to keep the reader's attention on the content of your message is to keep the color of the printed text consistent. Newspapers do a very bad job of it. They agree that type, even in narrow columns, has to be justified. The result is words and lines that are erratically letterspaced. Readers have become used to that style (or rather, lack of it); loose and tight lines of type, one after another, don't seem to upset anyone.

In other surroundings, however, lines that look a little lighter and then a little darker because no one has adjusted the spacing might make the reader think there is some purpose behind this arrangement: are the loose lines more important than the tight ones?

Again, and there is no guarantee this is the last time: every time you change one spacing parameter, you have to look closely at all the others and adjust them accordingly.



There are situations, and this really is the final car picture, in which normal rules don't apply. Space becomes a rare commodity indeed when thousands of people are trying to get to the same place at the same time. Some pages are just like a downtown traffic jam: too many messages, too many directions, and too much noise. One thing typography can do, however, that city planning cannot: we can make all of our vehicles different sizes, move them up and down, overlap them, put them into the background, or turn them sideways. A page like this looks better than your typical downtown gridlock.

Tracking for this page is increased. A dark background recedes and makes type look tighter than dark type on a light background.

S p a c e



If time be of all things the most precious, wasting time must be the greatest prodigality; since lost time is never found again, and what we call time enough always proves little enough. Let us then be up and doing, and doing to a purpose, so by diligence we should do more with less perplexity. Sloth makes all things difficult, but industry all things easy. He that riseth late must trot all day and shall scarce overtake the business at night; while laziness travels so slowly that poverty soon overtakes him. Sloth, like rust, consumes faster than labor wears, while the used key is always bright.

If time be of all things the most precious, wasting time must be the greatest prodigality; since lost time is never found again, and what we call time enough always proves little enough. Let us then be up and doing, and doing to a purpose, so by diligence we should do more with less perplexity. Sloth makes all things difficult, but industry all things easy. He that riseth late must trot all day and shall scarce overtake the business at night; while laziness travels so slowly that poverty soon overtakes him. Sloth, like rust, consumes faster than labor wears, while the used key is always bright.

If time be of all things the most precious, wasting time must be the greatest prodigality; since lost time is never found again, and what we call time enough always proves little enough. Let us then be up and doing, and doing to a purpose, so by diligence we should do more with less perplexity. Sloth makes all things difficult, but industry all things easy. He that riseth late must trot all day and shall scarce overtake the business at night; while laziness travels so slowly that poverty soon overtakes him. Sloth, like rust, consumes faster than labor wears, while the used key is always bright.

If time be of all things the most precious, wasting time must be the greatest prodigality; since lost time is never found again, and what we call time enough always proves little enough. Let us then be up and doing, and doing to a purpose, so by diligence we should do more with less perplexity. Sloth makes all things difficult, but industry all things easy. He that riseth late must trot all day and shall scarce overtake the business at night; while laziness travels so slowly that poverty soon overtakes him. Sloth, like rust, consumes faster than labor wears, while the used key is always bright.

This copy is set to the same specifications as the second example on page 153, but reversed out.

In reversed-out settings, the spaces between letters look smaller, because they are dark. This text is set with the letterspacing (tracking) more open than in the example above.

White type looks heavier than black type (dark color recedes, bright colors come forward), so we used a lighter optical weight of Minion.

Often the problem is not that white type looks too heavy, but that the ink-spread from the printing process fills in the open spaces in and around letters. We have chosen a smaller optical size of Minion to make it a little sturdier.

1 If time be of all things the most precious, wasting time must be the greatest prodigality; since lost time is never found again, and what we call time enough always proves little enough. Let us then be up and doing, and doing to a purpose, so by diligence we should do more with less perplexity. Sloth makes all things difficult, but industry all things easy. He that riseth late must trot all day and shall scarce overtake the business at night; while laziness travels so slowly that poverty soon overtakes him. Sloth, like rust, consumes faster than labor wears, while the used key is always bright.

Remember: the more letters contained in a line, the more space that's needed between words and lines.

4 If time be of all things the most precious, wasting time must be the greatest prodigality; since lost time is never found again, and what we call time enough always proves little enough. Let us then be up and doing, and doing to a purpose, so by diligence we should do more with less perplexity. Sloth makes all things difficult, but industry all things easy. He that riseth late must trot all day and shall scarce overtake the business at night; while laziness travels so slowly that poverty soon overtakes him. Sloth, like rust, consumes faster than labor wears, while the used key is always bright.

2 If time be of all things the most precious, wasting time must be the greatest prodigality; since lost time is never found again, and what we call time enough always proves little enough. Let us then be up and doing, and doing to a purpose, so by diligence we should do more with less perplexity. Sloth makes all things difficult, but industry all things easy. He that riseth late must trot all day and shall scarce overtake the business at night; while laziness travels so slowly that poverty soon overtakes him. Sloth, like rust, consumes faster than labor wears, while the used key is always bright.

3 If time be of all things the most precious, wasting time must be the greatest prodigality; since lost time is never found again, and what we call time enough always proves little enough. Let us then be up and doing, and doing to a purpose, so by diligence we should do more with less perplexity. Sloth makes all things difficult, but industry all things easy. He that riseth late must trot all day and shall scarce overtake the business at night; while laziness travels so slowly that poverty soon overtakes him. Sloth, like rust, consumes faster than labor wears, while the used key is always bright.

For comparison among the various settings, the horizontal and vertical scales are broken down into millimeter units.

The first example has approximately 5 words (25+ characters) per line and is set in 8-point type with 9-point line space (set 8 on 9); word spaces are very small and tracking is 5 units. The second example accommodates

8 words (45 characters) per line, is set 8 on 10; word spaces are 10 percent wider and tracking is 10. The third block of text is set 8 on 11, with about 11 words (60 characters) to a line; the word space is opened another 10

units, and the tracking is a little tighter. The fourth text block is set 8 on 12, and with 15 words (90 characters) per line, which is almost too wide. The word spaces are now at the default value, with a little more tracking.

GERARD UNGER

The chief elements of style are the product not merely of the country, region or city in which the designer happens to live, they are also molded by his own personal qualities and the age in which he works.

(1942–2018) was a Dutch graphic and type designer and author. As visiting professor at the University of Reading he mentored many young typeface designers. His book, *While You're Reading*, appeared in many languages. *Gulliver*, designed for newspapers, is familiar to millions of readers, as are his typefaces for the Dutch highways and for the Amsterdam metro. *Demos* and *Praxis* (1976) were among the very first digital typefaces. Unger's *Theory of Type Design* was published in 2018. **Swift**

CHAPTER 8

Putting it to work.

FF Real Head Medium

THE BED IS ONE piece of furniture that has escaped most design trends. Mattresses have changed and so has the technology of making bed frames, but the way we sleep is still the same and the basic bedroom looks just as it has for centuries.

Bedrooms and books have one thing in common: an essentially single purpose. Reading, like sleeping, hasn't changed much in several hundred years, although we now have reading glasses, electrically operated headrests, and little lamps that clip right onto our books.

It may be said that the forerunner of what we consider coffee table books existed in the early days of printing, showing small illustrations positioned in a narrow marginal column next to the main body of text. Paperbacks crammed full of poorly spaced type with narrow page margins are an unfortunate and fairly recent innovation. But the intimate process of reading a book remains largely unchanged, as does the look of books.

Common to every book design is the underlying grid that divides the page into areas that serve different purposes – columns of text, marginal comments, headlines, footnotes, captions, illustrations. The more complex the structure of the text, the more possibilities for the arrangement of elements supported by this grid. Linear reading (as in a novel) usually just needs a straightforward, single-column layout, for which there are plenty of successful historical precedents.

The size of a book is crucial, but it is often determined by technical or marketing constraints. Books for serious reading should fit in our hands; it is preferable, then, to have a narrow format with wide margins that allow room for fingers to hold the book.

The column width (i.e., the length of a line of type) is governed by the width of the page, the size of type, and the number of words or characters per line. One or more of these variables is usually given, or is unavoidable, simplifying the other design decisions.

Type for extended reading in print should be no smaller than 9 point and no larger than 14 point. Point size is a fairly arbitrary measurement (see page 57), so these suggestions are valid only for “normal” book typefaces – types with a very pronounced or very small x-height need to be carefully evaluated.

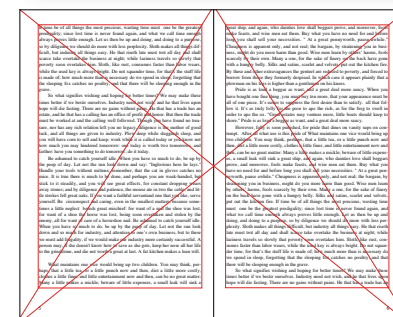
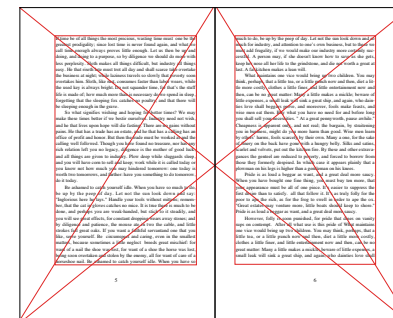

The arrangements or layouts of our living-rooms still follow the same model they did generations ago. There is usually a comfortable chair or two, perhaps a sofa to accommodate more than one person, a table, a bookshelf, some lights. The only recent addition to this harmonious ensemble has been the television set, which took over the center of attention from the hearth.

Living rooms, as opposed to bedrooms, serve a multitude of functions. Families sit together, and when they're not all staring in the same direction watching TV, they might actually play games at the table, eat dinner (not all staring in the same direction), or even pursue other interests such as reading, conversing, or staring at their small screens.

Certain types of books are used the same way: you can read, browse, look at pictures, or even check on something of particular interest. Pages offer various levels of entry for readers, viewers, and occasional browsers. These books will have to look different than our time-honored tomes of linear reading, just as living rooms look different than bedrooms.

Some books look like catalogs, some like magazines. Some have the structure of a typical novel, but with illustrations, either integrated into the text or on separate pages. The reader is likely to peruse this sort of book in a more casual fashion, so the designer needs to provide several levels of distinct typographic elements to act as guides through text and images.

If it has to be larger to accommodate pictures, or to provide room for text set in multiple columns, a book most likely will have to be set down on a table to be studied rather than read. This means that the margins can be smaller (no room needed for fingers to hold it) and that pictures can even extend to the edges of pages.

While books with only one level of copy usually need only one typeface in one size plus italic and small caps, more specialized books (such as this one) have to distinguish among the main text and other elements. This could mean a pronounced difference in type size; or perhaps another typeface with contrasting design or weight, or another color. In this book, we've employed several of these devices at the same time.

If the contents, the illustrations, and the amount of copy vary from page to page, a flexible grid is needed. The one in this book allows for many different column widths, captions, and sidebars. These elements shouldn't be changed randomly on every other page, but when they do have to be adapted to varying contents, the underlying grid structure serves as a common denominator.

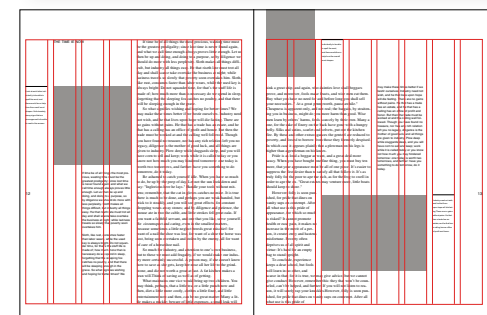
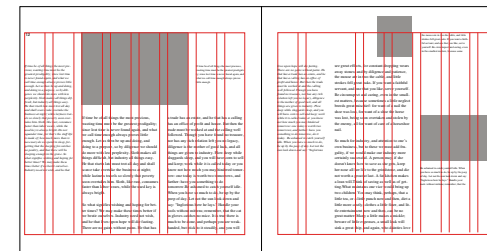



Hotel lobbies are institutional living rooms. Guests and visitors spend time there doing what they might do at home, but in the company of strangers. The dress has to be more formal and one's attention is more likely to be distracted by the things going on, and the general level of activity should rule out listening to one's personal choice of music. There is still the opportunity, however, for all to sit staring in the same direction, watchin a giant screen. Some people manage to read real books in quasi-public places like hotel lobbies, but most spend their time there waiting for someone or something, so they are only able to read magazines (small screens notwithstanding). Magazine pages are designed for the casual reader: there are snippets of information or gossip (or one dressed up as the other), headlines, captions, and other graphical signposts pointing toward various tidbits of copy.

As advertisements change their look according to the latest cognitive fashion, editorial pages tend to either look trendier, or to deliberately stay sober, bookish and authoritative.

Most magazines are printed in standard sizes; in the USA this means they're close to 8 1/2 by 11 inches. A line of type needs to be at least six words (between 35 and 40 characters) long, so the type ought to be about 10 point to arrive at a column width of 55 to 60 mm, or 2 1/4 to 2 3/8 inches. Three of these columns fit onto the page, leaving acceptable margins. The three-column grid is thus the basis for most publications printed on A4 = 210 x 297 mm. 8 1/2 x 11 inches = 216 x 279 mm.

To allow for other elements besides the main text columns, these measurements have to be divided again. Captions can be set in smaller type and in very short lines, so they might fit into half a basic column, making it a six-unit grid.

A good way to make these grids more flexible and spontaneous is to leave one wide margin that would only occasionally be filled with type. This grid would then have an odd number of units, say seven or even thirteen. The more complex the contents, the more supple the grid has to be, allowing for different stories in different-size types to occupy different widths.

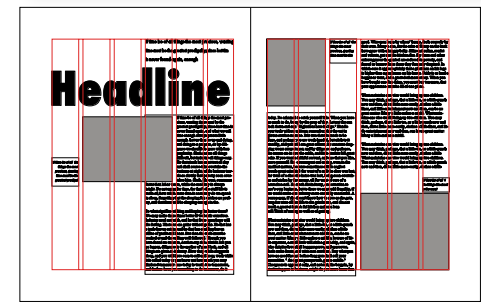
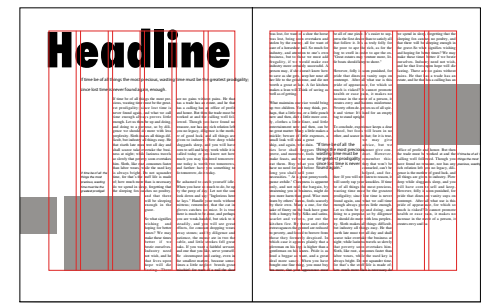



Kitchens are rooms with a clearly defined purpose: the storage, preparation, and often consumption of food and beverages. The equipment for these activities has changed considerably over the years and one could list numerous parallels to the development of typesetting systems over the same time span. The basic purpose has remained unchanged in both cases, whether it concerns food or type.

In a kitchen there are different surfaces for particular tasks, and containers and shelves for food, tools, dishes, pots, and pans. Graphic designers and typographers call the containers columns or picture boxes, the food is the text, the surface the page, and the tools are the typographic parameters needed to prepare an interesting page for the reader who has to digest it all.

Each recipe in a cookbook usually has explanatory text, a list of ingredients, and a step-by-step guide. It is sometimes illustrated either with small photographs or drawings. This sort of structure applies to any how-to publication, whether it's for car mechanics or landscapers.

People read cookbooks and other how-to manuals in situations that are often less than ideal. A cookbook has to compete for tabletop space with food, knives, towels, and bowls, and there is never enough time to read anything carefully. The text has to be read while standing, which means the type should be larger than usual. The recipe steps have to be clearly labeled with short headlines; ingredients and measurements should be in lists that can be referred to at a glance.

One of the best – or worst – examples of badly designed information is found in instructions for mounting snow chains onto the wheels of your car. This operation is usually done in the dark when you're wet, in a hurry, and uncomfortably cold. The instructions are often printed on white paper, which invariably gets wet and dirty before you've finished the job.

The typographic solution is to print them on the outside of the package, which should be made of some water-resistant material. The best color combination would be black type on a yellow background, which wouldn't show dirt as much as white. Type should be big and strong so it's legible no matter what. The text should be set in short, simple words and sentences.

As we've since learned, all these rules equally apply to pages on hand-held devices, with type being crisp, but even smaller.

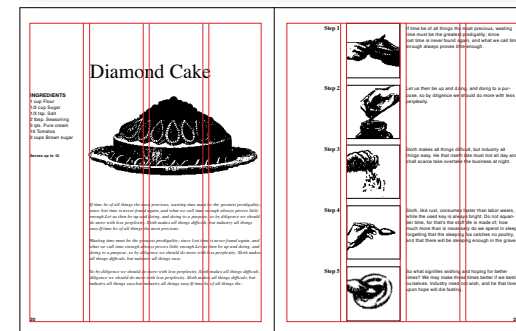
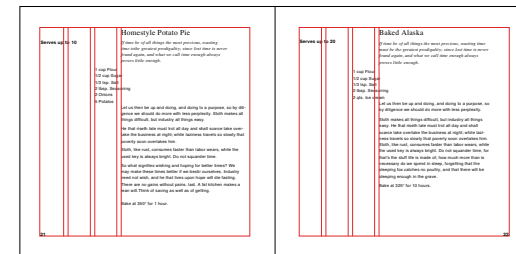



We spend much of our time outside our homes in places where our priorities are defined by other people. This is the case in most public places and, unfortunately, at work. Many people still have to work in conditions very much like this typing pool of the 1940s, even though it would be easy to improve the environment and thus the quality of work.

The same goes for much typographic work. There is no reason for hardworking pieces like price lists, technical catalogs, timetables, and similar heavy-duty information to look as ugly or complicated as they often do, whether on paper or on computer screens. If something looks dull, repetitive, and off-putting, people will approach it with a negative attitude (if they approach it at all). This does not improve their willingness to absorb the information.

Computers are a huge improvement over mechanical typewriters, and the output of laser printers certainly looks much better than anything that ever came out of a typewriter. To create good visual communication, however, takes much more than good tools. Whenever you come across those official looking, unreadable pieces, don't blame it on the equipment.

Complex information, such as price lists and timetables, cannot be designed on a preconceived grid. The page arrangement has to stem from the content and structure of the information itself. First you have to find the shortest and the longest elements, and then ignore them; if your layout accommodates the extremes you will end up making allowances for a few isolated exceptions. The thing to do is to make the bulk of the matter fit, then go back to the exceptions and work with them one by one. If there are only a few long lines in an otherwise short listing, it should be considered an opportunity to flex your creative muscles: design around them or rewrite.

A sure way to improve the look and function of any information-intensive document is to eliminate boxes. Vertical lines are almost always unnecessary. Type creates its own vertical divisions along the left-hand edges of columns as long as there is sufficient space between columns. A vertical line is wasteful because it needs precious space on either side. Use space to divide elements from each other. Utilize horizontal lines to accentuate areas of the page. The edge of the paper or screen makes its own box and doesn't require more boxes inside it.

FTB 8494/5/6/7 Series Attenuators

Ordering Information

FTB 355 Series, 8494/5/6/7 Series Specifications

FTB Model (Manual/Programmable)	Frequency Range (GHz)	Incremental Attenuation (dB)	SNR (dB)	Insertion Loss (dB)	Attenuation Accuracy	Power Rating (W)	Size (mm)	Weight (g)	Connector	Price
350D (Manual)	dc to 1	0 to 12 1 dB steps	1.5	dc to 0.25 GHz: 1.2 dc to 0.5 GHz: 1.5 dc to 1.0 GHz: 1.5	±0.1 dB ±0.25 dB ±0.35 dB	15 to 18 W per section	61 mm H × 70 mm W × 152 mm D (2.4 in × 2.75 in × 6 in)	1.4 kg (3 lb)	NCP (H) See Note 1	\$1,095
350E (Programmable)	dc to 1	0 to 12 1 dB steps	1.5	dc to 0.25 GHz: 1.2 dc to 0.5 GHz: 1.5 dc to 1.0 GHz: 1.5	±0.1 dB ±0.25 dB ±0.35 dB	15 to 18 W per section	61 mm H × 70 mm W × 152 mm D (2.4 in × 2.75 in × 6 in)	1.4 kg (3 lb)	NCP (H) See Note 1	\$1,095
350F (Manual)	dc to 18	0 to 11 1 dB steps	1.5	dc to 0.5 GHz: 1.5 dc to 1.0 GHz: 1.5 dc to 1.8 GHz: 1.5	±0.2 dB ±0.3 dB ±0.4 dB	15 to 18 W per section	67 mm H × 70 mm W × 152 mm D (2.6 in × 2.75 in × 6 in)	1.4 kg (3 lb)	NCP (H) See Note 1	\$1,095
350G (Programmable)	dc to 18	0 to 11 1 dB steps	1.5	dc to 0.5 GHz: 1.5 dc to 1.0 GHz: 1.5 dc to 1.8 GHz: 1.5	±0.2 dB ±0.3 dB ±0.4 dB	15 to 18 W per section	67 mm H × 70 mm W × 152 mm D (2.6 in × 2.75 in × 6 in)	1.4 kg (3 lb)	NCP (H) See Note 1	\$1,095
350H (Manual)	dc to 4	0 to 10 1 dB steps	1.35	dc to 0.25 GHz: 1.2 dc to 0.5 GHz: 1.5 dc to 1.0 GHz: 1.5	±0.1 dB ±0.25 dB ±0.35 dB	15 to 18 W per section	61 mm H × 70 mm W × 152 mm D (2.4 in × 2.75 in × 6 in)	1.4 kg (3 lb)	NCP (H) See Note 1	\$1,095
350I (Programmable)	dc to 4	0 to 10 1 dB steps	1.35	dc to 0.25 GHz: 1.2 dc to 0.5 GHz: 1.5 dc to 1.0 GHz: 1.5	±0.1 dB ±0.25 dB ±0.35 dB	15 to 18 W per section	61 mm H × 70 mm W × 152 mm D (2.4 in × 2.75 in × 6 in)	1.4 kg (3 lb)	NCP (H) See Note 1	\$1,095
350J (Manual)	dc to 18	0 to 11 1 dB steps	1.5	dc to 0.5 GHz: 1.5 dc to 1.0 GHz: 1.5 dc to 1.8 GHz: 1.5	±0.2 dB ±0.3 dB ±0.4 dB	15 to 18 W per section	67 mm H × 70 mm W × 152 mm D (2.6 in × 2.75 in × 6 in)	1.4 kg (3 lb)	NCP (H) See Note 1	\$1,095
350K (Programmable)	dc to 18	0 to 11 1 dB steps	1.5	dc to 0.5 GHz: 1.5 dc to 1.0 GHz: 1.5 dc to 1.8 GHz: 1.5	±0.2 dB ±0.3 dB ±0.4 dB	15 to 18 W per section	67 mm H × 70 mm W × 152 mm D (2.6 in × 2.75 in × 6 in)	1.4 kg (3 lb)	NCP (H) See Note 1	\$1,095
350L (Manual)	dc to 4	0 to 10 1 dB steps	1.35	dc to 0.25 GHz: 1.2 dc to 0.5 GHz: 1.5 dc to 1.0 GHz: 1.5	±0.1 dB ±0.25 dB ±0.35 dB	15 to 18 W per section	61 mm H × 70 mm W × 152 mm D (2.4 in × 2.75 in × 6 in)	1.4 kg (3 lb)	NCP (H) See Note 1	\$1,095
350M (Programmable)	dc to 4	0 to 10 1 dB steps	1.35	dc to 0.25 GHz: 1.2 dc to 0.5 GHz: 1.5 dc to 1.0 GHz: 1.5	±0.1 dB ±0.25 dB ±0.35 dB	15 to 18 W per section	61 mm H × 70 mm W × 152 mm D (2.4 in × 2.75 in × 6 in)	1.4 kg (3 lb)	NCP (H) See Note 1	\$1,095
350N (Manual)	dc to 18	0 to 11 1 dB steps	1.5	dc to 0.5 GHz: 1.5 dc to 1.0 GHz: 1.5 dc to 1.8 GHz: 1.5	±0.2 dB ±0.3 dB ±0.4 dB	15 to 18 W per section	67 mm H × 70 mm W × 152 mm D (2.6 in × 2.75 in × 6 in)	1.4 kg (3 lb)	NCP (H) See Note 1	\$1,095
350O (Programmable)	dc to 18	0 to 11 1 dB steps	1.5	dc to 0.5 GHz: 1.5 dc to 1.0 GHz: 1.5 dc to 1.8 GHz: 1.5	±0.2 dB ±0.3 dB ±0.4 dB	15 to 18 W per section	67 mm H × 70 mm W × 152 mm D (2.6 in × 2.75 in × 6 in)	1.4 kg (3 lb)	NCP (H) See Note 1	\$1,095
350P (Manual)	dc to 4	0 to 10 1 dB steps	1.35	dc to 0.25 GHz: 1.2 dc to 0.5 GHz: 1.5 dc to 1.0 GHz: 1.5	±0.1 dB ±0.25 dB ±0.35 dB	15 to 18 W per section	61 mm H × 70 mm W × 152 mm D (2.4 in × 2.75 in × 6 in)	1.4 kg (3 lb)	NCP (H) See Note 1	\$1,095
350Q (Programmable)	dc to 4	0 to 10 1 dB steps	1.35	dc to 0.25 GHz: 1.2 dc to 0.5 GHz: 1.5 dc to 1.0 GHz: 1.5	±0.1 dB ±0.25 dB ±0.35 dB	15 to 18 W per section	61 mm H × 70 mm W × 152 mm D (2.4 in × 2.75 in × 6 in)	1.4 kg (3 lb)	NCP (H) See Note 1	\$1,095

FTB 8494/5/6/7 Series Attenuators

Ordering Information

FTB 355 Series, 8494/5/6/7 Series Specifications

FTB Model (Manual/Programmable)	Frequency Range (GHz)	Incremental Attenuation (dB)	SNR (dB)	Insertion Loss (dB)	Attenuation Accuracy	Power Rating (W)	Size (mm)	Weight (g)	Connector	Price
8494 (Manual)	dc to 1	0 to 12 1 dB steps	1.5	dc to 0.25 GHz: 1.2 dc to 0.5 GHz: 1.5 dc to 1.0 GHz: 1.5	±0.1 dB ±0.25 dB ±0.35 dB	15 to 18 W per section	61 mm H × 70 mm W × 152 mm D (2.4 in × 2.75 in × 6 in)	1.4 kg (3 lb)	NCP (H) See Note 1	\$1,095
8495 (Programmable)	dc to 1	0 to 12 1 dB steps	1.5	dc to 0.25 GHz: 1.2 dc to 0.5 GHz: 1.5 dc to 1.0 GHz: 1.5	±0.1 dB ±0.25 dB ±0.35 dB	15 to 18 W per section	61 mm H × 70 mm W × 152 mm D (2.4 in × 2.75 in × 6 in)	1.4 kg (3 lb)	NCP (H) See Note 1	\$1,095
8496 (Manual)	dc to 18	0 to 11 1 dB steps	1.5	dc to 0.5 GHz: 1.5 dc to 1.0 GHz: 1.5 dc to 1.8 GHz: 1.5	±0.2 dB ±0.3 dB ±0.4 dB	15 to 18 W per section	67 mm H × 70 mm W × 152 mm D (2.6 in × 2.75 in × 6 in)	1.4 kg (3 lb)	NCP (H) See Note 1	\$1,095
8497 (Programmable)	dc to 18	0 to 11 1 dB steps	1.5	dc to 0.5 GHz: 1.5 dc to 1.0 GHz: 1.5 dc to 1.8 GHz: 1.5	±0.2 dB ±0.3 dB ±0.4 dB	15 to 18 W per section	67 mm H × 70 mm W × 152 mm D (2.6 in × 2.75 in × 6 in)	1.4 kg (3 lb)	NCP (H) See Note 1	\$1,095
8498 (Manual)	dc to 4	0 to 10 1 dB steps	1.35	dc to 0.25 GHz: 1.2 dc to 0.5 GHz: 1.5 dc to 1.0 GHz: 1.5	±0.1 dB ±0.25 dB ±0.35 dB	15 to 18 W per section	61 mm H × 70 mm W × 152 mm D (2.4 in × 2.75 in × 6 in)	1.4 kg (3 lb)	NCP (H) See Note 1	\$1,095
8499 (Programmable)	dc to 4	0 to 10 1 dB steps	1.35	dc to 0.25 GHz: 1.2 dc to 0.5 GHz: 1.5 dc to 1.0 GHz: 1.5	±0.1 dB ±0.25 dB ±0.35 dB	15 to 18 W per section	61 mm H × 70 mm W × 152 mm D (2.4 in × 2.75 in × 6 in)	1.4 kg (3 lb)	NCP (H) See Note 1	\$1,095
849A (Manual)	dc to 18	0 to 11 1 dB steps	1.5	dc to 0.5 GHz: 1.5 dc to 1.0 GHz: 1.5 dc to 1.8 GHz: 1.5	±0.2 dB ±0.3 dB ±0.4 dB	15 to 18 W per section	67 mm H × 70 mm W × 152 mm D (2.6 in × 2.75 in × 6 in)	1.4 kg (3 lb)	NCP (H) See Note 1	\$1,095
849B (Programmable)	dc to 18	0 to 11 1 dB steps	1.5	dc to 0.5 GHz: 1.5 dc to 1.0 GHz: 1.5 dc to 1.8 GHz: 1.5	±0.2 dB ±0.3 dB ±0.4 dB	15 to 18 W per section	67 mm H × 70 mm W × 152 mm D (2.6 in × 2.75 in × 6 in)	1.4 kg (3 lb)	NCP (H) See Note 1	\$1,095
849C (Manual)	dc to 4	0 to 10 1 dB steps	1.35	dc to 0.25 GHz: 1.2 dc to 0.5 GHz: 1.5 dc to 1.0 GHz: 1.5	±0.1 dB ±0.25 dB ±0.35 dB	15 to 18 W per section	61 mm H × 70 mm W × 152 mm D (2.4 in × 2.75 in × 6 in)	1.4 kg (3 lb)	NCP (H) See Note 1	\$1,095
849D (Programmable)	dc to 4	0 to 10 1 dB steps	1.35	dc to 0.25 GHz: 1.2 dc to 0.5 GHz: 1.5 dc to 1.0 GHz: 1.5	±0.1 dB ±0.25 dB ±0.35 dB	15 to 18 W per section	61 mm H × 70 mm W × 152 mm D (2.4 in × 2.75 in × 6 in)	1.4 kg (3 lb)	NCP (H) See Note 1	\$1,095

Microwave test Accessories



A business that wants to attract good people and keep them motivated will have to indulge them a little. Talking to each other may be more important than counting key strokes. Relaxed work spaces, flexible hours and flat hierarchies are all signs of a culture that judges people by their work and not by their strict compliance with corporate rules. If a firm still uses forms with lots of little boxes and redundant lines, it probably also keeps its employees in small cubicles.

The typing pool is as old fashioned as boxes on forms. Today's "information" workers still sit at a desk and type on keyboards, but they are allowed to move around, talk to other workers, get drinks, and actually exchange information with each other. Even the office cubicle, which was the successor to the typing pool, seems on its way out. And more liberal attitudes in our work space tend to show up in our design tastes.

Many menial tasks, such as typing the same information again and again, are done via the "copy and paste" command, and programs need just one keystroke to call up previously stored information about your address and credit card numbers. The biggest problem now is to remember all your passwords without writing them down on a sticky note and displaying that on your computer screen for everyone to see.

Web pages will look very different on the user's desktop than they look on the designer's screen unless they conform to some widespread, and therefore sometimes bland, standards. A lot of websites still display Arial, Verdana and Times, certainly at text sizes. You can, however, at least define which fonts your browser will use to fill in the fields with your personal information.

For some very old and boring reasons, monitors driven by PCs use a different PPI (Pixels Per Inch) standard than Macs. So type on a PC won't look the same size as it will on a Macintosh. With today's high resolution screens, that doesn't matter very much anymore - it is just a small nuisance if you use different platforms for the same documents. Web designers code CSS (Cascading Style Sheets) to make sure that users see the same layout - if not at the exact same apparent size - in their browsers, irrespective of the platform.

If that is not the case, designers didn't do their job properly or you use a very old browser.

Identifier	Data	Description/Comments
First Name	<input type="text"/>	
Last Name	<input type="text"/>	
E-Mail	<input type="text"/>	
Tel	<input type="text"/>	
Fax	<input type="text"/>	
Company	<input type="text"/>	
Logit	<input type="text"/>	
Pa	<input type="text"/>	
Pa	<input type="text"/>	
Re-Identif	<input type="text"/>	

Billing Information	Use of Personal Information
<p>Please fill out the order to complete your information, you agree Limited ("Adobe") or for such purpose.</p>	<p><input type="checkbox"/> I would like to receive information and special promotions on Adobe products and services. Adobe - Create an account</p>

My Adobe account

Use your Adobe ID to download free trials, buy products, manage orders, and access online services such as Adobe Creative Cloud and Acrobat.com. Plus, be a part of the thriving Adobe online community.

Create an Adobe ID

[I already have an Adobe ID](#)

Adobe ID (Email Address)

Password

Retype Password

First Name

Last Name

Country/Region
United States

Stay informed via email about Adobe products and services. [Learn more.](#)
 I have read and agree to the Adobe [Terms of Use](#) and [Privacy Policy](#).

Quantity B	1.800	600	600	1.200	1.7										
Quantity C	400	6.000	2.000	2.200	1.0										
Quantity D	1.000	700	500	500	800										
Quantity E	7236	4437	98	75986	1.900	2.1									
7675	7887	1256t	38473	00276	004732	57549	887542	51864	982392	34675	369234	7675	765765	1675	765765
Office Supplies	3000	250	250	250	250	250	250	250	250	250	250	250	250	250	250
Journals	100	100	100	100	100	100	100	100	100	100	100	100	100	100	100
Legal and Accounting	5000	350	350	350	350	350	350	350	350	350	350	350	350	350	350
Bank Charges	50	50	50	50	50	50	50	50	50	50	50	50	50	50	50

Financial Statement		December 31, 2018	
Assets			
Current Assets			
Cash	1,000		
Accounts Receivable	3,000		
Notes Receivable	1,500		
Merchandise Inventory	40,000		
Office Supplies			
Store Supplies			
Prepaid Insurance			
Total Current Assets	46,500		
Plant Assets			
Land	5,000		
Buildings	76,000		
Less Accumulated			
Depreciation	3,000	73,000	
Store Equipment	20,000		

FINANCIAL STATEMENT			
	Salaries	Rent	Leasing
1	200	400	200
2	600	250	300
3	300	120	150
4	500	800	1200
5	600	950	300
6	300	400	450

FF UNIT

FINANCIAL STATEMENT	
December 31, 2019	
Assets	
Current Assets	
Cash	21,456
Accounts Receivable	33,789
Notes Receivable	31,012
Merchandise Inventory	240,234
Office Supplies	41,345
Store Supplies	52,678
Prepaid Insurance	323,567
Current Assets	446,890
Plant Assets	
Land	65,902
Buildings	76,123
Less Accumulated	345,567
Depreciation	73,234 273,456
Store Equipment	320,789
Less Accumulated	23,456

AXEL

FINANCIAL STATEMENT	
December 31, 2019	
Assets	
Current Assets	
Cash	21,456
Accounts Receivable	33,789
Notes Receivable	31,012
Merchandise Inventory	240,234
Office Supplies	41,345
Store Supplies	52,678
Prepaid Insurance	323,567
Current Assets	446,890
Plant Assets	
Land	65,902
Buildings	76,123
Less Accumulated	345,567
Depreciation	73,234 273,456
Store Equipment	320,789
Less Accumulated	23,456

ITC FRANKLIN GOTHIC CONDENSED

FINANCIAL STATEMENT	
December 31, 2019	
Assets	
Current Assets	
Cash	21,456
Accounts Receivable	33,789
Notes Receivable	31,012
Merchandise Inventory	240,234
Office Supplies	41,345
Store Supplies	52,678
Prepaid Insurance	323,567
Current Assets	446,890
Plant Assets	
Land	65,902
Buildings	76,123
Less Accumulated	345,567
Depreciation	73,234 273,456
Store Equipment	320,789
Less Accumulated	23,456

Spreadsheets - as the name implies - need plenty of space. If you set them in Courier, you will end up with type that is small and very easy to misread.

There are numerals that save space and that are still more legible than Helvetica or Times or those in your standard word-processor font. Figures in tables have to each be the same width or they will not line up properly in columns. Lining figures (numerals that don't have ascenders and descenders) are usually tabular, and so do a reasonable job in this situation; lining figures are standard in most modern digital fonts.

For maximum legibility with added space economy, look at narrower-than-normal typefaces like FF Unit, at condensed faces like ITC Franklin Gothic Condensed, or at faces designed for this purpose, like Axel. These types will set your spreadsheets apart from the norm: not only will they look better, but they will read better.

1234567890
ITC FRANKLIN GOTHIC CONDENSED
1234567890
UNIVERS 57
1234567890
MINION PRO MEDIUM CAPTION
1234567890
FRUTIGER CONDENSED
1234567890
FF INFO OFFICE
1234567890
AXEL
1234567890
ITC OFFICINA BOOK
1234567890
FF UNIT REGULAR LF

Our figures do not derive from the Romans but from Indian mathematicians and were then adopted in Persia and the Arab countries.

Identical twins look the same to everybody but their mother. Their differences are expressed more in their behavior than their looks. Distinct characters aren't always obvious at first glance.

That is why we now call them Arabic or Hindu numerals. We still use Roman numerals, but more for decorative purposes and mainly on movie posters and watch dials.

Numerals appear in different settings. In spreadsheets, they have to align underneath each other to form neat columns. They have to be easily distinguishable from each other and as large as space will permit. Within text, figures should be treated like words; they have descenders and ascenders like alphabetic characters and thus form an uneven outline like a word. That outline helps legibility (see page 107).

OpenType fonts allow for many features, which, in the case of figures, not only add esthetic pleasure but also improve function. Tables are set in tabular (!) figures: They all share the same width, as do other characters that are used in that context, for example currency symbols and en dashes. Hyphens, commas and decimal points should be a defined fraction of that figure space so tables line up vertically when all lines contain these characters as well as figures.

OpenType features provide at least four different set of figures.

Tabular lining, tabular oldstyle, proportional oldstyle, proportional lining. There are also properly designed numerators and denominators to set fractions (as opposed to figures automatically reduced to fraction size or just the figures for quarter, half and three quarters), specially designed figures for sub- and superscript, even figures to go with small caps, and there again lining or oldstyle. A slashed zero to distinguish that figure from an O or an o is also often present.

Proper Roman numerals should be set as small caps if within text, but not tracked as generously as SMALL CAPS within a line of characters, because they are not small caps, they just look like them.

Roman MDMLXXXIV

Roman MDMLXXXIV

- 1 proportional lining
- 2 proportional oldstyle
- 3 proportional small caps
- 4 tabular lining
- 5 tabular oldstyle
- 6 fractions numerators
- 7 fractions denominators
- 8 superiors
- 9 inferiors
- 10 bullets positive/negative

1 No 12345678900

2 No 1234567890

3 NO 1234567890

4 N^o 12345678900

5 N_o 12345678900

6 1/2 3/4 5/6 7/8 9/9

7 1/2 3/4 5/6 7/8 9/9

8 cm 1234567890

9 H₂O 34567890

10 ① ② ③ ④ ⑤ ⑥



PAUL KLEE

**APPEAR-
ANCES
ARE NOT
FALSE.**

(1879–1940) was a German-Swiss painter whose work was imaginative, meditative, fantastic and playful. He gave his works ironic, irreverent, flippant and poetic titles.

Alfarn

CHAPTER 9

**Type
on screen.**

FF Real Head Demi Bold

A manuscript by Albert Einstein. Gérard Lhéritier built a large rare books collection

Trickery in rare

PARIS
French dealer is accused of orchestrating a vast literary Ponzi scheme

BY DAVID SEGAL
A letter from Frida Kahlo, signed and twice kissed with red lipstick, fetched just over \$8,800. A page of scribbled calculations by Isaac Newton sold for about \$21,000. A 1953 handwritten speech by John F. Kennedy took in \$10,000.

“Adjugé!” said a gray-haired auctioneer, over and over, as he gavelled away nearly every one of the 200 lots for sale at Drouot, an auction house, in Paris in mid-November. The sale generated \$4.2 million, which might sound like a triumph.

Actually, the sale was a fiasco, or, more precisely, one part of an ongoing fiasco. All of the items came from a now-defunct company, Aristophil, which starting in 2002 built one of the largest collections of rare books, autographs and manuscripts in history — some 136,000 pieces in all.

The buying spree turned the company's founder and president, a stout 71-year-old named Gérard Lhéritier, into a



Mr. Lhéritier in was the victim

celebrity. H seum of Le pricey nei rounded naries. T dents, a crowned Today flatteri Franc

spotlight from cit



Rem Koolhaas said state-of-f



15:11 Sun 23, Feb

Live Nevada Results Latest Updates Precinc

More in U.S. News

Trump's Efforts to Remove the Disloyal Heightens Unease Across His Administration
Feb. 22
Doug Mills/The New York Times

Same Goal, Different Playbook: Why Russia Would Support Trump and Sanders
Feb. 22
Alexander Zemlianichenko/Pool, via Reuters

Russia Is Said to Be Interfering to Aid Sanders in Democratic Primaries
Feb. 21
Erin Schall/The New York Times

Lawmakers Are Warned That Russia Is Meddling to Re-elect Trump
Feb. 20
Emmanuel Dunand/Agence France Presse—Getty Images

In Case Green Card Sotomayor
Feb. 21

Editors' Picks

'It's Pretty Brutal': The Sandwich Generation Pays a Price
Feb. 11
Rosem Morton for The New York Times

What Happens When You Get Famous Off One Song?
Feb. 14
Alexander Coggin for The New York Times

In 6 Minutes, You Done With Your W
Feb. 18

Screens are not just new surfaces; they also require different layouts and ways to present content. Typography is the common denominator when moving a known brand across platforms. We recognize this newspaper even without the masthead.

As content on the web continues to move from the desktop to the mobile phone, tablet, and across social networks, web fonts can provide a consistent, branded experience no matter

where a user encounters content. Publishers get instant brand recognition, while users benefit from an elegant, crafted typographic experience: a win for all.

For quite a while now, web designers have no longer been reliant on the established system fonts such as Times and Arial, which are installed on all computers. Typographic emergency solutions using Flash or similar technology have pretty much become a thing of the past.

Web fonts are delivered in two formats: EOT (Embedded OpenType) and WOFF (Web Open Format Fonts). WOFF is a format specifically designed for web use with the @font-face declaration.

Web fonts are downloaded from a remote server and embedded using CSS and JavaScript. Fonts are “obfuscated” (packaged and hidden away), so they cannot be extracted and used for print. They require a special license. Companies like Adobe Fonts, Font Squirrel, Fontdeck, as well as the major foundries provide this service and convert fonts to the appropriate formats. License models vary too widely to be quoted in a book. The same goes for specific technical details, which are bound to be redundant by the time the ink on these pages is dry.

In order for the bitmap on screen to look like the image on the right, the actual outlines have to be distorted as shown here on the left. (Image courtesy of Petr van Blokland.)

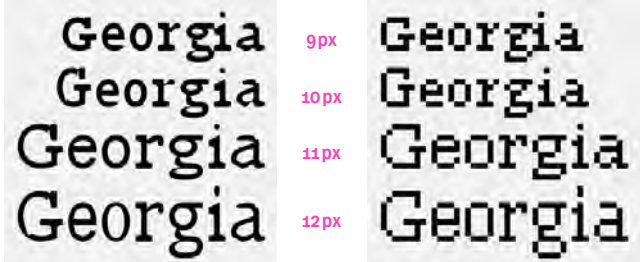

A technical standard is all very well, but it does not guarantee that the same typeface will appear the same across browsers or platforms. The dreaded term “hinting” appears elsewhere in this book when we talk about presenting letters on screen or other modest-resolution surfaces. No amount of bending Bézier curves around to fit into grids, however, will ever accommodate every render engine on every system. Web designers will have to live with the fact that type will look different in different environments, just as it has done for centuries as paper-making, printing, and typesetting technologies changed.

The illustration below shows how far the outlines of Georgia have to be changed in order to fit the grid at different sizes. And this is one of the most thoroughly hinted screen fonts in the world! Automatically converting print fonts into web fonts will not get those results. For type used bigger than 14 or so pixels that won't matter so much, but it does for smaller sizes. That is why good old Georgia still dominates the web when it comes to reading long text.

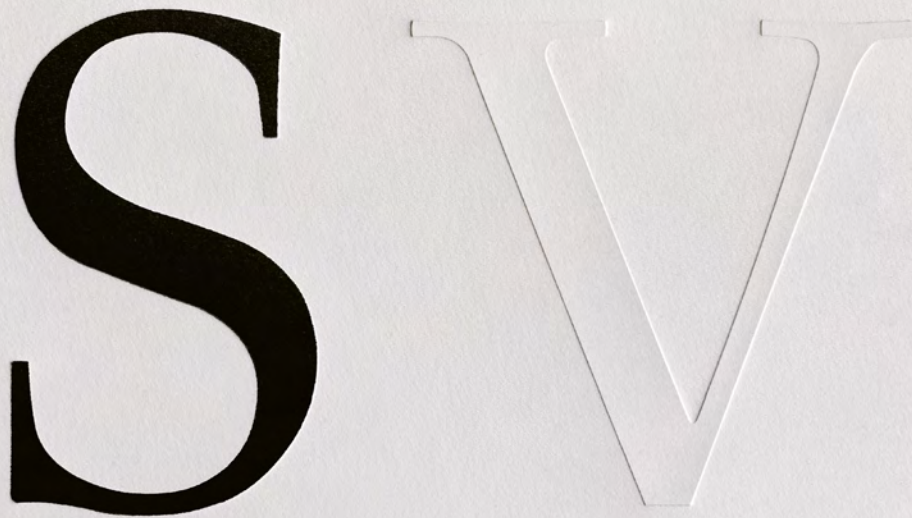

When Claude Garamond cut the punches for his typefaces back around 1530, he knew what the local printers in Paris needed. They printed with wooden presses on handmade paper and had to manually ink every page for each pull of the press. Type had to be as small as possible: More pages meant more work and more expensive paper. A small book fits in the reader's hand, can be carried around, and doesn't waste space on the shelf.

Deep impression, ink smudges and the paper itself had to be taken into account when designing a typeface for print.

By the time Giambattista Bodoni cut his letters some 250 years later, presses were more sophisticated and paper was smoother. Printers could print finer lines and achieve better density on the page. Bodoni got away

with the extreme contrast between thins and thicks that make his typefaces so beautiful even today.

Early screens were today's equivalent of handmade paper and the render engines were the wooden printing presses. Screen resolution is much better now, but type is still made up of pixels, and the look of fonts across different screens and browsers is anything but constant. So when you pick a typeface for text in small sizes that is meant to be read on a screen, remember Garamond. Don't sacrifice esthetics for practicality. Pick a typeface that has character and strength. Basically, the models which survived 500 years will look good on screens today.

Typefaces with reduced contrast, stronger serifs (or without serifs), and a reasonably weight are well suited for small screens. No serifs doesn't mean geometric: One of the earliest system fonts, Lucida, has good contrast and is very legible. That is why Apple even reworked it for one of their operating systems, before they went back to cool but unpractical Helvetica. It took them a few more years to finally design their own system font, San Francisco, which is not exactly a beauty, but fit for the purpose.

Other system fonts have also been designed with the screen in mind, but following traditional models. We read best what we read most.

Source Sans by Paul D. Hunt is a useful and good-looking typeface released under the Open Font License (OFL), which allows the licensed fonts to be used, studied, modified, and redistributed freely, but not sold again.

Fira Sans and Fira Mono were designed for Firefox by Ralph Du Carrois and Erik Spiekermann and also released under the OFL. These typefaces are available for free, but that doesn't mean they're cheaply made. They were designed for screen but work equally well on paper.

Light
LightItalic
Regular
RegularItalic
Medium
MediumItalic
Bold
BoldItalic

FIRA SANS

Regular
Bold

FIRA MONO

Regular
Italic
Bold
Italic

LUCIDA

Regular
Italic
Demibold
Italic

LUCIDA SANS

Regular
Bold

LUCIDA TYPEWRITER

ExtraLight
ExtraLightItalic
Light
LightItalic
Regular
RegularItalic
Semibold
SemiboldItalic
Bold
BoldItalic

LUCIDA SANS

Black
BlackItalic

SOURCE SANS

Handgloves

FF TISA

Handgloves

FF META SERIF

Handgloves

PROXIMA SANS

These three faces were instant hits as webfonts, and for good reasons: they are sturdy but pleasant, useful but not over-used.

ANDREW S TANENBAUM

The good thing
about standards
is that there are
so many of them.

(*1944) Author of MINIX,
a free Unix-like operating system for teaching purposes,
and of computer science textbooks, regarded as standard
texts in the field. He operates *Electoral-vote.com*, a website
dedicated to analysis of polling data in federal elections in
the United States as well as the capabilities of Russian
hackers from St Petersburg altering the polling data.

Akzidenz Grotesk, also known as Standard

CHAPTER 10

Variable
fonts.

FF Real Head Bold

Fraunces

Roman & Italic
An “Old Style”
Typeface Family

Soft

Express Fraunces is a stylish and contemporary Old Style with a “Softness” axis to control the ‘wetness’ or ‘inkiness’ of the typeface. Although it is drawn entirely with rounded serifs, it achieves crispness in the “Sharp” area of the design space with extremely high contrast. See more at fraunces.undercase.xyz

Berlow

Roboto Flex Parametric

Finesse Roboto Flex is Font Bureau’s upgrade of Roboto, with optical sizing as its *tour de force*. Flex boasts a huge range of weights and widths at the larger size-specific designs, shown above in 36 point, 90% width, grade -60, weight 1000, and below in 30% width, grade +150 & 100 weight. It contains over a dozen other axes that form a system of fine-grain controls over every typography detail. Learn more at variablefonts.typenetwork.com. Google Fonts has published introductions to variable fonts at design.google/fonts, web.dev/variable-fonts and fonts.google.com/knowledge. They also commissioned Jason Pamental to create the open source variablefonts.io website as an in-depth “primer” that explains all the ins and outs of using variable fonts on the web. It has curated links to other useful and interesting stuff.

WHILE ANY TYPE technology can carry alternate glyph designs, a new kind of true fluidity is possible with digital type. This works through the process of interpolation – placing two or more designs along an “axis” and moving from one end to the other in a smooth, linear transition. In 2016 the OpenType font format – the one we’ve all been using for years – was finally updated with a radically new capability to customize your type: variable fonts.

Before variable fonts, a complete font family with many weights and widths could add up to over 200 files – bold in one file, light in another, condensed in another ... But

Variable jacket format: fits into a small pouch but packs a big punch when unfolded. Just like every imaginable variation of a typeface fits into one variable font file.

now with an OpenType variable font, a single file can contain the designs for an entire family. The type designer still decides which designs are available by drawing the minimum and maximum version of every axis. Some fonts might only have one axis, and some may have many more.

There are three main benefits to using variable fonts for designers: to compress, to express, and to finesse. Let’s review each one.

To compress: The more files we used before, the more a variable font-file upgrade can save in file size, from bytes on-disk to webpage loading latency. On the web we can use CSS to show the design anywhere along the allowable axis range, without any artificial distortion by the browser. The most common axes – width, weight, and optical size – can be set directly via common CSS properties like font-weight and font-size. So upgrading to a variable font can be straight-forward for web developers.

For desktop design apps, variable fonts contain “named instances,” which are aliases for styles that used to be in separate files. So whatever the typeface designer had in mind for “Bold Condensed” can be mapped to the appropriate points along the weight and width axes. This means upgrading to a variable font can be straight-forward for designers, too.

The text is based on Jason Pamental’s website Responsive Web Typography, rwt.io, and is used with permission.

It was edited by Dave Crossland from Google Fonts, who came up with the *compress/express/finesse* slogan after spending too much time with David Berlow.





	Recursive Mono				Recursive Sans			
	Casual		Linear		Casual		Linear	
	Normal	Italic	Normal	Italic	Normal	Italic	Normal	Italic
Light (300)	IW	<i>rw</i>	IW	<i>rw</i>	rw	<i>rw</i>	rw	<i>rw</i>
Regular (400)	IW	<i>rw</i>	IW	<i>rw</i>	rw	<i>rw</i>	rw	<i>rw</i>
Medium (500)	IW	<i>rw</i>	IW	<i>rw</i>	rw	<i>rw</i>	rw	<i>rw</i>
Semibold (600)	IW	<i>rw</i>	IW	<i>rw</i>	rw	<i>rw</i>	rw	<i>rw</i>
Bold (700)	IW	<i>rw</i>	IW	<i>rw</i>	rw	<i>rw</i>	rw	<i>rw</i>
ExtraBold (800)	IW	<i>rw</i>	IW	<i>rw</i>	rw	<i>rw</i>	rw	<i>rw</i>
Heavy (900)	IW	<i>rw</i>	IW	<i>rw</i>	rw	<i>rw</i>	rw	<i>rw</i>
ExtraBlack (1000)	IW	<i>rw</i>	IW	<i>rw</i>	rw	<i>rw</i>	rw	<i>rw</i>

Recursive is a five-axis variable font built to maximize versatility, control, and performance. You can choose from a wide range of predefined styles, or dial in exactly what you want for each of its axes: Weight, Slant, Monospace, Casual, and Cursive. Compressed in WOFF2 format ready for web use, the size of the variable font file for all of that is only 687KB, but the equivalent 64 files are over 7.2MB. Learn more at recursive.design

To express: While simply re-packing an existing typeface family into a different data format isn't super interesting for designers, this is a quantifiable benefit that can be exciting for engineers and executives. And even with only one axis for weight, the ability to dial in exactly how bold or light you want your text to be opens up powerful new possibilities. You can customize type to express your design better, but only within the range of options provided in the font.

Variable fonts aren't limited to offering customization in only width or weight – any aspect of the typeface can be made variable by the typeface designer. For example, in Recursive, the “Casual” axis allows the design to metamorphose, from rationalized and squared to brushy and flowing. Fraunces has a “Softness” axis to customize the design from the default “Soft” in the middle to “Sharp” or “Super-Soft”. But the axes can be anything! The typeface Climate Crisis has an axis that melts the Extra-Bold sans like arctic ice, with a range from 1979 to 2050.

Axes are usually manipulated expressively using a bank of sliders somewhere in your design tool's typography controls palette. Recent versions of Adobe Illustrator, Photoshop, and InDesign offer sliders, along with web/UI design applications like Sketch and the ever popular CoreDRAW. The Firefox web inspector has them built-in, too. Which design apps have what “VF” support is tracked by Nick Sherman at v-fonts.com/support.

If you have obtained a variable font file, go check out Roel Nieskens' WakamaiFondue.com (*What Can My Font Do ... get it?*). Simply drag and drop your font file as directed and you'll be able to see what features the font has, language support info, file size, its number of glyphs, and all of the variable axes that font supports with their default, min and max values. There's even a type tester and some sliders that let you play around with the different axes.

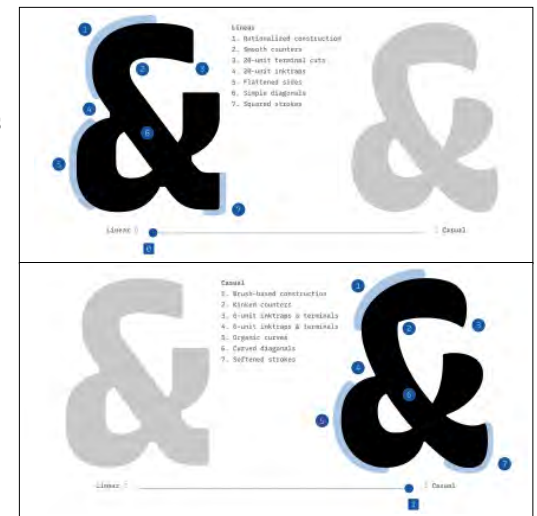

Recursive's expressive “Casual” axis. Many other examples of expressive variable fonts can be found on Laurence Penny's brilliant-axis-praxis.org and Nick Sherman's comprehensive v-fonts.com. Check out the sublime and the ridiculous, the practical and the outrageous.

Roboto Flex
Optical size 96pt
width 100, weight 150

Roboto Flex
Optical size 96pt
width 110, weight 250

Roboto Flex
Optical size 96pt
width 120, weight 350

Roboto Flex
Optical size 96pt
width 130, weight 450

Roboto Flex
Optical size 96pt
width 140, weight 550

Roboto Flex
Optical size 96pt
width 90, weight 650

Roboto Flex
Optical size 96pt
width 80, weight 750

Roboto Flex
Optical size 96pt
width 70, weight 850

Roboto Flex
Optical size 96pt
width 60, weight 950

Roboto Flex
Optical size 96pt
width 50, weight 850

Roboto Flex
Optical size 96pt
width 40, weight 750

Roboto Flex
Optical size 96pt
width 35, weight 650

Roboto Flex
Optical size 96pt
width 30, weight 550

Roboto Flex
Optical size 96pt
width 25, weight 450

Variable fonts.
Variable fonts.
Variable fonts.
Variable fonts.
Variable fonts.
Variable fonts.
Variable fonts.
Variable fonts.
Variable fonts.
Variable fonts.
Variable fonts.
Variable fonts.
Variable fonts.
Variable fonts.
Variable fonts.
Variable fonts.

To finesse: Perhaps the most powerful benefit of variable fonts is their ability to finesse text typography in subliminal ways – automatically. The best example of this today is “Optical Size,” an axis that provides styles for specific sizes that are accurate down to the unit of one point. A variable font with an optical size range from 10 to 60 has 50 subtly different styles, and that’s just for the regular-weight, normal-width Roman!

On the web, if an optical size axis exists in the font file, each appropriate style is automatically selected for headings, paragraphs, and captions by the typical font-size setting. This is thanks to the new CSS property “font-optical-sizing,” which has already shipped in all major browsers—and is on by default.

The Amstelvar and Roboto Flex typefaces from Type Network have pioneered applying optical size axis to a full set of weights and widths, from extremely light and narrow to extremely bold and wide, from eight up to 144 point. Another capability it has to finesse text is a complete range of “Grade” variation, throughout that entire design space. Grades adjust weight without any reflow.

These fonts also contain an additional set of so-called “Parametric” axes that relate to each other as a system that enables both visual designers and automated conditional rules to fine-tune typography. By specifying stem widths, counterform heights, and other details with a new level of precision, a new level of typographic control means Amstelvar and Roboto Flex can closely pair with other typefaces and graphical elements in layouts. Principal designer David Berlow has developed a brochure with with examples of parametric axes used to solve different problems at variablefonts.typenetwork.com.

The power to customize type through variation is now in the hands of everyone, thanks to variable fonts becoming standard on all major web and mobile platform – and more and more design applications, too. This new breed of fonts can be finely adjusted by eye or by automation – just once for a simple document, or many times per second for live interaction and animation.

The possibilities for the future of typography are endless! Use variable fonts to explore, to push design flexibility and boundaries even further – and save web bandwidth at the same time.

Amstel
Amstel
Amstel
Amstel
Amstel
Amstel
Amstel
Amstel
Amstel

Amstelvar, set in 30pt, weight 400, width 100, optical sizes 8/12/16/24/36/48/60/84/144. Every value is possible, you can set optical size to 19 or 99.99 if you must. As contrast increases, spacing gets tighter.

The Grade axis changes visual weight without changing spacing, so you can set lighter or heavier type without reflow. You can finesse different printing processes or papers, on hover or in dark mode.

Set in 11pt, weight 400, width 100, grade -300/-150/0/+150/+500.

Amstelvar has serifs
Amstelvar has serifs
Amstelvar has serifs
Amstelvar has serifs
Amstelvar has serifs

GROUCHO MARX

NOW THAT YOUR WIFE
HAS BOUGHT YOU
A NEW SUIT, I DON'T
MIND STARTING UP
A CORRESPONDENCE.

(1895–1977) was a member of the Marx Brothers, one of the funniest comedy teams in movie history. In films like *Horse Feathers* and *Duck Soup*, Groucho is perpetually punning while displaying a remarkable facility for the leering look.

LiebeDoris

CHAPTER 11

**There is no
bad type.**

FF Real Head Extra Bold



FROM MEDITERRANEAN MERCHANTS making notes on clay tablets, to Roman masons chiseling letters into stone, to medieval monks moving quills across parchment – the look of letters has always been influenced by the tools used to make them. Two hundred years ago copper-plate engraving changed the look of typefaces, as did all subsequent technologies: the pantograph, Monotype and Linotype machines, phototype-setting, digital bitmaps, and outline fonts.

Most of these technologies are no longer viable, but some of the designs they engendered now represent particular categories of typefaces. Once again, the best example is the typewriter. As an office machine it is all but dead, but its typeface style survives as a typographic stereotype. Other recognizable styles that have outlived their production methods are stenciled letters and constructed letters made with a square and compass.

Technical constraints no longer exist when it comes to the reproduction or re-creation of fonts from any and all periods. What used to be a necessity has become a look, just like prewashed jeans are supposed to make anybody look like a cowboy who’s been out on the trail for a few months.

Designers have always got good mileage out of the low-tech look. Theoretically, for example, almost every typeface could be stenciled; all it takes is a few lines to connect the inside shapes to the outside so the letters won’t fall apart when cut out of metal.

At almost the same time two designers had the clever idea of creating a stencil typeface for print. Stencil, designed by R. Hunter Middleton for Ludlow, was released in June of 1937; in July of that same year Stencil by Gerry Powell for ATF was debuted.

Today anybody can make a typeface from any original. Rubber stamps, tea-chests, old typewriters, and rusty signs have been used as inspiration and often even as original artwork. Scanners and digital cameras bring it to the desktop. Then it takes skill, talent and serendipitous timing to turn an idea into a successful font.

Just van Rossum and Erik van Blokland were the first type designers to get all the ingredients right when they grabbed everything looking like letters in their attic and scanned it. FF Karton, FF Confidential and FF Trixie don’t hide their simple analog heritage while being perfectly functional digital fonts.

A true trend came out of Berkeley, California. Zuzana Licko of Emigre Graphics was inspired by the primitive bitmap fonts generated by the first Macintosh computers. She designed her own types within those constraints. For technical reasons, some bitmaps are still with us, and these early designs show how stylish they could be.

In 1974, Joel Kaden and Tony Stan in New York realized that people wanted “honest” typewriter faces, but with all the benefits of “real” type. So they designed ITC American Typewriter, which answers those needs. It has all the ingredients of 1970s typographic fashion – large x-height, generous curves, no false modesty.

HANDGLOVES

STENCIL

HANDGLOVES

FF KARTON

HANDGLOVES

FF CONFIDENTIAL

Handgloves

FF STAMP GOTHIC

Handgloves

FF TRIXIE PRO LIGHT

Handgloves

EMIGRE TEN

Handgloves

OAKLAND EIGHT

Handgloves

EMPEROR TEN

Handgloves

ITC AMERICAN TYPEWRITER REGULAR

Handgloves

ITC AMERICAN TYPEWRITER BOLD

If a note is scribbled quickly, chances are the letter shapes in the words will be connected. Every stop, start, and pen lift of the writing hand slows down the process.

Neon signs and cursive fonts work hand in hand, so to speak. Neon tubes are filled with gas; the more interruptions there are in the continuous loop, the more expensive it is to make the sign. Signmakers therefore have to look for typefaces that connect as many letters as possible, or they must manipulate other types to accommodate the technical constraints.

The neon-sign style, in turn, influenced graphic design, and people have spent a lot of time airbrushing a glow of light around curved, tubular letters. Like other graphic manipulations, achieving neon effects has become much easier with drawing and painting programs available on the computer.

Signmakers working with neon take pride in their ability to select any old typeface and reproduce it with glass tubes. As neon messages are generally short, the signmaker will most likely take the entire word and make it into one shape. Even if inspiration comes from available type styles, the glass literally has to be bent and shaped to fit the design and technical requirements.

Since most signs are original designs, there hasn't been much call for real neon typefaces, although some fonts with glowing shadows and curvy shapes existed on transfer lettering. Some typefaces look as though they could be useful for neon signs. They have strokes of identical thickness throughout and no sharp angles or swelling of curves. Kaufmann fulfills these criteria and possesses some of that 1930s elegance.

Handgloves
KAUFMANN

Handgloves

This warm glow of the tube is created with the help of Adobe Photoshop.

Handgloves
FB NEON STREAM

Handgloves
HOUSE-A-RAMA LEAGUE NIGHT

Handgloves
LIEBE LOTTE

Handgloves
FB STREAMLINE

Handgloves
FB MAGNETO

MOTEL
Capri

CABLE TV
ELEVATOR

MOTEL



We associate particular typeface looks with certain products. Fresh produce always seems to want an improvised, handwritten sort of message, while high-tech applications demand a cool, technocratic look. Warm, cuddly products respond to a soft serif treatment, grainy whole foods are represented best by a handmade, rough-edged typeface, and serious money businesses always recall the era of copperplate engraving, when assets were embodied in elaborately printed certificates.

In some cases this makes perfect sense. In produce and meat markets, where prices change constantly, time and expense prevent shopkeepers from having new signs printed each day. The most common solution is to write them out by hand; however, if the proprietor has illegible handwriting, it would be a disservice to customers to present an up-to-date but unreadable sign. The shopkeeper can simply buy a casual script or a brush font and print the signs reversed out on the laser printer. They will look almost like genuine handwriting on a blackboard.

Which one of these signs would you trust?

FRESH EGGS

Flying lessons

Fresh eggs

Flying lessons

Advertising, especially in newspapers, has always tried to emulate the spontaneous style of small-time shopkeepers and their signwriters. There were plenty of brushstroke typefaces available in hot metal days, even though the immediacy of brushstrokes and the rigidity of metal letters seem to be a contradiction. Many brushstroke typefaces now exist in digital form.

The names signal their potential application or the writing tool: Reporter from 1938 is the rough, brush stroke; Felt Tips didn't exist then. Mistral, the most spontaneous design of all metal typefaces, has already been praised in this book (see page 49).

With a little determination and a lot of software savvy, all of us today could make type. Some of these homemade fonts, sold by independent digital foundries, have become very popular. Among them are FF Erikright-hand, by Erik van Blokland, and FF Justleft-hand by Just van Rossum, which began as practical jokes, and by now, after 30 years, have become classics of that genre.

Handgloves

LIEBE GERDA

Handgloves

REPORTER

Handgloves

MISTRAL

Handgloves

FELT TIP WOMAN

Handgloves

FF PROVIDENCE

Handgloves

FF ERIKRIGHTHAND

Handgloves

FF JUSTLEFTHAND



Every language has its vernacular. It is considered the dialect of a specific group of people rather than a language of wider communication. The vernacular also has many vocabularies: the images we share, the music we attribute to a certain period, the TV series we remember – even the architecture that surrounds us.

Typography also has its vernacular. Not the traditional typefaces, designed for reading books or magazines, brochures, or newspapers, but rather the stuff local printers would use on a letterhead or shopkeepers for flyers in their

The type on this wooden sign places it firmly in the American West of the 1800s, regardless when it was actually made.

windows. Movie titles used to be handmade and designed according to the subject matter or the fashion of the time.

We still recognize classic horror movies by their scraggy lettering, always with a dramatic drop shadow. We remember *Ben Hur* for the stacked title that looked like a colossal sculpture. Hanna-Barbera, Disney, and all the other studios had their signature hand-lettered type.

Lettering originally meant that there wasn't any pre-made type, but artists sat down and designed each headline, title, and credit from scratch. When photostetting came about, lettering artists took their artwork and transferred it to strips of negatives through which one letter at a time was projected onto paper or film. The result was more mechanical than before because each character existed only in one version. So they added alternates, ligatures, and swashes to the character set, just like OpenType fonts have them today. The look of those titles, headlines and slogans may appear quaint today, but they are still an inspiration for today's type designers.

The computer was invented to take over repetitive tasks because it knows no boredom. It is not easy making computer-generated art appear spontaneous and lively. The same goes for type. Even variations can end up as mere repeats of similar patterns.

The House Industries guys in Delaware consider themselves lettering artists as well as type designers. They thrive on American vernacular. Turn to their library for typefaces which look like they came straight from a beach bar in Hawaii or a 50s diner in Hollywood.

They took it upon themselves to digitize the entire Photolettering library, which had its heyday when mad advertising men ruled on Madison Avenue. The fonts manage to combine Flintstone aesthetics with digital finesse, a high-tech approach to portrait the low-tech culture that we'll always remember.

Handgloves

HOUSE-A-RAMA LEAGUE NIGHT

HANDGLOVES

HOUSE-A-RAMA KINGPIN

HANDGLOVES

HOUSE-A-RAMA STRIKE

HANDGLOVES

HOUSE MOVEMENTS CUSTOM

HANDGLOVES

HOUSE MOVEMENTS POSTER

Handgloves

HOUSE MOVEMENTS SIGN

Handgloves

HOUSE MOVEMENTS SOILED

HANDGLOVES

HOUSE MOVEMENTS RUNWAY



29. II 11
 Betty Tagebücher: Ein Mensch, der
 Tagebuch hat, ist einem Tagebuch gegenüber
 falschen Position. Wenn er z. B. in Loeb
 liest 11. I 1797 den ganzen Tag zuhause
 deren Anordnungen beschäftigt "so so
 er selbst hätte noch niemals an einer
 wenig gemacht. - Reisebeobachtungen
 anders als die heutigen weil sie aus
 Fort Rutsche gemacht mit den langsam
 gen des Geländes sich einfacher entwi-
 celn leichter selbst von denjenigen ver-
 werden können der die jene Gegenden
 Ein ruhiges friedlich landschaftliches
 tritt ein da die Gegend unbeschädigt i-
 Charakter dem Innern der
 eingeborenen darbietet und auch die Landstr-
 sich darbietet und auch die Landstr-
 Land viel natürlicher schneiden als
 Eisenbahnstrecken zu denen sie willig
 chen Verhältnisse stehen wie Flüsse in Kan-
 braucht es auch beim Zuschauer keine
 Reiten und er kann ohne große Mühe
 sehen. Augenblickebeobachtungen gibt
 wenige meist nur in Innenräumen wo bei
 Menschen gleich gewöhnlich einem vor den
 nfransen z. B. österreichische Offiziere in Hei-
 e ist diese Stelle von den Männern in

Original Kafka manuscript

Kafka's handwriting, as digitized by Julia Sismäläinen.

nen Charakter
 id viel natür
 nbahnstrecken
 e Verhältnisse

Typography is writing with mechanical letters. But as formal as our printing letters may have become, they still show traces of the hand. The rhythm of up- and downstrokes seems natural to our eyes, seriffed stroke endings betray the brush or the quill and typographic terms like cursive remind us of the origin of our writing system.

Once we've mastered what schoolteachers still call "print," we move on to developing our own style of handwriting. This is often a compromise between personal expression and legibility for the sake of communication. Fountain pens and paper notebooks may be back in fashion, but more as fashion statements than actual writing tools.

The personal touch of "real" handwriting, however, is often used when a brand wants to convey a feeling of intimacy, of genuine one-to-one communication. Good idea, but difficult to turn into electronic form without a lot of scanning and reproduction work. Instead, we have typefaces that look like handwriting. A word like letter, with two identical e and l would show its mechanical origin if it weren't for OpenType features. Two or more versions of each letter can be designed and inserted automatically. Letter shapes at the beginning of a word are different from those at the end, some characters have alternate descenders or ascenders, and one can even have letters underscored or crossed out, as messy as your doctor's prescription.

Type designers have always been using their own handwriting as models for typefaces. Mechanical constraints and society conventions resulted in more or less formal scripts, executed with brushes, quills, fountain pens, and even felt tips. Those were then cut into metal or photographed and made into fonts. As digital tools became available and ever more sophisticated, handwriting fonts became more unconventional and personal.

You can now buy the "handwriting" of famous artists like Picasso, Cezanne, and even Franz Kafka. His manuscripts were rather messy, but that did not stop Julia Sismäläinen from designing her Mr. K with all the imperfections the writer would probably have liked to avoid.

An OpenType version of FF Trixie, the first digital "old" typewriter font, now uses features to make digital type look analog, while Suomi by Tomi Haaparanta looks like the handwriting you wish you had. Supermarker by Ulrike Rausch has no less than five alternatives for most characters.

Handgloves
SUPERMARKER
Haaaand
SUPERMARKER
Handgloves
SUOMI HAND
Handgloves
FF TRIXIE HD PRO HEAVY

Handgloves
FF MISTER K
Handgloves
FF MISTER K ONSTAGE
Haaaaannnn
FF TRIXIE HD PRO HEAVY
Handgloves
FF TRIXIE HD PRO HEAVY

The rigid typographic system of points and picas, of non-printing materials like galleys, furniture, quads and spaces, quoins, and formes presented a challenge to those designers who wanted to make their work appear unconstrained, effortless, free-flowing even. It is ironic, therefore, that today – where the computer offers limitless choices to arbitrarily place elements anywhere on the surface, in any color, shape, or size – people should go back to letterpress printing.

Arranging the space inbetween the letters is more work than setting the type itself. This is Joschmi, cut in wood at 12 pica size.

There is one easy way out: Take the artwork from your computer and have someone make a polymer plate from it. That can be printed on a press, one color at a time, without the hassle of arranging the non-printing elements as carefully as those that will show up as inked messages. The tactile quality of printing *into*, rather than just *onto*, a surface will still be visible.

If you want the full imperfections that come with the mix of materials – metal, wood, ink, paper – where each one adds to the list of things that can go wrong while trying to tame complex mechanical processes involving heavy machinery, electricity, chemicals, even compressed air, you can become a letterpress printer. Don't expect to make a living, but be prepared to learn your craft all over again.

Or you can simply fake it by using one of the many typefaces that have been revived from original woodtype. At least the visual effect will evoke the spirit, if not the body, of letterpress printing.

The trouble (or the fun) with letterpress printing is that you have to physically arrange not only the pieces that will eventually print, i. e. show on the page, but also the stuff in between: the non-printing space.

Large pieces, made from wood or metal, are called *furniture* and measured in picas. One pica equals 12 points and 6 picas equal one inch (ca. 2,54cm) – within the Anglo-American typographic system.

Thinner pieces are called *reglet* or *leads*. They are used for the space between lines of type, thus the expression *leading*. *Quads* are used for spacing out a line of type and come in all sizes. An *em*-quad is a space that is one *M* wide, as wide as the height of the font. An *en*-quad is a space that is one *N* wide: half the width of an *em*-quad. Thinner adjustments are made with *spaces*, as thin as a sixth of the height. We still use these measurements in Indesign and other layout applications.



At the Hamilton Wood Type & Printing Museum, they still cut wood type. Erik Spiekermann's Artz was designed for them. Joschmi is Flavia Zimbardi's adaptation of a sketch by Joost Schmidt, cut as wood type at Spiekermann's workshop p98a in Berlin. Ulrike Rausch digitized Filicudi, an Italian wood type from the 20s, for Adobe's Tipoteca series.

HANDGLOVES

FILICUDI SOLID

HANDGLOVES

FILICUDI STRIPED

HANDGLOVES

FILICUDI TWO COLORS

HANDGLOVES

HWT AMERICAN SOLID

HANDGLOVESSS

HWT ARTZ

Handgloves

JOSCHMI

MANUFACTURED BY
Wm. H. Page & Co.

In ordering, leave out no part of the name or number printed over the line.

(Patented.)

Twenty Line Chromatic French Clarendon Ornamented No. 4. Inset. Class C. 15 Cents.

Outside, Class E. 22 Cents.

SPOIL

Thirty Line Chromatic French Clarendon Ornamented No. 5.

Outside, Class E. 32 Cents.

Inset. Class C. 21 Cents.

DIN

Twelve Line Border No. 52. \$1.25 per foot.

Printed with WADE'S INKS, from H. D. Wade & Co., 50 Ann St., New York.

No matter what turns technology takes, the typefaces we see most will still be those based upon letterforms from the end of the fifteenth century; the original Venetian or German models are evident in the diverse interpretations of every type designer since then. Garamond, Caslon, Baskerville, Bodoni; Gill, Zapf, Frutiger, Unger: they all found inspiration in the past for typeface designs that were appropriate for their times and their tools. Every new imaging technology (as we call it today) results in a new generation of type

When people today complain that there are too many typefaces around, show them some of the type specimens from the late 1800s. Those fonts were all manually cut, in wood or metal! They show that designing typefaces and making fonts have always fascinated artists, craftsmen and designers, challenging them to make better and more beautiful things all the time.

designs. Today, outline fonts can emulate any shape imaginable, if not necessarily desirable; they can equal and even improve upon every aesthetic and technical refinement ever dreamed of or achieved.

Apart from the typefaces that work well because we are familiar with them, there are those that defy the simplistic classifications of usefulness or purpose. They may exist only because the type designer's first thought one morning was a new letter shape. These private artistic expressions may not appeal to a wide audience, but every now and again the right singer effortlessly transforms a simple song into a great hit. There are typographic gems hidden in today's specimen books just waiting to be discovered. In the right hands, technical constraints turn into celebrations of simplicity, and awkward alphabets are typographic heroes for a day.

There is no bad type.

It takes time for a typeface to progress from concept through production to distribution, and from there to the type users' awareness. Typefaces are indicators of our visual and thus cultural climate; type designers, therefore, have to be good at anticipating future trends. No amount of marketing will get a typeface accepted if it runs against the spirit of the time.

Every once in a while a typeface is revived by graphic designers and typographers who dust it off and display it in new environments – either as a reaction against prevailing preferences or simply because they want to try something different. Actual problemsolving often seems not to matter when it comes to choosing typefaces. True classic typefaces – that is, those with the beauty and proportion of their fifteenth-century ancestors – still win awards in the most chic and modern design annuals.

There is no bad type.

FIELD TRIP

Type travels



FF Real Text Condensed Medium

There may not be any bad type, but there is more type than this book could possibly show. Apart from a few mentions at the beginning, this has been entirely about Latin type. While colonialism imposed English, French, Spanish, Portuguese, and even Dutch on many countries around the world, other writing systems survived and even thrived.

Today, more than 5 billion people write the Latin alphabet. Arabic is written by 660 million people and 250 million use Cyrillic for several

In the Western world, printing the 42-line bible in 1455 wrongly earned Gutenberg the reputation as sole inventor of printing with movable metal type. Seventy years before him, types were engraved, cast and set on the Korean peninsula to print a book called *Jikji*.

In 1443 King Sejong the Great created Hangul, a writing system for the Korean language. The letters of this alphabet are arranged in blocks of syllables in two dimensions. Movable metal Hangul types are shown on the opposite page.

languages, while some former Soviet republics have gone back to their traditional alphabets like Georgian or Armenian. Hebrew and Greek have a high profile but not many users – Greek eleven million, Hebrew 14 million. What typographers and engineers call CJK are the alphabets written in China, Japan and Korea – a large part of the world's population. Hindi is the major language in India, written in Devanagari. Urdu is a major language in Pakistan, written in Arabic script. Both languages – natively spoken by more than 300 million people – are closely related and can be understood in both countries, but religious and political divisions have separated what was once called Hindustan.

The smallest writing system must be Cherokee, which is used by 20,000 people.

Contemporary designs for the Hangul alphabet include *Arvana* by Noheul Lee and *Dunkel Sans* by Minjoo Ham, both graduates of the Type and Media course at KABK in The Hague. *Arvana* combines a strong brush stroke typical of Hangul with Latin calligraphic features and also assembles sharp edges with elegantly dynamic curves. The Latin counterpart was drawn by Lee's studio partner Loris Olivier. Together they run lo-ol type foundry.

편두통

ARVANA REGULAR HANGUL

Migraine

ARVANA REGULAR LATIN

일편단심

ARVANA BLACK HANGUL

Sincerity

ARVANA BLACK LATIN

Dunkel Sans is derived from mid-century Korean movie posters and demonstrates Ham's exploration of a heavyweight Hangul face – quite a challenge for multi-storey syllables. 'Dunkel' means 'dark' in German. In collaboration with Mark Frömberg she co-founded the multi-script typedesign studio Hypertype in 2020. Their first typeface is Neutronic, first released as heavy, but with a larger family system in mind for the future.

등켈산스

DUNKEL SANS HANGUL

Dunkel

DUNKEL SANS LATIN

하이퍼타입

NEUTRONIC HANGUL

Hypertype

NEUTRONIC LATIN



The design of alphabets has always been practiced by communities all across the world. In recent years these networks have moved together more closely, enabling exchange and increasing knowledge. New and affordable tools as well as type design courses offered in several countries create opportunities for a new generation of designers to learn about all the world's writing systems and create visual interpretations for them. These pages only represent a very small fraction of an ever-growing global multi-script typeface library.

The examples below were designed by the emerging Foundry Five, run by Kostas Bartsokas, Mohamad Dakak and Pria Ravichandran, graduates of the prestigious MA Type Design programme at the University of Reading, UK, specialized in the design of multi-script type families.

The Arabic specimen words below are part of a popular phrase used to list all the characters of this alphabet, arranged right to left. The Greek reads *Endi-amesous*, meaning "intermediates," while the specimen word at the bottom is the name of a neighborhood in Chennai, India, arranged in a typeface for Tamil, a language spoken by over 85 mio. people.

حطي كلمن

EQIL ARABIC

Лазутчица

EQIL CYRILLIC

Ενδιάμεσους

EQIL GREEK

Handgloves

EQIL LATIN

حطي كلمن

JALI EXTRALIGHT

حطي كلمن

JALI LIGHT

حطي كلمن

JALI REGULAR

حطي كلمن

JALI MEDIUM

حطي كلمن

JALI SEMIBOLD

حطي كلمن

JALI BOLD

حطي كلمن

JALI EXTRABOLD

திருவான்மியூர்

TEAK MICRO BOLD

In recent years, several independent type foundries emerged that specialize in either a native script or follow a multi-script approach. The opposite page shows type specimens by Sandoll (Seoul, Korea), Rosetta (Brno, Czech Republic), Foundertype (Beijing, China) and a publication by typejournal.ru, specialists in Cyrillic type design.

Marlik represents a 'simplified' version of the Arabic script and features modern, straightforward forms, retaining conventional proportions. It was designed by Borna Izadpanah, with art direction by Fiona Ross, released by Rosetta in 2018, and also supports Persian and Urdu. The first line reads "solid geometry" and highlights Arabic diacritics or short vowels that are not always typeset.

الهندسة الفراغية

MARLIK EXTRABOLD

ماهندرابارفاتا

MARLIK SEMIBOLD

Oded Ezer designed a Hebrew companion for the existing FF Meta. It captures the essence of the original humanist sans serif, without denying the common square proportions of Hebrew letterforms.

שבאנציקלופדיה

FF META HEBREW REGULAR

שבאנציקלופדיה

FF META HEBREW BOLD

گشايش مجدد معماری داخلی
معماری داخلی از سال ۱۳۲۹ هجری شمسی در
دانشگاه تهران و کارآموزی در این رشته و
تقدیم جامعه شده اند که بیشتر آن ها از اساتید
دانشگاهها و هنرمندان سرشناس می باشند.

منی حاظوم، هي فنانة فيديو فلسطينية وفنانة تنصيبة
في كلية بيروت الجامعية في لبنان حاظوم لمدة عامين
للعمل في وكالة إعلانات. لم تكن حاظوم رائدة
أثناء عملها في مجال تصميم الإعلانات

Sha Mohammad Hadid DBE RA (Arabic:
Hadid) 31 October 1950–31 March
British architect. She was
the Pritzker Archite-
as described by
the curve" who
ing it."



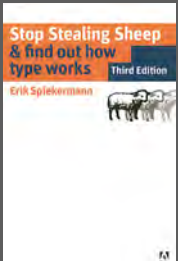

Not one source could possibly list all the writing systems in the world – but wait! There is a standard: Unicode. The official website of the Unicode consortium is home.unicode.org. It shows more than 110,000 characters, signs and symbols. You can look up a language and see which writing system is used to express it. The work to gather and encode writing systems is ongoing, with emojis and forgotten characters of ancient scripts being the latest addition.

The modern Japanese writing system uses mainly three scripts: adopted Chinese characters called Kanji (first three characters in the lines below), Hiragana for adopted Japanese words (4th and 7th character) and Katakana used mostly for foreign terms (5th and 6th). Japanese text is traditionally arranged vertically, but it is just as common to see horizontal typesetting. Chikushi was designed under the type direction of Shigenobu Fujita, released with Fontworks in 2010.

羊泥棒をヤメて
羊泥棒をヤメて

羊泥棒をヤメて
羊泥棒をヤメて

This book has been translated into German, Portuguese, Korean, Russian, and Thai – in some cases it had to be typeset in the respective scripts.

Chikki is a contemporary typeface for Devanagari (primarily used for Sanskrit, Prakrit, Hindi and Marathi), Gurmukhi (used to write Panjabi) and Latin by Kimya Gandhi and Robert Keller, released with Mota Italic in 2019. The Devanagari line below translate as “the art of printed and written letterforms,” the Gurmukhi word simply means “universities.”

मुद्राक्षरलेखनकला
मुद्राक्षरलेखनकला
मुद्राक्षरलेखनकला
ਯੂਨੀਵਰਸਟੀਆਂ
ਯੂਨੀਵਰਸਟੀਆਂ

decodeunicode.org is a project by Siri Poagaran and Johannes Bergerhausen. It lists information well beyond the simple (!) showing of all encoded characters. Apart from looking up a language and the corresponding writing system, you can look at a large showing of each sign or character – they have all been redrawn to a high standard. You can check which language a character appears in, which script it belongs to, and, of course, its Unicode value. All you ever wanted to know about type & language is there.



YOGI BERRA

**When you
get to the fork
in the road,
take it.**

(1925–2015), Hall-of-Fame catcher for the New York Yankees, was one of the great all-time clutch hitters and a notorious bad ball hitter. Berra, who later managed the Yankees, has a natural ability to turn ordinary thoughts into linguistic ringers.

FF Unit

CHAPTER 12

Final form.

FF Real Head Black





Links

These links were all tested some time in the summer of 2020.

By the time this book gets to you, however, some of them may have expired and many more useful websites will have sprung up.

A new foundry opens up every day, and while many young type designers still license their fonts to an established distributor, new ways of showing type and selling fonts are still being invented.

Just a warning for our young readers: clicking on these links will not get you to a website; you actually have to type them into a browser again.

And there's plenty of space to write new links in, by hand!

.....

bboxtype.com
commercialtype.com
dardenstudio.com
djr.com
emigre.com
ferdinandulrich.com
fonts.com
fontfont.com
fontstand.com
fontwerk.com
fonts.adobe.com
fontshop.com
fontbureau.com
fonts.google.com
fontlab.com
fontsinuse.com
foundryfivetype.com
fonts.google.com
frerejones.com
futurefonts.com
glyphs.com
grillitype.com
hamiltonwoodtype.com
houseindustries.com
hvdfonts.com
ilovetypography.com
kupferschrift.de
liebefonts.com
letterror.com
letteringandtype.com
normanpossett.com
optimo.ch
paulshawletterdesign.com
p98a.berlin
sportsfonts.com
swisstypefaces.com
type-together.com
typecache.com
typefacts.com
typekit.com
typenetwork.com
typography.com
typographica.org
typotheque.com
typographyforlawyers.com
typerecord.com
underware.nl
vllg.com
welovetypography.com
woodyper.com
zetafonts.com

Bibliography

Learning to use type properly might take a lifetime, but it will be a lifetime of fun.

In case you have now been bitten by the typographic bug, here is what we recommend as further reading on the subject. The list is far from complete, but includes both practical manuals and classic works. Some of these books are out of print, but can be found with a little effort in good used book stores or online. Not that we suggest you do your reading online, but plenty of useful information about type & typography can be found on the web.

Most of these books are in English, some are not. Many of this book's readers do not have English as their first language, and it never hurts to look at books in another language than your own. You'd be surprised how different type can look in another language because then you don't read, just look at the words and letters.

- AHRENS, TIM, SHOKO MUGIKURA.
Size-specific adjustments to type designs.
Munich: Just another foundry, 2014.
- BERGERHAUSEN, JOHANNES,
POARANGAN, SIRI.
Decodeunicode – Alle Schriftzeichen der Welt.
Mainz: Verlag Hermann Schmidt, 2011.
- BERRY, JOHN D.
Language Culture Type: International Type Design in the Age of Unicode.
New York: Association Typographique Internationale, 2002.
- BERRY, W. TURNER, A. F. JOHNSON,
W. P. JASPERTS.
The Encyclopedia of Type Faces.
London: Blandford Press, 1962.
- BIGELOW, CHARLES, PAUL HAYDEN
DUENSING, LINNEA GENTRY.
Fine Print On Type: The Best of Fine Print on Type and Typography.
San Francisco: Fine Print/Bedford Arts, 1988.
- BLUMENTHAL, JOSEPH.
The Printed Book in America.
Boston: David R. Godine, 1977.
- BOSSHARD, HANS RUDOLF.
Technische Grundlagen der Satzherstellung.
Bern: Verlag des Bildungsverbandes Schweizerischer Typografen BST, 1980.
- BOSSHARD, HANS RUDOLF.
Mathematische Grundlagen der Satzherstellung.
Bern: Verlag des Bildungsverbandes Schweizerischer Typografen BST, 1985.
- BOSSHARD, HANS RUDOLF.
The typographic grid.
Zurich: Niggli, 2006.
- BRANCZYK, ALEXANDER, JUTTA NACHTWEY,
HEIKE NEHL, SIBYLLE SCHLAICH,
JÜRGEN SIEBERT, EDS.
Emotional Digital: A Sourcebook of Contemporary Typographics.
New York & London: Thames and Hudson, 2001
- BRINGHURST, ROBERT.
The Elements of Typographic Style. 2nd ed.
Point Roberts, WA: Hartley & Marks, 1997.
- BURKE, CHRISTOPHER.
Paul Renner. The art of typography.
London: Hyphen Press, 1998.
- BUTTERICK, MATTHEW.
Typography for lawyers: Essential tools for polished & persuasive documents.
Houston: Jones McClure Publishing, 2010.
- CAMPE, CHRIS, ULRIKE RAUSCH.
Making Fonts! Der Einstieg ins professionelle Type-Design
Mainz: Verlag Hermann Schmidt, 2016.
- Making Fonts! Der Einstieg ins professionelle Type-Design*
Mainz: Verlag Hermann Schmidt, 2016.
- CARTER, HARRY.
A view of early typography up to about 1600.
London: Hyphen Press, 2002.
- CARTER, ROB, BEN DAY, PHILIP MEGGS.
Typographic Design: Form and Communication.
Hoboken, NJ: John Wiley & Sons, 2012.
- CARTER, SEBASTIAN.
Twentieth Century Type Designers.
New York: W. W. Norton & Company, 1999.
- CHAPPELL, WARREN, ROBERT BRINGHURST.
A Short History of the Printed Word.
Point Roberts, WA: Hartley & Marks, 2000.
- THE CHICAGO MANUAL OF STYLE.
15th Edition. Chicago: The University of Chicago Press, 2002.
- CHAMARET, SANDRA, JULIEN GINESTE,
SÉBASTIEN MORLIGHEM.
(FOREWORD BY GERARD UNGER).
Roger Excoffon & Fonderie Olive.
Paris: Ypsilon Editeur, 2010.
- CHENG, KAREN.
Anatomie der Buchstaben. Basiswissen für Schriftgestalter.
Mainz: Verlag Hermann Schmidt, 2006.
- COLES, STEPHEN
(FOREWORD BY ERIK SPIEKERMANN).
The Anatomy of Type. New York: Harper Design, 2012; *The Geometry of Type.*
London: Thames & Hudson, 2013.
- CRYSTAL, DAVID.
The Cambridge Encyclopedia of Language.
Cambridge: University Press, 1997.
- DAIR, CARL.
Design with Type. Toronto and Buffalo: University of Toronto Press, 1982.
- DONALDSON, TIMOTHY.
Shapes for Sound. New York: Matt Batty Publisher, 2008.
- DOWDING, GEOFFREY.
Finer Points in the Spacing and Arrangement of Type.
Point Roberts, WA: Hartley & Marks, 1998.
- DOWDING, GEOFFREY.
An Introduction to the History of Printing Types.
London: The British Library, 1997.
- DRUCKER, JOHANNA.
The Alphabetic Labyrinth, the Letters in History and Imagination.
London: Thames and Hudson, 1997.
- DWIGGINS, WILLIAM ADDISON.
Layout in Advertising.
New York: Harper and Brothers, 1948.
- EISELE, PETRA, ISABEL NAEGELE ED.
Texte zur Typografie. Positionen zur Schrift.
Zürich: Niggli, 2012.
- EISELE, PETRA, ANNETTE LUDWIG,
ISABEL NAEGELE ED.
Futura. Die Schrift.
Mainz: Verlag Hermann Schmidt, 2016.
- FINEDER, MARTINA, EVA KRAUS,
ANDREAS PAWLK ED.
postscript | Zur Form von Schrift heute.
Stuttgart: Hatje Cantz, 2004.
- FISCHBACH, DAVID ED.
Die Galerie im Setzkasten.
The Gallery in the Type Case. The Collector Arno Stolz. Zürich: Niggli, 2018.
- FRUTIGER, ADRIAN.
Type, Sign, Symbol. Zürich: ABC Verlag, 1980.
- GARFIELD, SIMON.
Just my type: A book about fonts.
London: Profile Books, 2010.
- GILL, ERIC.
An Essay on Typography.
Boston: David R. Godine, 1988.
- GORDON, BOB.
Making Digital Type Look Good.
New York: Watson-Guptill, 2001.
- GRAY, NICOLETE.
A History of Lettering: Creative Experiment and Letter Identity. Boston: David R. Godine, 1986.
- HARLING, ROBERT.
The Letter Forms and Type Designs of Eric Gill.
Boston: David R. Godine, 1977.
- Hart's Rules for Compositors and Readers.*
London: Oxford University Press, 1967.
- HLAVSA, OLDRIČH.
A Book of Type and Design. New York: Tudor Publishing, 1960.
- HOCHULI, JOST, ROBIN KINROSS.
Designing Books: Practive and Theory. London: Hyphen Press, 1996.
- HOUSTON, KEITH.
Shady characters: Ampersand, interrobangs and other typographical curiosities.
London: Particular Books, 2013.

- HOUSTON, KEITH.
The Book. New York: W. W. Norton, 2015.
- HYNDMAN, SARAH.
The Type Taster: How Fonts Influence You. London: Type Tasting, 2015.
- IZUMO, TOSHIYA.
Japanische Typografie. Berlin: UDK, 2010.
- JASPERT, W. PINCUS, W. TURNER BERRY, A. F. JOHNSON.
The Encyclopedia of Type Faces. New York: Blandford Press, 1986.
- JOHNSTON, ALASTAIR.
Alphabets to Order: The Literature of Nineteenth-Century Typefounders' Specimens. London: The British Library; New Castle, DE: Oak Knoll, 2000.
- JURY, DAVID.
Letterpress: The allure of the handmade. Brighton: Rotvision, 2011.
- KELLY, ROB ROY.
American Wood Type 1828–1900: Notes on the Evolution of Decorated and Large Types. New York: Van Nostrand Reinhold, 1977.
- KINROSS, ROBIN ED.
Anthony Froshaug. Typography & Texts/ Documents of a Life. London: Hyphen Press, 2000.
- KINROSS, ROBIN.
Unjustified texts: Perspectives on typography. London: Hyphen Press, 2002.
- KINROSS, ROBIN.
Modern Typography: An Essay in Critical History. London: Hyphen Press, 1992.
- LAWSON, ALEXANDER.
Anatomy of a Typeface. Boston: D.R. Godine, 1990.
- LAWSON, ALEXANDER.
Printing Types: An Introduction. Boston: Beacon Press, 1971.
- LEWIS, JOHN.
Anatomy of Printing: The Influence of Art and History on Its Design. New York: Watson Guptill, 1970.
- LUPTON, ELLEN.
Thinking with type: A critical guide for designers, writers, editors & students. New York: Princeton Architectural Press, 2004.
- MALSY, VICTOR, INDRA KUPFERSCHMID, AXEL LANGER.
Helvetica forever: Geschichte einer Schrift. Baden: Lars Müller Publishers, 2008.
- MCGREW, MAC.
American Metal Typefaces of the Twentieth Century. New Castle, DE: Oak Knoll, 1993.
- MCCLEAN, RUARI.
Jan Tschichold: Typographer. London: Lund Humphries Ltd., 1975.
- MCCLEAN, RUARI.
The Thames and Hudson Manual of Typography. London/New York: Thames and Hudson, 1980.
- MCCLEAN, RUARI.
Typographers on Type: An illustrated anthology from William Morris to the present day. London: Lund Humphries Publishers, 1995.
- MCCLEAN, RUARI.
How Typography Happens. London: The British Library; New Castle, DE: Oak Knoll, 2000.
- MEGGS, PHILIP B., ROY MCKELVEY, EDS.
Revival of the Fittest: Digital Versions of Classic Typefaces. Cincinnati, Ohio: North Light Books, 2000.
- MERRIMAN, FRANK. A. T. A.
Type Comparison Book. New York: Advertising Typographers Association of America, 1965.
- MIDDENDORP, JAN.
Dutch Type. Rotterdam: OIO Publishers, 2004.
- MIDDENDORP, JAN, ERIK SPIEKERMANN, ED.
Made with FontFont: Type for independent minds. Amsterdam: BIS Publishers, 2006.
- MORISON, STANLEY.
Type designs of the past and present. London: The Fleuron, 1926.
- MORISON, STANLEY.
First Principles of Typography. New York: The Macmillan Company, 1936.
- MORISON, STANLEY.
A Tally of Types. Boston: David R. Godine, 1999.
- NICKEL, KRISTINA ED.
Ready to Print: Handbook for Media Designers. Berlin: Gestalten, 2011.
- OSTERER, HEIDRUN, PHILIPP STAMM ED.
Adrian Fruiterer Typefaces: The Completed Works. Basel, Boston, Berlin: Birkhäuser, 2009.
- PAWLIK, ANDREAS, MARTIN TIEFENTHALER, ED.
Subtext Typedesign. Zürich: Niggli, 2017.
- PIPES, ALAN.
Production for Graphic Designers. 3rd ed. New York: The Overlook Press, 2001.
- ROGERS, BRUCE.
Paragraphs on Printing. New York: Dover Publications, 1979.
- RONDTHALER, EDWARD.
Life with letters as they turned photogenic. New York: Hastings House Publishers, 1981.
- ROSENDORF, THEODORE.
The typographic desk reference. New Castle, DE: Oak Knoll Press, 2009.
- SCHALANSKY, JUDITH.
Fraktur Mon Amour. Mainz: Verlag Hermann Schmidt, 2006.
- SHAW, PAUL ED.
The Eternal Letter: Two Millennia of the Classical Roman Capital. Cambridge, MA: MIT Press, 2015.
- SMEIJERS, FRED.
Counter punch: Making type in the sixteenth century, designing typefaces now. London: Hyphen Press, 1996.
- SMITSHUIJZEN, EDO.
Sculpting Type. An Introduction to CNC Typography. Amsterdam: Khatt Books, 2013.
- SPENCER, HERBERT.
Pioneers of modern typography. London: Lund Humphries Publishers Ltd., 1990.
- SPIEKERMANN, ERIK.
Rhyme & Reason: A Typographical Novel. Berlin: Berthold, 1987.
- THI TRUONG, MAI-LINH, JÜRGEN SIEBERT, ERIK SPIEKERMANN ED.
FontBook. Digital Typeface Compendium. 4th ed. Berlin: FSI FontShop International, 2006.
- TIPOTECA ITALIANA
Tipoteca 25. Cornuda: Tipoteca Italiana, 2019.
- TRACY, WALTER.
Letters of Credit: A View of Type Design. London: Gordon Fraser, 1986.
- TSCHICHOLD, JAN.
Alphabets and Lettering: A Source Book of the Best Letter Forms of Past and Present for Sign Painters, Graphic Artists, Typographers, Printers, Sculptors, Architects, and Schools of Art and Design Ware. Hertfordshire, England: Omega Books, 1985.
- TSCHICHOLD, JAN.
The Form of the Book: Essays on the Morality of Good Design. Point Roberts, WA: Hartley & Marks, 1997.
- ULRICH, FERDINAND
(FOREWORD BY JACK W. STAUFFACHER).
Hunt Roman Genealogy. Berlin, 2012.
- UNGER, GERARD.
Terwijl je leest. Amsterdam: De Buitenkant, 1997.
- UNGER, GERARD.
Theory of typeface design. Amsterdam: De Buitenkant, 2019.
- UPDIKE, DANIEL BERKELEY.
Printing Types: Their History, Forms, and Use. 2 vols. New Castle, Delaware: Oak Knoll, 2001.
- VAN GAALEN, ANNELOES ED.
Never Use More Than Two Different Typefaces: And 50 Other Ridiculous Typography Rules. Amsterdam: BIS publishers, 2010.
- VOELKER, ULYSSES.
read + play. Mainz: Verlag Hermann Schmidt, 2015.
- WILLIAMSON, HUGH.
Methods of Book Design: The Practice of an Industrial Craft. New Haven & London: Yale University Press, 1985.
- WILLIAMS, JIM.
Type Matters. London: Merrel, 2012.
- WITTNER, BEN, SASCHA THOMA, TIMM HARTMANN ED
Bi-Scriptual. Typography and Graphic Design with Multiple Script Systems. Salenstein, CH: Niggli, 2018.

Index

- A**
accents, 13, 59
Adobe CoolType, 133
Adobe Creative Suite, 117ff
Adobe Illustrator, 17, 49, 155
advertisements, 11, 83, 87, 93, 111, 161, 193,
Aicher, Otl, 121
lowercase alphabets, 7, 25, 47,
51, 59, 71, 113–117, 145
alternates, 117ff, 195
architectural type, 75
Arabic, 209
Armenian, 207
Arrighi, Ludovico degli, 33
arrows, 101
ascenders, 57, 107
- B**
backlit signs, 23
Baker, Arthur, 33
Bankhead, Tallulah, 26
bar codes, 21
Bartsokas, Kostas, 207
Baskerville, John, 71, 201
Bauer, Konrad, 53
Baum, Walter, 53
Benton, Morris Fuller, 47, 53,
69, 91
Bergerhausen, Johannes, 211
Berlow, David, 47, 53, 93, 183
Berra, Yogi, 208
Bigelow, Charles, 175
bitmap fonts, 59, 75, 183, 177, 189
bitmaps, 37, 59, 73, 133
black typefaces, 47, 53, 125, 153,
163
Bodoni, Giambattista, 67, 179
bold type, 69, 89, 95, 111, 125
branding, 77, 177
Brody, Neville, 47
brushstroke typefaces, 193
business forms, 19, 89, 167
Butterick, Matthew, 93
- C**
capitals, 7, 47, 51, 91, 107, 117
captions, 157ff
Carter, Matthew, 71, 75
Caslon, William, 81, 201
casual typefaces, 49, 65
Chansler, KimBaker, 33
character sets, 97, 117, 195
charts, 119
Chinese, 211
classic typefaces, 40, 51, 195
classifying type, 55, 89, 199
ClearType technology, 133
coffee table books, 157
column, 15, 81, 87, 149,
- 157, 171
condensed typefaces, 47, 53,
85, 95, 127, 183
contrast, 127, 179
cookbooks, 163
CoolType technology, 133
copperplates, 71, 189, 193
counters, 23, 37, 57, 75,
93, 125
cursive fonts, 65, 191, 197
Cyrillic, 209
- D**
Dakak, Mohamad, 209
de Groot, Lucas, 69
descenders, 57, 107
design, invisible, 15
Devanagari, 207, 211
diagrams, 119
digital typefaces, 29, 133
Di Montalcino, Brunello, 21
DIN standard, 25
discretionary ligatures, 117
Doyle, Sir Arthur Conan, 78
Du Carrois, Ralph, 179
Dulkyns, Susanna, 49
- E**
Eaves, Sarah, 71
Eboys, 37, 59
eggs, type on, 21
email messages, 137, 175
emotions, 21, 47–55
EOT format, 177
ergonomics, 131
Ezer, Oded, 209
Excoffon, Roger, 49, 53
expert sets, 113
- F**
families, type, 77, 83, 111,
113, 121, 127, 205
Figgins, 53, 93
figures, 113, 117, 169, 171
fonts
cursive, 65, 191, 197
formal, 71
jobbing, 47, 93
monospaced, 19, 21, 137
OpenType, 113, 117, 171,
177, 183, 195
See also →typefaces
Fontworks, 211
food packages, 11, 47
forms, 19, 89, 167, 184
fraktur, 31
Franklin, Benjamin, 80, 81
Frazier, Greg, 33
Frere-Jones, Tobias, 63, 65,
69, 73
- Freud, Sigmund, 38
Frömberg, Mark, 207
Frutiger, Adrian, 67, 89, 121,
123
Foundertype, 209
Foundry Five, 209
Fujita, Shigenobu, 211
- G**
Gandhi, Kimya, 211
Garamond, Claude, 179
Georgian, 207
Germanic typefaces, 31
Gill, Eric, 33, 105, 121, 201
Gillespie, Joe, 59, 75
Golden Section, 35
Goudy, Frederic, 7, 93,
139, 141
Griffith, Chauncey H., 63
Gurmukhi, 211
Gutenberg, 31, 33, 203
- H**
Ham, Minjoo, 207
hand lettering, 17
Hangul, 207
“Handgloves” typography, 41
handwriting, 31, 33, 193, 197
Harvey, Michael, 33, 65
headlines, 40–44, 83, 95, 131,
137, 145, 161ff, 195
Hebrew, 209
Herrmann, Ralf, 25
Hindi, 211
hinting, 97, 133, 177
Hiragana, 211
historical forms, 117
Hoffmann, H., 47
Holmes, Kris, 75
Holmes, Sherlock, 78
House Industries, 37, 195
Houston, Keith, 115
how-to manuals, 163
HTML, 119, 175
Huber, Jürgen, 53
human body, 35, 57
Hunt, Paul D., 179
Hypertype, 207
- I**
icons, 101
italic, 33, 47, 91, 159, 183,
185
Izadpanah, Borna, 209
- J**
Japanese, 211
JavaScript, 119, 177
Jikji, 207
jobbing fonts, 93
justified text, 137
- K**
Kaden, Joel, 189
КАВК The Hague, 207
Kanji, 211
Katakana, 211
Kegler, Richard, 193
kerning, 139
Klee, Paul, 172
Koch, Rudolf, 51
Kochel, Travis, 119
Korean, 207, 211
- L**
laser printers, 165
Le Corbusier, 35
leading, 15, 193
Lee, Noheul, 207
legibility, 19, 23, 63ff, 75,
85, 109, 171, 175, 197
letterforms, 51, 105, 195
lettering artists, 189
letterpress printing, 93, 199
lettering, 17, 37, 65, 191, 195
letters, history of, 137
Licko, Zuzana, 37, 53, 71, 189
ligatures, 113, 117
linear reading, 157
lines
length of, 137, 141, 143,
145, 149, 153
spacing of, 15, 57, 81, 137,
141, 147, 149, 153, 199
lining figures, 113, 169ff
Lipton, Robert, 33
lo-ol type foundry, 207
- M**
magazines, 91, 95, 159ff, 195
Majoor, Martin, 71
Manutius, Aldus, 31
Marathi, 211
margins, 81, 159
Marx, Groucho, 186
master designs, 129
Meier, Hans-Eduard, 51
metal type, 47, 23, 47, 53, 57,
93, 113, 189, 193, 199, 201ff
Microsoft ClearType, 133
Middleton, R. Hunter, 189
Miedinger, Max, 123
Modulor system, 35
monospaced fonts, 19, 21, 137
Montalbano, James, 25
Mota Italic, 211
Mulligan, Gerry, 60
multiple master typefaces,
129, 131
- N**
nature, 35, 139
neon signs, 185
Ness, Helmut, 25
netiquette, 175
newspapers, 13–15, 40, 63, 95
Nix, Charles, 131
nostalgia, 93
numerals, 69, 113, 119, 139,
169, 171
- O**
old style figures, 113, 117
Olivier, Loris, 207
OpenType fonts, 113, 117ff,
171, 177, 183ff, 195ff
ordinals, 117
outline, 105ff
outline fonts, 59, 184, 201
- P**
Page, William Hamilton, 93
Pamental, Jason, 183ff
Panjabi, 211
paperbacks, 40, 81, 157
parametric, 185
Persian, 209
pics, 193
pictograms, 99
planning process, 29
Poagaran, Siri, 211
point size, 57, 177
positive type, 23, 99, 165
PostScript, 23, 67, 85
Powell, Gerry, 189
Prakrit, 211
prime marks, 115
printing, 21, 29ff, 37, 63, 69,
93, 131, 153, 157, 177ff, 197,
199, 203
polymer plates, 199
proportion, rules of, 35
proportionately spaced fonts,
137
- Q**
quotation marks, 49, 115
- R**
Rausch, Ulrike, 197ff
Ravichandran, Pria, 209
Reading University, 209
Renner, Paul, 83
reversed type, 23, 99, 152, 165
rhythm, 127
Rickner, Tom, 93
Roman numerals, 171
Rosetta, 209
Ross, Fiona, 209
Rottke, Fabian, 53

S

Sandoll, 209
 Sanskrit, 211
 Sauerteig, Steffen, 75
 Schäfer, Ole, 53
 Schmidt, Joost, 499
 Schneider, Werner, 25
 Schwartz, Christian, 123
 screen displays, 21, 59, 75, 101, 133
 screen fonts, 37, 75, 179
 script fonts, 65, 71
 Shaw, George Bernard, 81
 Sherman, Nick, 185
 Shinn, Nick, 65
 sidebars, 7
 signage systems, 23*ff*, 63, 67, 73, 99*ff*
 signs
 neon, 191
 road, 7, 23, 25
 Sjong the Great, 207
 Slimbach, Robert, 33, 111
 small capitals, 117
 small print, 40
 Smeijers, Fred, 81, 91
 spacing
 letter, 53, 65, 75, 85, 139*ff*, 199
 line, 57, 81, 143*ff*,
 word, 87, 143*ff*, 157
 special characters, 115
 special purpose type-
 faces, 41
 Spiekermann, Erik, 53, 121,
 179, 185, 199
 spreadsheets, 169, 171
 Stan, Tony, 189
 stencil typefaces, 189
 Sutcliff, Judith, 33
 stylistic, 117*ff*
 symbols, 99*ff*, 201
 Sysmälainen, Julia, 197

T

tabular figures, 171
 Thai, 211
 Tam, Keith Chi-hang, 25
 technical constraints, 49
 technical standards, 177
 text
 color of, 149
 long vs. short, 141, 143,
 145
 reversed, 23, 99, 152, 165
 white vs. black, 152
 Thompson, Greg, 47
 Tinnes, Andrea, 69
 Tipoteca Italiana, 199
 tracking, 139, 143, 147*ff*, 152

trendy typefaces, 73
 Twombly, Carol, 29, 51, 81
 type

 advertisement, 83, 93
 architectural, 75
 book, 45, 81, 157, 159
 digital, 29, 85
 form, 49, 89, 167, 184
 magazine, 91, 95, 159, 195
 newspaper, 13–15, 40,
 63, 95
 black, 47, 53, 125
 bold, 69, 111, 125
 brushstroke, 193
 casual, 65
 classifying, 55
 condensed, 85, 127
 families of, 83, 111*ff*, 121,
 workhorse, 69, 75
 typewriters, 69, 113*ff*, 137, 165,
 189, 197

U

UI applications, 101, 185
 Unger, Gerard, 63, 65, 154,
 201
 Unicode, 211
 Urdu, 207

V

van Blokland, Erik, 177, 189,
 193
 van den Keere, Hendrik, 63
 van Rossum, Just, 189, 193
 VanderLans, Rudy, 71
 variable fonts, 181*ff*
 vector data, 149

W

Watzlawick, Paul, 8
 website, 167, 183
 web typography, 167
 Weidemann, Kurt, 77
 weight, 23, 47, 53, 63, 67*ff*, 77,
 81*ff*, 93, 101, 111, 121*ff*, 131,
 153, 159, 175, 179, 183*ff*
 Welk, Lawrence, 121
 Wenzel, Martin, 69
 width, 45, 47, 59, 67, 85, 89,
 123*ff*, 129, 157*ff*, 169*ff*, 183*ff*,
 199
 WOFF, 177, 185
 wood type, 23, 53, 71, 93,
 199, 201
 words
 outline of, 105*ff*
 spacing, 141, 147, 153
 workhorse typefaces, 69, 75

X

x-height, 107

Z

Zapf, Hermann, 67, 201
 Zimbardi, Flavia, 199

Typeface index**A**

Aachen Colin Brignall, 1968: 95
 Akzidenz Grotesk Berthold,
 1896: 85, 180
 Alternate Gothic Morris Fuller
 Benton, 1903: 53
 HWT American P22, 1850, 2012:
 199
 ITC American Typewriter
 Joel Kaden & Tony Stan,
 1974: 189
 Amplitude Christian Schwartz,
 2003: 95
 Amstelvar FontBureau, 2021:
 187
 Andale Mono Steve Matteson,
 1997: 21
 Angst Jürgen Huber, 1997: 53
 Antique Olive Roger Excoffon,
 1962: 41, 49, 53, 95, 107
 Ariat Robin Nicholas & Patricia
 Saunders, 1998: 25, 167, 177
 Arnold Böcklin O. Weisert,
 1904: 43, 44
 Arrival Keith Tam, 2005: 25
 Arvana Noheul Lee: 207
 FF Atlanta Peter Bilak, 1995: 21
 ITC Avantgarde Gothic
 International Typeface
 Corporation, 1970: 105
 Axel Erik Spiekermann,
 Ralph du Carrois, Erik van
 Blokland, 2009: 169

B

Banco Roger Excoffon, 1951: 49
 Baskerville John Baskerville,
 1757: 71, 201
 FF Bau Christian Schwartz,
 2002: 54
 Bembo Monotype Corporation,
 1929: 31
 ITC Benguiat Ed Benguiat, 1977:
 109
 Berliner Grotesk Erik
 Spiekermann (Louis
 Oppenheim 1913), 1979: 93
 Bickham Script Richard Lipton,
 1997: 33
 Block H. Hoffmann, 1908: 47, 53,
 93*ff*, 102, 115
 Bodega Greg Thompson, 1990:
 47
 Adobe Bodoni Morris Fuller
 Benton, 1915: 87

Bodoni Giambattista Bodoni,
 1790: 67, 77, 87, 93

Bauer Bodoni Bauer Type
 Foundry, 1926: 71, 87
 Berthold Bodoni Berthold,
 1930: 87

ITC Bodoni Janice Fishman,
 Holly Goldsmith, Jim
 Parkinson, Sumner Stone,
 1994: 55, 67, 87
 FF Bokka John Critchley, Darren
 Raven, 1997: 99
 Brush Script Robert E. Smith,
 1942: 21

C

Cafeteria Tobias Frere-Jones,
 1992: 65
 Campus Mecanorma: 43, 44
 Carta Lynne Garell, 1986: 99
 Adobe Caslon Carol Twombly,
 1990: 40, 41, 81
 Caslon William Caslon, 1725:
 78, 81
 Centaur Bruce Rogers, 1928: 55
 Centennial Adrian Frutiger,
 1986: 41, 89
 FF Chartwell Travis Kochel,
 2012: 119
 FF Clan Łukasz Dziedzic, 2007:
 129
 ITC Cheltenham Morris Fuller
 Benton, 1902: 45
 Clearview James Montalbano,
 Donald Meeker, 1997–2004:
 23, 25
 Chikki Kimya Gandhi, Robert
 Keller, 2019: 211
 Chikushi Shigenobu Fujita, 2010:
 211
 Choc Roger Excoffon, 1955: 49
 FF Confidential Just van Rossum,
 1992: 189
 Cooper Black Oz Cooper, 1926:
 43, 44, 45
 Copperplate Gothic Frederic
 Goudy, 1901: 21, 71
 Coranto Gerard Unger, 1999: 63
 Corona Chauncey H. Griffith,
 1940: 63
 Corporate A. S. E. Kurt
 Weidemann, 1990: 41, 77
 Courier Bud Kettler,
 1945: 49, 121, 471, 475
 Critter Craig Frazier, 1993: 33

D

Didot Firmin Didot, 1783: 115
 FF Dingbats Johannes Erler,
 Henning Skibbe, 2008: 101
 FF Din Albert-Jan Pool,
 1995: 73, 105
 Dizzy Jean Evans, 1995: 49
 Dogma Zuzana Licko, 1994: 49
 FF Dot Matrix Stephan Müller,
 Cornel Windlin, 1992: 21
 Dunkel Sans Minjoo Ham: 207



E









Eagle David Berlow, 1989: 53
 Eagle Bold Morris Fuller Benton,
 1933: 53
 Ellington Michael Harvey, 1990:
 65
 Empire Morris Fuller Benton,
 1937: 47
 Bureau Empire David Berlow,
 1989: 47
 Eqil Kostas Bartsokas, Mohamad
 Dakak, Pria Ravichandran: 209
 Equity Matthew Butterick, 2012:
 8, 121, 143
 FF Erikrihand Erik van
 Blokland, 1991: 193
 Excelsior Chauncey H. Griffith,
 1931: 63





F

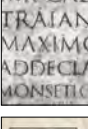









FF Fago Ole Schäfer, 2000: 95
 Fanfare Louis Oppenheim, 1927:
 54, 115
 Felt Tip Woman Mark Simonson,
 2003: 193
 ITC Fenice Aldo Novarese, 1977:
 71
 Fira Ralph du Carrois, Erik
 Spiekermann, 2013: 175, 179
 ITC Flora Gerard Unger, 1980: 65
 Flyer Konrad Bauer & Walter
 Baum, 1962: 53, 95
 FF Fontesque Nick Shinn, 1994:
 65
 Formata Bernd Möllenstädt,
 1984: 95
 Franklin Gothic Morris Fuller
 Benton, 1904: 91, 95
 ITC Franklin Gothic Vic Caruso,
 1980: 53, 69, 91, 196
 Franklinstein Fabian Rottke,
 1997: 53
 Fraunces, Undercase, 2019: 183
 Friz Quadrata Ernst Friz, 1965: 55
 Frutiger Adrian Frutiger, 1976:
 25, 67, 69, 85, 169
 Futura Paul Renner, 1927:
 41, 53, 73, 83, 95, 105, 115











- G**
Garamond Claude Garamond, 1532: **40, 179**
Garamond ATF Mark van Bronkhorst, Igino Marini, Ben Kiel, 2015 (Morris Fuller Benton 1918): **107, 113**
Adobe Garamond Robert Slimbach, 1989: **111, 115**
ITC Garamond Tony Stan, 1975: **107**
GE Inspira Mike Abbink, Carl Cossgrove, Patrick Glasson, Jim Wasco, 2002: **77**
Georgia Matthew Carter, 1996: **177**
Gill Floriated Eric Gill, 1937: **33**
Gill Sans Eric Gill, 1928: **104, 105, 109, 121**
Giza David Berlow, 1994: **53**
Glyphish Joseph Wain, 2010: **99**
Google Sans Google Fonts: **236/7**
Gotham Tobias Frere-Jones, 2000: **69**
Goudy Heavyface Frederic Goudy, 1925: **45**
Goudy Old Style Frederic Goudy, 1915: **134**
Graphik Christian Schwartz, 2009: **73**
Griffith Gothic Tobias Frere-Jones, 1997: **95**
Gulliver Gerard Unger, 1993: **63**
- H**
Neue Haas Grotesk Christian Schwartz, 2010 (Max Miedinger 1957): **123**
Hamilton Thomas Rickner, 1993: **93**
Hartem Neville Brody, 1996: **47**
Hermes Matthew Butterick, 1995: **93**
Helvetica Max Miedinger, 1957: **21, 53, 59, 73, 85, 89, 105, 115, 123, 125, 127, 169, 179**
Helvetica Inserat Max Miedinger, 1957: **127**
Helvetica Now Monotype 2019: **123, 127**
Neue Helvetica Linotype, 1983: **73, 89, 115, 127**
Hobo Morris Fuller Benton, 1910: **41**
House-a-Rama - League Night, Kingpin, Strike, Gutterball, House Industries; Ken Barber *et al.*, 1999: **194, 195**
- I**
Impact Geoffrey Lee, 1963: **95**
FF Info Erik Spiekermann, Ole Schäfer, 1996: **25, 169**
Interstate Tobias Frere-Jones, 1993: **69, 73, 95**
- J**
Jackpot Ken Barber, 2001: **37**
Jali Kostas Bartsokas, Mohamad Dakak, Pria Ravichandran: **209**
Janson Text Horst Heiderhoff, Adrian Frutiger, 1985: **55**
Adobe Jenson Robert Slimbach, 1996: **33**
Joanna Eric Gill, 1930: **121**
FF Justleft hand Just van Rossum, 1991: **193**
- K**
Kabel Rudolf Koch, 1927: **51**
ITC Kabel® International Typeface Corporation, 1976: **51**
FF Karton Just van Rossum, 1992: **189**
Kaufmann Max R. Kaufmann, 1936: **191**
Kigali Arthur Baker, 1994: **33**
FF Kievit Mike Abbink, Paul van der Laan, 2001: **105**
Künstler Script Hans Bohn, 1957: **71**
- L**
Letter Gothic Roger Roberson, 1956: **19, 121**
FF Letter Gothic Slang Susanna Dulkinys, 1999: **49**
Lithos Carol Twombly, 1989: **51**
Lo-Res Emigre, Emperor, Oakland Zuzana Licko, 2001 (1985): **183**
LoType Erik Spiekermann 1979 (Louis Oppenheim 1913): **115**
Lucida Kris Holmes, Charles Bigelow, 1985: **19, 75, 124, 179**
Lyon Kai Bernau, 2009: **54, 73**
- M**
Magneto Leslie Cabarga, 1995: **195**
FF Mark Hannes von Döhren, FSI Team, 2013: **117, 169**
Marlik Borna Izadpanah, Fiona Ross: **209**
Matrix Zuzana Licko, 1986: **71**
Memphis Rudolf Weiss, 1929: **55**
Mercedes Edenspiekermann, 2020: **41**
Mesquite Kim Buker, Barbara Lind, Joy Redick, 1990: **43, 44**
FF Meta Erik Spiekermann, 1985-1991: **40, 41, 69, 101, 105**
FF Meta Serif E. Spiekermann, Kris Sowersby, Christian Schwartz, 2007: **179**
FF Meta Hebrew Oded Ezer, Erik Spiekermann: **209**
Mini 7 Joe Gillespie, 1989: **59**
Minion Robert Slimbach, 1992: **104, 152, 169**
FF Mister K Julia Sismäläinen, 2008: **54, 197**
Mistral Roger Excoffon, 1955: **49, 193**
Mrs. Eaves Zuzana Licko, 1996: **71**
Myriad Carol Twombly, Robert Slimbach 1992: **105, 107**
Mythos Min Wang, Jim Wasco, 1993: **33**
Neon Stream Leslie Cabarga, 1996: **194**
- N**
Neutronik Mark Frömberg, 2020: **207**
News Gothic Morris Fuller Benton, 1908: **69, 169**
Nugget Ken Barber, 2001: **37**
- O**
OCR B Adrian Frutiger, 1968: **19**
FF OCR F Albert-Jan Pool, 1995: **21**
ITC Officina Erik Spiekermann, 1990: **19, 53, 69, 121, 169**
Ottomat Claudio Piccinini, 1995: **49**
- P**
Palatino Hermann Zapf, 1952: **67, 115**
ITC Peecol Kai Vermehr, Steffen Sauerteig, 1998: **37**
Poetica Robert Slimbach, 1992: **55**
Poppi Martin Friedl, 2003: **99**
Poplar Kim Buker, Barbara Lind, Joy Redick, 1990: **53, 95**
Poynter Tobias Frere-Jones, 1997: **63**
FF Profile Martin Wenzel, 1999: **69**
FF Providence Guy Jeffrey Nelson, 1994: **193**
Proxima Sans Mark Simonson, 1994-2005: **179**
- Q**
FF Quadrata Fred Smeijers, 1992: **91**
- R**
Rad John Ritter, 1993: **33**
FF Real Erik Spiekermann, Ralph Du Carrois, 2014
Reporter C. Winkow, 1938: **115, 193**
Recursive Nick Sherman: **185**
Rhode David Berlow, 1997: **93**
Roboto Sans, Christian Robertson, 2011: **183, 186**
Rosewood Kim Burkler Chansler, 1992: **33**
Rotis Otl Aicher, 1989: **121**
Runic Condensed Monotype Corporation, **1935: 47**
- S**
Sabon Jan Tschichold, 1966: **55**
FF Sari Hans Reichel, 1999: **95**
Sassoon Primary Rosemary Sassoon, 1990: **41**
FF Scala Martin Majoor, 1996: **71, 109**
PTL Skopex Gothic Andrea Tinnes, 2006: **69**
Snell Roundhand Matthew Carter, 1965: **43, 44, 71**
Source Sans Paul D. Hunt, 2012: **179**
ITC Souvenir® Ed Benguiat, 1977: **45**
Spartan Classified John Renshaw, Gerry Powell, 1939: **41**
- Stempel** **Schneidler** F.H.E. Schneidler, 1936: **45, 65**
Stencil Robert Hunter Middleton, 1937: **189**
Stencil Gerry Powell, 1937: **189**
ITC Stone Sumner Stone, 1987: **121**
Streamline Leslie Cabarga, 1937: **191**
Studz Michael Harvey, 1993: **33**
FF Sub Mono Kai Vermehr, 1998: **37**
Suburban Rudy Vanderlans, 1993: **71**
Suomi Hand Tomi Haaparanta, 2008: **197**
Swift Gerard Unger, 1985: **41, 133, 154**
Syntax Hans-Eduard Meier, 1995: **51**
- T**
Tagliente **Initials** Judith Sutcliffe, 1990: **33**
Teak Foundry **Five: 209**
Tekton David Siegel, 1990: **43, 44, 109**
Tempo Robert Hunter Middleton, 1940: **95**
Tenacity Joe Gillespie, 2001: **75**
Tern Ralph du Carrois, Erik Spiekermann, 2010: **23**
Theinhardt François Rappo, 2009: **73**
Thesis Luc(as) de Groot, 1996: **69, 85, 105**
Times New Roman Stanley Morison, Victor Lardent, 1931: **21, 59, 63, 67, 169, 177**
FF Tisa Mitja Miklavčič, 2008: **179**
Trajan Carol Twombly, 1989: **29**
FF Transit MetaDesign, 1994: **25**
Transport Margaret Calvert, Jock Kinneir, 1957: **23**
FF Trixie Erik van Blokland, 1991/2011: **189, 197**
FF Typestar Steffen Sauerteig, 1999: **75**
- U**
FF Unit Erik Spiekermann, Christian Schwartz, 2003: **95, 169, 208**
Univers Adrian Frutiger, 1957: **53, 67, 85, 89, 115, 123, 127, 169**
- V**
Verdana Matthew Carter, 1996: **19, 21, 75, 167**
Vialog Werner Schneider, Helmut Ness, 2002: **25**
- W**
Berthold **Walbaum** Günter Gerhard Lange, 1976 (Justus Erich Walbaum 1815): **55, 131, 141**
Monotype **Walbaum** Charles Nix, Carl Crossgrove, Juan Villanueva, 2018 (Justus Erich Walbaum 1815): **131, 141**
Wayfinding **Sans** Ralf Herrmann, 2012: **25**
ITC Weidemann Kurt Weidemann, 1983: **41**
Weiss Rudolf Weiss, 1926: **107**
Wilhelm **Klingspor** **Gotisch** Rudolf Koch, 1925: **55**
- Z**
FF Zapata Erik van Blokland, 1997: **41**
Zebra **wood** Kim Burke Chansler, 1992: **33**

-  **Cover Design:**
Erik Spiekermann, Berlin
Sheep drawing courtesy of csaimages.com
-  **6 Street sign 2018**
Photo: Göran Söderström, Stockholm
-  **8 Paul Watzlawick**
You cannot not communicate.
-  **10 Salt & pepper**
Photo: Norman Posselt, Berlin
-  **12 Newspapers 2013**
Photo: Norman Posselt, Berlin
-  **14 USA Today**
Photo: Ferdinand Ulrich, Berlin

-  **16 Labels**
Typographic design:
Thomas Nagel,
San Francisco
-  **18 Forms**
Photo:
Ferdinand Ulrich,
Berlin
-  **20 Eggs**
Photo:
Norman Posselt,
Berlin
-  **22 British freeway sign**
Courtesy of
Henrik Kubel
-  **22 Cuban freeway sign**
Photo:
Ferdinand Ulrich,
Havana
-  **24 Düsseldorf Airport**
Photo:
Stefan Schilling,
Cologne
-  **26 Tallulah Bankhead**
There is less
in this than
meets the
eye.
-  **28 Trajan Column, Rome**
Photo:
Victoria & Albert
Museum, London
-  **30 Hypnerotomachia Poliphili**
Source: Octavo Digital
Rare Books
-  **32 Handwriting samples**
From the library of
Jack W. Stauffacher,
San Francisco

-  **34 Winter tree**
Photo:
Peter de Lory,
San Francisco
-  **36 www**
Typographic design:
Julie Heumüller,
Berlin
-  **38 Sigmund Freud**
-  **42-44 Shoes**
Photo:
© Adobe Systems
-  **46 Doubt**
Photo:
Dennis Hearne,
San Francisco
Model: Megan Biermann
-  **48 Surprise**
Photo:
Dennis Hearne,
San Francisco
Model: Megan Biermann
-  **50 Joy**
Photo:
Dennis Hearne,
San Francisco
Model: Megan Biermann
-  **52 Anger**
Photo:
Dennis Hearne,
San Francisco
Model: Megan Biermann
-  **56 Albrecht Dürer:**
Underweysung der
Messung
Source: Octavo Digital
Rare Books
-  **58 Washing machine**
Photo:
Erik Spiekermann,
Berlin

-  **60 Gerry Mulligan**
The best part
about playing
the saxophone
is that you don't
have to lug
around a
saxophone.
-  **62 Travel**
Styling:
Susanna Dulkinys
Photo:
Max Zerrahn, Berlin
-  **64 Vacation**
Styling:
Susanna Dulkinys
Photo:
Max Zerrahn, Berlin
-  **66 Business**
Styling:
Susanna Dulkinys
Photo:
Max Zerrahn, Berlin
-  **68 Work**
Styling:
Susanna Dulkinys
Photo:
Max Zerrahn, Berlin
-  **70 Formal**
Styling:
Susanna Dulkinys
Photo:
Max Zerrahn, Berlin
-  **72 Trendy**
Styling:
Susanna Dulkinys
Photo:
Max Zerrahn, Berlin
-  **74 Mosaic subway type**
Photo:
Ferdinand Ulrich,
New York
-  **76 Number plate**
Photo:
Erik Spiekermann,
Berlin
-  **78 Sherlock Holmes**
No Watson.
This was
not done
by accident,
but by design.

-  **80 Article**
Typographic design:
Erik Spiekermann,
Berlin
-  **82 Advertisement**
Photo:
Dennis Hearne,
San Francisco
-  **84 Announcement**
Typographic design:
Ferdinand Ulrich,
Berlin
-  **86 Corporate Report**
Typographic design:
Erik Spiekermann,
Berlin
-  **88 Order Form**
Typographic design:
Erik Spiekermann,
Berlin
-  **90 Pamphlet**
Typographic design:
Erik Spiekermann,
Berlin
-  **92 Ad**
Typographic design:
Julie Heumüller,
Berlin
-  **94 Newspaper**
Typographic design:
MetaDesign,
San Francisco
-  **96 Free fonts**
Photo:
Norman Posselt,
Berlin
-  **98 Symbol sets**
Typographic design:
Julie Heumüller,
Berlin



100 Arrow
Photo: Ferdinand Ulrich, Havana



102 Louis Oppenheim



104-108 John, Paul, George & Rita
Photo: Dennis Hearne, San Francisco



110 The Trapp Family
Photo: James McKee © World Wide Photo



112 Guitars
Photo: Dennis Hearne, San Francisco



114 Braun Stereo
Photo: Erik Spiekermann & Ferdinand Ulrich, Berlin



116 Features
Photo: Oote Boe © Plainpicture, Hamburg



118 Typefaces Used
Typographic design: Julie Heumüller, Berlin



120 The Lawrence Welk Family
Photo: © The Bettmann Archives



122 The Concert (c. 1550)
© The Bridgeman Art Library



124 Tuba player
Photo: James McKee © Wide World Photo



126 Dad's metronome
Photo: Ferdinand Ulrich, Berlin



128 Orchestra
Photo: © Plainpicture/Cultura, Hamburg



130 Small book
Alexander Nagel, photographed by Norman Posselt, Berlin

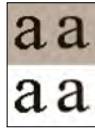

132 Anti-aliasing
Photo: Ralf Weissmantel, Berlin



134 Frederic Goudy



136 Tree plantation
Photo: © Pearson



138 Summer tree
Photo: Peter de Lory, San Francisco



140 Marathon runners
Photo: © Plainpicture, Hamburg



142 Sprinters
Photo: Julian Finney © Getty Images, Photonica World



144 Traffic jams in LA/ Freeway night
© iStock by Getty Images/ © Plainpicture/ponton Hamburg



146 Traffic lanes
Photo: © iStock by Getty Images



148 Cars on highway
Photo: Alex Maclean © Getty Images, The Image Bank



150 City traffic
Photo: © fStop



151 Noise
Photo: Michael Balgavy, Vienna



154 Gerard Unger



156 Bedroom
Photo: Dennis Hearne, San Francisco



158 Living room
Photo: M. Helfer © Superstock



160 Hotel lobby
Photo: Dennis Hearne (at Hotel Triton), San Francisco



162 Kitchen
Photo: M. Helfer © Superstock



164 Typing pool
Photo: © Historical Pictures/ Stock Montage



166 Edenspiekermann
Berlin
Photo: Edenspiekermann



170 Twins
Photo: © iStock by Getty Images



172 Paul Klee



174 Erik's e-mail
Photo: Erik Spiekermann, Berlin



176 New York Times
Photo: Norman Posselt, Berlin

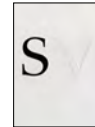

178 Letterpress
Photo: Norman Posselt, Berlin



180 Andrew S Tanenbaum



182 Variable Jacket
Photo: Norman Posselt, Berlin



184 Recursive specimen
Stephen Nixon



186 Variable fonts
Erik Spiekermann, Berlin



188 Groucho Marx



190 Stencils & stamps
Photo: Susanna Dulkins, Berlin

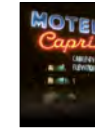

192 Neon signs
Photo: Nari Haase, San Francisco



194 Chalk board type
Photo: Ferdinand Ulrich, London



196 Vernacular type
Photo: Erik Spiekermann, San Francisco

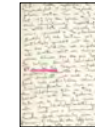

198 Kafka's handwriting
Franz Kafka, Historisch-Kritische Ausgabe sämtlicher Handschriften, Drucke und Typoskripte. Hrsg. v. Roland Reuß u. Peter Staengle, Oxforder Quartette 1 & 2 (Stroemfeld Verlag: Frankfurt am Main, Basel 2001)



200 Letterpress @ p98a
Photo: Norman Posselt, Berlin



202 Specimens of Chromatic Wood Type, Borders & C.
Courtesy of Nick Sherman



204 Chinese type
Photo: Norman Posselt, Berlin



206 Korean type
Metal printing types in Hangeul, the extraordinary Korean alphabet: Seoul, 2007, p. 15



208 Global scripts
Photo: Ferdinand Ulrich, Berlin



210 Repro
Erik Spiekermann, Berlin



212 Yogi Berra



214-216 Sheep library
Photo: Norman Posselt, Berlin



Thank you, danke, grazie:

Everyone needs access to the power of great type.

Type has a major impact on the way we experience and communicate with the world everyday. It can be moving, or define a movement. It can evoke an emotion, or provoke a reaction. It can unite people together, or it can celebrate our differences. It can be beautiful, or useful – or both!

Google Fonts makes it easy for you to bring personality and performance to whatever you're creating – wherever you are.

At Google Fonts, we help make the web (and the world) more beautiful, fast, and open through great typography and iconography. We're continuously growing our catalog of open-source fonts and icons by partnering with some of the world's most talented type designers and foundries.

Together with this diverse community of type lovers, we're adding not just more variety to fonts.google.com, but also more language and accessibility support.



This edition of the SHEEP BOOK is published by TOC – THE OTHER COLLECTION.

TOC is the product of our belief that important literature deserves books made of the finest materials, using the most sophisticated printing techniques. At a time when most reading has become a fleeting experience, we will create a more permanent space for important thoughts and ideas, by lodging them in handsomely printed books. Our books – placed on a curated bookshelf – will be a quiet place in today’s information pandemonium. But we shall also choose books that spur lively dialogue with other readers. TOC focuses on contemporary literature, books that will form the canon of the future.

The books are printed letterpress in limited editions, signed and numbered – individually designed to enhance each text.

The sheep book is TOC’s first venture from literature into the non-fiction world. We justify this by the subject of this book, which must also be close to the hearts of our traditional readers.

TOC was started and is run by Susanna Dulkyns, Erik Spiekermann, and Birgit Schmitz.



THERE ARE MANY things to consider when picking a printer for a book that is aimed at the critical eyes of designers.

Quality is the top criterium. A printer who has the latest hi-tech printing equipment, finishing and binding, and dedication to service.

There would be several candidates, all colleagues whom we have worked with in the past and whom we'll turn to again in the future.

Then there is the location. This book was mostly written and designed in Berlin, Germany, so a local printer would have made things easy. But who wants easy when you have friends in a place worth a journey, even if that takes you across the Alps?

Over the years, we established a relationship with our friends at *Tipoteca Italiana*. Tipoteca is the most splendid museum of traditional letterpress type and machinery anywhere. It was founded by Silvio Antiga, one of four brothers who also run *Grafiche Antiga* (sic) in Crocetta del Montello, Veneto.

So we decided to combine expertise, friendship, travel, and a little adventure to work with our friends in Italy to print a book written in English by a German author.

Did I mention that Tipoteca have their own restaurant?

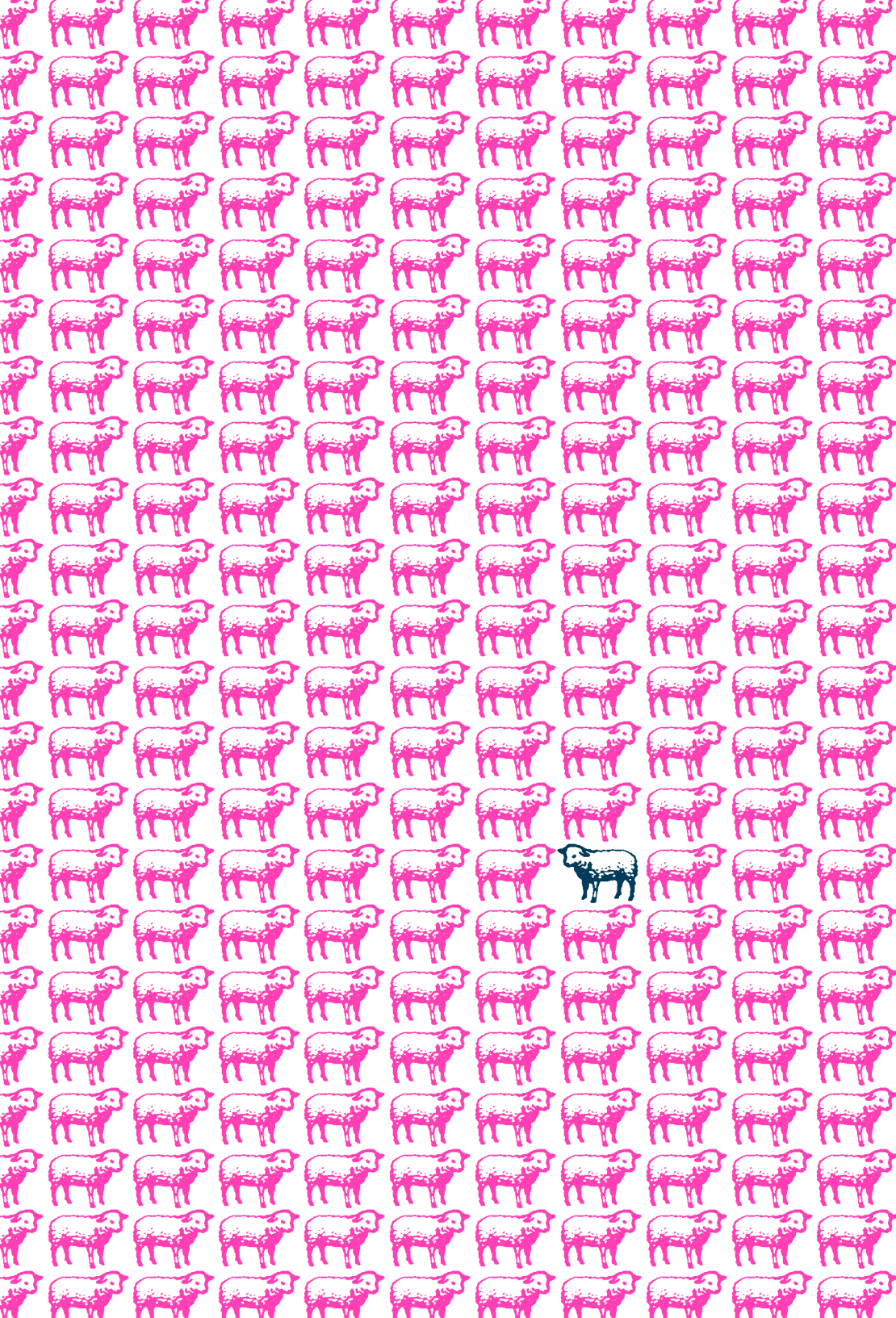

Für die Zier- und Auszeichnungsschriften, können etwa sechs oder acht Grade genügen. Die meisten Schriften werden heute in fünfzehn bis zwanzig Graden verlangt

CASLON IONIC · PAUL BARNES, GREG GAZDOWICZ · COMMERCIAL CLASSICS · 2019

Фёдор Миха́йлович Достоёвский (30 октября [11 ноября] 1821, Москва, Российская империя — 28 января [9 февраля] 1881, Санкт-Петербург, Российская империя)

FF CASUS · EUGENE YUKECHEV · FONTFONT · 2016

Jede Schrift wird in mehreren Graden geschnitten. Für Auszeichnungs- und Zierschriften können etwa sechs oder acht Grade genügen. Die meisten Schriften werden heute

DUNBAR TEXT · CJ DUNN · CJ TYPE · 2016

Eine der folgenreichsten Taten in der Menschheitsgeschichte ist die Erfindung des Alphabets. Sie gelang um 1500 v. Chr. einem phönikischen Kaufmann.

EAMES CENTURY MODERN · ERIK VAN BLOKLAND · HOUSE INDUSTRIES · 2010

A Boeing jet at Hamburg Airport, ready to take off for a non-stop flight to New York: That is the modern way of getting there quickly, one jump ahead they feel that

EDIT SERIF PRO REGULAR · CHRISTOPH DUNST · ATLAS FONT FOUNDRY · 2017

The man in the street speaks of twenty-six letters of the alphabet. The printer knows that there are lower case and upper case, ligatures, accented letters, numerals, signs

EQUITY · MATTHEW BUTTERICK · MB TYPE · 2011

Another feature I particularly like is the ingenious way in which you have placed your hydraulic unit into a welded steel tank underneath the table to the rear of

FABRIKAT MONO MEDIUM · CHRISTOPH KOEBERLIN · HVD FONTS · 2017

تیبوتیک مؤسسه متخصصه فی صناعة الخطوط،
مقرّها لاهای، فی هولندا. نعمل علی تصمیم خطوط
لنظامی ماکنتوش وای بی إم وتسویقها. لقد أخذنا علی

FEDRA ARABIC · PETER BILAK · TYPOTHEQUE · 2007

Die führenden Typografen sind von jeher für die Schrift als Hauptelement der Drucksache eingetreten. Es ist aber nicht das zeitlose Gesetz allein, das den Verantwortungsbewussten

GRAPHIK REGULAR · CHRISTIAN SCHWARTZ · COMMERCIAL TYPE · 2009

Et c'est alors que j'ai rencontré un industriel du bassin liégeois, constructeur de machines pour l'industrie textile. Bien sûr, des machines de ce genre, on en vend en Belgique, mais il est

GRÄBENBACH REGULAR · WOLFGANG SCHWÄRZLER · CAMELOT TYPEFACES · 2016

Die Papiermacher früher hatten es nicht leicht, denn sie standen im Wettbewerb mit dem Pergament, welches zwar teuer war, aber Künstlern vorteilhafter erschien.

FF HERTZ BOOK · JENS KUTÍLEK · FONTFONT · 2015

Es war noch Nacht, als er erwachte, die Dunkelheit aber schien verdünnt, im Begriff, grau zu werden. Er hatte traumlos und tief geschlafen, jetzt aber hatten Hunger und Kälte

LYON REGULAR · KAI BERNAU · COMMERCIAL TYPE · 2009

Es war noch Nacht, als er erwachte, die Dunkelheit aber schien verdünnt, im Begriff, grau zu werden. Er hatte traumlos und tief geschlafen, jetzt aber hatten Hunger und Kälte

LYON REGULAR NO. 2 · KAI BERNAU · COMMERCIAL TYPE · 2009

Mon constructeur se donne donc beaucoup de mal. Il écrit force lettres, il envoie des imprimés et notamment un catalogue. Bien entendu ce catalogue illustré a été

QUESTA REGULAR · MARTIN MAJLOOR, JOS BUIVENGA · THE QUESTA PROJECT · 2017

Edel sei der Mensch, hilfreich und gut! Denn das allein unterscheidet ihn von allen Wesen, die wir kennen. [...] Der edle Mensch sei hilfreich und gut! Unermüdet

QUESTA SANS REGULAR · MARTIN MAJLOOR, JOS BUIVENGA · THE QUESTA PROJECT · 2017

While a number of excellent theoretical treatises, covering the work of observers both in this country and abroad, have appeared in literature of recent years, most of these

FF REAL TEXT BOOK · ERIK SPIEKERMANN, RALPH DU CARROIS · FONTFONT · 2014

Die Fotografie ist heute zu einer Wissenschaft geworden. Die Technik allein kommt mit Empirie aus, doch die Wissenschaft nicht mehr. Ihre Grundlage ist die mathe-

ROMAIN 20 REGULAR · ALICE SAVOIE · 205TF · 2020

Keine Wissenschaft ist für eine geografische Forschungsreise so wichtig wie die Geologie. Das war auch die große Stärke der schwedischen Polarfahrten. Expeditionsreise nach dem

TABLET GOTHIC REGULAR · VERONIKA BURIAN, JOSÉ SCAGLIONE · TYPETOGETHER · 2012

Das Holz ist auch ein guter Werkstoff, so dass sich ein Holzschnitt sehr gut zum unmittelbaren Druck verwenden lässt, wenn eine kleine Auflage in Frage

WALBAUM 6 PT REGULAR · CHARLES NIX, CARL CROSSGROVE, JUAN VILLANUEVA · MONOTYPE · 2018

As the gorgeous but now forgotten light of the afternoon waned, I sat on the stone steps of the chapel, baffled and brooding. Then something stirring in the

WILLIAM TEXT REGULAR · MARIA DOREULI · TYPOTHEQUE · 2016

We don't know how many typefaces are out there – the number is certainly in the hundreds of thousands. When we published the last printed FontBook at FontShop in Berlin, back in 2006, the book showed some 32,000 faces on 1700 pages and it weighed 3 kg. This little volume with its mere 240 pages never intended to be a type specimen. When it came to illustrating how type works, we stuck to a lot of the undisputed classics. Whatever else may happen in type and typography, Garamond, Bodoni, Futura and Helvetica defined new categories when they appeared and will never be forgotten.

We have included quite a few new typefaces since Sheep 3.0 was published in 2014, but only where they helped illustrate the topics in the chapters. And then we realized that a lot of our favorites were missing – type we had been using in the p98a studio, type made by good friends, as well as typefaces that crossed categories, questioned existing wisdom and often just made us happy.

Here is an overview of contemporary display typefaces, some of which we have used in recent years, while others are lined up for future projects, and some that we think are just cool. We'll probably never be able to use them all in a commercial project, but it's good to have new type to look forward to.

The choice of words echo the classic printed specimens. Each line for the display sizes has to show the most significant characters and fill the column width. The occasional in-joke makes the work more fun.

The showings on the right have all been set to the same cap-height which shows that type size is a very unreliable measurement for visual comparison.

The text settings on the previous page have been adjusted to show the same x-height because that is the only way to judge type for continuous text. In a book written and set in English, it may appear redundant to show text in other languages. But type looks different set in different languages and we should celebrate those differences, even if we cannot read the words. In fact: the less we can understand, the closer we look at the shapes.

Santiago Bernabéu

FF REAL HEAD EXTRABOLD · ERIK SPIEKERMANN, RALPH DU CARROIS · FONTFONT · 2014

Handliche Bibliothek

WALBAUM 60 REGULAR · CHARLES NIX, CARL CROSSGROVE, JUAN VILLANUEVA · MONOTYPE · 2018

Belgian Waffles \$7⁵⁰

CANELA · MIGUEL REYES · COMMERCIAL TYPE · 2018

L'archéologie du savoir

INFINI BOLD · SANDRINE NUGUE · GRAPHISME EN FRANCE · 2014

bits pieces

BITCOUNT · PETR VAN BLOKLAND · TYPETR · 2018

Saint-Jean-Baptiste de

LYON DISPLAY · KAI BERNAU · COMMERCIAL TYPE · 2010

Back to the roots '57

NEUE HAAS GROTESK BOLD · MAX MIEDINGER, CHRISTIAN SCHWARTZ · LINOTYPE · 2010

SPRING FASHION

HESSE ANTIQUA · GUDRUN ZAPF VON HESSE, FERDINAND ULRICH, BERND VOLMER · MONOTYPE · 2018

Ober- und unterlängen

DUNBAR LOW, DUNBAR TALL · CJ DUNN · CJ TYPE · 2016

St. Louis, Missouri

EAMES CENTURY MODERN STENCIL · ERIK VAN BLOKLAND · HOUSE INDUSTRIES · 2010

arquitectos del siglo

ORIENTATION · SANDRINE NUGUE · COMMERCIAL TYPE · 2018

JUBILÄUMSJAHR

ALFARN · CÉLINE HURKA · ADOBE FONTS · 2018

Das Kommunistische Manifest

CARLMARX · HIDETAKA YAMASAKI · ADOBE FONTS · 2018

#MuseumfürGestaltung

JOSCHMI · FLAVIA ZIMBARDI · ADOBE FONTS · 2018

SHEREMETYEVO →

INSTITUT · VYACHESLAV KIRILENKO, GAYANEH BAGDASARYAN · BROWNFOX · 2013

ETNA & VESUVIO

TIPOTECA SERIES · ULRIKE RAUSCH · ADOBE FONTS · 2019

PANTOGRAFISCH GESEHEN

HTW ARTZ · ERIK SPIEKERMANN · P22 · 2013

GRIMMERMANT & GRIMME

HOBEAUX ROCOCEAUX · JAMES EDMONDSON · OH NO TYPE COMPANY · 2016

■ ● ▲ ▽ ○ □ ↶ ↷ ↸ ↹

FUTURA SCHMUCK · PAUL RENNER · BAUER · 1930

Best Kölsch from Nancy

FUNFAIR · LOUIS OPPENHEIM, FERDINAND ULRICH, NORMAN POSSELT