

# Display Controller



## User Guide

Windows 7, Windows 8.1 and Windows 10

**Barco NV**

Beneluxpark 21, 8500 Kortrijk, Belgium  
[www.barco.com/en/support](http://www.barco.com/en/support)  
[www.barco.com](http://www.barco.com)

**Registered office: Barco NV**

President Kennedypark 35, 8500 Kortrijk, Belgium  
[www.barco.com/en/support](http://www.barco.com/en/support)  
[www.barco.com](http://www.barco.com)

# Table of contents

<b>1</b>	<b>Welcome!</b> .....	<b>7</b>
1.1	About the product.....	8
1.2	What's in the box.....	8
<b>2</b>	<b>Display Controller installation</b> .....	<b>9</b>
2.1	Which Display Controller ? .....	10
2.2	Installing a Barco Display Controller .....	10
2.3	Installation procedure .....	11
2.4	Connecting your Barco Displays .....	12
2.5	Dongles .....	13
2.5.1	Passive Single-Link Dongle .....	14
2.5.2	Active Single-Link Dongle .....	14
2.5.3	Active Dual-Link Dongle.....	14
2.6	Shipping the Barco Display Controller .....	14
<b>3</b>	<b>Driver and software installation</b> .....	<b>17</b>
3.1	Introduction.....	18
3.2	Installation procedure .....	18
3.3	Silent installation .....	19
3.4	Installation options .....	20
3.5	After installation .....	20
3.6	Uninstallation.....	21
<b>4</b>	<b>Configuring Barco displays in Windows</b> .....	<b>23</b>
4.1	Display resolution .....	24
4.2	Software rotation .....	24
4.3	Night light.....	25
<b>5</b>	<b>Driver and Intuitive Workflow Tools</b> .....	<b>27</b>
5.1	Barco System Settings Control Panel .....	28
5.1.1	Description.....	28
5.1.2	Operation.....	29
5.2	Application Appearance Manager .....	30
5.2.1	Description.....	30
5.2.2	Operation.....	30
5.2.3	Configuration .....	31
5.3	Color and Grayscale Depth .....	31
5.3.1	Description.....	31
5.3.2	Operation.....	31
5.3.3	Configuration .....	31
5.4	Conference CloneView™ .....	32

5.4.1	Description.....	32
5.4.2	Operation.....	32
5.4.3	Configuration .....	33
5.5	DimView™ .....	33
5.5.1	Description.....	33
5.5.2	Operation.....	33
5.5.3	Configuration .....	33
5.6	Film Clip .....	33
5.6.1	Description.....	34
5.6.2	Operation.....	34
5.6.3	Configuration .....	34
5.7	FindCursor™ .....	34
5.7.1	Description.....	34
5.7.2	Operation.....	35
5.7.3	Configuration .....	35
5.8	I-Luminate™ .....	35
5.8.1	Description.....	35
5.8.2	Operation.....	35
5.8.3	Configuration .....	35
5.9	Reading Environment.....	36
5.9.1	Description.....	36
5.9.2	Operation.....	36
5.9.3	Configuration .....	36
5.10	Screen Capture.....	37
5.10.1	Description.....	37
5.10.2	Operation.....	37
5.10.3	Configuration .....	37
5.11	SingleView™ .....	38
5.11.1	Description.....	38
5.11.2	Operation.....	38
5.11.3	Configuration .....	38
5.12	SmartCursor™ .....	38
5.12.1	Description.....	38
5.12.2	Operation.....	39
5.12.3	Configuration .....	39
5.13	SoftGlow™ .....	39
5.13.1	Description.....	39
5.13.2	Operation.....	39
5.13.3	Configuration .....	40
5.14	SpotView™ .....	40
5.14.1	Description.....	40
5.14.2	Operation.....	40
5.14.3	Configuration .....	41
5.15	Touchpad gestures.....	42
5.15.1	Description.....	42
5.15.2	Operation.....	42
5.15.3	Configuration .....	43
5.16	VirtualView™ .....	43
5.16.1	Description.....	43
5.16.2	Operation.....	44
5.16.3	Configuration .....	44
<b>6</b>	<b>Important information .....</b>	<b>45</b>
6.1	Safety information.....	46

6.2	Environmental information.....	46
6.3	Regulatory compliance information.....	48
6.4	Explanation of symbols.....	49
6.5	Legal disclaimer.....	51
6.6	Technical specifications.....	51



**Welcome!**

**1**

## 1.1 About the product

### Display Controller

Thank you for choosing this Barco Display Controller!

Barco's state-of-the-art Display Controllers deliver the performance, quality and stability required for today's advanced medical imaging applications. The powerful boards ensure ultra-fast and smooth image loading, and graphics processing of images in every resolution.

Use the instructions in this guide to install your Barco Display Controller.

## 1.2 What's in the box

### Contents

Your Barco Display Controller comes with:

- This Barco Display Controller User Guide
- 1 extender bracket is included with the MXRT-7600.
- 2 Single-Link Dongles are included with the MXRT-4500, MXRT-5500 & MXRT-7500.
- 1 low-profile bracket is included with the MXRT-2400, MXRT-2500 & MXRT-2600.
- 1 DMS-59-to-DVI adapter cable and 1 low-profile bracket are included with the MXRT-1450 & MXRT-1451.



Keep your original packaging. It is designed for this Display Controller and is the ideal protection during transport and storage.



# Display Controller installation

# 2

## 2.1 Which Display Controller ?

### Display Controller range

Your Barco medical display is compatible with a large range of Barco Display Controller boards. Depending on the order details, the display can be delivered with or without a Display Controller.

If you are installing a Barco Display Controller, please follow the installation instructions in this section.

Barco displays are compatible with a limited set of non-Barco display controllers. If you are installing a non-Barco display controller, please consult its corresponding documentation.

## 2.2 Installing a Barco Display Controller

### Guidance

This chapter will guide you through the physical installation of a Barco Display Controller for your display system.



**WARNING:** Wear a grounded, protective ESD strap when handling or during installation of the Display Controller. Electrostatic charges can damage the Display Controller.

### Overview

Prior to installing the Barco Display Controller(s) for your Barco Display System in your workstation, please take a few minutes to familiarize yourself with the Display Controller(s) and the PCIe slots.

### Types of Display Controllers for Barco Display Systems

The following models of Barco Display Controllers are available for your display system. Please check which of the following models is delivered with your system and follow the corresponding installation instructions:

Barco Model	Compatible PCIe Slot
Barco MXRT-1450	x1 <sup>1</sup> , x8, x16
Barco MXRT-1451	x1 <sup>1</sup> , x8, x16
Barco MXRT-2400	x16
Barco MXRT-2500	x16
Barco MXRT-2600	x16
Barco MXRT-4500 <sup>2</sup>	x16
Barco MXRT-5400	x16
Barco MXRT-5450	x16
Barco MXRT-5500	x16
Barco MXRT-5550	x16
Barco MXRT-5600	x16
Barco MXRT-7400	x16
Barco MXRT-7500	x16
Barco MXRT-7600	x16

### Which PCIe slot to use

The table above lists the various Display Controller model(s) available for your Barco Display System and the recommended PCIe slot to use for optimum performance. The figure below shows the different types of PCIe slots that can be used.

1: Recommended PCIe slot. You can also use x16 & x8 slots for x1 boards.  
 2: Available in limited markets

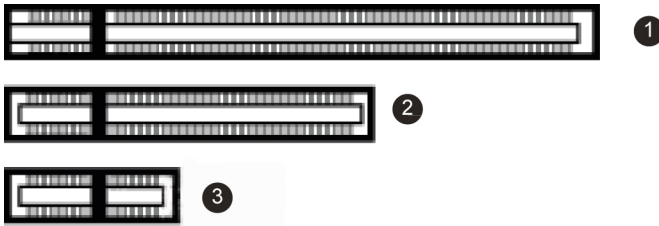

Image 2-1: Examples of PCIe slots

1. x16 slot
2. x8 slot
3. x1 slot

## 2.3 Installation procedure



**WARNING:** Wear a grounded, protective ESD strap when handling or during installation of the Display Controller. Electrostatic charges can damage the Display Controller.



If you are using a motherboard containing an on-board graphics solution and do not intend to use it as part of a multiple-display setup, disable it either in the computer's System Set-up utility (BIOS) or the Windows device manager.

### How to install

The following instructions will take you step by step through the installation of the Barco Display Controller(s) for your Barco Display System.

1. If you are not going to use your old Display Controller, uninstall its drivers and software.
2. Turn off the computer, display(s), and other peripheral devices.
3. Unplug the computer's power cord and disconnect all cables from the back of your computer.



**Warning:** Wait approximately 20 seconds after unplugging the power cord before disconnecting a peripheral or removing a component from the motherboard to avoid possible damage to the motherboard.

4. Remove the computer cover. If necessary, consult your computer's manual for instructions.
5. If necessary, unscrew or unfasten and remove any existing display controller(s) from your computer.
6. Locate the appropriate slot and, if necessary, remove the metal back-plate cover(s).
7. Align the Barco Display Controller(s) for your Barco Display System with the slot(s) and press it(them) in firmly until the card(s) is(are) fully seated.
8. Connect the power cable, available from the workstation vendor, to the 6-pin power connection on the Display Controller. Make sure the cables are not interfering with anything inside the computer (for example, a cooling fan).



**Tip:** This step only applies to the MXRT-7400, MXRT-7500 & MXRT-7600.

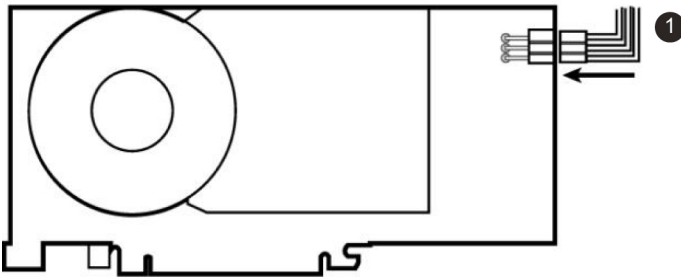

Image 2-2: Power connection for the MXRT-7400, MXRT-7500 & MXRT-7600 controllers

9. Screw in or firmly fasten the Display Controller. Replace and secure the computer cover.

## 2.4 Connecting your Barco Displays



For a detailed description of the display installation and signal connection, please refer to the Display User Guide.

### IO-Panel for the Barco MXRT-1450 & MXRT-1451

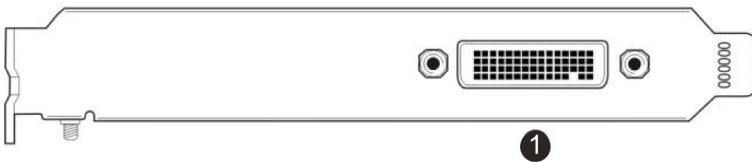

Image 2-3: MXRT-1450 & MXRT-1451

1. DMS-59 connector provides DVI-I / Head 1 & Head 2 output connections through included the Y-adapter cable.

### IO-Panel for the Barco MXRT-2400 & MXRT-2500

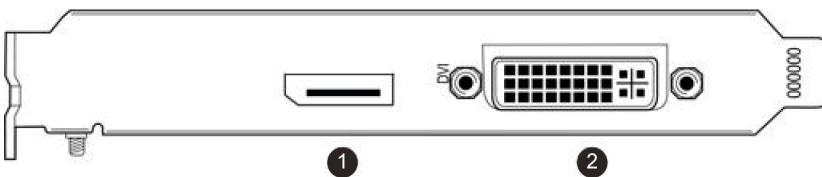

Image 2-4: MXRT-2400 & MXRT-2500

1. DisplayPort Connection
2. DVI-I Connection

### IO-Panel for the Barco MXRT-2600

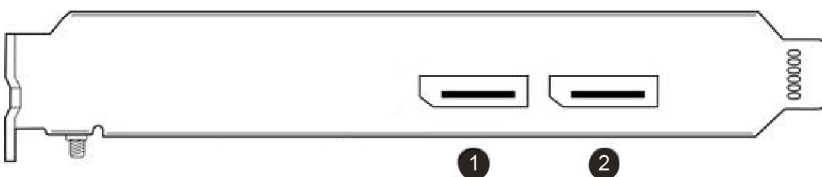

Image 2-5: MXRT-2600

1. DisplayPort #1

## 2. DisplayPort #2

### IO-Panel for the Barco MXRT-5450 & MXRT-5550

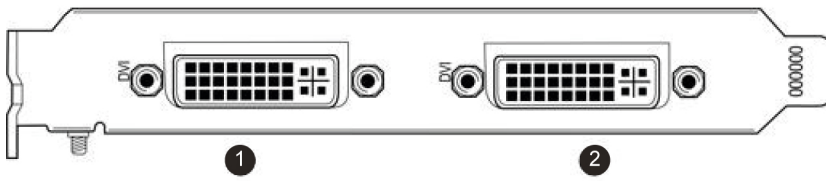

Image 2-6: MXRT-5450 & MXRT-5550

1. Head 1- DVI-I Connection
2. Head 2- DVI-I Connection

### IO-Panel for the Barco MXRT-4500, MXRT-5400, MXRT-5500 & MXRT-7400

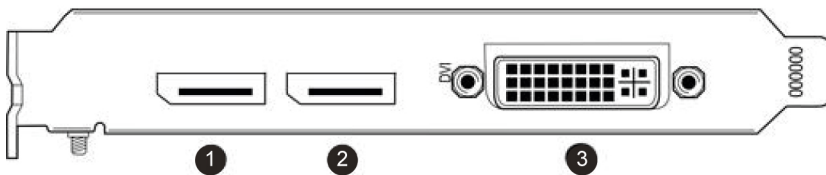

Image 2-7: MXRT-4500, MXRT-5400, MXRT-5500 & MXRT-7400

1. DisplayPort #1
2. DisplayPort #2
3. DVI-I

### IO-Panel for the Barco MXRT-5600, MXRT-7500 & MXRT-7600

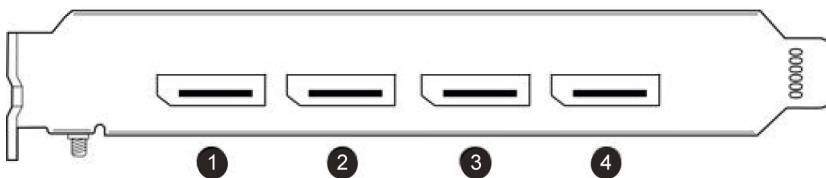

Image 2-8: MXRT-5600, MXRT-7500 & MXRT-7600

1. DisplayPort #1
2. DisplayPort #2
3. DisplayPort #3
4. DisplayPort #4

For displays with native DisplayPort input, use a native DisplayPort cable to connect the DisplayPort output of the Display Controller to the DisplayPort input of the display. You cannot connect the DVI output of a Display Controller to the DisplayPort input of a display.

## 2.5 Dongles

### About

Barco dongles are designed to allow Barco Display Controllers with a DisplayPort connector to a display with only a DVI input. All current Barco displays support direct DisplayPort connection.



If video cable conversion is not required, you may bypass this section.

Barco dongles are available for purchase independently.

## 2.5.1 Passive Single-Link Dongle

### About

The passive Single-Link Dongle converts DisplayPort input signals to single-link DVI output signals. It is compatible with all Barco grayscale displays and up to 2MP color models. For color displays of 3MP and greater resolutions, the Dual-Link Dongle is necessary.



Image 2-9: Single-Link dongle

1. To display Single-Link DVI cable
2. To DisplayPort connector on Barco Display Controller

## 2.5.2 Active Single-Link Dongle

### About

Barco Display Controllers are not compatible with third-party active single-link dongles. Please use Barco passive Single-Link dongles.

## 2.5.3 Active Dual-Link Dongle

### About

The active Dual-Link Dongle converts DisplayPort input signals to dual-link DVI output signals. Unlike the passive Single-Link dongle, the Dual-Link dongle allows higher resolutions (greater than 1920x1200) on color displays.



When using QAWeb software for calibration and quality assurance of a display connected through a Dual-Link dongle, a USB cable must also be connected to the display.



Image 2-10: Dual-Link dongle

1. To computer's USB port
2. To display via DVI Dual-Link cable
3. To DisplayPort connector on Barco Display Controller

## 2.6 Shipping the Barco Display Controller

### About

After the installation and validation of software components, Barco recommends removing the display controllers from the workstation and returning them to their original packaging prior to shipment.



Barco does not recommend shipping display controllers installed in the workstation.

If it is necessary to ship a controller installed in a workstation, the MXRT-7600 requires an extender bracket to protect against shock and vibration. Assemble the extender bracket as shown below. Refer to the workstation user documentation on proper installation to its card guide.

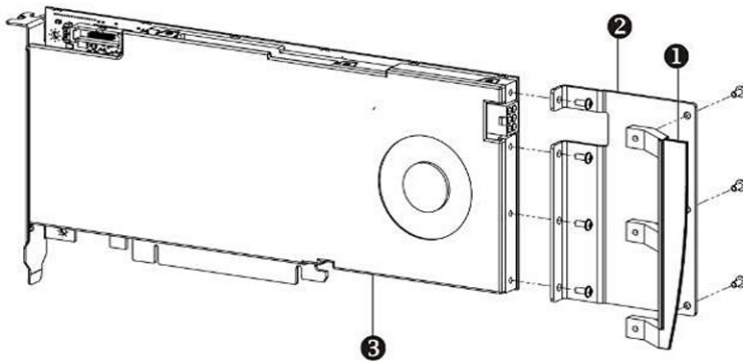

Image 2-11: MXRT-7600 Extender Bracket

1. Bracket
2. Extender
3. MXRT-7600





# Driver and software installation

# 3

## 3.1 Introduction

### About

This chapter will guide you through the installation of the drivers, software and documentation associated with your Barco Display System or Barco Display Controller(s).

### Prerequisites

Before starting the installation of the Barco drivers, software and documentation following prerequisites must be adhered:

- Your operating system must be installed and running. Following versions of Windows are supported:
  - Windows 7 (32-bit or 64-bit)
  - Windows 8.1 (64-bit)
  - Windows 10 (64-bit)
- You must be logged on as a user with local administrator privileges.
- All Barco displays must be connected to the appropriate Display Controller(s) in your system.



For optimal system performance, Barco recommends installing no more than two drivers on a system at one time. If the configuration will require three drivers, the Barco Driver Installer will alert the user to replace one board to eliminate one of the drivers.

- When there is a non-Barco board in the system, you must first install the driver for the non-Barco display controller before installing the Barco driver.



After each driver installation, you should reboot the system before proceeding with the installation of another driver.

You will need to install the Barco Display Controller system drivers and software in the following cases:

- After you have installed the Barco Display Controller(s) for your Barco Display System in your system for the first time.
- After you have reinstalled or upgraded your operating system.
- When upgrading to a newer version of the MXRT driver and software, manual uninstallation of the prior version is not necessary. The Barco Product Installation Wizard will detect any prior installations and start the uninstallation process automatically.



The installation dialog will display in English if your operating system's language is not supported.

## 3.2 Installation procedure

### Installation procedure

1. Start your system.

If you have a fresh OS installation, or you have uninstalled an existing driver, the OS may automatically install an inbox driver from the Windows driver store, either an AMD driver or a standard VGA driver, for the Barco Display Controller(s). If this occurs, the OS prompts you to restart your computer, click **Yes** to allow the automatic driver installation to complete and reboot the system.

2. Download the installer from the Barco public site for your controller, such as <https://www.barco.com/en/product/mxrt-5600>. Launch the Barco Product Installation Wizard by clicking **master\_setup.exe** in the Barco folder.
3. The first page of the installation wizard is the license agreement. You must accept the license agreement in order to proceed.
4. The second page of the installation wizard will show you the display controller driver and software components that will be installed. To accept the installation of default software components, click **Next**. To custom select software components, click on specific software components to unselect them.

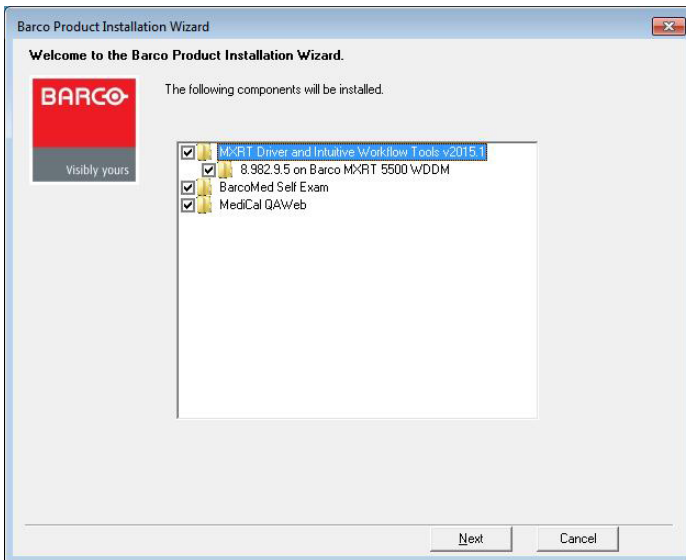

Image 3-1: Barco Product Installation Wizard

- **MXRT Driver and Intuitive Workflow Tools:** Barco MXRT Display Controller drivers and accompanying software for supporting Intuitive Workflow Tools
  - **BarcoMed Self Exam:** Barco diagnostic tool
  - **MediCal QAWeb Agent:** Barco calibration software
5. If a previous installation of an MXRT driver exists, the installation wizard will detect it and guide you through the uninstallation process if necessary.
  6. During installation, the desktop may flash, and the Installation Wizard window may appear on different displays. This is expected behavior.
  7. When the installation of all components has completed, the system must reboot to complete the changes, and an automatic reboot window will be displayed.

## 3.3 Silent installation

### Installation procedure

Navigate to the Barco installation folder and execute the command `master_setup.exe -silent`.

This can be done from the command shell, from the Run command, or from a command shortcut. The setup program will automatically install the drivers for any MXRT boards that are present, the BarcoMed Self Exam program, and QAWeb (if part of the installation package).

### Configure silent installation options

You can modify the `setup.ini` file at the Barco root folder to customize certain silent install behavior. The configurable options are listed in the [Custom] section of the `setup.ini` file.

#### Reboot

- Locate the **[Custom]** section of `setup.ini`.
- If set to Yes (default), the installer will prompt the user or launch a timer to reboot following software installation. If No, the prompt/timer is not shown.

## 3.4 Installation options

### Configure installation options

You can modify the setup.ini file at the Barco root folder to change the default setting of MXRT driver after either installation or silent installation.

#### Install driver in 24-bit

- Locate the **[MXRT\_WDDM]** section of setup.ini
- Remove **-30bit** command line parameter from both **Install** and **SilentInstall** lines
- Modify the default.ini file, found in:  
Barco\_MXRT\_Driver\_SoftwarePackage\_xxxx\Setup\_Barco\_Productivity\_Tools.x.x.x\  
Change `Color%20Depth\30BitDesktop` to **false**.

#### Install driver with Coronis Fusion displays in SingleView mode

- Locate the **[MXRT\_WDDM]** section of setup.ini
- Add **-singleview** command line parameter to the end of both **Install** and **SilentInstall** lines
- Modify the default.ini file, found in:  
Barco\_MXRT\_Driver\_SoftwarePackage\_xxxx\Setup\_Barco\_Productivity\_Tools.x.x.x\  
Change `SingleView\singleviewEnabled` to **true**.

#### Install driver with VirtualView enabled

- Locate the **[MXRT\_WDDM]** section of setup.ini
- Add **-virtualview** parameter to both **Install** and **SilentInstall** lines
- Modify the default.ini file, found in:  
Barco\_MXRT\_Driver\_SoftwarePackage\_xxxx\Setup\_Barco\_Productivity\_Tools.x.x.x\  
Change `VirtualView\FeatureEnabled` to **true**.

## 3.5 After installation

### Installation verification

To verify that the driver was installed, go to the **Windows Control Panel**, select **System**, select **Device Manager**, then select **Display Adapters**. Verify that Barco Display Controllers are properly identified, as shown below:

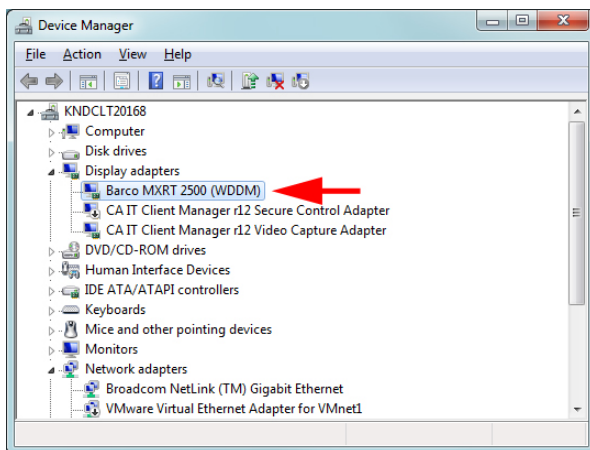

Image 3-2: Verifying driver installation

### Automatic display configuration

Once the drivers, software and documentation have been installed and the system has been rebooted, the computer should automatically detect your Barco displays and attach them to the desktop with the correct resolution. If the computer fails to detect your Barco displays or fails to attach them to the desktop correctly, please use the **Windows Screen Resolution** to set the correct resolution.

## Upgrade drivers

When performing a driver upgrade, the **Barco System Settings Control Panel** default profile will be applied. Any user profile that was saved on the system previously is still available and can be selected through the Barco System Settings Control Panel.

## 3.6 Uninstallation

### Uninstalling the drivers and software

To uninstall the Barco drivers, software or documentation for your Barco Display System, please use the **Windows Add/Remove Programs**. This can be found in the **Windows Control Panel** under **Programs & Features**.

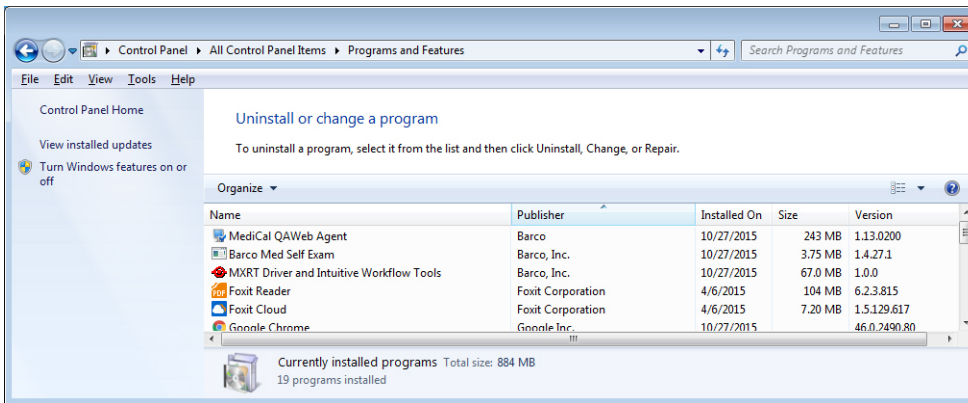

Image 3-3: Windows 7 Add/Remove Programs

### Barco System Cleaner

The Barco System Cleaner is a tool that will remove all Barco software components from your workstation. This includes the display driver, the accompanying software for supporting Intuitive Workflow features, BMSE, and QAWeb calibration software. The application can be found at **C:\Program Files\Barco**.



The Barco System Cleaner will remove all Barco components from your system. It is recommend to only use the System Cleaner under direction of Barco Customer Support.



# Configuring Barco displays in Windows

# 4

## 4.1 Display resolution

### Changing resolutions

1. Click on the **Configure Displays** button on the Barco System Settings Control Panel or right click on the desktop and select **Screen resolution** in Windows 7 and 8.1. This will open the Windows Control Panel shown in Image 4-1. In Windows 10, right click on the desktop and select **Display settings** to launch a control panel with similar functions but a different look and feel.
2. Click on the **Resolution** drop down box to show the list of resolutions.
3. Select the desired resolution, and click **Apply**.

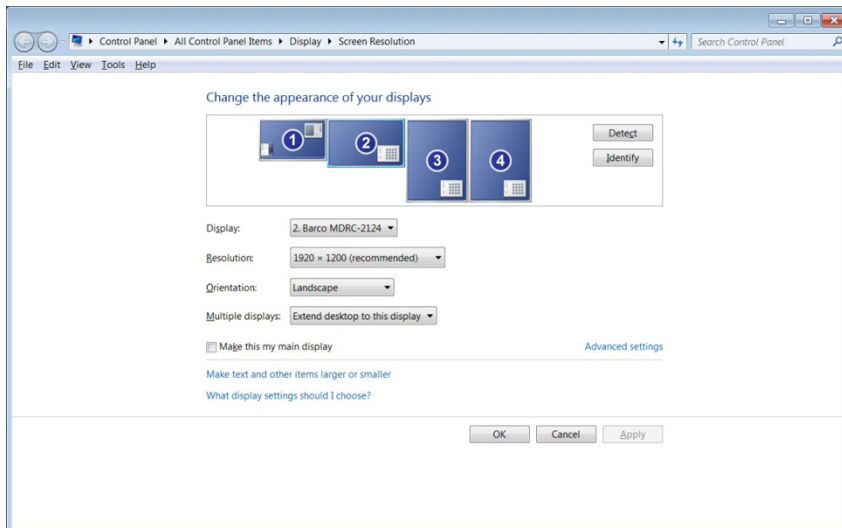

Image 4-1: Windows Display Control Panel



In Windows 7, the maximum horizontal resolution of the desktop is 8192 pixels for a single display controller. Your calculation should include the *VirtualView* display, if used. Please refer to Microsoft Knowledge Base article 2724530.

## 4.2 Software rotation

### Configuring screen orientation

Software rotation is only necessary for displays that do not support hardware rotation, such as MDRC displays and some third-party displays.

1. Right click on the Desktop, and select **Screen Resolution** in the context menu.
2. Select a Display.
3. In the **Orientation** drop down list, these options are available:
  - **Landscape**
  - **Portrait**
  - **Landscape (flipped)**
  - **Portrait (flipped)**
4. Select the desired setting, and click **Apply**.



## 4.3 Night light

### Disabling Night light

Windows 10 provides a feature to shift the white point of light throughout the day. This is not recommended for diagnostic workstations. It should be disabled by default. If Night light is enabled, follow these steps to disable it:

1. Right click on the Desktop, and select **Display settings** in the context menu.
2. Under **Night light**, turn the feature to **Off**.



# Driver and Intuitive Workflow Tools

# 5

# 5.1 Barco System Settings Control Panel

## 5.1.1 Description

### Overview

The Barco System Settings Control Panel provides a centralized configuration interface for users to personalize their Barco Display System environment.

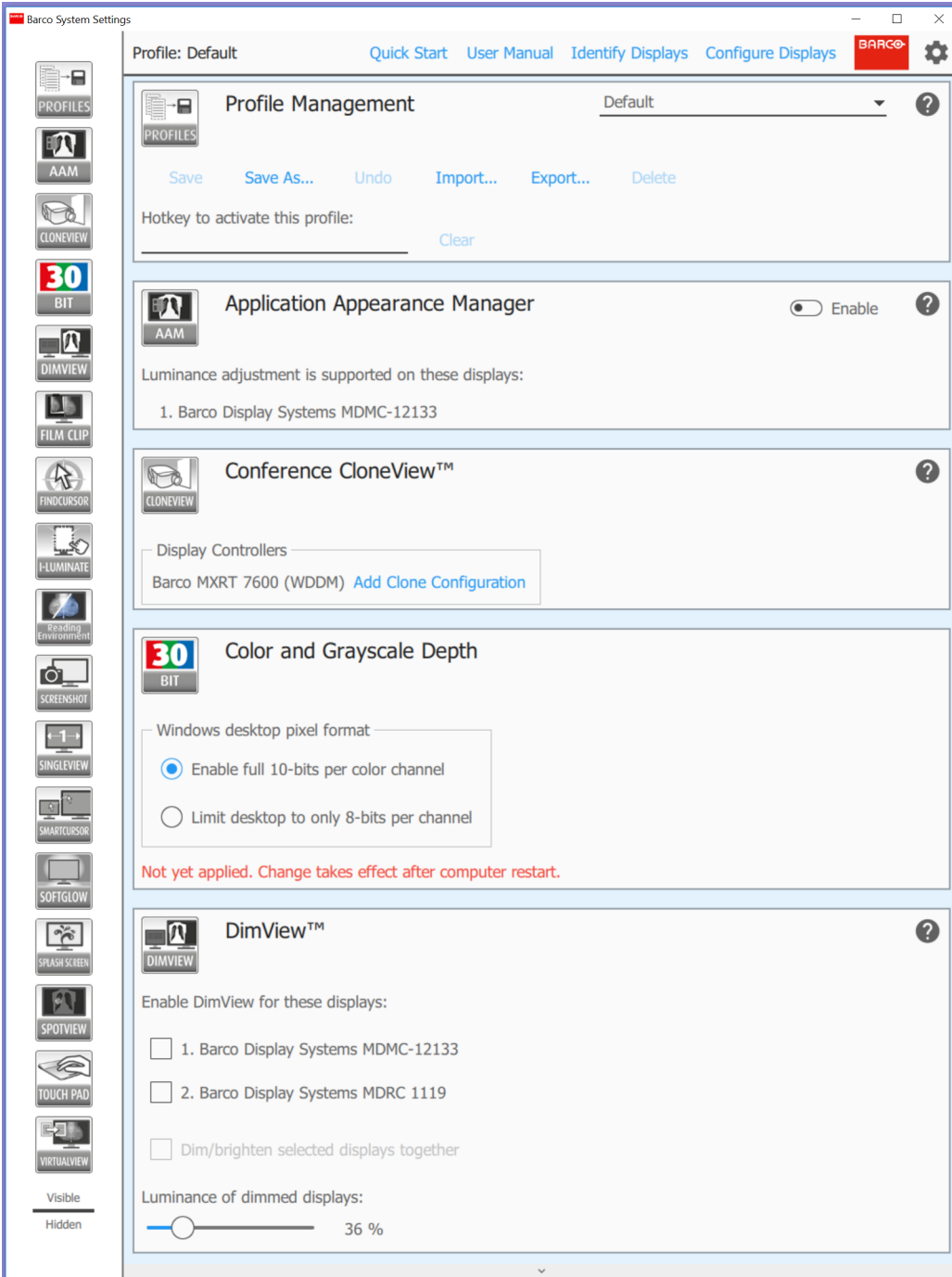

Image 5-1: Barco System Settings Control Panel

## 5.1.2 Operation

### Accessing the Barco System Settings Control Panel

- Right click on the desktop and select **Barco System Settings**, or
- Click on the Barco icon in the System Tray, or
- Press the hotkey **Control+ALT+O**

### Layout of the Barco System Settings Control Panel

The Barco System Settings Control Panel consists of 3 sections: the Control Bar at the top, the Navigation pane on the left, and the configuration tiles on the right. The Control Bar shows the current active profile and provides 4 additional buttons.

- **Open User Manual:** This opens a PDF version of this user guide if a PDF viewer is installed in the system.
- **Identify Displays:** Some settings in the Barco System Settings Control Panel require selection of individual displays. Press this button to see which display corresponds to which configuration numbers.



The identification numbers used by the Barco System Settings Control Panel do not reflect the display ID number assigned by Windows as shown in the Windows Screen Resolution configuration page.

- **Configure Displays:** This opens the Windows Screen Resolution Control Panel to allow changes to the location and resolution of displays in the Windows desktop.
- : Clicking the gear symbol opens the Control Panel Settings Box and allows the user to change settings of the Barco System Settings Control Panel.
  - Hotkey to Show This Control Panel: Click Clear to remove the hotkey. Click on the hotkey box to enter a new one.
  - Disable Navigation Bar Popups: This button can enable popups on the Navigation Pane, making the icons larger and more legible.

Through the Navigation Pane, the user can get quick access to the configuration tile of a feature by clicking on its icon. The Navigation Pane also allows customization of the Barco System Settings Control Panel. Dragging icons in the Navigation Pane will change the order of the tiles, allowing commonly used tiles to appear at the top. In the middle of the Navigation Pane is the visibility line. The tile for any feature can be hidden by dragging its corresponding Navigation Pane icon below the visibility line, reducing control panel clutter. If the icons in the Navigation Pane appear too small, popups with larger icons can be enabled in the Control Panel Settings Box.

Each configuration tile contains controls for the given feature, and those controls are described later in this section. Each configuration tile contains a help icon , and clicking on it will bring the user to the relevant section of this user guide.

### Profile management

The Profile Management tile is an exception to the rules above; it cannot be reordered or hidden. Selected options in the Barco System Settings Control Panel can be saved in profiles, and those profiles are managed with this tile. The profiles are specific to the current user, and they will be automatically applied when the user logs into the system.

The profile can be exported to and imported from a remote disk, so it can be deployed to multiple systems.

- **Profile:** The current profile is selected with this drop-down menu. If the profile is edited, it will be marked here as “modified”.
- **Save:** This saves changes to the current profile. Changes to the Default profile cannot be saved.
- **Save as...:** This saves the current configuration setting as a profile with a new name. Provide a profile name in the popup dialog box.
- **Undo:** This reverts to the saved version of the current profile.
- **Import...:** This imports a profile from file and makes it available in the Profile list to be selected.
- **Export...:** This saves selected profiles on this system to a file. The selection is made from a dialog box.
- **Delete:** This removes the current profile from the profile list and restores the system to the Default profile.

To apply a profile system wide:

1. Export the profile, and name it Default.ini

2. Edit the new file:
  - Change line 3 from `names=<profileName>` to `names=Default`
  - Change line 5 from `[<profileName>]` to `[Default]`
3. Replace the default profile in `C:\Program Files\Barco\ProductivityTools\Default.ini` with the new one.

## 5.2 Application Appearance Manager



Application Appearance Manager is pending medical device clearance and is currently not available in all markets.

### 5.2.1 Description

#### Overview

The high luminance of Barco diagnostic displays may not be necessary when using the displays to view non-diagnostic applications, such as text documents and emails. The *Application Appearance Manager (AAM)* feature allows the user to set all windows of specific applications to a lower desired luminance, while retaining the full diagnostic luminance for all other applications.

For the SteadyColor™ displays, such as the Coronis Uniti and the MDNC-6121, *AAM* can also change the output color profile of specific applications to match the application expectations. For example, a web browser used for non-diagnostic purposes could be set to an sRGB color space.



Image 5-2

#### Supported display controllers

When driven by an MXRT-x500 or later display controller, *AAM* can be enabled on selected Barco Coronis, Nio, and Mammography displays. These include the MDCC-6530, MDCC-6430, MDCC-6330, MDCC-4430, MDCC-4330, MDCC4230, MDNC-6121, and MDMC-12133.

The color profile management feature is supported on SteadyColor calibrated displays. The MDMC-12133 is supported when calibrated with QAWeb (1.13.01 or later) or QAWeb Enterprise. The MDNC-6121 is supported when calibrated with QAWeb (1.13.10 or later) or QAWeb Enterprise. The MDCC-6530 and MDCC-4430 are supported when calibrated by QAWeb Enterprise (2.2 or later).

### 5.2.2 Operation

#### Using Application Appearance Manager

Select each desired application executable to add it to the list of *AAM*-managed applications. Independently edit the luminance and color profile for each managed application.

Applications can be blocked from being managed by *AAM*. In the directory `C:\ProgramData\Barco\ProductivityTools`, open the `AAMBlackList.txt` file. Enter the name of the application executable, and after rebooting the system, the application will not appear in *AAM*. If the name of the executable is not known, launch the application, enable *AAM*, and note the name of the executable from the unmanaged list. To edit the file, launch the editor with the *Run As Administrator* option.



**CAUTION:** If you are using a web browser-based DICOM viewer, do not change the *AAM* setting for your web browser.

## 5.2.3 Configuration

### Configuring color management

- **Enable:** This switch will enable or disable the *Application Appearance Manager*.
- **Manage Selected App Name:** Check the box of an application to control its appearance.
- **Luminance:** Change the luminance of the selected managed application with this slider. Although the slider will allow entry up to 1000 candela, the maximum luminance is the calibration luminance of the display showing the application window. The minimum luminance is 250 candela.  
Click on the palette symbol  to open controls for color management. It will be grayed out if no display supports color profile management.
- **Color Profile:** Select the color profile that matches the color profile of the controlled application. Select from sRGB, SteadyColor, and DICOM.
- **White Point:** Select the desired white point of a display for viewing the application. Select from D65, D75, ClearBase, and BlueBase.
- **Rendering Intent:** Two rendering intents are available for the sRGB color profile: Relative and Absolute. With Relative intent, out of gamut colors will be represented by the nearest color within the display's color range and other colors may shift to maintain visual differences. With Absolute intent, out of gamut colors will be represented by the nearest color, leaving other colors intact.
- **Apply:** Apply the currently shown color profile settings to that application's windows.
- **Reset:** Returns the color profile settings of that application's windows to the display's calibration settings.

## 5.3 Color and Grayscale Depth

### 5.3.1 Description

#### Overview

This feature allows High Dynamic Range visualization of medical imaging on gray scale and color displays.



Image 5-3

#### Supported display controllers

This feature is supported on all Barco MXRT display controller systems.

### 5.3.2 Operation

#### Using 30-bit desktop

30-bit desktop is enabled by default for the standard Barco MXRT driver software package. This is typically compatible with all PACS application software.

### 5.3.3 Configuration

#### Configuring color depth

- **Enable full 10-bits per color channel:** Click to allow 10-bit grayscale and 30-bit color imaging.
- **Limit desktop to only 8-bits per channel:** Click to restrict dynamic range of grayscale to 8 bits and color to 24 bits.



It is necessary to reboot the system to apply changes to the color depth.

## 5.4 Conference CloneView™

### 5.4.1 Description

#### Overview

This feature allows the user to clone the images sent to one or more displays to other displays or projectors attached to the same Barco Display Controller. *Conference CloneView* supports zooming and panning on the cloned image(s) for ease of viewing.



Image 5-4

#### Supported display controllers

*Conference CloneView* is supported by all systems with an MXRT-x400 or later display controller.

### 5.4.2 Operation

#### Using Conference CloneView

Create a new clone session and select up to 3 source displays and up to 3 target displays for the clone session. The source and target displays must be attached to the same display controller. The cloned image can be scaled to fit the resolution of the target display. With a Barco Display Controller with 4 outputs, it is possible to have two independent cloning sessions.

When the cursor is over to the cloned image, it will change to the Barco cursor. The user can zoom in on the cloned image by rolling the mouse wheel and pan the image with the left mouse button.



When zoomed in, the cloned image may be bigger than the clone display and part of the image may be off screen. Click and drag the left mouse button and move the cursor to pan to the portion of the image that is off screen.

Right clicking on the cloned image will bring up the *Conference CloneView* context menu. The menu options are described below.

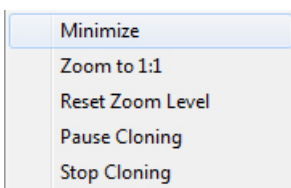

Image 5-5: Conference CloneView Context Menu

- **Minimize:** This minimizes the cloned image to show the desktop.
- **Zoom to 1:1:** Changes the scaling to 1 target pixel per source pixel. If the source resolution is larger than the target resolution, panning will be necessary to see the entire image. If the source resolution is smaller than the target resolution, black boarders will show around the image. “*Stretch to fill*” has priority over this option.
- **Reset Zoom Level:** When “*Stretch to fill*” is selected in the Barco System Settings Control Panel, this will reset to the minimal zoom possible to make the stretched aspect ratio possible. When “*Stretch to fill*” is not selected, this option will reset the zoom to 1:1. When the image is already at the minimum zoom level, this option is grayed out.
- **Pause Cloning:** This suspends updates to the clone image; the source can continue to change while the target image remains static. Select it a second time to resume active cloning.
- **Stop Cloning:** Select this option to stop cloning on the current Display Controller. It has the same effect as clicking on the Stop Cloning button in the Barco System Settings Control Panel.



## 5.4.3 Configuration

### Configuring Conference CloneView

- **Add clone configuration:** Click this button to define a new clone configuration.
- **Clone From** and **Clone To:** Click on one or more source displays in the **Clone From** list and one or more target displays from the **Clone To** list for the session. An active source cannot be used as a target, and an active target cannot be used as a source.
- **Stretch to fill:** If this is unchecked, the aspect ratio of the source displays will be preserved. If this is checked, the cloned image will be stretched to fill the target display(s) with the cloned image.
- **Start/Stop:** Clicking the **Start** button activates the clone session, and the button will change to **Stop**, which would end the session.
- **Remove this configuration:** Deletes this configuration.

## 5.5 DimView™

### 5.5.1 Description

#### Overview

The *DimView* feature reduces ambient light during diagnostic readings by dimming navigational displays when the cursor is moved off those displays. While the feature is intended for use with navigational heads, it can be enabled on any display.



Image 5-6

#### Supported display controllers

*DimView* is supported on the MXRT-1450 , MXRT-1451, and all MXRT-x500 or later display controllers.

### 5.5.2 Operation

#### Using DimView

*DimView* can be individually enabled on each display. All *DimView*-enabled displays can operate independently, or they can be configured to dim and brighten together.

### 5.5.3 Configuration

#### Configuring DimView

- **Enable DimView for these displays:** All displays that support *DimView* are listed in the configuration section. Click on the checkbox to enable the feature on that display.
- **Dim/brighten selected displays together:** When this box is checked, all *DimView*-enabled displays will brighten when the cursor is moved onto any one of those displays, and dim only when the cursor is off all of them.
- **Luminance of dimmed displays:** This slider bar sets the luminance while dimmed.

## 5.6 Film Clip



Film Clip is pending medical device clearance and is currently not available in all markets.

## 5.6.1 Description

### Overview

*Film Clip* allows the user to view a physical radiological film by using the I-Luminate™ feature of the display as a virtual light box.



Image 5-7

### Supported display controllers

When driven by an MXRT-x400 or later display controller, *Film Clip* can be enabled on the MDMG-5221 and MDMC-12133 displays.

## 5.6.2 Operation

### Using Film Clip

The size and location of the film clip light box are programmable. It has an automatic time-out with a programmable duration. An optional hotkey can quickly turn the light box on or off.

Supported film sizes for both MDMG-5221 and MDMC-12133 include the 18 cm x 24 cm and 24 cm x 30 cm; the MDMC-12133 also supports the larger 34 cm x 43 cm size.

## 5.6.3 Configuration

### Configuring Film Clip

- **Enable Film Clip hotkey for these displays:** All displays that support *Film Clip* are listed in the configuration section. Click on the checkbox to launch the feature on that display with the hotkey.
- **Timeout:** The slider bar sets the time-out period for Film Clip mode.
- **Hotkey to enabled Film Clip:** Click **Clear** to remove a hotkey. Click on the hotkey box to enter a new one.
- **Position:** This sets the location of the light box image on enabled displays.
- **Size:** This sets the size of the light box image to match the physical film dimensions.

## 5.7 FindCursor™

### 5.7.1 Description

#### Overview

The *FindCursor* feature provides a method to quickly locate the cursor on a system with multiple displays.



Image 5-8

### Supported display controllers

*FindCursor* is supported on all MXRT-x400 or later display controllers.

### Default behavior

*FindCursor* is enabled by default.

## 5.7.2 Operation

### Using FindCursor

To quickly locate the cursor, hold down the hotkey (default: **Control+Shift+F**). The cursor location will be highlighted by a circle, which appears yellow on color displays and gray on grayscale displays.

## 5.7.3 Configuration

### Configuring FindCursor

- **Enable/Disable:** Use the checkbox to enable or disable *FindCursor*.
- **Hotkey:** The currently selected hotkey is displayed in the edit box. To program a new hotkey, highlight the edit box, and input the new keystrokes. The change will take affect right away.

## 5.8 I-Luminate™



I-Luminate is pending medical device clearance and is currently not available in all markets.

## 5.8.1 Description

### Overview

This feature boosts the luminance of supported displays.



Image 5-9

### Supported display controllers

When driven by an MXRT-x400 or later display controller, *I-Luminate* can be enabled on supported displays, including MDMC-12133, MDMG-5221, and MDCG-5221.

## 5.8.2 Operation

### Using I-Luminate

A hotkey will boost the luminance on all selected displays.

## 5.8.3 Configuration

### Configuring I-Luminate

- **Enable I-Luminate for these displays:** All displays that support *I-Luminate* are listed in the configuration section. Click on the checkbox to enable the feature on that display.
- **Hotkey to enabled I-Luminate:** Click **Clear** to remove a hotkey. Click on the hotkey box to enter a new one.
- **Timeout:** The slider bar sets the time-out period for the *I-Luminate* mode.

## 5.9 Reading Environment

### 5.9.1 Description

#### Overview

The reading environment settings for diagnostic displays allow the user to specify the color temperature and luminance of SteadyColor-calibrated displays. The reading environment for non-diagnostic displays allows the user to specify the maximum luminance on Barco clinical displays and third-party displays, however color temperature selection is not available.



Image 5-10

#### Supported display controllers

When driven by an MXRT-x500 or later display controller, the Reading Environment can be configured on MDMC-12133, MDNC-6121, MDCC-6530, MDCC-4430, Barco MDRC displays, and third-party displays.



Diagnostic reading environment configuration is available on Coronis Uniti displays that are calibrated with QAWeb 1.13.01 or later, on MDNC-6121 displays that are configured with QAWeb 1.13.10 or later, and on MDCC-6530 and MDCC-4430 displays calibrated by QAWeb Enterprise 2.2 or later.

### 5.9.2 Operation

#### Using Reading Environment for SteadyColor Diagnostic Displays

The configuration of the Reading Environment is complimentary to the QAWeb settings. If the SteadyColor display is calibrated by the QAWeb 1.x Agent and the workstation is not connected to the QAWeb 1.x Server, all the controls in this section are available in the Barco System Settings Control Panel. If the workstation is connected to the QAWeb 1.x Server, use the server to set the reading environment. If the display is calibrated by the QAWeb Enterprise Agent, only the white-point chromaticity is calibrated through the Barco System Settings Control Panel.

Configure the white point chromaticity, ambient light, color calibration model, and calibrated luminance to user preference. After the settings have been changed, the QAWeb Agent will check if it has calibration files for the new settings. If it does, it will upload the calibration data to the display, which may take 20-60 seconds. If it does not have the calibration files, it will calibrate the display to create them, which may take up to 10 minutes.



When changes to the Reading Environment for Diagnostic Displays are made, the Barco System Settings Control Panel will indicate that changes are still in progress. Please let the system apply its changes before proceeding with readings.

#### Using Reading Environment for Non-Diagnostic Displays

Reading Environment can be individually enabled on each non-diagnostic display to reduce its luminance. Unlike *DimView*, the luminance of these displays will not change with cursor movement. The Reading Environment feature can be used in conjunction with *DimView*.

### 5.9.3 Configuration

#### Configuring Reading Environment for Diagnostic Displays

- **Use the settings QAWeb already has:** When selected, reading environment settings for diagnostic displays are disabled in the Barco System Settings Control Panel.
- **Suggest the following settings to QAWeb:** When selected, the reading environments are modifiable.

- **White point chromaticity:** This selects between clearbase, bluebase, and native white points.
- **Ambient light condition:** This selects the expected ambient light condition based on reading room class.
- **SteadyColor calibration:** This selects the color calibration model of the SteadyColor display.
- **Luminance of white:** This slider sets the calibration luminance of the display.



In some installations with QAWeb, Ambient light condition, SteadyColor calibration, and Luminance of White do not appear in the Barco System Settings Control Panel. These can be configured in QAWeb with an appropriate image quality policy.

## Configuring Reading Environment for Non-Diagnostic Displays

- **Select the displays:** All supported non-diagnostic displays are listed in the configuration section. Click on the checkbox to enable the feature on that display.
- **Display luminance:** This slider bar sets the luminance reduction for the selected displays.

## 5.10 Screen Capture

### 5.10.1 Description

#### Overview

The Screen Capture feature captures the desktop into an image, including the Intuitive Workflow features, such as *SpotView*.



Image 5-11

#### Supported display controllers

This feature is supported by MXRT-x400 and above display controllers.

### 5.10.2 Operation

#### Using Screen Capture

The screen capture is triggered through a hotkey. The user can choose to capture the image of the display with the cursor to the clipboard. The user can also choose to capture an image of each display to a file in either PNG or PPM format.

### 5.10.3 Configuration

#### Configuring Screen Capture

- **Hotkey:** Click **Clear** to remove a hotkey. Click on the hotkey box to enter a new one.
- **Copy captured image to Windows clipboard:** Check this box to copy the image of the display with the cursor to the clipboard.
- **Output directory:** To save the capture images as files, enter a target location here.
- **File format:** Use these radio buttons to choose the file format as either PNG or PPM.

## 5.11 SingleView™

### 5.11.1 Description

#### Overview

*SingleView* enables the use of a Coronis Fusion display as a single display in the Windows desktop and eliminates any tearing down the center.



Image 5-12

#### Supported displays

When driven by an MXRT-x400 or later display controller, *SingleView* is supported on all Coronis Fusion displays.

### 5.11.2 Operation

#### Using SingleView

A button will switch all Coronis Fusion displays into *SingleView*, and another will switch all into *DualView*. Hotkeys are available for both actions.

When in *SingleView*, it is possible to have the left and right halves out of position, and a button will swap the two.

*DualView* is the preferred setting for most PACS application software.

### 5.11.3 Configuration

#### Configuring SingleView

- **Enable SingleView:** This check box will toggle between *SingleView* and *DualView*.
- **Swap Left/Right:** This can correct misaligned *SingleView* displays one at a time.
- **Hotkeys:** *SingleView* and *DualView* activations have individual hotkeys. Click **Clear** to remove a hotkey. Click on the hotkey box to enter a new one.

## 5.12 SmartCursor™

### 5.12.1 Description

#### Overview

The Barco *SmartCursor* feature prevents the cursor from becoming stuck on edges of adjacent displays of different sizes.



Image 5-13

#### Supported display controllers

*SmartCursor* is supported by all systems with an MXRT-x400 or later display controller.

## 5.12.2 Operation

### Using SmartCursor

The *SmartCursor* operation is illustrated in Image 5-14.

Consider two points, A and B, on two displays of different sizes. Without *SmartCursor*, the cursor cannot move left from point A because it will be stuck on that edge. With *SmartCursor*, moving the cursor left from point A will move the cursor to point B. For symmetry, with *SmartCursor* moving to the right from point B, the cursor will appear back at point A.



Image 5-14: *SmartCursor* moving left from point A and right from point B.

## 5.12.3 Configuration

### Configuring SmartCursor

**Enable:** Click on this checkbox to turn *SmartCursor* on or off.

## 5.13 SoftGlow™

### 5.13.1 Description

#### Overview

Select Barco Coronis displays support *SoftGlow*. It consists of a task light, which sheds a light on the desktop, and a wall light, which provides ambient lighting for the reading room to reduce eye fatigue. The brightness of each is configurable.



Image 5-15

#### Supported display controllers

When driven by an MXRT-x400 or later display controller, *SoftGlow* can be configured on MDMC-12133, MDCC-6530, and MDCC-4430 displays.

### 5.13.2 Operation

#### Using SoftGlow

The task and wall lights will be set to the *SoftGlow* settings when the user has logged on to the Barco display system.

### 5.13.3 Configuration

#### Configuring SoftGlow

- **Task Light** and **Wall Light**: Use these sliders to set the brightness of the lights. Click and enter 0 to shut the light off.
- **Hotkey**: When configured, this hotkey will toggle the task lights on and off. The wall lights are only controlled by the slider.

## 5.14 SpotView™



SpotView is pending medical device clearance and is currently not available in all markets.

### 5.14.1 Description

#### Overview

The *SpotView* feature allows focused observation during readings by dimming images outside a region of interest and optionally enhancing the contrast in the region of interest.

The *SpotView Mag* feature offers 2x zoom within the *SpotView* region of interest. *SpotView Invert* inverts the pixels in the region of interest. *SpotView Align* creates a bar-shaped region of interest, which can be rotated as needed. *SpotView Align* has 2 modes of operation, a straight bar, or a V-shaped bar.



Image 5-16

#### Supported displays and display controllers

When driven by an MXRT-x500 or later display controller, SpotView can be enabled on selected Barco Coronis, Nio, and Mammography displays, including MDCC-6530, MDCC-6430, MDCC-6330, MDCC-4430, MDCC-4330, MDCC-4230, MDCG-5221, MDCG-3221, MDNC-6121, MDNC-3421, MDNC-3321, MDNC-2221, MDNG-5221, MDMG-5121, MDMG-5221, MDMC-12133.

### 5.14.2 Operation

#### Using SpotView

*SpotView* highlights a region of interest. The region of interest is selected by the use of the Barco Touchpad or by the mouse and a hotkey (default: **Control+Shift+X**). To control *SpotView* with the touchpad, hold and move one finger. The highlighted region of interest is always bound to displays that support *SpotView*.



To show *SpotView* when the Barco Touchpad is in *Mouse Emulation Mode*, hold one finger then tap a second.

The default diameter of the region of interest is controllable in the Barco System Settings Control Panel. If Dynamic Sizing is enabled, the diameter is also controllable with the scroll wheel when using the mouse, or with a pinch gesture when using the Barco touchpad. When *SpotView* is released, it returns to the default diameter on the next activation. When using the mouse, clicking on the scroll wheel will toggle between controlling the Dynamic Sizing of the spot and scrolling in the Windows application.

To enhance viewing on Coronis and Mammography displays, the *SpotView* feature boosts the luminance of the display, if supported. The boost feature will turn off after one minute of continuous use. To further enhance viewing, the *SpotView* feature will optionally enhance the contrast of the region of interest. Contrast enhancement is not available with *SpotView Align*.



*SpotView Mag* highlights a region of interest, boosts luminance, and applies 2x zoom to the area. It is controlled through the Barco Touchpad or by the mouse and a hotkey (default: **Control+Shift+Z**). For the touchpad, while holding one finger to show *SpotView*, tap a second finger to toggle on (or off) *SpotView Mag*.

*SpotView Invert* inverts pixels in the region of interest. It is controlled through the Barco Touchpad or by a mouse and a hotkey (default: **Control+Shift+S**). For the touchpad, while holding one finger to show *SpotView*, double-tap a second finger to toggle on (or off) *SpotView Invert*. *SpotView Invert* can be used simultaneously with *SpotView Mag* with the Barco Touchpad or by a mouse and hotkey (default: **Control+Shift+A**).

When using the hotkey to turn on *SpotView*, the Spot will appear with the current cursor position being the center. When the Spot is moved onto a display that does not support the feature, it will not show the spot.

*SpotView Align* implements *SpotView* technology in different shapes to enable alternative uses. The two alternate shapes are a bar and a vee. They are only available through use of the Barco Touchpad, and both allow custom angles specified by the user.



Image 5-17

To enable the *SpotView Align* bar shape, first hold one finger on the touchpad to show *SpotView* then hold two fingers on it to show *SpotView Align*. Rotate two fingers for the desired angle, and keep just one finger to lock the angle. The bar can be moved by dragging the one finger. The angle of *SpotView Align* can be adjusted again by rotating two fingers on the touchpad. While holding one finger to show *SpotView Align*, tap or double-tap a second finger to toggle on (or off) *SpotView Mag* or *SpotView Invert*.



Image 5-18

To enable the *SpotView Align* vee shape, first enable the bar shape, then hold three fingers to show the mirror-image vee shape. Rotating two fingers will rotate the right bar, and the left image will follow. While holding one finger to show *SpotView Align*, tap or double-tap a second finger to toggle on (or off) *SpotView Mag* or *SpotView Invert*.

### 5.14.3 Configuration

#### Configuring SpotView

- **Enable SpotView for these displays:** All displays that support *SpotView* are listed in the configuration section. Click on the checkbox to enable the feature on that display.
- **Enable Dynamic Contrast Enhancement:** Click on this checkbox to turn on the contrast enhancement feature. This is only available for the standard *SpotView* circle shape.
- **Enable Dynamic Size Adjustment for spot:** Click on this checkbox to allow the *SpotView* diameter to change with the scroll wheel or keypad pinch.
- **Show cursor in spot:** Enabling this feature shows the cursor when controlled by a mouse. The touchpad behavior is unaffected.
- **Bar:** Check this box to enable the *SpotView Align* bar shape by holding down two fingers on the touchpad.
- **Vee:** Check this box to enable the *SpotView Align* vee shape by holding down three fingers on the touchpad.
- **Luminance outside of spot:** This slider bar sets the luminance on *SpotView* enabled displays outside of the spot.
- **SpotView size, SpotView Mag size, and SpotView Align Width:** These sliders control the diameter of their spots and the width of the *SpotView Align* bar.  
Note: These sizes are described in centimeters. The apparent size will vary due to parallax, rounding of the display size, and the shaded penumbra of the spot. It is not intended to be used alone to make exact measurements of body parts.
- **Hotkeys:** *SpotView* and *SpotView Mag*, both with and without *SpotView Invert*, have individual hotkeys. Click **Clear** to remove a hotkey. Click on the hotkey box to enter a new one.

## 5.15 Touchpad gestures

### 5.15.1 Description

#### Overview

In addition to controlling *SpotView*, the Barco Touchpad can control the cursor and allows the user to control PACS and other applications with multi-touch gestures and touchpad buttons. The user can program the gestures and buttons to send shortcut keystrokes recognized by the PACS system.



Image 5-19

#### Supported display controllers

The touchpad gestures are supported by all systems with an MXRT-x400 or later display controller and the Barco Touchpad CTH-480 or later.

### 5.15.2 Operation



#### Using the Barco Touchpad Mouse Emulation

When *Mouse Emulation Mode* is enabled, the user can control the cursor using the Barco Touchpad instead of a mouse. The gestures recognized in *Mouse Emulation Mode* are listed in the table below. To show *SpotView* with *Mouse Emulation Mode* enabled, hold one finger and tap a second.

Touchpad gesture	Emulated Mouse action
Move one finger	Move cursor
Tap one finger	Left click
Double-tap one finger	Left double-click
Tap two fingers	Right click
Double-tap two fingers	Right double-click
Double-tap one finger, holding it the second time and moving	Left click and drag
Double-tap two finger, holding one the second time and moving	Right click and drag
Pinch two fingers together	Control+scroll wheel down (Zoom out)
Pinch two fingers out	Control+scroll wheel up (Zoom in)
Drag two fingers up	Scroll wheel up
Drag two fingers down	Scroll wheel down
Drag two fingers left	Click scroll Wheel and drag left
Drag two fingers right	Click scroll Wheel and drag right

#### Using the Barco Touchpad Gesture Recognition

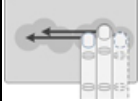
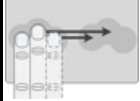
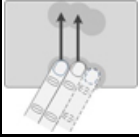
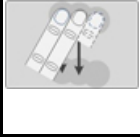
The Barco Touchpad recognizes 10 two- and three-finger gestures: Two- and Three-finger Swipe Left, Two- and Three-finger Swipe Right, Two- and Three-finger Swipe Up, Two- and Three-finger Swipe Down, Two-finger Pinch In, and Two-finger Pinch Out. These are shown in the table below.

Swipe Left		Swipe Right	
Swipe Up		Swipe Down	
Pinch In		Pinch Out	

Each gesture can be programmed to send keystroke shortcuts, as if those keys were pressed on the keyboard. These keystroke shortcuts can be used by the active application in Windows. The gesture can send a single keystroke or send the keystroke continuously until the gesture ceases. Some gestures are used by default in *Mouse Emulation Mode*; those defaults can be overwritten in the Barco System Settings Control Panel.

### 5.15.3 Configuration

#### Configuring the Barco Touchpad

From the Barco System Settings Control Panel, navigate to the Touchpad Gestures section to associate the Barco Touchpad gestures with desired shortcut keys.

- **Enable Mouse Emulation:** Click on this checkbox to control the cursor with the touchpad.
- **Speed:** This slider controls the responsiveness of the cursor in *Mouse Emulation Mode*.
- **Emitted Shortcut:** This field shows the currently defined keyboard shortcut for each gesture. Click on the field to define a new shortcut.
- **Clear:** Click the Clear button to remove the hotkey for a given gesture or button.
- **Continuous:** This checkbox enables continuous shortcut emission.
- **Rate:** This slider controls the rate of continuous shortcut emission.
- **Shortcut Description:** Click on this free text field to describe the intention of the shortcut.

## 5.16 VirtualView™

### 5.16.1 Description

#### Overview

*VirtualView* gives the user additional real-estate on the screen by creating a virtual display in Windows without the need for an additional physical display on the desk. A virtual display is created for the user to use as a navigational head, or for other software, such as dictation. The user can set the location of the virtual display, and when the cursor moves into that virtual area, or hotkey is triggered, the virtual display appears on the Windows desktop.



Image 5-20

#### Supported display controllers

*VirtualView* is supported by all systems with an MXRT-2500, MXRT-4500, MXRT-5500, MXRT-7500, MXRT-5600, or MXRT-7600 display controller.

## 5.16.2 Operation

### Using VirtualView

*VirtualView* creates a virtual display within the Windows desktop. In the Windows control panel, it appears as a normal display with a display number, and its resolution and location can be changed similarly to a physical display.

By moving the cursor to the virtual display location on the desktop, the virtual display appears on a physical display. *VirtualView* can also be activated and hidden by a hotkey (default: **Control +Shift +V**). It can be stretched to make the contents larger or shrunk to make the window take less desktop space. Windows and applications can be dragged and dropped onto the virtual display, and they will show only when *VirtualView* is showing.

To promote usability with PACS applications, *VirtualView* has a visibility setting. In the Diagnostic visibility mode (default), it will appear on the top of all other windows, and in the Administrative visibility mode, it may be hidden by other windows, including the PACS software.

The virtual display window has **Minimize**, **Maximize**, **Restore**, and **Close** buttons.

- Clicking the **Minimize** button hides *VirtualView* and creates an icon on the Task Bar, and clicking on the icon will restore it to its previous size and location.
- Clicking the **Maximize** button resizes *VirtualView* to the largest size possible on that physical display while maintaining aspect ratio, and that button will change to **Restore**.
- Clicking on the **Restore** button returns the maximized window to its previous size and location.
- Clicking the **Close** button does not terminate the *VirtualView* feature. It hides the window, and when shown again, it will appear in the default location and size.

## 5.16.3 Configuration

### Configuring VirtualView through Barco System Settings Control Panel

- **Connect:** *VirtualView* is disabled by default. Click on this checkbox to connect a *VirtualView* display to the desktop. Once *VirtualView* has been connected to the desktop through the Barco System Settings Control Panel, the *VirtualView* display will show up in the Windows Display Control Panel as Barco Virtual display, and can be controlled as a regular display on the desktop.
- **Reset window size:** This resets the virtual display window to 1-to-1 scaling.
- **Configure Visibility:** Selects between Diagnostic and Administrative visibility modes.
- **Configure Hotkey:** Specify a hotkey to show/hide virtual display window.

### Configuring VirtualView through Windows Display Control Panel

The Windows Display Control Panel can be opened through the Barco System Settings Control Panel. Or, from the **Control Panel**, select **Display**, and select **Screen Resolution**. Or, click on the desktop a select **Screen Resolution**.

The Barco virtual display resolution and location on the Windows desktop can also be changed in the control panel in the same method as normal displays. *VirtualView* supports a large range of portrait and landscape resolutions.

**Important  
information**

**6**

## 6.1 Safety information

### General recommendations

Read the safety and operating instructions before operating the device.

Retain safety and operating instructions for future reference.

Adhere to all warnings on the device and in the operating instructions manual.

Follow all instructions for operation and use.

### Electrical Shock or Fire Hazard

To prevent electric shock or fire hazard, do not remove cover.

No serviceable parts inside. Refer servicing to qualified personnel.

Do not expose this apparatus to rain or moisture.

### Modifications to the unit

Do not modify this equipment without authorization of the manufacturer.

### Type of protection (Electrical)

Device with external power supply: Class I equipment.

### Degree of safety (flammable anesthetic mixture)

Equipment not suitable for use in the presence of a flammable anesthetic mixture with air or with oxygen or nitrous oxide.

## 6.2 Environmental information

### Disposal Information

Waste Electrical and Electronic Equipment



■ This symbol on the product indicates that, under the European Directive 2012/19/EU governing waste from electrical and electronic equipment, this product must not be disposed of with other municipal waste. Please dispose of your waste equipment by handing it over to a designated collection point for the recycling of waste electrical and electronic equipment. To prevent possible harm to the environment or human health from uncontrolled waste disposal, please separate these items from other types of waste and recycle them responsibly to promote the sustainable reuse of material resources.

For more information about recycling of this product, please contact your local city office or your municipal waste disposal service.

For details, please visit the Barco website at: <http://www.barco.com/AboutBarco/weee>

### Turkey RoHS compliance



■ Türkiye Cumhuriyeti: AEEE Yönetmeliğine Uygundur.

[Republic of Turkey: In conformity with the WEEE Regulation]

### 中国大陆 RoHS

Chinese Mainland RoHS

根据中国大陆《电器电子产品有害物质限制使用管理办法》（也称为中国大陆RoHS），以下部分列出了Barco产品中可能包含的有毒和/或有害物质的名称和含量。中国大陆RoHS指令包含在中国信息产业部MCV标准：“电子信息产品中有毒物质的限量要求”中。

According to the “Management Methods for the Restriction of the Use of Hazardous Substances in Electrical and Electronic Products ” (Also called RoHS of Chinese Mainland), the table below lists the names and contents of toxic and/or hazardous substances that Barco’s product may contain. The RoHS of Chinese Mainland is included in the MCV standard of the Ministry of Information Industry of China, in the section “Limit Requirements of toxic substances in Electronic Information Products”.

零件项目(名称) Component name	有毒有害物质或元素 Hazardous substances and elements					
	铅 Pb	汞 Hg	镉 Cd	六价铬 Cr6+	多溴联苯 PBB	多溴二苯醚 PBDE
印制电路配件 Printed Circuit Assemblies	x	o	o	o	o	o
本表格依据SJ/T 11364的规定编制 This table is prepared in accordance with the provisions of SJ/T 11364. o: 表示该有毒有害物质在该部件所有均质材料中的含量均在 GB/T 26572 标准规定的限量要求以下。 o: Indicates that this toxic or hazardous substance contained in all of the homogeneous materials for this part is below the limit requirement in GB/T 26572. x: 表示该有毒有害物质至少在该部件的某一均质材料中的含量超出 GB/T 26572 标准规定的限量要求。 x: Indicates that this toxic or hazardous substance contained in at least one of the homogeneous materials used for this part is above the limit requirement in GB/T 26572.						

在中国大陆销售的相应电子信息产品（EIP）都必须遵照中国大陆《电子电气产品有害物质限制使用标识要求》标准贴上环保使用期限（EFUP）标签。Barco产品所采用的EFUP标签（请参阅实例，徽标内部的编号用于指定产品）基于中国大陆的《电子信息产品环保使用期限通则》标准。

All Electronic Information Products (EIP) that are sold within Chinese Mainland must comply with the “Marking for the restriction of the use of hazardous substances in electrical and electronic product” of Chinese Mainland, marked with the Environmental Friendly Use Period (EFUP) logo. The number inside the EFUP logo that Barco uses (please refer to the photo) is based on the “General guidelines of environment-friendly use period of electronic information products” of Chinese Mainland.



## 台灣 RoHS

Taiwan RoHS

限用物質含有情況標示聲明書

Declaration of the Presence Condition of the Restricted Substances Marking

設備名稱：视频显示卡 . 型號 ( 型式 ) : 102-c58708-01; MXRT-5600; MXRT-7600 Equipment name . Type designation (Type)						
單元 Unit	限用物質及其化學符號 Restricted substances and its chemical symbols					
	鉛 (Pb)	汞 (Hg)	鎘 (Cd)	六價鉻 (Cr <sup>6+</sup> )	多溴聯苯 (PBB)	多溴二苯醚 (PBDE)
风扇散热器 Fansink	-	o	o	o	o	o
电路板 Circuit Board	-	o	o	o	o	o
托架 Bracket	o	o	o	o	o	o

拧 Screw	○	○	○	○	○	○
<p>備考1. “超出0.1 wt %” 及 “超出0.01 wt %” 係指限用物質之百分比含量超出百分比含量基準值            Note 1 : “Exceeding 0.1 wt %” and “exceeding 0.01 wt %” indicate that the percentage content of the restricted substance exceeds the reference percentage value of presence condition</p> <p>備考2. “○” 係指該項限用物質之百分比含量未超出百分比含量基準值            Note 2 : “○” indicates that the percentage content of the restricted substance does not exceed the percentage of reference value of presence.</p> <p>備考3. “-” 係指該項限用物質為排除項目            Note 3 : The “-” indicates that the restricted substance corresponds to the exemption</p>						

## 6.3 Regulatory compliance information



The Intuitive Workflow Tools (SpotView, I-Luminate, Film Clip and Application Appearance Manager (AAM)) are pending medical device clearance and are currently not available in all markets.

### Intended use

The Intuitive Workflow Tools (SpotView, I-Luminate, Film Clip and Application Appearance Manager (AAM)) are intended to be used as accessories for image enhancement in diagnostic displays.

### Intended conditions for use

There are no specific intended conditions for use.

### Contra-indications

Not applicable.

### Intended users

The Intuitive Workflow Tools are intended to be used by trained medical practitioners.

### Manufacturing country

The manufacturing country of the product is indicated on the product label (“**Made in ...**”).

### Importers contact information

To find your local importer, contact one of Barco’s regional offices via the contact information provided on our website ([www.barco.com](http://www.barco.com)).

### FCC class B

This device complies with Part 15 of the FCC Rules. Operation is subject to the following two conditions: (1) this device may not cause harmful interference, and (2) this device must accept any interference received, including interference that may cause undesired operation.

This device has been tested and found to comply with the limits for a Class B digital device, pursuant to Part 15 of the FCC Rules. These limits are designed to provide reasonable protection against harmful interference in a residential installation. This device generates, uses and can radiate radio frequency energy and, if not installed and used in accordance with the instructions, may cause harmful interference to radio communications. However, there is no guarantee that interference will not occur in a particular installation. If this device does cause harmful interference to radio or television reception, which can be determined by turning the device off and on, the user is encouraged to try to correct the interference by one or more of the following measures:

- Reorient or relocate the receiving antenna.
- Increase the separation between the device and receiver.
- Connect the device into an outlet on a circuit different from that to which the receiver is connected.
- Consult the dealer or an experienced radio/TV technician for help.















Changes or modifications not expressly approved by the party responsible for compliance could void the user's authority to operate the equipment.











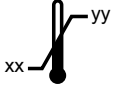

**FCC responsible:** Barco Inc., 3059 Premiere Parkway Suite 400, 30097 Duluth GA, United States, Tel: +1 678 475 8000

## 6.4 Explanation of symbols

### Symbols on the device

On the device or power supply, you may find the following symbols (nonrestrictive list):

	Indicates compliance with Part 15 of the FCC rules (Class A or Class B)
	Indicates the device is approved according to the UL regulations
	Indicates the device is approved according to the UL regulations for Canada and US
	Indicates the device is approved according to the UL regulations for Canada and US
	Indicates the device is approved according to the UL Demko regulations
	Indicates the device is approved according to the CCC regulations
	Indicates the device is approved according to the VCCI regulations
	Indicates the device is approved according to the KC regulations
	Indicates the device is approved according to the BSMI regulations
	Indicates the device is approved according to the PSE regulations
	Indicates the device is approved according to the EAC regulations
	Caution: Federal law (United States of America) restricts this device to sale by or on the order of a licensed healthcare practitioner.
	Indicates the USB connectors on the device

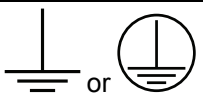
	Indicates the DisplayPort connectors on the device
	Indicates the legal manufacturer
	Indicates the manufacturing date
	Indicates the temperature limitations <sup>3</sup> for the device to safely operate within specs
	Indicates the device serial number
	Indicates the device part number or catalogue number
	<b>Warning:</b> dangerous voltage
	<b>Caution</b>
	Consult the operating instructions
	Indicates this device must not be thrown in the trash but must be recycled, according to the European WEEE (Waste Electrical and Electronic Equipment) directive
	Indicates Direct Current (DC)
	Indicates Alternating Current (AC)
	Stand-by
	Equipotentiality
	Protective earth (ground)

<sup>3</sup>: Values for xx and yy can be found in the technical specifications paragraph.

## 6.5 Legal disclaimer

### Disclaimer notice

Although every attempt has been made to achieve technical accuracy in this document, we assume no responsibility for errors that may be found. Our goal is to provide you with the most accurate and usable documentation possible; if you discover errors, please let us know.

Barco software products are the property of Barco. They are distributed under copyright by Barco NV or Barco Inc., for use only under the specific terms of a software license agreement between Barco NV or Barco Inc. and the licensee. No other use, duplication, or disclosure of a Barco software product, in any form, is authorized.

The specifications of Barco products are subject to change without notice.

### Trademarks

All trademarks and registered trademarks are property of their respective owners.

### Copyright notice

This document is copyrighted. All rights are reserved. Neither this document, nor any part of it, may be reproduced or copied in any form or by any means - graphical, electronic, or mechanical including photocopying, taping or information storage and retrieval systems - without written permission of Barco.

© 2019 Barco NV all rights reserved.

### Privacy policy

Barco is concerned about respecting the privacy of our users. Please see our privacy policy on our website at <http://www.barco.com/en/about-barco/legal/privacy-policy> to learn more.

## 6.6 Technical specifications



Check with local service representatives for specifications if your card is not listed.

### MXRT-1450

Product acronym	MXRT-1450
Bus compatibility	Could be installed within PCI Express x1, x8, x16 mechanical slots Works in PCI Express x1, x4, x8, x16 electrical slots / operates at x1 speed
Power consumption	17 Watt
Form factor	Low profile, half-length, 2.3"x 6.6"
Operating system	Windows 7 – 32/64-bit, Windows 8.1 – 64-bit, Windows 10 – 64-bit
Platforms	Intel® and AMD architectures
Graphics accelerator	ATI FirePro
Graphics memory	512 MB DDR3
Memory interface	64-bit
Memory bandwidth	9.6 GB/s
Pixel depth	32-bit color
Electrical standard	Single-link DVI complying to v1.0 specification
Connectors	DMS-59
Connectivity	One DMS-59-to-DVI adaptor included
Supported resolutions	2560x1600 DisplayPort, 1920x1200 DVI/Analog
DirectX support	Microsoft® DirectX v11.0

OpenGL support	OpenGL 4.0
OpenCL support	OpenCL 1.0
Approvals and compliance	FCC Part 15 Class B, CE EN 55022 Limit B, EN 55024, UL-60950-1, BMSI CNS, CISPR- 22/24, IEC609050-1, VCCI, CSA C22.2, EU RoHS directive (2002/95/EC), Certificate of Information & Communication Equipment (Republic of Korea)
Operating temperature	0° to 60°C (32° to 140° F)

**MXRT-1451**

Product acronym	MXRT-1451
Bus compatibility	Could be installed within PCI Express x1, x8, x16 mechanical slots Works in PCI Express x1, x4, x8, x16 electrical slots / operates at x1 speed
Power consumption	17 Watt
Form factor	Low profile, half-length, 2.3"x 6.6"
Operating system	Windows 7 – 32/64-bit, Windows 8.1 – 64-bit, Windows 10 – 64-bit
Platforms	Intel® and AMD architectures
Graphics accelerator	ATI FirePro
Graphics memory	1 GB DDR3
Memory interface	64-bit
Memory bandwidth	9.6 GB/s
Pixel depth	32-bit color
Electrical standard	Single-link DVI complying to v1.0 specification
Connectors	DMS-59
Connectivity	One DMS-59-to-DVI adaptor included
Supported resolutions	2560x1600 DisplayPort, 1920x1200 DVI/Analog
DirectX support	Microsoft® DirectX v11.0
OpenGL support	OpenGL 4.1
OpenCL support	OpenCL 1.0
Approvals and compliance	FCC Part 15 Class B, CE EN 55022 Limit B, EN 55024, UL-60950-1, BMSI CNS, CISPR- 22/24, IEC609050-1, VCCI, CSA C22.2, EU RoHS directive (2011/65/EC), Certificate of Information & Communication Equipment (Republic of Korea)
Operating temperature	0° to 60°C (32° to 140° F)

**MXRT-2400**

Product acronym	MXRT-2400
Bus compatibility	PCIe Gen2 x16
Power consumption	43 Watt
Form factor	169.67 mm (L) x 64.46 mm (H) single PCIe slot wide
Operating system	Windows 7 – 32/64-bit, Windows 8.1 – 64-bit, Windows 10 – 64-bit
Platforms	Intel® and AMD architectures
Graphics accelerator	ATI FirePro
Graphics memory	512 MB DDR3
Memory interface	64-bit
Memory bandwidth	14.4 GB/s
Pixel depth	32-bit pixels (supports 8-bit and 10-bit per color channel)
Electrical standard	Dual-link DVI complying to v1.0, DisplayPort complying to v1.1a
Connectors	1- DVI-I, 1- DisplayPort
Connectivity	One DisplayPort to Single-Link DVI-I dongle included

Supported resolutions	Up to 6MP color
DirectX support	Microsoft® DirectX v11.0, Vertex Shader 5.0, Pixel Shader 5.0
OpenGL support	OpenGL 4.0
OpenCL support	OpenCL 1.0
Approvals and compliance	FCC Part 15 Class B, CE EN 55022 Limit B, EN 55024, UL-60950-1, BMSI CNS, CISPR- 22/24, IEC609050-1, VCCI, CSA C22.2, EU RoHS directive (2002/95/EC), Certificate of Information & Communication Equipment (Republic of Korea)
Operating temperature	0° to 60°C (32° to 140° F)

### MXRT-2500

Product acronym	MXRT-2500
Bus compatibility	PCIe Gen2 x16
Power consumption	50 Watt
Form factor	168 mm (L) x 68 mm (H) single PCIe slot wide
Operating system	Windows 7 – 32/64-bit, Windows 8.1 – 64-bit, Windows 10 – 64-bit
Platforms	Intel® and AMD architectures
Graphics accelerator	ATI FirePro
Graphics memory	1 GB DDR3
Memory interface	128-bit
Memory bandwidth	28.8 GB/s
Pixel depth	32-bit pixels (supports 8-bit and 10-bit per color channel)
Electrical standard	Dual-link DVI complying to v1.0, DisplayPort complying to v1.2
Connectors	1- DVI-I, 1- DisplayPort
Connectivity	One DisplayPort to Single-Link DVI-I dongle included
Supported resolutions	Up to 6MP color
DirectX support	Microsoft® DirectX v11.0, Vertex Shader 5.0, Pixel Shader 5.0
OpenGL support	OpenGL 4.2
OpenCL support	OpenCL 1.1
Approvals and compliance	FCC Part 15 Class B, CE EN 55022 Limit B, EN 55024, UL-60950-1, BMSI CNS, CISPR- 22/24, IEC609050-1, VCCI, CSA C22.2, EU RoHS directive (2011/65/EC), Certificate of Information & Communication Equipment (Republic of Korea)
Operating temperature	0° to 60°C (32° to 140° F)

### MXRT-2600

Product acronym	MXRT-2600
Bus compatibility	PCIe Gen3 x16 (wired x8)
Power consumption	26 Watt
Form factor	168 mm (L) x 68 mm (H) single PCIe slot wide
Operating system	Windows 7 – 32/64-bit, Windows 8.1 – 64-bit, Windows 10 – 64-bit
Platforms	Intel® and AMD architectures
Graphics accelerator	ATI FirePro
Graphics memory	2 GB DDR3
Memory interface	128-bit
Memory bandwidth	28.8 GB/s
Pixel depth	32-bit pixels (supports 8-bit and 10-bit per color channel)
Electrical standard	DisplayPort complying to v1.2a
Connectors	2- DisplayPort

Supported resolutions	Up to 6MP color
DirectX support	Microsoft® DirectX v11.2, Vertex Shader 5.0, Pixel Shader 5.0
OpenGL support	OpenGL 4.4
OpenCL support	OpenCL 1.2
Approvals and compliance	FCC Part 15 Class B, CE EN 55022 Limit B, EN 55024, UL-60950-1, BMSI CNS, CISPR- 22/24, IEC609050-1, VCCI, CSA C22.2, EU RoHS directive (2011/65/EU), Certificate of Information & Communication Equipment (Republic of Korea)
Operating temperature	0° to 55°C (32° to 131° F)

**MXRT-4500**

Product acronym	MXRT-4500
Bus compatibility	PCIe Gen2.1 x16
Power consumption	75 Watt
Form factor	163 mm (L) x 97 mm (H) single PCIe slot wide
Operating system	Windows 7 – 32/64-bit, Windows 8.1 – 64-bit, Windows 10 – 64-bit
Platforms	Intel® and AMD architectures
Graphics accelerator	ATI FirePro
Graphics memory	1 GB GDDR5
Memory interface	128-bit
Memory bandwidth	64 GB/s
Pixel depth	32-bit pixels (supports 8-bit and 10-bit per color channel)
Electrical standard	Dual-link DVI complying to v1.0, DisplayPort complying to v1.2
Connectors	1- DVI-I, 2- DisplayPort
Connectivity	Two DisplayPort to Single-Link DVI-I dongles included DisplayPort to Dual-Link DVI-I dongle available from Barco; Part Number K9305104
Supported resolutions	Up to 6MP color and 10MP grayscale
DirectX support	Microsoft® DirectX v11.0, Vertex Shader 5.0, Pixel Shader 5.0
OpenGL support	OpenGL 4.1
OpenCL support	OpenCL 1.1
Approvals and compliance	FCC Part 15 Class B, CE EN 55022 Limit B, EN 55024, UL-60950-1, BMSI CNS, CISPR- 22/24, IEC609050-1, VCCI, CSA C22.2, EU RoHS directive (2011/65/EC), Certificate of Information & Communication Equipment (Republic of Korea)
Operating temperature	0° to 60°C (32° to 140° F)

**MXRT-5400**

Product acronym	MXRT-5400
Bus compatibility	PCIe Gen2 x16
Power consumption	72 Watt
Form factor	230.53 mm (L) x 98.34 mm (H) single PCIe slot wide
Operating system	Windows 7 – 32/64-bit, Windows 8.1 – 64-bit, Windows 10 – 64-bit
Platforms	Intel® and AMD architectures
Graphics accelerator	ATI FirePro
Graphics memory	1 GB GDDR5
Memory interface	128-bit
Memory bandwidth	64 GB/s
Pixel depth	32-bit pixels (supports 8-bit and 10-bit per color channel)
Electrical standard	Dual-link DVI complying to v1.0, DisplayPort complying to v1.1a

Connectors	1- DVI-I, 2- DisplayPort
Connectivity	Two DisplayPort to Single-Link DVI-I dongles included DisplayPort to Dual-Link DVI-I dongle available from Barco; Part Number K9305104
Supported resolutions	Up to 6MP color and 10MP grayscale
DirectX support	Microsoft® DirectX v11.0, Vertex Shader 5.0, Pixel Shader 5.0
OpenGL support	OpenGL 4.0
OpenCL support	OpenCL 1.0
Approvals and compliance	FCC Part 15 Class B, CE EN 55022 Limit B, EN 55024, UL-60950-1, BMSI CNS, CISPR- 22/24, IEC609050-1, VCCI, CSA C22.2, EU RoHS directive (2002/95/EC), Certificate of Information & Communication Equipment (Republic of Korea)
Operating temperature	0° to 60°C (32° to 140° F)

**MXRT-5450**

Product acronym	MXRT-5450
Bus compatibility	PCIe Gen2 x16
Power consumption	72 Watt
Form factor	230.53 mm (L) x 98.34 mm (H) single PCIe slot wide
Operating system	Windows 7 – 32/64-bit, Windows 8.1 – 64-bit, Windows 10 – 64-bit
Platforms	Intel® and AMD architectures
Graphics accelerator	ATI FirePro
Graphics memory	1 GB GDDR5
Memory interface	128-bit
Memory bandwidth	64 GB/s
Pixel depth	32-bit pixels (supports 8-bit and 10-bit per color channel)
Electrical standard	Dual-link DVI complying to v1.0
Connectors	2- DVI-I
Connectivity	Dual-Link DVI Cables
Supported resolutions	Up to 6MP color and 10MP grayscale
DirectX support	Microsoft® DirectX v11.0, Vertex Shader 5.0, Pixel Shader 5.0
OpenGL support	OpenGL 4.0
OpenCL support	OpenCL 1.0
Approvals and compliance	FCC Part 15 Class B, CE EN 55022 Limit B, EN 55024, UL-60950-1, BMSI CNS, CISPR- 22/24, IEC609050-1, VCCI, CSA C22.2, EU RoHS directive (2002/95/EC), Certificate of Information & Communication Equipment (Republic of Korea)
Operating temperature	0° to 60°C (32° to 140° F)

**MXRT-5500**

Product acronym	MXRT-5500
Bus compatibility	PCIe Gen3 x16
Power consumption	75 Watt
Form factor	184.15 mm (L) x 111 mm (H) single PCIe slot wide
Operating system	Windows 7 – 32/64-bit, Windows 8.1 – 64-bit, Windows 10 – 64-bit
Platforms	Intel® and AMD architectures
Graphics accelerator	ATI FirePro
Graphics memory	2 GB GDDR5
Memory interface	256-bit

Memory bandwidth	102.3 GB/s
Pixel depth	32-bit pixels (supports 8-bit and 10-bit per color channel)
Electrical standard	Dual-link DVI complying to v1.0, DisplayPort complying to v1.2
Connectors	1- DVI-I, 2- DisplayPort
Connectivity	Two DisplayPort to Single-Link DVI-I dongles included DisplayPort to Dual-Link DVI-I dongle available from Barco; Part Number K9305104
Supported resolutions	Up to 6MP color and 10MP grayscale
DirectX support	Microsoft® DirectX v11.1, Vertex Shader 5.0, Pixel Shader 5.0
OpenGL support	OpenGL 4.2
OpenCL support	OpenCL 1.2
Approvals and compliance	FCC Part 15 Class B, CE EN 55022 Limit B, EN 55024, UL-60950-1, BMSI CNS, CISPR- 22/24, IEC609050-1, VCCI, CSA C22.2, EU RoHS directive (2011/65/EC), Certificate of Information & Communication Equipment (Republic of Korea)
Operating temperature	0° to 60°C (32° to 140° F)

**MXRT-5550**

Product acronym	MXRT-5550
Bus compatibility	PCIe Gen3 x16
Power consumption	75 Watt
Form factor	184.15 mm (L) x 111 mm (H) single PCIe slot wide
Operating system	Windows 7 – 32/64-bit, Windows 8.1 – 64-bit, Windows 10 – 64-bit
Platforms	Intel® and AMD architectures
Graphics accelerator	ATI FirePro
Graphics memory	2 GB GDDR5
Memory interface	256-bit
Memory bandwidth	102.3 GB/s
Pixel depth	32-bit pixels (supports 8-bit and 10-bit per color channel)
Electrical standard	Dual-link DVI complying to v1.0
Connectors	2- DVI-I
Connectivity	Dual-Link DVI Cables
Supported resolutions	Up to 6MP color and 10MP grayscale
DirectX support	Microsoft® DirectX v11.1, Vertex Shader 5.0, Pixel Shader 5.0
OpenGL support	OpenGL 4.2
OpenCL support	OpenCL 1.2
Approvals and compliance	FCC Part 15 Class B, CE EN 55022 Limit B, EN 55024, UL-60950-1, BMSI CNS, CISPR- 22/24, IEC609050-1, VCCI, CSA C22.2, EU RoHS directive (2011/65/EC), Certificate of Information & Communication Equipment (Republic of Korea)
Operating temperature	0° to 60°C (32° to 140° F)

**MXRT-5600**

Product acronym	MXRT-5600
Bus compatibility	PCIe Gen3 x16
Power consumption	75 Watt
Form factor	172 mm (L) x 110 mm (H) single PCIe slot wide
Operating system	Windows 7 – 32/64-bit, Windows 8.1 – 64-bit, Windows 10 – 64-bit
Platforms	Intel® and AMD architectures



Graphics accelerator	ATI FirePro
Graphics memory	4 GB GDDR5
Memory interface	128-bit
Memory bandwidth	96 GB/s
Pixel depth	32-bit pixels (supports 8-bit and 10-bit per color channel)
Electrical standard	DisplayPort complying to v1.2a
Connectors	4- DisplayPort
Supported resolutions	Up to 12MP color and 10MP grayscale
DirectX support	Microsoft® DirectX v11.2, Vertex Shader 5.0, Pixel Shader 5.0
OpenGL support	OpenGL 4.4
OpenCL support	OpenCL 1.2
Approvals and compliance	FCC Part 15 Class B, CE EN 55022 Limit B, EN 55024, UL-60950-1, BMSI CNS, CISPR- 22/24, IEC609050-1, VCCI, CSA C22.2, EU RoHS directive (2011/65/EU), Certificate of Information & Communication Equipment (Republic of Korea)
Operating temperature	0° to 45°C (32° to 113° F)

### MXRT-7400

Product acronym	MXRT-7400
Bus compatibility	PCIe Gen2 x16
Power consumption	138 Watt
Power connector	One 2x3 power connector
Form factor	281.29 mm (L) x 98.53 mm (H) single PCIe slot wide
Operating system	Windows 7 – 32/64-bit, Windows 8.1 – 64-bit, Windows 10 – 64-bit
Platforms	Intel® and AMD architectures
Graphics accelerator	ATI FirePro
Graphics memory	2 GB GDDR5
Memory interface	256-bit
Memory bandwidth	128 GB/s
Pixel depth	32-bit pixels (supports 8-bit and 10-bit per color channel)
Electrical standard	Dual-link DVI complying to v1.0, DisplayPort complying to v1.1a
Connectors	1- DVI-I, 2- DisplayPort
Connectivity	Two DisplayPort to Single-Link DVI-I dongles included DisplayPort to Dual-Link DVI-I dongle available from Barco; Part Number K9305104
Supported resolutions	Up to 6MP color and 10MP grayscale
DirectX support	Microsoft® DirectX v11.0, Vertex Shader 5.0, Pixel Shader 5.0
OpenGL support	OpenGL 4.0
OpenCL support	OpenCL 1.0
Approvals and compliance	FCC Part 15 Class B, CE EN 55022 Limit B, EN 55024, UL-60950-1, BMSI CNS, CISPR- 22/24, IEC609050-1, VCCI, CSA C22.2, EU RoHS directive (2002/95/EC), Certificate of Information & Communication Equipment (Republic of Korea)
Operating temperature	0° to 60°C (32° to 140° F)

### MXRT-7500



Product acronym	MXRT-7500
Bus compatibility	PCIe Gen3 x16
Power consumption	140 Watt

Power connector	One 2x3 power connector
Form factor	242 mm (L) x 98.53 mm (H) single PCIe slot wide
Operating system	Windows 7 – 32/64-bit, Windows 8.1 – 64-bit, Windows 10 – 64-bit
Platforms	Intel® and AMD architectures
Graphics accelerator	ATI FirePro
Graphics memory	4 GB GDDR5
Memory interface	256-bit
Memory bandwidth	154 GB/s
Pixel depth	32-bit pixels (supports 8-bit and 10-bit per color channel)
Electrical standard	DisplayPort complying to v1.2
Connectors	4- DisplayPort
Connectivity	Two DisplayPort to Single-Link DVI-I dongles included DisplayPort to Dual-Link DVI-I dongle available from Barco; Part Number K9305104
Supported resolutions	Up to 6MP color and 10MP grayscale
DirectX support	Microsoft® DirectX v11.1, Vertex Shader 5.0, Pixel Shader 5.0
OpenGL support	OpenGL 4.2
OpenCL support	OpenCL 1.2
Approvals and compliance	FCC Part 15 Class B, CE EN 55022 Limit B, EN 55024, UL-60950-1, BMSI CNS, CISPR- 22/24, IEC609050-1, VCCI, CSA C22.2, EU RoHS directive (2011/65/EC), Certificate of Information & Communication Equipment (Republic of Korea)
Operating temperature	0° to 60°C (32° to 140° F)

### MXRT-7600

Product acronym	MXRT-7600
Bus compatibility	PCIe Gen3 x16
Power consumption	150 Watt
Power connector	One 2x3 power connector
Form factor	248 mm (L) x 110 mm (H) single PCIe slot wide
Operating system	Windows 7 – 32/64-bit, Windows 8.1 – 64-bit, Windows 10 – 64-bit
Platforms	Intel® and AMD architectures
Graphics accelerator	ATI FirePro
Graphics memory	8 GB GDDR5
Memory interface	256-bit
Memory bandwidth	160 GB/s
Pixel depth	32-bit pixels (supports 8-bit and 10-bit per color channel)
Electrical standard	DisplayPort complying to v1.2
Connectors	4- DisplayPort
Supported resolutions	Up to 12MP color and 10MP grayscale
DirectX support	Microsoft® DirectX v11.2, Vertex Shader 5.0, Pixel Shader 5.0
OpenGL support	OpenGL 4.4
OpenCL support	OpenCL 1.2
Approvals and compliance	FCC Part 15 Class B, CE EN 55022 Limit B, EN 55024, UL-60950-1, BMSI CNS, CISPR- 22/24, IEC609050-1, VCCI, CSA C22.2, EU RoHS directive (2011/65/EU), Certificate of Information & Communication Equipment (Republic of Korea)
Operating temperature	0° to 45°C (32° to 113° F)



	<p>Barco NV President Kennedypark 35 8500 Kortrijk Belgium</p>		<p>MXRTs</p>
---	--	---	--------------

K5905271 /16 | 2019-08-07