

Three new species of cobitid fish (Teleostei, Cobitidae) from the River Xinjiang and the River Le'anjiang, tributaries of Lake Poyang of China, with remarks on their classification

Authors: Chen, Yongxia, and Chen, Yifeng

Source: Folia Zoologica, 62(2) : 83-95

Published By: Institute of Vertebrate Biology, Czech Academy of Sciences

URL: <https://doi.org/10.25225/fozo.v62.i2.a1.2013>

BioOne Complete (complete.BioOne.org) is a full-text database of 200 subscribed and open-access titles in the biological, ecological, and environmental sciences published by nonprofit societies, associations, museums, institutions, and presses.

Your use of this PDF, the BioOne Complete website, and all posted and associated content indicates your acceptance of BioOne's Terms of Use, available at www.bioone.org/terms-of-use.

Usage of BioOne Complete content is strictly limited to personal, educational, and non - commercial use. Commercial inquiries or rights and permissions requests should be directed to the individual publisher as copyright holder.

BioOne sees sustainable scholarly publishing as an inherently collaborative enterprise connecting authors, nonprofit publishers, academic institutions, research libraries, and research funders in the common goal of maximizing access to critical research.

Three new species of cobitid fish (Teleostei, Cobitidae) from the River Xinjiang and the River Le'anjiang, tributaries of Lake Poyang of China, with remarks on their classification

Yongxia CHEN^{1*} and Yifeng CHEN²

¹ College of Life Sciences, Hebei University, Baoding 071002, Hebei Province, China; e-mail: chen Yongxia@hbu.edu.cn

² Laboratory of Evolution and Biogeography for Freshwater Fishes, Institute of Hydrobiology, Chinese Academy of Sciences, Wuhan 430072, Hubei Province, China; e-mail: chen yf@ihb.ac.cn

Received 5 April 2012; Accepted 5 November 2012

Abstract. Three new species of *Cobitis*, *C. fasciola* sp. nov., *C. crassicauda* sp. nov. and *C. stenocauda* sp. nov. are found from the River Xinjiang and the River Le'anjiang, tributaries of Lake Poyang, belonging to the River Yangtze system, Jiangxi Province, China. These cobitid fish are described based on the morphology features such as the pigmentation pattern, shape of lamina circularis, body scales, mouth character and sequences of mitochondrial cytochrome *b* (*cyt b*) gene, which can be used for molecular identification and diagnosis of these species. Illustrations of the morphology characters of new species are given, and phylogenetic analysis identifies deoxyribonucleic acid (DNA) lineages closely related to these cobitid fish. Traditional taxonomy of cobitid fish of the subfamily Cobitinae is discussed based on the recent molecular phylogenies of these cobitid fish.

Key words: *Cobitis*, taxonomy, Jiangxi Province, molecular phylogeny

Introduction

The freshwater fish genus *Cobitis* Linnaeus, 1758, inhabiting various habitats in rivers, streams, lakes and ponds, is the largest group in the subfamily Cobitinae, widely distributed in Eurasia (excluding Tibetan Plateau) and its adjacent islands and northwestern Africa (Chen 1981, Sawada 1982). Species of *Cobitis* rarely reach 15 cm in total length and, as a result of their strong adaptation to benthic habitats, have an elongated or very elongated body covered with thick skin, strongly reduced scales and small, sometimes reduced eyes (Roberts 1989).

The River Xinjiang and the River Le'anjiang, in Jiangxi Province, are tributaries of Lake Poyang, the largest fresh water lake in China, belonging to the River Yangtze system. The River Yangtze basin is the largest river in China, and the world's third longest river, 6300 km total length, flows to East China Sea following west to east trend. Lake Poyang is located in middle and lower reaches of the River Yangtze, supplies including the River Ganjian, the River Fuhe, the River Xinjiang, the River Raohe and the River

Xiushui. The River Le'anjiang belongs to the River Raohe (Fig. 1). *C. macrostigma* Dabry, 1872, endemic to China, was the earliest record of the genus *Cobitis* in China, and it was described from the specimens collected in Lake Poyang and Lake Dongting. Later, the second species *C. sinensis* Sauvage & Dabry, 1874, was described from the upper reaches of the River Yangtze systems in western Sichuan Province. Nichols (1925) recognized the two species *C. macrostigma* and *C. sinensis* from the River Yangtze basin. Chen (1981) described another species *Cobitis rarus* (= *C. rara*) Chen, 1981, based on the specimens collected in the River Jialingjiang, the upper reaches of the River Yangtze. However, it was synonymized with *C. sinensis* by many scholars (Chen 1987, Ding 1994). The variations in morphology and colouration between the specimens were noted, but these variations were considered to be related to different habitats of the specimens studied in various environment and the varying individual size (Ding 1994). Chen & Chen (2005), based on the morphological characteristics

* Corresponding Author

of pigmentation pattern, shape of lamina circularis in males, body scales and mouth character, recognized it as valid species.

In this study, we investigated the *Cobitis* specimens collected from Lake Poyang and its tributaries, which were kept in the Freshwater Fishes Museum (FFM) of the Institute of Hydrobiology (IHB) at the Chinese Academy of Sciences (CAS) in Wuhan (Hubei Province), and found that some material represented a distinct, undescribed species. Thus, three new species are described here using data on the morphology characters and sequences of the mitochondrial cytochrome *b* (*cyt b*) gene.

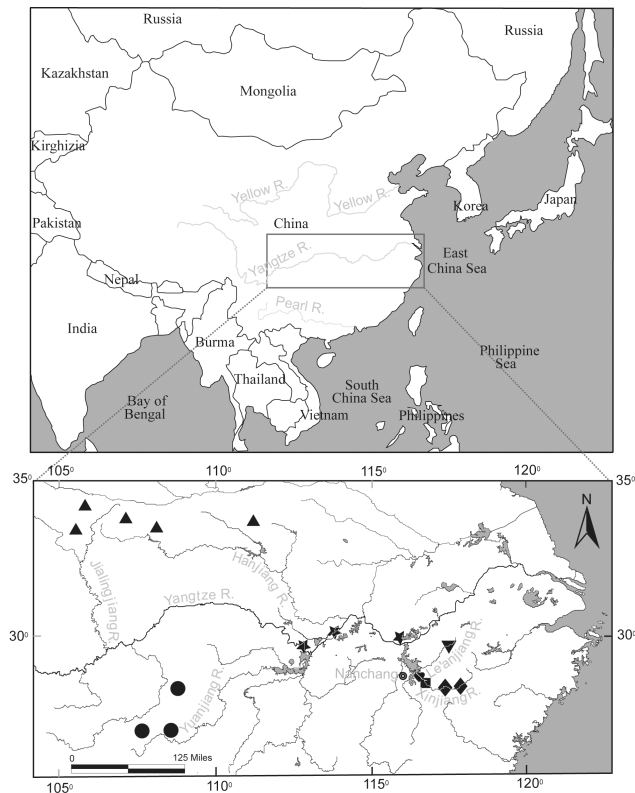

Fig. 1. Map showing the collection sites (currently known localities) of six species of loaches (Cobitidae) in the River Yangtze. (■) type locality of *C. fasciola* sp. nov., *C. crassicauda* sp. nov. and *C. stenocauda* sp. nov., (▼) the second locality of *C. fasciola* sp. nov., (♥) the second locality of *C. crassicauda* sp. nov., (◆) the second locality of *C. stenocauda* sp. nov., (▲) *C. rara*, (●) *C. sinensis*, (★) *C. macrostigma*, (◎) Guizhou City.

Material and Methods

The study was based on specimens collected using hand nets and electrofishing. Material used in evaluation of the colour patterns and morphometry was preserved in 10 % formalin, specimens for molecular analyses were taken from muscle tissue or fin, and were preserved in 95 % ethanol. All study specimens are stored in the FFM of the IHB at the CAS in Wuhan (Hubei Province).

Nineteen morphometric variables were measured according to the procedures by Chen & Chen (2011). Fin-rays (simple and branched) were counted under transmitted light using a binocular dissecting microscope. Simple rays of the dorsal, ventral and anal fins were counted anteriorposteriorly and dorsoventrally for the caudal and pectoral fins. Vertebrae (including the Weberian ossicles and the hypural complex) were counted by examination of the negatives of roentgenograms. The roentgenograms were made of the lateral aspect of the fish using a medical X-ray system. Scales were collected from the subdorsal region between dorsal fin and lateral line and photographed by using a Leica DC180 camera attached to a Leica GZ6 stereomicroscope.

We sequenced the complete mitochondrial cytochrome *b* gene of 1140 bp for 17 individuals of nine species of the genus *Cobitis*, their collection sites and their corresponding GenBank sequence Accession Nos. are listed in Table 1. Based on the recent study on the family of Cobitidae (Šlechtová et al. 2008), *Sabanejewia* Vladykov, 1929 was chosen as outgroup taxa.

Total genomic DNA was isolated by the standard phenol-chloroform method (Sambrook et al. 1989). The complete mitochondrial cytochrome *b* (*cyt b*) was amplified and sequenced using the primer L14724 (5'-GAC TTG AAA AAC CAC CGT TG-3') and H15915 (5'-CTC CGA TCT CCG GAT TAC AAG AC-3') (Xiao et al. 2001). The PCR was performed at an initial denaturation step at 95 °C for 4 min, followed by 35 cycles at 94 °C for 40 s, 52-60 °C for 45 s, 72 °C for 1 min, and a final extension at 72 °C for 8 min. The amplified fragments were purified with BioStar glass-milk DNA purification kit following the manufactures instruction. The purified fragments were sequenced by Shanghai DNA Biotechnologies Company. We used ClustalX 1.81 (Thompson et al. 1997) to align the sequences. Dataset was tested for saturation at codon position by plotting the absolute pairwise differences in transitions and transversions against the *p*-distance. The phylogenetic trees were constructed using Bayesian inference (BI) as implemented in MrBayes 3.0 (Huelsenbeck & Ronquist 2001) and Maximum likelihood (ML) as performed in MEGA 5.05 (Tamura et al. 2011). For the ML analyses, substitution model were calculated applying Tamura-Nei using rates. Nonparametric bootstrap support for internal branches was calculated for ML with 1000 pseudoreplicates. For the BI analyses, four Metropolis coupled Markov Chains Monte Carlo (MCMCMC) were run for 2 × 10⁶ generations starting with random trees under the GTR + G + I and sampling frequency of each 100

generations. The datasets were partitioned into codon positions and the parameter values were estimated during the analyses for each partition independently. Log-likelihood stability was reached after c. 60000 generations, and then we excluded the first 600 trees and used the remaining trees to compute a 50 % majority-rule consensus tree.

The sequence divergence between the different lineages was calculated with the use of a Jukes-Cantor model of substitution, with all substitution weighted equally, implemented in the program MEGA 3.1 (Kumar et al. 2004).

Results

Cobitis fasciola sp. nov. (Figs. 2A-F, 3A)

Holotype: IHB 9607002, adult male, 97.0 mm TL, 81.9

mm SL. China: Jiangxi Province, Yujiang County, the River Xinjiang drainage, 28°12' N, 116°49' E, July 1996.

Paratypes: IHB 9607001-10, 10 males, 83.9-100.4 mm TL, 70.9-84.4 mm SL; IHB 9607012-50, 39 females, 111.6-121.3 mm TL, 81.9-103.1 mm SL; data as for holotype; IHB 0509339-343, 0509351, 0509358, 0509362, 0509365, nine males, 90.6-101.5 mm TL, 88.5-85.6 mm SL; IHB 0509344-350, 0509352-3, 0509355, 0509357, 0509359-61, 0509364, 15 females, 112.6-129.2 mm TL, 82.3-105.8 mm SL; the River Xinjiang, Yujiang County, October 2005; IHB 90v1866, male, 111.9 mm TL, 93.3 mm SL; IHB 90v1868, female, 114.6 mm TL, 95.1 mm SL; the River Le'anjiang, Wuyuan County, Jiangxi Province, May 1990.

Table 1. Taxa analysed in this study, their sites of origin and their GenBank Accession numbers.

Scientific name in source	Locality	Accession Nos.
<i>Cobitis sinensis</i> 1	China, Guizhou, R. Yuangjiang	JX888902
<i>Cobitis sinensis</i> 2	China, Guizhou, R. Yuangjiang	
<i>Cobitis macrostigma</i>	China, Jiangxi, L. Poyang	JX888904
<i>Cobitis dolichorhynchus</i> 1	China, Fujian, R. Jiulongjiang	JX888908
<i>Cobitis dolichorhynchus</i> 2	China, Fujian, R. Jiulongjiang	
<i>Cobitis lutheri</i> 3	China, Heilongjiang, R. Heilongjiang	JX888906
<i>Cobitis lutheri</i> 4	China, Heilongjiang, R. Heilongjiang	
<i>Cobitis microcephala</i> 1	China, Guangxi, R. Nanlijiang	JX888907
<i>Cobitis microcephala</i> 2	China, Guangxi, R. Nanlijiang	
<i>Cobitis fasciola</i>1 sp. nov.	China, Jiangxi, R. Xinjiang, Yujiang County	JX888910
<i>Cobitis fasciola</i>2 sp. nov.	China, Jiangxi, R. Xinjiang, Yujiang County	
<i>Cobitis crassicauda</i>1 sp. nov.	China, Jiangxi, R. Xinjiang, Yujiang County	JX888909
<i>Cobitis crassicauda</i>2 sp. nov.	China, Jiangxi, R. Xinjiang, Yujiang County	
<i>Cobitis crassicauda</i>3 sp. nov.	China, Jiangxi, R. Xinjiang, Yujiang County	
<i>Cobitis stenocauda</i>1 sp. nov.	China, Jiangxi, R. Xinjiang, Guixi County	JX888903
<i>Cobitis stenocauda</i>2 sp. nov.	China, Jiangxi, R. Xinjiang, Guixi County	
<i>Cobitis arenae</i>	China, Hainan, R. Nanduijiang	JX888905
<i>Cobitis melanoleuca</i>	Šlechtová et al. (2008)	EF508500*
<i>Cobitis pacifica</i> 1	Šlechtová et al. (2008)	EF508505*
<i>Cobitis pacifica</i> 2	Šlechtová et al. (2008)	EF508506*
<i>Cobitis rara</i>	Šlechtová et al. (2008)	EF508507*
<i>Cobitis granoei</i>	Tang et al. (2005)	DQ105242*
<i>Cobitis</i> cf. <i>granoei</i>	Tang et al. (2005)	DQ105243*
<i>Cobitis lutheri</i> 1	Šlechtová et al. (2008)	EF508498*
<i>Cobitis lutheri</i> 2	Šlechtová et al. (2008)	EF508499*
<i>Iksookimia koreensis</i>	Šlechtová et al. (2008)	EF508511*
<i>Cobitis choii</i>	Šlechtová et al. (2008)	EF508510*
<i>Iksookimia longicarpa</i> 1	Šlechtová et al. (2008)	EF508513*
<i>Iksookimia longicarpa</i> 2	Šlechtová et al. (2008)	EF508514*
<i>Iksookimia pumila</i>	Šlechtová et al. (2008)	EF508515*
<i>Iksookimia yongdokensis</i>	Šlechtová et al. (2008)	EF508516*
<i>Kichulchoia brevifasciata</i> 1	Šlechtová et al. (2008)	EF508518*
<i>Kichulchoia brevifasciata</i> 2	Šlechtová et al. (2008)	EF508519*
<i>Sabanejewia balcanica</i>	Perdices & Doadria (2001)	AF499190*

Sequences marked with * were retrieved from GenBank.

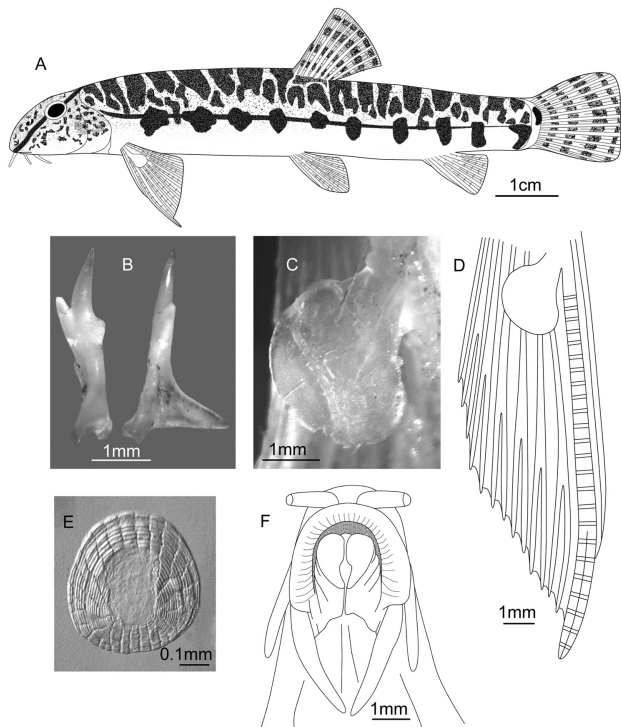

Fig. 2. *C. fasciola* sp. nov. A, holotype, IHB 9607002, male, 97.0 mm TL, 81.9 mm SL. The River Xinjiang drainage, China; B, suborbital spine; C-D, lamina circularis in the pectoral fin of male; E, subdorsal scales; F, mouth characters.

Diagnosis: *Cobitis fasciola* sp. nov. co-occurs with *C. crassicauda* sp. nov. and *C. stenocauda* sp. nov. in the River Xinjiang. It is easily distinguished from other *Cobitis* species by its unusual pigmentation pattern, on dorsum 12-16 large vertical bands from the occiput to the base of caudal fin, the bands continuous in midlateral line blotches, first band small, 6-7 vertical bands at anterior dorsal fin base, two bands at dorsal fin base, 5-7 bands between posterior dorsal fin base and caudal flexure; males with an oval lamina circularis; rounded scales with a small focal area. It can be distinguished from *C. crassicauda* sp. nov. by shorter snout length (snout length 2.1-2.6 (mean 2.3) times of head length in males and 2.0-2.4 (mean 2.2) in females, 2.5 in males, and 2.5-2.9 (mean 2.7) in females in *C. crassicauda*), shorter pectoral-ventral length (pectoral-ventral length 3.1-3.6 (mean 3.3) times of standard length in males and 2.9-3.5 (mean 3.1) in females, 2.9 in males and 2.7-3.0 (mean 2.9) in females in *C. crassicauda*), shorter pectoral-ventral length (pectoral-ventral length 3.1-3.6 (mean 3.3) times of standard length in males and 2.9-3.5 (mean 3.1) in females, 2.9 in males and 2.7-3.0 (mean 2.9) in females in *C. crassicauda*), shorter pectoral-ventral length (ventral length 7.1-8.3 (mean 7.9) times of standard length in males and 8.1-10.2 (mean 9.1) in females, 7.0 in males and 8.1-8.4 (mean 8.3) in females in *C. crassicauda*). It can be distinguished from *C. stenocauda* by its shorter caudal peduncle (caudal peduncle depth 1.2-1.5 (mean 1.4) times of its length in males, and 1.2-1.6 (mean 1.4) in females, 1.7 in males and 1.6-2.3 (mean

1.9) in females in *C. stenocauda*), shorter ventral fin (ventral length 7.1-8.3 (mean 7.9) times of standard length in males and 8.1-10.2 (mean 9.1) in females, 7.1 in males and 7.6-9.3 (mean 8.6) in females in *C. stenocauda*).

Description: Morphometric characters are given in Table 2. D. III-7; A. III-5; V. II-5; P. I-8; C. VI-16-V. Vertebrae 4 + 39-40 + 1. Body elongated, laterally compressed. Depth of the space between nape and dorsal fin base homogenous and slightly decreasing towards caudal-fin base. Head slightly longer, laterally compressed, snout bluntly rounded, preorbital part of the head slightly longer than the postorbital part. Mouth small, inferior, and arched. Three pairs of barbels, of which one is rostral, one is maxillary and a third maxillo-mandibular barbels, which length equal to or slightly shorter than eye diameter. Mental lobe undeveloped. Eyes located on upper and middle of head. Interorbital width equal to or slightly wider than eye diameter. Suborbital spine bifid, situated in front of eyes, extended posteriorly to beneath the middle of the eyes.

Head without scales, body scales round, with a slightly small excentric focal area (being closer to the base), and 25-33 radial grooves, and 9-11 supplementary grooves. Lateral line short, not exceeding posteriorly to beneath the length of pectoral fins.

Dorsal fin is inserted almost in the middle or caudal half of the body. Dorsal fin long, tip blunt. Dorsal fin shorter than head. In males, pectoral fins long, the second ray being longer and thicker, 1.0-1.3 (mean 1.2) times of head length. In females, the third pectoral ray being longer, 1.4-1.9 (mean 1.6) times of head length. Ventral fins short, located approximately at the same level with the second branched dorsal ray. Anal fin small, located on half of the space between the ventral and caudal fins. Caudal fin long, tip emarginated, Ventral adipose crest between the anal and caudal fins. Anal near the anal fin.

Pigmentation pattern: This species is characterized by absence of Gambetta's pigmentation pattern (Figs. 2A, 3A). On dorsum 12-16 large vertical bands from the occiput to the base of caudal fin, the bands continuous midlateral line blotches, first band small, 6-7 vertical bands at anterior dorsal fin base, two bands at dorsal fin base, 5-7 bands between posterior dorsal fin base and caudal flexure. In some females, behind head 4-5 vertical stripes. 8-11 large oval and prolong blotches below midlateral line of body, the gap of oval blotches broader than the oval blotches. Less than 10 irregular bars speckles on dorso-lateral, bars decreasing towards caudal fin base. One conspicuous

Table 2. Morphometric and meristic characters for *Cobitis fasilolata* sp. nov., *Cobitis crassicauda* sp. nov. and *Cobitis stenocauda* sp. nov.

Variable	<i>Cobitis fasilolata</i> sp. nov.						<i>Cobitis crassicauda</i> sp. nov.						<i>Cobitis stenocauda</i> sp. nov.					
	Males (n = 11)			Females (n = 25)			Males (n = 3)			Females (n = 25)			Males (n = 12)			Females (n = 20)		
	Holotype	Range	Mean	Range	Mean	Holotype	Mean	Holotype	Mean	Range	Mean	Holotype	Range	Mean	Range	Mean		
TL	97.0	83.9-114.6	94.0	96.6-121.3	105.8	82.5	81.0	87.3-98.1	93.0	77.8	74.9-87.1	82.1	90.4-109.2	98.8				
SL	81.9	70.9-84.4	77.4	81.9-103.1	89.8	68.1	67.6	72.9-81.6	78.3	64.6	74.9-87.1	68.4	75.9-91.5	83.4				
SL/BD	6.2	5.8-6.4	6.1	5.6-6.6	6.3	5.4	5.7	4.8-5.5	5.2	5.6	5.6-7.1	6.3	5.7-7.6	6.8				
SL/HL	4.7	4.6-5.7	4.8	4.7-5.4	5.0	4.8	4.9	4.8-5.3	5.1	4.8	4.6-6.9	5.0	4.7-5.4	5.1				
SL/CPL	8.2	6.1-8.2	7.1	6.2-8.2	7.0	8.1	8.6	7.5-8.5	8.0	6.4	5.8-7.4	6.5	5.4-7.4	6.4				
SL/CPD	9.7	8.9-10.9	9.8	8.6-10.5	10.0	8.8	9.4	8.6-9.1	8.9	10.4	10.4-12.2	11.2	11.5-13.3	12.3				
SL/PVL	3.3	3.1-3.6	3.3	2.9-3.5	3.1	2.7	2.9	2.7-3.0	2.9	3.0	3.0-3.6	3.3	2.9-4.9	3.3				
SL/CL	5.0	4.7-5.7	5.2	4.8-6.3	5.5	5.0	5.0	5.1-5.5	5.4	5.2	4.5-5.3	4.9	4.9-6.0	5.3				
SL/DFL	5.9	5.6-6.3	5.9	5.5-7.7	6.7	5.5	5.7	5.5-6.3	5.9	5.7	4.9-6.1	5.5	6.0-7.4	6.6				
SL/DBL	10.5	8.5-10.8	9.8	8.9-11.8	9.9	9.8	9.1	9.2-10.3	9.6	9.3	7.8-12.2	9.4	8.6-10.9	9.7				
SL/PFL	5.5	4.8-6.2	5.6	6.9-9.0	7.9	5.5	5.2	7.1-7.6	7.4	5.3	5.3-6.3	5.7	7.0-9.3	8.1				
SL/VFL	8.0	7.1-8.3	7.9	8.1-10.2	9.1	6.8	7.0	8.1-8.4	8.3	7.3	6.6-7.9	7.3	7.6-9.3	8.6				
SL/AFL	6.9	6.3-8.5	7.1	7.1-9.3	8.4	7.5	7.8	8.1-9.4	8.8	7.9	6.2-8.3	7.1	7.4-10.1	8.8				
SL/ABL	14.1	11.7-14.3	12.9	12.4-16.2	14.1	13.2	14.0	14.0-15.0	14.3	11.6	11.2-14.7	12.3	12.3-15.2	13.5				
SL/PrDL	1.9	1.8-2.0	1.9	1.8-2.0	1.9	1.8	1.9	1.9-2.0	1.9	2.0	1.9-2.2	2.0	1.9-2.1	2.0				
SL/PrVL	1.8	1.8-1.9	1.8	1.7-1.9	1.8	1.7	1.7	1.6-1.8	1.7	1.8	1.8-1.9	1.8	1.8-2.0	1.9				
SL/PrAL	1.3	1.2-1.3	1.3	1.2-1.3	1.3	1.2	1.2	1.2-1.3	1.2	1.3	1.3-1.3	1.3	1.2-1.3	1.3				
HL/PrOL	2.2	2.1-2.6	2.3	2.0-2.4	2.2	2.3	2.5	2.5-2.9	2.7	2.3	1.6-2.3	2.1	2.0-2.4	2.2				
HL/ED	5.5	5.1-7.1	6.1	5.9-7.5	6.6	6.7	6.5	6.0-7.2	6.6	6.6	5.0-6.9	6.2	5.7-7.6	6.8				
HL/IW	6.0	5.6-6.7	6.3	6.1-8.9	7.2	5.4	5.7	5.8-7.2	6.5	6.8	5.3-8.5	6.9	6.0-11.3	8.4				
CPL/CPD	1.2	1.1-1.5	1.3	1.2-1.6	1.4	1.1	1.1	1.1-1.2	1.1	1.6	1.6-2.0	1.7	1.6-2.3	1.9				

ABL, Anal fin bases length; AFL, Anal fin length; BD, Body depth; CL, Caudal fin length; CPD, Caudal peduncle depth; CPL, Caudal peduncle length; DBL, Dorsal fin bases length; DFL, Dorsal fin length; ED, Eye diameter; HL, Head length; IW, Interorbital width; PFL, Pectoral fin length; PrAL, Preanal length; PrDL, Predorsal length; PrOL, Preorbital length; PrVL, Preventral length; PVL, Pectoral-ventral length; SL, Standard length; TL, Total length; VFL, Ventral fin length.

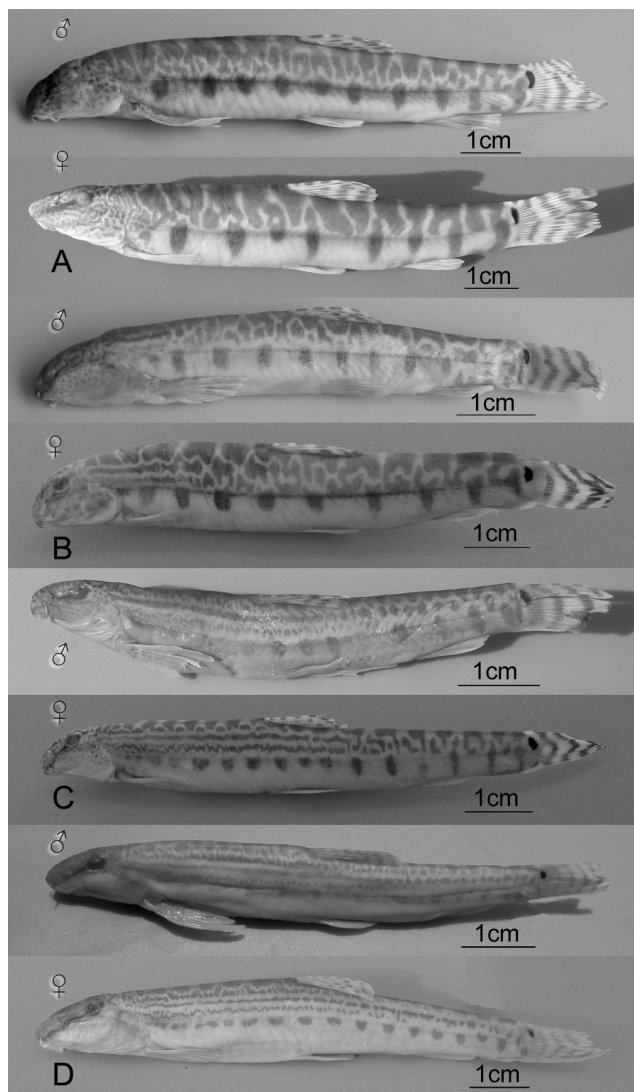

Fig. 3. A, *C. fasciola* sp. nov. male, holotype, IHB 9607002, female, IHB 9607018; B, *C. crassicauda* sp. nov. male, holotype, IHB 9607027, female, IHB 9607078; C, *C. stenocauda* sp. nov. male, holotype, IHB 9607072, female, IHB 9607058; D, *C. dolichorhynchus*.

an arcuate black blotch on upper half of caudal fin base. 3-4 rows of brownish dots on the dorsal and caudal fins. The head sprinkled with many worm-like stripes, a black stripe from the occiput through eye to the insertion of the rostral barbel.

Sexual dimorphism: Males are smaller than females, with proportionally longer pectoral, ventral, dorsal and anal fins. The base of anal fin of the males is also longer than in the females. Caudal peduncle depth of the males is bigger than of the females. In males, the second pectoral ray is thickened and elongated. A round lamina circularis is at the base of second ray of pectoral fin.

Distribution: This new species occurs in the lower reaches of the River Xinjiang and the River Le'anjiang, tributaries of Lake Poyang, belonging

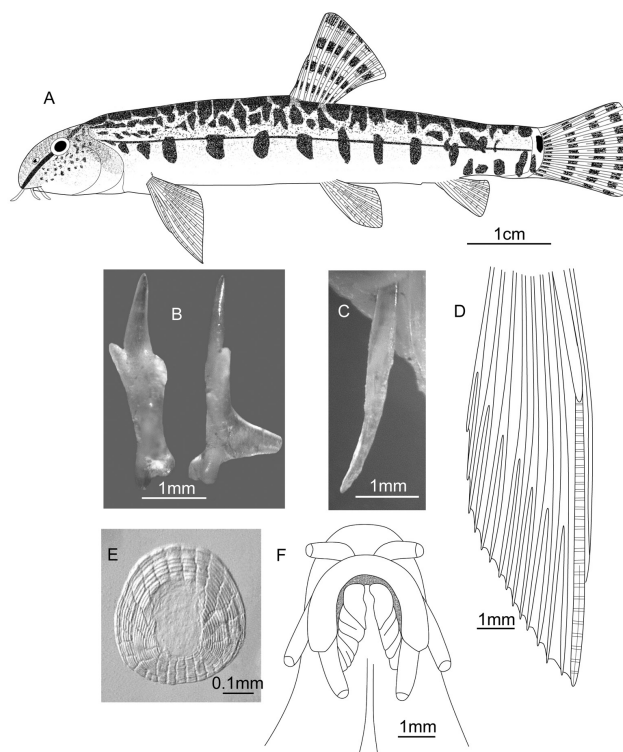

Fig. 4. *C. crassicauda* sp. nov. A, holotype, IHB 9607027, male, 73.5 mm TL, 62.3 mm SL. The River Xinjiang drainage, China; B, suborbital spine; C-D, lamina circularis in the pectoral fin of male; E, subdorsal scales; F, mouth characters.

to the River Yangtze system (Fig. 1). Two other species, *C. crassicauda* and *C. stenocauda*, are known to co-occur only in the River Xinjiang basin with *C. fasciola*. Collections of these species are few but it does not appear that these three species are broadly sympatric within the basin. *C. fasciola* and *C. crassicauda* occur in lower reaches of the River Xinjiang basin, especially, *C. crassicauda* occurs in near Lake Poyang, while *C. fasciola* no found in near Lake Poyang. *C. stenocauda* mainly occurs in the upper-middle reaches of the River Xinjiang, and few found in the lower. It is not known if they live syntopically. All three species, however, have been collected from the Yujiang County.

Etymology: The species name *fasciola* is Latin for “with lateral stripe”, and refers to the colour pattern consisting of lateral vertical bars on body side. Used as a noun.

Cobitis crassicauda sp. nov. (Figs. 4A-F, 3B)

Holotype: IHB 9607027, adult male, 73.5 mm TL, 62.3 mm SL; China: Jiangxi Province, Yujiang County, the River Xinjiang drainage, 28°12' N, 116°49' E, July 1996.

Paratypes: IHB 9607076-7, two males, 74.3-82.5 mm TL, 62.5-68.1 mm SL; IHB 9607078-80, three

females, 93.3-98.1 mm TL, 79.8-81.6 mm SL, data as for holotype. IHB 90iv0287, male, 86.1 mm TL, 72.2 mm SL; IHB 90iv0291, female, 87.3 mm TL, 72.9 mm SL, Yujiang County, April 1990. IHB 0509336, 0509356, 0509354, three males, 65.4-89.1 mm TL, 53.8-95.5 mm SL; IHB 0509327-335, 0509363, 0509357, 11 females, 63.8-95.5 mm TL, 52.8-78.4 mm SL, Yujiang County, the River Xinjiang, October 2005. IHB 05090381-390, 303, 11 females, 65.8-83.5 mm TL, 53.9-70.9 mm SL, Jinxian County, the River Xinjiang, October 2005.

Diagnosis: *Cobitis crassicauda* is distinguishable from its congeners by the following combination of characters: two stripe above lateral line, exceeding posteriorly the length of pectoral fins, and then scattered cloudy speckles between dorsal blotches and lateral spots; 10-13 prolonged oval blotches along midlateral line of body; a single distinct black prolong or semicircular spot at the base of the caudal fin; males with a slender and long needle-shaped lamina circularis; scales slightly prolonged, with small focal area; caudal peduncle short (caudal peduncle depth 1.1-1.2 (mean 1.1) times of its length in females and 1.1 in males); vertebrae 4 + 37-38 + 1. Features distinguishing *C. crassicauda* from *C. fasciola* sp. nov. have been listed above under the diagnosis of *C. fasciola*. *C. crassicauda* can be distinguished from *C. stenocauda* by its shorter caudal peduncle (caudal peduncle depth 1.1-1.2 (mean 1.1) times of its length in females and 1.1 in males, 1.7 in males and 1.6-2.3 (mean 1.9) in females in *C. stenocauda*), longer pectoral-ventral length (pectoral-ventral length 2.9 times of standard length in males and 2.7-3.0 (mean 2.9) in females, 3.1 in males and 2.9-4.9 (mean 3.3) in females in *C. stenocauda*), shorter ventral fin (ventral length 7.0 times of standard length in males and 8.1-8.4 (mean 8.3) in females, 7.1 in males and 7.6-9.3 (mean 8.6) in females in *C. stenocauda*).

Description: Morphometric characters are given in Table 2. D. III-7; A. III-5; V. II-5; P. I-8; C. VI-16-V. Head, body and caudal peduncle laterally compressed. Depth of between nape and dorsal fin base homogenous and slightly decreasing towards caudal-fin base. Head small, snout bluntly rounded. Preorbital part of the head slightly shorter than the postorbital part. Eyes small, on upper lateral surface of head close to snout than to gill opening. Interorbital width equal to or slightly wider than eye diameter. Mouth small, inferior, with three pairs of barbels. Maxillo-mandibular barbels extend caudally not to underneath the eyes. Upper lip thin, lower lip divided into two mental lobes with pointed tips. Anterior

nasal tube near the posterior orifice, closer to eye than to tip of snout. Suborbital spine situated in front of eyes, which bifid, extended posteriorly to beneath the middle of the eyes.

Body covered by minute, slightly prolong scales, with a slightly small focal area, and 32-35 radial grooves, with 6-10 supplementary grooves; no scales on cheek and part of operculum. Lateral line short, not exceeding posteriorly the length of pectoral fins.

Dorsal fin located in the middle of the anterior eyes and the base of the caudal fin. In males, pectoral fins long, the second pectoral ray being longer and thicker, while in females, the third pectoral ray being longer. Ventral fins short, small, and approximately at the same level with the third branched dorsal ray. Anal fin short, far behind dorsal extremity, caudal fin long, tip emarginated. Anal near the anal fin. Ventral adipose crest between the anal and caudal fins.

Pigmentation pattern: *Cobitis crassicauda* does not reveal the Gambetta's pigmentation pattern (Figs. 4A, 3B). On dorsum 12-16 long transverse bands from the occiput to the base of the caudal fin, bands broader than their interspaces, the dorsal fin being placed generally in the middle two blotches; two stripe above lateral line, exceeding posteriorly the length of pectoral fin, and then scattered cloudy speckles on dorso-lateral of body; a row of 10-13 prolonged oval blotches along midlateral line of the body, and reaching to the abdomen behind the anal orifice; a distinct black prolong or semicircular spot at the base of the caudal fin; 3-4 rows of brownish dots on dorsal and caudal fins; many black dots and speckles sprinkled on the head, a black stripe from the occiput through eye to the insertion of the rostral barbel.

Sexual dimorphism: Males are smaller than females, with proportionally longer pectoral, ventral, anal fins. The base of anal fin of the males is longer than in the females. In males, the second pectoral ray is thickened and elongated, whereas in females, the third pectoral ray is elongated. A needle-shaped lamina circularis is at the base of second ray of pectoral fin.

Distribution: This new species occurs in the lower reaches of the River Xinjiang, a tributary of Lake Poyang, belonging to the River Yangtze system (Fig. 1). Two other species, *C. fasciola* and *C. stenocauda*, also live in the River Xinjiang basin in Yujiang County section, but the two other species were not found in Jinxian County section, near Lake Poyang.

Etymology: From the Latin *crassus*, meaning thick, and *cauda*, meaning tail, in reference to the caudal peduncle is thick. Used as a noun.

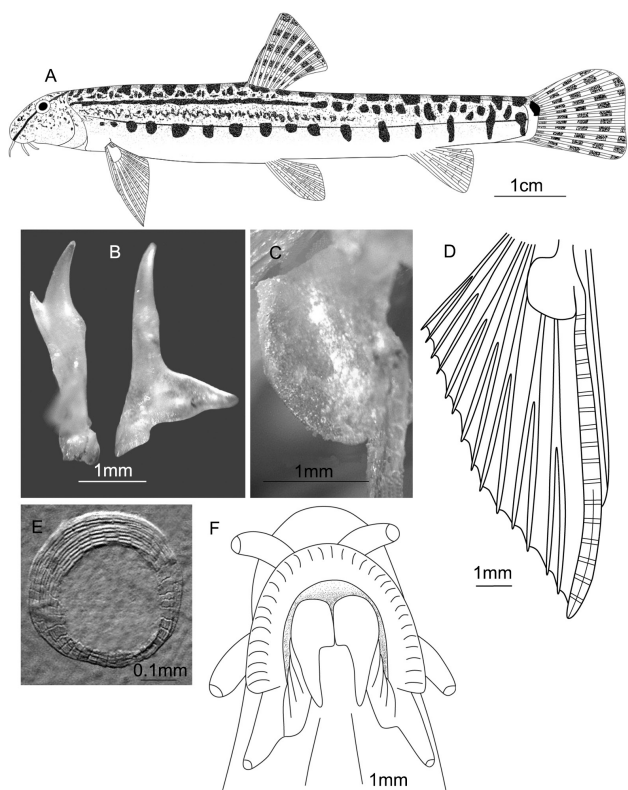

Fig. 5. *C. stenocauda* sp. nov. A, holotype, IHB 9607072, male, 77.8 mm TL, 64.6 mm SL. The River Xinjiang drainage, China; B, suborbital spine; C-D, lamina circularis in the pectoral fin of male; E, subdorsal scales; F, mouth characters.

Cobitis stenocauda sp. nov. (Figs. 5A-F, 3C)

Holotype: IHB 9607072, adult male, 77.8 mm TL, 64.6 mm SL; China: Jiangxi Province, Guixi County, the River Xinjiang, 28°24' N, 117°19' E, July 1996.

Paratypes: IHB 9607073, male, 74.9 mm TL, 62.8 mm SL; IHB 9607051-68, 9607071, 19 females, 90.4-109.2 mm TL, 75.9-91.5 mm SL; data as for holotype; IHB 0509380, 0509204-215, 13 males, 79.4-86.5 mm TL, 65.6-73.6 mm SL; IHB 0509377-379, 0509372-374, six females, 90.2-109.6 mm TL, 77.4-92.0 mm SL; Yujiang County, Yiyang County, and Guixi County, the River Xinjiang, October 2005.

Diagnosis: *Cobitis stenocauda* sp. nov. co-occurs with *C. fasciola* and *C. crassicauda* in the River Xinjiang. It is easily distinguished from other *Cobitis* species by its heart-shaped lamina circularis; almost rounded scales with a large excentric focal area. Features that distinguish *C. stenocauda* from *C. fasciola* and *C. crassicauda* were discussed above under their respective diagnosis.

Description: Morphometric characters are given in Table 2. D. III-7; A. III-5; V. II-5; P. I-8; C. VI-16-V. Vertebrae 4 + 39 + 1. Body medium, elongated and laterally compressed. Abdomen rounded, dorsal and ventral lines in abdominal region almost parallel. Head

small, laterally compressed. Preorbital part of the head slightly longer than the postorbital part. Three pairs of barbels, which length equal to or slightly longer than eye diameter. Mental lobe developed. Eyes located on upper and middle of the head. Interorbital width equal to or slightly narrower than eye diameter. Suborbital spine bifid, situated in front of eyes, extended posteriorly to beneath the middle of eyes.

Head without scales, body scales almost round, with a large excentric focal area, and 26-29 radial grooves, and 8-12 supplementary grooves. Lateral line short, not exceeding posteriorly to beneath the length of pectoral fins.

Dorsal fin is inserted in the middle of the body, dorsal fin slightly long, tip blunt. Dorsal fin shorter than head. In males, pectoral fins long, the second pectoral ray being longer and thicker, 1.1-1.2 (mean 1.2) times of head length. In females, the third pectoral ray being longer, 1.3-1.8 (mean 1.6) times of head length. Ventral fins short, small, and approximately at the same level with the dorsal fin. Anal fin small, located on the caudal half of the ventral and caudal fins. Caudal fin long, tip emarginated. Ventral adipose crest between the anal and caudal fins. Anus near the anal fin.

Pigmentation pattern: This species is characterized by having all five Gambetta's pigmentations (Figs. 5A, 3C). L_1 is composed of 17-25 rectangular blotches, rectangular blotch width slightly narrow (the description follows Takeda & Fujie (1945), who revised the Gambetta's pigmentation pattern (Gambetta 1934), described five longitudinal lines of dark speckles on the dorsolateral of the body (L_1 - L_5 , dorsal to ventral, respectively). L_2 spots with a row of irregularly dots that are fused but never fused in a band. L_3 shows a narrow dark stripe traced at the anal fin, and then is a row of blotches. L_4 usually well developed and often the broad striation can be traced beyond the anal fin. L_5 is consists of 13-17 large oval blotches. The upper caudal spot forms an oval black blotch. There are four or five striations on the dorsal and caudal fins. The head is sprinkled with many black spots, a black stripe from the occiput through eye to the insertion of the rostral barbel.

Sexual dimorphism: Males are smaller than females with proportionally longer pectoral, ventral fins. Ventral fin is inserted from more posterior part in females. The caudal peduncle is higher in males. In males, the second pectoral ray is thickened and elongated. A heart-shaped lamina circularis is at the base of second ray of pectoral fins.

Distribution: *Cobitis stenocauda* has a wide distribution. It is known from the upper-middle reaches of the River

Xinjiang in Geyang County and Guixi County section, and also occurs in the lower reaches of the River Xinjiang in Yujiang County section (Fig. 1). Though a few specimens were found in Yujiang County, but co-occur with *C. crassicauda* and *C. fasciola* in the area. **Etymology:** From the Latin *stenos*, meaning narrow, and *cauda*, meaning tail, in reference to the caudal peduncle is slender and long. Used as a noun.

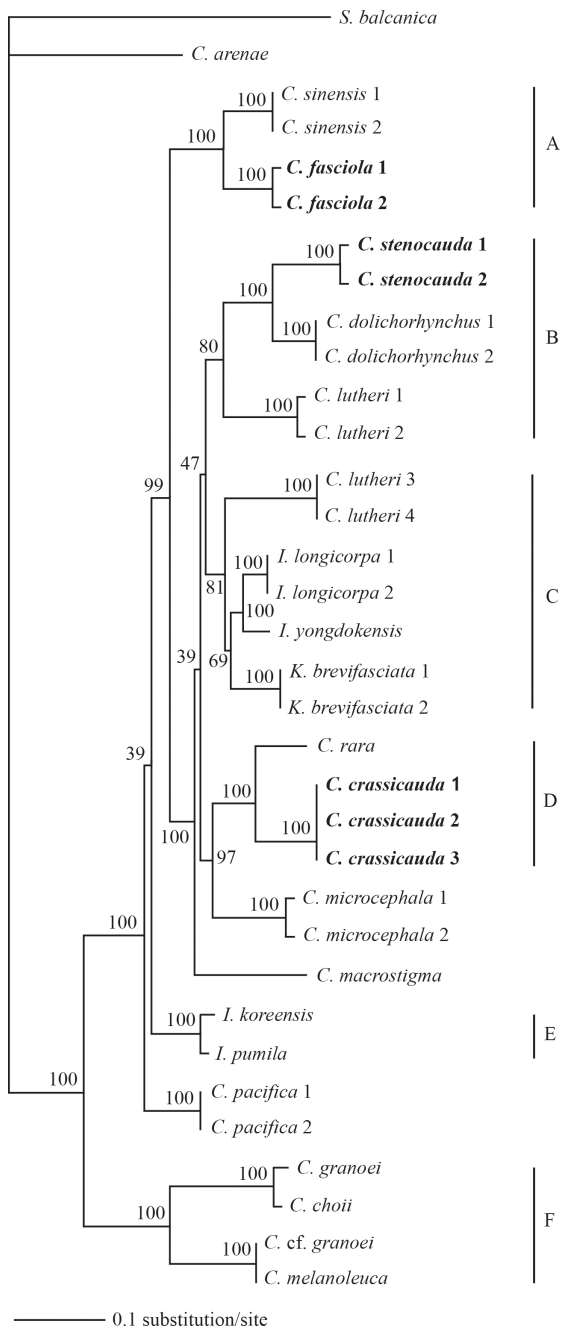

Fig. 6. Bayesian phylogeny of 26 mitochondrial cytochrome *b* lineages of *Cobitis* spp., five lineages of *Iksookimia* spp., two lineages *Kichulchoia* spp. and one lineage *Sabanejewia balcanica* used as out-groups. The lineages are numbered as in Table 1. Upper values at the branches correspond to Bayesian posterior probabilities.

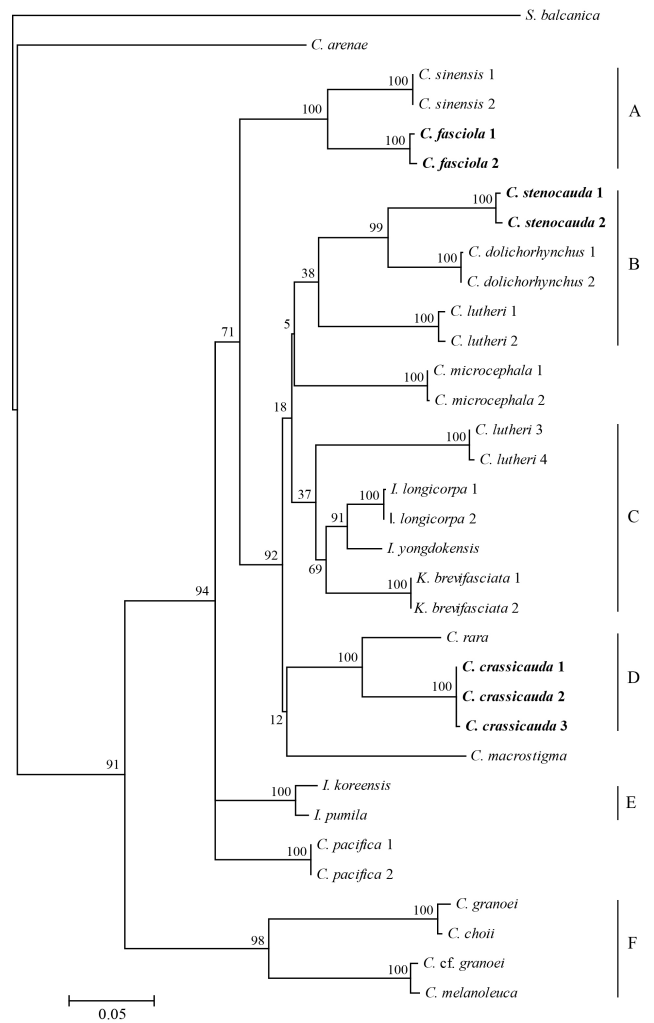

Fig. 7. Maximum likelihood tree based on Tamura-Nei model calculated in MEGA 5.05 based on entire cytochrome *b* sequences. Bootstrap percentages are shown on branches.

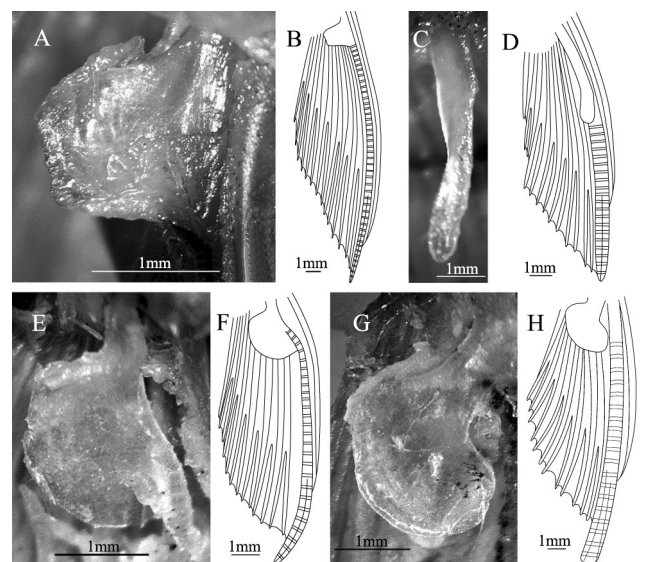

Fig. 8. Comparison of the morphology of the pectoral fins with an osseous lamina circularis in males. A-B, *C. macrostigma*; C-D, *C. dolichorhynchus*; E-F, *C. sinensis*; G-H, *C. rara*.

Table 3. The sequence divergence (in percentage) between mitochondrial cytochrome *b* lineages of the species of *Cobitis*.

Species	1	2	3	4	5	6	7	8	9	10	11	12	13	14	15	16	17	18	
1 <i>C. sinensis</i> 1																			
2 <i>C. sinensis</i> 2	0																		
3 <i>C. stenocauda</i> 1	14.6	14.6																	
4 <i>C. stenocauda</i> 2	14.5	14.5	0.6																
5 <i>C. macrostigma</i>	13.6	13.6	14.7	14.6															
6 <i>C. lutheri</i> 3	12.7	12.7	13.1	13.2	12.5														
7 <i>C. lutheri</i> 1	12.6	12.6	12.3	12.3	11.7	11.5													
8 <i>C. lutheri</i> 2	12.5	12.5	12.5	12.5	11.7	12.1	0.7												
9 <i>C. lutheri</i> 4	12.8	12.8	13.4	13.5	12.6	0.3	11.6	12.2											
10 <i>C. rara</i>	14.2	14.2	13.4	13.5	12.7	12.3	11.6	11.4	12.0										
11 <i>C. microcephala</i> 1	12.2	12.2	12.4	12.2	11.8	11.9	11.8	11.4	12.0	11.0									
12 <i>C. microcephala</i> 2	12.3	12.3	12.5	12.3	11.7	12.0	11.9	11.5	12.1	11.1	0.1								
13 <i>C. dolichorhynchus</i> 1	14.0	14.0	8.4	8.5	13.4	12.3	11.4	11.4	12.6	11.0	11.7	11.8							
14 <i>C. dolichorhynchus</i> 2	13.8	13.8	8.5	8.6	13.3	12.4	11.3	11.3	12.5	10.9	11.8	11.9	0.1						
15 <i>C. crassicauda</i> 1	14.0	14.0	13.0	13.1	12.4	11.9	12.4	12.3	11.8	7.7	12.6	12.7	12.9	12.8					
16 <i>C. crassicauda</i> 2	14.0	14.0	13.0	13.1	12.4	11.9	12.4	12.3	11.8	7.7	12.6	12.7	12.9	12.8	0				
17 <i>C. crassicauda</i> 3	13.7	13.7	13.0	13.1	12.4	11.9	12.4	12.3	11.8	7.9	12.6	12.7	12.9	12.8	0.2	0.2			
18 <i>C. fasciola</i> 1	8.0	8.0	14.7	14.5	13.1	13.6	12.0	11.9	13.7	13.6	13.2	13.3	13.0	12.9	12.3	12.3	12.2		
19 <i>C. fasciola</i> 2	8.0	8.0	14.8	14.8	13.3	14.1	12.4	12.1	14.2	14.0	13.2	13.3	13.1	13.0	12.4	12.4	12.3	12.3	0.6

Table 4. The sequence divergence (in percentage) between mitochondrial cytochrome *b* lineages of species of *Cobitis*, *Iksookimia* and *Kichulchoia*.

Species	1	2	3	4	5	6	7	8	9	10	11	12	13	14	15	16
1 <i>I. koreensis</i>																
2 <i>I. yongdokensis</i>	10.7															
3 <i>I. longicorpa</i> 1	10.8	4.0														
4 <i>I. longicorpa</i> 2	10.7	3.9	0.1													
5 <i>I. pumila</i>	2.0	11.0	11.0	10.9												
6 <i>K. brevifasciata</i> 1	12.0	6.4	6.9	6.8	12.2											
7 <i>K. brevifasciata</i> 2	12.0	6.4	6.9	6.8	12.2	0										
8 <i>C. pacifica</i> 1	9.0	10.9	11.0	10.9	8.6	12.4	12.4									
9 <i>C. pacifica</i> 2	9.0	10.9	11.0	10.9	8.6	12.4	12.4	0								
10 <i>C. lutheri</i> 1	12.6	9.1	8.4	8.3	12.9	10.4	10.4	12.3	12.3							
11 <i>C. lutheri</i> 2	12.3	9.1	8.1	8.0	12.6	10.2	10.2	12.2	12.2	0.7						
12 <i>C. melanoleuca</i>	16.2	16.3	16.0	15.9	15.4	17.6	17.6	15.8	15.8	15.4	15.0					
13 <i>C. cf. granoiei</i>	16.4	16.4	16.1	16.0	15.7	17.5	17.5	16.1	16.1	15.7	15.2	0.9				
14 <i>C. granoiei</i>	14.5	15.8	15.1	15.0	14.2	17.0	17.0	15.1	15.1	16.3	15.9	12.8	12.9			
15 <i>C. choii</i>	14.3	15.8	15.1	15.0	14.0	17.1	17.1	15.2	15.2	16.3	15.9	12.2	12.3	1.0		
16 <i>C. lutheri</i> 3	13.8	9.3	10.0	9.9	13.3	10.4	10.4	13.2	13.2	11.6	12.2	17.0	17.1	17.4	17.2	
17 <i>C. lutheri</i> 4	13.5	9.0	9.9	9.8	13.0	10.1	10.1	12.9	12.9	11.5	12.1	17.1	17.2	17.3	17.1	0.3

Phylogenetic analysis of cytochrome *b* sequences

The entire cytochrome *b* (1140 bp) was used for phylogenetic reconstruction. Topologies of the trees recovered by two phylogenetic methods are shown in Fig. 6 (BI) and Fig. 7 (ML). The trees provided by BI and ML analyses are slightly incongruent. But both the trees generate six major lineages (clades A-F in Figs. 6-7) and, three monotypic lineages: *C. arenae* (Lin, 1934), *C. pacifica* Kim, Park & Nalbant, 1999 and *C. macrostigma*. The lineages of the new species *C. fasciola*, *C. crassicauda* and *C. stenocauda* belong to clearly different clades, with strong high Bayesian values (100 %) and bootstrap (> 99 %). The lineage of *C. fasciola* clusters well with the lineage of *C. sinensis* (clade A in Figs. 6-7), with a genetic distance 8.0 % between these lineages (Table 3). The lineage of *C. stenocauda* clusters well with the lineage of *C. dolichorhynchus* Nichols, 1918, with a genetic distance 8.5 % (Table 3), and then is a sister lineage of *C. lutheri* Rendal, 1935 (from Korea) (clade B in Figs. 6-7), and then is a sister lineage of *C. microcephala* Chen & Chen, 2011 (Fig. 7), with a genetic distance between them of 11.4-12.5 % (Table 3). Clade C (Figs. 6-7) contained four lineages: a sister relationship between *Iksookimia longicorpa* (Kim, Choi & Nalbant, 1976) and *I. yongdokensis* Kim & Park, 1997, with a genetic distance 3.9-4.0 % (Table 4), and then clusters with *Kichulchoia brevifasciata* (Kim & Lee, 1995), and then is a sister lineage of *C. lutheri* (from China), with a genetic distance between them of 6.4-10.0 % (Table 4). The lineage of *C. crassicauda* clusters well with the lineage of *C. rara* (clade D in Figs. 6-7), with a genetic distance 7.8 % between these lineages, and then is a sister lineage of *C. microcephala* (Fig. 6), with a genetic distance between them of 11.1-12.7 % (Table 3). The lineage of *I. koreensis* (Kim, 1975) clusters with the lineage of *I. pumila* (Kim & Lee, 1987) (clade E in Figs. 6-7), with a genetic distance 2.0 % between these lineages (Table 4). Clade F (Figs. 6-7) is contained of four lineage: a sister relationship between *C. granoei* Rendal, 1935 and *C. choii* (Kim & Son, 1984), with a genetic distance 1.0 % between these lineages; and sister lineages *C. cf. granoei* and *C. melanoleuca* Nichols, 1925, with a genetic distance 0.9 %, and then the two clade cluster together (Table 4).

Discussion

Identifying the cobitid fishes in genus *Cobitis* to the morphospecies level is a complex task mainly because their extensive morphological similarities and often overlapping ranges (Nalbant 1993). One should always be aware that the currently used PCR protocols are indirect detection methods. Šlechtová

et al. (2008) based on the mitochondrial cytochrome *b* gene and the nuclear gene RAG-1 elucidated the phylogenetic relationships within Cobitidae that stimulated new studies on the taxonomy of the family. In this paper, based on the morphology characteristics and sequences of mitochondrial cytochrome *b* (cyt *b*) gene, we recognized six species of *Cobitis* from the River Yangtze drainage: *C. fasciola*, *C. crassicauda*, *C. stenocauda*, *C. sinensis*, *C. rara* and *C. macrostigma* (Fig. 1). Among the six species, *C. macrostigma*, endemic to China, can be found in the lakes, mainly in Lake Dongting and Lake Poyang. It reveals a large size and large blotches, males with a tooth-shape lamina circularis (Fig. 8A-B), it can be immediately distinguished from all others in this genus. Our molecular data showed that *C. stenocauda* clusters well with *C. dolichorhynchus*, with a genetic distance 8.5 %. And *C. stenocauda* superficially resemble *C. dolichorhynchus* in shape and colour pattern. The former species is easily distinguished from the later by the following features: males with a heart-shaped lamina circularis (Fig. 5C-D) versus a semicircular lamina circularis (Fig. 8C-D); the second pectoral fin ray short, not forming flagpole (Fig. 5D) versus the second pectoral fin ray elongate, nearly flagpole (Fig. 8D); L_2 usually spots with a row of few irregularly dots and can be traced beyond the dorsal fin (Fig. 3C) versus a row of thick and fast dots and can be traced beyond the anal fin (Fig. 3D); L_5 is consists of 13-17 large oval blotches versus 17-20 small oval blotches; caudal peduncle length 5.8-7.4 (mean 6.5) in standard length in males and 5.4-7.4 (6.4) in females versus 7.0-8.1 (mean 7.6) in males and 6.2-8.0 (6.9) in females. *C. fasciola* and *C. crassicauda* are similar to the species *Iksookimia* in colour pattern, and absence of the Gambetta pigment line (Gambetta 1934) on the body sides. However, mitochondrial cyt *b* lineages of *C. fasciola* and *C. sinensis* cluster together but not with the species of the genus *Iksookimia* and *C. crassicauda*. *C. fasciola* can be easily distinguished from *C. sinensis* by the following features: absence of the Gambetta pigment line versus five Gambetta pigment lines; a round lamina circularis (Fig. 2C) versus a kidney-shaped lamina circularis (Fig. 8E-F). Mitochondrial cyt *b* lineages of *C. crassicauda* and *C. rara* cluster together, with high Bayesian values (100 %) and bootstrap (100 %). *C. crassicauda* can be easily distinguished from *C. rara* by the following features: absence of the Gambetta pigment line versus five Gambetta pigment lines; a needle-shaped lamina circularis (Fig. 4C-D) versus a fingerlike lamina circularis (Fig. 8G-H). Recent molecular findings

showed that the diagnostic characters for nominal genera *Iksookimia* and *Kichulchoia* have little phylogenetic significance and the status and delimitation of these taxa needs to be carefully re-evaluated (Šlechtová et al. 2008). Besides, the genetic distance between morphologically well-differentiated *I. longicorpa*, *I. yongdokensis*, *I. koreensis*, *I. pumila*, *C. pacifica*, *K. brevifasciata*, *C. choii* and *C. granoei* is small (Table 4). The genetic distance between mitochondrial *cyt b* lineage *I. pumila* and *C. pacifica* is 8.6 %; the genetic distance between mitochondrial *cyt b* lineage *I. yongdokensis* Kim & Park, 1997 and *K. brevifasciata* is 6.4 %; *I. longicorpa* and *I. yongdokensis* is 3.9-4.0 %; *I. pumila* and *I. koreensis* is 2.0 %; and *C. choii* and *C. granoei* is only 1.0 %. These findings show that small genetic distances between mitochondrial *cyt b* gene lineages sometimes reflect an inter-species divergence of cobitid fish. In other words, even morphological species evolutionarily quite divergent cannot be placed in a separated genus without molecular investigations. Mechanisms contributing to the evolution of such closely related species remain unknown.

Mitochondrial *cyt b* lineages of *C. melanoleuca* and *C. cf. granoei* cluster together, with a genetic distance 0.9 % between these lineages (Table 3). While the genetic distance between mitochondrial *cyt b* lineage *C. melanoleuca* and *C. granoei* is 12.8 %. Here, in fact, *C. cf. granoei* is *C. melanoleuca*. *C. melanoleuca* is similar to *C. granoei* by the morphological characters, and was synonymized with *C. granoei* or *C. sinensis* by many scholars (Chen 1981, Ding 1994), recognized as valid species by Chen & Chen (2005).

Comparative material

Cobitis arenae: IHB 82077 (1), male, 94.6 mm TL, 80.1 mm SL, China: from the River Pearl in Huaiji County, in Guangdong Province; IHB 863-867, 6294-6296 (8), females, 70.3-91.3 mm TL, 61-78.8 mm SL, China: from the River Pearl in Lingyun County and Guiping City in Guangxi Province; IHB 0509404 (1), male, China: from the River Nandujiang in Ding'an County in Hainan Province.

Cobitis macrostigma: IHB 0509147, 0509149, 0509153-6, 0509157-8 (8), males 112.0-125.8 mm TL, 94.4-109.2 mm SL; IHB 0509139-146, 0509148, 0509151-2 (11), females, 130.7-158.9 mm TL, 111.9-137.4 mm SL, China: from Lake Dongting in Anxiang County in Hubei Province.

Cobitis dolichorhynchus: IHB 74v0402, 74v0409, 74v0436, 74v0439-40, 74v0443-4, 74v0448, 74v0627 (9), males 67.2-80.4 mm TL, 56.1-66.0 mm SL; IHB 74v0401, 74v0408, 74v0432, 74v0413-6, 74v0437,

74v0445, 74v0448, 74v0612-3, 74v0615, 74v0617-20, 74v0621-5, 74v0629-30, 74v0641 (25), females 96.9-126.4 mm TL, 83.1-107.8 mm SL, China: from the River Jiulongjiang in Zhangzhou City in Fujian Province.

Cobitis melanoleuca: IHB 800742, 900044 (2), females 63.7-74.6 mm TL, 53.3-74.5 mm SL, China: from the Liujiaxia reservoir in Gansu Province.

Cobitis granoei: IHB 6331, 6335, 6354, 6356-8, 6360-1 (8), males, 55.5-61.6 mm TL, 47.4-51.9 mm SL; IHB 6329-30, 6336-8, 6340-1, 6343, 6344-6, 6366 (12), females, 60.7-72.4 mm TL, 51.9-62.5 mm SL, China: from the River Huangshui in Xining City in Qinghai Province.

Cobitis rara: IHB 80vi0905, 80vi0909-10, 80vi0913, 80vi0915-6, 80vi1070, 80vi1072, 80vi1074-5, 80vi1058 (11), males, 86.4-96.9 mm TL, 73.2-80.8 mm SL; IHB 80vi0473, 80vi0475-6, 80vi0694, 80vi0904, 80vi0911-2, 80vi0914, 80vi1055, 80vi1057, 80vi1059, 80vi1063, 80vi1065, 80vi1067, 80vi1194, 80vi1201 (16), females, 89.9-117.2 mm TL, 76.2-99.6 mm SL, China: from the River Jialingjiang in Shaxi Province.

Cobitis sinensis: IHB 8840712, 8840702 (2) males, 92.7-100.8 mm TL, 78.9-85.3 mm SL; IHB 701, 703-8, 710, 713 (9), females, 89.4-131.9 mm TL, 75.4-113.9 mm SL, China: from the River Yuangjiang in Songtao County in Guizhou Province.

Cobitis lutheri: IHB 58908, 58924, 58927, 58932-5, 58937 (8), males, 47.7-72.6 mm TL, 40.8-61.8 mm SL; IHB 58903, 58910-4, 58917, 58919-20, 58930-1, 58935, 58939 (13), females, 61.0-74.9 mm TL, 52.5-64.4 mm SL, China: from the River Haila'er in Neimenggu Province; IHB 6031-2, 6035-6, 6038, 6040, 6046-8, 6052 (10), males, 50.0-66.6 mm TL, 43.2-56.8 mm SL, China: from the River Fabiela in Aihui County in Heilongjiang Province.

Cobitis multimaculata: IHB 75v3203, 75v3188, 75v3190, 75v3192, 75v3194-5, 75v3198, 75v3202, 75v3205, (9) males, 72.0-79.8 mm TL, 60.3-68.8 mm SL; IHB 75v3100, 75v3186, 75v3189, 75v3193, 75v3196-7, 75v3204, (7) females, 80.0-108.0 mm TL, 68.4-92.0 mm SL, China: from the River Nanliu in Bobai County in Guangxi Province.

Cobitis microcephala: IHB 0605135, 0605138, (2) male, 57.1-60.5 mm TL, 47.9-51.8 mm SL; IHB 0605205-210, (6) females, 59.2-69.5 mm TL, 50.4-59.8 mm SL; China: from the River Nanliu in Bobai County in Guangxi Province.

Acknowledgements

This research was done under the auspices of the Hebei University Campus Natural Science Funds (2008-133) and the Science and Technology Bureau of Baoding City (12zf079). We thank the reviewers for giving lots of valuable suggestions on both science and language.

Literature

- Chen J.X. 1981: A study on the classification of the subfamily Cobitinae of China. *Trans. Chinese Ichthyol. Soc. 1*: 21–31. (in Chinese with English summary)
- Chen J.X. 1987: Cobitidae. Fauna of Qinling Mountain Area fresh water fishes. *Science Press, Beijing*: 37–39. (in Chinese)
- Chen Y.F. & Chen Y.X. 2005: Secondary sexual characters, pigmentary zones of Gambetta and taxonomical revision the genus *Cobitis* from China (Pisces: Cobitidae: Cobitinae). *Acta Zootax. Sinica 30* (4): 647–658. (in Chinese with English summary)
- Chen Y.X. & Chen Y.F. 2011: Two new species of cobitid fish (Teleostei, Cobitidae) from the River Nanliu and the River Beiliu, China. *Folia. Zool. 60*: 143–152.
- Ding R.H. 1994: Cobitidae. Fauna of Sichuan fresh water fishes. *Sichuan Publishing House of Science and Technology, Chendu*: 115–117. (in Chinese)
- Gambetta L. 1934: Sulla variabilita del cobite fluviale (*Cobitis taenia* L.) e sul rapporto numericodei sessi. *Boll. Mus. zool. Anat. Comp. Univ. Torino 44*: 279–325.
- Huelsenbeck J.P. & Ronquist F. 2001: MrBayes: Bayesian inference of phylogeny. *Bioinformatics 17*: 754–755.
- Kumar S., Tamura K. & Nei M. 2004: MEGA3: integrated software for Molecular Evolutionary Genetics Analysis and sequence alignment. *Bioinformatics 5*: 150–163.
- Nalbant T.T. 1993: Some problems in the systematics of the genus *Cobitis* and its relatives (Pisces, Ostariophysi, Cobitidae). *Rev. Roum. Biol. Ser. Biol. Anim. 38* (2): 101–110.
- Nichols J.T. 1925: The two Chinese loaches of the genus *Cobitis*. *Amer. Mus. Novitates. 170*: 3.
- Perdices A. & Doadria I. 2001: The molecular systematics and biogeography of the European cobitids based on mitochondrial DNA sequences. *Mol. Phylogenet. Evol. 19*: 468–478.
- Roberts T.R. 1989: The freshwater fishes of western Borneo (Kalimantan Barat, Indonesia). *Mem. Calif. Acad. Sci. 14*: 1–210.
- Sambrook J., Fritsch E.F. & Maniatis T. 1989: Molecular cloning: a laboratory manual. *Cold Spring Harbor Laboratory Press, Cold Spring Harbor, New York*.
- Sawada Y. 1982: Phylogeny and zoogeography of the superfamily Cobitoidea (Cyprinoidei, Cypriniformes). *Mem. Fac. Fish., Hokkaido Univ. 28* (2): 199.
- Šlechtová V., Böhlen J. & Perdices A. 2008: Molecular phylogeny of the freshwater fish family Cobitidae (Cyriniformes: Teleostei): delimitation of genera, mitochondrial introgression and evolution of sexual dimorphism. *Mol. Phylogenet. Evol. 47*: 812–831.
- Takeda R. & Fujie K. 1945: Distribution of some color pattern types of *Cobitis taenia* (Tokyo). *Zool. Mag. 56* (11/12): 1–5. (in Japanese)
- Tamura K., Peterson D., Peterson N., Stecher G., Nei M. & Kumar S. 2011. MEGA5: Molecular Evolutionary Genetics Analysis using maximum likelihood, evolutionary distance, and maximum parsimony methods. *Mol. Biol. Evol. 28*: 2731–2739.
- Tang Q.Y., Liu H.Z., Mayden R. & Xiong B.X. 2005: Comparison of evolutionary rates in the mitochondrial DNA cytochrome *b* gene and control region and their implications for phylogeny of the Cobitoidea (Teleostei: Cypriniformes). *Mol. Phylogenet. Evol. 39*: 347–357.
- Thompson J.D., Gibson T.J., Plewniak F., Jeanmougin F. & Higgins D.G. 1997: The clustal X window interface: flexible strategies for multiple sequences alignment aided by quality analysis tools. *Nucleic Acid. Re. 25*: 4876–4882.
- Xiao W., Zhang Y. & Liu H. 2001: Molecular systematics of Xenocyprinae (Teleostei: Cyprinidae): taxonomy, biogeography, and coevolution of a special group restricted in east Asia. *Mol. Phylogenet. Evol. 18*: 163–173.