



Photafish system: An affordable device for fish photography in the wild

JORGE E. GARCÍA-MELO¹, LUÍS J. GARCÍA-MELO², JESÚS D. GARCÍA-MELO³,
DIANA K. ROJAS-BRIÑEZ⁴, GIOVANY GUEVARA² & JAVIER A. MALDONADO-OCAMPO¹

¹*Unidad de Ecología y Sistemática (UNESIS), Departamento de Biología, Facultad de Ciencias, Pontificia Universidad Javeriana, Edf. 53, Laboratorio de Ictiología 108B, Carrera 7 No. 43-82, Bogotá, DC, Colombia. Send reprint request to this address.*

E-mail: jgarcia-m@javeriana.edu.co

²*Grupo de Investigación en Zoología, Departamento de Biología, Facultad de Ciencias, Universidad del Tolima, Santa Helena Parte Alta, Ibagué, Colombia.*

³*Programa de Arquitectura, Facultad de Humanidades, Artes y Ciencias Sociales, Universidad de Ibagué, Carrera 22 Calle 67 B/ Ambalá, Ibagué, Tolima, Colombia.*

⁴*Institución Educativa Ismael Santofimio Trujillo, Secretaría de Educación Municipal, Ibagué, Colombia.*

Abstract

This paper describes the *Photafish System*, an innovative technique for capturing high-quality digital images of live freshwater fishes and other aquatic organisms in the field. This system may improve and facilitate the visual documentation of such organisms to illustrate guidebooks, populate online databases and support scientific papers, particularly taxonomic ones. The system was designed and tested to produce Taxonomically Informative Photos (TIPs) of living specimens and employs an Aquarium Assembly for Photography (AAP) distinguished by its portability and low cost. Using Neotropical freshwater fishes as a model, we propose an optimized protocol for documenting the morphology of live specimens to support taxonomy, as well as awareness and conservation of freshwater biodiversity. This paper addresses the technical aspects and challenges of field studio photography in remote locations. Tricks gleaned from personal experiences with nature photography are also shared. Finally, we briefly discuss the advantages and weaknesses of our approach.

Key words: Aquarium and live fish photography, Conservation, Taxonomically Informative Photos, Visualization of morphological characters

Resumen

Este artículo describe el *Photafish System*, una técnica innovadora para tomar imágenes digitales de alta calidad de peces de agua dulce y otros organismos acuáticos en campo. Este sistema puede mejorar y facilitar la documentación visual de estos organismos para ilustrar guías, alimentar bases de datos en línea y respaldar documentos científicos, particularmente taxonómicos. El sistema fue diseñado y probado para producir Fotos Taxonómicamente Informativas (TIPs) de especímenes vivos y emplea un Acuario Ensamblable para Fotografía (AAP) que se distingue por su portabilidad y bajo costo. Utilizando los peces Neotropicales de agua dulce como modelo, proponemos un protocolo optimizado para documentar la morfología de los especímenes vivos, para apoyar la taxonomía, así como la concientización y conservación de la biodiversidad de agua dulce. Este documento aborda los aspectos técnicos y los desafíos de la fotografía de estudio en campo usando fondos blancos y negros y métodos estandarizados, en áreas remotas. También se comparten algunos trucos obtenidos de las experiencias personales con la fotografía de la naturaleza. Finalmente, discutimos brevemente las ventajas y las debilidades de nuestro enfoque, para una consideración futura.

Palabras clave: Acuarios y fotografía de peces vivos, Conservación, Fotos taxonómicamente informativas, Visualización de caracteres morfológicos

Introduction

Photography is an essential tool for exploring and documenting the natural world, and has long played an important and widely variable role in taxonomy (Tautz *et al.* 2003; Steinke *et al.* 2009). Visual representations support taxonomy (Akkari *et al.* 2015), but some taxonomic works lack good visual data (illustrations, photos, X-ray tomography, etc.) or fail to correctly use such data to contribute to the formal identification or description of specimens under study (Leggett & Kirchoff 2011).

The need for high-quality visual data is opening doors for naturalist photographers to make significant contributions to taxonomy (Marshall 2008), but not without some controversy. A publication in *Science* by Minter *et al.* (2014) ignited debate by claiming “Collecting specimens is no longer required to describe a species or to document its rediscovery” because “alternative methods of documentation, including high-resolution photography, audio recording, and nonlethal sampling...can be just as accurate”. Marshall & Evenhuis (2015) recently described a new species of Diptera based exclusively on a few photographs, a taxonomic act defended by Pape (2016). In response to Minter *et al.* (2014), Krell & Wheeler (2014) argued that such lines of evidence are individually problematic and cannot be used to reliably identify or describe most Earth’s biodiversity. Other authors (e.g., Ceríaco *et al.* 2016; Aguiar *et al.* 2017) also consider the practice advocated by Minter *et al.* (2014) to be simplistic and harmful, especially if taxonomic authors do not publish their RAW files to enable the potential handling of the original digital image (e.g., original color data).

Despite polarization of the taxonomic community on this issue, the visual recognition of individual specimens has been essential to scientific discoveries in several fields of biology (Wilder 2009). From the early days of taxonomy, species descriptions have been accompanied by various types of visual support that are vital to convey information about the morphology and character states used to distinguish species (Akkari *et al.* 2015, García-Melo *et al.* 2018). Currently, the use of digital images in taxonomy has focused on photo-identification methods (Dala-Corte *et al.* 2016) in studies of large vertebrates (Bertulli *et al.* 2015; Koivuniemi *et al.* 2016; Treilibs *et al.* 2016), amphibians (Sannolo *et al.* 2016), lizards (Sreekar *et al.* 2013; Knox *et al.* 2016), invertebrates (Caci *et al.* 2013, Chim & Tan 2012), fishes (Speed *et al.* 2007; Dala-Corte *et al.* 2016), and bats (Rydell & Russo 2014). Few works, however, have attempted to standardize protocols for field photography to provide images that are taxonomically informative for scientific publications and aesthetically attractive for disseminating knowledge and promoting biodiversity conservation to a broader constituency. Recent projects by wildlife photographers, such as Meet Your Neighbours™ (Niall Benvie & Clay Bolt) and the Photo Ark (Joel Sartore), present fresh, eye-catching and inspiring imagery of animals taken in field studios with conservation, rather than taxonomic, objectives (Franco-Pérez *et al.* 2015). Therefore, finding an intersection between scientific and aesthetic approaches would mark an important advancement to nature photography.

Fishes are more diverse than all other vertebrates combined with approximately 34,090 valid species (Eschmeyer *et al.* 2017). Yet, live fishes are perhaps the least photographed animals due, in part, to the difficulty of observing them in nature when compared to birds, amphibians, reptiles and mammals. High-quality photos of live and well-preserved fishes showing their natural colors and meristic/morphometric characteristics, respectively, provide valuable taxonomic aids with broad applications (Goodbred & Occhiogrosso 1979; Herler *et al.* 2007). Fish images are used in species descriptions to describe morphology and clarify identifications (Herler *et al.* 2007). Despite the advancement of digital photography and techniques for capturing high-quality fish images (e.g., Sabaj 2010), difficulties persist with respect to the motion of live fish and color fading after capture and preservation as noted by Goodbred & Occhiogrosso (1979) nearly four decades ago. A few publications have addressed such issues in a variety of ways. Highlights include Emery & Winterbottom’s (1980) paper on fish photography using vertical aquaria in the field to capture near life-like color photos.

Holm (1989) improved upon their results, but with a highly complex setup for taking photographs of fishes of different sizes. Rinne & Jakle (1981) took photographs of live fishes *in situ* with Plexiglas® tanks connected to a direct-current pump. Howe (1996) created a simple and inexpensive method for immobilizing and photographing small live fishes, and Davenport & Roop (2000) patented the Teaching-Photographic Tank for fish identification. Herler *et al.* (2007) described an innovative technique for digitally imaging small fish specimens using conventional flatbed scanners. Sabaj (2010) described a simple protocol for photographing fishes live (or anaesthetized with a few drops of clove oil) using a phototank made of plate glass and ambient light. Smith & Bissette (2015) described a similar phototank method that utilizes flashes, removing any concern over ambient lighting, and black backgrounds. Both of those phototank methods immobilize the fish via a squeeze plate.

Most of the aforementioned techniques have been successfully used to photograph small (< 25 cm), freshly fixed or anaesthetized fish with laterally compressed body shapes (e.g., Characiformes), which makes it easier to restrict the subject's movement. Photographing fishes with a variety of body plans and sizes, particularly catfishes in lateral view, is challenging even when using a squeeze plate (e.g., live catfishes almost always seek the bottom of the phototank). Photographers sometimes place rocks or sand on the bottom of the tank, but this adds time to photo shoots and produces rather artificial-looking photos. The situation becomes more complex in Neotropical freshwater systems where there are typically many species to photograph at any given site.

Based on a review of existing databases and literature, there is tremendous variability among the photos available for freshwater fishes. Differences include the state of the specimens (e.g., live, dead, recently dead, pinned against the glass, missing scales, natural vs. stress coloration, etc.), the background (white, black, grey, blue), the bottom of the phototank (bare or with aquatic or terrestrial plants, rocks, sand, etc.), the scale indicators (rulers, coins, pens, etc.), the structure of the system (glass or acrylic aquaria, plastic bags, hand held), the lighting (natural, artificial lamps, flashes), the water (river, filtered or tap), among others. Our survey of online images in FishBase (Froese & Pauly 2016) revealed a low number of species represented by Taxonomically Informative Photos (TIPs) of live specimens among the Neotropical members of the freshwater Superorder Characiphysae (Characiformes, Siluriformes, and Gymnotiformes; Fig. 1). Our survey shows that while photography has evolved, the images themselves have not kept pace.

Color descriptions of new fish species are often based on the examination of alcohol-preserved specimens in ichthyological collections. Published descriptions may include technically sound images of preserved specimens, but too few contain images showing key morphological details or variation among multiple live specimens. Furthermore, many published images are not based on standardized methods and are thus hard to compare, especially when backgrounds differ. Therefore, it is important to establish standards for taking TIPs that reflect advances in digital photography (see García-Melo *et al.* 2018).

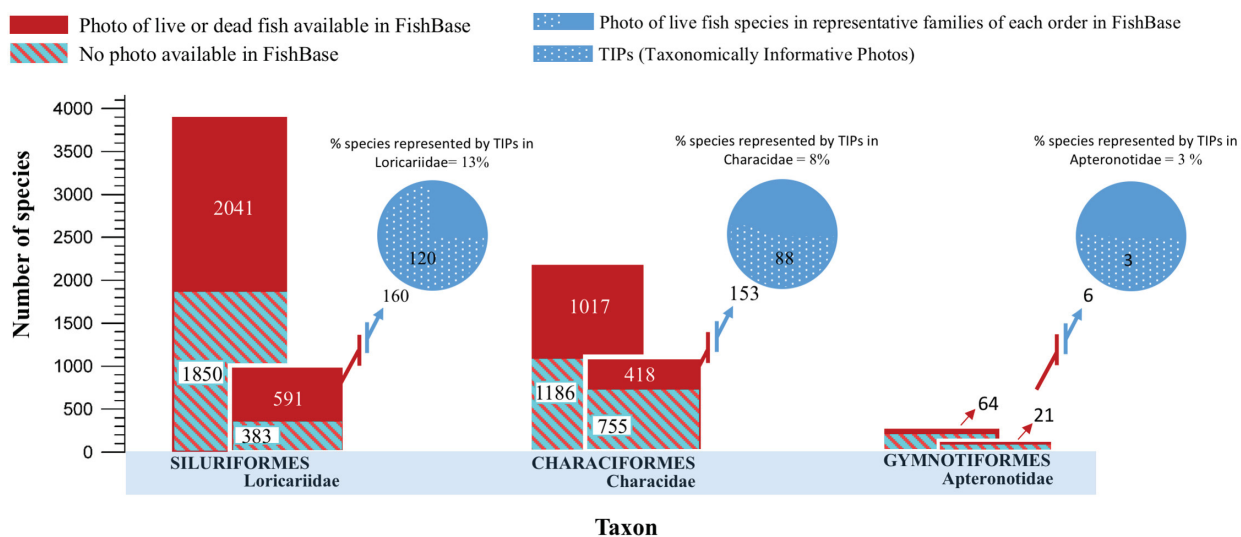

FIGURE 1. Number of species in the three main orders of Neotropical freshwater fishes for which there are photos of live specimens that are taxonomically informative in FishBase (Froese & Pauly 2016). For the three orders (3896 species of Siluriformes, 2203 species of Characiformes, and 252 species of Gymnotiformes) and their representative families (974 species of Loricariidae, 1173 species of Characidae, and 96 species of Aptereronotidae), more than 50% of species are not presented by any photos. Furthermore, only 160 species of Loricariidae, 153 species of Characidae and 6 species of Aptereronotidae have photos of live specimens. In the same way, the number of species represented by TIPs for each family is lower (area dotted in the pie charts).

In practice, field studio techniques using fishes, described in part by Benvie (2013), can be technically complex, even for a professional photographer, and difficult to establish in remote areas due to equipment needs and logistic constraints. In this paper, we propose a relatively inexpensive system for producing standardized images that are not only technically sound, but also improve and facilitate the visual documentation of freshwater animals to illustrate guidebooks, populate online databases and enhance scientific papers. As examples, we use multiple images obtained during field expeditions that have facilitated taxonomic identifications and (sometimes)

the recognition of inconspicuous morphological features. Moreover, our proposed approach alleviates the problem of photographing fish in remote or poorly accessible areas far from sources of electricity, filtered water and other comforts readily available in the lab.

Material and methods

Field studio. There are a variety of techniques for capturing high-quality color images of fishes in phototanks (i.e., aquariums), all of which have been vastly simplified and improved in many ways by the advent of digital technology (Sabaj 2010).

However, those techniques have not been optimized for field work in remote locations, where many species must be documented, often under time constraints (e.g. biological expeditions, rapid ecological assessments).

Our proposed systematic protocol (i.e., Specimen collection, Specimen preparation, and Laboratory/at home phase) for photographing freshwater fishes and other aquatic organisms in the wild is based on two key features described below.

1) Photafish System. Although the idea of photographing fishes in the field against black or white backgrounds is not new, our technique allows for greater standardization regardless of settings or equipment. By eliminating the natural context of the living organism, the image fosters an appreciation of the individual and allows any species to be compared to another (Franco-Pérez *et al.* 2015). Our *Photafish System* was conceived in terms of portability and practicality. Arming the entire system requires approximately 15 minutes, and most of the photos were captured by a single person in the field, at times even on a small boat in motion (see Fig. 5c).

The *Photafish System* is proposed as a versatile and cost-effective technique for capturing high-quality photos of freshwater organisms, particularly fish. The photographic system employs gear that is regularly used in field studios (i.e., camera, lens, flash units, softboxes, backgrounds, wireless flash triggers and supports), but is optimized for remote locations (Table 1, Fig. 2).

TABLE 1. Components and approximate costs of the *Photafish System*. The ‘ideal system’ employs more devices and is therefore more expensive. In the Basic System, several devices can be suppressed, making the system cheaper; however, it requires more user skill. Cameras and lenses are not included in the system. Superscript symbols (*^+) match the number and type of device to the different options and prices.

| Devices | Quantity and Reference | Ideal System Cost (\$) | | | Basic System Cost (\$) |
|--------------------------------------|--|------------------------|----------|----------|------------------------|
| | | Option 1 | Option 2 | Option 3 | |
| Aquarium | 1 AAP (Small size*, Medium size**, Large size***) | 30* | 40** | 50*** | 30* |
| Flash Units | 2^ or 3^^ Yongnuo Speedlight YN 560 III | 180^^ | 120^ | 120^ | 120^ |
| Flash batteries | 4 Panasonic eneloop pro AA Rechargeable NiMH Batteries (1.2V, 2550mAh, 4-Pack) | 64 | 64 | 64 | 64 |
| Softbox | 1 Neewer 9" x 9" / 23cm x 23cm Foldable Off-Camera Flash | 14 | 14 | 14 | |
| Wireless flash triggers | 4+ Yongnuo YN-622 or 4 Yongnuo^^ RF605 or 1 Yongnuo YN560-TX II+++ | 146+ | 66^^ | 37+++ | 37+++ |
| Tripod | 1 Vanguard Alta Pro 263AT | 130 | 130 | 130 | |
| Head ball | 1 Pergear Tripod Ball Head 360 Degree | 22 | 22 | 22 | |
| Portable Workbech or modified Tripod | 1 Black & Decker WM125 | 29 | 29 | 29 | |
| Magic arm | 1 Neewer 11 Inch Adjustable Friction | 32 | 32 | 32 | |
| LED lamp | 1 QUANS 5W Clip on Clamp Gooseneck COB LED 19inch Neck Black | 18 | 18 | 18 | |
| Rechargeable battery | 1 ExpertPower EXP1290 12 Volt 9 Amp | 23 | 23 | 23 | |
| Total cost <i>Photafish System</i> | | 674 | 544 | 525 | 251 |

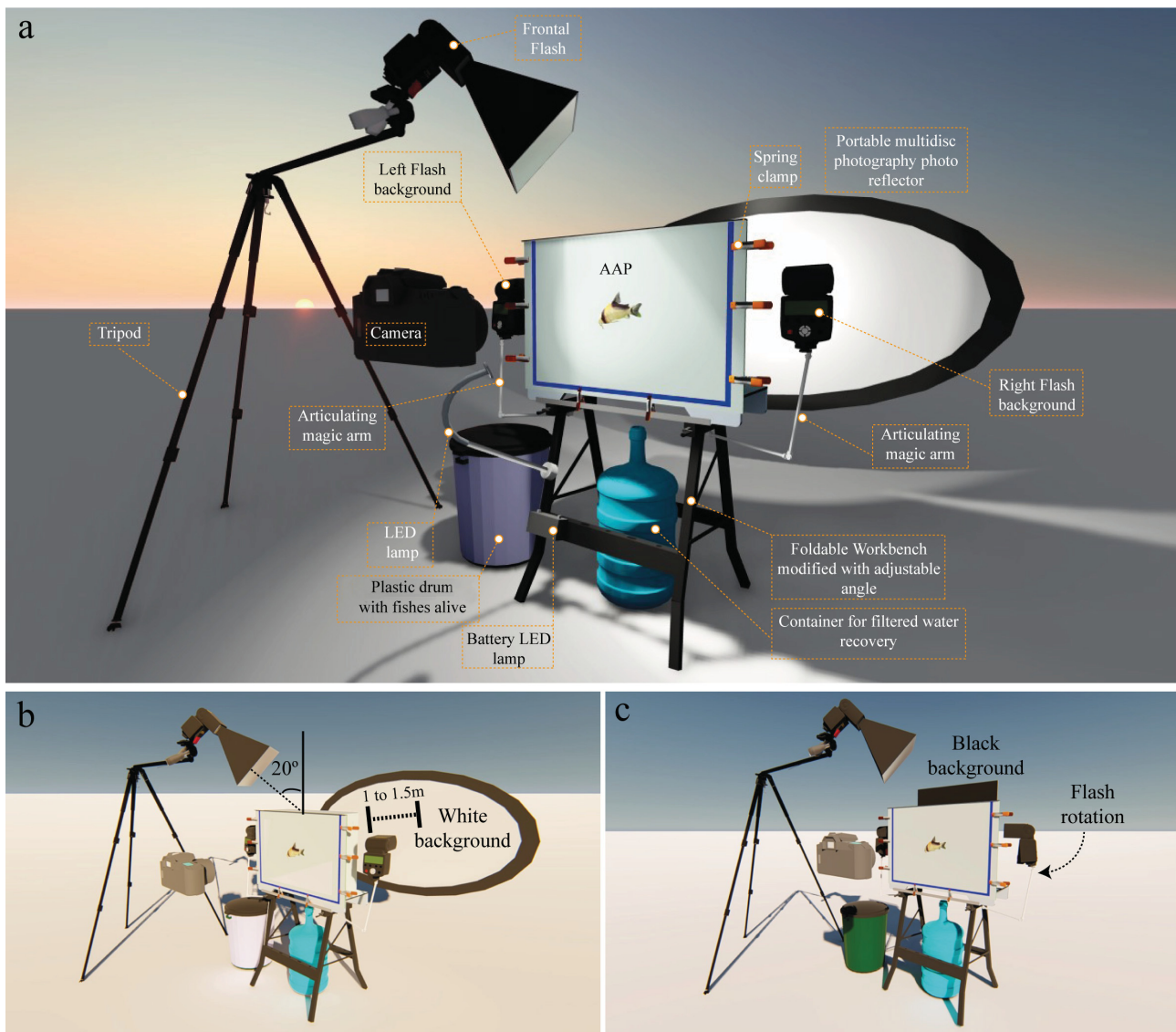

FIGURE 2. The *Photafish System*. a. Components optimized for field photography and AAP (Aquarium Assembly System for Photography). Three Speedlite flash units are used for shooting regardless of background (white or black). Photographs can be taken at any time of the day with the help of an LED lamp. b. Lighting scheme for white backgrounds. c. Lighting scheme for black backgrounds. For clarity, the two lighting schemes are shown in supplementary file S1.

A basic, yet key aspect is that all photos were shot in RAW format. Aguiar *et al.* (2017) stress that RAW files (i.e., digital negatives) should be made available to taxonomists for comparison and to avoid doubts regarding authenticity. A second key aspect is lighting, and only flashes offer the control and intensity required to generate extremely light whites or dark blacks in field studio work. Ambient light has been used by many ichthyologists for field photography of fishes in aquaria due to a variety of reasons (e.g., simplicity, time constraints, lack of knowledge on lighting techniques, etc.). However, there are many restrictions when shooting fish in motion or under low-light conditions. So, after numerous field tests, we established the most appropriate lighting directions for three flash units (Fig. 3 & 4) for both white and black backgrounds. The proximity of the flashes to the subject and the intensity of the light depend on the size and type of fish (i.e., with or without scales) and the aquarium. The autonomy of the flashes will depend on the type of batteries and background used. Regarding batteries, lithium AA batteries last the longest (170 to 400 shots to 1/1 full power flash), but they are not rechargeable and are more expensive. Alkaline batteries are less expensive but have a shorter lifespan (70 to 120 shots to 1/1 full power flash). For this reason, we prefer to use NiMH rechargeable batteries from 2500 to 3000 mAh (110 to 190 shots to 1/1 full power flash) when a portable electric generator is available. However, recently on the market exist flash models

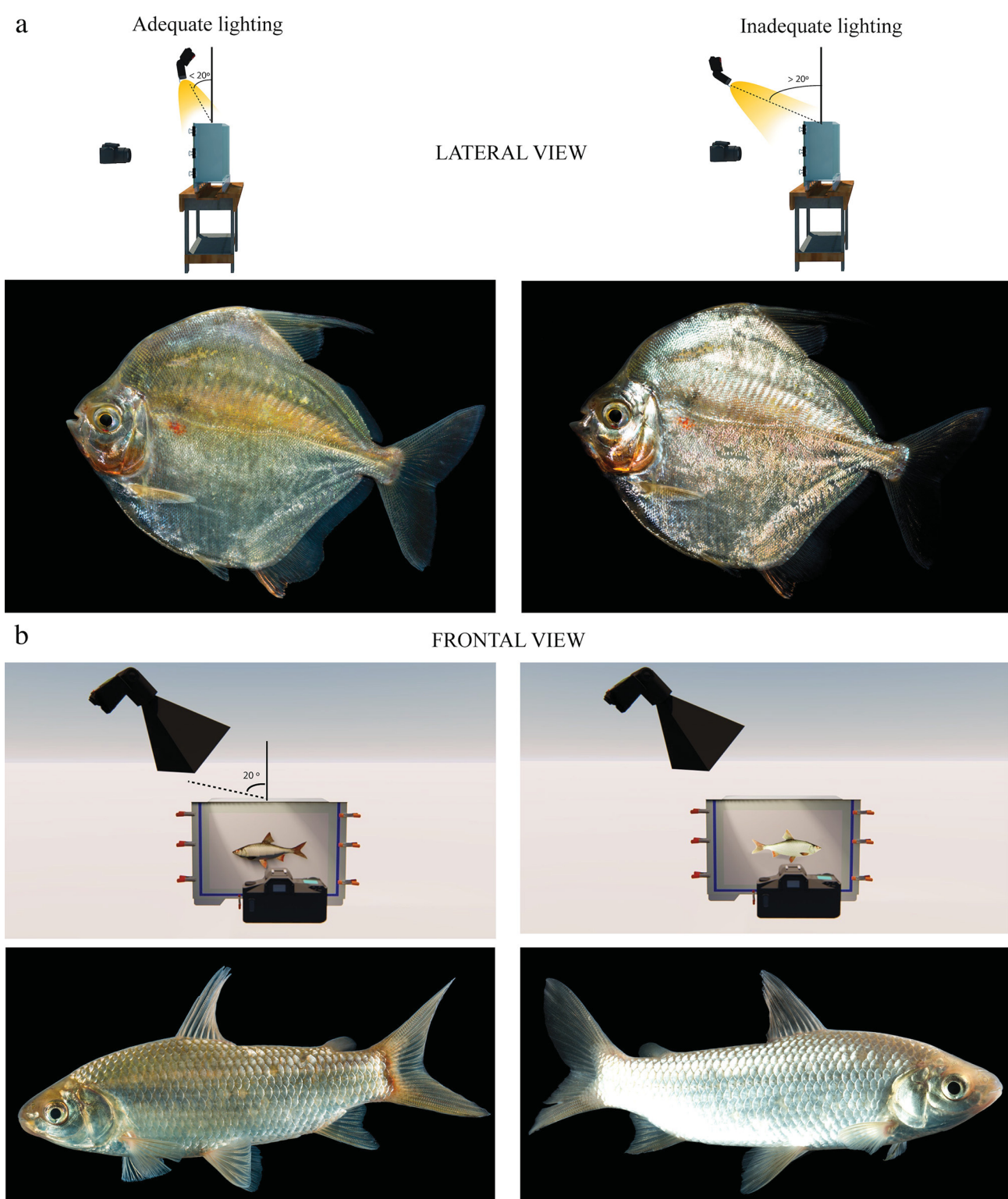
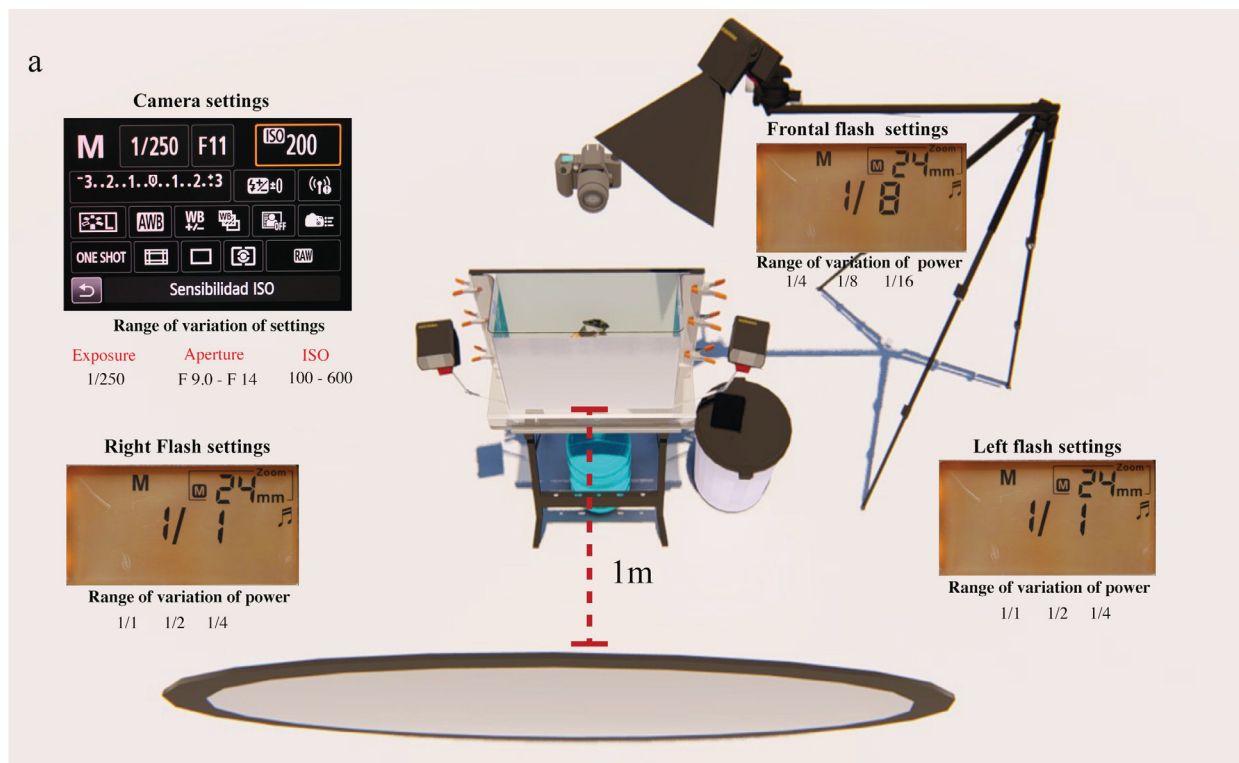

FIGURE 3. For fishes with scales, such as *Metynnis oblicua*, optimum results depend on the lighting angle of the front flash. a. At angles less than 20° with respect to the vertical axis, the scales do not generate reflections. At angles greater than 20° , reflection occurs throughout the body, and the fins are not visible. b. The flash is usually best held above and slightly in front of the fish (and fine-tuned via experimentation) displaced towards the side of the aquarium (approximately 20°) to avoid reflections on the curved sheet of acrylic, especially when using black backgrounds. For fishes such as *Cyphocharax magdalenae*, frontal flash lighting preferably should be anterior regarding fish (left image), otherwise reflections on the scales tend to be a problem (right image).



Equipment used:
 Canon eos 70D
 Canon EF 100mm f/2.8 Macro
 2 Yongnuo Flash YN600ex-rt
 1 Canon Speedlite 600EX II-RT

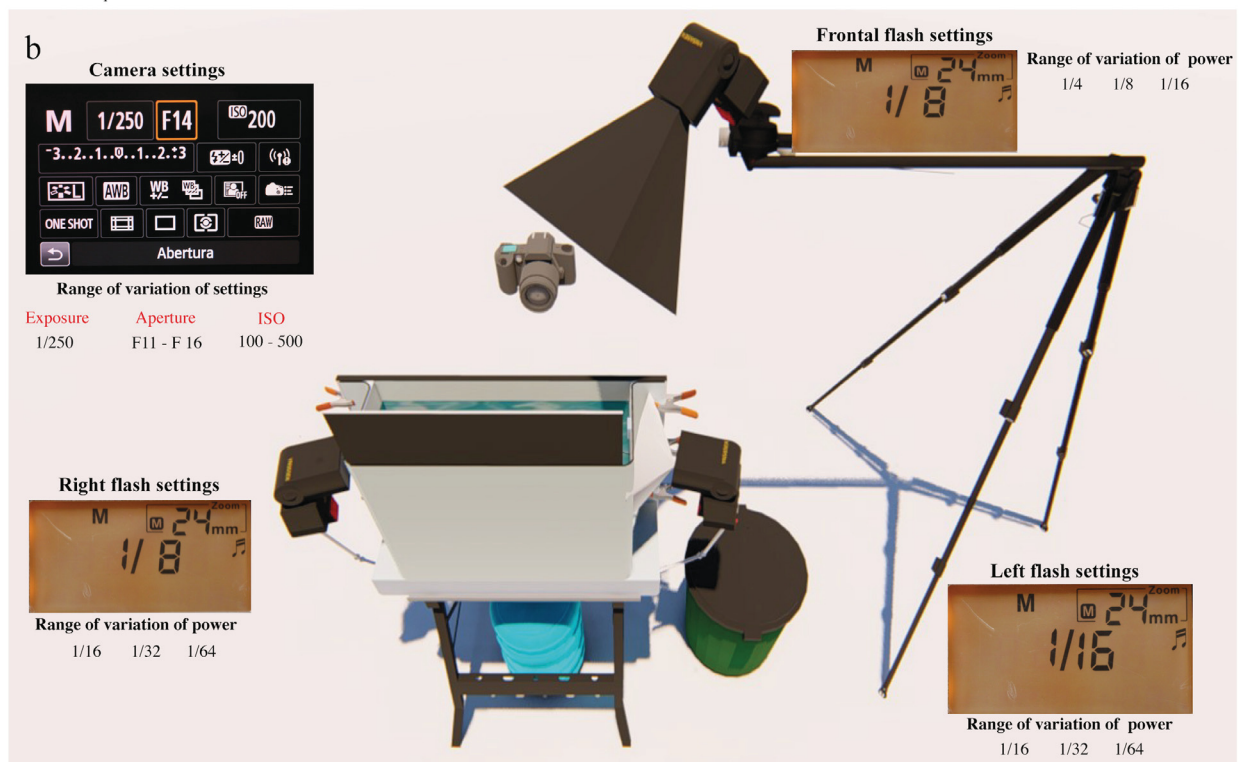

FIGURE 4. Camera settings and flash power ratio used in the *Photofish* System with Manual mode (M) in all devices. a. On white backgrounds, we mostly use these parameters, increasing or decreasing the ISO sensitivity according to the magnification used in the lens. b. Power ratio of right and left flashes were lowest for the black background. Settings used here, are only a reference and can be changed depending on the equipment and requirements. Flash settings also can be used on automatic when using TTL compatible flashes (flash's computer determines the appropriate flash power). The zoom on the flash is usually set to the widest.

with rechargeable lithium batteries similar to those of cameras, which increases the autonomy (up to 700 shots to 1/1 full power flash, according to manufacturers' specifications) and this decreases recycle time to less than 1.5 sec (e.g., Yongnuo YN860Li, Yn680EX-RT, YN686EX-RT, Neewer Nw870, Flashpoint Zoom Li-on R2, Pixel X900N or Godox V860II). Regarding the background, the white background requires greater partial powers of the left and right flashes (see Fig. 4a) and therefore a lower autonomy for those flashes. In this case, it is possible to use portable extended flash (e.g., Fomito Godox PB960) to extend to autonomy (1800 times in full power). Therefore, when battery availability is low or access to recharging places is limited, it is advisable to use black backgrounds that guarantee greater autonomy for flashes. It is important to clarify that the autonomy will also depend on the model of the flash and ambient temperature.

The approximate cost for implementation depends on the devices used, particularly the camera, flashes and lenses. To guide the photographer, we indicate the brands and models used to obtain the high-quality images in this study. The parameters of exposure and flash intensity depend on the characteristics of the devices used, the type of background, and the distances between the camera, aquarium, and background (which, in turn, depend on the size of the organism and focal length). The device settings most regularly used in camera and flash during our photographic sessions are specified in Fig. 4, but in general, the ISO was set as low as possible (100 or 200). With a 100 mm macro lens, we use F values >11 to increase the depth of field and guarantee more areas in focus. Depending on fish-form (compressed i.e., Gymnotiformes, Characidae or wide i.e., Loricariidae, Callichthyidae, Pimelodidae), the size of the specimen and the focusing distance, the F value was adjusted.

2) Aquarium assembly for photography (AAP). The AAP is perhaps the core of the *Photofish System* and was designed to solve some of the aforementioned problems. At least eight characteristics make AAP different from conventional aquarium systems. The first feature is that AAP is built with a combination of acrylic (or Plexiglas®) and highly resistant glass (laminated or tempered). Only the front of the aquarium is glass, which reduces the weight, especially of large aquariums, as well as the possibility of breakage and scratching during transport or use (Fig. 5e). Second, because the glass is adjusted with a pressure system controlled by gaskets (mounting putty for avoid water filtering) and held using spring clamps, it is easily removable and can be interchanged with another piece of glass in seconds (Fig. 5e). Third, a curved inner sheet of acrylic allows photographs to be made of the lateral views of many types of fish, as well as the ventral or dorsal views of some species of catfishes, without the inconvenience caused by the fish moving to the bottom of the aquarium (Fig. 5e and supplementary file S4). This can be achieved by manipulating the fish with a small wire (35 cm) into the proper position and by moving the acrylic sheet forward or backward (Fig 6). Flash photography freezes a fish in constant motion, allowing for greater versatility during photo capture. Fourth, large aquariums are equipped with a drainage system for easy removal and filtering of water for reuse (Fig. 5e). This feature is extremely valuable in remote locations where clean water is not readily available. Fifth, the aquarium is attached to a folding table, which reduces the risk of falling (Fig. 5d). Furthermore, this table has an efficient clamping system and built-in lighting powered by a rechargeable battery, which allows photos to be taken at night. However, to reduce weight and space during transport, we can also use a conventional photography tripod with a metal plate adapted for the size of aquarium (Fig. 7). Sixth, an acrylic sheet covered with black plush fabric is submerged towards the back of the aquarium; this ensures a deep black background that facilitates image editing. Likewise, lateral flash backlighting highlights the silhouette of the fish (see Fig. 4b). This set up is particularly useful for fish with dark contours on the body and/or fins. Seventh, by simply changing the background and rotating the two flash units attached to the table or tripod, it is easy to obtain high-quality photographs against both black and white backgrounds. Eighth, aquaria can be manufactured at low costs and in different sizes depending on user needs. An animation showing all components of the system and building the AAP can be found in the supplementary file S5.

Specimen collection. When photographing fishes for identification purposes, the overarching strategy is to maximize the content and accuracy of the information in the image (Sabaj 2010). We collected fishes via electrofishing and hand-netting in rivers, streams, lakes, swamps, marshes, etc. Any live specimen in good condition (e.g., scales, fins and barbels intact) may be useful for photography. Sudden changes in environmental conditions are one of the most common causes of stress to fishes and thus affect coloration (Sköld *et al.* 2012). To reduce stress, all captured fish preferably were stored in a dark plastic barrel with water from the capture location. Battery-powered air pumps were used to oxygenate the water.

Specimen preparation. Fishes were removed to a second plastic barrel containing clean water (i.e., water fit for human consumption or at least free of suspended particles) and allowed to acclimate for a few minutes.

Transferring the fish to clean water reduces subsequent fouling of the aquarium water by foreign debris attracted to mucous-laden skin and fins, especially in catfishes. At this point, all fish should be handled with aquarium nets to reduce the risk of scale loss, fin damage, etc. We avoid using anaesthetized fish or specimens recently preserved in formalin, due to the loss of bright/iridescent colors, or the opacity of organisms with fatty skin (e.g., pseudopimelodid catfishes).

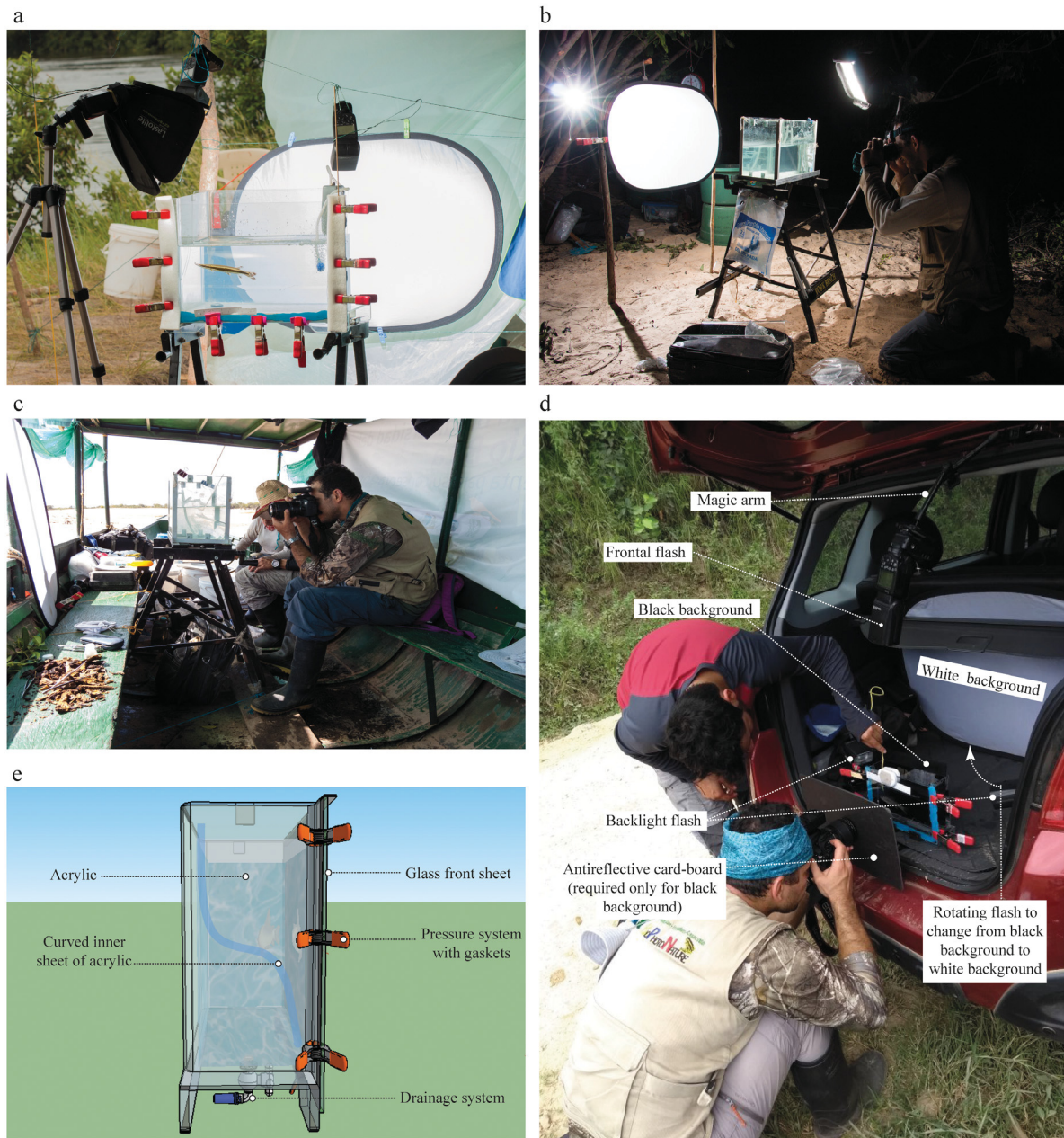

FIGURE 5. Portability and practicality of the *Photafish System*. Live fishes can be photographed during the a. day or b. night, in a c. boat or in remote places. d. A simplified version (Basic System in Table 1) of the system with a smaller aquarium; ostensibly reduces weight, volume and cost, and increases portability. In this case, the system was adapted to the trunk of a car, demonstrating its versatility. e. Acrylic and glass components allow the AAP to be light and durable (i.e., front glass easily changed); curved acrylic sheet allows the fish to remain suspended regardless of body form and behavior.

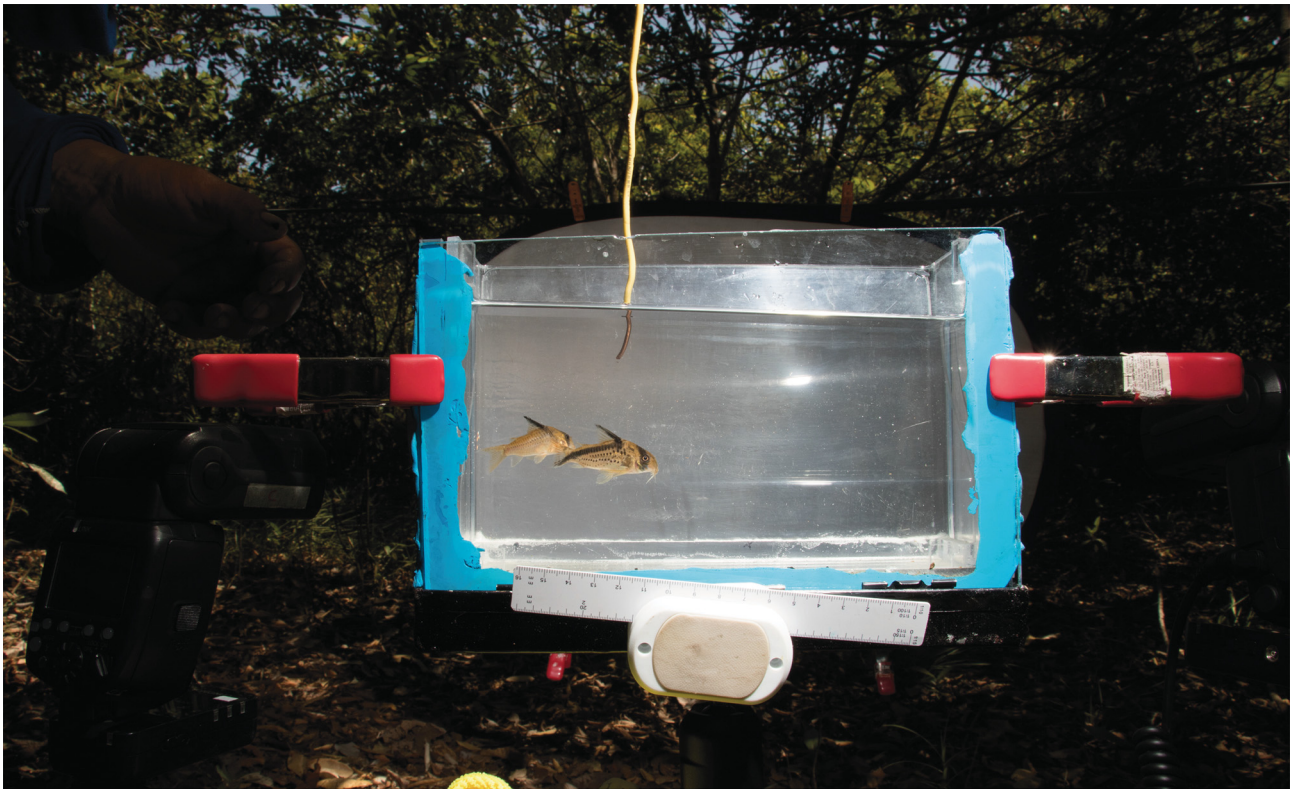

FIGURE 6. After placing the fish in the aquarium, the manipulation can be done using a small copper wire, rigid enough but also moldable to adjust its shape and facilitate handling inside the aquarium, especially for small size fish. It is also used to accommodate the fish or make it swim in the desired direction. This action can be facilitated with the help of another person. After some training time, it is possible to shoot the camera with one hand, and at the same time manipulate the fish with the wire.

The aquarium was filled with clear bottled or filtered/deionized tap water to minimize the formation of air bubbles on the specimen and glass. Unless exceptionally clear, stream or lake water is generally unsuitable because of suspended debris which can be a significant distraction in an otherwise good photo (Sabaj 2010). Some degree of suspended debris is tolerable for photographs against a white background. The absence of debris is more critical when shooting against a black background due to the contrast generated by the lighting. Therefore, photographs against a black background should be taken first.

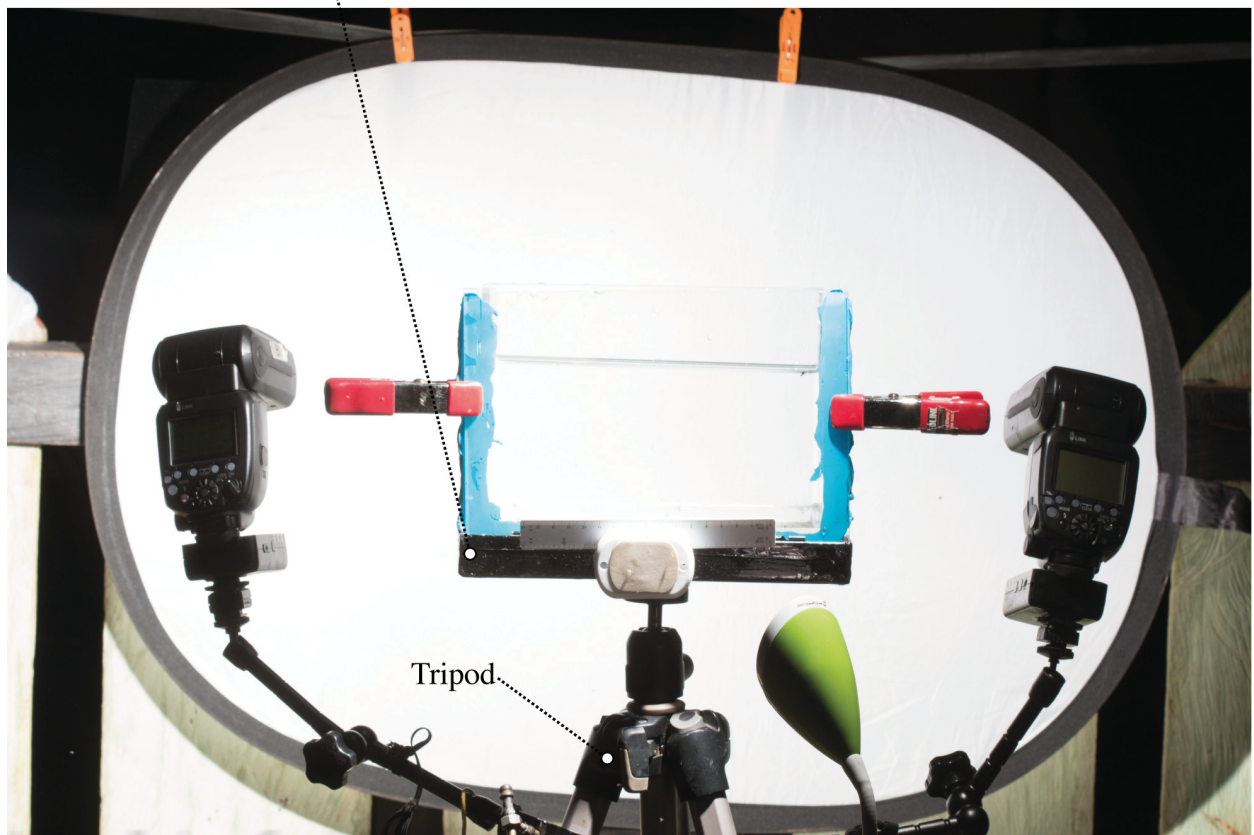

FIGURE 7. One of the most recent innovations to the system is the use of a simple tripod, with a metal plate adapted to support the aquarium. This reduces the space occupied by the system and facilitates its transport. In recent expeditions to the Colombian Amazon, it was transported for hours using different means of transport (plane, boat, car). Similarly, the system was carried by two people walking 6–12 km daily in the jungle during 20 days, to reach each of the sampling sites.

Laboratory/at home phase. Our workflow for image editing used Lighthouse v6.8 (LR) and Photoshop CC 2015 (PS) software from Adobe Systems Incorporated® because they are both powerful and widely used programs for cataloguing and editing images. For simplification, only the key steps are shown in our workflow. It is advisable to update the Adobe Camera Raw plug-in when importing images in LR and opening RAW files in PS, thus ensuring complete compatibility among images generated by recent camera models.

We used the traditional workflow for cataloguing and editing images in LR composed of three basic steps: 1. building a photo folder, 2. importing photos into an LR catalog and 3. using the Develop Module. Details for executing the first two steps are found in the LR user guide or video tutorials available on line at: <https://helpx.adobe.com/lightroom/user-guide.html>. Steps for editing images in the LR Develop Module and integration with PS for final image editing are shown in a video tutorial in the supplementary file S2.

Results

For more than a decade, we have tested a large variety of aquarium systems during ichthyological expeditions in Colombia. Obstacles included system portability and durability in remote places (e.g., study locations in the Atrato, Orinoco, and Amazonas basins), taking photos of living organisms, the artificiality of images obtained using an aquarium setup, and a lack of standards for images intended for taxonomic purposes. We managed to overcome many of these obstacles using the *Photafish System* as described below.

Portability and durability. The *Photafish System* was tested during several research expeditions over a period of two years, and it proved reliable enough to endure transport (via land, air and/or water) to remote locations. The portability and durability of the system (especially the AAP) made it possible to image fish species that were poorly documented or had never been photographed live (Fig. 8 of supplementary file S3). Traditionally, field photography of aquatic organisms has been more focused on increasing awareness and promoting conservation of wildlife close to our homes (e.g., Benvie 2013; Benvie & Bolt 2017; Sartore 2017). Setups constructed for such purposes have used tanks made of either glass or acrylic, but not in combination given the difficulty of joining the two materials. Acrylic aquariums are easily scratched during transport on long expeditions, but glass aquariums are heavy, difficult to transport (if large) and carry the risk of breaking in places where replacement is impossible. In our system, glass is only used for the front side of the aquarium and replacement glass is easy to carry in case of scratches or breakage. In Fig 2 and supplementary file S1, an ideal system is shown for a single person to comfortably photograph live specimens up to 50 or 55 cm TL. At first glance, the system may seem large and cumbersome. With the largest aquarium, however, the system (minus camera and flashes) weighs about 10 kg and occupies comparatively less space than a typical set of electro-fishing equipment. In addition, most of the time ichthyologists only require small or medium aquariums which reduces the weight of the system, and makes some components avoidable. For example, with smaller aquariums only two flashes are necessary, and the folding table and tripod (as well as other components) can be discarded, significantly reducing the overall cost of the system (see Table 1).

Photographing live organisms. As shown in Fig. 1, live Neotropical freshwater fishes are poorly represented in online image databases. Taxonomic papers on such fishes, especially those describing new species, often lack images of live specimens and rely on images of those fixed in formalin and preserved in alcohol. The subjects of such photos are also static and offer no sense of natural movement. With the *Photafish System*, it was possible to photograph live specimens in a range of sizes and colors while moving or in unusual positions (Figs. 10, 20, 21 of supplementary file S3). Additionally, multiple individuals can be photographed at once, or specific body parts can be photographed in detail. The latter images show features that are not apparent in most published photographs such as the iridescence, number of branched rays, and structural modifications in fins, the distribution and color of chromatophores, lateral line scales and pores, and the shape and orientation of the bones of the head as well as teeth, cephalic sensory pores, and even internal organs in semi-translucent fishes (Figs. 9-16 of supplementary file S3). Associated organisms (e.g., parasites) attached to the fins or skin also become more noticeable, thus contributing ecological information.

Artificiality. Our field studio technique makes the specimen the center of interest, avoids the artificiality of aquarium sets that simulate natural conditions and simplifies the overall image by rendering its appearance to that of a textbook illustration, particularly when using a white background (see Franco-Pérez *et al.* 2015). Although this

technique is growing in popularity among nature photographers, it remains underused as a valuable alternative to generating images for use in identification guides and taxonomic descriptions of new species.

Taxonomically Informative Photos (TIPs). In taxonomy, morphological characters have long been the primary source for distinguishing organisms at different levels of classification. A trained (or amateur) taxonomist can obtain valuable primary information from a good, standardized photo. Thus, we introduce the term Taxonomically Informative Photos (TIPs) to refer to an authentic, high-quality image taken in field from which it is possible to extract information useful to the accurate identification or description of an organism with a high level of confidence. We used Neotropical freshwater fish as a model for TIPs due to their great diversity, complex taxonomy and the difficulty of documenting live specimens. Images captured in the field are edited in LR and PS to produce high-resolution TIPs that highlight characters of taxonomic importance (Fig. 17a, 17b of supplementary file S3).

Standards for TIPs. Having many standardized images, not only of different species but of individuals from different populations showing morphological variation within species, facilitates the fish taxonomy workflow. Depending on size, color and taxonomic group, some morphological characters can be accentuated by the color of the background (white vs. black). A black background often creates a dramatic effect by accenting colors on the body and fins. This effect is most compelling when backlit flashes are used to highlight the dark contours of the subject, giving it a sense of volume. In Figs. 18a and 19a (in supplementary file S3) the fin rays are clearly visible as are the membranes and iridescent colors. However, the dark pigments in the fins are not easily visible, and colors can sometimes appear too pronounced, creating a biased perception. White backgrounds emphasize the true colors of fishes and highlight dark pigments in the fins; but, white or hyaline fins are less conspicuous, and their outlines can be absorbed by the background (Figs. 18b, 19b of supplementary file S3). With the *Photafish System*, it is easy to change from one background to another. In fact, for fishes that remain stationary in the aquarium (e.g., Astroblepidae in Fig. 17b of supplementary file S3) it is possible to generate almost identical images of the subject on different backgrounds. The use of two backgrounds (black and white) is complementary when obtaining TIPs of fishes and recommended for certain taxa (for examples, see photos in Motomura *et al.* 2017).

Fish in motion: Conservation of coexisting species in freshwaters. Using only flashes as light sources, any specimen (not only fish), can be captured in a wide variety of positions, generating many visual options (Fig. 20 of supplementary file S3). Thus, dynamic and natural images of swimming fish can be obtained for use not only in scientific publications, but also those intended for a general audience. Live photographs are generally more engaging to the public, and are thereby better able to convey information about the diversity of freshwater animals hidden in our rivers (Fig. 21 of supplementary file S3) as well as their incredible adaptations.

Discussion

We believe that the implementation of the *Photafish System* can have important implications for fish taxonomy as it can be adopted by a greater number of ichthyologists interested in graphically documenting their field expeditions. Obtaining a high-resolution image of a specimen permits other researchers to identify the species and provide verification or correction (McCullough *et al.* 2013). In addition, the rapid advancement in technology and software over the past few years has resulted in high-quality, user-friendly and more affordable imaging systems. However, shortcomings persist in the systems traditionally used for the photography of live fish in the field, and the quality and homogeneity of the resulting images employed by many ichthyologists. The *Photafish System* and workflow described and tested in this study helped to overcome multiple difficulties ranging from specimen capture to the final editing of photos for publication (e.g., García-Melo *et al.* 2018) or use in conservation campaigns.

The *Photafish System* facilitates the visual documentation of morphological characters in live specimens by optimizing and customizing methods for field photography, even in remote locations. The system employs many of the same basic equipment and practices that photographers have used for years, but in a way that democratizes fish photography for a wide range of users. Our system is not intended as a means for photo-identification or PBT (photography-based taxonomy *sensu* Pape 2016). Photo-identification is only applicable to animals that have individually identifiable features that can be photographed in the field and used for identification by visually matching photographs from previous surveys without other sources of information (after Knox *et al.* 2016). Compared with other taxonomic groups, few photo-identification studies have been carried out on fishes because

they are not easily identifiable in the field and multiple species are often too similar in terms of external characters (Dala-Corte *et al.* 2016). PBT aside, the *Photafish System* is an effective tool for supplementing taxonomic descriptions with high-quality images (TIPs) and contributing unique visual information to natural history collections and their associated databases (Garrouste 2017).

The appropriate use of TIPs depends on several factors. The first is the level of expertise of the people involved including evaluation by experts and non-experts of a taxonomic group (see Austen *et al.* 2016). The second is the authenticity of the photos and the ethical principles guiding their use. The third is the publication of the images in journals (as core content or supplementary material) with provisions for free access in online databases. In this sense, we promote the free online distribution and use of standardized visual information together with biological and geographical data to enhance freshwater fish taxonomy. This initiative is currently underway with Colombian ichthyofauna (www.jorgegarciabiophoto.com/cavfish).

Our approach has limitations, and successful results depend in part on the availability of suitable photographic equipment (i.e., SLR camera with two flashes and batteries) and clean water in the field (especially when using black backgrounds), user experience (basic knowledge of photography and editing software) and taxonomic skills (familiarity with characters used for identification in a particular group), the logistics of the study (location, transportation and time constraints) and focus research (e.g., rapid bioassessments and social inventories such as www.fm2.fieldmuseum.org/rbi). Hence, *Photafish System* Version 1.0 can be improved over time in terms of portability, handling, versatility and price. We will release periodically updates to the system with new versions, available on the website www.jorgegarciabiophoto.com/cavfish of the Visual Catalog of Freshwater Fishes of Colombia (CaVFish). Based on our suggestions, the user should be able to adjust the system to meet their own needs.

In the future, the spread of photographic devices with sensors and optics that offer extremely high image resolution (>100 megapixels) will allow photographers to capture images of living specimens at the level detail achieved by current projects involving insects, such as Microsculpture (www.microsculpture.net). Enhanced software may eventually reduce the time spent editing images to a few clicks. For example, Adobe Systems Incorporated® recently launched a *Select Subject* feature in Photoshop that uses Adobe's Artificial Intelligence platform (Sensei) and machine learning to identify and automatically mask subjects in the image. Nevertheless, field photography of biodiversity remains a challenge, particularly in megadiverse countries as Colombia.

Acknowledgements

JEGM especially thanks Jorge Enrique Garcia Diaz and Luz Marina Melo de García for supporting his photographic career for more than 20 years. The authors are grateful to Francisco Villa and Gladys Reinoso (Universidad del Tolima, Ibagué, Colombia), Fernando Trujillo (OMACHA Foundation, Colombia), Saulo Usma (WWF Colombia) and Carlos Lasso (IAvH, Colombia) for their institutional support during the fieldwork and photographic expeditions. Additionally, we are grateful to all the people who assisted us in the field during the many days of photography, particularly Juan Gabriel Albornoz, Cristian Conde, Diana Montoya, Edwin López, Jesús Vasquez, Pamela Zúñiga, Negover Briñez, Armando Ortega, Gian Carlo Sánchez and Lesley de Souza (The Field Museum). We are indebted to the laboratory staff of the Grupo de Investigación en Zoología (GIZ - Universidad del Tolima) and members of the Laboratorio de Ictiología (PUJ). This work was supported with personal resources and completed during the PhD work of JEGM, who is supported by the Instituto Colombiano para el Desarrollo de la Ciencia y la Tecnología Francisco José de Caldas (COLCIENCIAS-COLFUTURO, doctoral fellowship grant 567/2012) and the Division of Research of the Pontificia Universidad Javeriana (Project number: 00006552).

Literature cited

- Aguiar, J.J.M., Santos, J.C. & Urso-Guimaraes, M.V. (2017) On the use of photography in science and taxonomy: how images can provide a basis for their own authentication. *Bionomina*, 12, 44–7.
<https://doi.org/10.11646/bionomina.12.1.4>
- Akkari, N., Enghoff, H. & Metscher, B.D. (2015) A new dimension in documenting new species: High-detail imaging for

- myriapod taxonomy and first 3D cybertype of a new millipede species (Diplopoda, Julida, Julidae). *PLoS One*, 10 (8), 1–25.
<https://doi.org/10.1371/journal.pone.0135243>
- Austen, G.E., Bindemann, M., Griffiths, R.A. & Roberts, D.L. (2016) Species identification by experts and non-experts: Comparing images from field guides. *Scientific Reports*, 6 (33634), 1–7.
<https://doi.org/10.1038/srep33634>
- Benzie, N. & Bolt, C. (2009) Meet Your Neighbours. Available from: <http://meetyourneighbours.net/> (accessed 19 May 2017)
- Benzie, N. (2013) *The Field Studio: How to photograph nature on a perfect white background*. First publ. Wardhill, Brechin, Angus, 45 pp.
- Bertulli, C.G., Rasmussen, M.H. & Rosso, M. (2015) An assessment of the natural marking patterns used for photo-identification of common minke whales and white-beaked dolphins in Icelandic waters. *Journal of the Marine Biological Association of the United Kingdom*, 96 (4), 807–819.
<https://doi.org/10.1017/S0025315415000284>
- Caci, G., Biscaccianti, A.B., Cistrone, L., Bosso, L., Garonna, A. & Pietro, R.D. (2013) Spotting the right spot: Computer-aided individual identification of the threatened cerambycid beetle *Rosalia alpina*. *Journal of Insect Conservation*, 17 (4), 787–795.
<https://doi.org/10.1007/s10841-013-9561-0>
- Ceríaco, L.M.P., Gutierrez, E.E. & Dubois, A. (2016) Photography-based taxonomy is inadequate, unnecessary, and potentially harmful for biological sciences. *Zootaxa*, 4196 (3), 435–445.
<https://doi.org/10.11646/zootaxa.4196.3.9>
- Chim, C.K. & Tan, K.S. (2012) Recognition of individual knobby sea stars *Protoreaster nodosus* (L., 1758) using aboral surface characteristics. *Journal of Experimental Marine Biology and Ecology*, (430–431), 48–55.
<https://doi.org/10.1016/j.jembe.2012.06.028>
- Dala-Corte, R.B., Moschetta, J.B., Becker, F.G. (2016) Photo-identification as a technique for recognition of individual fish: A test with the freshwater armored catfish *Rineloricaria aequalicuspis* Reis & Cardoso, 2001 (Siluriformes: Loricariidae). *Neotropical Ichthyology*, 14 (1), 1–10.
<https://doi.org/10.1590/1982-0224-20150074>
- Davenport, L.J. & Roop, K.L. (2000) Teaching fish identification with a simple teaching- photographic tank. *The American Biology Teacher*, 62 (3), 202–203.
<https://doi.org/10.2307/4450873>
- Emery, A.R. & Winterbottom, R. (1980) A technique for fish specimen photography in the field. *Canadian Journal of Zoology*, 58, 2158–2162.
<https://doi.org/10.1139/z80-297>
- Franco-Pérez, L.M., García-Melo, J.E. & Guevara-Cardona, G. (2015) *Naturaleza Inadvertida: Conectando la Universidad con la Biosfera. First edition*. Universidad de Ibagué, Ibagué, Tolima, Colombia, 205 pp.
- Fricke, R., Eschmeyer, W.N. & Fong, J.D. (2017) *Species by family/subfamily Catalog of fishes*. California Academy of Sciences. Available from: <http://researcharchive.calacademy.org/research/ichthyology/catalog/SpeciesByFamily.asp> (accessed 1 March 2017)
- Froese, R. & Pauly, D. (2016) FishBase. Available from: <http://www.fishbase.org> (accessed 30 August 2016)
- García-Melo, J.E., Albornoz-Garzón, J.G., García-Melo, L.J., Villa-Navarro, F.A. & Maldonado-Ocampo, J.A. (2018) A New species of *Hemibrycon* (Characiformes, Characidae, Stevardiinae) from the upper Magdalena River Basin in Colombia. *Journal of Fish Biology*, 92 (6), 1929–1955.
<https://doi.org/10.1111/jfb.13634>
- Garrouste, R. (2017) The “wild shot”: photography for more biology in natural history collections, not for replacing vouchers. *Zootaxa*, 4269 (4), 453–454.
<https://doi.org/10.11646/zootaxa.4269.4.2>
- Goodbred, S. & Occhiogrosso, T. (1979) Method for photographing small fish. *The Progressive Fish-Culturist*, 41 (2), 76–77.
[https://doi.org/10.1577/1548-8659\(1979\)41\[76:MFPSF\]2.0.CO;2](https://doi.org/10.1577/1548-8659(1979)41[76:MFPSF]2.0.CO;2)
- Herler, J., Lipej, L. & Makovec, T. (2007) A simple technique for digital imaging of live and preserved small fish specimens. *Cybium*, 31 (1), 39–44.
- Holm, E. (1989) Improved technique for fish specimen photography in the field. *Canadian Journal of Zoology*, 67 (9), 2329–2332.
<https://doi.org/10.1139/z89-327>
- Howe, J.C. (1996) A technique for immobilizing and photographing small, live fishes. *Fisheries Research*, 27 (4), 261–264.
[https://doi.org/10.1016/0165-7836\(95\)00470-X](https://doi.org/10.1016/0165-7836(95)00470-X)
- Knox, C.D., Cree, A. & Seddon, P.J. (2016) Accurate identification of individual geckos (*Naultinus gemmeus*) through dorsal pattern differentiation. *New Zealand Journal of Ecology*, 37 (1), 60–66.
- Koivuniemi, M., Auttila, M., Niemi, M., Levänen, R. & Kunnasranta, M. (2016) Photo-ID as a tool for studying and monitoring the endangered Saimaa ringed seal. *Endangered Species Research*, 30, 29–36.
<https://doi.org/10.3354/esr00723>
- Leggett, R. & Kirchoff, B.K. (2011) Image use in field guides and identification keys: Review and recommendations. *AoB*

Plants, plr004, 1–37.

<https://doi.org/10.1093/aobpla/plr004>

- Krell, F.T. & Wheeler, Q.D. (2014) Specimen collection: Plan for the future. *Science*, 344 (6186), 815–816.
<https://doi.org/10.1126/science.344.6186.815>
- Marshall, S.A. (2008) Field photography and the democratization of Arthropod taxonomy. *American Entomologist*, 54 (4), 207–210.
<https://doi.org/10.1093/ae/54.4.207>
- Marshall, S.A. & Evenhuis, N.L. (2015) New species without dead bodies: A case for photobased descriptions, illustrated by a striking new species of *Marleyimyia hesse* (Diptera, Bombyliidae) from South Africa. *Zookeys*, 525, 117–127.
<https://doi.org/10.3897/zookeys.525.6143>
- McCullough, C., Worthington, C. & Paradise, C.J. (2013) Using digital macrophotography to measure biodiversity, identify insects, and enhance outreach and education. *American Entomologist*, 59 (3), 179–181.
<https://doi.org/10.1093/ae/59.3.176>
- Minteer, B.A., Collins, J.P., Love, K.E. & Puschendorf, R. (2014) Avoiding (Re)extinction. *Science*, 344 (6181), 260–261.
<https://doi.org/10.1126/science.1250953>
- Motomura, H., Alama, U.B., Muto, N., Babaran, R.P. & Ishikawa, S. (2017) *Commercial and bycatch market fishes of Panay Island, Republic of the Philippines*. The Kagoshima University Museum, Kagoshima, University of the Philippines Visayas, Iloilo, and Research Institute for Humanity and Nature, Kyoto, 246 pp.
- Pape, T. (2016) Taxonomy: Species can be named from photos. *Nature*, 537, 307.
<https://doi.org/10.1038/537307b>
- Rinne, J.N. & Jakle, M.D. (1981). The Photarium: A device for taking natural photographs of live fish. *The Progressive Fish-Culturist*, 43 (4) 201–204.
[https://doi.org/10.1577/1548-8659\(1981\)43\[201:TP\]2.0.CO;2](https://doi.org/10.1577/1548-8659(1981)43[201:TP]2.0.CO;2)
- Rydell, J. & Russo, D. (2014) Photography as a low-impact method to survey bats. *Mammalian Biology*, 80 (3), 182–184.
<https://doi.org/10.1016/j.mambio.2014.11.003>
- Sabaj, M.H. (2010) Photographic atlas of fishes of the Guiana Shield. *Bulletin of the Biological Society of Washington*, 2010, 52–59.
<https://doi.org/10.2988/0097-0298-17.1.52>
- Sannolo, M., Gatti, F., Mangiacotti, M., Scali, S. & Sacci, R. (2016) Photo-identification in amphibian studies: A test of I3S Pattern Marco. *Acta Herpetologica*, 11 (1), 63–68.
https://doi.org/10.13128/Acta_Herpetol-17198
- Smith, S. & Bisette, J. (2015) Photography and post-processing techniques for native fishes. *American Currents*, 40 (2), 26–29.
- Sköld, H.N., Aspengren, S., Wallin, M. & Sko, H.N. (2012) Rapid color change in fish and amphibians-function, regulation, and emerging applications. *Pigment Cell and Melanoma Research*, 26 (1), 29–38.
<https://doi.org/10.1111/pcmr.12040>
- Speed, C.W., Meekan, M.G. & Bradshaw, C.J. (2007) Spot the match-wildlife photo-identification using information theory. *Frontiers in Zoology*, 4 (2), 1–11.
<https://doi.org/10.1186/1742-9994-4-2>
- Sreekar, R., Purushotham, C.B., Saini, K., Rao, S.N., Pelletier, S. & Chaplod S. (2013) Photographic capture-recapture sampling for assessing populations of the Indian Gliding Lizard *Draco dussumieri*. *PLoS One*, 8 (2), 1–5.
<https://doi.org/10.1371/journal.pone.0055935>
- Steinke, D., Hanner, R.H. & Hebert, P.D.N. (2009) Rapid high-quality imaging of fishes using a flat-bed scanner. *Ichthyological Research*, 56 (2), 210–211.
<https://doi.org/10.1007/s10228-008-0068-8>
- Tautz, D., Arctander, P., Minelli, A., Thomas, R.H. & Vogler, A.P. (2003) A plea for DNA taxonomy. *Trends in Ecology and Evolution*, 18 (2), 70–74.
[https://doi.org/10.1016/S0169-5347\(02\)00041-1](https://doi.org/10.1016/S0169-5347(02)00041-1)
- Treilibs, C.E., Pavey, C.R., Hutchinson, M.N. & Bull, C.M. (2016) Photographic identification of individuals of a free-ranging, small terrestrial vertebrate. *Ecology and Evolution*, 6 (3), 800–809.
<https://doi.org/10.1002/ece3.1883>
- Wilder, K. (2009) *Photography and Science*. Reaktion Books Ltd., London, 144 pp.

Supplementary files

S1. Video-animation of *Photafish System* using white and black backgrounds.

https://drive.google.com/open?id=11pgTDYmoK5rGQ7JcIg_n4_okIZPwz40a

S2. Video of steps for editing images in LR using the Develop Module and integrating them into PS for final editing.

<https://drive.google.com/open?id=1v7roPjtmbX69kPqG00g-vZY7Y6B-wa1u>

S3. Images highlighting the potential of the *Photafish System* for field photography of live specimens in support of taxonomic studies. Fig. 8–Fig. 21.



FIGURE 8. Some species of freshwater fish are poorly documented. **a.** *Belonion dibranchodon* (Beloniformes: Belonidae), **b.** *Gymnorhamphichthys rondoni* (Gymnotiformes: Rhamphichthyidae) and **c.** *Schultzichthys gracilis* (Siluriformes: Trichomycteridae) are species difficult of shooting photos in field due to small size and transparency of their bodies and fins. With *Photafish System*, this task is greatly simplified.

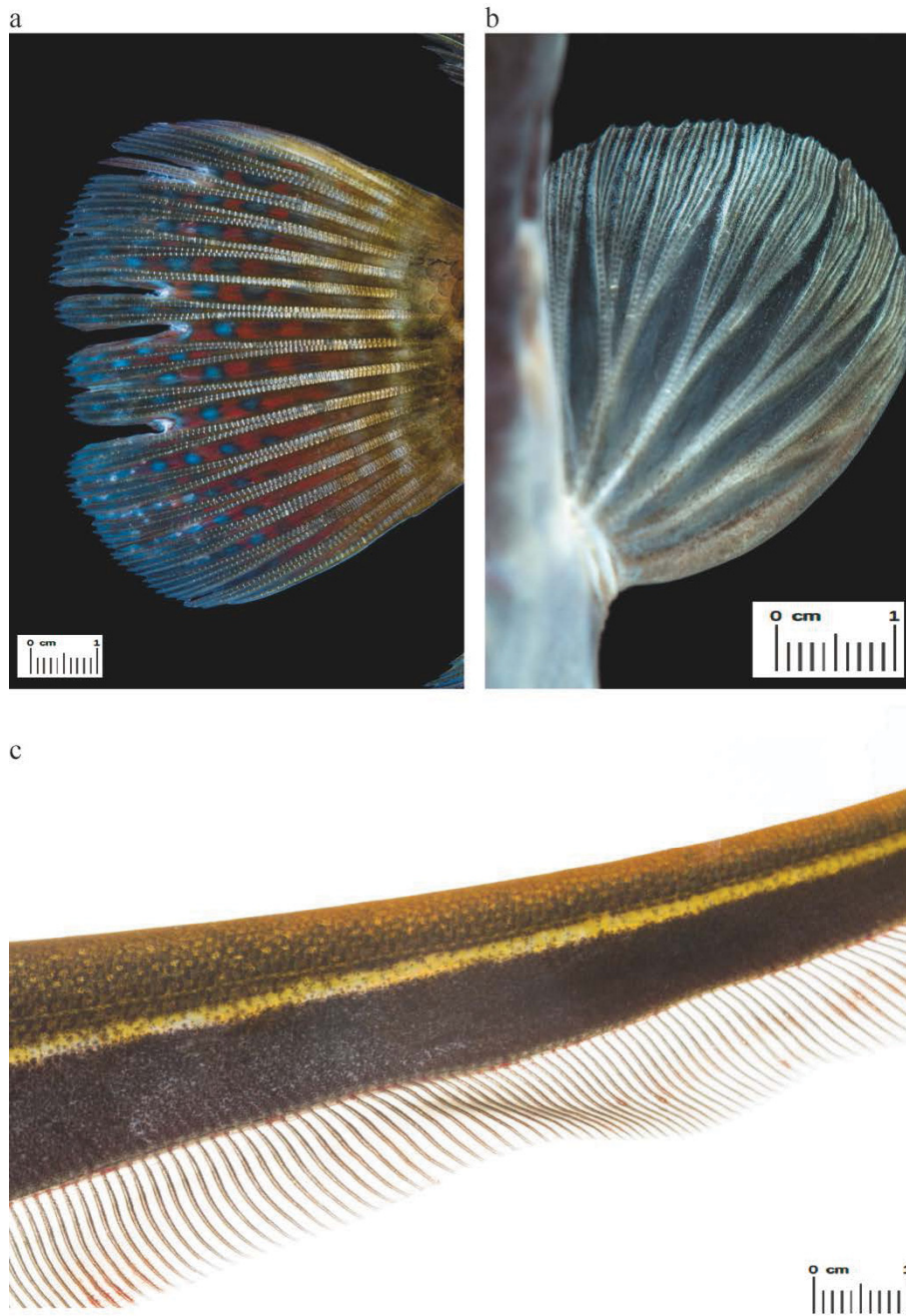

FIGURE 9. Detailed photographs of fins allow to clearly determine features such as coloring, number of rays, shape of rays, among others important characters for taxonomy. **a.** Caudal fin of *Kronoheros umbrifer* (Cichliformes: Cichlidae), **b.** pectoral fin of *Pimelodus grosskopfii* (Siluriformes: Pimelodidae) and **c.** anal fin of *Sternopygus aequilabiatu* (Gymnotiformes: Sternopygidae).

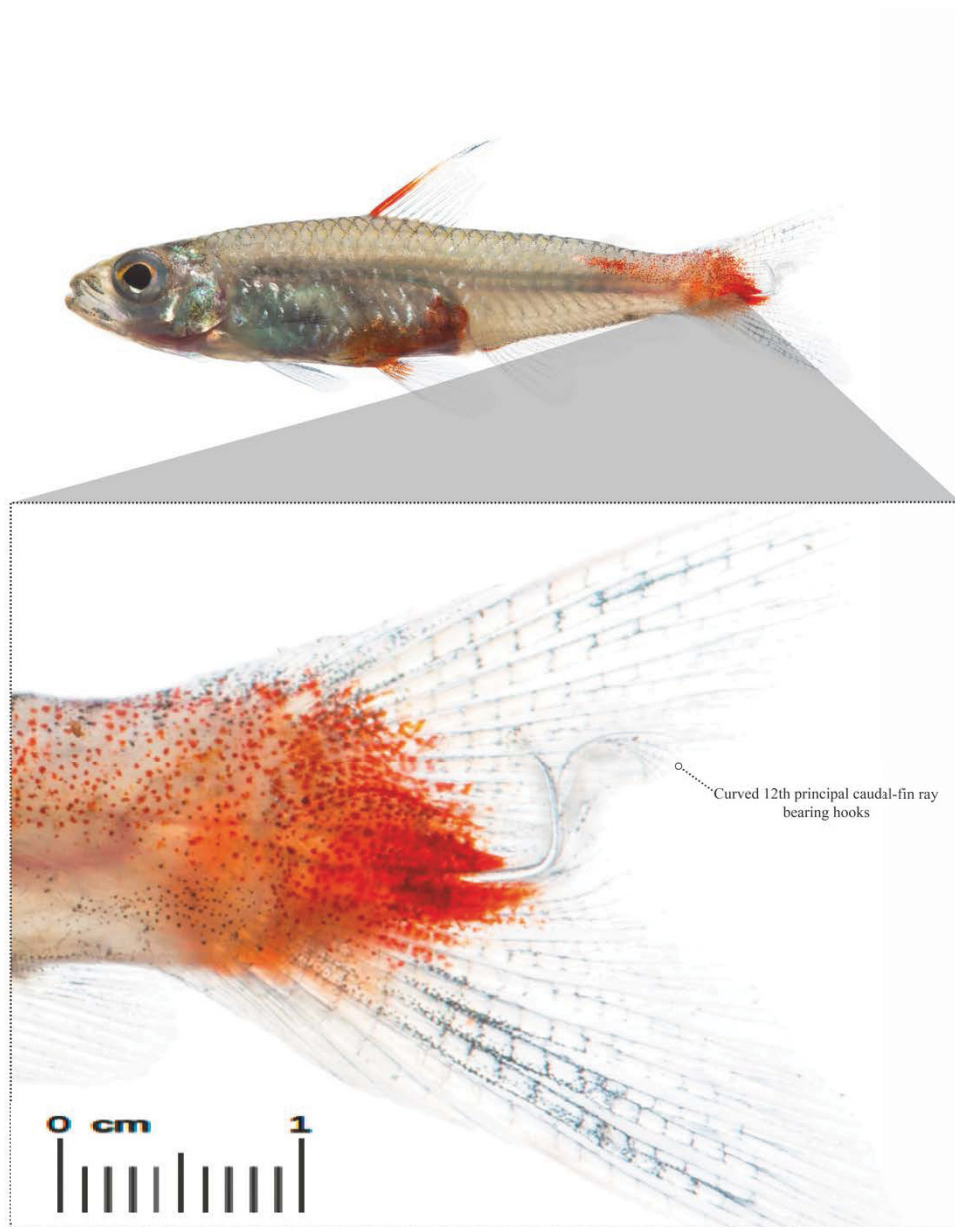

FIGURE 10. Photos highlighting diagnostic character of miniature characid *Brittanichthys* (Characiformes: Characidae). Mature male has a unique type of caudal fin with the 12th principal caudal-fin ray thickened, elongate, sigmoidally-curved, and projecting slightly to one side.

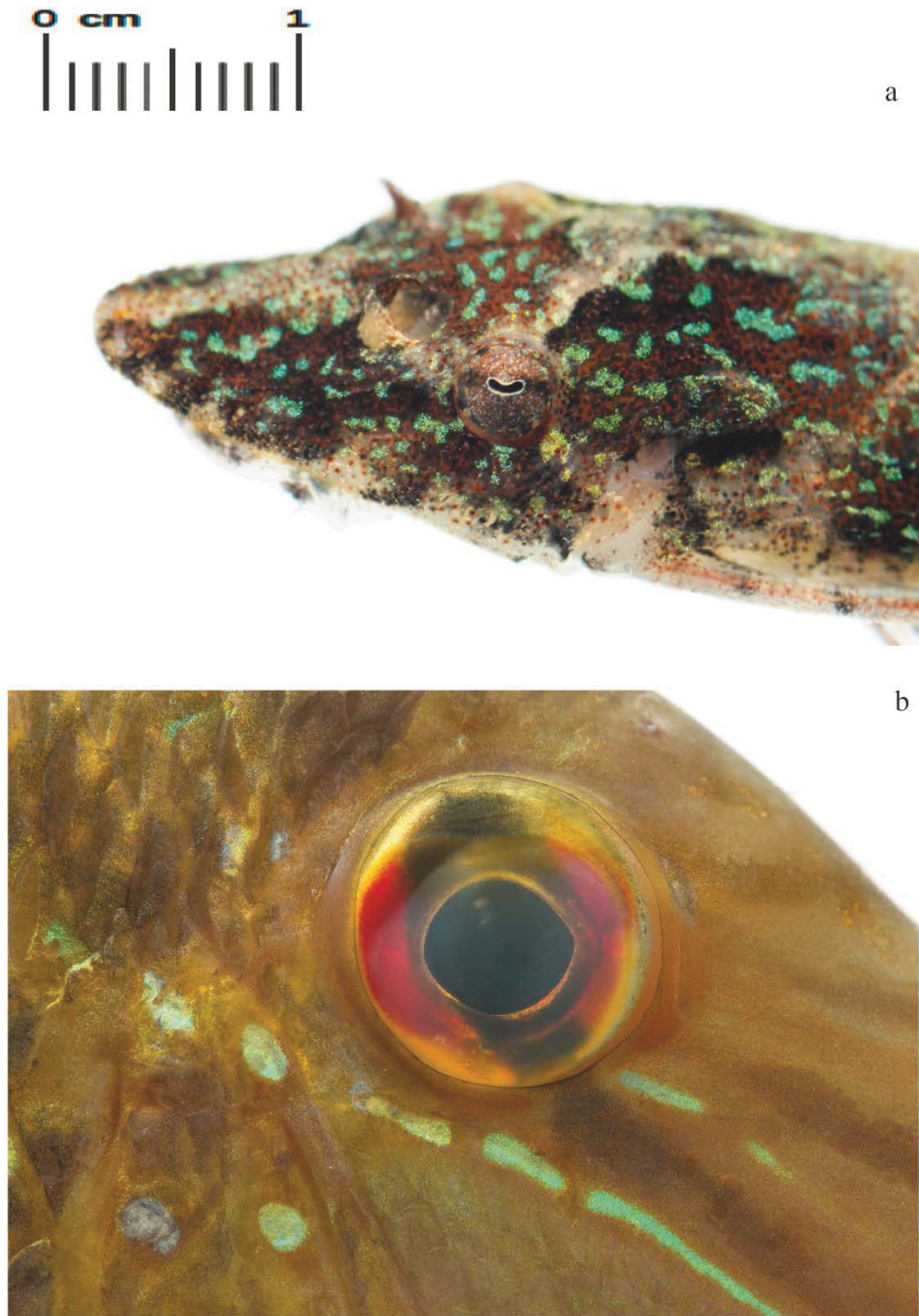

FIGURE 11. Distribution and color of the chromatophores in the fish determine important taxonomic features for description and identification. **a.** Chromatophores in the head of a juvenile of *Parotocinclus eppley* (Siluriformes: Loricariidae). **b.** Chromatophores in the eye of *Satanoperca daemon* (Cichliformes: Cichlidae).

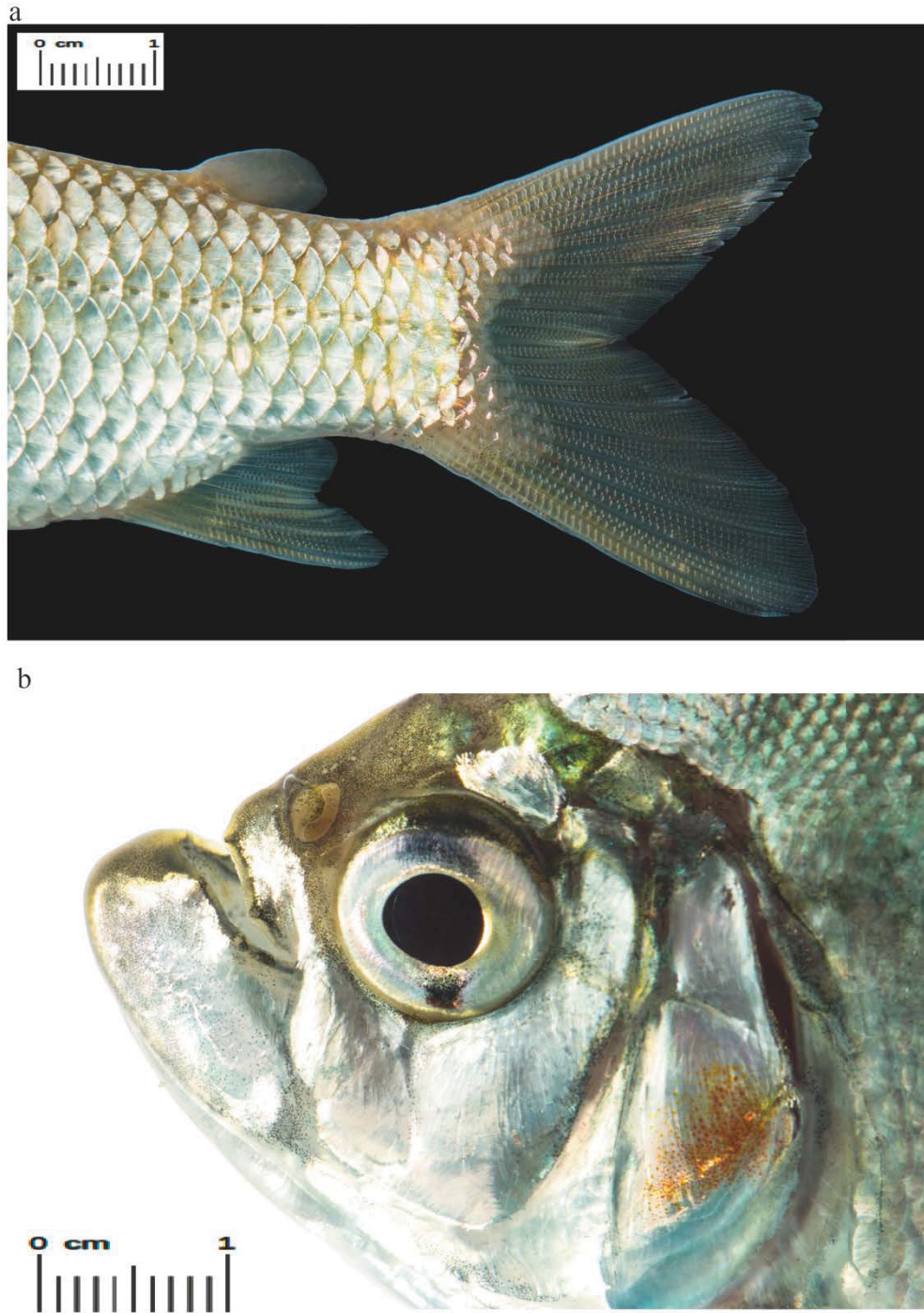

FIGURE 12. Detailed images of the lateral line in **a.** *Cyphocharax magdalenae* (Characiformes: Curimatidae) and **b.** bones of the head in *Catoprion mento* (Characiformes: Serrasalminidae).

a



b



FIGURE 13. In translucent body of electric glass knifefishes, the images obtained allow to identify structures such as brain, swim bladder, bones, digestive and circulatory system. **a.** *Eigenmannia* sp. (Gymnotiformes: Sternopygidae). **b.** *Gymnorhamphichthys rondoni* (Gymnotiformes: Rhamphichthyidae).



FIGURE 14. Number, size, shapes and kind of teeth are used in fish taxonomy and identification. Detailed images of these structures help in the identification of species. **a.** *Acestrorhynchus minimus* (Characiformes: Acestrorhynchidae). **b.** *Creagrutus maxillaris* (Characiformes: Characidae). **c.** *Boulengerella lateristriga* (Characiformes: Ctenoluciidae).



FIGURE 15. Images with magnification of the head of knifefishes reveals arrangement of cephalic latero-sensorial system's pores. **a.** *Apteronotus eschmeyeri* (Gymnotiformes: Apteronotidae). **b.** *Sternopygus aequilabiatus* (Gymnotiformes: Sternopygidae).

a



b



FIGURE 16. Mouth position in fish is a distinctive feature that is related to feeding and important for taxonomy. **a.** *Pseudanos winterbottomi* (Characiformes: Anostomidae). **b.** *Osteoglossum ferreirai* (Osteoglossiformes: Osteoglossidae).

a



FIGURE 17. Image or image sets which allow extraction of useful information for taxonomy with high level of confidence, and can be used as TIPs. TIPs can be composed of several photos that highlight features of specimens. The *Photafish System* allowed shooting pictures in different views and magnifications of **a.** *Cyphocharax magdalenae* (Characiformes: Curimatidae) and **b.** *Astroblepus mariae* (Siluriformes: Astroblepidae).

b



FIGURE 17. b



FIGURE 18. *Sternopygus aequilabiatus* (Gymnotiformes: Sternopygidae) photographed with black background and white background. Note that each background provides different color information. **a.** The black background accentuates the yellow and purple colors and makes the fins very visible. **b.** The white background emphasizes the chromatophores of skin and highlights the pigment of the fins. Thus, the description of live fish could be done more reliably. Therefore, we suggest including both backgrounds, especially in publications.

a



b



FIGURE 19. *Saccodon dariensis* (Characiformes: Parodontidae) photographed with black and white background. **a.** The iridescent pink color of the lower body and the pectoral and pelvic fins are evident with the black background, while **b.** the dark red color on the pectoral fin stands out when using the white background.

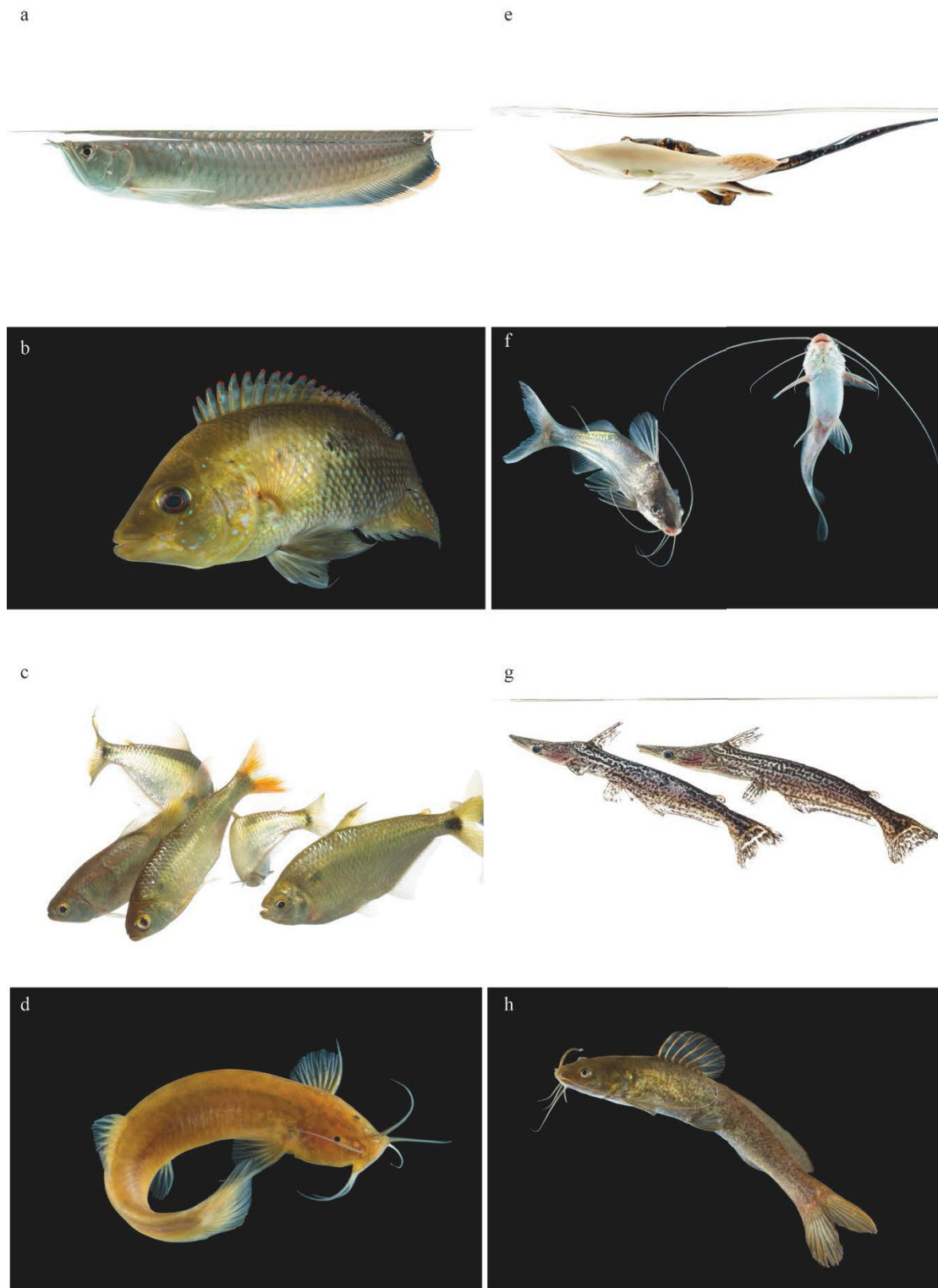

FIGURE 20. The dynamism that brings an image of a subject in motion is very useful to give naturalness and generate visual attraction in the viewer. Fins and bodies curved in different positions, two or more individuals included in the frame and the inclusion of the water level of the aquarium, are elements that distinguish a photo for a taxonomic guide of a photo used for dissemination and conservation. The latter aims to reach a wider audience and serves as an awareness mechanism. The objective is to achieve the pictorial superiority of the fish, that is, to make the images more remembered than the words. **a.** *Osteoglossum ferreirai* (Osteoglossiformes: Osteoglossidae). **b.** *Kronoheros umbrifer* (Cichliformes: Cichlidae). **c.** *Astyanax magdaleneae* and *Astyanax filiferus* (Characiformes: Characidae). **d.** *Trichomycterus* sp. (Siluriformes: Trichomycteridae). **e.** *Potamotrygon magdaleneae* (Myliobatiformes: Potamotrygonidae). **f.** *Pimelodus grosskopfii* (Siluriformes: Pimelodidae). **g.** *Ageneiosus caucanus* (Siluriformes: Auchenipteridae). **h.** *Rhamdia quelen* (Siluriformes: Heptapteridae).

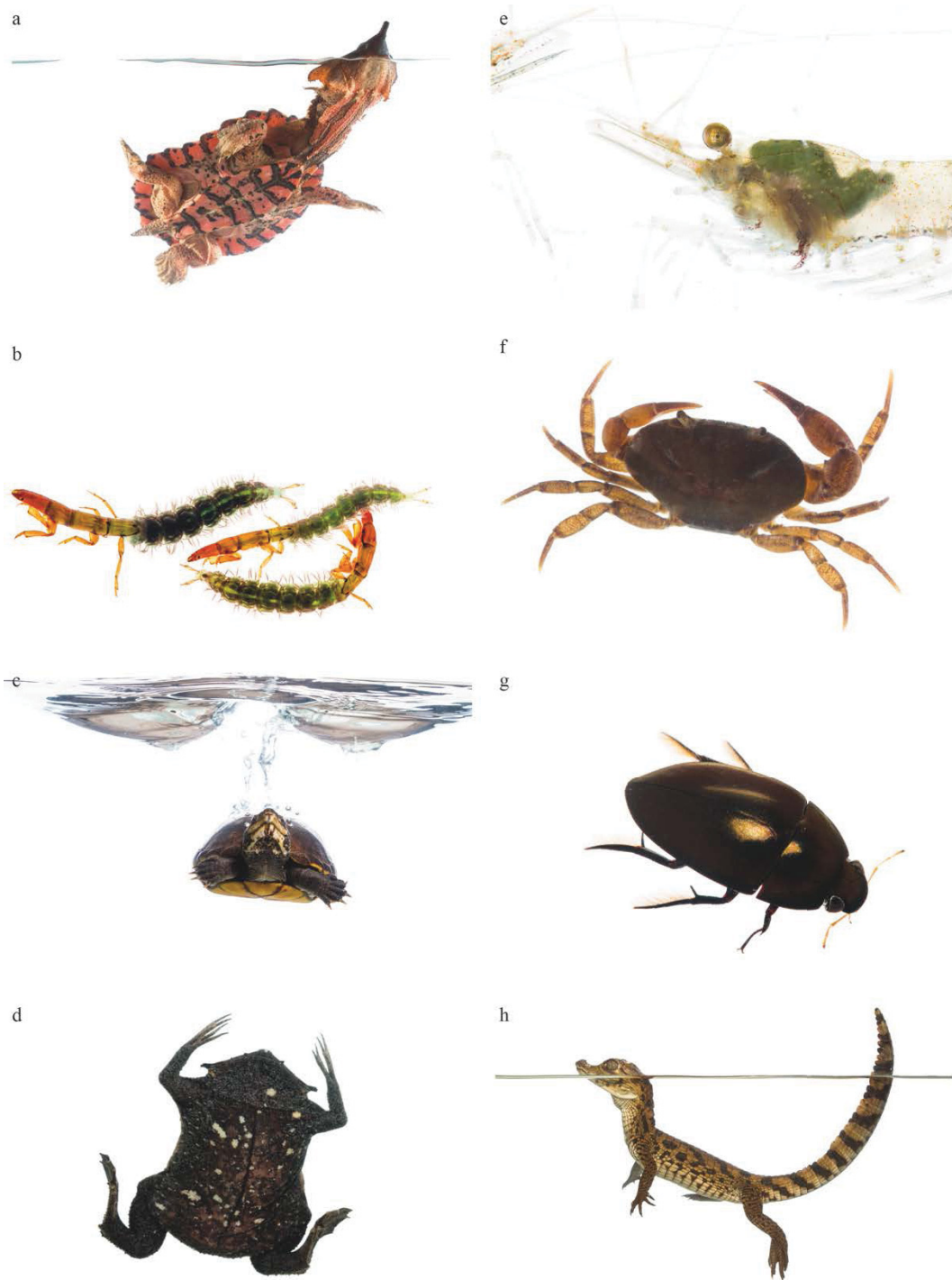

FIGURE 21. Several other taxonomic groups that coexist with the fish fauna can also be photographed (e.g., benthic macroinvertebrates, amphibians, reptiles, etc.). Therefore, our system is polyvalent and can be adjusted, according to the size of the organisms.

S4. Video-animation on how to build the Aquarium Assembly for Photography (AAP).

https://drive.google.com/file/d/1DvMG5TRlibwllmh0jzO408aY_JDNX7Ts/view

S5. Planes with each of the pieces to build three sizes of aquaria.

LARGE AAP

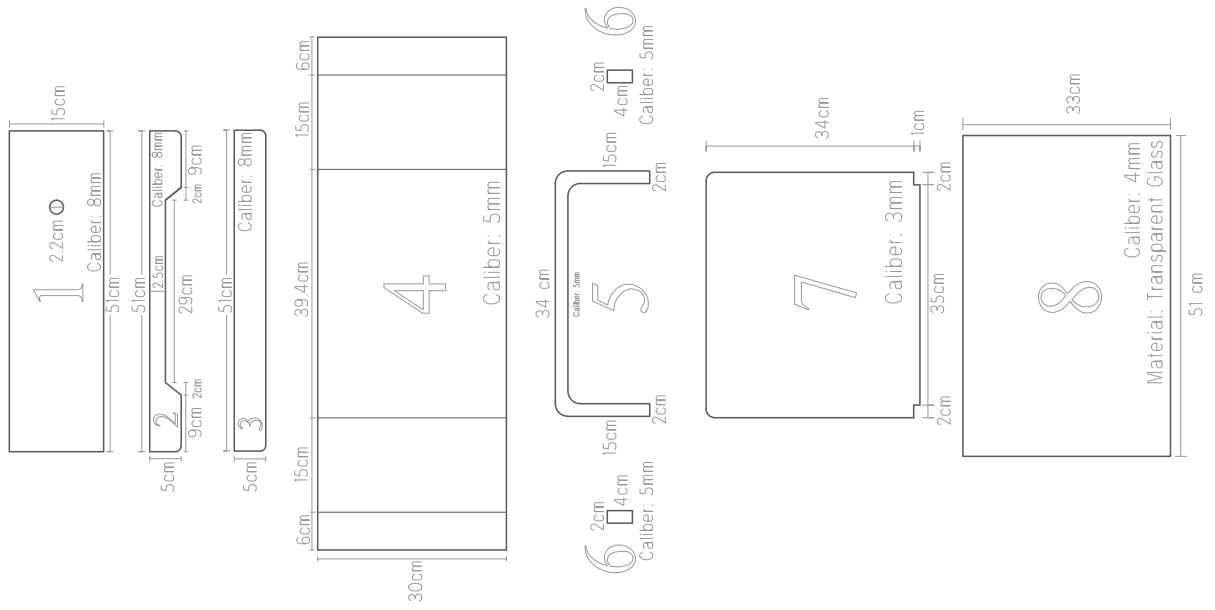

MEDIUM AAP

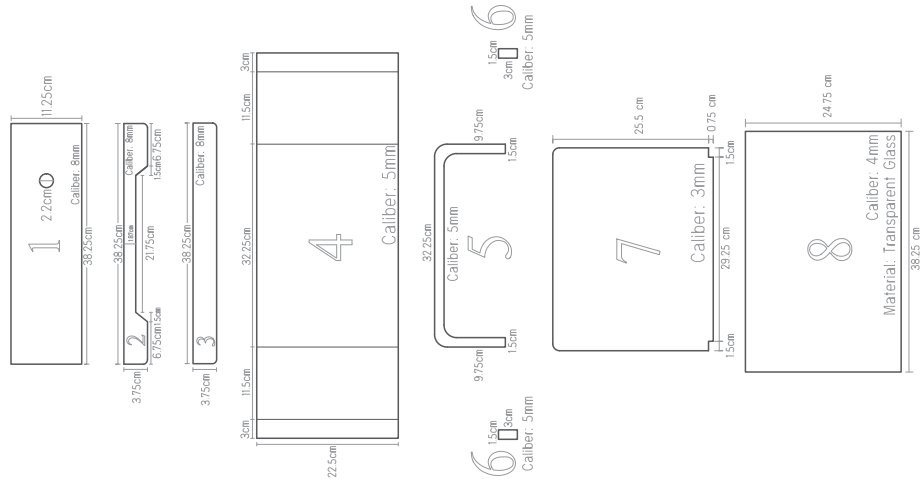

SMALL AAP

