

Nikon Speedlight

SB-11

INSTRUCTION MANUAL

NOMENCLATURE

① Wide-Flash Adapter SW-3

② Tilting flash head

③ Shooting mode selector

④ Sensor Unit SU-2

⑤ Exposure calculator dial

⑥ Sync/multiple flash sockets

⑦ Sensor socket

⑧ Bracket mounting adapter

⑨ Sync Cord SC-11

⑩ Bracket mounting pin

⑪ Attachment screw

⑫ Bracket SK-4

⑬ Tripod socket

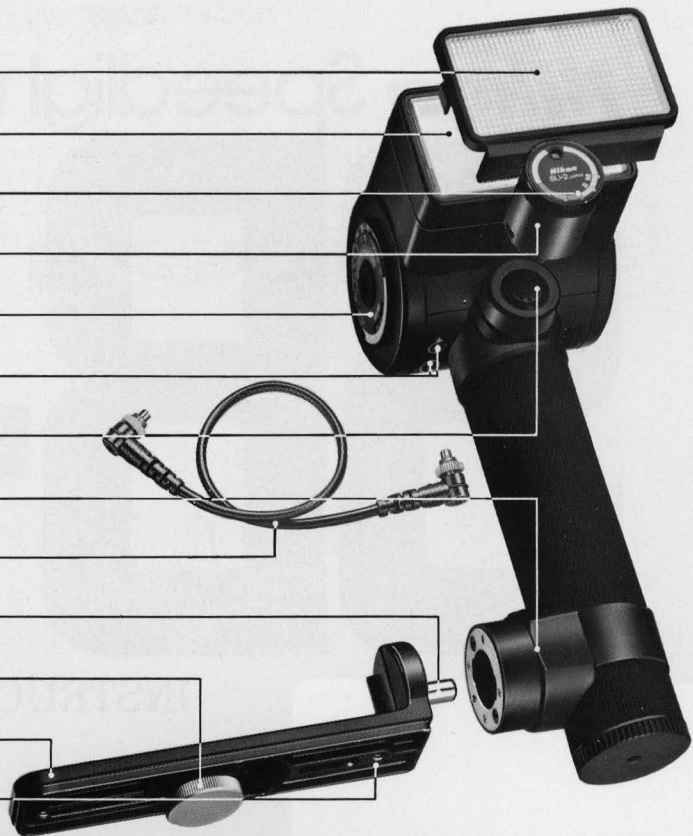



CONTENTS

NOMENCLATURE	2-3
FOREWORD	5
BASIC OPERATION	6-12
CONTROLS IN DETAIL	13-21
Bracket SK-4	13
Bracket Mounting Adapter	13
Tilting Flash Head	14
Wide-Flash Adapter SW-3	15
Exposure Calculator Dial	16-17
Sensor Unit SU-2	18
Ready-Light	19
Open-Flash Button	19
External Power Terminal	20
Sync/Multiple Flash Sockets	20
Sync Cord SC-11	21
Synchronization Chart	21
ACCESSORIES	22
TTL Remote Cords SC-12 and SC-23	22
Sensor Remote Cord SC-13	22
Sync Cord SC-15	22
DC Unit SD-7	22
"RED EYE"	23
TIPS ON SPEEDLIGHT CARE	24-25
OPTIMUM BATTERY PERFORMANCE	26
SPECIFICATIONS	27

FOREWORD

Compatible with all Nikon SLR cameras, the bracket-mounting Nikon Speedlight SB-11 features automatic control of the flash exposure to match the flash-to-subject distance. By utilizing a silicon-controlled rectifier and series circuitry, the speedlight is also able to conserve its excess energy for the next shot when shooting subjects at close range thus reducing recycling time and increasing the number of flashes per battery set. The optional accessory TTL Remote Cord SC-12 (for the Nikon F3-series camera) or SC-23 (for the Nikon FA, FE2, F-301/N2000 or FG camera) allows the SB-11 to be used for automatic TTL (through-the-lens) control of the flash exposure. In addition, the SB-11 has a tilting flash head allowing you to bounce the light off the ceiling or walls for more diffused lighting—a technique especially useful when taking portraits or snapshots.*

Even though the SB-11 is extremely easy to use, you should familiarize yourself with the unit's basic operation as presented in the first section. For more detailed information, please refer to "CONTROLS IN DETAIL." A few minutes wisely invested now will pay off later in years of rewarding photographic experiences.

**In the U.S.A. and Canada, the Nikon F-301 camera is sold as the Nikon N2000.*

BASIC OPERATION

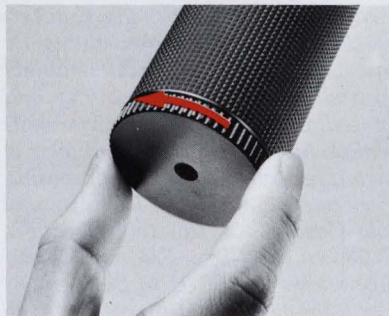

1. Open the battery chamber.

Unscrew the lid (25) at the base of the handle and remove the battery clip.



2. Attach the bracket mounting adapter (8) to the speedlight's handle (27).

First, use the screwdriver provided to loosen the two screws on the bracket mounting adapter. Then, slip the adapter onto the speedlight's handle and slide it to the desired position. Orient the adapter so that its flat side is in the same plane as the speedlight's exposure calculator dial (5). Make sure the locking wheel (24) is facing toward the rear of the speedlight.



3. Secure the bracket mounting adapter.

Tighten the screws to secure the adapter into place.

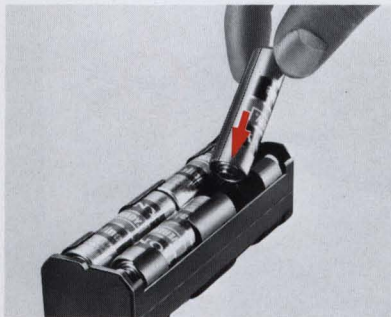

4. Load the batteries.

Insert eight AA-type penlight batteries following the + and - symbols on the inside of the battery clip.



5. Install the battery clip.

Insert the battery clip into the battery chamber. Make sure the terminal end goes in first. Then line up the V-shaped notch on the end of the clip with the white dot on the rim of the battery chamber. Push the clip position until it drops into the fully seated position.

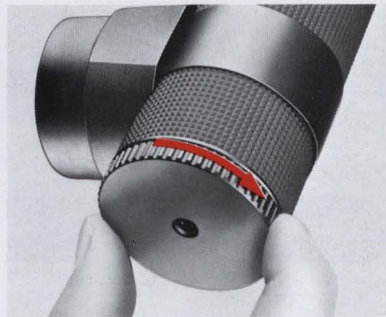

6. Close the battery chamber.

Screw the battery lid back into place.

BASIC OPERATION—continued

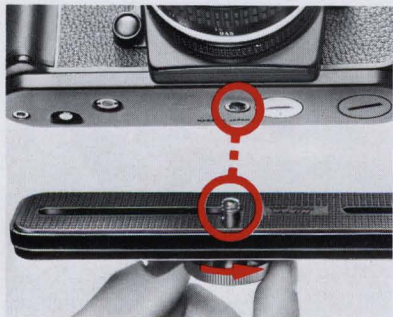

7. Attach the bracket ⑫ to the camera.

Position the camera in the bracket with the bracket mounting pin ⑩ on the same side of the camera as its rewind knob. Then, screw the bracket's attachment screw ⑪ into the camera's tripod socket to secure the two units together tightly.

Note: For attachment to the MD-4 Motor Drive, you must reposition the bracket's attachment screw to the other slot ⑬. For details, refer to page 13.

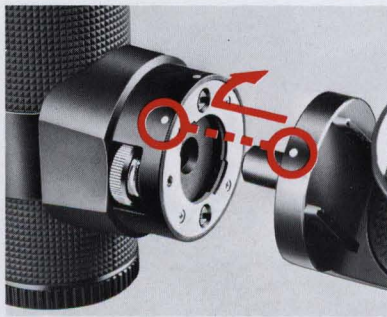

8. Attach the bracket to the speedlight.

Insert the bracket mounting pin into the hole in the bracket mounting adapter with the two dots ⑳ aligned; rotate the camera forward.



9. Tighten the locking wheel completely.

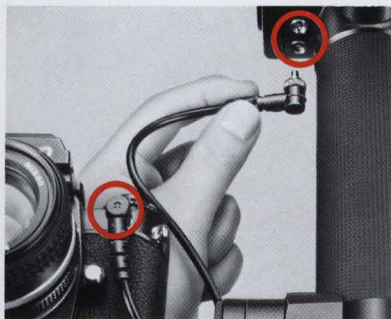

10. Attach the sync cord ⑨.

Screw one end of the SC-11 Sync Cord into either of the speed-light's sync/multiple flash sockets ⑥; screw the other end into the camera's sync terminal.



11. Plug in the sensor ④.

With the "Nikon" name up, push the Sensor Unit SU-2 into the sensor socket ⑦ until it click-locks into place.

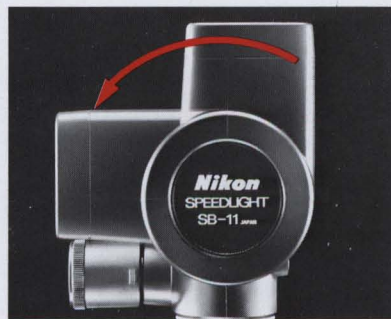

12. Rotate the flash head ② to the normal shooting position.

BASIC OPERATION—continued

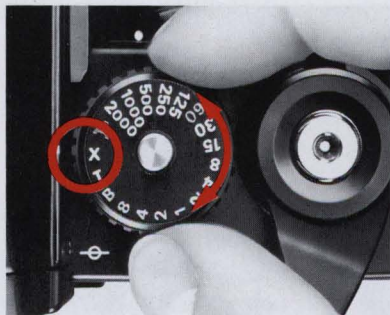

13. Set the camera's shutter speed for proper synchronization.

Set the shutter speed dial to the highest synchronization speed for electronic flash (e.g. set the F3 to the "X" setting). For other camera models, refer to the chart on page 21.

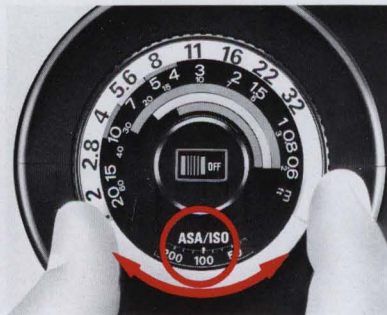

14. Set the exposure calculator dial ⑤.

Turn the dial until the ASA/ISO index ① is opposite the speed of the film in use. The color-coded lines underneath the f/stop scale ② indicate the three usable f/stops for automatic operation, whereas the auto shooting range indicators ③ give you the range of flash-to-subject distances. For example, if you're using ASA/ISO 100 film and select f/4, the automatic shooting range is indicated by an orange line. Thus you can shoot any subject located between 0.6 and 9 meters (2 and 30 feet) from the speedlight.



15. Set the lens aperture ring to an appropriate f/number.



16. Set the shooting mode selector ③.

Turn the ring on the front of the sensor until the white index is opposite the color corresponding to that of the f/stop selected. This sets the speedlight for automatic operation.

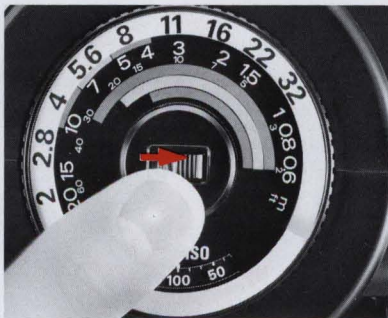

17. Turn on the speedlight.

Slide the power switch ⑭ to uncover the red mark.



18. Watch the ready-light ⑮.

As soon as the LED ready-light comes on, the speedlight is ready to fire.

BASIC OPERATION—continued



19. Take the picture.

After the speedlight fires, if the ready-light, does not blink, you have a perfect flash exposure.

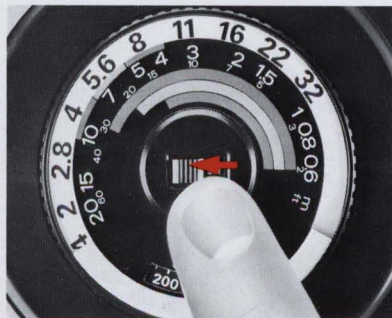

20. Turn off the speedlight.

To conserve battery power between shooting sessions, slide the power switch to the OFF position.

CONTROLS IN DETAIL

For FA, FE2,
FE, FM2, FM

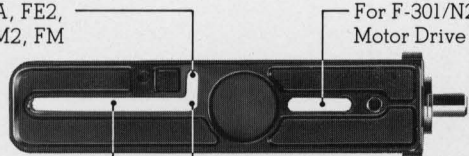

For F-301/N2000*,
Motor Drive MD-4

For MD-11,
MD-12, MD-14,
MD-15

For F3-series, F-301/N2000
(with AH-3), FG, FG-20, EM, F2,
MD-2, MD-3, MD-E, MB-1, MB-2

* To fit the SK-4 securely onto the Nikon F-301/N2000 camera, use the Nikon Tripod Adaptor AH-3.

Bracket SK-4 ⑫

The Speedlight SB-11's bracket can be attached to various camera and/or motor drive combinations. To change the attachment screw from one slot to another, slide it to the threaded end of the slot and unscrew it; then screw it back into the threaded end of the other slot. Once screwed in, the attachment screw can be moved freely to any position along the slot. The diagram indicates the recommended position of the attachment screw for all Nikon SLR cameras and motor drives.

Note: The bracket contains a tripod socket ⑬ for direct attachment of the camera and speedlight to a tripod.



Bracket Mounting Adapter ⑧

The release/locking wheel on the bracket mounting adapter allows the speedlight to be removed from the bracket for off-camera flash operation. To detach the speedlight, loosen the release/locking wheel completely by turning it to the end of its travel, push the locking wheel to the left to release the catch, tip the camera backward until the two white dots are aligned and pull the camera away from the speedlight.

Note: The speedlight's handle contains a tripod/light stand socket ⑭ for mounting of the speedlight on a tripod or light stand for more convenient off-camera operation.

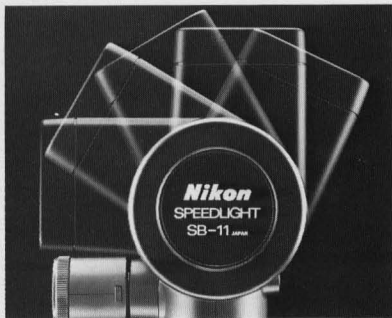

Tilting Flash Head ②

The SB-11's tilting flash head has click-stops at 30°, 60°, 90°, and approx. 120°. For normal shooting, point the flash head straight ahead. In this position, the light travels directly out to the subject providing the maximum amount of light possible. However, to soften the shadows and lower the contrast for indoor snapshots, you can tilt the flash head back to bounce the light off the ceiling or walls. Consult the illustration for details. You can also use the open-flash button ② in conjunction with the ready-light to determine if there is enough light for correct exposure *before* actually taking the picture. Please see page 19 for more information. The color temperature of the SB-11's light output is balanced for use with daylight-type color film.

Notes:

- 1) When the flash head is tilted back only 30°, some amount of light from the flash head may reach the subject directly, causing unevenness of illumination. To avoid this, make sure the flash head is tilted back 60° or more.
- 2) Unless the surface you are using to bounce the light off is white or silver, your color photographs will come out with an unnatural color cast similar to that of the reflecting surface.

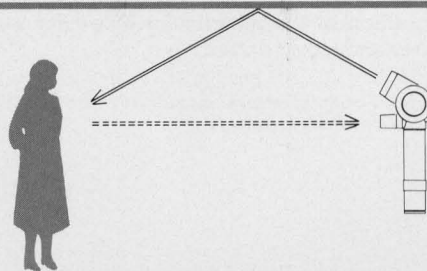

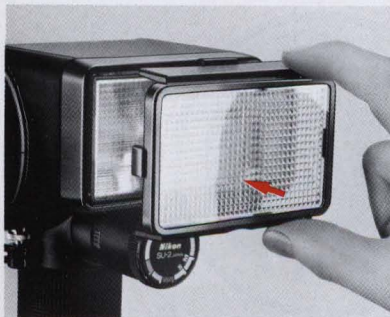

Wide-Flash Adapter SW-3 ①

The angle of illumination of the SB-11 by itself is 56° horizontally and 40° vertically—wide enough for use with a 35mm wideangle lens. When the Wide-Flash Adapter is clipped onto the front of the flash head, it increases the illumination to 67° horizontally and 48° vertically providing just the right amount of coverage when a 28mm lens is used. With the SW-3 attached, the light output of the speedlight is reduced resulting in a decrease in guide number from 36 (ASA/ISO 100 and meters) to 25. The ASA/ISO 25 and feet guide number is reduced from 60 to 42.

Note: To detach the Wide-Flash Adapter SW-3, first rotate the tilting flash head to other than the horizontal position. Then lift up the catch at the top of the SW-3 to remove it.

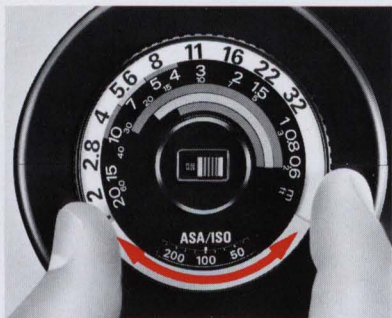

Exposure Calculator Dial ⑤ For Automatic Operation

The SB-11's exposure calculator dial helps you select the usable range of *f*/stops for the speed of the film in use and the flash-to-subject distance. On the dial, there are three *f*/stops to choose from. Each *f*/stop determines the usable distance range in which you can obtain the correct automatic exposure. The automatic shooting ranges for the three *f*/stops are indicated by a set of curved color-coded lines near the center of the dial.

If the subject distance remains the same, the wider the aperture you select, the faster the recycling time of the speedlight and the greater the maximum shooting distance, but the less depth of field in the final photograph.

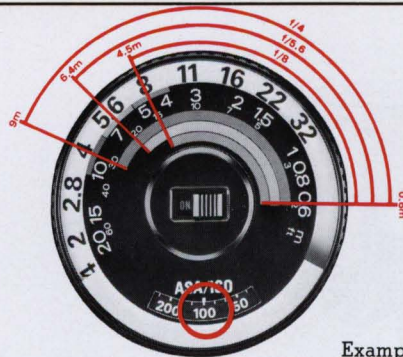

Example 1

Conversely, if you choose a small aperture, the depth of field will be greater, but the recycling time will be longer and the maximum shooting distance is less. Therefore, in choosing an appropriate *f*/stop, you should take all these factors—depth of field, recycling time, and maximum shooting distance—into consideration. The following examples explain how to use the exposure calculator dial:

Example 1

If you are using ASA/ISO 100 film, you can shoot subjects at distances from 0.6—9m (2—30ft) at *f*/4, 0.6—6.4m (2—21 ft) at *f*/5.6, and 0.6—4.5m (2—15ft) at *f*/8.

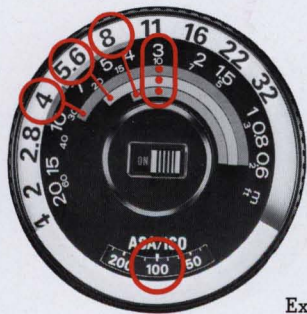

Example 2

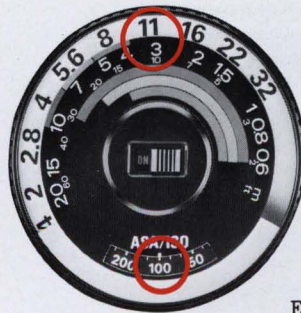

Example 3

Example 2

With ASA/ISO 100 and a subject three meters (10 feet) away, you can shoot at either $f/4$, $f/5.6$, or $f/8$. If a short recycling time is preferable, use $f/4$. If greater depth of field is desired, use $f/8$.

Once you've selected an appropriate f /stop for the film in use and the flash-to-subject distance, set this f /number on your lens and fire away. Your pictures will come out properly exposed.

For Manual Operation

Simply read off the f /number which appears directly above the flash-to-subject distance W ; then set this aperture on your lens.

Example 3

At ASA/ISO 100, if the subject is three meters (10 feet) away, you should set the aperture ring on your lens to $f/11$.



Sensor Unit SU-2 ④

The plug-in Sensor Unit SU-2 controls the operation of the SB-11 Speedlight. It has five settings to choose from.

At the Auto Positions

To shoot on Auto, lift up and turn the knurled ring on the outside of the sensor to one of the three positions (orange, yellow, or blue) which are color-coded for use with the exposure calculator dial. At these settings, the SB-11 is able to vary its light output automatically to match the flash-to-subject distance.

At the S (Slave) Position

At this setting, the SB-11 emits a modulated burst of light which can trigger a second electronic flash. The remote flash unit is attached to the receiver portion of the optional

Modulite Remote Control Unit ML-1 (which is set to Channel 2), while the SB-11 Speedlight acts as the transmitter.

At the M (Manual) Position

Set the SU-2 to the M setting and the SB-11 operates manually at its maximum light output regardless of the flash-to-subject distance. In this case, you have to calculate the exposure manually by referring to the exposure calculator dial. See page 17 for more information.



Ready-Light ⑳

Built into the back of the SB-11's flash head is a ready-light which comes on as soon as the speedlight is recycled and ready to fire. As an additional feature, the ready-light blinks if the speedlight fires at its maximum output indicating that the light might be insufficient for correct exposure on Automatic. The warning blinks last for approximately two seconds.



Open-Flash Button ㉑

The red open-flash button is used to fire the speedlight manually without having to trip the camera's shutter. In this manner, you can create multiple-exposure "stroboscopic" effects or paint the scene with light by firing the speedlight repeatedly with the camera set to "B" or "T." The open-flash button is also used in conjunction with the ready-light to determine if you can get the correct exposure when shooting on Automatic. This is especially useful when doing bounce flash. After setting up the shot, push the open-flash button. If the ready-light does not blink, you can take the picture. If it does blink, try moving the speedlight closer to the subject or bounce surface, or reset the Sensor Unit SU-2 to a color-coded position calling for a wider aperture.

CONTROLS IN DETAIL—continued



External Power Terminal ⑭

This terminal is for connection of a separate battery pack.



Sync/Multiple Flash Sockets ⑥

Two standard Nikon screw-in type terminals are provided on the SB-11 Speedlight. Either terminal can be used to attach the Sync Cord SC-11, while the other is provided for connecting the SB-11 with another speedlight in series for multiple flash operation.

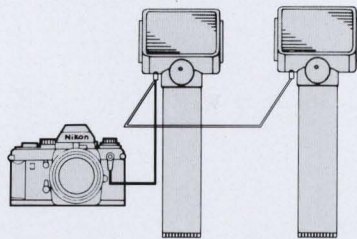

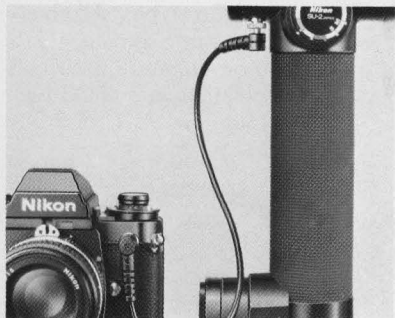

Sync Cord SC-11 ⑨

This cord has standard Nikon connections at both ends for positive attachment of the SB-11 to a Nikon camera having a screw-in type sync terminal.

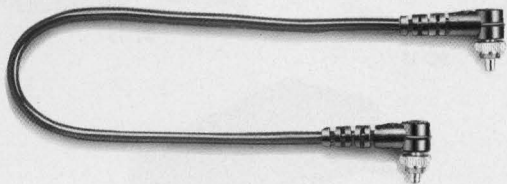

Synchronization Chart

Nikon Camera	Proper synchronization speed (sec.)
F3-series	1/80 (X) or slower
FA	1/250 or slower
FE2	1/250 or slower
FE	1/125 or slower
FM2 (with 1/250 sec. sync speed)	1/250 or slower
FM2 (with 1/200 sec. sync speed)	1/200 (X200) or slower
F-301/N2000*	1/125 or slower
FG-20*	1/90 (M90) or slower
FG*	1/90 (M90) or slower
EM*	1/90 (M90) or slower
F2-series	1/80 (red line located between 1/60 and 1/125) or slower

* These cameras do not have a sync terminal. To use the SB-11, you must first attach the Sensor Remote Cord SC-13. Via the SC-13, the shutter speed is automatically switched to the proper synchronization speed with the camera in any automatic exposure mode.

ACCESSORIES

TTL Remote Cords SC-12 and SC-23

The SC-12 is for the Nikon F3-series cameras; the SC-23 is for the Nikon FA, FE2, F-301/N2000 and FG cameras. Connecting the SB-11 and an appropriate camera with SC-12 or SC-23 provides TTL control of the flash exposure. Automatic switchover of shutter speed to a proper flash sync speed and a ready-light indication in the camera's viewfinder are also provided.

Sensor Remote Cord SC-13

The SC-13 is used to mount the SB-11's Sensor Unit SU-2 directly on a camera's ISO-type accessory shoe for automatic (but not TTL), off-camera operation. With the FA, FE2, FE, FM2, F-301/N2000, FG, FG-20, or EM camera, or with the F3-series camera via the AS-4 coupler, a ready-light indication is provided in the camera's viewfinder. Except for the FM2, the automatic switchover of shutter speed to a proper flash sync speed is also provided.

Sync Cord SC-15

A coiled cord over one meter in length, the SC-15 screws into the camera's sync terminal and allows the SB-11 to be detached from its bracket and used off-camera.

DC Unit SD-7

The Nikon DC Unit SD-7 is an external power source which can be used with the Nikon Speedlights SB-11 and SB-14. This unit uses six C-type batteries of either the

alkaline-manganese or general NiCd type. Alkaline-manganese batteries will produce approximately 270 flashes with the SB-11 and SB-14 on Manual (in normal temperatures). Minimum recycling time with NiCd batteries is approximately 4 seconds with the SB-11 and SB-14.



SC-12

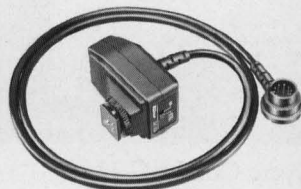

SC-23



SC-13

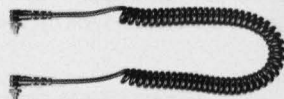

SC-15



SD-7

"RED EYE"

"Red eye" is a phenomenon in flash photography where the center portions of the subject's eyes appear as bright red orbs in color photographs (or white in black and white pictures). This is a result of the light from the flash illuminating the retina directly. If the subject looks straight into the lens and there is little or no ambient light, the pupil is wide open, making the retina clearly visible in the picture.

To avoid "red eye," you can take any or all of the following precautions:

1. Ask the subject not to look directly into the lens when the picture is taken.
2. Remove the flash unit from the camera and hold it as far away as possible from the camera by using a sync cord.
3. Increase the room's overall illumination to reduce the opening of the subject's pupils.

TIPS ON SPEEDLIGHT CARE

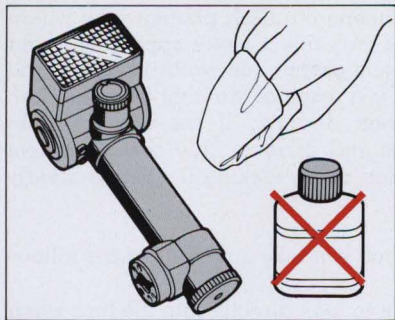

- To remove dirt or fingerprints, wipe with a dry soft or silicon-treated cloth. Never use thinner, benzine or alcohol, since they might damage the plastic parts. To clean the Wide-Flash Adapter, wash it with soap and water. Never use a brush, as this may damage it.

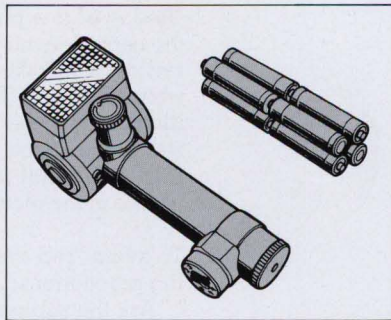

- If you do not plan to use the unit for more than two weeks, remove the batteries to avoid possible damage to the circuitry by battery leakage. If leakage should inadvertently occur, take the flash unit to your nearest Nikon authorized service facility.

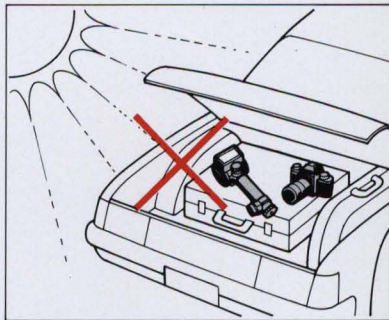

- To prevent damage to the flash unit's electronic circuitry, keep the camera away from places where the temperature is likely to go higher than 50°C, such as inside the trunk of a car in the hot summer sun; also do not store the unit in exceptionally damp places. Use the SB-11 within the range of -10°C ~ +50°C.

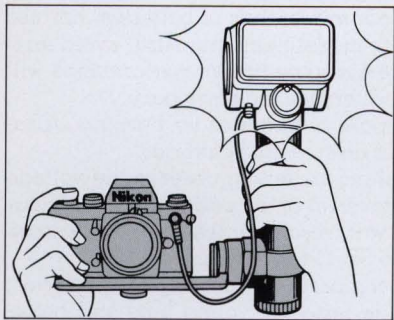

- If your SB-11 has not been used for a long time, its recycling time may be longer. To maintain the built-in condenser in peak condition, thereby enabling you to use the SB-11 for many years, fire the flash unit a few times every month. After firing, wait until the ready-light lights, then turn off the power switch, remove the batteries, and store the SB-11 in a suitable location. This will prevent the condenser from deteriorating.

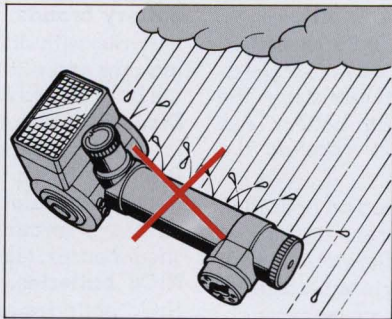

- Keep the flash unit away from salt water and out of the rain.

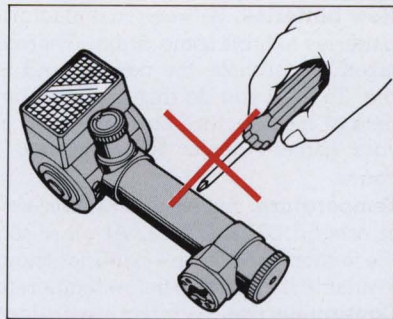

- Never attempt to disassemble or repair the flash yourself. These delicate procedures should be left to an authorized service facility.

OPTIMUM BATTERY PERFORMANCE

New batteries. Between manufacturing and first use, all batteries exhibit some drain. Therefore, care should be taken to purchase the newest (and freshest) ones possible. To help you do this, some manufacturers stamp the date of manufacture on the bottom of each battery. Ask your camera dealer for assistance in interpreting the codes.

Temperature. Battery life ratings are based on operation at around 25°C (77°F). At other temperatures, battery life is shortened. Spare batteries should therefore be kept available if operation in low temperatures is anticipated.

Continuous use. Batteries are drained much more quickly by continuous use than by intermittent use.

Storage. When not in use, the batteries should be removed to prevent damage from leakage. To minimize drain during the period of disuse, store the batteries in a cool, dry place below 20°C (68°F).

Battery brands. Do not mix brands of batteries, nor use batteries with different model numbers. Also, avoid mixing new and old batteries since proper performance will not be obtained and battery leakage may occur.

Disposal. Do not dispose of batteries by burning. Also, for safety's sake, never disassemble batteries.

Polarity. When installing batteries, observe the voltage polarities carefully. Reversal of the positive (+) and negative (-) terminals will result in leakage. If leakage should occur, take the SB-11 to your dealer.

NiCd batteries. In comparison with regular batteries, NiCd batteries provide faster recycling time and better efficiency at low temperatures. However, note that the recycling time and the number of flashes per battery set are dependent on the age of the batteries, how much charge they have, and their capacities.

SPECIFICATIONS

Light output control	Automatic: flash output control with silicon controlled rectifier (thyristor) using Sensor Unit SU-2; Manual: full output	Number of flashes (approx.)	Automatic: variable depending on shooting distance; Manual: 150 with fresh set of alkaline-manganese batteries
Guide number (ASA/ISO 100 and meters)	36 (25 with Wide-Flash Adapter SW-3)	Power source	Eight 1.5V AA-type penlight batteries
(ASA/ISO 25 and feet)	60 (42 with Wide-Flash Adapter SW-3);	Ready-light	Provided; blinks if flash output is at its maximum indicating that light might be insufficient for correct automatic exposure
Angle of coverage	Horizontal: 56° (67° with 'SW-3); Vertical: 40° (48° with SW-3)	Open-flash button Mounting	Provided Bracket-type
Automatic shooting range (at ASA/ISO 100)	0.6—9m (2—30ft) at f/4; 0.6—6.4m (2—21ft) at f/5.6; 0.6—4.5m (2—15 ft) at f/8	Dimensions (approx.)	276mm (H) × 104mm (W) × 118mm (D)
ASA/ISO film speed range	ASA/ISO 25~800	Weight (excluding batteries)	Approx. 860g
Recycling time	Automatic: variable depending on shooting distance; Manual: approx. 8 sec.		



No reproduction in any form of this booklet,
in whole or in part (except for brief quotation in
critical articles or reviews), may be made without
written authorization from Nippon Kogaku K.K.

NIPPON KOGAKU K.K.

Fuji Bldg., 2-3, Marunouchi 3-chome, Chiyoda-ku, Tokyo 100, Japan

Phone: 81-3-214-5311 **Telex:** J22601 (NIKON) **Fax:** 81-3-201-5856

Printed in Japan 8&135-A10