



genteq[®]
ECM SERVICE GUIDE

A Regal Brand

REGAL

©2014 Regal-Beloit Corporation

 **WARNING**

Genteq does not condone the repair of any individual components in the motor control or motor of their ECM products. This practice is unsafe and may cause personal injury, death, or property damage.

 **WARNING**

Working on the motor with power connected may result in electrical shock or other conditions that may cause personal injury, death or property damage.

 **WARNING**

On models 2.0/ 2.3/ 2.5/ Eon/ X13/ 3.0 always disconnect the power from the HVAC system and wait at least 5 minutes before opening the motor, i.e. removing the two bolts from the motor control (end bell) and disconnecting the 3-pin plug to the motor. This is to allow the capacitors to dissipate for safety.

 **WARNING**

Always disconnect the power from the HVAC system before removing or replacing connectors, servicing the motor, removing the high voltage plug, and before reconnecting.

 **WARNING**

Disconnect AC power from the system and make sure the blower wheel or fan blade has come to a complete stop before servicing the motor.

 **WARNING**

Do not operate motor without blower wheel or fan blade attached. Such operation will cause the motor to oscillate up and down.

 **WARNING**

You must have the correct replacement module and/or motor from the manufacturer that is a direct replacement for the failed module and/or motor. **USING THE WRONG MODULE AND/OR MOTOR VOIDS ALL PRODUCT WARRANTIES AND MAY PRODUCE UNEXPECTED RESULTS.**

TABLE OF CONTENTS

About the Company 1

Using the ECM Service Guide

Start Here: 3
Using the ECM Service Guide

HVAC System Troubleshooting Basics 4

Tech Tips 6

Motor Identification Chart 7

Motor Diagnostics & Replacement

Variable Speed Motors 10
Premium ECM Motor Diagnostics

X13 Motor 26
Standard ECM Motor Diagnostics

Evergreen Replacement Motors or Retrofit 37
Retrofit Motor Diagnostics

Outdoor Motors 50
Motor Identification Chart

Final Checks 53

Introduction

The ECM Service Guide provided by Genteq® is a troubleshooting tool like no other. It covers over 20 years worth of OEM (Original Equipment Manufacturer) and aftermarket residential HVAC ECM motors including the Variable Speed indoor blower motor models 2.0, 2.3, Eon, and 3.0, Constant Torque indoor blower motor model X13, Constant Speed outdoor fan motor model 142 and 142R, and the Constant Torque indoor blower motor Evergreen. Genteq motors have been used almost exclusively in OEM equipment including fossil fuel furnaces, electric air handlers, geothermal and package systems. Regardless of the manufacturer of the appliance, this guide will help troubleshoot the Genteq ECM motor driving it. It is our hope that this guide will provide a simple and accurate process for troubleshooting all of our motors.

About the Company

In 1987 General Electric introduced ECM technology to the residential HVAC industry. This technology is predominantly used in variable speed indoor blower motors, constant speed induced draft motors and condensing fan motors. These innovative motors changed the industry by providing unmatched efficiency as well as comfort options not possible with PSC induction motors.

In 2004 the Regal Beloit Corporation acquired General Electric's Commercial and HVACR Motors and Capacitors businesses with the right to use the GE brand through 2009. These divisions were named GE ECM by Regal Beloit, GE Commercial Motors by Regal Beloit and GE Capacitors by Regal Beloit.

In 2009, Regal Beloit announced the rebranding of those GE branded businesses under the name Genteq, for markets that include residential and



commercial HVAC equipment and electrical applications that utilize capacitors. With this rebranding, the Genteq logo took the place of GE ECM, GE Commercial Motors and GE Capacitors logos on all branded products, sales and marketing materials, Web sites, communications documents, signage and other related items.



This rebranding reflects the company's reputation for innovation and speaks to the future. We want to assure customers that this rebranding is an exciting, progressive step. Genteq continues providing unparalleled service and developing the progressive, innovative HVACR solutions for which this company has always been known. Even if you are not familiar with the name Regal Beloit, you are most likely familiar with one or more of the motor brands they own such as Marathon, Lincoln, Leeson and Fasco. Regal Beloit is a leading manufacturer of mechanical and electrical motion control and power generation products serving markets throughout the world. Regal Beloit is headquartered in Beloit, Wis., and has manufacturing, sales, and service facilities throughout the United States, Canada, Mexico, Europe and Asia.



Genteq will continue to create innovative, premium comfort and electrical components. Our proven reputation for high quality, highly reliable products and strong customer relationships make us the preferred brand throughout the industry.

For more information on our company, Please visit our Web site at jointhegeneration.com. For technical information and training on our OEM products please visit theDealerToolbox.com. For information and training on Evergreen visit EvergreenDealer.com. And for information on homeowner benefits and tax rebates please visit genteqcomfort.com.

Using the ECM Service Guide



Read this section before using
Motor Diagnostics & Replacement

START HERE: Using the ECM Service Guide

The purpose of this guide is to help you accurately and efficiently troubleshoot Genteq ECM-driven systems. For ease of troubleshooting and to avoid misdiagnosis, it is strongly recommended that each step of this guide be used in the following order:

1. Begin with the “HVAC System Troubleshooting Basics” section on the opposite page.
2. If the answer to the problem is not solved there, read all of the Tech Tips on page 6.
3. After reading all of the Tech Tips, go to the “Motor ID” section of this guide on page 7 to be sure you use the procedures for the correct motor.
4. After determining which motor you are working on from the “Motor ID” chart on page 7, go to the section in this guide for the motor model you are working on and follow the instructions listed there.



HVAC System Troubleshooting Basics

Before troubleshooting the ECM motor, check these system basics if applicable:



1. Confirm that the correct thermostat input and ONLY the correct input voltage is present at the interface or main control board on the furnace/air handler or outdoor unit. Loose or broken low-voltage wires are also potential problem areas and can cause intermittent problems.

➔ For the heating and/or cooling systems, use the manufacturer's guide to confirm proper demands (heat or cool), especially on multi-stage systems. Use the "Sequence of Operation" charts and the "Thermostat Wiring Diagrams," found in these guides to confirm proper wiring and operation.

2. When checking low-voltage connections, always use the C terminal on the board, never ground.
3. Check the setting of the jumper pins or switches or menu selections on the manufacturer's control board or system interface. Do not assume they are correct; use the manufacturer's guide to select the proper airflow, delays, and profiles. **Always disconnect the main power to the unit when making these adjustments, unless required for interface operation.**

- 
- 
4. Check all terminal/plug connections both at the furnace/air-handler or outdoor unit control board and at the motor. **Always disconnect power to the system before disconnecting and reconnecting plugs.**

Look for:

- ➞ Loose plugs and/or loose pin connections in the plug.
 - ➞ Burnt, bent or loose pins or seats.
5. Confirm there are no limits, rollouts or safeties tripped. Also check for any fault codes present on the furnace/air-handler or outdoor unit control boards.
 - ➞ If fault codes are present, follow the manufacturer's recommendations to resolve the problem.
 6. If these checks do not solve the problem, or if a fault code reveals a motor problem, read the Tech Tips on page 6, and go to the "Motor ID" section on page 7 to identify the motor. Then go to the corresponding motor section in this guide for additional diagnostics.
- 
- 

Tech Tips

TECH TIP #1

Do not automatically assume the ECM motor has failed. Follow this guide completely before replacing it.

TECH TIP #2

When it is necessary to disconnect the power from the HVAC system, it is always good practice to **verify that voltage has been disconnected** with a voltmeter.

TECH TIP #3

A True- RMS meter is not needed to check high voltage or low voltage (communication voltage) to the motor.

TECH TIP #4

Always pull on the connector and not the wires. Most connectors are also keyed. Reconnecting a connector the wrong way could damage the motor.

TECH TIP #5

When checking any plug connector, the meter leads are most likely larger than the terminals or socket. Using thin leads will prevent the terminals from being damaged by voltage checks. Thinner leads are also available in a 90° angle as needed. Go to **thedealertools.com** for part numbers and ordering information if needed.

Motor Identification Chart

OEM Constant Torque Indoor Blower Motor

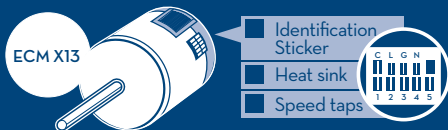

Evergreen Aftermarket Constant Torque Indoor Blower Motor

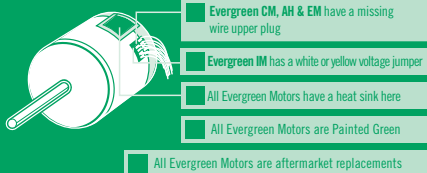

OEM Constant Speed Outdoor Fan Motor

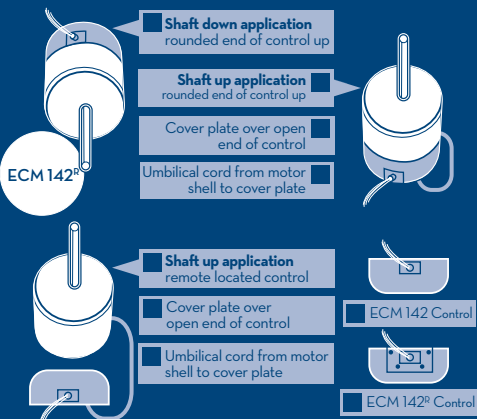

Motor Identification Chart

OEM Variable Speed Indoor Blower Motor

ECM 3.0
& Eon



- Eon uses 16-pin connector
- Identification Sticker
- Heat sink
- 3.0 uses 4-pin connector



ECM
2.3/2.5



2.3
≥ 6
wires



2.5
≤ 5
wires



- Identification Sticker

NOTE: Early models do not have identification stickers.

- Painted, steel motor control

- 2.3 - 6 or more wires in the 16-pin connector
- 2.5 - 5 or less wires in the 16-pin connector

ECM 2.0



- Unpainted, cast aluminum motor control

NOTE: ECM 1.0, 2.0, 2.3 & 2.5 motors are no longer in production

ECM 1.0



- Square motor control

NOTE: See HVAC manufacturer's service guide for 1.0 motor diagnostics.

MOTOR ID

 **WARNING**

Genteq does not condone the repair of any individual components in the motor control or motor of their ECM products. This practice is unsafe and may cause personal injury, death, or property damage.

 **WARNING**

Working on the motor with power connected may result in electrical shock or other conditions that may cause personal injury, death or property damage.

 **WARNING**

On models 2.0/ 2.3/ 2.5/ Eon/ 3.0 always disconnect the power from the HVAC system and wait at least 5 minutes before opening the motor, i.e. removing the two bolts from the motor control (end bell) and disconnecting the 3-pin plug to the motor. This is to allow the capacitors to dissipate for safety.

 **WARNING**

Always disconnect the power from the HVAC system before removing or replacing connectors, servicing the motor, removing the high voltage plug, and before reconnecting.

 **WARNING**

Disconnect AC power from the system and make sure the blower wheel or fan blade has come to a complete stop before servicing the motor.

 **WARNING**

Do not operate motor without blower wheel or fan blade attached. Such operation will cause the motor to oscillate up and down.

 **WARNING**

You must have the correct replacement module and/or motor from the HVAC unit manufacturer that is a direct replacement for the failed module and/or motor. **USING THE WRONG MODULE AND/OR MOTOR VOIDS ALL PRODUCT WARRANTIES AND MAY PRODUCE UNEXPECTED RESULTS.**

Variable Speed Models 2.0 / 2.3 / 2.5 / Eon / 3.0 Premium ECM Motors

See the Motor ID Chart on page 8 if needed.

Models 2.0 / 2.3 / 2.5 / Eon / 3.0

Premium ECM Motor Diagnostics 11

TECINspect

TECINspect Usage Chart 15

Troubleshooting with the TECINspect 16

Module Replacement

ECM Control Module 19

ECM Motor Module 24

Models 2.0 / 2.3 / 2.5 / Eon / 3.0

Premium ECM Motor Diagnostics

IF THE MOTOR IS RUNNING

- 1. It is normal for the motor to rock back and forth on start up. Do not replace the motor if this is the only symptom identified.**
2. If the system is excessively noisy, does not appear to change speeds in response to a demand (Heat or Cool), or is having symptoms during the cycle such as a tripping limit or freezing coil, check the following:
 - ➔ Wait for programmed delays to time out. If delays are too long, then reset them using the manufacturer's charts.
 - ➔ Ensure the airflow settings are correct for the installed system using the manufacturer's charts. Remember that the change in airflow between continuous-fan speed and low stages of operation may be very slight depending on the size of the system. If the system is operating normally in each stage, then there is no problem.
 - ➔ Remove the filter and check that all of the dampers, registers, and grills are open and free flowing. If removing the filter corrects the problem, clean or replace with a less restrictive filter. Also check and clean as needed the blower wheel, secondary heat exchanger (if applicable) and evaporator coil (if applicable).

If this does not correct the problem then:

- ➔ Check the external static pressure. If it is higher than the manufacturer's recommendations, correct the airflow restriction.

- 
3. If the motor does not shut off at the end of the cycle, check the delay times and wait for the delays to time out. Also, make sure that there is no call for “Continuous fan” on the “G” terminal. This motor may take a while to come to a complete stop with selected delays and the normal ramp down.
 4. **If the 2.0 / 2.3 / Eon / 3.0 motor** has proper high voltage and ground at the 5-pin connector, go to the “Troubleshooting with the TECINspect” section on page 16. If the 2.5 motor has proper high voltage and ground at the 5-pin connector, the equipment manufacturer’s checks, located in their service manuals, must be referenced. This guide cannot troubleshoot the communication to the 2.5 motor. The TECINspect is not designed for use on the 2.5 motor.



➡ Checking the high voltage on the 5-pin connector is outlined in step 1 on page 13.



IF THE MOTOR IS NOT RUNNING

1. Check for proper high voltage and ground at the 5-pin connector at the motor. Correct any voltage issues before proceeding to the next step. These are dual voltage motors capable of operating in 120 or 240VAC systems. On 120VAC systems there should be a jumper between terminals 1 and 2 (see Figure 1). On 240VAC systems the jumper should be removed (see Figure 2). If a motor is operating at 240VAC with the jumper in place, the motor will be permanently damaged. Input voltage within plus or minus 10% of the nominal 120VAC or 240VAC is acceptable.
2. If the 2.0 / 2.3 / Eon / 3.0 motor has proper high voltage and ground at the 5-pin connector, go to the “Troubleshooting with the TECINspect” section on page 16. If the 2.5 motor has proper high voltage and ground at the 5-pin connector, the equipment manufacturer’s checks, located in their service manuals, must be referenced. This guide cannot troubleshoot the communication to the 2.5 motor.
The TECINspect is not designed for use on the 2.5 motor.
3. If further troubleshooting identifies a failed control module, go to “Replacing the ECM Control Module” section on page 24 of this guide for replacement steps.

Figure 1

Models 2.0 / 2.3 / 2.5 / Eon / 3.0

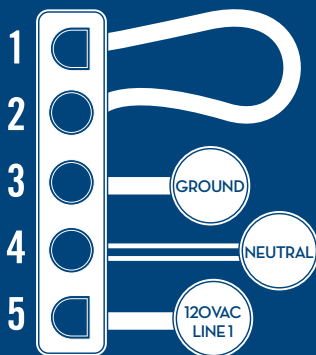

120VAC SYSTEM

⚠ WARNING

Always disconnect the power from the system before removing the high voltage plug, and before reconnecting.

Figure 2

Models 2.0 / 2.3 / 2.5 / Eon / 3.0

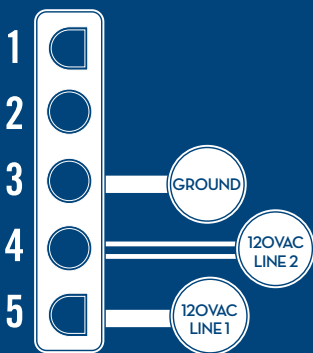

240VAC SYSTEM

TECINspect USAGE CHART

In 2013 the TECMate Pro service tool was rebranded to TECINspect.

TECINspect Service Tool Generational Growth



TECMate XL	TECMate PRO	TECINspect
4 Switches	1 Switch	1 Switch
16-pin connector	<p>1st Generation 16-pin connector</p> <p>2nd Generation 16-pin connector with supplied 16-4 pin adapter</p> <p>3rd Generation 16 & 4 pin connector harness</p>	<p>16&4 pin connector harness</p> <p>No change from TECMate PRO 3rd generation</p>
Out of Production	Out of Production	Current Model

TECINspect Application Chart

These service tools will properly diagnose applicable Genteq indoor blower motors in all HVAC OEM equipment.

TECMate XL	TECMate PRO	TECINspect
Applicable Motors 2.0, 2.3, EON, 3.0		
Model 3.0 diagnostics require a 16-4 pin adaptor ^{1,2}	Model 3.0 diagnostics may require a 16-4 pin adaptor ¹	

The TECINspect service tools are not designed for use on Genteq models 1.0, 2.5, X13 or Evergreen. The TECINspect service tools are not designed for use on Genteq outdoor fan motors.

¹The 16-4 pin adaptor can be ordered from thedealertools.com

²The TECMate XL may not accurately troubleshoot Carrier/Bryant 2.0/2.3 models.

Troubleshooting with the TECINspect (Models 2.0 / 2.3 / Eon / 3.0 only)

See Motor ID Chart on page 8, if needed.

See the Usage Chart on the opposite page for motors applicable to the TECINspect.

The TECINspect is capable of identifying a motor control failure versus another HVAC system controller or wiring failures.

⚠ WARNING

Disconnect AC power from the system and make sure the blower wheel has come to a complete stop before servicing the motor.

⚠ WARNING

Do not operate motor without blower wheel attached. Such operation will cause the motor to oscillate up and down.

1. Connect the TECINspect to the communication plug on the motor

➡ On Models 2.0/2.3/Eon remove the 5-pin AC power connector first to make accessing the 16-pin communication connector locking tab easier. Remove the 16-pin connector from the motor, and connect the 16-pin connector from the TECINspect to the motor. **Reconnect the 5-pin AC power connector.**

➡ On Model 3.0 remove the 4-pin connector from the motor (do not remove the 5-pin AC power connector). Connect the 4-pin connector from the TECINspect to the motor. Use the 16-4 pin adaptor (p15) with early model TECMate tools.

(see below).

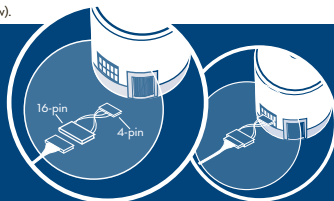

Connect the two alligator clips from the TECINspect to a constant 24VAC (**24VAC terminal and Common terminal**) source such as the transformer low-voltage terminals or terminal strip on the manufacturer's control board (see Figure 3 below). These connections are not polarity sensitive.

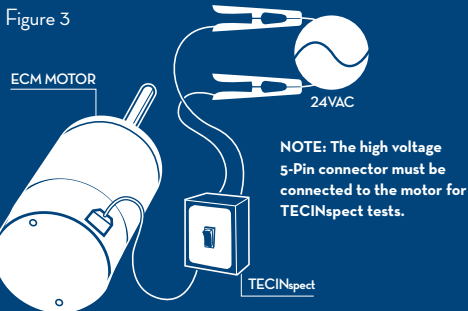

2. Place the TECINspect switch(es) in the OFF position.
3. Reconnect the AC power to the system. The green LED light on the TECINspect should be on when connected properly to 24VAC. If the green LED light is not on, there is no power to the TECINspect or the TECINspect has failed. Do not continue until the green LED is on by correcting low voltage issue/connections or replacing the TECINspect.
4. **Refer to the table on the back of the TECINspect for operation guidelines.** Observe the motor for a minimum of 15 seconds.

➡ **If using a TECMate XL on Models**

2.0/2.3/Eon, make sure to set the switches according to the instructions on the back for each demand test to eliminate misdiagnosing the problem.

➔ **If using a TECMate XL on Model 3.0**, the only switch necessary to test the motor is the furthest switch to the right (labeled BK/PWM on the XL or DH on the Troubleshooter).

5. When testing is finished, place the TECINspect switch(es) in the OFF position and wait for the motor to completely stop. (Based on the manufacturer's program, the motor may not shut off immediately after a test; this is normal).

➔ **If the motor operates using TECINspect, both the control module and the motor module are ok.** The motor may operate at a reduced speed during the TECINspect test, this is normal. Turn off the power to the unit, remove the 16-pin or 4-pin communication harness from both the motor and the manufacturer's control board. Perform a continuity check on each individual wire of the harness. Some manufacturers use a different style connector on the control board side of the harness. Follow the wires to be sure of checking the proper pins. Replace the communication harness if any wires fail the continuity check, if any of the pins are bent beyond repair or damaged and check the system operation again. If the harness is good or a new harness does not solve the problem, troubleshoot the communication out of the manufacturer's control board with their troubleshooting guide. Always troubleshoot the communication at the motor end of the harness.

➔ **If the motor does not operate with the TECINspect**, confirm high voltage (pages 13-14) is present before replacing the control module. Follow the next section on "Replacing the ECM Control Module" on page 19.

Replacing the ECM Control Module (Models 2.0/ 2.3/ 2.5/ Eon/ 3.0 Only)

Before replacing the electronic-control module, you must test the motor module to ensure it is not also damaged. Installing a new control on a failed motor will result in no operation, improper operation and/or potential failure of the new control. Procedures for testing the motor module are included below.

WARNING

Disconnect AC power from the system and make sure the blower wheel has come to a complete stop before servicing the motor.

WARNING

You must have the correct replacement module and/or motor from the manufacturer that is a direct replacement for the failed module and/or motor. **USING THE WRONG MODULE AND/OR MOTOR VOIDS ALL PRODUCT WARRANTIES AND MAY PRODUCE UNEXPECTED RESULTS.**

1. Disconnect AC power from the HVAC system. Unplug the 16-pin or 4-pin communication connector and the 5-pin connector from the motor control.
2. Remove the blower assembly from the HVAC system if needed.
3. **ONLY after the system AC power has been off for 5 minutes**, remove the two (2) hex-head screws from the back of the control.
4. Unplug the 3-pin connector from the inside of the control by squeezing the latch and gently pulling on the connector (see Figure 4 on the next page). Now you're ready to test the motor.

Figure 4

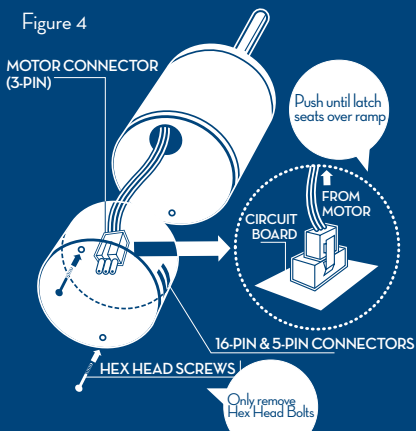

MOTOR MODULE TESTS

A. The Winding Test (see Figure 5)

Set ohm meter to the highest possible setting and measure resistance between each of the three motor leads to the unpainted part of the end shield (or x-brace on model Eon & 3.0). The motor passes the test if the meter indicates greater than 100k ohms.

WINDING TEST

Figure 5

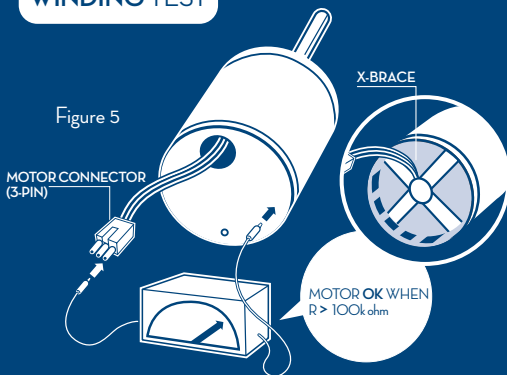

B. The Phase-to-Phase Test (see Figure 6 below)

Set ohm meter to lowest possible setting and measure the motor phase to phase resistance by checking these combinations of the 3-pin motor connector with an ohm meter:

- Lead 1 to lead 2
- Lead 1 to lead 3
- Lead 2 to lead 3

For the purpose of this test, either end of the 3-pin plug is lead 1. Resistance values should be less than 20 ohms and each of the three values should be the same (plus or minus 10%). If the measured resistance is outside of these parameters, the motor fails the test.

PHASE-TO-PHASE TEST

Figure 6

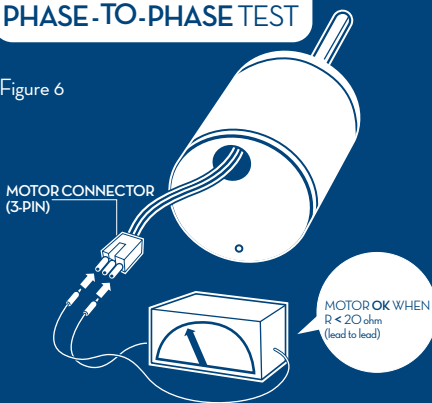

C. If the motor passes both of these tests and the shaft spins freely when rotated by hand, then the motor is ok and only the control must be replaced. Continue with replacing the ECM control module in step 5.

D. If the motor fails either of these tests or does not spin freely when rotated by hand, replace the motor and control module following the guidelines on page 24.

5. Insert the 3-pin connector back into the new control module. A slight click will be heard when inserted properly. This connector is keyed for proper connection.
6. Attach the new control module with the plug connections oriented down (see figure 7, page 23), insert the appropriate bolts and tighten. Due to model replacements, some motors may need to be rotated in their mount to orient the plug connectors properly. See below for model specific notes and/or follow any OEM instructions included with the new control.

➡ Model 2.0 & 2.3 - These models are no longer available and can only be replaced with an OEM Eon kit that includes a motor adapter ring (see below).

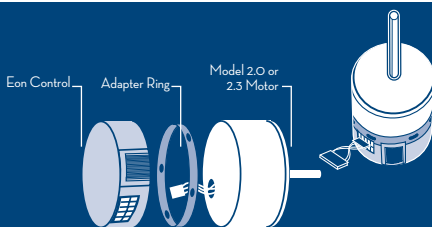

➡ Model Eon - This model can only be replaced with with an OEM Eon.

➡ Model 2.5 - This model is no longer in production. It can only be replaced with an OEM 3.0 kit that includes a 16-4 pin wiring adapter and a motor adapter ring.

➔ Model 3.0 - This model can only be replaced with an OEM 3.0.

7. Reinstall the blower/motor assembly into the HVAC system by following the manufacturer's guidelines.
8. Plug the 16-pin or 4-pin communication connector and the 5-pin connector back into the motor. The connectors are keyed. Observe proper orientation.
9. Be certain to form a drip loop so that water cannot enter the motor by draining down the cables (see Figure 7 below).
10. Go to the "Final Installation Checks" on pages 53-54.

Figure 7

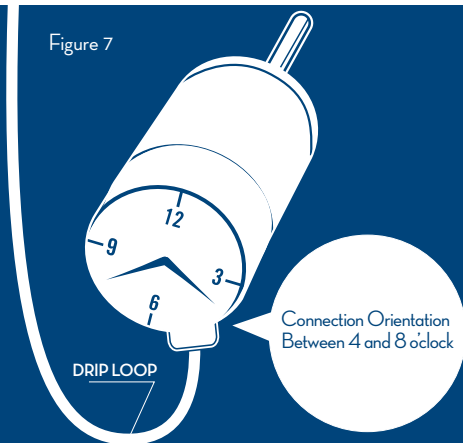

Replacing the ECM Motor and Control Modules (Models 2.0 / 2.3 / 2.5 / Eon / 3.0)

1. The most efficient way to install the motor is to have the control already attached.
 - ➡ If the new motor and control are not already bolted together use the OEM instructions or steps 5 and 6 on page 22.
2. Make sure the belly band mount is on the motor module only and is not covering any of the motor shell holes. Typically the belly band is located between the two sets of motor shell holes.
3. Before tightening down the belly band, rotate the motor until the connectors in the control are facing down or at least between the 4 and 8 o'clock position in the blower housing, as it will mount into the HVAC system (see figure 7 page 23).
4. Center the blower wheel in the blower housing and tighten the blower wheel hub bolt on the flat portion of the motor shaft.
5. Reinstall the blower/motor assembly into the HVAC system by following the manufacturer's guidelines.
6. Plug the 16-pin or 4-pin communication connector and the 5-pin connector back into the motor. The connectors are keyed. Observe proper orientation.
7. Be certain to form a drip loop so that water cannot enter the motor by draining down the cables (see figure 7 page 23).
8. Go to the "Final Installation Checks" on pages 53-54.

 **WARNING**

Genteq does not condone the repair of any individual components in the motor control or motor of their ECM products. This practice is unsafe and may cause personal injury, death, or property damage.

 **WARNING**

Working on the motor with power connected may result in electrical shock or other conditions that may cause personal injury, death or property damage.

 **WARNING**

Always disconnect the power from the HVAC system and wait at least 5 minutes before opening the motor, i.e. removing the two bolts from the motor control (end bell) and disconnecting the 3-pin plug to the motor. This is to allow the capacitors to dissipate for safety.

 **WARNING**

Always disconnect the power from the HVAC system before removing or replacing connectors, servicing the motor, removing the high voltage plug, and before reconnecting.

 **WARNING**

Disconnect AC power from the system and make sure the blower wheel has come to a complete stop before servicing the motor.

 **WARNING**

Do not operate motor without blower wheel attached. Such operation will cause the motor to oscillate up and down.

 **WARNING**

You must have the correct replacement motor from the manufacturer that is a direct replacement for the failed motor. **USING THE WRONG MOTOR VOIDS ALL PRODUCT WARRANTIES AND MAY PRODUCE UNEXPECTED RESULTS.**

Model X13

Standard ECM Motor Diagnostics

See the Motor ID Chart on page 7 if needed.

IF THE MOTOR IS RUNNING

- 1. It is normal for the motor to rock back and forth on start up. Do not replace the motor if this is the only problem identified.**
2. If the system is excessively noisy, does not appear to change speeds in response to a demand (Heat or Cool), or is having symptoms during the cycle such as a tripping limit or freezing coil, check the following:
 - ➔ Wait for programmed delays to time out. If delays are too long, reset them using the manufacturer's charts.
 - ➔ Ensure the airflow settings are correct for the installed system using the manufacturer's charts. If the system is operating normally in each mode, there is no problem.
 - ➔ Remove the filter and check that all of the dampers, registers, and grills are open and free flowing. If removing the filter corrects the problem, clean or replace with a less restrictive filter. Also check and clean as needed the blower wheel, secondary heat exchanger (if applicable) and evaporator coil (if applicable).

If this does not correct the problem then:

- ➔ Check the external static pressure. If it is higher than the manufacturer's recommendations, correct the airflow restriction.

3. If the motor does not shut off at the end of the cycle, check the delay times and wait for the delays to time out. Also make sure that there is no call for “Continuous fan” on the “G” terminal. This motor may take a while to come to a complete stop with selected delays.
4. If the above diagnostics do not solve the problem, confirm the voltage checks in the next section below, then continue diagnostics in the section, “Model X13 Standard ECM Motor Communication Diagnostics.” The TECINspect is not designed for use on this motor.

WARNING

Always disconnect the power from the system before removing the high voltage plug, and before reconnecting.

IF THE MOTOR IS NOT RUNNING

1. Check for proper high voltage and ground at the (L)(G)(N) connections at the motor (see Figure 8 on the next page). Correct any voltage issues before proceeding to the next step. The X13 motor is voltage specific. Only the correct voltage should be applied to the proper motor. Input voltage within plus or minus 10% of the nominal 115VAC, 230VAC, 277VAC or 460VAC is acceptable.
2. The TECINspect is not needed for use on this motor. If the motor has proper high voltage and ground at the (L)(G)(N) connections, continue diagnostics in the next section, “Model X13 Standard ECM Motor Communication Diagnostics.”

Figure 8

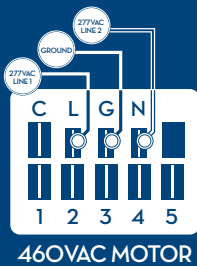
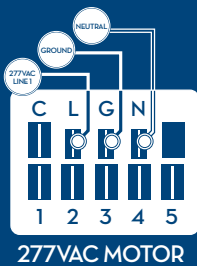

Model X13 Standard ECM Motor Communication Diagnostics

The X13 motor can be communicated through AC or DC low voltage. AC voltage is typically 24VAC and DC voltage can be between 9-23VDC (see Figures 9 and 10 on the next page).

1. Start with the manufacturer's literature to confirm proper set-up, connections and voltage. It is not required that all terminals on the motor have a program. If the low-voltage communication is applied to an unprogrammed terminal, the motor will not operate, which is normal.
2. Initiate a demand from the thermostat and check the voltage between the common and the appropriate motor terminal 1- 5. Confirm the meter is set to the voltage identified from the manufacturer's literature (see Figures 9 and 10 on the next page).

➡ If the low voltage communication is not present, check the demand from the thermostat. Also check the output terminal and wire(s) from the manufacturer's control board or relays to the motor.

➡ If the motor has proper high voltage as identified in the previous section, and proper low voltage to a programmed terminal, and is not operating, follow the next section on "Replacing the ECM Control Module" on page 31.

Figure 9

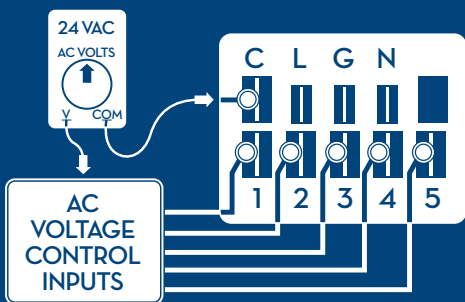
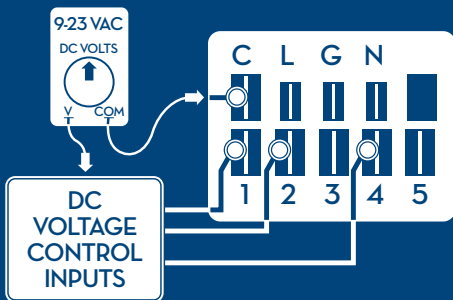

Figure 10



Replacing the ECM Control Module (Model X13)

Before replacing the electronic-control module, you must test the motor module to ensure it is not also damaged. Installing a new control on a failed motor will result in no operation, improper operation and/or potential failure of the new control. Procedures for testing the motor module are included below.

WARNING

Disconnect AC power from the system and make sure the blower wheel has come to a complete stop before servicing the motor.

WARNING

You must have the correct replacement module and/or motor from the manufacturer that is a direct replacement for the failed module and/or motor. **USING THE WRONG MODULE AND/OR MOTOR VOIDS ALL PRODUCT WARRANTIES AND MAY PRODUCE UNEXPECTED RESULTS.**

1. Disconnect AC power from the HVAC system. Unplug all wires and/or connectors. Note tap position of all individual wires from the motor control.
2. Remove the blower assembly from the HVAC system if needed.
3. **ONLY after the system AC power has been off for 5 minutes**, remove the two (2) hex-head screws from the back of the control.
4. Unplug the 3-pin connector from the inside of the control by squeezing the latch and gently pulling on the connector (see Figure 11 on the next page). Now you're ready to test the motor.

Figure 11

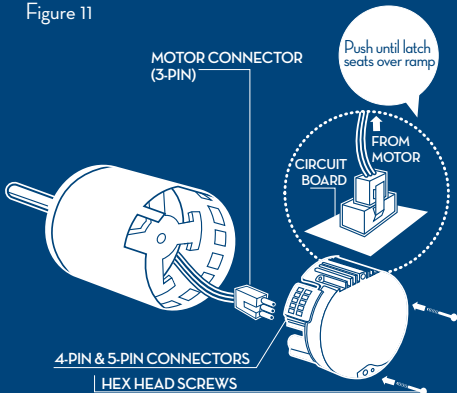

MOTOR MODULE TESTS

A. The Winding Test (see Figure 12)

Set ohm meter to the highest possible setting and measure resistance between each of the three motor leads to the unpainted part of the x-brace. The motor passes the test if the meter indicates greater than 100k ohms.

WINDING TEST

Figure 12

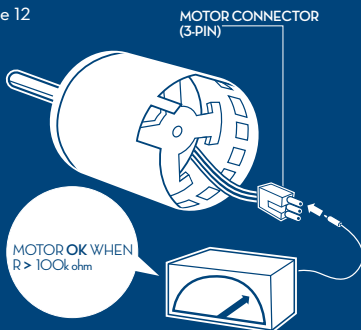

B. The Phase-to-Phase Test (see Figure 13 below)

Set ohm meter to lowest possible setting and measure the motor phase to phase resistance by checking these combinations of the 3-pin motor connector with an ohm meter:

- Lead 1 to lead 2
- Lead 1 to lead 3
- Lead 2 to lead 3

For the purpose of this test, either end of the 3-pin plug is lead 1. Resistance values should be less than 20 ohms and each of the three values should be the same (plus or minus 10%). If the measured resistance is outside of these parameters, the motor fails the test.

PHASE-TO-PHASE TEST

Figure 13

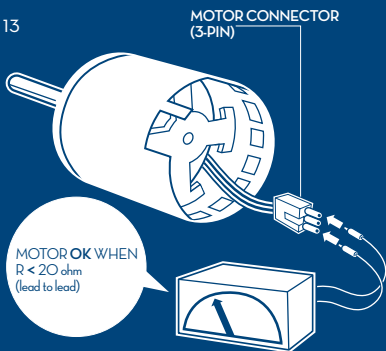

C. If the motor passes both of these tests and the shaft spins freely when rotated by hand, then the motor is ok and only the control must be replaced. Continue with replacing the ECM control module in step 5.



- 
- D. If the motor fails either of these tests or does not spin freely when rotated by hand**, replace the motor and control modules following the guidelines on page 36.
5. Insert the 3-pin connector back into the new control module. A slight click will be heard when inserted properly. This connector is keyed for proper connection.
 6. Attach the new control module with the plug connections oriented down (see figure 14, page 35), insert the appropriate bolts and tighten.
 7. Reinstall the blower/motor assembly into the HVAC system by following the manufacturer's guidelines.
 8. Reconnect all wires and/or connectors. Make sure individual wires are connected to proper taps.
 9. Be certain to form a drip loop so that water cannot enter the motor by draining down the cables (see Figure 14 below).
 10. Go to the "Final Installation Checks" on pages 53-54.
- 
- 

Figure 14

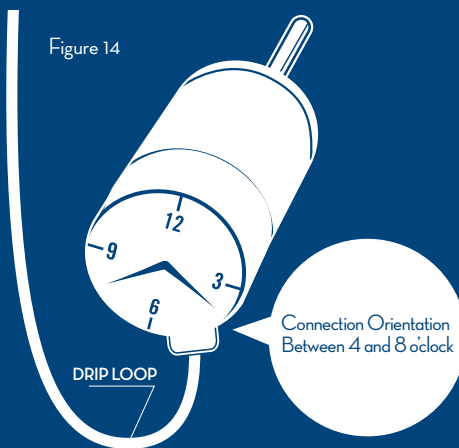

Figure 15



Replacing the ECM Motor and Control Modules (Model X13)

1. The most efficient way to install the motor is to have the control already attached.
 - ➡ If the new motor and control are not already bolted together use the OEM instructions or steps 5 and 6 on page 34.
2. When replacing the X13 motor with a belly band for mounting, the band should not be located in the area identified in Figure 15.
3. Before tightening down the belly band, rotate the motor until the connectors in the control are facing down or at least between the 4 and 8 o'clock position in the blower housing, as it will mount into the HVAC system (see figure 14 page 35).
4. Center the blower wheel in the blower housing and tighten the blower wheel hub bolt on the flat portion of the motor shaft.
5. Reinstall the blower/motor assembly into the HVAC system by following the manufacturer's guidelines.
6. Reconnect all wires and/or connectors. Make sure individual wires are connected to proper taps.
7. Be certain to form a drip loop so that water cannot enter the motor by draining down the cables (see figure 14 page 35).
8. Go to the "Final Installation Checks" on pages 53-54.

Evergreen

Indoor Blower Motor Diagnostics

See the Motor ID Chart on page 7 if needed.

Introduction:

Evergreen is an ECM designed as an aftermarket replacement of existing PSC (Permanent Split Capacitor), direct drive, indoor blower motors for the purpose of increasing efficiency and comfort. For more information on this motor please visit www.thedealertools.com. There you will also find the complete installation manual, training videos and other valuable information.

Evergreen motors are not approved to replace existing ECM Variable Speed or X13 motors, should not be used on twinned systems and should not be used on belt drive systems.

There are two Evergreen Models. Please make sure to use the appropriate troubleshooting information. See the Motor ID chart on page 7 if needed.

Evergreen IM (page 38)

This motor is dual voltage 120-240VAC, reversible, multi-horsepower, and designed for all residential HVAC systems less than 5 ton of cooling and 150k BTU_h of heating.

Evergreen AH (page 45)

This motor is 208-230VAC only, non reversible, and designed for any air handler application including package systems that do not incorporate fossil fuel.

Evergreen • IM Diagnostics

Note: Please read the introduction on page 37 before using these diagnostics

⚠ WARNING

ALWAYS DISCONNECT MAIN HVAC SYSTEM POWER BEFORE DISCONNECTING OR RE-CONNECTING ANY WIRES OR CONNECTORS TO THE EVERGREEN MOTOR.

IMPORTANT NOTE:

There must be proper voltage at the **High Voltage POWER** and **High Voltage SIGNAL** connections for the motor to operate. Skipping any of the troubleshooting in this section could result in misdiagnosis of the motor and/or HVAC system.

IF THE MOTOR IS NOT RUNNING

Check that the proper Line Voltage jumper is installed.

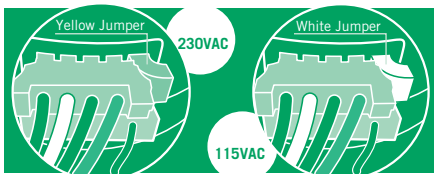

For 230VAC systems the yellow jumper should be installed. For 115VAC systems the white jumper should be installed. **NOTE: If the motor was powered with 230VAC while the white jumper was installed, the motor may be permanently damaged and need to be replaced.** Continue troubleshooting here after proper jumper is installed.

IF THE MOTOR IS NOT RUNNING

(continued)

Confirm proper system line voltage is connected. Measure the voltage at the **High Voltage POWER** connections L1 (black) and L2 (white). On 115VAC systems, Neutral should be connected to L2. The power connected to these taps should be continuous un-switched line voltage. **This voltage alone will not operate the motor.** If proper voltage is not present, troubleshoot the HVAC system. Continue troubleshooting here after proper voltage has been confirmed.

Confirm there is a 115VAC demand on any one or all of the **High Voltage SIGNAL** connections. The High Voltage SIGNAL connections of the motor should only be connected to the HVAC Systems 115VAC fan controls (fan relay or circuit board) connections.

➡ On 230VAC systems, the voltage switched by the fan controls must be the same line voltage that is connected to the L1 High Voltage POWER connection.

➡ If 115VAC L1 and Neutral or 230VAC L1 and L2 was powered to these connections, the motor may be permanently damaged and need to be replaced.

If proper voltage is not present, troubleshoot the HVAC System.

IF THE MOTOR IS NOT RUNNING

(continued)

Final Diagnosis – If there is a 115VAC demand on one or more of the High Voltage SIGNAL connections, the correct Line Voltage Jumper is installed, there is proper voltage on the High Voltage POWER connections and the motor is not operating, replace the motor.

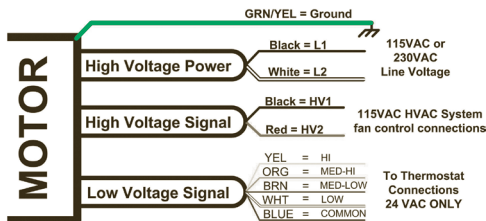

Sequence of Operation

A **Low Voltage SIGNAL** demand from the HVAC Systems thermostat connection alone will not operate the motor. The motor will turn on when it receives its **High Voltage SIGNAL** demand from the HVAC Systems fan controls (fan relay or circuit board) connections. The **High Voltage POWER** connections must be powered continuously from the proper line voltage. Constant fan operation does not require a Low Voltage SIGNAL demand. The special low constant fan speed will operate with a High Voltage SIGNAL demand alone.

IF THE MOTOR IS RUNNING

If the motor is running but there is an airflow issue causing improper performance, undesired comfort or HVAC System failure, check the following:

Confirm the proper HVAC System 24VAC thermostat demand is connected to a **Low Voltage SIGNAL** (speed) tap. **Any voltage above 30VAC could permanently damage the motor.**

This voltage alone will not operate the motor (See the Sequence of Operation section on page 40). Confirm there is proper 24VAC between the selected Low Voltage SIGNAL (speed) tap and the BLUE Common tap on the motor. (see schematic on page 40) If more or less airflow is required, change this connection to a higher or lower speed tap. If the highest or lowest speed tap does not achieve the required airflow, the horse power (Hp) selection may need to be adjusted. If proper 24VAC is not present, troubleshoot the HVAC System. Continue troubleshooting here if this does not solve the problem.

CAUTION:

Adjusting the Horse Power (Hp) selection will change the airflow value of all Low Voltage SIGNAL (speed) taps. If the Hp selection is changed, airflow in all demands will need to be checked and adjusted as needed.

IF THE MOTOR IS RUNNING

(continued)

To achieve the proper horse power (Hp) the **High Voltage SIGNAL** connections must be connected to the HVAC Systems fan controls according to the diagrams on page 43. When the motor was installed it should have been configured to match the Hp of the replaced motor. To increase or decrease the Hp selection, see the chart below.

1/2 Hp Motor	—	HV1 & HV2 = 1/2 - 1/3 Hp operation
		HV1 = 1/3 - 1/4 Hp operation
		HV2 = 1/4 - 1/5 Hp operation
1 Hp Motor	—	HV1 & HV2 = 3/4 Hp operation
		HV1 = 3/4 - 1/2 Hp operation
		HV2 = 1/2 Hp operation

If the highest or lowest Hp setting does not achieve the required airflow, the motor size may be incorrect. This motor is designed to replace multiple motors based on Hp and system sizing. If the sizing of the motor is in question, see the selection chart below.

1/5 - 1/2 Hp	—	}	1/2 Hp Evergreen IM
1.5 - 3 Ton	—		
40 - 100k BTUH	—		
1/2 - 3/4 Hp	—	}	1 Hp Evergreen IM
3.5 - 5 Ton	—		
110 - 150k BTUH	—		

IF THE MOTOR IS RUNNING

(continued)

The **High Voltage SIGNAL** connections are connected together with all the 115VAC fan outputs from the HVAC Systems controls to communicate to the motor when to turn on and at what horse power to operate at.

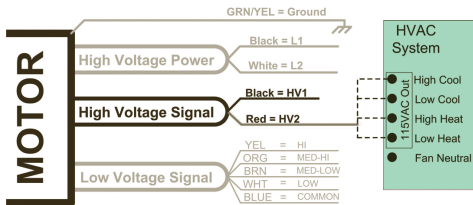
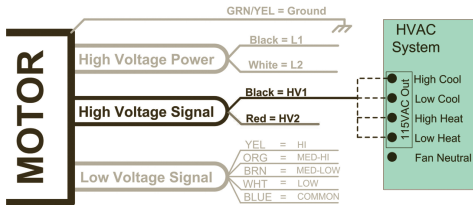
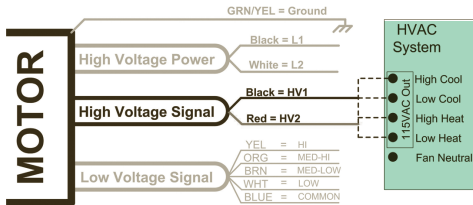

IF THE MOTOR IS RUNNING

(continued)

Airflow restrictions can be caused by any one or more of the following:

- Dirty filters
- Dirty blower wheel, secondary heat exchanger and/or evaporator
- Too many registers, grilles and/or balancing dampers are closed.
- Dirty, damaged, or poorly constructed ductwork.

All of these issues can be solved by visual inspection and cleaning. If this does not solve the problem check the Total External Static Pressure (TESP). If the TESP is above .8, there is an issue with the ductwork or filter sizing that must be corrected. After correcting one or more airflow restrictions, it may be necessary to adjust the speed selection and/or horse power selection.

If the diagnostics provided here do not solve your problem, please go to thedealertools.com and download the full installation manual for further support.

Technical Support is also available on the **Evergreen Hotline at 1-866-503-8566.**

Evergreen • AH Diagnostics

Note: Please read the introduction on page 37 before using these diagnostics

⚠ WARNING

ALWAYS DISCONNECT MAIN HVAC SYSTEM POWER BEFORE DISCONNECTING OR RE-CONNECTING ANY WIRES OR CONNECTORS TO THE EVERGREEN MOTOR.

IMPORTANT NOTE:

There must be proper voltage at the **High Voltage POWER** and the **Low Voltage (Speed Tap)** connections for the motor to operate. Skipping any of the troubleshooting in this section could result in misdiagnosis of the motor and/or HVAC system.

Evergreen • AH Selection Data

Check the HVAC systems existing PSC motor horse power (Hp) and tonnage of the outdoor unit to determine the Evergreen sizing. If only one checkmark falls in each Evergreen sizing use the larger motor.

1/6 - 1/2 Hp _____
1.5 - 3 Ton _____ 1/2 Hp Evergreen IM

1/2 - 3/4 Hp _____
3.5 - 5 Ton _____ 1 Hp Evergreen IM

IF THE MOTOR IS NOT RUNNING

Step 1. Confirm 208-240 VAC between the two black leads of the motor.

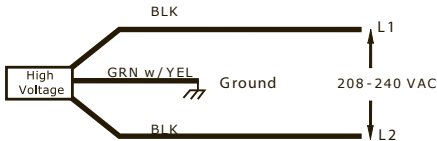

If there is not proper voltage at these leads, correct the problem before the motor. If the motor still does not operate after this step has been corrected, go to **Step 2**.

If there is proper voltage at these leads, go to **Step 2**.

Step 2. Confirm 24 VAC between any one of the speed taps (Green, Orange, Brown, White or Yellow) and the Blue lead (24 VAC common connection)

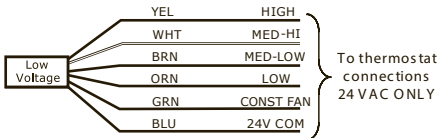

If there is not proper voltage at one or all of these leads during proper system demand, correct the problem before the motor. The motor should operate with 24 VAC supplied to any of its speed taps, with proper 24 VAC common supplied to the blue lead of the motor. If the motor still does not operate after this has been corrected, replace the motor.

IF THE MOTOR IS RUNNING

If the motor is running but there is an airflow issue causing improper performance, undesired comfort or HVAC System failure, check the following:

Step 1. Check all of the airside components such as registers, diffusers, grilles, filters, blower wheel, and indoor coil for dirt or other restrictions. Check filter sizing, especially aftermarket filters.

Clean any dirt or debris on the airside components. Open and clear all registers, diffusers and grilles. Replace filters with proper size according to manufacturer specs. Aftermarket filters may need to be larger than the original specs. If this does not correct the problem go to step 2.

Step 2. Confirm that the proper speed tap has been selected for the proper demand by checking the airflow using one of the methods covered in the “Airflow Tests” section of the Evergreen AH manual. This manual can be downloaded from thedealertools.com.

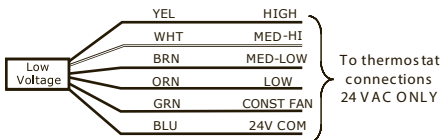

If the airflow needs to be increased or decreased, select the speed tap that produces the proper airflow for the system tonnage.

IF THE MOTOR IS RUNNING

(continued)

If the LOW speed is too much airflow or HIGH speed is not enough airflow, check the motor sizing using the selection chart on page 45. Install the correct size motor if needed and repeat step 2. **(See note below first)** If this does not correct the problem go to Step 3.

NOTE:

Do not oversize the motor to correct airflow problems. If the motor installed matches the motor selection chart recommendation, select the speed that produces the best possible airflow and proceed to Step 3.

Step 3. Check the system's Total External Static Pressure (Total ESP).

If the total ESP is higher than the system manufacturer recommends, the problem is most likely a restricted or undersized duct system. Correct the duct issues.

If the Total ESP is lower than the system manufacturer recommends, the problem is most likely a disconnected or improper opening in the duct system. Correct the duct issues.

If the diagnostics provided here do not solve your problem, please go to thedealertools.com and download the full installation manual for further support.

Technical Support is also available on the **Evergreen Hotline at 1-866-503-8566.**

 **WARNING**

Genteq does not condone the repair of any individual components in the motor control or motor of their ECM products. This practice is unsafe and may cause personal injury, death, or property damage.

 **WARNING**

Working on the motor with power connected may result in electrical shock or other conditions that may cause personal injury, death or property damage.

 **WARNING**

Always disconnect the power from the HVAC system before removing or replacing connectors, servicing the motor, removing the high voltage plug, and before reconnecting.

 **WARNING**

Disconnect AC power from the system and make sure the fan blade has come to a complete stop before servicing the motor.

 **WARNING**

Do not operate motor without fan blade attached. Such operation will cause the motor to oscillate up and down.

 **WARNING**

You must have the correct replacement motor from the manufacturer that is a direct replacement for the failed motor.

USING THE WRONG MOTOR VOIDS ALL PRODUCT WARRANTIES AND MAY PRODUCE UNEXPECTED RESULTS.

Models 142 and 142R ECM Outdoor Fan Motor Diagnostics

See the Motor ID chart on page 7 if needed.

IF THE MOTOR IS RUNNING

1. It is normal for the motor to rock back and forth on start up. Do not replace the motor if this is the only symptom identified.
2. If the system is working properly but the motor appears to run slower than it should, the motor is good. High efficiency systems, especially those with optimized fan blades, will run the motor slower to decrease noise.
3. If the system is noisy, freezing up, running a high head pressure, tripping the high pressure switch or the compressor overload, check the following:
 - ➔ Clean the condensing coil and any shrouds thoroughly including in between two pass coils (this may require some unit disassembly) following the manufacturer's recommendations. This motor will not compensate for lack of airflow through dirty coils.
 - ➔ Confirm all fan blades are shaped the same, in good condition and not rubbing on the shroud. Also confirm the fan blade hub bolt is secure on the motor shaft. Also confirm the motor is secure in its mount and the mount legs are secure to the unit.
 - ➔ Use the next section "If the motor is not running" for voltage checks to determine if the motor is getting the proper inputs.
4. If the motor does not appear to be running at the proper speed or does not shut off, refer to the next section for voltage checks to determine if the motor is getting the proper inputs.

IF THE MOTOR IS NOT RUNNING

This motor uses a 5 or 6 wire harness with wire colors specified by the OEM. Therefore the OEM schematic for the particular unit you are working on will be necessary to identify motor connections on the system controls.

1. Check for proper high voltage and ground. Using the OEM schematics, locate the L1, L2, and Ground connections and confirm voltage is 208-230 \pm 10%. Correct any voltage issues, worn or broken connections.
2. This motor is energized and de-energized with communication inputs. Model variations include Single Speed 24VAC communication, Multi-speed 24VAC communication and Single or Multi-speed PWM communication. See example figures on p52. Using the OEM schematic, identify the communication type and check for proper voltage. PWM taps are diagnosed with DC voltage specified by the HVAC unit OEM.

➡ **If the motor IS NOT receiving any communication**, troubleshoot the communication issue using the manufacturer's troubleshooting guides. The control board in the outdoor unit will need the proper demand call (low voltage or communication) from the indoor controls to provide the proper communication to the motor. Confirm these demand(s) are there before checking the communication to the motor.

➡ **If the motor IS receiving proper communication** (and proper high voltage power) and is not running, proceed to the next section on Motor Replacement.

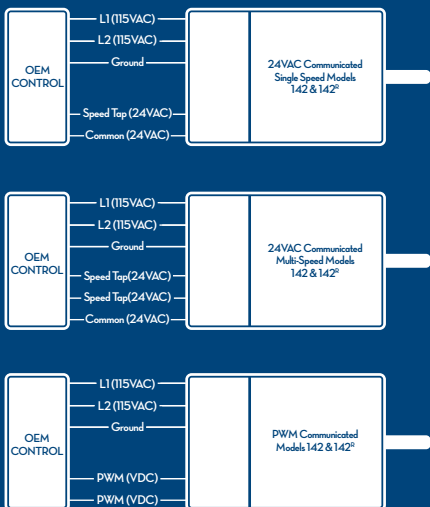

Replacing the Motor

This motor is replaced in one piece. The control cannot be replaced separately from the motor. Even if the control is remotely located, the replacement part will be a new control with harness and new motor.

You must have the correct replacement motor from the manufacturer that is a direct replacement for the failed motor. **USING THE WRONG MOTOR VOIDS ALL PRODUCT WARRANTIES AND MAY PRODUCE UNEXPECTED RESULTS.**

Always mount the replacement motor and control (if mounted separately) according to the manufacturer's specifications using all required hardware to reduce vibration. Make sure all wires are free of the fan blade and not pinched in mountings or cabinet through points.

Indoor Motor Final Installation Checks

- Check all wiring and connections, especially those removed while servicing.

Ensure the system is set up as follows:

- Clear all condensate drain and traps.
- Check and plug leaks in return ducts and equipment cabinet.
- Verify that the system is running quietly and smoothly, producing proper air flow in all modes (heating, cooling, and continuous fan) and all stages (if applicable).
- Return all thermostat settings to the customer's preference.
- If any evidence of moisture, then correct the issue.
- If the area is subject to high amounts of lightning strikes, then use of additional transient protection may be helpful.

Outdoor Motor Final Installation Checks

- Before energizing the HVAC system, confirm the fan blade is free of all obstructions, including the system shroud and compressor.
- Check all wiring and connections, especially those removed while servicing.
- Verify the system is running quietly and smoothly in all modes and stages if applicable.
- Check the refrigerant level only after confirming proper indoor airflow as well.
- Bent coil fins restrict airflow; correct if possible without damaging the coil or other fins.
- Return all thermostat settings to the customer's preference.

Good Practices:

- Finish all service calls by checking all safeties, and perform a visual inspection of the overall job to prevent call-backs.
- Check the level of Carbon Monoxide (CO) in the vent(s) and living spaces of all homes with fossil-fuel appliances.
- Recommend annual maintenance.

Visit thedealertools.com
to learn more



1946 WEST COOK ROAD : FORT WAYNE, IN 46818
ph : 260 416 5400 fx : 260 416 5499



GTQ-8001 Version 3.0
©2014 Regal-Beloit Corporation

A Regal Brand

The Regal logo, which is the word "REGAL" in a bold, italicized, sans-serif font, set against a dark grey trapezoidal background.

REGAL

©2014 Regal-Beloit Corporation