

XAC 170R USER MANUAL RESOURCES

CONFIDENTIAL

Table of Contents

1	Purpose and audience of this document	5
2	References.....	5
3	Specifications.....	6
4	Package Content	8
5	Device Overview.....	9
6	Power On/Off the Device.....	10
7	Using the Magnetic Card Reader.....	11
8	Using the IC Card Reader.....	11
9	Using the Key Pad	12
10	Using the Contactless Card Reader.....	12
11	Changing the Battery	13
12	Insert SAM & SIM card.....	14
13	Loading Paper	14
14	Installing the Strap.....	15
15	Operating the Terminal.....	16
	15.1 Launcher Screen.....	16
	15.2 Status Bar	17
	15.3 Notifications	18
	15.4 Navigation Bar.....	20
	15.5 Logging in	20
	15.5.1 Login Modes	20
	15.5.2 Authorization Screen.....	21
	15.6 Settings.....	24
	15.7 Sleep.....	25

15.8	Loss of WiFi	26
15.9	Configuring Device Page	28
16	Payments.....	30
16.1	Introduction	30
16.2	Common Scenarios	30
16.2.1	Simple Sale with Payment Card.....	30
16.2.2	Sale with a tip	37
16.2.3	Sale with Manual Card Entry	39
16.2.4	Pre-authorization Only	40
16.2.5	Status Check	40
16.3	Common Transaction Exceptions.....	41
16.3.1	Cancelled Transaction	41
16.3.2	Card Removed	42
16.3.3	Timeout	43
16.3.4	Card Read Error	44
16.3.5	Communication Error	45

1 Purpose and audience of this document

This document is a resource of information about the XAC 107R Smart POS device.
The present version of this document describes the hardware and the Launcher software.

2 References

Document	Publisher
xCL_AT-170R Datasheet	XAC Automation Corporation
xCL_AT_170 Series: Installation Guide	XAC Automation Corporation

3 Specifications



CPU	ARM Cortex-A7 microprocessor cores (quad-core) up to 1.1GHz
Operating system	Android 8.x
Memory	<ul style="list-style-type: none"> • 1GB DDR3 SDRAM • 8GB eMMC Memory
Display	<ul style="list-style-type: none"> • 1280x800 full color TFT IPS • Capacitive touch screen display
Audio	Audio Jack and Microphone
Pin pad	Touch PINPAD
Magnetic Stripe Reader	ISO 7811 compliant 3-track MSR
Smart Card Reader	<ul style="list-style-type: none"> • ISO7816-1/2/3 compliant Asynchronous Card protocol T=0, T=1, and SLE4442 Memory Card • Up to 2 SAM, Support 3V SAM card
Contactless Reader	<ul style="list-style-type: none"> • ISO14443 type A/B, ISO18092 (NFC) • MiFare, Felica • <u>Global Contactless L2</u>

	<ul style="list-style-type: none"> • Visa PayWave - Mastercard PayPass • Discover DPAS - AMEX ExpressPay • ChinaUnionPay QuickPass • <u>Local Contactless L2</u> • Japan Jspeedy - Canada Interac Flash • Germany GBIC - France Carte Bleue • Russia MIR
Security	<ul style="list-style-type: none"> • Algorithm: 3DES, AES, RSA • Key Management: MK/SK, DUKPT • TLS 1.2 support • Secure Code Update Architecture
Certification	<ul style="list-style-type: none"> • PCI PTS 5.x with SRED • GBIC, and CC compliant • EMV Contact L1 & L2 • EMV Contactless L1 • Mastercard TQM (IFM/PCD) • PayPass, PayWave, DPAS, ExpressPay, Quickpass, JSpeedy, MIR, CB, GBIC
Thermal Printer	48 mm printing width with tear bar
Communication	<ul style="list-style-type: none"> • WI-FI 802.11 a/b/g/n (2.4GHz & 5GHz) • Bluetooth 4.2 dual mode • 4G wireless, dual SIM or 1*SIM+1*eSIM
Extension Ports	USB Type C Connector x 1
Barcode Reader (optional)	Support 1D/2D barcode scanning
GPS (optional)	GPS Tracking
Power	<ul style="list-style-type: none"> • 5V/2A Switching Power Adapter • Li-Ion Battery (5200mAh) with smart battery charger (state of health)
Dimensions	-231.1 (L) x 113.8 (W) x 71.8(H) mm
Environmental	<ul style="list-style-type: none"> • Operating Temperature: 0°C to 50°C • Battery Charging Operating Temp.: 0°C to 45°C • Storage Temperature: - 20°C to 60°C • Operating Humidity: 5% to 85% (non-condensing)

Accessory	<ul style="list-style-type: none">• 5V/2A DC power adapter• USB cable (type C to type A)• Rechargeable battery• Paper roll• Quick user guide/safety instruction• Cradle (XC-70)• - Charger Stand• - Charger Stand + Ethernet + USB host x 2+ RS232 x 2• - Charger Stand + Ethernet + USB host x 1 + RS232 x 2+ Modem
------------------	--

4 Package Content



■ AT-170



■ Power adaptor (Optional)



■ USB cable



■ Paper Roll



■ Hand Strap (Optional)

5 Device Overview

AT-170 Key Buttons & Interface Ports (Figure 1)

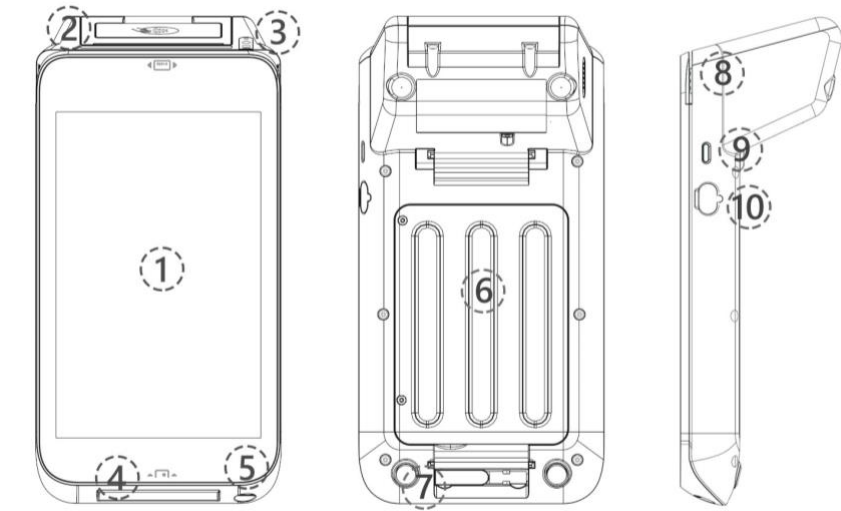

Figure 1

Front:

1	7" Touch Display
2	Printer Paper Cover & Contactless Card Tapping Area
3	Camera for barcode scanning (Optional)
4	Smart Card Reader (SCR) slot
5	Audio Jack

Rear:

6	Battery Compartment
7	Charging Contact

Right:

8	Magnetic Strip Reader (MSR) slot
9	Power Button (Press > 3 seconds to power on/off)
10	USB OTG port (type C)

- AT-170 Power spec:
 - Input: 5V DC, 2A
- Power Adapter spec:
 - Input: 100 ~240 Vac
 - Output: 5V DC, 2A

 **Caution:** Use only the AC adapter approved and provided by XAC Automation Corporation for use with this device. Use of any other AC adapter may cause a risk of fire or explosion.

- Operating Temperature:
 - 0°C to 40°C

6 Power On/Off the Device

Power ON. Press and hold the Power key for 3 seconds until the screen is activated. **(Figure 2)**

Power OFF. Press and hold the Power key for 3 seconds to shut down the device.

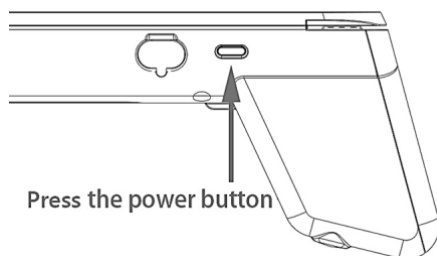
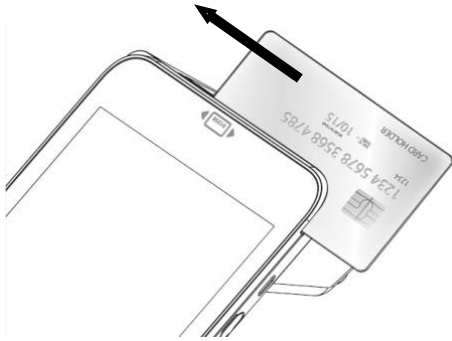

Figure 2

NOTE: When device is in idle or suspend mode, one short press power of the button will wake up the device.

7 Using the Magnetic Card Reader

Swipe the card through the slot with magnetic stripe at the back side of the card:



8 Using the IC Card Reader

Insert an IC card into the slot with the chip side facing upward:



9 Using the Key Pad

After inserting the chip card, press the numeric keys of virtual keypad shown on the display to enter the password. Press Cancel (X) key to terminate any current function and press the Enter (O) key to confirm a value or an option.

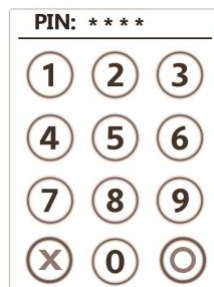

10 Using the Contactless Card Reader

Tap the contactless card on top of the contactless logo which is shown on the paper cover. The four green LED indicates the contactless card reading status:

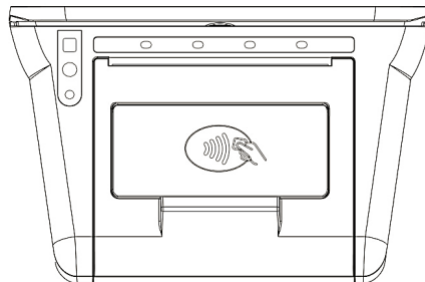

11 Changing the Battery

- STEP 1.** Remove the 2 screws and open the battery cover as **Figure 7**.
- STEP 2.** Lift the battery and pull up the battery connector from device as **Figure 8**
- STEP 3.** Insert the connector of new battery into the device as **Figure 8**

Note: Please ensure the orientation of connector of battery cable matches the connector on the device.

- STEP 4.** Place the new battery into the compartment
- STEP 5.** Place the battery cover to close the compartment as **Figure 7**.
- STEP 6.** Fasten the 2 screws.

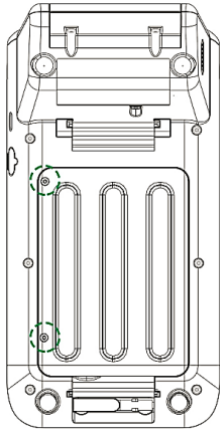

Figure 7

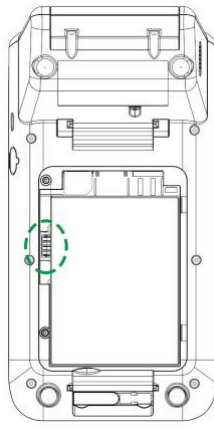

Figure 8

Bottom Cover Removal Warning

When removing the bottom cover and screws for the purposes of changing battery, remember to put back the cover and screws before power on the POS.

CAUTION:

RISK OF EXPLOSION IF BATTERY IS REPLACED BY AN INCORRECT TYPE. DISPOSE OF USED BATTERIES ACCORDING TO THE INSTRUCTIONS.

Warning for internal battery pack

To reduce risk of fire or burns:

1. Do not attempt to open, disassemble, or service the battery pack.
2. Do not crush, puncture, short external contacts, or dispose of in fire or water.
3. Do not heat above 60°C

12 Insert SAM & SIM card

After removing the battery cover, two SAM and two SIM card slot are top of the battery (**Figure 9**). Please insert the card correctly as the icon shown on the cover:

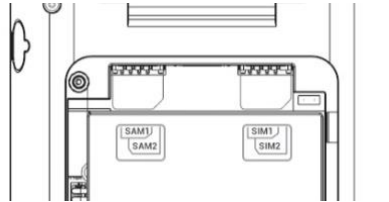

Figure 9

13 Loading Paper

STEP 1. Gently pop the printer cover's latch; then pull the cover upward to open the paper roll cover

STEP 2. Load a roll of thermal paper into the printer. Please ensure the printing-side of the paper will feed out facing the operator.

STEP 3. Close the cover by pressing on the center of the printer cover. Use the serrated bar to tear off any excess paper.

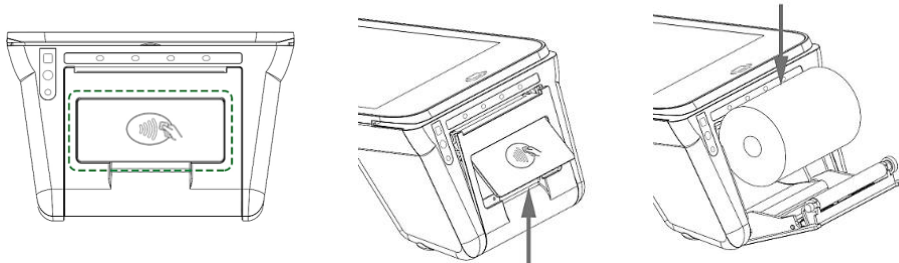

14 Installing the Strap

Align two ends of strap pin to the notches on AT-170 rear cover:

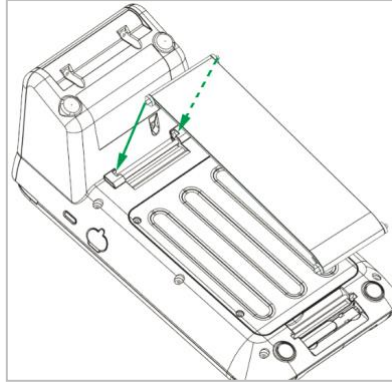

Press downward the strap pin into the notches, then pull another pin of the strap to install another side as Figure 11-2.

Note: After pressing the pin, make sure it is fixed into the notch of AT-170:

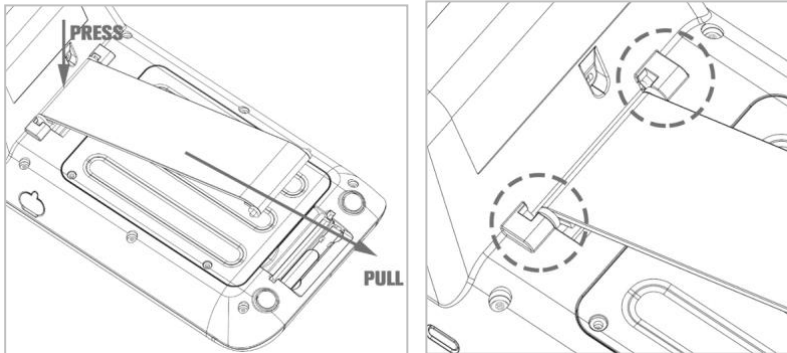

Finished look of the strap assembly:

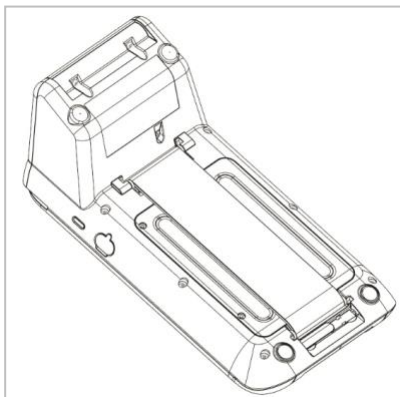

15 Operating the Terminal

15.1 Launcher Screen

The layout of the launcher screen will be customised. It can have a number of styles, and show any number of apps. The following is an illustrative example, which is unlikely to be exactly like the exact Launcher you see on your own device:

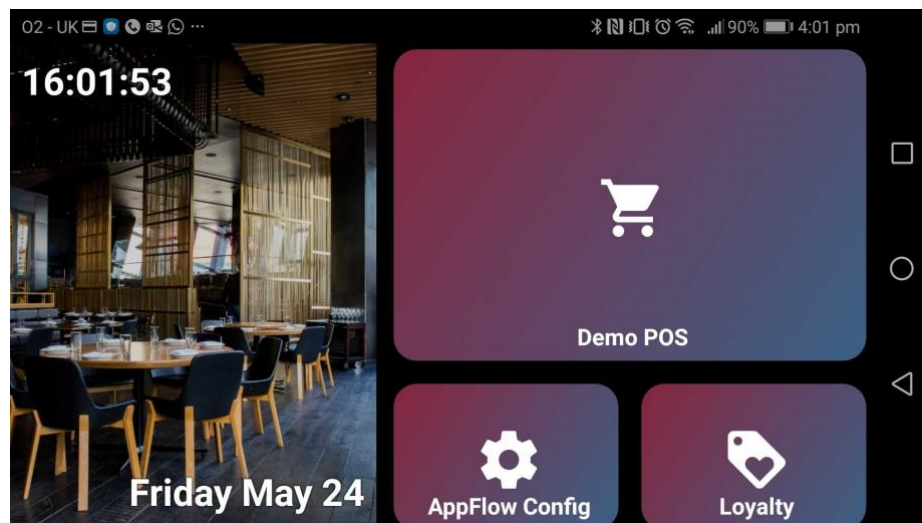

15.2 Status Bar

The device shows a status bar at the top of the screen. It is the same in appearance and functionality as the standard Android system bar. It conveys the following types of information:

- Communications type eg. WiFi, 4G
- Communications strength
- Notifications
- Time
- Background activity indicator
- Battery charge remaining
- Battery/power usage indicator

Example:



The icons on the status bar are predominantly the standard Android operating system ones, e.g. the same ones that would be seen on an Android phone. However, they include icons that alert you to notifications that have been received from particular apps, including some apps that are provided pre-loaded on the device, such as these three in the example above:



From left to right, the three notification icons relate to:

- **Payment Processing Service**, which is the app (also called App Flow) that co-ordinates the flow of processing between different apps to complete a transaction.
- **Xlator**, which is an app that supports the payment processing service
- **MDM Agent**, (Mobile Device Management), which is an app that communicates with a central server. It monitors the device's health and ensures that its apps and system settings are up to date.

15.3 Notifications

If you swipe down from the status bar, you will see a panel of notifications. The actual notifications vary and are explained later in this section. A typical set of notifications would resemble the set below:

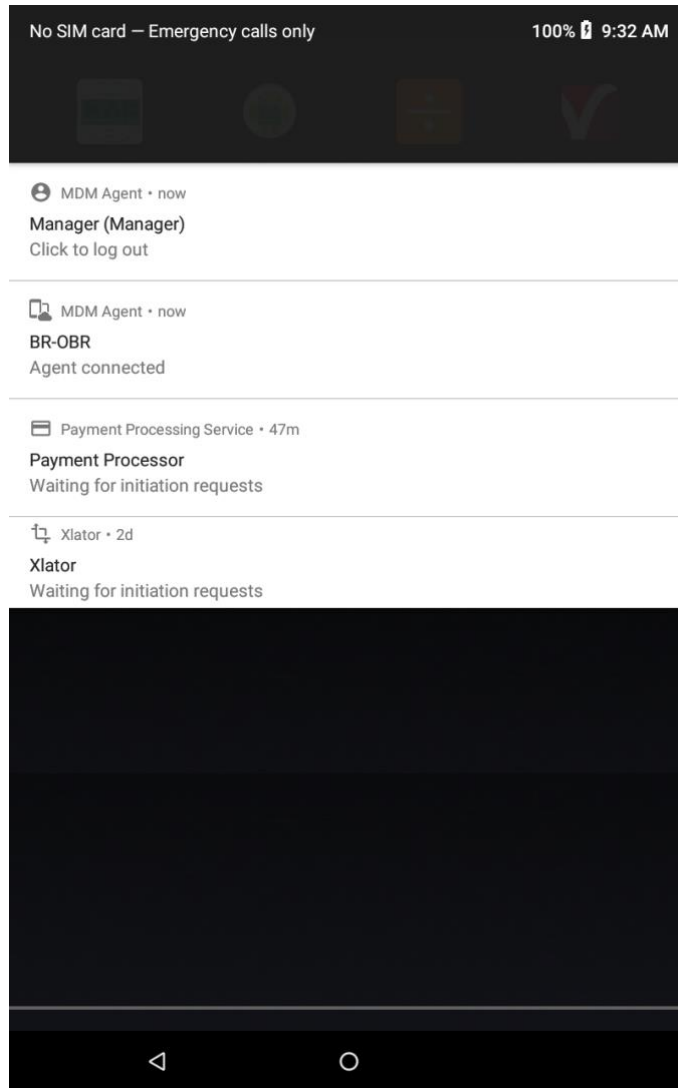

- **MDM Agent** (Mobile Device Management) is an app that communicates with a central server. It monitors the device's health and ensures that its apps and system settings are up to date. Most of the time, two MDM Agent notifications are displayed, as shown in the above example:
 - An indication of the kind of user that is currently logged in: one of Operator, Manager and Technician. See the sub-section on logging in for more information about what happens if you click to log out.
 - An indication that the MDM Agent is connected. Clicking on this opens the Configuring Device Page (see Configuring Device page sub-section).

Other notifications that the MDM Agent could display include:

- If the agent loses its connection with the server (most likely due to a loss of Wi-Fi signal), the “Agent connected” notification is replaced by the one below and you should check the WiFi (see the section on Settings):

 MDM Agent • now
BR-OBR
Failed to contact device management service

- If the MDM Agent has removed an app (acting on an update received from the remote server), a notification is posted, e.g.:

 Android System ▾
Draw
Deleted by your admin



- **Payment Processing Service** is the app (called App Flow) that co-ordinates the flow of processing between different apps to complete a transaction. In its normal state, it indicates that it is “Waiting for initiation requests”, as shown above.

Another notification that is sometimes displayed from the Payment Processing Service is this one:

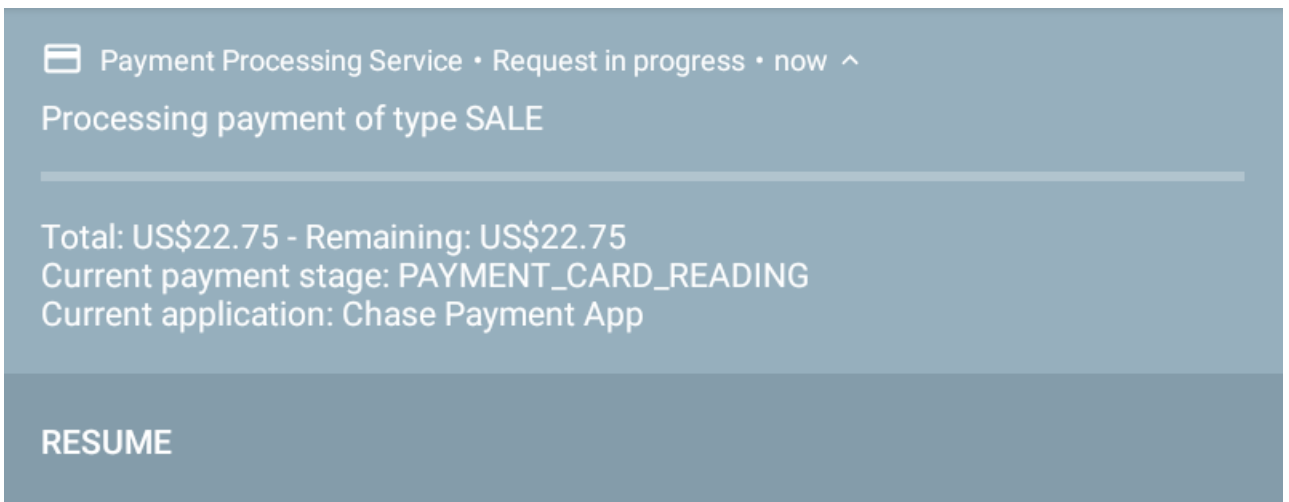

The screenshot shows a notification with a blue background. At the top, it says "Payment Processing Service • Request in progress • now ^" with a close icon on the left. Below that, it says "Processing payment of type SALE". A horizontal line separates this from the details: "Total: US\$22.75 - Remaining: US\$22.75", "Current payment stage: PAYMENT_CARD_READING", and "Current application: Chase Payment App". At the bottom, there is a dark blue bar with the word "RESUME" in white capital letters.

The notification above is displayed when the user minimises the payment app (i.e. opens the home screen) during a transaction. It offers the user the ability to resume the transaction that was interrupted.

- **Xlator** is an app that supports the payment processing service and its normal state message is “Waiting for initiation requests”, as shown above.

15.4 Navigation Bar

The navigation bar at the bottom of the screen is a standard Android one, offering a Back and a Home option:



15.5 Logging in

15.5.1 Login Modes

The device will have been configured by the system administrator to operate in one of two modes:

- Login not required. The user can use the device at the least privileged level (Operator) without entering a password. Only higher levels (Manager or Technician) require a password to be entered.
- Login required. The user needs to know at least an Operator password.

15.5.2 Authorization Screen

The authorization screen, as well as accepting a password, presents information that is useful, especially if seeking technical assistance:

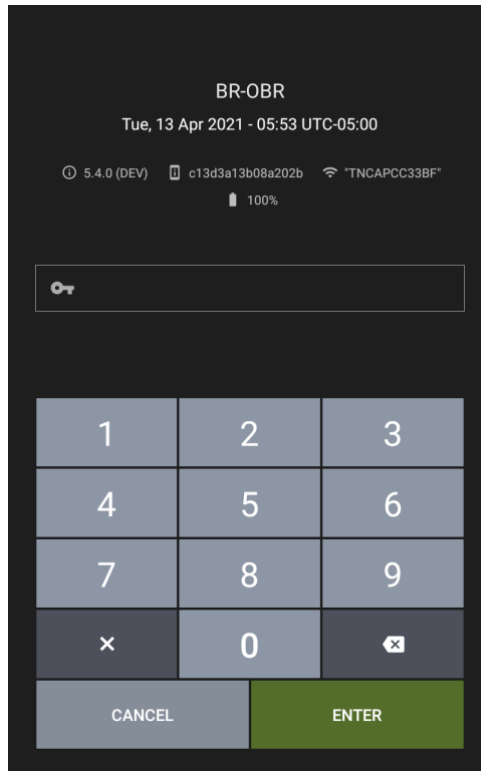

At the top, the name of the device is shown (“BR-OBR” in this example). The name cannot be changed from the device, and can only be set centrally, using the partner device procurement portal. Once set, it can also be edited from the portal.

The date and time are the device’s settings and sometimes this information is relevant to a technical support call. The part of the time that begins “UTC” refers to an offset from Greenwich Mean Time (so is indicating a time zone).

On the third line down, the version (“5.4.0 (DEV)” in this example) is the version of the MDM Agent. The long sequence of letters and numbers (starting “c13d...” in this example) is called the Device Id. On a technical support call, you may be asked to read this Id out, as it allows the device to be identified on the central Admin Portal. If the device is connected to a Wi-Fi, you will see the name of the Wi-Fi network.

The battery charge level is also displayed.

In the Login Not Required mode, when the login screen is displayed, it is sufficient to press Cancel to be able to use the device as an Operator:

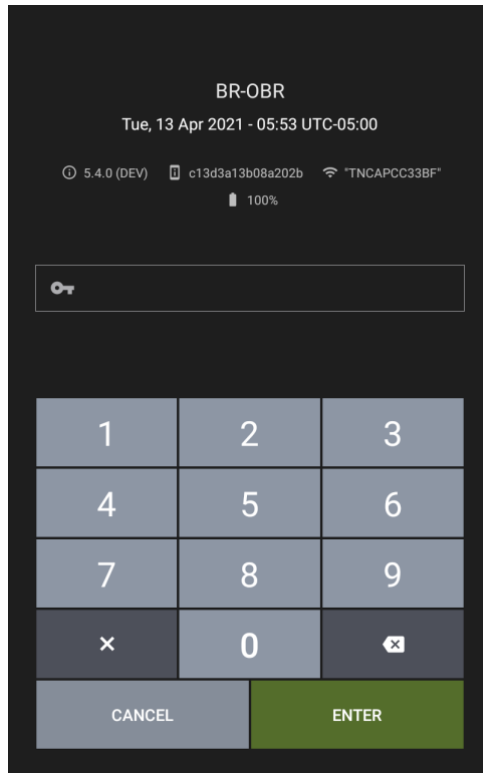

Use the number pad to enter a password. You may have been given two passwords: an operator one (if using Login Required mode) and a manager one. It is sufficient to press Cancel to login as an Operator. Alternatively, press Enter to submit a password. The differences between the rights of an Operator and a Manager are explained in the Settings sub-section below.

If you have forgotten your passwords, contact your technical support team, who will re-generate a pair of passwords. The passwords, once generated centrally by the technical support team, will be likely to take 5 or more minutes to be sent down to the device, so may not work immediately.

You may wish to change from being logged in as an operator to being a manager or vice versa. To do this, swipe down from the status bar to display the notifications, one of which will state the level at which you are logged in:

 MDM Agent • 2m
Operator (Operator)
Click to change account

or:

 MDM Agent • now
Manager (Manager)
Click to log out

Clicking the notification when the logged-in user is the operator displays the password entry screen, where you can enter a password. Clicking the notification when the logged-in user is the manager automatically demotes the log-in level to operator (no password entry required).

In addition to the operator and manager passwords, there exists a technician's password, which confers maximum rights on the device. The technician's password, which is time-limited, is available only to suitably qualified support personnel.

After a period of inactivity, the device goes to sleep and this may result in the login page being displayed when the device is woken again: see the sub-section on Sleep below.

15.6 Settings

The settings that can be edited vary according to the logged-in level. A manager can edit more settings than an operator, though neither has access to the full range of Android settings. The table below lists the settings that are made available, with an indication of the log-in level that is required.

Table Heading	Login level
Wifi	Manager
Bluetooth	Manager
SIM cards	Manager or Operator
Battery	Manager
Display	Manager or Operator
Notifications	Manager or Operator
About	Manager

The technician, when logged in, can access the full range of settings that is offered by the version of Android that is installed.

For the sub-sets of the full Android settings that are made available to the Manager and/or Operator, the meaning and behaviour of each setting is identical to the standard for the version of Android that is on the device.

15.7 Sleep

The device will go to sleep after a period of inactivity. The screen switches off and it can be woken up by a single press on the power button. On being woken up, depending on the configuration set by the system admin, one of two things will happen:

- If the logged-in user is operator, the screen displays the page that was displayed when the sleep mode started. If the logged user is any level other than operator, the login page is displayed (with an option to Cancel, in order to continue as an operator).

Or

- The screen always displays the login page.

The actual Sleep timeout is set in Settings, under Display -> Advanced. The device offers a range of timeout periods, up to a maximum that is set by the system admin.

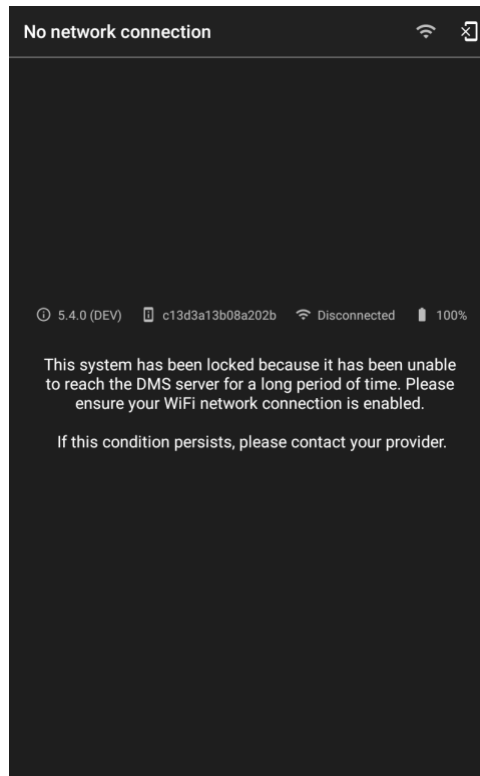

15.8 Loss of WiFi

If the device loses its Wi-Fi connection for a period of time, it displays this screen:



The period of time that triggers this is set by the administrators of your device and is not the same for all devices.

The two icons in the top status bar, on the right, offer two options for remedying this condition:

	<p>Use this to Factory Reset the device. Only choose this option after taking advice from your technical support team, as it is an irreversible action that renders the device unusable as a payment device without re-installation of components.</p>
	<p>Use this option to reconnect the device to a Wi-Fi network. On pressing it, you will be asked for a password. You must enter the manager password (or a technician password if you are a support team member). The operator password will not be accepted (as setting WiFi requires a higher level login than operator). After entering a password, you will be presented with the WiFi Settings page. After re-connecting it and pressing the back or home button on the navigation bar, the screen will return to the “network disconnected” screen shown above. This is normal and the screen will automatically change to the home screen, showing the usual launcher, after about a minute.</p>

15.9 Configuring Device Page

The device's apps are updated by a remote server. The Configuring Device page provides a summary of the installations that have been done. The page is opened from a notification from MDM Agent. Clicking on the standard notification for MDM Agent opens the Configuring Device page:

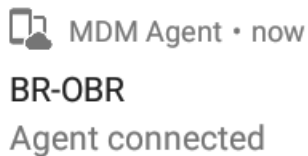

When the device is being updated, a different notification is added to the notifications panel, and clicking on this notification, too, will open the Configuring Device Page (though you are not required to click on any notification for the updates to be completed):

:

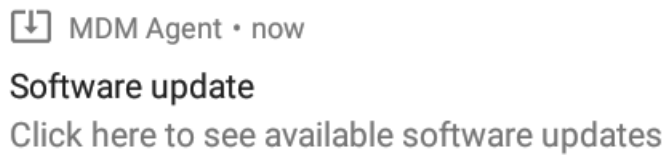

The Configuring Device page shows a chronological list of the apps, and their version, that are currently installed on your device, e.g.:

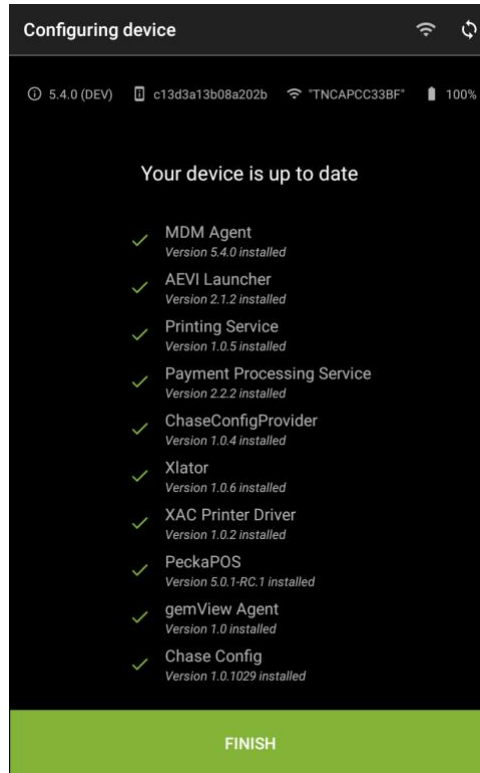

If any app installation failed, a notice of failure is presented for the app installation that failed.

Clicking on the refresh icon at the top right causes the device to synchronize with the server to check that it has all the latest software updates.

At the top of the page, the version ("5.4.0 (DEV)" in this example) is the version of the MDM Agent. The long sequence of letters and numbers (starting "c13d..." in this example) is called the Device Id. On a technical support call, you may be asked to read this Id out, as it allows the device to be identified on the central Admin Portal. If the device is connected to a Wi-Fi, you will see the name of the Wi-Fi network.

The battery charge level is also displayed.

16 Payments

16.1 Introduction

The Payment App processes card authorizations and sales. Transactions are initiated from a separate POS application (it is not possible to initiate one from the Payment App directly). A user guide to the POS will have been provided separately and its functionality is not described in this document.

When the POS is ready to process a transaction, it hands over control to the Payment App. The mechanism for this is a pre-loaded software system called AppFlow (documentation for AppFlow is held on <https://developer.aevi.com>).

This document presents the screens for processing example transaction scenarios.

16.2 Common Scenarios

This section describes the steps in the most common sales scenarios when using the payment app:

- A simple sale using a payment card.
- A sale with a tip using a payment card.
- A sale using manual card entry.
- A pre-authorization of a payment card without a sale.
- A status check of a payment card.

16.2.1 Simple Sale with Payment Card

In this common scenario the POS initiates a sale and the customer pays by swiping, inserting or tapping a card. In this scenario, no tip is prompted for and no signature is required.

- The POS application initiates the sale (the goods are selected and the sale transaction has been requested by the POS app).
- Depending on the system configuration, prior to the next step, one or more other apps could be presented, to offer pre-sale services. The apps presented, if any, will be any that the system administrator has selected. Information about any such apps is not provided in this document.

- The payment app displays the total to be paid:

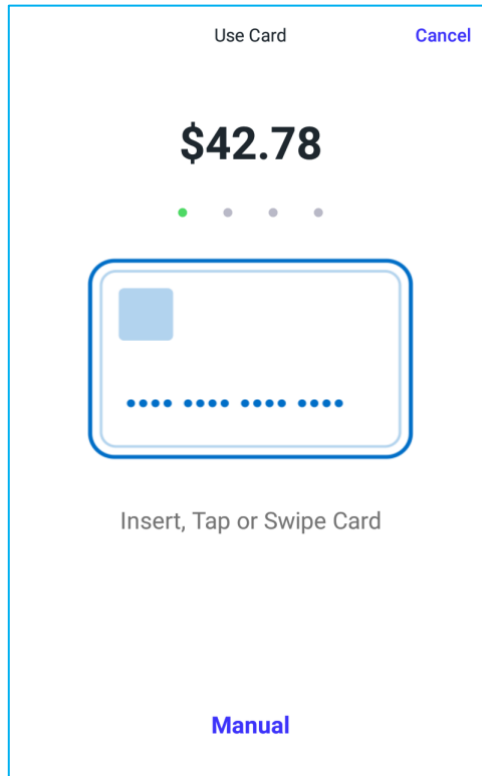

- Insert, tap or swipe the card. See the sections above for more information about the correct ways to do these on the XAC 170R device.
- The user may in some cases be presented with a screen to choose between a credit card and a debit card and sometimes also with other choices, e.g. Us Debit, Visa.
- Depending on the system configuration, prior to the next step, one or more other apps could be presented, to offer pre-sale services. The apps presented, if any, will be any that the system administrator has selected. Information about any such apps is not provided in this document.

- While the device reads the card, the following screen is presented:

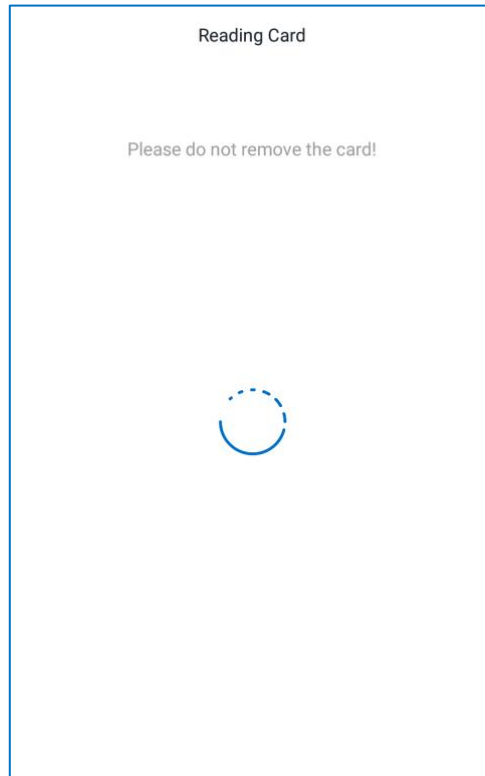

- If a PIN is required, the PIN entry screen is presented:

Enter PIN

[Input field]

1 2 3

4 5 6

7 8 9

0

[X] [←] [✓]

- An incorrect PIN is notified on the same PIN screen:

[X] [Incorrect Pin ←] [✓]

- The card should be removed when the device prompts:

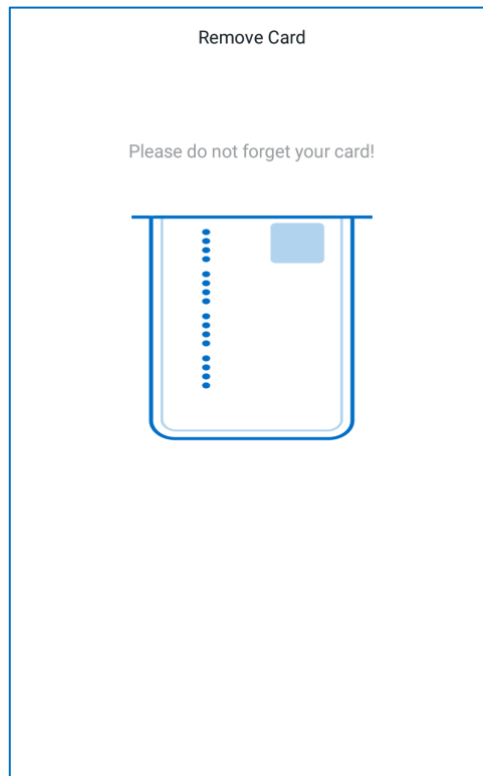

- While the payment app is authorizing the payment, the following screen is displayed:

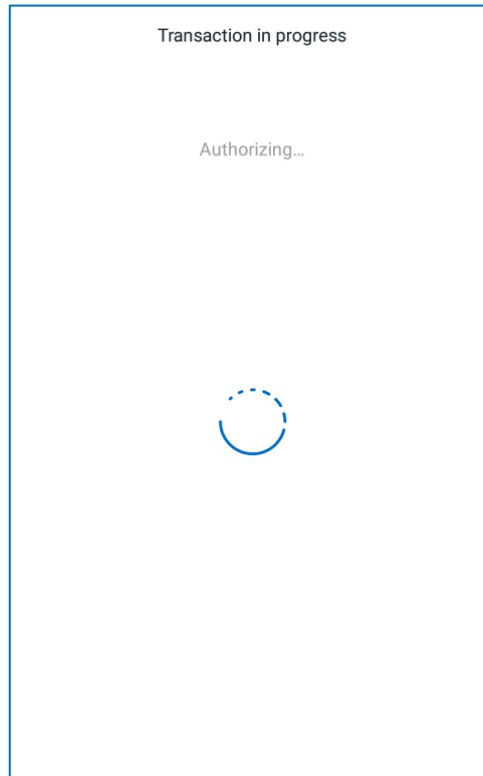

- If the transaction is successful, this is reported:

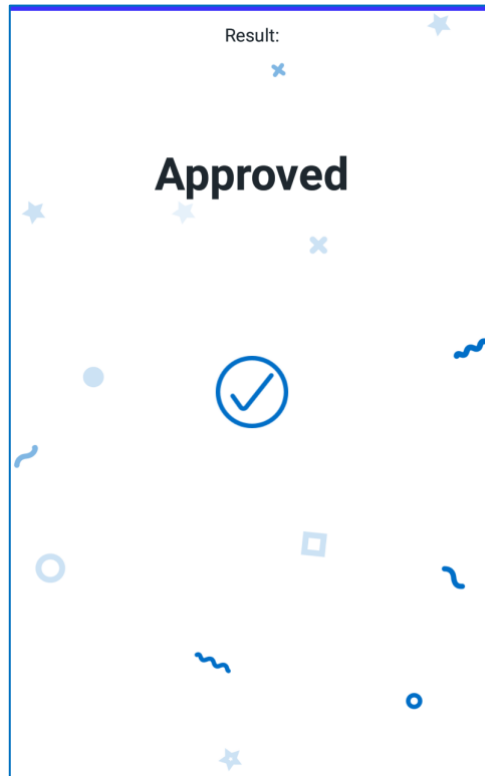

- Receipts are printed on completion of the transaction (a signature may be required).

16.2.2 Sale with a tip

The customer is prompted to add a tip to the sale amount.

The device will process a tip only if the system administrator has activated that functionality.

- The POS application initiates the sale (the goods are selected and the sale transaction has been requested by the POS app).
- Depending on the system configuration, prior to the next step, one or more other apps could be presented, to offer pre-sale services. The apps presented, if any, will be any that the system administrator has selected. Information about any such apps is not provided in this document.
- The payment app displays the total to be paid with a number of tip options also offered:

Enter Tip Cancel

\$42.78

+0.00

%5	\$44.92	+2.14
%10	\$47.06	+4.28
%15	\$49.20	+6.42
%20	\$51.34	+8.56

Pay Now!

Custom

- The customer can choose to:
 - Pay Now, without any tip.
 - Add any of the pre-calculated tips by tapping on the percentage / amount that they want to give (and then Pay Now).
 - Select Custom, which presents a page in which they can define an amount of their own (and then Pay Now):

The screenshot shows a mobile application interface titled "Enter Tip". At the top right, there is a "Cancel" link. The main display shows a large amount of "\$42.78". Below this, there is a grey button labeled "+0.00". A numeric keypad is displayed with digits 1 through 9, "00", and "0". At the bottom, there is a prominent blue button labeled "Pay Now!". Below the "Pay Now!" button, the word "Percent" is written in a smaller font.

- From this point on, the transaction is the standard one, as defined in the scenario Simple Sale with Payment Card (above).

16.2.3 Sale with Manual Card Entry

The POS initiates a sale and the merchant manually enters the card details.

Depending on how the system administrator has configured the device, manual card entry might not be supported.

- The POS application initiates the sale (the goods are selected and the sale transaction has been requested by the POS app).
- Depending on the system configuration, prior to the next step, one or more other apps could be presented, to offer pre-sale services. The apps presented, if any, will be any that the system administrator has selected. Information about any such apps is not provided in this document.
- The payment app displays the total to be paid:

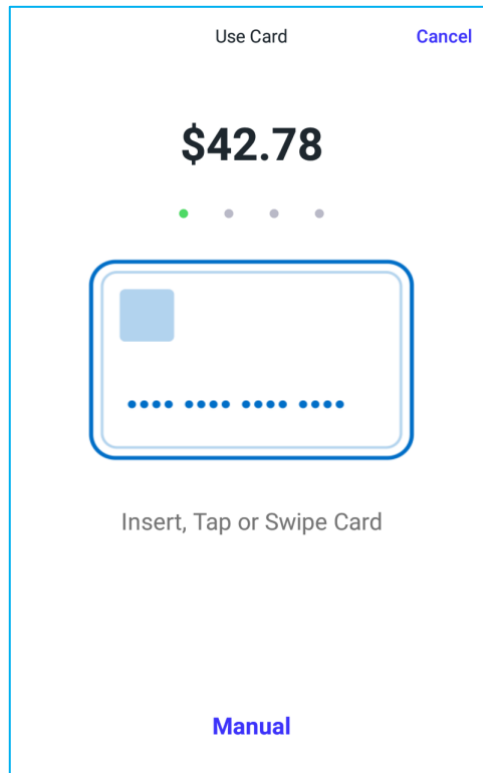

- Select Manual. In the manual entry screen, enter the card number and expiry date (use leading zeros, e.g. “02” not “2” for the month) and select Confirm:

The screenshot shows a mobile application screen titled "Manual Entry" with a "Cancel" link in the top right. Below the title is a text input field labeled "Card Number". Underneath that are two smaller input fields labeled "MM" and "YY", with the text "Expiration Date" centered below them. A prominent blue "Confirm" button is located below the input fields. At the bottom of the screen is a numeric keypad with digits 1-9, 0, a decimal point, a hyphen, a comma, a backspace key (X), and a right arrow key. The screen is framed by a blue border.

- From this point on, the transaction is the standard one, as defined in the scenario Simple Sale with Payment Card (above).
- Receipts are printed on completion of the transaction (a signature may be required).

16.2.4 Pre-authorization Only

The user wants to pre-authorize an amount.

The steps for this are identical to the scenarios above, with the same sequences of screens, except that the sale is not completed.

16.2.5 Status Check

The user wants to check the status of a card.

The steps for this are identical to the scenarios above, with the same sequences of screens, except that the pre-authorized amount is \$0.0.

16.3 Common Transaction Exceptions

16.3.1 Cancelled Transaction

If the user cancels a transaction before it is completed, by selecting a Cancel option in any screen, the following is displayed:

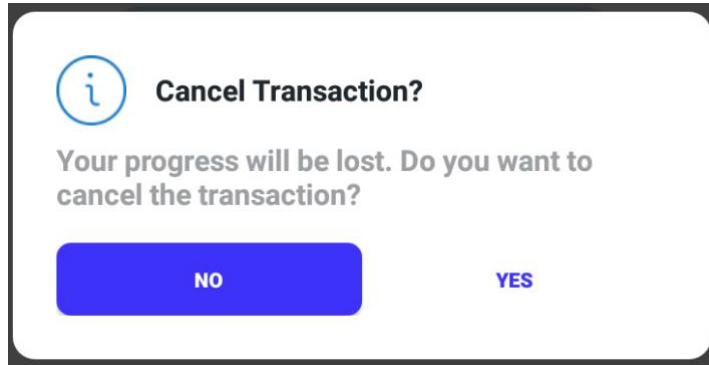

If the user selects Yes, the transaction is cancelled and a confirmation screen is displayed:

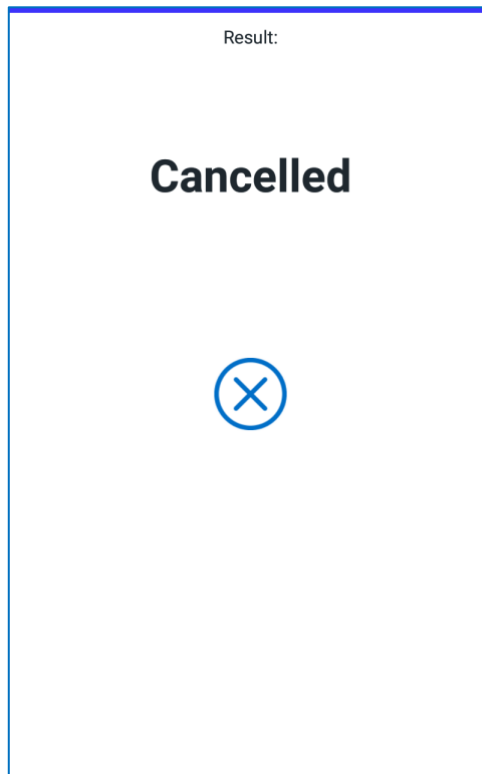

16.3.2 Card Removed

If the card is removed prematurely, the following screen is displayed:

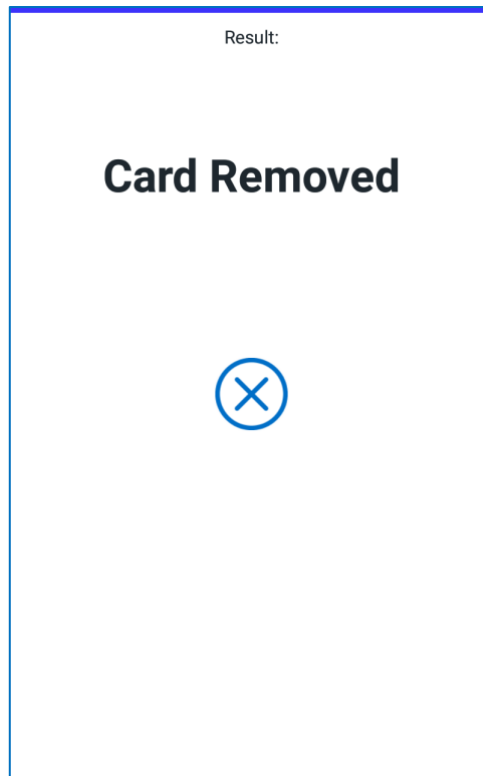

16.3.3 Timeout

The transaction times out if the user fails either to insert a card or to submit a manual card number within the required period of time. On a timeout, the following screen is displayed and the transaction is cancelled:

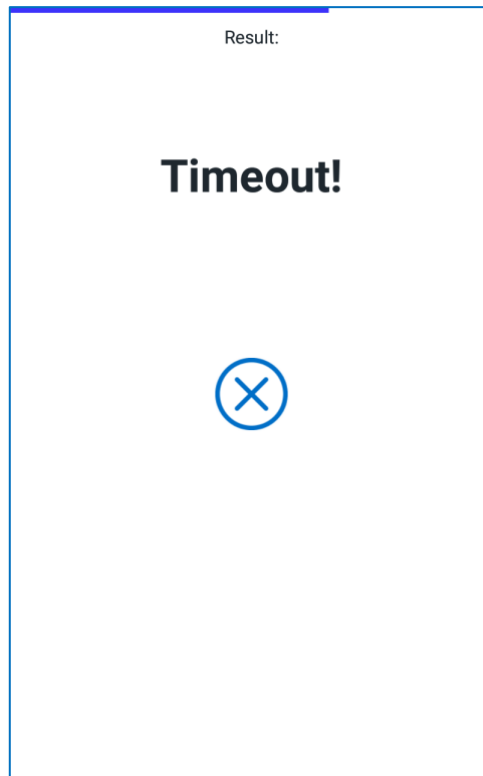

16.3.4 Card Read Error

If the device or the payment app are unable to read the CHIP on the card, the following is displayed (followed by advice to remove the card):

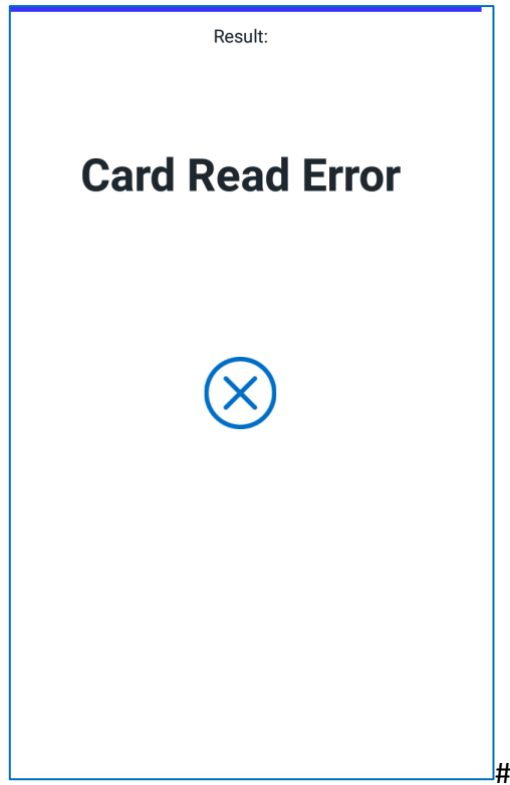

16.3.5 Communication Error

If there is a communication error, the following screen is displayed:

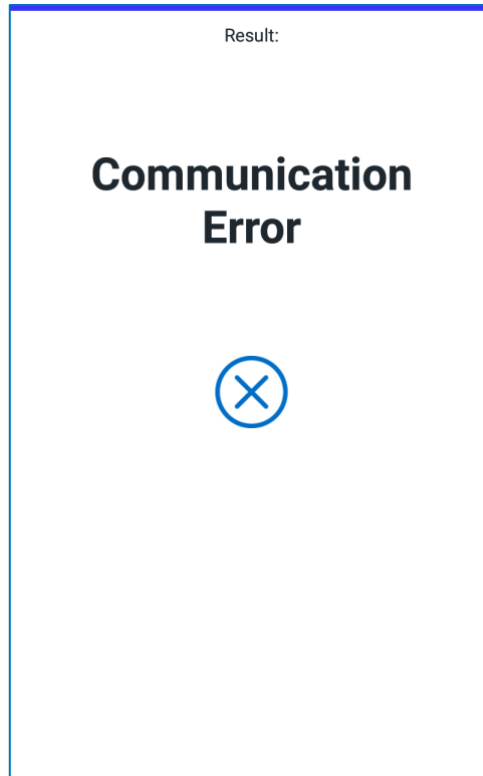

Check that the device is connected to the WiFi. If the problem persists, contact support.