

**CANARE®**

**26C**



*International Edition*

# CANARE®

offering value - added products to meet your needs for today and tomorrow.

## Five-point Product Development Goal



1

### Responsive

Fulfilling the needs of the industry through custom solutions.

2

### Unique

Incorporating valuable features not offered by competitors.

3

### Cutting-edge

Devoted to meeting the requirements for emerging technologies.

4

### Enduring

Concentrated on products with long-term value.

5

### Global

Focused on niche markets as well as universal products.

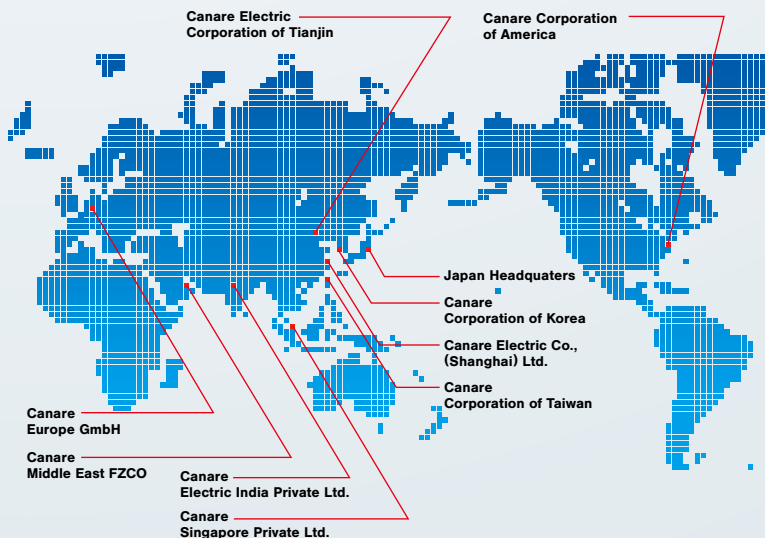

## Corporate Profile

- Name: Canare Electric Co., Ltd.
- Incorporated: February 1974 (commenced operation 1970)
- Capital: 1.04 billion yen
- Activities: Manufacture and sale of audio-video cables, connectors, assemblies, converters and related products for professional audio and video industry.

## Company Locations

Japan Headquarters (Overseas Department)  
5F, LIVMO Rising Bldg., 3-19-1 Shinyokohama,  
Kohoku-ku, Yokohama-shi,  
Kanagawa, 222-0033 Japan  
Phone: +81-45-620-7332  
Fax: +81-45-620-7364  
• Warehouse: Nagoya Japan

## Subsidiary Companies

- |  |  |
|--|--|
| • Canare Corporation of America          | <a href="http://www.canare.com">www.canare.com</a>       |
| • Canare Corporation of Korea            | <a href="http://www.canare.co.kr">www.canare.co.kr</a>   |
| • Canare Corporation of Taiwan           | <a href="http://www.canare.com.tw">www.canare.com.tw</a> |
| • Canare Electric Corporation of Tianjin | <a href="http://www.canare.com.cn">www.canare.com.cn</a> |
| • Canare Singapore Private Ltd.          | <a href="http://www.canare.com.sg">www.canare.com.sg</a> |
| • Canare Electric India Private Ltd.     | <a href="http://www.canare.in">www.canare.in</a>         |
| • Canare Europe GmbH                     | <a href="http://www.canare.eu">www.canare.eu</a>         |
| • Canare Middle East FZCO                | <a href="http://www.canare-me.com">www.canare-me.com</a> |

- Canare Electric (Shanghai) Co., Ltd.
- Canare Harness Co., Ltd (Japan)
- Canare System Works Co., Ltd (Japan)
- Canare Connected Products Co., Ltd. (Japan)



12G-SDI

EO Converters



12G-SDI

Active BNC



12G-SDI

75Ω BNC

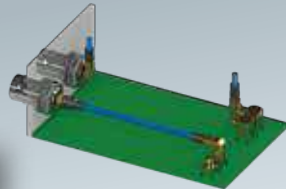

12G-SDI

75Ω Micro-miniature Coax Connectors



12G-SDI

Ultra Coax



12G-SDI

75Ω Staggered Video Patchbay



Cable Reel Snake



Cable Assemblies

# Contents

## Technical Trend

3 12G-SDI

## Fiber-Optic Systems

5 Overview

8 EO/OE Converters, Repeater

13 Mux/Demux, Optical Splitter

14 Power Supply

15 HFO Transmission Devices

17 HFO Camera Cables

22 HFO Camera Cable Checkers

23 HFO Camera Connector Panels

24 HFO Camera Connector Panels, Splice Enclosures

25 Fiber-optic Cables

## Connectors

29 75Ω BNC Connectors

35 Active BNC

37 75Ω BNC, N Connectors

38 75Ω Micro BNC Connectors

39 75Ω DIN Connectors

40 75Ω Micro-miniature Coax Connectors

41 75Ω Multichannel Coax Connectors

42 75Ω Triaxial Connectors

43 RCA Connectors

44 F Connectors, Phone Plugs

45 50Ω BNC Connectors

46 50Ω TNC, N, SMA Connectors

47 Cable Stripper, Crimp Tools

50 Impedance Transformers

## Cables

51 Q&A

53 Star Quad Microphone Cables

56 Two-conductor Shielded Cables

60 AES/EBU Digital Audio Cables

61 Speaker Cables

63 OFC Line, A/V Composite Cables

64 DMX, RS422 Cables

65 Ethernet Cables

66 75Ω Coaxial Cables

72 50Ω Coaxial Cables

## Panels and Patchbays

73 75Ω Video Patchbays

81 Unloaded Video Jack Panels

82 RS422 Patchbays

83 Video Patch Cords

84 Connector Panels

86 Audio Patchbays

## Multichannel Systems

88 Overview

89 Snake Trunks, Cable Reel Snakes

90 Fantails, Junction Boxes

91 Pin Assignments, Reels

92 Reels

## Cable Assemblies

93 BNC

94 Micro BNC, DIN, RCA (video), Triax

95 Ethernet

96 Ethernet, RS422, DMX

97 XLR, Phone

98 RCA (audio), Speaker, Audio Patch

99 Digital Audio, Analog Audio

100 HDMI

101 HDMI, DVI, VGA

102 VGA, 3 RCA, 2 RCA

Technical Trend

Fiber-Optic Systems

Connectors

Cables

Panels & Patchbays

Multichannel Systems

Cable Assemblies

### Cable and Connectors for UHD TV

Recent years, developments of Serial Digital Interface (SDI) require wider bandwidth and higher data rates. Cables and connectors are becoming a significant role in high definition video productions to work properly.

The table on the right shows comparison of high definition video formats which are standardized by SMPTE (Society of Motion Picture and Television Engineers). Canare, as a member of SMPTE, has provided the right products based on the requirements.

### Typical Cable Lengths

The right table shows typical cable lengths according to cable loss at receiver specified in the standard. The results may be different (most likely longer) because it's really the matter of the performance of a chipset built in. Obviously any other coax cables will be accepted if an application does not require such long, like patch cords.

### Video Formats

SMPTE	ST 292	ST 424	ST 2081-1	ST 2082-1
Format	HD-SDI	3G-SDI	6G-SDI	12G-SDI
So-called	HDTV	HDTV	UHDTV-1	UHDTV-1
Data Rate	1.485 Gbps	2.97 Gbps	5.94 Gbps	11.88 Gbps
Pixels	2K 1080i/720p	2K 1080p	4K 2160p30	4K 2160p60
Cable	75Ω Coax	75Ω Coax	75Ω Coax	75Ω Coax
Cable Loss at Receiver	20 dB @ 750 MHz	30 dB @ 1.5 GHz	40 dB @ 3 GHz	40 dB @ 6 GHz
Connector	75Ω BNC	75Ω BNC	75Ω BNC	75Ω BNC
Return Loss	15 dB @ 1.5 GHz	10 dB @ 3 GHz	7 dB @ 6 GHz	4 dB @ 12 GHz

### Cable Lengths

SMPTE	ST 292	ST 424	ST 2081-1	ST 2082-1
Format	HD-SDI	3G-SDI	6G-SDI	12G-SDI
L-2.5CHD	66 m	69 m	64 m	43 m
L-4.5CHD	115 m	119 m	109 m	74 m
L-3.3CUHD	85 m	90 m	83 m	58 m
L-5.5CUHD	155 m	161 m	149 m	102 m

The lengths are based on SMPTE standards and will vary depending on receiving equipment.

### 12G-SDI Signal Integrity

Canare 12G-SDI products are developed by a huge investment of time and research. Our products are verified and approved by the TRUE 12 GHz test equipment in addition, collaborations with top brands of broadcast products.

### Coaxial Cables: L-UHD Series

L-5.5CUHD for any applications up to around 100 meters. L-3.3CUHD for intermediate distance around 60 meters. Both are evaluated with endurance reliabilities such as bending, impact, and accelerated test.

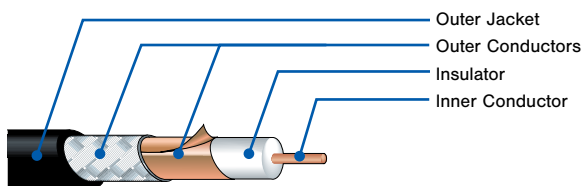

L-5.5CUHD (page 66)

### BNC Connectors and Patchbays

BNC connectors and video patchbays should be fully matched with 12G coax cables. Canare developed these products over the years of improvements in order to exceed SMPTE requirements.



BCP-BPLHK (page 33)



MCVJK-ST\* (page 74)

### Nominal Attenuation

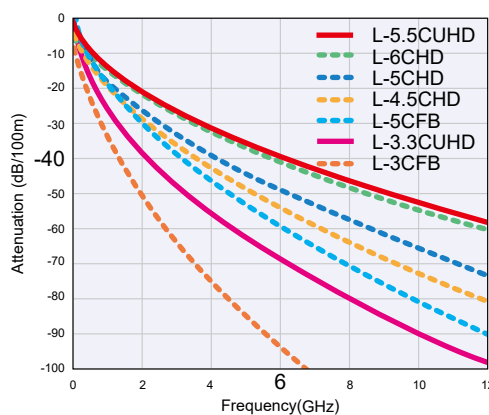

### Return Loss

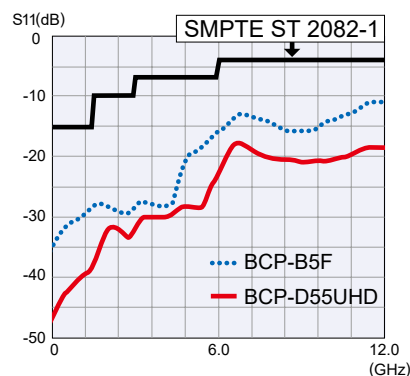

**2K/4K: 3G-SDI Single-link or Multi-link**

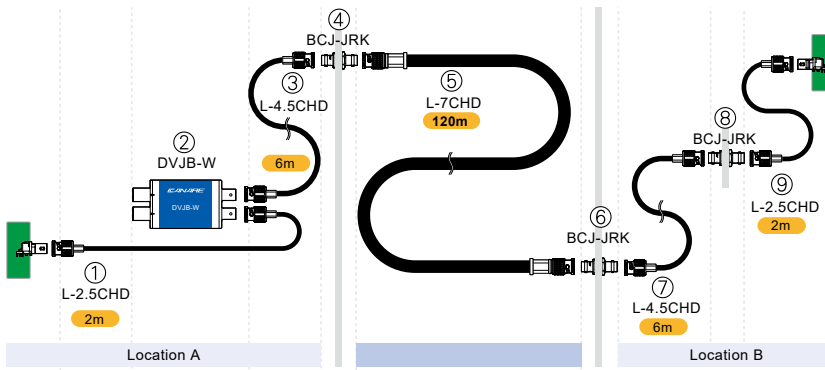

Standards referred to:  
 ST424: 3 Gb/s Signal/Data Serial Interface  
 ST425-1: Single Link 3 Gb/s SDI (2K)  
 ST425-2: Single Link 3 Gb/s SDI (Stereo)  
 ST425-3: Dual Link 3 Gb/s SD for Single Images w/ 6 Gb/s payload (2K/4K)  
 ST425-4: Dual Link 3 Gb/s SDI (Stereo)  
 ST425-5: Quad Link 3 Gb/s SD for Single Images w/ 12 Gb/s payload (4K)  
 ST425-6: Quad Link 3 Gb/s SDI for a Stereo Pair of 6 Gb/s (Stereo/2K/4K)

**Attenuation Graph**

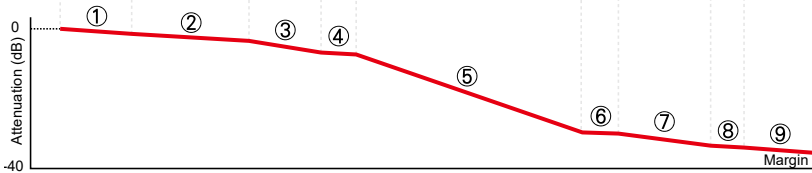

**Typical Value**

Factor	①	②	③	④	⑤	⑥	⑦	⑧	⑨	BNC Plugs	Total (dB)	Limit (dB)	Margin (dB)
Q'ty	2	1	6	1	120	1	6	1	2	10	26.3	30.0	3.7
Unit	m	pcs	m	pcs	m	pcs	m	pcs	m	pcs			
dB/unit	0.431	0.9	0.251	0.2	0.159	0.2	0.251	0.2	0.431	0.1			
dB	0.862	0.9	1.506	0.2	19.08	0.2	1.506	0.2	0.862	1			

**4K/8K: 12G-SDI Single-link or Multi-link**

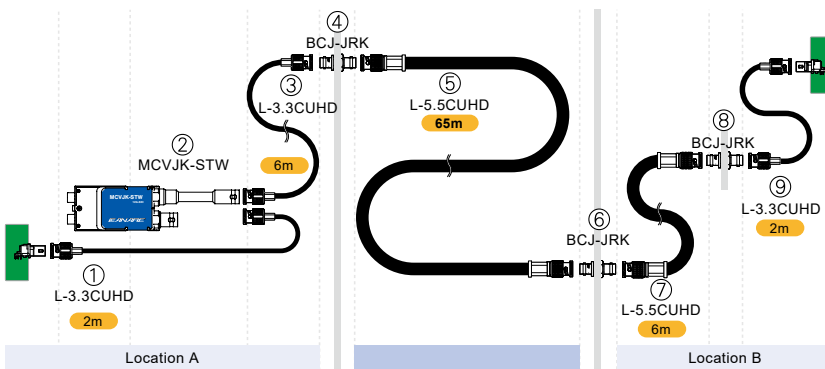

Standards referred to:  
 ST2082-1: 12 Gb/s Signal/Data Serial Interface  
 ST2082-10: Single Link 12 Gb/s SDI (4K)  
 ST2082-11: Dual Link 12 Gb/s SDI for Single Images w/ 24 Gb/s Payload (4K/8K)  
 ST2082-12: Quad Link 12 Gb/s SDI for Single Images w/ 48 Gb/s Payload (4K/8K)

**Attenuation Graph**

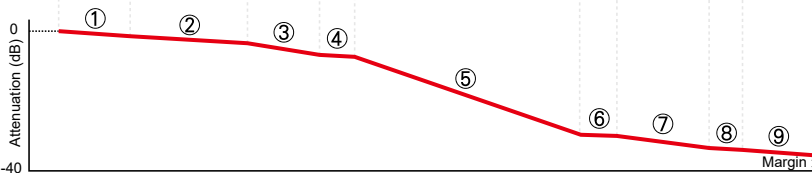

**Typical Value**

Factor	①	②	③	④	⑤	⑥	⑦	⑧	⑨	BNC Plugs	Total (dB)	Limit (dB)	Margin (dB)
Q'ty	2	1	6	1	65	1	6	1	2	10	37.6	40.0	2.4
Unit	m	pcs	m	pcs	m	pcs	m	pcs	m	pcs			
dB/unit	0.685	2	0.685	0.2	0.391	0.2	0.391	0.2	0.385	0.1			
dB	1.37	2	4.11	0.2	25.415	0.2	2.346	0.2	0.77	1			

Technical Trend

Fiber-Optic Systems

Connectors

Cables

Panels & Patchbays

Multichannel Systems

Cable Assemblies

# Fiber - Optic Systems

## Overview

### Trunk Lines at the Moment

#### ■ Migrating to Fiber Optics

Trunk lines carry many different kinds of signals—video, synchronization, audio, control, power supply—and consequently they're usually comprised of numerous different types of cables. As a result, conduits, electrical pits, and ladders tend to overflow with cabling, leaving hardly any room when lines must be added to upgrade or expand the system.

But, converting these disparate signals into optical signals and transmitting them using fiber optic cables greatly reduces the need for so many specialized cables. Converting trunk lines to fiber optics makes it much easier to design and upgrade equipment and systems, because once laid these lines can be used with considerable flexibility. Fiber optic cables also have smaller diameters, meaning they take up less space, a clear advantage in alleviating some of the problems of today's cable-stuffed broadcasting facilities.

#### ■ Sending HD Signals Everywhere

HD-SDI signals can be transmitted only about 100 meters over standard coaxial cables (5C-FB). This means that when wiring rooms and buildings with coaxial cables, it's sometimes difficult to achieve an optimal layout or position equipment where it will be most convenient and useful.

Further, signal transmissions often need to cover unexpectedly long distances, and fiber optic cables, with their transmission distance measured in tens of kilometers, win hands-down over coaxial cables. This flexibility alleviates much of the conventional worry about cable routing and allows the equipment itself to take center stage.

The cost of optical signal converters has dropped radically, too—most can be had for a few hundred dollars—making it difficult these days to find reasons not to introduce fiber optic systems!

### Diversified Needs for Optical Conversion

#### ■ It is not just the HD-SDI signal

It is not just the HD-SDI signal that is converted into optical signals. For example, there is a case in which the HD-SDI signal is converted into optical signals along with the control signal to transmit video images during recording in a studio. Converting various signals into optical signals allows them to be transmitted through fiber-optic cables, eliminating the necessity of separately preparing metal cables.

#### ■ Advantages of Fiber Optic Transmission in the Field

With it now so easy to convert transmissions into optical signals, fiber optic systems are better suited than ever to field recording applications. Newly developed extra-strong, extra-bendable optical fibers have finally reduced past concerns about cable durability, meaning that in applications like remote broadcasting, video, audio and other signals can all be transmitted on a single cable, one of the inherent merits of fiber optic systems.

#### Cable Diameters

Even with 100 cores (lines), a fiber optic cable has an external diameter of just 11.5 mm. Compare that to a typical coaxial cable and the difference is clear.

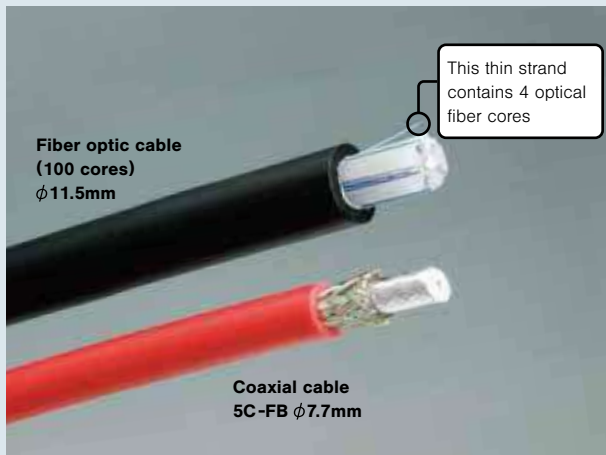

#### Example of an Optical Fiber Trunk Line

Fiber optic systems are used in signal transmissions within a single broadcast station, or between a main building and an annex building.

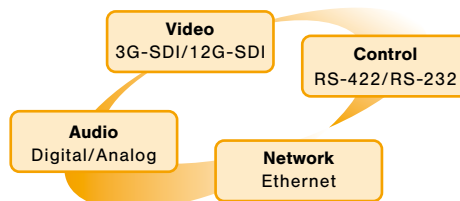
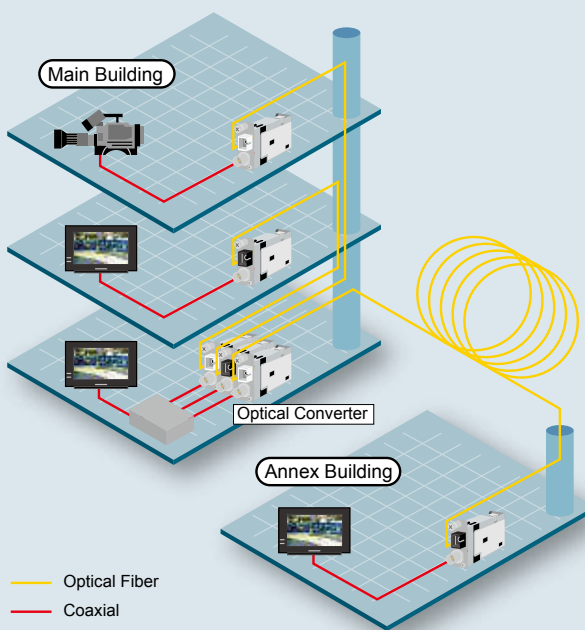

#### Tough & Flexible HFO Camera Cable



(See page 19)



# Fiber - Optic Systems

## Overview

### Wavelength Multiplexing Systems

#### Multiplexing

"Multiplexing" is a technology that allows multiple signals with different wavelengths to be transmitted together over a single optical fiber. Three general types of multiplexing – WDM, CWDM and DWDM – offer increasing signal-carrying capacities, as described below.

#### Wavelength Division Multiplexing (WDM)

WDM is the simplest form of multiplexing and uses two wavelengths of 1310nm and 1551nm. Unlike when using an optical divider, insertion loss can be kept below 0.5dB.

#### Coarse Wavelength Division Multiplexing (CWDM)

CWDM systems use 8 wavelengths (20nm grid) primarily between 1471nm and 1611nm. To these it is also possible to add 8 more between 1271nm and 1451nm to allow a maximum of 16 wavelengths to be carried as a single multiplexed transmission. An ultra-thin membrane filter on the optical multiplexer/demultiplexer (mux/demux) keeps insertion loss at just 2-3dB.

\*CWDM standardized through ITU G695.

#### Optical Converter (TX for CWDM)

Canare's CWDM optical converter uses a DFB laser, which offers a much tighter spectrum than FP lasers. Up to 16 different wavelengths fall within 1271nm and 1611 nm in 20nm intervals.

The wavelengths in the 20nm grid between 1391nm and 1411nm are not used because their proximity to the water peak results in too much attenuation.

**Optical Fiber Transmission Loss Characteristics**

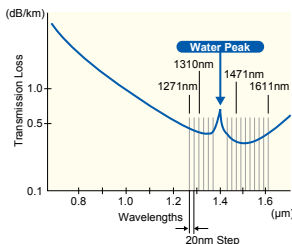

#### Optical Multiplexer/Demultiplexers

The optical signals output from the optical converter (TX) are combined into a single signal by the multiplexer (mux) and transmitted along a single optical fiber. At the receiving end, these combined optical signals are demultiplexed (demux) to split them back into their original component 8 signals.

Optical mux/demuxers are bi-directional, so the same model can be used for transmitting and receiving on each end. It's also possible to use 4 wavelengths out of the 8 for transmitting and the remaining four for receiving. Both 8-wavelength and 16-wavelength models are available, and combining these with an optical converter allows a variety of system constructions with many uses.

#### Optical Converter (RX)

Canare's optical converter (RX) converts an optical signal comprised of 8 different wavelengths into electrical signals. This converter is common to all wavelengths and one converter is required for each wavelength.

Once optical fiber cables have been laid, multiplexing the transmissions carried on them eliminates the need to purchase and install new cables when more transmission lines are needed.

Eight Canare optical converters and an FCWDM-8B mux/demuxer can be installed compactly on a single 161UPSC 1RU-size platform, effectively allowing an 8-wavelength transmission system to be achieved in just 1RU of space.

#### Multiplexing (CWDM)

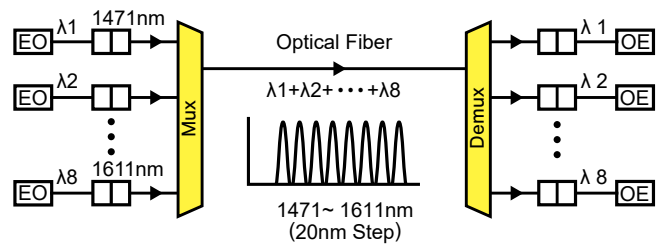

#### 8-wavelength CWDM system example

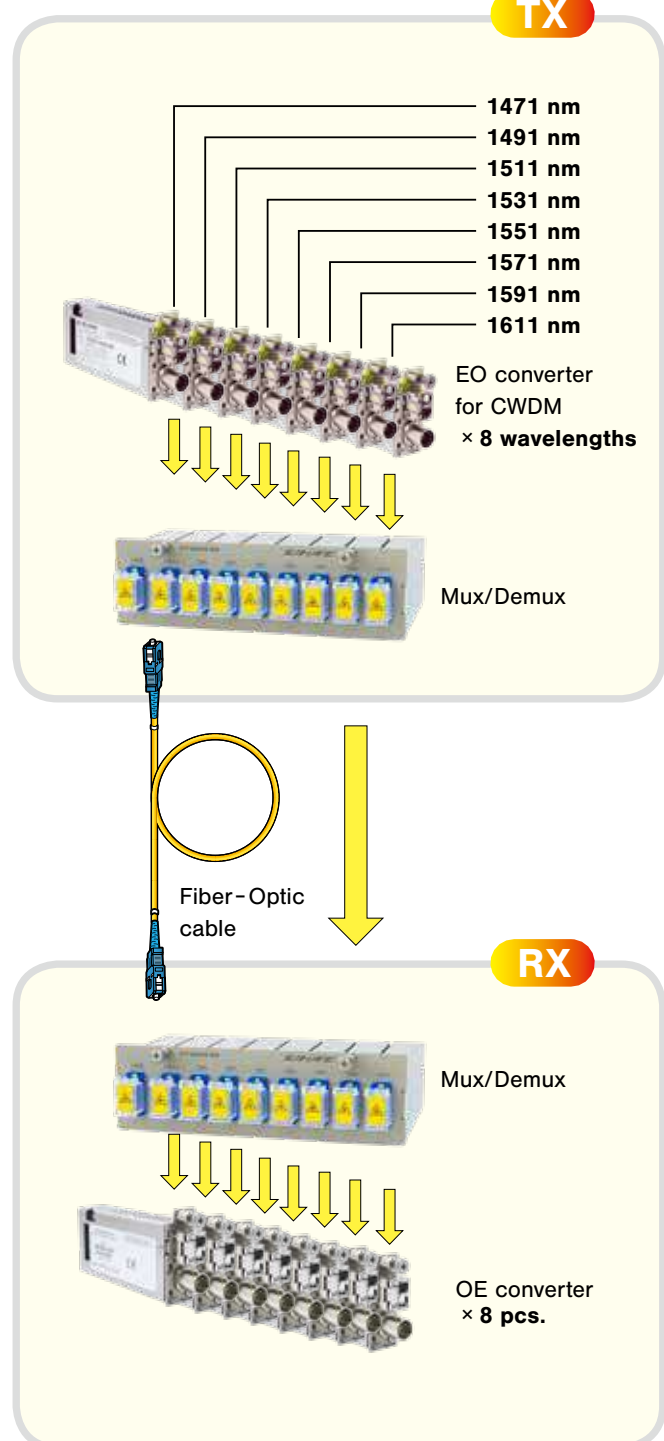

**Note:** Please use with Canare platform.



### 12G-SDI EO/OE Converters

#### Electric to Optic Converter (TX)

Model	Wavelength	Emission	Occupancy
EO12G-100B	1310 nm	-2 dBm	1 slot
<b>New</b> EO12G-100A-**	1271-1451nm for CWDM*	-1 dBm	1 slot

\*Refer to the following information to specify the wavelength and the model number.

#### Optic to Electric Converter (RX)

Model	Wavelength	Sensitivity	Occupancy
OE12G-101B	1260-1650 nm	-13 dBm	1 slot

#### Key Features and Benefits

- Supports 12G/6G/3G/HD/SD-SDI and DVB-ASI
- Capable of Pathological Test Pattern transmission (SMPTE RP-178, 198 Check Field Test Pattern)
- Super low latency
- Compact size
- No complicated settings
- 3-color LED signal indication

#### Specifications

Model	EO12G-100B	EO12G-100A-**	OE12G-101B
Convertibility	Electric to Optic		Optic to Electric
Fiber Type	Single Mode		
Optical Input	N/A		1 × LC
Optical Output	1 × LC		N/A
SDI Input	1 × 75Ω BNC		N/A
SDI Output	N/A		1 × 75Ω BNC
Dimensions	17 × 43.4 × 78.4 mm		
Weight	Approx. 95 g		
Standards	SMPTE ST 2082-1, 2081-1, 424, 297-1, 292-1, 259, EN50083-9		



EO12G-100B

12G-SDI



OE12G-101B

12G-SDI

#### Ordering Information for EO12G-100A-\*\*

EO12G-100A- [27] Wavelength

27	1271nm
29	1291nm
31	1311nm
33	1331nm
35	1351nm
37	1371nm
43	1431nm
45	1451nm



EO12G-100A-\*\*

12G-SDI

Note: Platform is required for power supply (page 14).

### 12G-SDI Repeater

Equalizes and reclocks SDI signals to extend the transmission distance over a coaxial cable.

Model	Supporting Signals	Occupancy
EE12G-100	12G/6G/3G/HD/SD-SDI, DVB-ASI	1 slot

#### Key Features and Benefits

- Supports 12G/6G/3G/HD/SD-SDI and DVB-ASI
- 12G-SDI cable equalization: 100 m over L-5.5CUHD (Typ.)
- 3-color LED signal indication
- Allows for efficient use of existing cable infrastructure.

#### Specifications

I/O Connectors	2 × 75Ω BNC
Standards	SMPTE ST 2082-1, 2081-1, 424, 292-1, 259, EN50083-9



EE12G-100

12G-SDI

Dimensions: 17 × 43.4 × 78.4 mm  
Weight: 85g

#### Example of Use

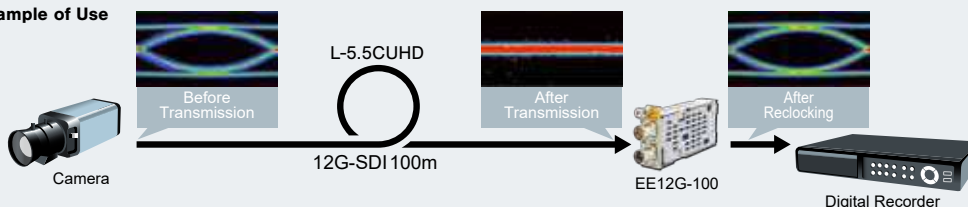

Note: Platform is required for power supply (page 14).

Technical Trend

Fiber-Optic Systems

Connectors

Cables

Panels & Patchbays

Multichannel Systems

Cable Assemblies

# Fiber - Optic Systems

## EO/OE Converters

### 3G-SDI EO/OE Converters

#### Electric to Optic Converter (TX)

Model	Wavelength	Emission	Monitor Out	Occupancy
EO3G-100	1310 nm	-2.5 dBm	No	1 slot
EO3G-200	1310 nm	-2.5 dBm	Yes	2 slots
EO3G-100A-**	1271 - 1611 nm for CWDM*	+2.5 dBm	No	1 slot

\*Refer to the following information to specify the wavelength and the model number.

#### Optic to Electric Converter (RX)

Model	Wavelength	Sensitivity	Dual Out	Occupancy
OE3G-101	1200 - 1620 nm	-22 dBm	No	1 slot
OE3G-201	1200 - 1620 nm	-22 dBm	Yes	2 slots

#### Key Features and Benefits

- Supports 3G/HD/SD-SDI and DVB-ASI
- Capable of Pathological Test Pattern transmission (SMPTE RP-178, 198 Check Field Test Pattern)
- Super low latency
- Compact size
- No complicated settings
- Cost effective

#### Specifications

Model	EO3G-100	EO3G-200	EO3G-100A	OE3G-101	OE3G-201
Convertibility	Electric to Optic			Optic to Electric	
Optical Connector	1 × LC (output)			1 × LC (input)	
Fiber Type	Single Mode				
SDI Input	1 × 75Ω BNC	1 × 75Ω BNC	1 × 75Ω BNC	N/A	N/A
SDI Output	N/A	1 × 75Ω BNC (no-reclocked)	N/A	1 × 75Ω BNC	2 × 75Ω BNC
Dimensions (mm)	17 × 43.4 × 78.4	35.5 × 43.4 × 78	17 × 43.4 × 78.4	17 × 43.4 × 78.4	35.5 × 43.4 × 78
Weight (approx.)	100 g	150 g	95 g	100 g	150 g
Standards	SMPTE ST 259, 292-1, 297-1, 424, EN50083-9				



EO3G-100



EO3G-200  
(with Monitor Output)



OE3G-101



OE3G-201  
(with Dual Output)

#### Ordering Information for EO3G-100A-\*\*

EO3G-100A-**27** - Wavelength



EO3G-100A-\*\*

<b>27</b>	1271nm	<b>47</b>	1471nm
<b>29</b>	1291nm	<b>49</b>	1491nm
<b>31</b>	1311nm	<b>51</b>	1511nm
<b>33</b>	1331nm	<b>53</b>	1531nm
<b>35</b>	1351nm	<b>55</b>	1551nm
<b>37</b>	1371nm	<b>57</b>	1571nm
<b>43</b>	1431nm	<b>59</b>	1591nm
<b>45</b>	1451nm	<b>61</b>	1611nm

Note: Platform is required for power supply (page 14).

## Technical Note

### Jitter

The timing deviation of the periodic signal waveform is called jitter. For serial data signals such as SDI signals, jitter occurs due to the deviation of reference clock signal, reflection caused by connection through coaxial cables or between devices, loss of DC and high frequency components, the influence of noise from the equipment itself or from the outside. In the worst case, an error occurs in clock data recovery due to this jitter and that with SDI signals, noise may appear on the screen or signal transmission may come to be fail.

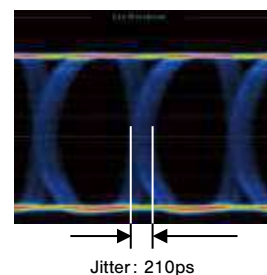
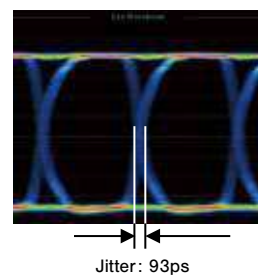

**AES 3id Optical Converters**

Model	Wavelength	Emission	Sensitivity	Occupancy
EO-500-**	1471-1611 nm for CWDM*	-3 dBm	N/A	5 slots
OE-501	1200-1620 nm	N/A	-26 dBm	

\* Refer to the following information to specify the wavelength.

**Key Features and Benefits**

- Multiplex and optically convert AES signals from up to 8 ports (16 audio channels) to allow them to be transmitted over long distance.
- Supports 8 wavelengths CWDM; enables max. 64 ports (128 audio channels) signals to transmit over a single optical fiber.
- AES-3id-1995 and SMPTE 276M
- Fully asynchronous multiplex transmission.
- Word clock can be transmitted (30kHz to 50kHz).
- Dolby-E compatible

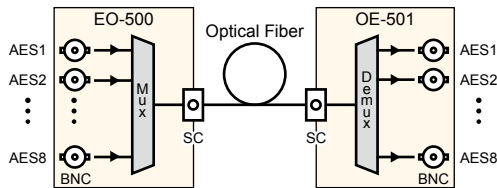

**Specifications**

Model	EO-500-**	OE-501
Convertibility	Electric to Optic	Optic to Electric
Fiber Type	Single Mode	
Optic Connector	1 × SC (output)	1 × SC (input)
AES I/O Connector	8 × 75Ω BNC (input)	8 × 75Ω BNC (output)
Dimensions	91 × 43.4 × 76.2 mm	
Weight	174 g	
Standards	AES-3id-1995, SMPTE ST 276	



EO-500-55



OE-501

**Ordering Information for EO-500-\*\***

EO-500-47	Wavelength
47	1471nm
49	1491nm
51	1511nm
53	1531nm
55	1551nm
57	1571nm
59	1591nm
61	1611nm

Note: Platform is required for power supply (page 14).

**Analog Audio Optical Converters**

Model	Wavelength	Occupancy	Remark
TRM-540	1310 nm	5 slots	Work with TRM-541.
TRM-541	1550 nm		Work with TRM-540.
TRM-540A-**	1471-1611 nm for CWDM (*1)		Work with TRM-540A-** of a different wavelength (*2).

\*1) Refer to the following information to specify the wavelength and the model number.  
\*2) TRM-540A-\*\* does not work with TRM-540 or TRM-541.

**Key Features and Benefits**

- Enables line level audio signals to transmit long distance over a fiber-optic cable.
- 8 channel transmission (4-channel inputs/4-channel outputs)
- Maximum input/output voltage: +24 dBu (balanced)
- Supports 600Ω input by each channel with selector switches.

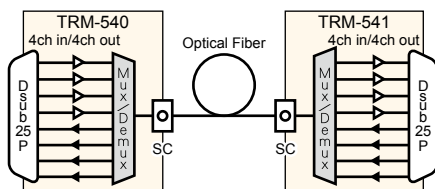

Block Diagram of TRM-540 and TRM-541

**Specifications**

Model	TRM-540, TRM-541	TRM-540A-**
Fiber Type	Single Mode	
Optic I/O Connector	1 × SC	2 × LC
Audio I/O Connector	1 × D sub 25 pin (F)	
Frequency Response	20 Hz - 40 kHz (-3 dB, +0.1 dB)	
Dimensions	91 × 43.4 × 78.4 mm	
Weight	265 g	



TRM-540



TRM-540A-\*\*

**Ordering Information for TRM-540A-\*\***

TRM-540A-47	Wavelength
47	1471nm
49	1491nm
51	1511nm
53	1531nm
55	1551nm
57	1571nm
59	1591nm
61	1611nm

Note: Platform or Stand Alone Kit required for power supply (page 14).

Technical Trend

Fiber-Optic Systems

Connectors

Cables

Panels & Patchbays

Multichannel Systems

Cable Assemblies

# Fiber - Optic Systems

## EO/OE Converters

### 1000BASE-T Optical Converters

Model	Wavelength	Occupancy	Remark
TRM-300-G31	1310 nm	2 slots	Work with TRM-300-G55.
TRM-300-G55	1550 nm		Work with TRM-300-G31.
TRM-300A-G**	1471-1611 nm for CWDM (*1)		Work with TRM-300A-G** of a different wavelength (*2).

\*1) Refer to the following information to specify the wavelength and the model number.  
\*2) TRM-300A-G\*\* does not work with TRM-300-G31 or TRM-300-G55.



TRM-300-G31

TRM-300A-G\*\*

#### Key Features and Benefits

- Media converters for Gigabit Ethernet 1000BASE-T\*  
\*No backwards compatibility with other Ethernet standards such as 100BASE-TX.
- Super-low latency: less than 1 micro-second.
- Extends communications up to 20 km (condition: line loss 0.5 dB/km)
- Bi-directional optical communication

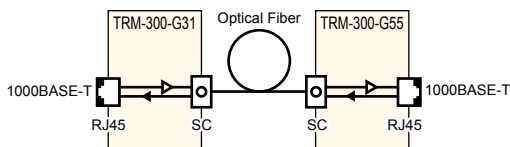

Block Diagram of TRM-300-G31 and TRM-300-G55

#### Specifications

Model	TRM-300-G31, TRM-300-G55	TRM-300A-G**
Fiber Type	Single Mode	
Optic I/O Connector	1 × SC	2 × LC
Ethernet I/O Connector	1 × RJ45	
Dimensions	35.5 × 43.4 × 76 mm	
Weight (approx.)	155 g	
Standards	IEEE 802.3ab (1000BASE-T)	

#### Ordering Information for TRM-300A-G\*\*

TRM-300A-G	Wavelength
47	1471nm
49	1491nm
51	1511nm
53	1531nm
55	1551nm
57	1571nm
59	1591nm
61	1611nm

Note: Platform is required for power supply (page 14).

### 100BASE-TX Optical Converters

Model	Wavelength	Occupancy	Remark
TRM-210	1310 nm	2 slots	Work with TRM-211.
TRM-211	1550 nm		Work with TRM-210.
TRM-210A-**	1471-1611 nm for CWDM (*1)		Work with TRM-210A-** of a different wavelength (*2).

\*1) Refer to the following information to specify the wavelength and the model number.  
\*2) TRM-210A-\*\* does not work with TRM-210 or TRM-211.



TRM-210

TRM-210A-\*\*

#### Key Features and Benefits

- Media converters for Fast Ethernet 100BASE-TX\*  
\*No backwards compatibility with other Ethernet standards such as 10BASE-T.
- Auto MDI/MDX
- Extends communications up to 30 km (condition: line loss 0.5 dB/km)
- Bi-directional optical communication

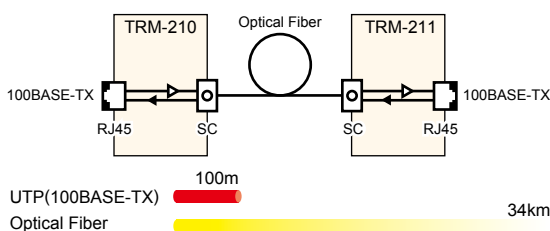

Block Diagram of TRM-210 and TRM-211

#### Specifications

Model	TRM-210, TRM-211	TRM-210A-**
Fiber Type	Single Mode	
Optic I/O Connector	1 × SC	2 × LC
Ethernet I/O Connector	1 × RJ45	
Dimensions	35.5 × 43.4 × 76.2 mm	
Weight (approx.)	103 g	110 g
Standards	IEEE 802.3u (100BASE-TX)	

#### Ordering Information for TRM-210A-\*\*

TRM-210A-	Wavelength
47	1471nm
49	1491nm
51	1511nm
53	1531nm
55	1551nm
57	1571nm
59	1591nm
61	1611nm

Note: Platform is required for power supply (page 14).

RS-422/RS-232 Optical Converters

Model	Wavelength	Occupancy	Remark
TRM-220	1310 nm	3 slots	Work with TRM-221.
TRM-221	1550 nm		Work with TRM-220.
TRM-220A-**	1471-1611 nm for CWDM (*1)		Work with TRM-220A-** of a different wavelength (*2).

\*1) Refer to the following information to specify the wavelength and the model number.  
 \*2) TRM-220A-\*\* does not work with TRM-220 or TRM-221.

Key Features and Benefits

- TIA-422, SMPTE ST 207, RS-232
- Usable in a case of RS-422 <=> RS-232
- Extends communications up to 30 km (condition: line loss 0.5 dB/km)
- Bi-directional optical communication

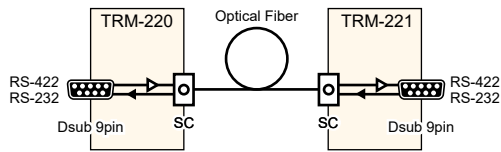

Block Diagram of TRM-220 and TRM-221

Specifications

Model	TRM-220, TRM-221	TRM-220A-**
Fiber Type	Single Mode	
Optic I/O Connector	1 x SC	2 x LC
Serial I/O Port	1 x Dsub 9 pin (F)	
Max. Data Rate	RS-422: 10 Mbps, RS-232: 1 Mbps	
Dimensions	54 x 43.4 x 76.2 mm	
Weight (approx.)	110 g	120 g
Standards	TIA-422, SMPTE ST 207, RS-232C	



TRM-220



TRM-220A-\*\*

Ordering Information for TRM-220A-\*\*

TRM-220A- [47]	Wavelength
47	1471nm
49	1491nm
51	1511nm
53	1531nm
55	1551nm
57	1571nm
59	1591nm
61	1611nm

Note: Platform is required for power supply (page 14).

More Converters

Model	Occupancy
TRM-100	3 slots
TRM-101	

Multiplex and optically convert HD-SDI and RS-485 signal to transmit long distance over a fiber-optic cable. Suited for HD surveillance camera system.

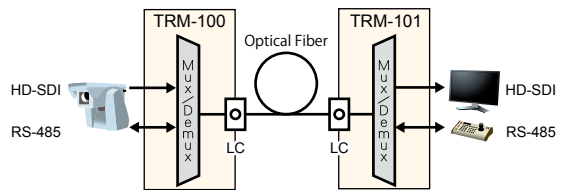

Model	Occupancy
TRM-400	3 slots
TRM-401	

Multiplex and optically convert analog video, stereo audio, RS-422, and relay signals to transmit long distance over a fiber-optic cable.

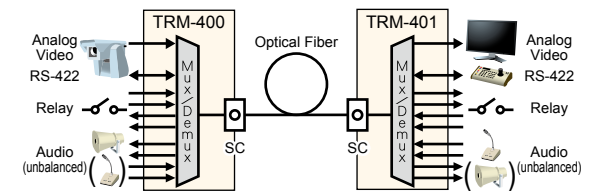

Model	Occupancy
TRM-230	3 slots
TRM-231	

Multiplex and optically convert 7 of each input/output relay signal and RS-422/232 signals to transmit long distance over a fiber-optic cable.

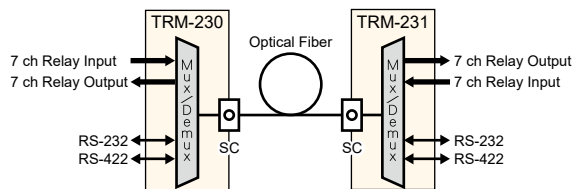

Note: Platform or Stand Alone Kit required for power supply (page 14).

Technical Trend

Fiber-Optic Systems

Connectors

Cables

Panels & Patchbays

Multichannel Systems

Cable Assemblies

# Fiber - Optic Systems

## Mux/Demux, Splitter

### CWDM Mux/Demux

#### Slot-in Module Types

Model	Ch.	Wavelengths	Occupancy
FCWDM - 8B	8	1471 - 1611 nm	8 slots
FCWDM - 8B - 13	8	1271 - 1451 nm	

#### Rack Mount Types

Model	Ch.	Wavelengths	Size
FCWDM8/1A	8	1471 - 1611 nm	1RU
FCWDM8/1A - 13	8	1271 - 1451 nm	
FCWDM8/2A	2 each of 8	2 each of 1471 - 1611 nm	
FCWDM8/2A - 13	2 each of 8	2 each of 1271 - 1451 nm	
FCWDM16A	16	1271 - 1611 nm	

#### Key Features and Benefits

- Bi-directional 8 or 16 wavelengths.
- Passive and stand-alone products.
- Easy to use - Just plug in SC-type connectors.
- FCWDM-8B(-13) can be loaded into 161UPSC; enables 8-wavelength CWDM within 1RU frame.

#### <Loading example (rear view of 161UPSC)>

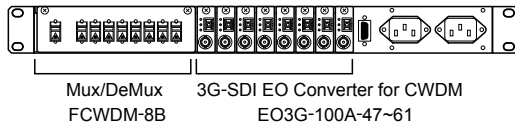

#### Specifications

Model	FCWDM - 8B (-13)	FCWDM8/1A (-13)	FCWDM8/2A (-13)	FCWDM16A
Connectors	SC			
Passband	+/- 6.5 nm (ITU-T G.695)			
Min. Passband Ripple	0.5 dB			
Max. Insertion Loss*	2.0 dB			3.3 dB
Min. Isolation	30 dB			
Dimensions (mm)	146 x 43.4 x 94.2	482.6 x 44 x 362.3		
Weight (approx.)	210 g	1700 g	1800 g	1890 g
Wavelengths Details (nm)	1271 - 1451: 1271/1291/1311/1331/1351/1371/1431/1451 1471 - 1611: 1471/1491/1511/1531/1551/1571/1591/1611			

\* Insertion loss includes ripple, PDL, and connector loss



FCWDM-8B



FCWDM8/1A (Rear View)



FCWDM8/2A (Rear View)



FCWDM16A (Rear View)

### Optical Splitter

Model	Wavelength	Description
FDM - 2	1261 - 1611nm	1 x 2 Splitter for Single Mode Fiber
FDM - 4		1 x 4 Splitter for Single Mode Fiber

#### Key Features and Benefits

- Divides single optical input into multiple optical output.
- Passive and stand-alone products.
- Can be loaded into platform for Canare plug-in unit.
- Easy to use - Just plug in SC-type connectors.
- Low insertion loss.

#### Insertion Loss

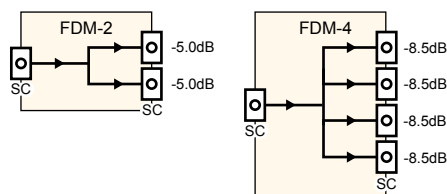

FDM-2

Slot Occupancy: 3 slots  
Dimensions: 54 x 43.4 x 82 mm  
Weight: 83g



FDM-4

Slot Occupancy: 4 slots  
Dimensions: 72 x 43.4 x 82 mm  
Weight: 110g

**Platform**

**Power supply for Canare plug-in modules. The robust 1RU rack mountable and space efficient portable types are available.**

Model	Description	Number of Slots
<b>161UPSC-**</b>	1RU rack mount type	16
<b>6PSC-**</b>	Portable type	6
<b>2PSC</b>	Palm size	2
<b>PSM2-**</b>	Redundant power supply module for 161UPSC	N/A

**Note:** 161UPSC shall be used in countries where CE marking directive is not applied. Contact Canare for details.

**Key Features and Benefits**

- Compact design - Maximum 16 modules within 1RU
- Hot swappable
- 161UPSC can be output 4 types of alarm signals via Dsub 9P (F).
- 161UPSC provides power redundancy by adding a PSM2.

**Specifications**

Model	161UPSC	6PSC	2PSC
<b>Number of Slots</b>	16	6	2
<b>AC Input Voltage</b>	100 to 240V 50/60Hz 0.35A		N/A
<b>DC Input Voltage</b>	N/A	10 to 18V	10 to 18V
<b>Max Power Consumption (exclusive of modules)</b>	22W	4.5W (AC) 2.2W (DC)	2.2W
<b>Power Connector</b>	AC3P Jack	AC3P Jack (AC) XLR4 Male (DC)	XLR4 Male
<b>Supply Voltage to Module</b>	DC 5V		
<b>Operating Temperature</b>	- 10 to 40 deg C		



**161UPSC-\*\***  
Dimensions: 434 × 44 × 340 mm  
Weight: 4500g



**6PSC-\*\***  
Dimensions: 210 × 44 × 165 mm  
Weight: 650g



**2PSC**  
Dimensions: 90 × 44 × 110 mm  
Weight: 200g

**10- slot portable platform is also available.**



**10PSA-JP**  
Dimensions: 210 × 44 × 280 mm  
Weight: 1200 g

**Stand Alone Kit New**

Model	For	Description
<b>WMM0190</b>	TRM with power input (TRM- 100/230/400/540)	a clamping bracket (one side)
<b>WEPZ0258</b>		AC 100 -240V to DC 5V adapter, Plug Type A No CE marking

**Key Features and Benefits**

- Operates a TRM converter without a Platform.
- Simple and cost-effective method
- Used in combination of two WMM0190 and WEPZ0258.



**WMM0190**



**2 of WMM0190 with TRM**



**WEPZ0258**

# Fiber - Optic Systems

## HFO Transmission Devices

### HFO Transmission Device (Quad-link)

Transmit 4-channel SDI over a HFO camera cable.

■ **FCBK4-12G** **12G-SDI** **New** Support 12G/6G/3G/HD/SD-SDI and DVB-ASI

Model	HFO Connector	EO/OE Modules	EXT Connector	IDX V-plate
<b>FCBK4-FF5W1-12G</b>	FCFRA (Female)	4 × OE12G-101B (RX)	XLR5 Female	No
<b>FCBK4-FF5W1-12G-PV</b>	FCFRA (Female)	4 × OE12G-101B (RX)	XLR5 Female	Yes
<b>FCBK4-FM5W2-12G</b>	FCMRA (Male)	4 × EO12G-100A-** (TX)	XLR5 Male	No
<b>FCBK4-FM5W2-12G-PV</b>	FCMRA (Male)	4 × EO12G-100A-** (TX)	XLR5 Male	Yes

**FCBK4-FM5W2-12G**



**FCBK4-FF5W1-12G**

■ **FCBA4-3G** Support 3G/HD/SD-SDI and DVB-ASI

Model	HFO Connector	EO/OE Modules	EXT Connector	IDX V-plate
<b>FCBA4-FF5W1</b>	FCFRA (Female)	4 × OE3G-101 (RX)	XLR5 Female	No
<b>FCBA4-FF5W1-PV</b>	FCFRA (Female)	4 × OE3G-101 (RX)	XLR5 Female	Yes
<b>FCBA4-FM5W2</b>	FCMRA (Male)	4 × EO3G-100A-** (TX)	XLR5 Male	No
<b>FCBA4-FM5W2-PV</b>	FCMRA (Male)	4 × EO3G-100A-** (TX)	XLR5 Male	Yes



(rear view)

#### Key Features and Benefits

- All-in-one device which combines four EO/OE modules and a power supply unit.
- The best solution for Quad-link 12G/3G-SDI outside broadcasting.
- Flexible configuration by replacing EO/OE modules.
- AC and DC input redundancy
- Optical SC connector for optional use

\* Canare OC series (Hybrid-OPS profile) is also available. Please contact us for more details.

**FCBA4-FM5W2**



**FCBA4-FF5W1**



**FCBA4-FM5W2-PV**

#### Specifications

Type	without V-plate	with V-plate
<b>SDI connector</b>	4 × 75Ω BNC	
<b>Optical connector</b>	SC (for optional use)	
<b>AC input</b>	AC 3P Jack	
<b>DC input</b>	XLR4-32-F77 (Male)	
<b>Power requirement</b>	AC 100-240 V, DC 10-18 V	
<b>Operating Temp.</b>	-10 to 40 deg C	
<b>Dimensions</b>	210 × 42 × 240 mm	
<b>Weight</b>	1800 g	1850 g

<Example of Use>

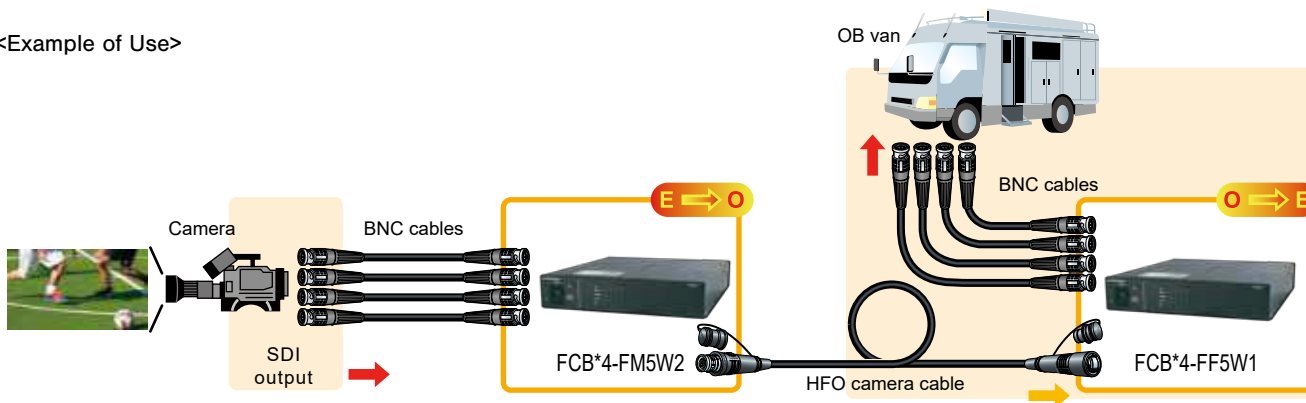



**HFO Transmission Device (Bi-directional)**

Transmit 2-channel SDI over a HFO camera cable.

■ **FCBK-12G** **12G-SDI** **New** Support 12G/6G/3G/HD/SD-SDI and DVB-ASI

Model	HFO Connector	EO/OE Modules	EXT Connector	IDX V-plate
<b>FCBK-FF3W1-12G</b>	FCFRA (Female)	EO12G-100B (TX) OE12G-101B (RX)	2 × XLR3 Female	No
<b>FCBK-FF3W1-12G-PV</b>	FCFRA (Female)	EO12G-100B (TX) OE12G-101B (RX)	2 × XLR3 Female	Yes
<b>FCBK-FM3W2-12G</b>	FCMRA (Male)	EO12G-101B (RX) EO12G-100B (TX)	2 × XLR3 Male	No
<b>FCBK-FM3W2-12G-PV</b>	FCMRA (Male)	EO12G-101B (RX) EO12G-100B (TX)	2 × XLR3 Male	Yes

**FCBK-FM3W2-12G**



**FCBK-FF3W1-12G**

■ **FCBA-3G** Support 3G/HD/SD-SDI and DVB-ASI

Model	HFO Connector	EO/OE Modules	EXT Connector	IDX V-plate
<b>FCBA-FF3W1-3G</b>	FCFRA (Female)	EO3G-100 (TX) OE3G-101 (RX)	2 × XLR3 Female	No
<b>FCBA-FF3W1-3G-PV</b>	FCFRA (Female)	EO3G-100 (TX) OE3G-101 (RX)	2 × XLR3 Female	Yes
<b>FCBA-FM3W2-3G</b>	FCMRA (Male)	EO3G-101 (RX) EO3G-100 (TX)	2 × XLR3 Male	No
<b>FCBA-FM3W2-3G-PV</b>	FCMRA (Male)	EO3G-101 (RX) EO3G-100 (TX)	2 × XLR3 Male	Yes



(rear view)

**Key Features and Benefits**

- All-in-one device which combines two EO/OE modules and a power supply unit.
- Ideal for outside broadcasting.
- Flexible configuration by replacing EO/OE modules.
- AC and DC input redundancy

\* Canare OC series (Hybrid-OPS profile) is also available. Please contact us for more details.

■ **Specifications**

Type	without V-plate	with V-plate
<b>SDI connector</b>	2 × 75Ω BNC	
<b>AC input</b>	AC 3P Jack	
<b>DC input</b>	XLR4-32-F77 (Male)	
<b>Power requirement</b>	AC 100-240 V, DC 10-18 V	
<b>Operating Temp.</b>	-10 to 40 deg C	
<b>Dimensions</b>	210 × 42 × 240 mm	
<b>Weight</b>	<b>FCBK-12G</b>	1400 g
	<b>FCBA-3G</b>	1200 g

**FCBA-FM3W2-3G**



**FCBA-FF3W1-3G**



**FCBA-FM3W2-3G-PV**

<Example of Use>

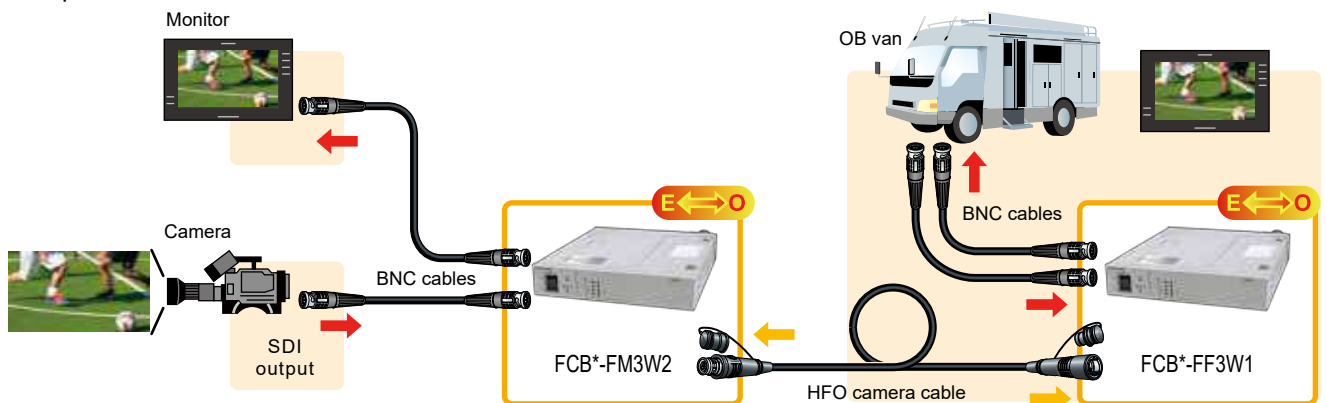

# Fiber - Optic Systems

## HFO Camera Cables

### Hybrid Fiber-optic Camera Cables (SMPTE ST 311)

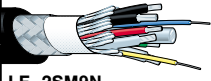
Type	Model	Sales Units (m)	Nom. O.D. (mm)	Weight kg/100m	Outer Jacket	Overall Shield	Tension Tolerance (N)	Strength Member O.D. (mm)	Min. Bend Radius	Temp. Range (deg C)	Channel Unit		
											Fiber	Aux. (Power)	Signal (Control)
 <b>LF-2SM9N</b> Jacket color: <b>BLK</b>	<b>LF-2SM9N</b>	Call	9.2	12.0	Abrasion-resistance PVC	9/24/0.10TA 91%	700	2.6	6 × Nom. O.D.	-40 to +75	2 × SM 9/125 (low-water-peak) Unit O.D. 0.9 mm	4 × 20 AWG 21 / 0.18TA Unit O.D. 1.7 mm	2 × 25 AWG 7 / 0.18TA Unit O.D. 1.2 mm
	<b>LF-2SM16</b>		16	29.0	Double PVC								

#### LF-2SM9N

- For general use.
- Abrasion-resistance Jacket enhance the adaptability to all studio and outside broadcast applications.
- Cost effective



#### LF-2SM16

- For studio use.
- O.D. 16mm Double Jacket prevents the cable from being jammed under a camera pedestal dolly.

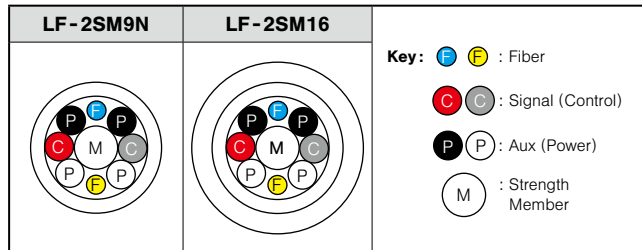
#### Cross Section



#### Camera to CCU

Type	Model	Length (m)
 Jacket color: <b>BLK</b>	<b>FCC10N</b>	10
	<b>FCC20N</b>	20
	<b>FCC25N</b>	25
	<b>FCC35N</b>	35
	<b>FCC50N</b>	50
	<b>FCC100N</b>	100
 Jacket color: <b>BLK</b>	<b>FCC150N</b>	150
	<b>FCC200N</b>	200
	<b>FCC30A-WJ</b>	30
	<b>FCC50A-WJ</b>	50
	<b>FCC100A-WJ</b>	100

- Standard and widely-used models.
- Heat shrink tubes help in labeling.
- FCC\*\*A-WJ prevents the cable from being jammed under a camera pedestal dolly by its O.D. 16mm double jacket.
- 7-color connector rings included.

\* Canare OC series (Hybrid-OPS profile) is also available. (see page 21)



FCFA



FCMA



Color Rings

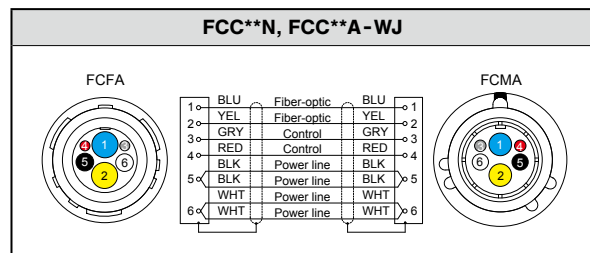

Wiring Diagram

### HFO Protective Covers New

#### Any-time-fit-on protector for SMPTE connector - the new traditional

Model	Shape	Component	Color
<b>FC-CV-F-SET-**</b>	Female	1 × Boot	RD: <b>Red</b> GR: <b>Green</b> YL: <b>Yellow</b> BK: <b>Black</b>
<b>FC-CV-M-SET-**</b>	Male	1 × Holder	

Please specify the color such as FC-CV-F-SET-RD

Cover: PVC, Holder: PE

- Canare exclusive retrofittable construction (patent pending)
- Fit for Canare FC series and other SMPTE 304 plugs
- Heavy-duty and harsh environment applications
- Quality verified over shock resistance tests

\* Not available for Canare OC series

\* The male and female are for FCMA and FCFA or equivalent respectively.

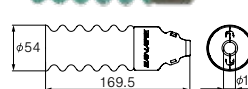

FC-CV-F-SET-GR



FC-CV-M-SET-RD

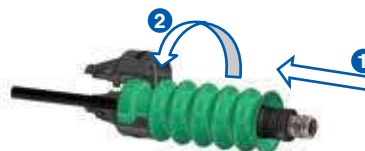

**Slim Hybrid Fiber-optic Camera Cable**

Type	Model	Sales Units (m)	Nom. O.D. (mm)	Weight kg/100m	Outer Jacket	Overall Shield	Tension Tolerance (N)	Strength Member O.D. (mm)	Min. Bend Radius	Temp. Range (deg C)	Channel Unit		
											Fiber	Aux. (Power)	Signal (Control)
	<b>LF-2SM7N</b>	Call	7.1	7.3	Abrasion-resistance PVC	8/24/0.10TA 91%	300	1.4	6 × Nom. O.D.	-40 to +75	2 × SM 9/125 (low-water-peak) Unit O.D. 0.9 mm	2 × 20 AWG 21 / 0.18TA Unit O.D. 1.7 mm	2 × 25 AWG 7 / 0.18A Unit O.D. 1.2 mm

Jacket color: **BLK**

**LF-2SM7N**

- O.D. 7 mm of slim profile and approx. 40% lighter than LF-2SM9N.
- Best fit for mobile applications.
- The power transmission distance is approx. twice as long as the previous model LF-2SM7R.

**Note:** The power transmission distance is shorter than typical HFO camera cables (approx. 50% of LF-2SM9N). Please contact us for more information.

**Cross Section**

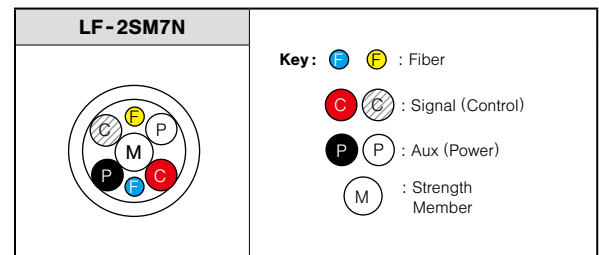

**FCF7A**



**FCM7A**



**Color Rings**

**Camera to CCU**

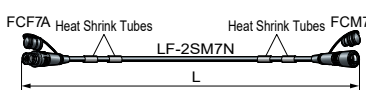
Type	Model	Length (m)
	<b>FCC10-7N</b>	10
	<b>FCC20-7N</b>	20
	<b>FCC30-7N</b>	30
	<b>FCC50-7N</b>	50
	<b>FCC100-7N</b>	100

Jacket color: **BLK**

- Equipped with slim and lightweight cable.
- FCC100-7N is approx. 5 kg lighter than typical 100m HFO camera cable as FCC100N.
- Heat shrink tubes help in labeling.
- 7-color connector rings included.

**Note:** The power transmission distance of FCC\*\*-7N is approx. half of that of the FCC\*\*N. \* Canare OC series (Hybrid-OPS profile) is also available. (see page 21)

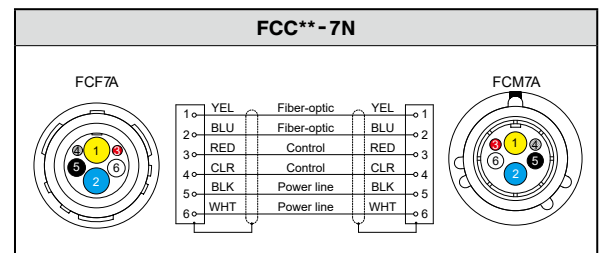

Wiring Diagram





**FCC\*\*-7N**

# Fiber - Optic Systems

## HFO Camera Cables

### Tough & Flexible HFO Camera Cables

Thermoplastic polyurethane type jacket offers amazing flexibility and superior mechanical properties; Crush Resistance, Impact Resistance and Cyclic Flexing exceed that of MIL.

Type	Model	Sales Units (m)	Nom. O.D. (mm)	Weight kg/100m	Outer Jacket	Overall Shield	Tension Tolerance (N)	Strength Member O.D.	Min. Bend Radius	Temp. Range (deg C)	Channel Unit		
											Fiber	Aux. (Power)	Signal (Control)
	<b>LF-2SM9T</b>	Call	9.2	9.8	TPU + PVC	N/A	1500	1.8 mm + Tensile strength fiber	Equal to Nom. O.D.	-40 to +75	2 x SM 9/125 (low-water-peak) Unit O.D. 0.9 mm	4 x 20 AWG 102 / 0.08A Unit O.D. 1.75 mm	2 x 25 AWG 24 / 0.08A Unit O.D. 1.2mm
	<b>LF-2SM7T</b>	Call	7.1	5.5	TPU + PVC	N/A	1000	0.63 mm + Tensile strength fiber	Equal to Nom. O.D.	-40 to +75	2 x SM 9/125 (low-water-peak) Unit O.D. 1.7 mm	2 x 23 AWG 60 / 0.08A Unit O.D. 1.4 mm	2 x 26 AWG 30 / 0.08A Unit O.D. 1.1 mm

#### LF-2SM9T

- Heavy-duty yet Flexible.
- Ideal for remote broadcast applications.
- Minimum bend radius: 9.2 mm.

#### LF-2SM7T

- Flexible, Slim, Lightweight, and moreover, Heavy-duty.
- Ideal for short-distance remote broadcast applications of up to 200 meters.
- O.D. 7.1 mm and weighing only 5.5 kg/100 m, it's so easy to carry around.
- Minimum bend radius: 7.1 mm.
- Fiber units include tensile strength fiber.

**Note:** The power supply distance of LF-2SM7T is shorter than other HFO camera cables. (approx. 30% of LF-2SM9N)  
LF-2SM7T requires a special technique during a connector assembly, so you can buy the cable assemblies shown below.

#### Cross Section

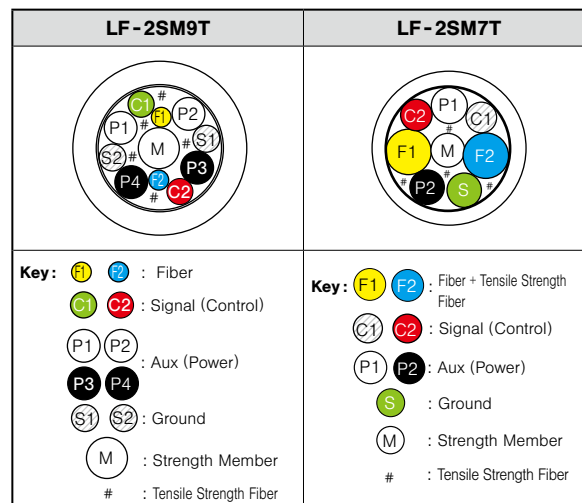

#### Camera to CCU

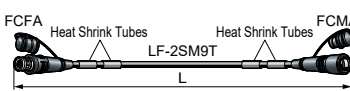
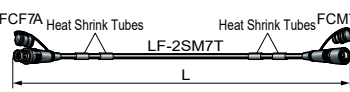
Type	Model	Length (m)
	<b>FCC10-9T</b>	10
	<b>FCC20-9T</b>	20
	<b>FCC25-9T</b>	25
	<b>FCC35-9T</b>	35
	<b>FCC50-9T</b>	50
	<b>FCC100-9T</b>	100
	<b>FCC150-9T</b>	150
	<b>FCC200-9T</b>	200
	<b>FCC10-7T</b>	10
	<b>FCC20-7T</b>	20
	<b>FCC30-7T</b>	30
	<b>FCC50-7T</b>	50
	<b>FCC100-7T</b>	100

- Tough & Flexible cable
- Fit for mobile applications in harsh environments.
- Heat shrink tubes help in labeling.
- 7-color connector rings included.

**Note:** The power transmission distance of FCC\*\*-7T is quite shorter than typical HFO camera cables.

\* Canare OC seires (Hybrid-OPS profile) is also available. Please contact us for more details.



**FCC\*\*-7T**



**FCFA, FCF7A**



**FCMA, FCM7A**



**Color Rings**

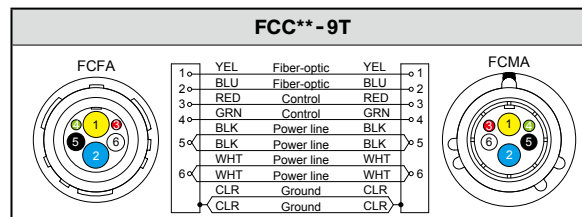

Wiring Diagram

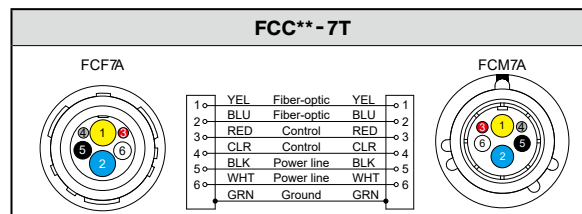

Wiring Diagram

## HFO Camera Cable Assemblies (Flanged Type)

### Panel to CCU

Type	Model	Length (m)
	<b>FCC05N-FRCM</b>	5
	<b>FCC10N-FRCM</b>	10
Jacket color: <b>BLK</b> IU-FCF-SET included		
	<b>FCC05N-FMRC</b>	5
	<b>FCC10N-FMRC</b>	10
Jacket color: <b>BLK</b> IU-FCM-SET included		

\* Canare OC series (Hybrid-OPS profile) is also available. (see page 21)

- HFO camera cable with the flange for panel mounting.
- SMPTE ST 304, ST 311, and ARIB BTA S-1005B compliant.
- Return loss: 45dB or greater ( $\lambda = 1.3\mu\text{m}$ ).
- Insertion loss: 0.5dB or less ( $\lambda = 1.3\mu\text{m}$ ).
- Connector body material is stainless steel.
- Color rings and insulation plates included.
- See below for the panel hole dimensions.



FCFRCA



FCMRCA



Color Rings



IU-FC\*-SET

## HFO Camera Receptacle Cables

### Pigtails

Type	Model	Length (m)
	<b>FCS015A-FR</b>	1.5
	Jacket color: <b>BLK</b> IU-FCF-SET included	
	<b>FCS015A-MR</b>	1.5
	Jacket color: <b>BLK</b> IU-FCM-SET included	

\* Canare OC series (Hybrid-OPS profile) is also available. (see page 21)

- Ideal for connecting wall terminal panels to splice enclosures, etc.
- Return loss: 45dB or greater ( $\lambda = 1.3\mu\text{m}$ ).
- Insertion loss: 0.5dB or less ( $\lambda = 1.3\mu\text{m}$ ).
- Connector body material is stainless steel.
- Insulation plates included.
- See below for the panel hole dimensions.



FCFRCA



FCMRCA

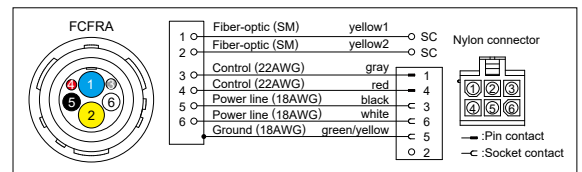

Wiring Diagram

## Insulation Plate

Ideal for perfect insulation between individual connector and panel.

Model	Suitable Connector
<b>IU-FCM-SET</b>	FCMRA, FCMRCA
<b>IU-FCF-SET</b>	FCFRA, FCFRCA

- Material: Bakelite (phenolic resin)
- Mounting screws included.

## Extraction Tool

Extraction tool helps easy to clean Canare HFO connectors.

Model	Suitable Connector
<b>ASPT-1</b>	FCFA, FCF7A, FCFRA, FCFRCA

- Tool to be used to release the alignment sleeve unit when cleaning HFO connectors.

\* Use the CLETOP 2.5/2.0 (100) cleaning stick to clean fiber-optic camera connectors.



IU-FC\*-SET

### Hole Dimensions

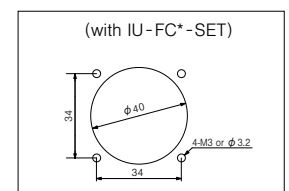

Quick-release



ASPT-1

US Patent No.7241055B2  
JP Patent No.4340186

# Fiber - Optic Systems

## HFO Camera Cables

### HFO Camera Cable Assemblies (Japanese Style)

Canare OC hybrid camera connectors are commonly used in Japan and Asian countries. It includes the same combination of SMPTE 304 but different pinouts. Improved reliabilities and advanced maintenance features.



#### OC connectors

- Symmetric pinout
- Finger detachable insulator
- Better grip, proper connections
- SMPTE 311 cable ready
- Camera MFGs accepted
- Hybrid-OPS profile



#### FC connectors

- SMPTE and ARIB standard
- Detachable insulator with tool
- Widely used in the market
- Hybrid-3K profile

### Camera to CCU

## O C C 1 0 0 - N

#### Series name

Cable mount plugs  
Male and female

#### Lengths

01 = 1 meters  
100 = 100 meters  
Call for stocked lengths.

#### Cable type

**N** : LF-2SM9N O.D. 9 mm PVC Jacket (most common)  
**WJ** : LF-2SM16 O.D. 16 mm PVC Jacket  
**7N** : LF-2SM7N O.D. 7 mm PVC Jacket  
**9T** : LF-2SM9T O.D. 9 mm TPU Jacket w/o Shield  
**7T** : LF-2SM7T O.D. 7 mm TPU Jacket w/o Shield  
TPU = Thermoplastic Polyurethane



OCFA



OCMA

### Panel to CCU

## O C C 0 5 N - F R C M

#### Series name

PNL mount M to  
cable mount F  
and vice versa

#### Lengths

05 = 5 meters  
10 = 10 meters  
Call for custom lengths.

#### Connector type

**FRCM** : OCFCRB-OCMA  
**FMRC** : OCMRCA-OCFA

Cable type: LF-2SM9N



OCFCRB



OCMRCA

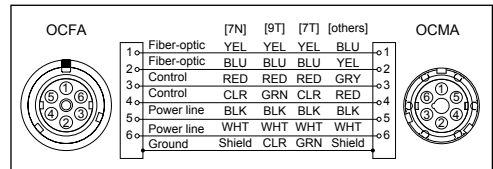

Wiring Diagram for OCC

### Pigtails

## O C S 0 1 5 - F R

#### Series name

OC breakout

#### Lengths

015 = 1.5 meters  
Call for custom lengths.

#### Connector type

**FR** : OCFA to 2 × SC, 1 × Nylon  
**MR** : OCMRA to 2 × SC, 1 × Nylon

### SMPTE Conversion

## F C M 0 2 N - O C F

#### Connector A

**FCM** : FCMA  
**FCF** : FCFA

#### Lengths

02 = 2meters  
Call for custom lengths.

#### Connector B

**OCF** : OCFA  
**OCM** : OCMA

Cable type: LF-2SM9N  
Call for custom models.



OCS015-FR

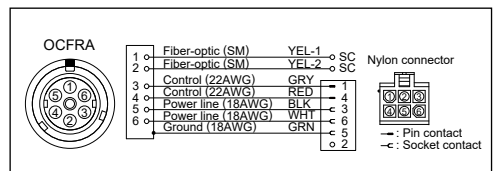

Wiring Diagram for OCS



FCF02N-OCM

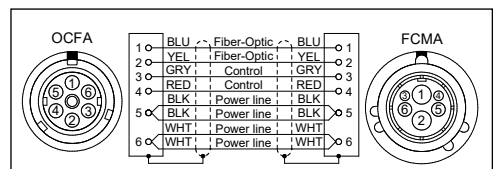

Wiring Diagram for Conversion

**Hybrid Fiber-Optic Camera Cable Checker**

Canare Cable Checker allows fast, easy confirmation of HFO cables in the field. No heavy equipment to drag around. The compact design features a backlight digital display to measure optic loss/power and electrical continuity. Small and light, Canare Cable Checker helps make mobile installations smooth, secure and constant.

Kit Model	Individual Model	
	Measuring Unit	Loop-back Unit
<b>FCT-FCKIT RED</b>	FCT-FC RED	FCT-FCLB RED
<b>FCT-OCKIT RED</b>	FCT-OC RED	FCT-OCLB RED

**Key Features and Benefits**

- Check hybrid camera cables instantly
- Indicating optic power and loss, electrical open-circuit and short-circuit at the same time
- Available in two most common hybrid camera connector interfaces
- All-in-one kit includes storage box, leather case, AA batteries, and CLETOP

**Specifications**

Kit Model	FCT-FCKIT RED	FCT-OCKIT RED
<b>Connector</b>	Canare FC series (SMPTE/ARIB)	Canare OC series (Hybrid-OPS)
<b>LD</b>	FP-LD	
<b>Wavelength</b>	1310 nm	
<b>Output Power</b>	-2.5 dBm	
<b>Sensitivity</b>	-24 to -2 dBm	
<b>Maximum Length</b>	3.5 km (Canare LF-2SM9N)	
<b>Optic Signals</b>	Optical Power and Loss	
<b>Electric Signals</b>	Open-circuit and Short-circuit	
<b>Battery/Life</b>	2 pcs of AA/ Approx. 20hours	
<b>Operating Temperature</b>	-10 to 60 deg C	
<b>Dimensions</b>	Measuring Unit: 46 × 46 × 150 mm Loop-back Unit: 46 × 46 × 65 mm	
<b>Weight</b>	Measuring Unit: 380 g Loop-back Unit: 170 g	
<b>Accessories</b>	Storage case, carrying cases, AA Batteries, and cleaning sticks	

**Note:** Red cap model will not work with black cap model.

CE, FCC, FDA registered  
US Patent No.7113678  
JP Patent No.4155979



Carrying Cases



Storage Case

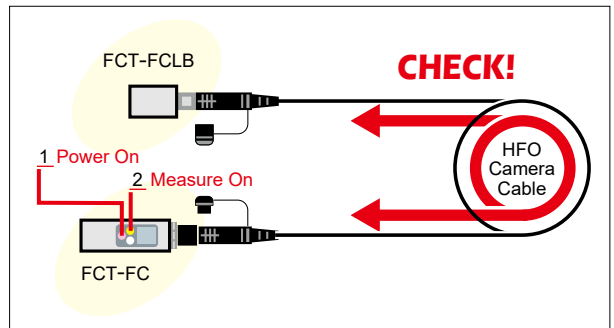

⚠ To prevent the product from being damaged, please NOTE the following points before connection:

- Discharge static electricity from HFO camera cable by grounding its metal part.
- Connect the Loop-back Unit first.
- Do not connect anything other than the Cable Checker and HFO camera cable.

**Technical Note**

**Maintaining Hybrid Fiber-Optic Camera Connectors**

The connector sections to be cleaned are the key parts, including the tips and sides of ferrules, the interior walls of alignment sleeves and the interior and exterior of connector shells. Note that scratches and particles of foreign matter on the tip of the ferrule can have a disabling effect on fiber-optic transmission. The following procedures should be used when cleaning hybrid fiber-optic camera connectors.

- For Plugs, the interior surfaces of alignment sleeves and the tips of ferrules are to be cleaned with the non-alcohol treated cleaning stick using a gentle stroking action. Canare FCFA and FCFRA enhance easy cleaning procedure for its innovative alignment sleeve and insulator detachable design.  
US Patent : No.7241055B2, JP Patent : No.4340186

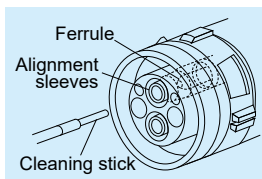

- For Jacks, it is important to clean both the tips and sides of the completely protruding ferrules with the cleaning stick.
- Both the male and female connector shells tend to attract dust and metal particles, so it is important to clean both the insides and outsides using cotton gauze or similar material.



Before cleaning



After cleaning

**Cleaning Stick  
Model: CLETOP 2.5/2.0**

- Compact and disposable
- Allows cleaning both the tips and sides of ferrules
- Manufactured by NTT-AT



Cleaning stick  
CLETOP 2.5/2.0

**IBC Brand Cleaner M-20  
Model: 14347 CLEANER**

- Easy "one-push" cleaner
- Allows cleaning the tips of ferrules without removing alignment sleeve
- Manufactured by US Conec



IBC Brand Cleaner M-20  
14347 CLEANER

Technical Trend

Fiber-Optic Systems

Connectors

Cables

Panels & Patchbays

Multichannel Systems

Cable Assemblies

# Fiber - Optic Systems

## HFO Camera Connector Panels

### Hybrid Fiber-optic Camera Connector Panels

Pre-terminated HFO camera connector panel with built-in splice enclosure box provides easy and quick installation between HD camera system and terminal panel or rack. By combining the unit and frame, HFO camera connector panel enables a variety of layouts depending on the system design.

#### ■ COPS Series (SMPTE)

Model	Panel Size	HFO Connectors* (Assembly)
<b>COPS-FF3A</b>	Wall Mount Type 3RU Height, W: 197.6mm	2 × FCFRA (FCS003A-FR)
<b>COPS-FM3A</b>		2 × FCMRA (FCS003A-MR)
<b>COPS-FF2A</b>	Wall Mount Type 2RU Height, W: 197.6mm	2 × FCFRA (FCS003A-FR)
<b>COPS-FM2A</b>		2 × FCMRA (FCS003A-MR)
<b>COPS3-FF3A</b>	Rack Mount Type 3RU	6 × FCFRA (FCS003A-FR)
<b>COPS3-FM3A</b>		6 × FCMRA (FCS003A-MR)
<b>COPS3-FF2A</b>	Rack Mount Type 2RU	6 × FCFRA (FCS003A-FR)
<b>COPS3-FM2A</b>		6 × FCMRA (FCS003A-MR)

\*HFO connectors are pre-terminated. (length: 0.3 m)

\*Canare OC series (Hybrid-OPS profile) is also available. Please contact us for more details.

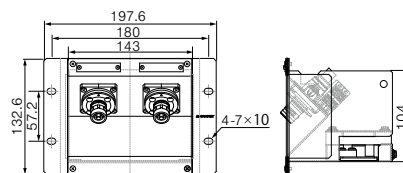

**COPS-FF3A**

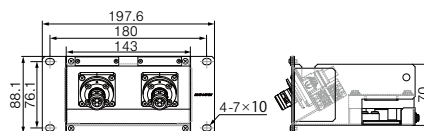

**COPS-FF2A**

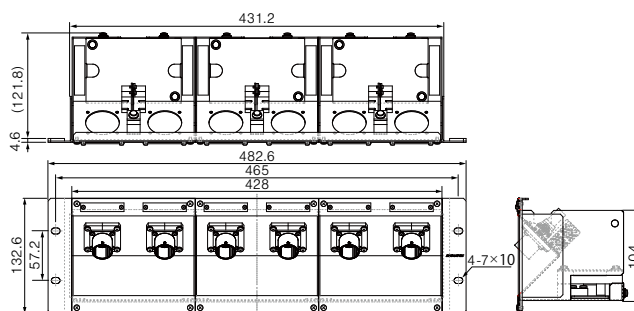

**COPS3-FM3A**

#### Key Features and Benefits

- Exclusive "5-directional Wiring"
- Convenient to build I/O interface between HD facilities and HD OB vans
- Variety of choice of 2RU/3RU and wall/rack mount
- Pre-terminated HFO connectors reduce installation time dramatically.
- Cost effective
- Lightweight aluminum chassis

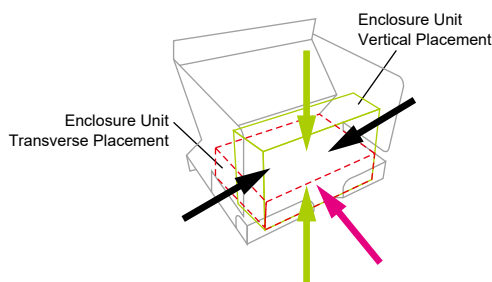

5 directions of cabling as indicated by colored arrows

- Vertical/Transverse placement
- Transverse placement
- Vertical placement

**5-directional Wiring**  
JP Patent No.4388540

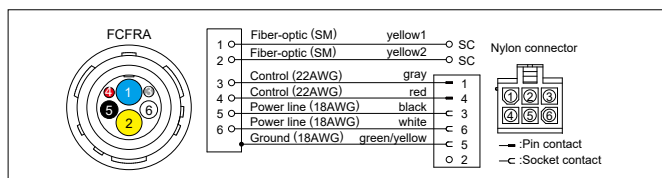

Wiring Diagram

Accessories:  
Fiber-optic cable w/SC connector (2m), grounding cable, nylon connector, pin contact, socket contact, tie-band, fusion splice protection sleeve, splice holder, color-coded tube, mounting screw, laser warning label.

**Note:** Assembly tools for the nylon connectors are NOT include.  
(AMP 91529-1: 26 to 22 AWG and AMP 91536-1: 20×2 to 16 AWG)



## Individual Frame and Unit

Model	Height	Description
<b>COUS-FF3A</b>	3RU	Connector Unit of COPS(3)-FF3A
<b>COUS-FM3A</b>		Connector Unit of COPS(3)-FM3A
<b>COF-13C</b>		Frame of COPS (for 1 unit)
<b>COF-33B</b>	2RU	Frame of COPS3 (for 3 units)
<b>COUS-FF2A</b>		Connector Unit of COPS(3)-FF2A
<b>COUS-FM2A</b>		Connector Unit of COPS(3)-FM2A
<b>COF-12B</b>		Frame of COPS (for 1 unit)
<b>COF-32A</b>	Frame of COPS3 (for 3 units)	

\*HFO connectors are pre-terminated. (length: 0.3 m)  
 \*Canare OC series (Hybrid-OPS profile) is also available. Please contact us for more details.

## Optional Parts

Model	Type	Suitable Frame/Unit
<b>COU-BP3A</b>	Blank Panel	COF-13A, COF-33B (3RU frames)
<b>COU-BP2A</b>		COF-12A, COF-32A (2RU frames)
<b>COU-CV3</b>	Top Cover	COUS-FF3A, COUS-FM3A (3RU units)
<b>COU-CV2</b>		COUS-FF2A, COUS-FM2A (2RU units)

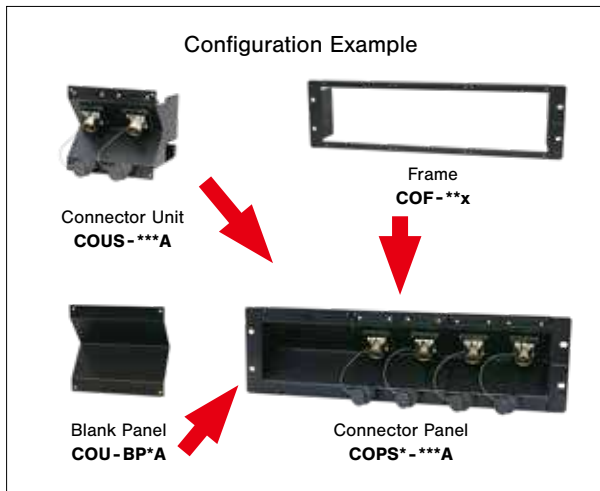

## <Example of Use>

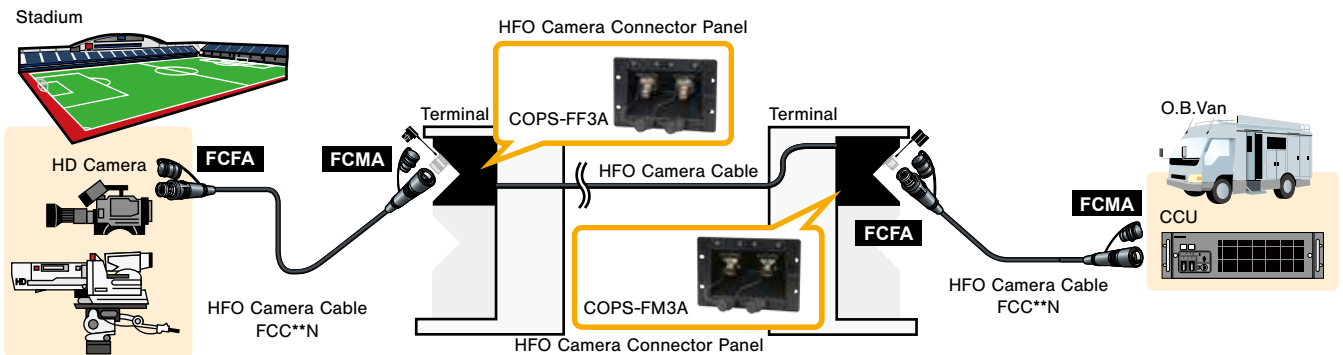

## Hybrid Fiber-optic Splice Enclosures

The optimized fiber-optic splice enclosures for use with HFO camera cables.

Model	No. of cables (capacity)	No. of splice trays	No. of Adapters	
			SC	Nylon
<b>FCE-2</b>	2	1	4	2
<b>FCE-4</b>	4	2	8	4
<b>FCE-6</b>	6	3	12	6

- Used to protect fusion splice connection parts
- Designed for use with LF-2SM9N
- Easy cable installation
- Can be placed vertically or horizontally
- Detachable brackets and a connector protection cover
- Insulated tension member clamp

**Note :**  
 The following tools are required for installing the nylon connector.  
 AMP 91529-1 (26 to 22 AWG) and AMP 91536-1 (20 x 2 to 16 AWG)

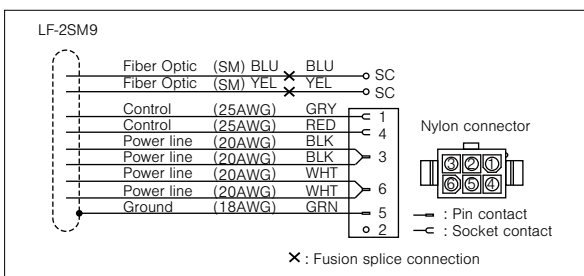

Wiring Diagram



**FCE-2**

Accessories:  
 Fiber-optic cable w/SC connector (2m), splice holder, fusion splice protection sleeve, nylon connector, pin contact, socket contact, tie band, grounding cable, color-coded tube.

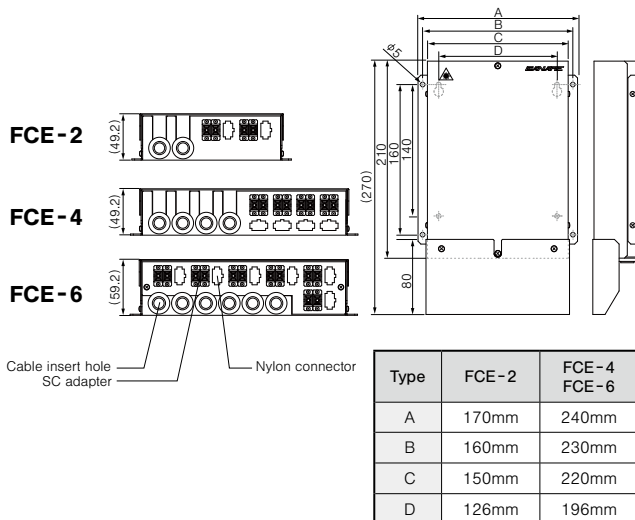

# Fiber - Optic Systems

## Fiber - optic Cables

### 6 - channel Fiber - optic Snakes

Type	Model	Length (m)
	<b>OM6C10</b>	10
	<b>OM6C20</b>	20
	<b>OM6C25</b>	25
	<b>OM6C35</b>	35
	<b>OM6C50</b>	50
	<b>OM6C100</b>	100
	<b>OM6C150</b>	150
	<b>OM6C200</b>	200

Jacket color: **BLK**

- Ruggedized multichannel fiber-optic assemblies with robust 6-fiber connector
- Single-mode, ITU-T G.657.A2 low bending loss and low water-peak fiber
- Abrasion-resistance cable jacket
- Tensile strength: 700 N or less
- Return loss: 45 dB or greater ( $\lambda = 1.3 \mu\text{m}$ )
- Insertion loss: 0.5 dB or greater ( $\lambda = 1.3 \mu\text{m}$ )
- 7-color connector rings included.
- Blue dust cap makes it easier to distinguish OM6 from HFO camera connectors.



**OM6PA**



**OM6JA**



**Color Rings**

- \* Canare OM6 connectors are NOT compatible with other multichannel/hybrid fiber-optic connectors.
- \* IBC brand "one-push" cleaner M-20 is highly recommended for cleaning OM6 connectors. (see page 22, model: 14347 CLEANER)

### 6 - channel Fiber - optic Fantails

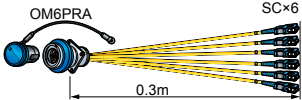
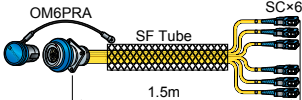
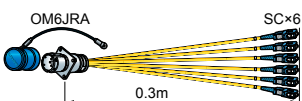
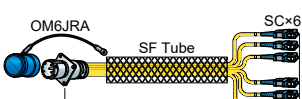
Type	Model	Length (m)
 <p>Jacket color: <b>YEL</b> IU-FCM-SET included</p>	<b>OM6S003-PR</b>	0.3
 <p>Jacket color: <b>YEL</b> IU-FCM-SET included</p>	<b>OM6S015-PR</b>	1.5
 <p>Jacket color: <b>YEL</b> IU-FCM-SET included</p>	<b>OM6S003-JR</b>	0.3
 <p>Jacket color: <b>YEL</b> IU-FCM-SET included</p>	<b>OM6S015-JR</b>	1.5

- OM6 receptacle with 6 SC single-mode fiber cord (2.0mm).
- Return loss: 45 dB or greater ( $\lambda = 1.3 \mu\text{m}$ )
- Insertion loss: 0.5 dB or greater ( $\lambda = 1.3 \mu\text{m}$ )
- Blue dust cap makes it easier to distinguish OM6 from HFO camera connectors.

- \* Canare OM6 connectors are NOT compatible with other multichannel/hybrid fiber-optic connectors.
- \* IBC brand "one-push" cleaner M-20 is highly recommended for cleaning OM6 connectors. (see page 22, model: 14347 CLEANER)



**OM6PRA**



**OM6JRA**

#### ■ Hole Dimensions

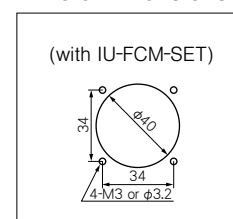

**Tactical Fiber-optic Cable**

Particularly rugged multichannel fiber-optic cable designed for mobile applications.

Type	Model	No. of Ch.	Sales Units (m)	Nom. O.D. (mm)	Weight kg/100m	Tension Tolerance (N)	Strength Member	Min. Bend Radius	Temp. Range (deg C)	Fiber-optic Unit		
										Fiber	Attenuation	Unit O.D.
 Jacket color: <b>BLK</b>	<b>LF-SM2T-4C</b>	4	100 200 500	7.8	4.9	1400	Aramid yarn	Equal to Nom. O.D.	-55 to +85	SM 9/125 (low-water-peak)	1.6 dB/km @1310 nm	2.0 mm including aramid yarn

Jacket: TPU



**LF-SM2T-4C**

- Heavy-duty and high flexibility
- \* Crush resistance : 2,000 N/cm
- \* Impact resistance : 300 impacts
- \* Cycle flexing : 20,000 cycles
- Single-mode
- Color-coded breakout type unit
- Thermoplastic polyurethane jacket
- Aramid yarn strength member
- 4-channel cable best suited for Quad-link 3G-SDI signals.

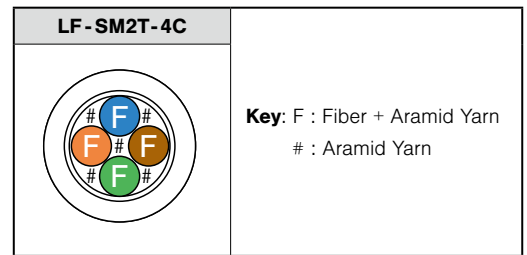
**Cross Section**

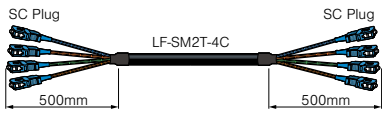

**Cable Assemblies**

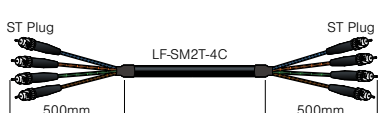
Type	Model	Length (m)
 SC Plug      LF-SM2T-4C      SC Plug 500mm      500mm Jacket color: <b>BLK</b>	<b>4FS50T-SS</b>	50
	<b>4FS100T-SS</b>	100
	<b>4FS150T-SS</b>	150
	<b>4FS200T-SS</b>	200
 LC Plug      LF-SM2T-4C      LC Plug 500mm      500mm Jacket color: <b>BLK</b>	<b>4FS50T-LS</b>	50
	<b>4FS100T-LS</b>	100
	<b>4FS150T-LS</b>	150
	<b>4FS200T-LS</b>	200
 ST Plug      LF-SM2T-4C      ST Plug 500mm      500mm Jacket color: <b>BLK</b>	<b>4FS50T-ST</b>	50
	<b>4FS100T-ST</b>	100
	<b>4FS150T-ST</b>	150
	<b>4FS200T-ST</b>	200

**Single-mode Fiber-optic Cables (Multichannel)**

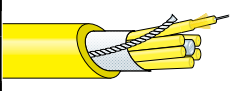
Type	Model	No. of Ch.	Sales Units (m)	Nom. O.D. (mm)	Weight kg/100m	Outer Jacket	Tension Tolerance (N)	Min. Bend Radius	Temp. Range (deg C)	Fiber-optic Unit		
										Fiber	Attenuation	Unit O.D.
 <b>LF-SM2-6C</b> Jacket color: <b>YEL</b>	<b>LF-SM2-2C</b>	2	Call	7.4	5.4	PVC	290	10 x Nom. O.D.	-40 to +75	SM 9/125 + Aramid yarn + PVC jacket	0.5 dB/km @1310nm	2.0 mm including aramid yarn
	<b>LF-SM2-4C</b>	4		7.4	5.5		290					
	<b>LF-SM2-6C</b>	6		9.0	7.3		300					
	<b>LF-SM2-8C</b>	8		10.0	10.4		780					
	<b>LF-SM2-12C</b>	12		12.8	14.2		780					
	<b>LF-SM2-16C</b>	16		14.7	16.3		780					
	<b>LF-SM2-24C</b>	24		15.0	18.3		780					

- Smooth PVC Jacket
- Including a central strength member and a rip cord.

# Fiber - Optic Systems

## Fiber - optic Cables

### Single-mode Fiber Optic Patch Cables

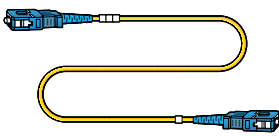
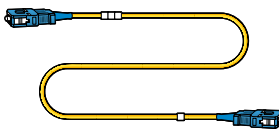
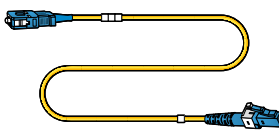
Type	Model	Length (m)
<b>SC - SC</b> 	FS3C002A - S	0.2
	FS3C003A - S	0.3
	FS3C005A - S	0.5
	FS3C007A - S	0.7
	FS3C01A - S	1
	FS3C02A - S	2
	FS3C03A - S	3
	FS3C04A - S	4
	FS3C05A - S	5
	Jacket color: <b>YEL</b> Cable O.D.: 3 mm	
<b>SC - SC</b> 	FS2C002A - SS	0.2
	FS2C003A - SS	0.3
	FS2C005A - SS	0.5
	FS2C007A - SS	0.7
	FS2C01A - SS	1
	FS2C02A - SS	2
	FS2C03A - SS	3
	FS2C04A - SS	4
	FS2C05A - SS	5
	Jacket color: <b>YEL</b> Cable O.D.: 2 mm	
<b>SC - LC</b> 	FS2C002A - SS/LS	0.2
	FS2C003A - SS/LS	0.3
	FS2C005A - SS/LS	0.5
	FS2C007A - SS/LS	0.7
	FS2C01A - SS/LS	1
	FS2C02A - SS/LS	2
	FS2C03A - SS/LS	3
	FS2C04A - SS/LS	4
	FS2C05A - SS/LS	5
	Jacket color: <b>YEL</b> Cable O.D.: 2 mm	

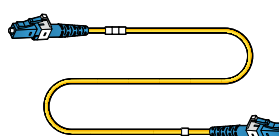
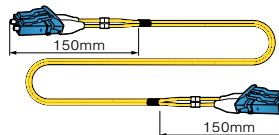
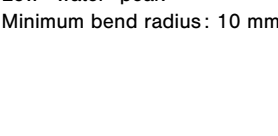
Type	Model	Length (m)	
<b>LC - LC</b> 	FS2C002A - LS	0.2	
	FS2C003A - LS	0.3	
	FS2C005A - LS	0.5	
	FS2C007A - LS	0.7	
	FS2C01A - LS	1	
<b>LC - LC Duplex</b> 	2FSZ2S005A - DLS	0.5	
	2FSZ2S007A - DLS	0.7	
	2FSZ2S01A - DLS	1	
	2FSZ2S02A - DLS	2	
	2FSZ2S03A - DLS	3	
<b>LC - LC Duplex</b> 	2FSZ2S04A - DLS	4	
	2FSZ2S05A - DLS	5	
	Jacket color: <b>YEL</b> Cable O.D.: 2 mm		

- ITU-T G.652.D/G.657.A2
- Low - water - peak
- Minimum bend radius : 10 mm

- Insertion loss : 0.5 dB max.
- Return loss : 50 dB max. (UPC)
- UL type OFNR

### Single-mode Fiber Optic Fantails

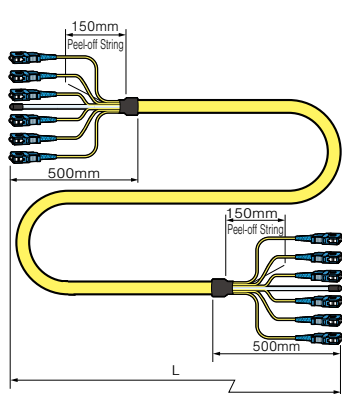
Type	Channel	Model	Length (m)	Fiber Optic Cable		
				Part Number	Unit O.D. (mm)	Nom. O.D. (mm)
<b>SC - SC</b> 	2	2FS10 - S	10	LF-SM2-2C	2	7.4
		2FS20 - S	20			
		2FS50 - S	50			
	4	4FS10 - S	10	LF-SM2-4C		7.4
		4FS20 - S	20			
		4FS50 - S	50			
	6	6FS10 - S	10	LF-SM2-6C		9.0
		6FS20 - S	20			
		6FS50 - S	50			
	8	8FS10 - S	10	LF-SM2-8C		10.0
		8FS20 - S	20			
		8FS50 - S	50			
12	12FS10 - S	10	LF-SM2-12C	12.8		
	12FS20 - S	20				
	12FS50 - S	50				
16	16FS10 - S	10	LF-SM2-16C	14.7		
	16FS20 - S	20				
	16FS50 - S	50				
24	24FS10 - S	10	LF-SM2-24C	15.3		
	24FS20 - S	20				
	24FS50 - S	50				
Jacket color: <b>YEL</b>						

- Flexible cable with reliable bellcore boots
- Adjustable fantail length with peel-off string
- UPC polishing; Return loss  $\geq 50$ dB for single mode
- Transmission loss 0.5dB at  $\lambda = 1.31\mu\text{m}$  and 0.4dB at  $\lambda = 1.55\mu\text{m}$

OM3 Multi-mode Fiber Optic Patch Cables

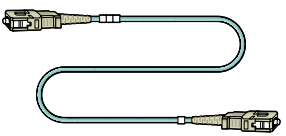
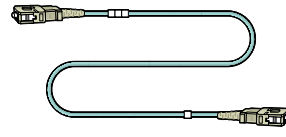
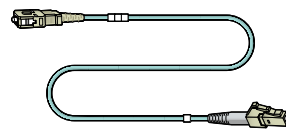
Type	Model	Length (m)
 Jacket color: AQUA Cable O.D.: 3 mm	FM33C005-S	0.5
	FM33C01-S	1
	FM33C03-S	3
	FM33C05-S	5
 Jacket color: AQUA Cable O.D.: 2 mm	FM32C005-SS	0.5
	FM32C01-SS	1
	FM32C03-SS	3
	FM32C05-SS	5
 Jacket color: AQUA Cable O.D.: 2 mm	FM32C005-SS/LS	0.5
	FM32C01-SS/LS	1
	FM32C03-SS/LS	3
	FM32C05-SS/LS	5

- Fiber type : Multi-mode 50/125 OM3
- Typically used in 10 Gigabit Ethernet
- Minimum bend radius: 10 mm

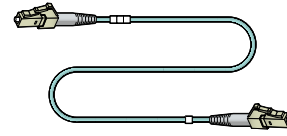
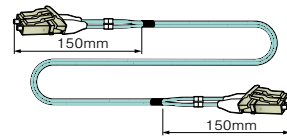
Type	Model	Length (m)
 Jacket color: AQUA Cable O.D.: 2 mm	FM32C005-LS	0.5
	FM32C01-LS	1
	FM32C03-LS	3
	FM32C05-LS	5
 Jacket color: AQUA Cable O.D.: 2 mm	2FM3Z2S005-DLS	0.5
	2FM3Z2S01-DLS	1
	2FM3Z2S03-DLS	3
	2FM3Z2S05-DLS	5

- Insertion loss : 0.3 dB max.
- Return loss : 30 dB max. (PC)
- UL type OFNR

OM3 Multi-mode Fiber Optic Fan-out Cables

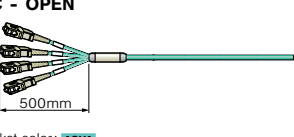
Type	Model	Length (m)
 Jacket color: AQUA	4FO-M3-015-SS	1.5
	4FO-M3-03-SS	3
	4FO-M3-05-SS	5

- 4-core Multimode 50/125 OM3 Ribbon Fiber
- Typically used in 10 Gigabit Ethernet
- Insertion loss : 0.3 dB max.
- Return loss : 30 dB max. (PC)

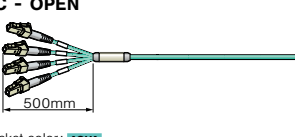
Type	Model	Length (m)
 Jacket color: AQUA	4FO-M3-015-LS	1.5
	4FO-M3-03-LS	3
	4FO-M3-05-LS	5

- Ribbon fiber cable : 2.1 × 3.5 mm outer dimensions
- Fan-out unit : 2 mm outer diameter, 500 mm length
- Fan-out tubing : 8 mm outer diameter
- UL type OFNR

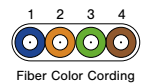

Multi-core OM3 Multi-mode Fiber Optic Cables

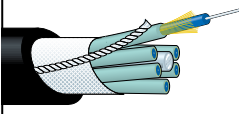
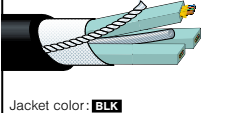
Type	Model	No. of Ch.	Sales Units (m)	Nom. O.D. (mm)	Weight kg/100m	Tension Tolerance (N)	Min. Bend Radius	Temp. Range (deg C)	Fiber-optic Unit		
									Fiber	Attenuation	Dim. (mm)
 Jacket color: BLK Unit color: AQUA	LF-M32-4C-EM	4	Call	7.4	5.6	290	6 × Nom. O.D.	-20 to +60	MM 50/125	3 dB/km @850nm 1 dB/km @1300nm	2.0 (round)
	LF-M32-6C-EM	6		9.0	7.5	300					1.5 × 2.5 (ribbon)
	LF-M32-8C-EM	8		10.1	10.8	780					
 Jacket color: BLK Unit color: AQUA	LF-M3R4-12C-EM	12 (3×4 core)		7.4	5.6	300					

Jacket material : Flame retardant PE

- OM3 fiber; typically used in 10 Gigabit Ethernet.
- Including a central strength member and a rip cord.
- Each unit has aramid strength member.

### 75Ω BNC Crimp Plugs

Canare added the new BCP-D series for 12G-SDI. SMPTE ST 2082-1 fully compliant connector makes UHD solutions as simple as existing SDI systems. The world's highest quality BNC includes BCP-B for 3G-SDI, BCP-A/C for up to HD.

#### ■ BCP-D Series **12G-SDI**

Return Loss: 20 dB @ 6 GHz, 15 dB @ 12 GHz

Model	Suitable Cable		Center Pin	Sleeve	Boot	Die Set
	Canare	Others				
<b>BCP-D33UHD</b>	L-3.3CUHD	—	BN1181	BN7003A	CB03	TCD-35CA
<b>BCP-D55UHD</b>	L-5.5CUHD	—	BN1175	B75004A	—	TCD-55UHD
<b>BCP-D55UHW</b>	L-5.5CUHWS	—	BN1192	BN7014	(TBD)	TCD-57C
<b>BCP-D57</b>	—	4794R	BN1192	BN7002	—	TCD-57C
<b>BCP-D8UHD</b>	L-8CUHD, L-8CHD	—	BN1174	BN7147	—	TCD-8HD*

\* Standard package (20pcs/100pcs)

\*Crimp tool for TCD-8HD is TC-2



**BCP-D55UHD**

#### ■ BCP-B Series

Return Loss: 26.4 dB @ 3 GHz

Model	Suitable Cable		Center Pin	Sleeve	Boot	Die Set
	Canare	Others				
<b>BCP-B25HD</b>	L-2.5CHD, L-2.5CHLT	VDM230	B11015E	BN7129	CB02	TCD-35CA
<b>BCP-B25HW</b>	L-2.5CHWS, V4-2.5CHW	—	B11015E	BN7143	CB02	TCD-35CA
<b>BCP-B26</b>	—	1855A, 1855P	B11014E	BN7029C	CB02	TCD-35CA
<b>BCP-B28</b>	—	1855ENH, HD PRO 0.6/2.8 AF	B11015E	BN7052A	CB02	TCD-35CA
<b>BCP-B3F</b>	L-3CFB, V*-3CFB	—	B11015E	BN7003A	CB03	TCD-35CA
<b>BCP-B31F</b>	L-3CFW, V*-3CFW	—	B11015E	BN7015A	CB04	TCD-4CA TCD-451CA
<b>BCP-B4F</b>	L-4CHD, L-4CFB, V*-4CFB	1505A, 1505ANH, VPM2000, HD PRO 0.8/3.7 AF	B11016E	BN7015A	CB04	TCD-4CA TCD-451CA
<b>BCP-B45HW</b>	L-4.5CHWS	1694F	B11020D	BN7016	CB05A	TCD-35CA
<b>BCP-B53</b>	L-4.5CHD	1694A	B11020D	BN7046	CB05A	TCD-35CA
<b>BCP-B56</b>	—	HD PRO 1.0/4.8 AF	B11020D	BN7046	CB05A	TCD-35CA
<b>BCP-B5F</b>	L-5CFB, V*-5CFB	—	B11020D	B75004A	CB05A	TCD-5CF TCD-55FA
<b>BCP-B51F</b>	L-5CFW, V*-5CFW	—	B11020D	B75004A	CB05A	TCD-5CF TCD-55FA

\* Standard package (20pcs/100pcs)

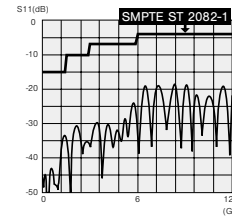

Return loss for BCP-D55UHD



**BCP-B5F**

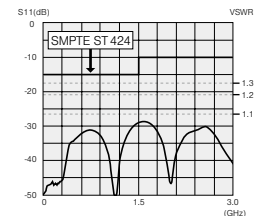

Return loss for BCP-B5F

#### ■ BCP-A Series

Return Loss: 26.4 dB @ 2 GHz, 20.8 dB @ 3 GHz (\*1)

Model	Suitable Cable		Center Pin	Sleeve	Boot	Die Set
	Canare	Others				
<b>BCP-A25</b>	L-2.5C2V	—	BN1018A	BN7029C	CB02	TCD-35CA
<b>BCP-A25F</b>	L-2.5CFB	1855A, 8218, 1417B, 1418B	B11014E	BN7029C	CB02	TCD-35CA
<b>BCP-A3</b>	L-3C2VS, L-3C2V, V*-3C	—	B11014E	BN7003A	CB03	TCD-35CA
<b>BCP-A31</b>	L-3C2W	—	B11014E	BN7011	CB04	TCD-31C
<b>BCP-A32</b>	—	1506A, 1824A, 1825A, 1826A, 643948	B11016E	BN7026A	CB03	TCD-35CA
<b>BCP-A3AHD</b>	L-3C-AHD	—	B11016E	BN7003A	CB03	TCD-35CA
<b>BCP-A3F</b>	L-3CFB, V*-3CFB	—	B11015E	BN7003A	CB03	TCD-35CA
<b>BCP-A4</b>	LV-61S	8241, 8279, RG-59B/U	B11015E	BN7015A	CB04	TCD-4CA TCD-451CA
<b>BCP-A42</b>	—	1505F	B11016E	BN7011	CB04	TCD-31C
<b>BCP-A4F</b>	L-4CHD, L-4CFB, V*-4CFB	1505A, 1505ANH, 8212, 8241F, 9167, 9259, 9659, VPM2000, HD PRO 0.8/3.7 AF	B11016E	BN7015A	CB04	TCD-4CA TCD-451CA
<b>BCP-A5</b>	L-5C2VS, L-5C2V, V*-5C	—	B11016E	BN7016	CB05A	TCD-35CA
<b>BCP-A52</b>	L-5C2W	—	B11016E	BN7014	—	TCD-451CA
<b>BCP-A55</b>	—	1695A, VSD2001TS	B11020D	BN7045A	CB04	TCD-35CA
<b>BCP-A5F</b>	L-5CFB, V*-5CFB	—	B11020D	B75004A	CB05A	TCD-35CA
<b>BCP-A77</b>	LV-77S	8281F	B11016E	B75004A	CB05A	TCD-5CF TCD-55FA
<b>BCP-VA3</b>	V*-3C	—	B11014E	BN7052A	CB03	TCD-35CA
<b>BCP-VA5</b>	V*-5C	—	B11016E	BN7045A	CB05A	TCD-35CA

\* Standard package (20pcs/100pcs).

\*1 Excluding BCP-A25, BCP-A25F and BCP-A4

Note: Suitable die set for BCP-A5F is TCD-35CA; do not use TCD-5CF/TCD-55FA for BCP-A5F.

- Canare crimp design ensures quick and reliable installation.
- Gold plated "snap locks" center pin and beryllium copper outer contact.
- Elongated body design for stable finger grip.
- Position mark on the body makes it easier to check if the connector is locked.

Be sure to use Canare Crimp Tool

■ BCP-C Series

Return Loss : 26.4 dB @ 2 GHz (\*2)

Model	Suitable Cable		Center Pin	Sleeve	Boot	Die Set
	Canare	Others				
<b>BCP-C1</b>	L-1.5C2VS, V*-1.5C	83264, 83267	Solder	BN7022	CB01	TCD-1DB
<b>BCP-C5HD</b>	L-5CHD	—	BN1139	B75004A	CB05A	TCD-5HD
<b>BCP-C6HD</b>	L-6CHD	—	BN1083A	BN7074A	—	TCD-67HD
<b>BCP-C71A</b>	—	7731A, 9064, 9292, 1617A, 9011	BN1043A	BN7021A	—	TCD-7CA
<b>BCP-C7FA</b>	L-7CFB	—	BN1012B	BN7021A	—	TCD-7CA
<b>BCP-C7HD</b>	L-7CHD	—	BN1082A	BN7021A	—	TCD-67HD

• Standard package (20pcs/100pcs).

\*2: Excluding BCP-C1



**BCP-C6HD**

Technical Trend

Fiber-Optic Systems

Connectors

■ BCP-LC Series (Right Angle)

Return Loss : 26.4 dB @ 2 GHz

Model	Suitable Cable		Center Pin	Sleeve	Boot	Die Set
	Canare	Others				
<b>BCP-LC3</b>	L-3C2VS, L-3C2V, V*-3C	—	B11014E	BN7003A	—	TCD-35CA
<b>BCP-LC3F</b>	L-3CFB, V*-3CFB	—	B11015E	BN7003A	—	TCD-35CA
<b>BCP-LC5</b>	L-5C2VS, L-5C2V, V*-5C	—	B11016E	BN7016	—	TCD-35CA
<b>BCP-LC5F</b>	L-5CFB, V*-5CFB	—	B11020D	B75004A	—	TCD-5CF TCD-55FA

• Standard package (20pcs)

- Canare crimp design ensures quick and reliable installation.
- Gold plated "snap locks" center pin and beryllium copper outer contact.

Be sure to use Canare Crimp Tool



**BCP-LC3**

Cables

Panels & Patchbays

Multichannel Systems

Cable Assemblies

75Ω Slim BNC Crimp Plugs

■ MBCP-C Series

Return Loss : 26.4 dB @ 1.5 GHz (\*3)

Model	Suitable Cable		Center Pin	Sleeve	Boot	Die Set
	Canare	Others				
<b>MBCP-C25F</b>	L-2.5CFB	1855A, 8218, 1417B, 1418B	B11014E	BN7029C	—	TCD-35CA
<b>MBCP-C3F</b>	L-3CFB, V*-3CFB	—	B11015E	BN7003A	CB24	TCD-35CA
<b>MBCP-C4</b>	LV-61S	8241, 8279, RG-59B/U	B11015E	BN7015A	CB25	TCD-4CA TCD-451CA
<b>MBCP-C4F</b>	L-4CFB, V*-4CFB	1505A, 1505ANH, 8212, 8241F, 9167, 9259	B11016E	BN7015A	CB25	TCD-4CA TCD-451CA
<b>MBCP-C53</b>	L-4.5CHD	1694A, 9066, 9116, 9118, 9248	B11020D	BN7046	CB26	TCD-35CA
<b>MBCP-C5F</b>	L-5CFB, V*-5CFB	—	B11020D	B75004A	CB26	TCD-5CF TCD-55FA

• Standard package (20pcs/100pcs)

\*3: Excluding MBCP-C25F

- Slim design : O.D. 12 mm
- Compatible with 75Ω BNC receptacles.
- Canare crimp design ensures quick and reliable installation.
- Gold plated "snap locks" center pin and beryllium copper outer contact.

Be sure to use Canare Crimp Tool

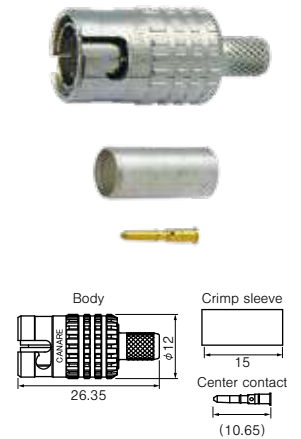
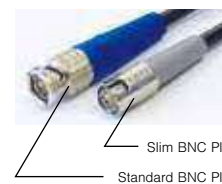

**MBCP-C3F**

Technical Note

Voltage Standing-wave Ratio (VSWR) and Return Loss

Terminating the receiving end of a limited length coaxial cable using a resistance value not equal to its characteristic impedance creates a reflected wave that returns back down the cable to the sending end. The result is interference developing between the travelling wave and the return wave which results in a standing wave that causes voltage levels to fluctuate. The degree to which terminating resistance matches the characteristic impedance is indicated using the VSWR or voltage standing-wave ratio standard shown in Fig. 1. Going hand in hand with the VSWR ratio is the return loss factor which measures the size of the reflected wave current in relation to the travelling wave current. (See Fig. 2)

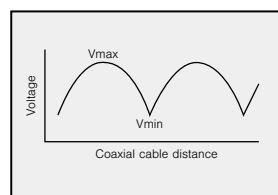

Fig. 1 Voltage Distribution Over Coaxial Cable

VSWR	Return Loss (dB)
2	9.54
1.5	13.98
1.2	20.83
1.1	26.44
1.05	32.26
1.02	40.09
1.01	46.06

Fig. 2 VSWR to Return Loss Conversion Table

# Connectors

## 75Ω BNC Connectors

### 75Ω BNC Solder Plugs

#### ■ BCP-H Series

Return Loss : 26.4 dB @ 1 GHz

Model	Suitable Cable	
	Canare	Others
<b>BCP-H3B</b>	L-3C2VS, L-3C2V, L-3CFB	—
<b>BCP-H31F</b>	L-3CFW	—
<b>BCP-H45HW</b>	L-4.5CHWS	1694F
<b>BCP-H5B</b>	L-5C2VS, L-5C2V, L-5CFB	—
<b>BCP-H51F</b>	L-5CFW, L-5CFB	—
<b>BCP-H5/1</b>	L-3C2VS, L-3C2V, L-3CFB L-5C2VS, L-5C2V, L-5CFB	—

• Standard package (20pcs)

- The tubular (ferrule) section is silver plated to make soldering easier.
- Cable stripper TS100E can be used. (Excluding BCP-H31F, BCP-H51F)



**BCP-H3B**

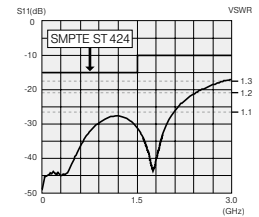

**Return loss for BCP-H3B**



**BCJ-C4**



**BCJ-D25HW**

**12G-SDI**

### 75Ω BNC Jack Plug

Model	Suitable Cable	Center Pin	Sleeve	Boot	Die Set
<b>BCJ-C4</b>	RG-59 B/U, LV-61S, Belden 8241, 8279, 88241	Solder	V75001	CB25	TCD-4CA TCD-451CA
<b>BCJ-D25HD</b>	L-2.5CHD	BN1204	BN7159	—	TCD-D253F
<b>BCJ-D25HW</b>	L-2.5CHWS	BN1204	BN7158	—	TCD-D253F
<b>BCJ-D33UHD</b>	L-3.3CUHD	BN1205	BN7003A	—	TCD-D253F

• Standard package (20pcs)

- Return loss for BCJ-C: 26.4 dB @ 1.5 GHz, 20.8 dB @ 2.4 GHz
- Return loss for BCJ-D: 20 dB @ 3 GHz, 15 dB @ 6 GHz, 10 dB @ 12 GHz

Be sure to use Canare Crimp Tool

### 75Ω BNC Extension Adapter

Model	Description
<b>BCJ-JK</b>	Jack to Jack, for 12G-SDI

• Standard package (20pcs/100pcs)

- Return loss for BCJ-JK: 15 dB @ 12 GHz



**BCJ-JK**

**12G-SDI**

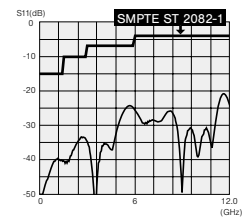

**Return loss for BCJ-JK**

### 75Ω BNC Termination Plugs

Model	Description
<b>BCP-TK</b>	True 75Ω Termination, for 12G-SDI
<b>BCP-TK-CH</b>	BCP-TK with String

• Standard package (20pcs/100pcs)

- Includes 1/4 watt resistance.
- Return loss for BCP-TK: 26.4 dB @ 3 GHz, 15 dB @ 12 GHz



**BCP-TK**

**12G-SDI**

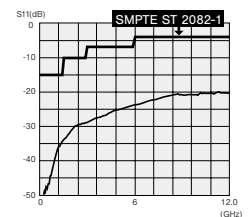

**Return loss for BCP-TK**

### Connector Boots

#### ■ CB0\* Series

Our best selling connector boots for Canare BNC, TNC crimp plugs.

Model	Colors Available	BCP-**	BP-**	TNP-**
<b>CB01</b>	BLK BLU GRN RED YEL WHT	C1		
<b>CB02</b>		B25HD, B25HW, B26, B28, A25, A25F		
<b>CB03</b>	BLK BLU BRN GRN GRY	D33UHD, B3F, B31F, A3, A32, A3AHD, A3F, VA3	C3, C4	C3, C4
<b>CB04</b>	ORN PPL RED YEL WHT	B4F, A31, A4, A42, A4F, A55	C31	C31
<b>CB05A</b>		B53, B56, B5F, B51F, A5, A5F, A77, VA5, C5HD	C5, C5FA	C5

#### ■ CB2\* Series

Thinner type of CB0\* series. Best fit for Canare Slim BNC, RCA, and F crimp plugs.

Model	Colors Available	Typical Connectors		
		MBCP-**	RCAP-**	FP-**
<b>CB24</b>		C3F	C3A, C3F	C3, C3F
<b>CB25</b>	BLK BLU GRN RED YEL WHT	C4, C4F	C3GS, C4A, C4F	C31, C4, C4F
<b>CB26</b>		C5F	C53, C5A, C5F	C5, C53A, C5F

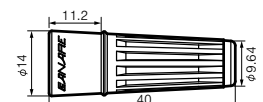

**CB03, CB04, CB05A**

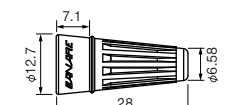

**CB01, CB02**



**CB24, CB25, CB26**



75Ω BNC Receptacles

■ **Jack to Jack** **12G-SDI** Return Loss: 15 dB @ 12 GHz

Model	Description	Flange
BCJ-JRK	Standoff	—
BCJ-JRUK	Flush-mount	ITT XLR-F77
BCJ-JRUDK		Neutrik D
BCJ-JRUDBK		Neutrik D (Black)

- Standard package (20 pcs)
- Redesigned for 12G-SDI to minimize return loss.

■ **Jack to Jack** Return Loss: 26.4 dB @ 2 GHz

Model	Description	Flange
BCJ-JRUD	Flush-mount	Neutrik D
BCJ-JRUDB	Flush-mount	Neutrik D (Black)

- Standard package (20 pcs)

■ **Jack to Solder** Return Loss: 26.4 dB @ 2 GHz

Model	Description	Flange
BCJ-R	Rear-mount	—
BCJ-R/1	Rear-mount, w/Ground Lug	—
BCJ-RU	Flush-mount	ITT XLR-F77
BCJ-RUD		Neutrik D
BCJ-RUDB		Neutrik D (Black)

- Standard package (20 pcs)

■ **Panel Jack (Jack to Solder and Crimp)** Return Loss: 26.4 dB @ 1 GHz

Model	Description	Flange	Suitable Cable	Die Set
BCJ-FC1	Front-mount, 1/2"	—	1.5C-2V	TCD-1DB
BCJ-FC1-7/16	Front-mount, 7/16"	—		
BCJ-RUC1	Flush-mount	ITT XLR-F77		

- Standard package (20 pcs)
- Panel Jack covers the rear wiring part with metal crimp sleeve.
- Flush-mount receptacle prevents damage on the jack.

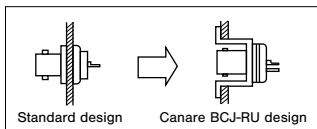

■ **Panel Hole Dimensions**

BCJ-R	★BCJ-R/1 ★BCJ-JRK	BCJ-FC1	★BCJ-FC1-7/16	BCJ-RUC1 BCJ-RU BCJ-JRUK	BCJ-RUD BCJ-RUDB BCJ-JRUD(K) BCJ-JRUDB(K)

★ marked models accept insulation bushing IU-7/16, and the panel hole for IU-7/16 should be adopted in this case. (see below)

■ **Insulation Bushing**

Model	Description
IU-7/16	ABS plastic

- Standard package (20 pcs)
- Insulate a connector from a panel.
- 6 colors available (white, black, blue, green, red, or yellow)
- Note: Please remove washers from a connector before using IU-7/16.

Panel Thickness:

- 1.2 to 1.5 mm: BCJ-DCJ, BCJ-FPLHA, BCJ-FPLV-12G, BCJ-FPLV-L, BCJ-FPLVA, BCJ-HBCJK, BCJ-R/1
- 1.2 to 3.0 mm: BCJ-FC1-7/16, BCJ-FPC, BCJ-FPC02, BCJ-FPLV01, BCJ-JRK, BJ-JR, FJ-JR, FJ-FPC, NCJ-BCJR, RJ-JR

Technical Trend  
Fiber-Optic Systems  
Connectors  
Cables  
Panels & Patchbays  
Multichannel Systems  
Cable Assemblies

# Connectors

## 75Ω BNC Connectors

### 75Ω BNC PCB Mount Receptacles (Screw Type)

#### ■ Front Mount

Model	Description	Stud Position	Panel Mount	Standard Package
BCJ-BPLHK	Right Angle, for 12G-SDI	Horizontal	Front: M2.6 screw	20 pcs/100 pcs
BCJ-BPLHA	Right Angle			20 pcs/100 pcs
BCJ-BPLHK2P <b>New</b>	Right Angle, Dual Jack, for 12G-SDI			10 pcs
BCJ-BPLH2PA	Right Angle, Dual Jack			10 pcs
BCJ-BPLH3PA	Right Angle, Triple Jack			10 pcs
BCJ-BPCK	Straight, for 12G-SDI			20 pcs
BCJ-BPC2P	Straight, Dual Jack	-	10 pcs/100 pcs	

Screws not included

#### Key Features and Benefits

- True 75Ω PC board mount receptacle.
- Gold plated beryllium copper center contact.
- Right Angle types can be fixed on PC board with M2.6 screw.
- Space-saving design
- Eliminates wiring material and cost.

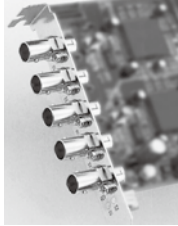

**Note:** Any cleaning solvents cannot be used. This leads to insulation problems.  
Insulation material: m-PPO (m-PPE)

#### < Return loss >

BCJ-BPLHK: 26 dB @ 1.5 GHz, 20 dB @ 3 GHz, 15 dB @ 6 GHz, 10 dB @ 12 GHz  
 BCJ-BPLHA: 26 dB @ 1.5 GHz, 20 dB @ 3 GHz  
 BCJ-BPCK: 26 dB @ 1.5 GHz, 20 dB @ 3 GHz, 15 dB @ 6 GHz, 10 dB @ 12 GHz  
 BCJ-BPC2P: 26 dB @ 1 GHz, 20 dB @ 2.5 GHz

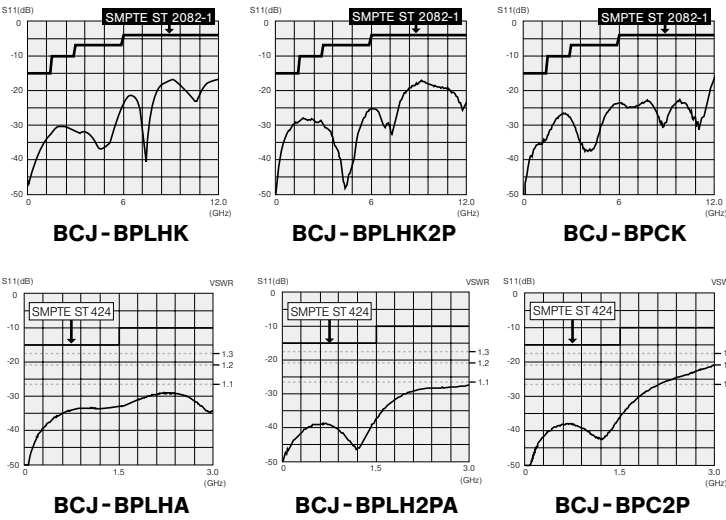

**BCJ-BPLHK**  
**12G-SDI**



**BCJ-BPLHA**

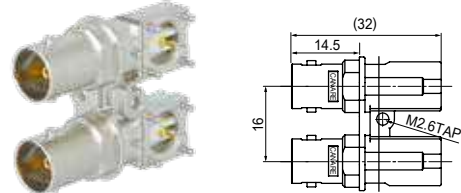

**BCJ-BPLHK2P**  
**12G-SDI**

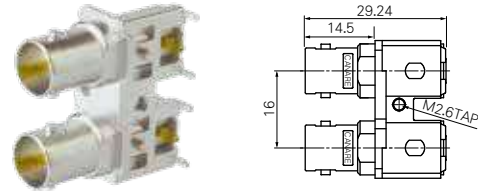

**BCJ-BPLH2PA**

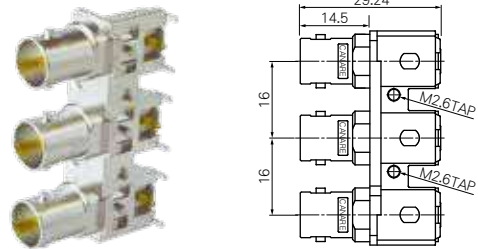

**BCJ-BPLH3PA**



**BCJ-BPCK**  
**12G-SDI**

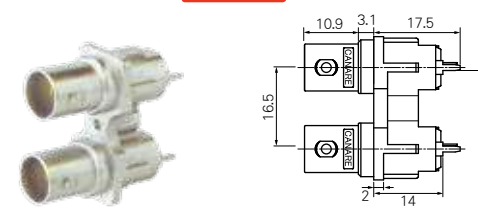

**BCJ-BPC2P**

	BCJ-BPLHK	BCJ-BPLHA	BCJ-BPLHK2P BCJ-BPLH2PA	BCJ-BPLH3PA	BCJ-BPCK	BCJ-BPC2P
Panel Hole Dim.						
PCB Hole Dim.						



# Connectors

## Active BNC

### 12G-SDI Active BNC New

12G-SDI Active BNC integrating I/O interface device inside. It frees you from struggling with PCB design coping with return loss and board space.

#### BCAK 12G-SDI

\*Card Edge Connector NOT included

Model	Form	Type	Built-in IC
<b>BCAK-TL</b>	Right Angle	TX	Cable Driver
<b>BCAK-RL</b>		RX	Cable Equalizer
<b>BCAK-BL</b>		BiDi	Cable Driver & Equalizer
<b>BCAK-TS</b>	Straight	TX	Cable Driver
<b>BCAK-RS</b>		RX	Cable Equalizer
<b>BCAK-BS</b>		BiDi	Cable Driver & Equalizer

Sales unit : 5 pcs

- Assembled on a PC board with SMT Card Edge Connector. The pluggable 2-piece structure improves productivity and replaceability.

\*Card Edge Connector sold separately

- Supports 12G/6G/3G/HD/SD-SDI
- Reduce entire development cost as well as development period.
- 16 mm : Minimum pitch between adjacent connectors
- Straight models can be mounted on the same board at the same height as 3G-SDI Active BNC.
- PIN control : status monitoring and mode change
- Command control for optimization and characterization
- Cable driver and equalizer with reclocker
- TX/RX/BiDi identification by insulation color

#### SMT Card Edge Connectors 12G-SDI

Model	Form	Suit for
<b>AKU-20LFYG</b>	Right Angle	BCAK-TL/RL/BL
<b>AKU-20SFYG</b>	Straight	BCAK-TS/RS/BS

Sales unit : 5pcs

- Card Edge Connector for BCAK.
- Same footprint for TX, RX and BiDi.
- Applicable for reflow soldering.

#### Specifications

Type	TX	RX	BiDi TX mode	BiDi RX mode
<b>Supply Voltage</b>	DC 2.5 V			
<b>Current Consumption</b>	195 mA	125 mA	128 mA	115 mA
<b>Operating Temperature</b>	-40 deg C to +85 deg C			
<b>Output Amplitude</b>	800 mV	N/A	800 mV	N/A
<b>Equalization</b>	N/A	12G-SDI 100m over L-5.5CUHD	N/A	12G-SDI 100m over L-5.5CUHD
<b>Standards</b>	SMPTE ST 2082-1, 2081-1, 424, 292, 259 BTA S-004C, EN 50083-9			
<b>Weight</b>	Right Angle: 9 g, Straight: 10 g			

	Right Angle	Straight
<b>Panel Hole Dim.</b>		
<b>PCB Hole Dim.</b>		

The dark shaded areas come into contact with the connector body.



**BCAK-TL**



**BCAK-TS**



**BCAK-RL**



**BCAK-RS**



**BCAK-BL**



**BCAK-BS**

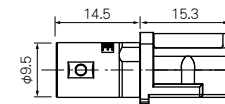

(Right Angle)

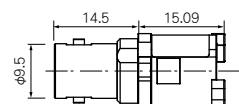

(Straight)



**AKU-20LFYG**



**AKU-20SFYG**

#### <Color Identifications>

Example) front view of Right Angle



**TX**  
Insulation color  
white



**RX**  
Insulation color  
black



**BiDi**  
Insulation color  
light gray

### 3G-SDI Active BNC

Small BNC connector incorporates either a cable equalizer or a cable driver. Active BNC makes innovation in your 3G-SDI PC board layout.

Model	Form	Type	Built-in IC
BCA-TL	Right Angle	TX	Cable Driver
BCA-RL		RX	Cable Equalizer
BCA-TS	Straight	TX	Cable Driver
BCA-RS		RX	Cable Equalizer

Sales unit: 5 pcs

- BNC connector integrated with a cable equalizer or a cable driver, and yet keep the connector size to a minimum.
- Support 3G/HD/SD-SDI
- Offers an excellent return loss performance without designing 75Ω I/O Circuit
- Simplifies PCB design process dramatically and will reduce entire development cost
- PCB space saving and help to downsize devices
- TX/RX identification by insulation color

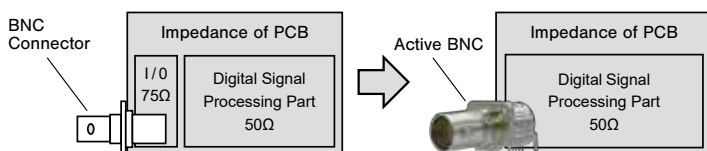

Simplify Your Circuit Design

#### <Color Identifications>

Example) front view of Right Angle

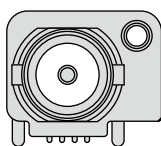

**TX**  
Insulation color white

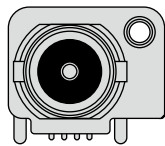

**RX**  
Insulation color black

#### ■ Specifications

Model	TX BCA-TL, BCA-TS	RX BCA-RL, BCA-RS
Supply Voltage	DC 3.3V	
Current Consumption	50mA	70mA
Operating Temperature	-25 deg C to +85 deg C	
Output Amplitude	800mVpp	N/A
Equalization	N/A	3G-SDI 120m over L-5CFB
Standards	SMPTE ST 424, 292, 259, BTA S-004C, EN 50083-9	
Weight	9g	



BCA-TL

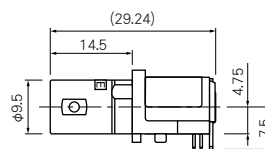

(Right Angle)



BCA-RS

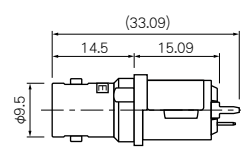

(Straight)

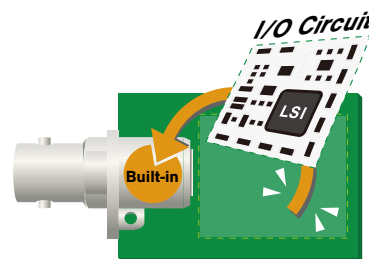

Space-saving

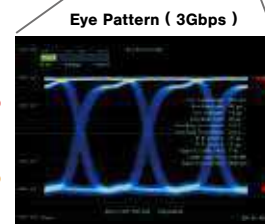
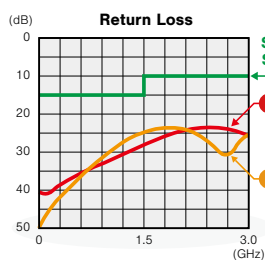
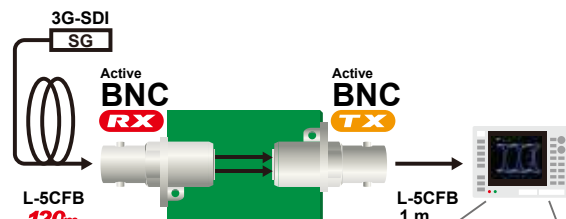

	BCA-TL	BCA-RL	BCA-TS	BCA-RS
Panel Hole Dim.	<p>t1.6 Screw: M2.6</p>		<p>t1.6 Screw: M2.6</p>	
PCB Hole Dim.	<p>Pin 8 5 1234 1: GND 2: SDI+ 3: SDI- 4: Vcc 5: SD/HD 6: - 7: - 8: ENABLE</p> <p>t2.0 (TOP VIEW)</p>	<p>Pin 1234 1: GND 2: SDO- 3: SDO+ 4: Vcc</p> <p>t2.0 (TOP VIEW)</p>	<p>Pin 4321 5 8 1: GND 2: SDI+ 3: SDI- 4: Vcc 5: SD/HD 6: - 7: - 8: ENABLE</p> <p>t2.0 (TOP VIEW)</p>	<p>Pin 4321 1: GND 2: SDO- 3: SDO+ 4: Vcc</p> <p>t2.0 (TOP VIEW)</p>

The dark shaded areas come into contact with the connector body.

# Connectors

## 75Ω BNC, 75Ω N, Connectors

### BNC Dust Caps

Model	Description
<b>BCJ-DC</b>	Polyethylene (Black)
<b>BCJ-DC-CH</b>	Polyethylene (Black) with string

• Standard package (20pcs/100pcs)

- Protects unused BNC receptacles from dirt and dust.



**BCJ-DC**

### BNC - RCA Adapter

Model	Description
<b>BCP-RCAJ</b>	RCA Jack (F) to BNC Plug (M)
<b>BCJ-RCAP</b>	BNC Jack (F) to RCA Plug (M)

• Standard package (1pc)

- Gold plated center contact
- Secure finger grip and reliable mating



**BCP-RCAJ**



**BCJ-RCAP**

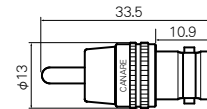
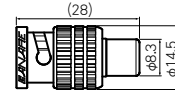

### 75Ω N Solder Plug

Return Loss: 26.4 dB @ 2 GHz

Model	Suitable Cable
<b>NCP-H8HD</b>	L-8CHD

• Standard package (1pc)

- Gold plating on the contact pin prevents deterioration, even after years of use.
  - Return loss: 26.4 dB @ 2 GHz
  - Solder type
- Tools required: 17 mm and 21 mm wrenches

**Caution:** The connecting section of the N connector uses a shape that conforms to the IEC169-16's 75Ω impedance standard. Note that the 50Ω N and other connectors that do not conform to this specification cannot be connected.



**NCP-H8HD**

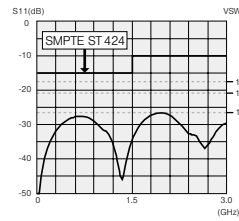
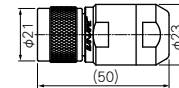

**Return loss for NCP-H8HD**

### 75Ω N to BNC Adapter

Return Loss: 26.4 dB @ 2 GHz

Model	Description
<b>NCJ-BCJR</b>	N (F) - BNC (F)

• Standard package (1pc)

- Beryllium copper (gold plated) is used on the center contact for its superior spring characteristics.
- Return loss: 26.4 dB @ 2 GHz
- Panel mountable as well. For isolation from the panel, use Canare isolation bushing IU-7/16.(see page 32)



**NCJ-BCJR**

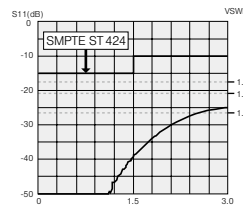
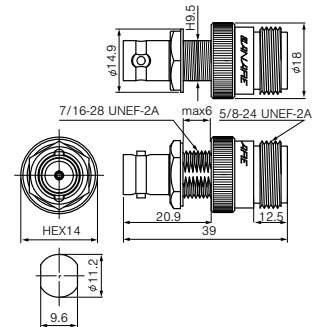

**Return loss for NCJ-BCJR**

**Panel Hole Dimensions**

**75Ω Micro BNC Connectors**

Micro BNC connectors supporting 12G-SDI. The micro BNC is about half the size of standard BNC and is ideal for high-density mounting.

**■ Crimp Plugs 12G-SDI**

Return Loss : 20 dB @ 3 GHz, 8 dB @ 12 GHz

Model	Suitable Cable		Center Pin	Sleeve	Die Set
	Canare	Others			
<b>HBCP-D25HD</b>	L-2.5CHD, L-2.5CHLT	1855A	BN1198	BN7155	TCD-D253F
<b>HBCP-D25HW</b>	L-2.5CHWS, V4-2.5CHW	—	BN1198	BN7141	TCD-D253F
<b>HBCP-D33UHD</b>	L-3.3CUHD	—	BN1199	BN7003A	TCD-D253F
<b>HBCP-D53</b>	L-4.5CHD	1694A	BN1200	BN7157	TCD-D534F

• Standard package (20 pcs)

**Key Features and Benefits**

- Compatible with the Amphenol line of HD-BNC connectors
- SMPTE ST 2082-1 compliant
- Canare crimp design ensures quick and reliable installation
- Gold plated “snap locks” center pin
- Beryllium copper outer contact

Be sure to use Canare Crimp Tool

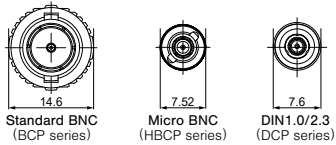

\* The values are not the maximum diameter of the plugs.

**■ PCB Mount Receptacles 12G-SDI**

Return Loss : 20 dB @ 3 GHz, 10 dB @ 12 GHz

Model	Description	Nut Driver Bit
<b>HBCJ-LRK</b> <span style="color:red">New</span>	Right Angle	NDT-HBC
<b>HBCJ-LRK/1</b> <span style="color:red">New</span>	Right Angle, Long type	NDT-HBC
<b>HBCJ-FEMK</b> <span style="color:red">New</span>	Edge Mount	NDT-HBC

• Standard package (20 pcs)

- SMPTE ST 2082-1 compliant
- Combination of HBCJ-LRK/1 and HBCJ-FEMK is effective for staggered arrangement.

**Note:** Nut driver bit NDT-HBC is required.

**■ Adapters 12G-SDI**

Return Loss : 20 dB @ 3 GHz, 10 dB @ 12 GHz

Model	Description	Nut Driver Bit
<b>HBCJ-JRK</b> <span style="color:red">New</span>	Jack to Jack	NDT-HBC (for panel mounting)
<b>BCJ-HBCJK</b> <span style="color:red">New</span>	BNC Jack to Micro BNC Jack	

• Standard package (20 pcs)

- SMPTE ST 2082-1 compliant
- Panel mountable

**<Panel Hole Dim.>**

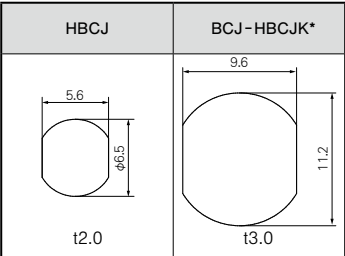

**<PCB Hole Dim.>**

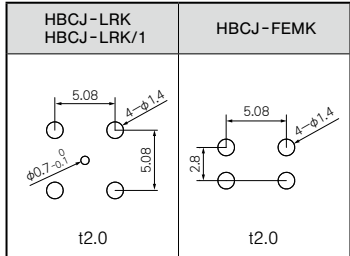

\* BCJ-HBCJK accept insulation bushing IU-7/16. See page 32 for the panel hole with IU-7/16.

**■ Tools**

Model	Description	Suitable Connector
<b>NDT-HBC</b> <span style="color:red">New</span>	Nut driver bit, 6.35 mm (1/4") hex shank	HBCJ, BCJ-HBCJK
<b>BET-D/H</b> <span style="color:red">New</span>	Extraction tool	DCP-C, HBCP-C

• Extraction tool BET-D/H is available for both Canare Micro BNC and DIN plugs.



**HBCP-D25HD**

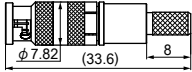

**HBCP-D25HD**

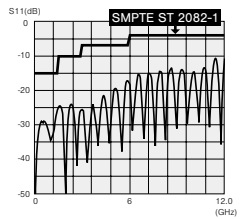

**Return Loss for HBCP-D25HD**



**HBCJ-LRK**

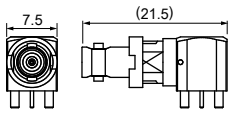

**HBCJ-LRK**



**HBCJ-LRK/1**



**HBCJ-FEMK**



**HBCJ-JRK**



**BCJ-HBCJK**



**NDT-HBC**



**BET-D/H**

Technical Trend  
Fiber-Optic Systems  
Connectors  
Cables  
Panels & Patchbays  
Multichannel Systems  
Cable Assemblies

# Connectors

## 75Ω DIN Connectors

### 75Ω DIN 1.0/2.3 Connectors

Mini coax connectors IEC61169-29 and DIN 47 297 compatible.

#### ■ Crimp Plugs

Return Loss : 20.8 dB @ 3 GHz

Model	Suitable Cable		Center Pin	Sleeve	Die Set
	Canare	Others			
<b>DCP-C25HD</b>	L-2.5CHD, L-2.5CHLT	1855A, VDM230	BN1148	BN7136	TCD-D253F
<b>DCP-C25HW</b>	L-2.5CHWS, V4-2.5CHW	—	BN1148	BN7141	TCD-D253F
<b>DCP-C3F</b>	L-3CFB	—	BN1148	BN7003A	TCD-D253F
<b>DCP-C4F</b>	L-4CHD, L-4CFB	1505A, VPM2000	BN1158	BN7015A	TCD-D534F
<b>DCP-C53</b>	L-4.5CHD	1694A, VSD2001	BN1157	BN7138	TCD-D534F

• Standard package (20pcs/100pcs)

- Our unique ball-locking mechanism offers smooth and reliable mating.
- Canare crimp design ensures quick and reliable installation.
- Elongated body design enables stable finger grip.
- Return loss : 20.8 dB or greater up to 3 GHz
- Extraction tool : BET-DIN or BET-D/H (see page 47)

US Patent No. : 8764473 B2

Be sure to use Canare Crimp Tool



**DCP-C25HD**

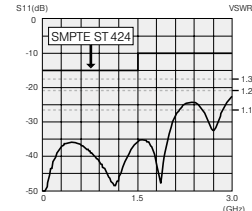

Return Loss for DCP-C25HD

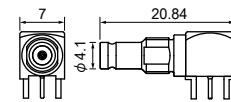

**DCJ-LR**

#### ■ PCB Mount Receptacles

Return Loss : 20.8 dB @ 3 GHz

Model	Description	Nut Driver Bit
<b>DCJ-LR</b>	Right Angle	NDT-DIN
<b>DCJ-LR/1</b>	Right Angle, Long type	
<b>DCJ-FEM</b>	Edge Mount	

• Standard package (20 pcs)

- Compact design ideal for high density mounting and downsizing devices.
- Combination of DCJ-LR/1 and DCJ-FEM is effective for staggered arrangement.
- Return loss : 20.8 dB or greater up to 3 GHz.

**Note :** Nut driver bit NDT-DIN is required.

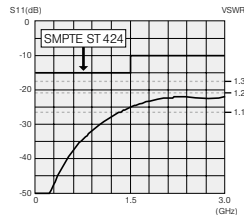

Return Loss for DCJ-LR

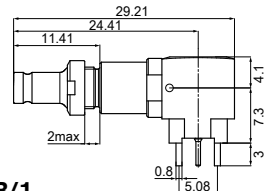

**DCJ-LR/1**

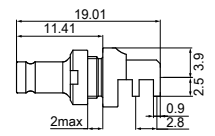

**DCJ-FEM**

#### ■ Adapters

Return Loss : 26.4 dB @ 3 GHz

Model	Description	Panel Mount	Nut Driver Bit
<b>DCJ-JR</b>	Jack to Jack	Yes	NDT-DIN
<b>BCJ-DCJ</b>	BNC Jack to DIN1.0/2.3 Jack	Yes	N/A
<b>BCP-DCJ</b>	BNC Plug to DIN Jack	No	N/A

• Standard package (20 pcs)

- Return loss : 26.4 dB or greater up to 3 GHz.

**Note :** Nut driver bit NDT-DIN is required for DCJ-JR

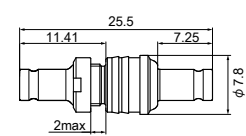

**DCJ-JR**

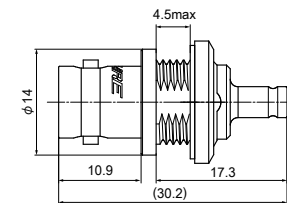

**BCJ-DCJ**

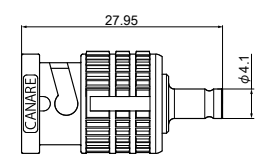

**BCP-DCJ**

#### <Panel Hole Dim.>

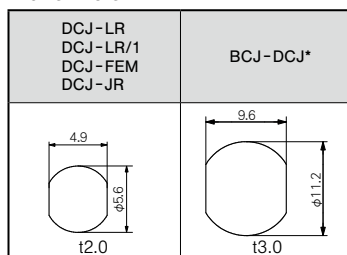

#### <PCB Hole Dim.>

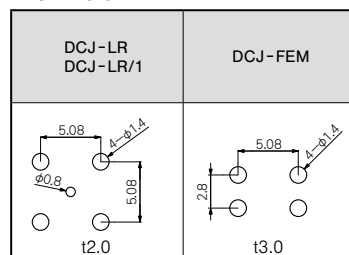

\*BCJ-DCJ accepts insulation bushing IU-7/16. See page 32 for the panel hole with IU-7/16.

#### ■ Nut Driver Bit

Model	Description
<b>NDT-DIN</b>	6.35mm (1/4") hex shank

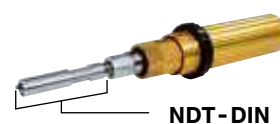

**NDT-DIN**



75Ω Micro-miniature Coaxial Connectors

Canare's exclusive micro miniature connectors, KC series: specially designed for 4K/8K UHD equipment. Our PCB mount solutions provide flexible layout and reliable connectivity on 12G-SDI signal path. Products are 12GHz verified and guaranteed SMPTE ST2082-1.

PCB Mount Receptacles **12G-SDI**

Model	Description
KCM-PC	Straight
KCM-LR	Right Angle

• Standard package (20 pcs)

KC to BNC Conversion Adapter **12G-SDI**

Model	Description	Nut Driver Bit
BCJ-KCM	Rear Mount, Hex Nut	—
BCJ-FKCM	Front Mount, Grooved Nut	NDT-7/16

• Standard package (20 pcs)

Note: BCJ-FKCM requires the nut driver bit NDT-7/16 for installation and removal. Contact for the details.

Cable Assemblies **12G-SDI**

Model	Description	
	Plug A	Plug B
KC1.2R-****-S	Straight	Straight
KC1.2R-****-L	Right Angle	Right Angle
KC1.2R-****-SL	Straight	Right Angle

Jacket: FEP (blue)  
\*\*\*\*: cable length (see below)

<Ordering Information>

KC1.2R - **0015** - **S**

Length	Plug Type
<b>0015</b> 150 mm	<b>S</b> Straight
<b>0020</b> 200 mm	<b>L</b> Right Angle
<b>0030</b> 300 mm	<b>SL</b> Straight to Right Angle

Custom length available. Contact for the details.

Key Features and Benefits

- DC to 12 GHz; meets the SMPTE 2082-1 return loss requirements.  
Return loss: 26 dB @ 1.5 GHz, 20 dB @ 3 GHz, 15 dB @ 6 GHz, 10 dB @ 12 GHz
- Snap-on engaging
- Durable design; beneficial for maintenance.
- Temperature range: -25 to 85 degree C
- The best flexibility on PCB design

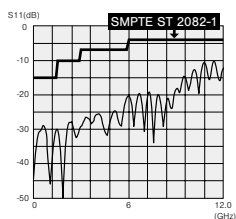

Return Loss Interface to Termination (reference)

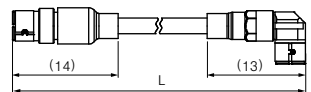
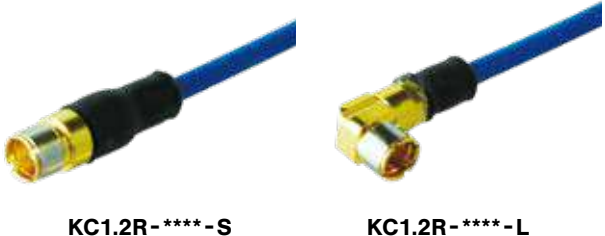
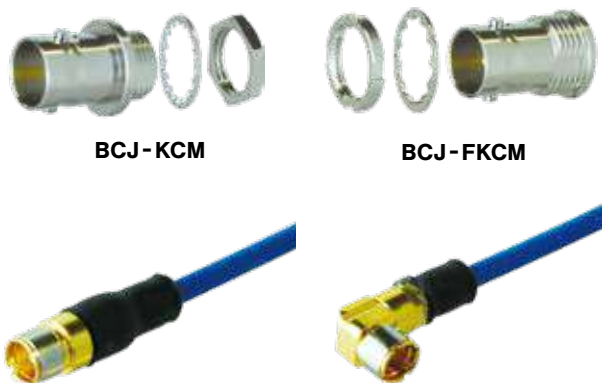
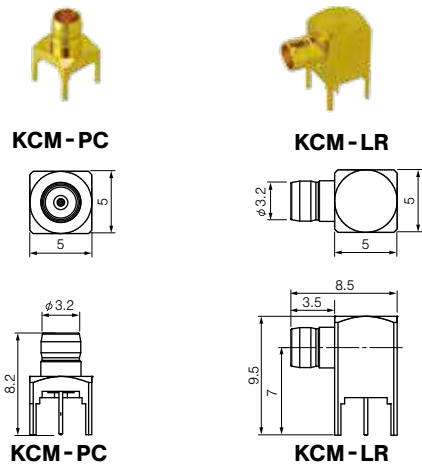

KC1.2R-\*\*\*\*-SL

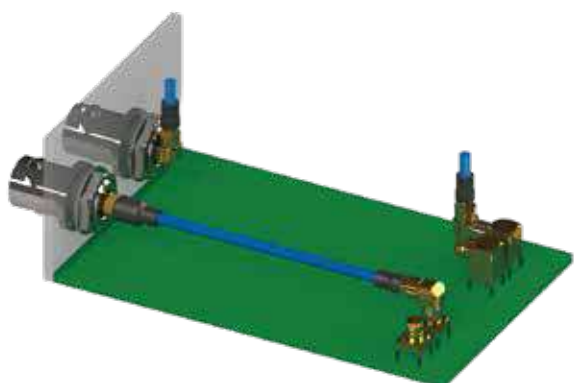

<Example of Use>

Technical Trend  
Fiber-Optic Systems  
Connectors  
Cables  
Panels & Patchbays  
Multichannel Systems  
Cable Assemblies

# Connectors

## 75Ω Multichannel Coax Connectors

### 4K-DIN Coax Connectors

Canare unique “4K-DIN” allows you to connect or disconnect 4 of 3G-SDI signals in one easy step.

#### ■ Crimp Plugs

Return Loss: 20 dB @ 3 GHz

Model	Suitable Cable	Die Set	Description
<b>MDM-V4C25HW</b>	V4-2.5CHW	TCD-D253F	Male
<b>MDF-V4C25HW</b>	V4-2.5CHW	TCD-D253F	Female

#### ■ Flush-mount Receptacle

Return Loss: 20 dB @ 3 GHz

Model	Description
<b>MDF-V4JRU</b>	Jack to Jack

- 75Ω 4-channel coax connector with push-pull locking mechanism.
- Compact, solid, and lightweight nylon resin (PA 66) body
- Return loss: 20 dB @ 3 GHz
- MDF-V4JRU accepts MDM-V4C25HW and also DIN 1.0/2.3 plugs.

\* Replacement crimp units also available:  
DCP-C25HW-ML for MDM  
DCJ-C25HW-ML for MDF

#### <Connection Example>

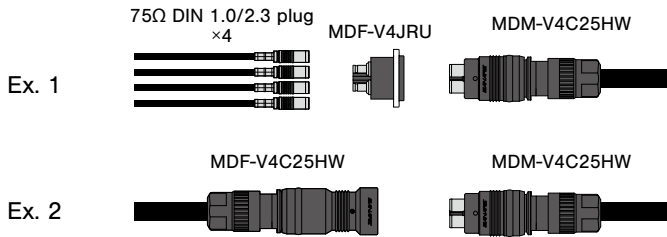

Be sure to use Canare Crimp Tool

### 75Ω Multi-pin Coax Connectors

Handles five 75Ω coaxial connections.

Model	Suitable Cable	Die Set	Description
<b>MCM-V5C3</b>	V5-3C	TCD-35CA	Plug
<b>MCF-V5C3</b>	V5-3C, L-3C2V, L-3C2VS	TCD-35CA	Receptacle

Model	Description
<b>DCM01</b>	Dust Cap for MCM-V5C3
<b>DCF01</b>	Dust Cap for MCF-V5C3

- 1.2 or less VSWR up to 1.5 GHz.
  - Crimp system ensures quick and reliable installation.
- \* Replacement unit also available. MCM-V5C3: BN9078A MCF-V5C3: BN9079B

Be sure to use Canare Crimp Tool



**MDM-V4C25HW**



**MDF-V4C25HW**

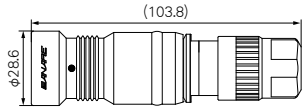

**MDF-V4JRU**

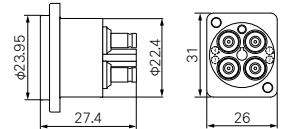

#### Hole Dimensions

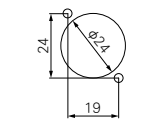

Min. 44 mm pitch (recommended)



**MCM-V5C3**



**MCF-V5C3**

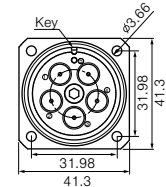
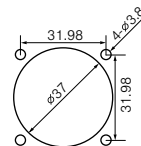
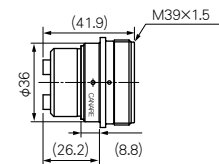
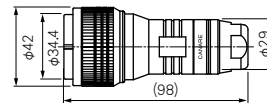

**Panel Hole Dimensions**  
(Mounting screw M3 × 4 pcs)

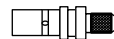

Replacement Unit **BN9078A**

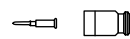

Replacement Unit **BN9079B**

75Ω Triaxial Connectors

Canare CC series cover global triaxial interconnection. CC-F series are ideal for interconnecting European triax system and CC- K series for American triax system.

Key Features and Benefits

- True 75Ω, DC 1.5 GHz; ≥20 dB return loss (≤1.2 VSWR)
- Push-lock mechanism
- Reliable crimp system
- Rugged and durable construction

■ CC-F Series: European preferred type

Model	Description	Suitable Cable		Boot/Cap	Center contact	Sleeve A	Sleeve B	Crimp Tool
		Canare	Others					
CCF5-JFC	Crimp type, Female cable mount	L-5CFTX	Belden: 7783A Klotz : TRIAX8 Fujikura: 4.8/1.0 EFTXF	CB31	BN9194	BN7120	BN7121	TC-1 + TCD-65C
CCM5-PFC	Crimp type, Male cable mount			CB32	BN1135			
CCF5-JFRC	Crimp type, Female panel mount			DCF02	BN9194			
CCM5-PFRC	Crimp type, Male panel mount			DCM02	BN1135			
CCF7-JFC	Crimp type, Female cable mount	L-7CFTX	Belden : 7784AS Klotz : TRIAX11 Fujikura : SUPERFLEX11	CB31	BN9182A	BN7113	BN7114	TC-2 + TCD-96C
CCM7-PFC	Crimp type, Male cable mount			CB32	BN1131			
CCF7-JFRC	Crimp type, Female panel mount			DCF02	BN9182A			
CCM7-PFRC	Crimp type, Male panel mount			DCM02	BN1131			

■ CC-K Series: U.S. preferred type

Model	Description	Suitable Cable		Retrofit Kit	Boot/Cap	Crimp Tool
		Canare	Others			
CCF4-JK	Crimp type, Female cable mount	L-4CFTX	Belden: 1856A, 1857A, 9267 Geppo: LVT61859, VT61859	BN9127A	CB23	TC-1 + TCD-316C
CCM4-PK	Crimp type, Male cable mount			BN9128B	CB22	
CCF4-JKR	Crimp type, Female panel mount			BN9127A	DCM02	
CCM4-PKR	Crimp type, Male panel mount			BN9128B	DCM03	

# Connectors

## RCA Connectors

### RCA Pin Connectors

#### ■ Crimp Plugs

Model	Suitable Cable		Center Pin	Sleeve	Boot	Die Set
	Canare	Others				
<b>RCAP - C25F</b>	L-2.5CFB	1855A, 8218, 1417B, 1418B	B11014E	BN7029C	—	TCD-35CA
<b>RCAP - C25HD</b>	L-2.5CHD	—	B11015E	BN7129	—	TCD-35CA
<b>RCAP - C3A</b>	L-3C2VS, L-3C2V, V*-3C	—	B11014E	BN7003A	CB24	TCD-35CA
<b>RCAP - C3GS</b>	GS-6	—	BN1093	BN7079	CB25	TCD-35D
<b>RCAP - C3F</b>	L-3CFB, V*-3CFB	—	B11015E	BN7003A	CB24	TCD-35CA
<b>RCAP - C42</b>	—	1505F	B11016E	BN7011	—	TCD-31C
<b>RCAP - C4A</b>	LV-61S	8241, 8279, RG-59B/U	B11015E	BN7015A	CB25	TCD-4CA, TCD-451CA
<b>RCAP - C4F</b>	L-4CFB, V*-4CFB	1505A, 1505ANH, 8212, 8241F, 9167, 9259, 9659	B11016E	BN7015A	CB25	TCD-4CA, TCD-451CA
<b>RCAP - C53</b>	L-4.5CHD	1694A, 9066, 9116, 9118, 9248	B11020D	BN7016	CB26	TCD-35CA
<b>RCAP - C5A</b>	L-5C2VS, L-5C2V, V*-5C	—	B11016E	BN7016	CB26	TCD-35CA
<b>RCAP - C5F</b>	L-5CFB, V*-5CFB	—	B11020D	B75004A	CB26	TCD-5CF, TCD-55FA
<b>RCAP - C77</b>	LV-77S	8281F	B11016E	B75004A	CB26	TCD-5CF, TCD-55FA

• Standard package (20pcs/100pcs)

- Canare crimp design ensures quick and reliable installation.
- The crimp tool for the RCAP-C can be used for the Canare crimp BNC plugs as well, thus saving on extra equipment.

Be sure to use Canare Crimp Tool

#### ■ Solder Plugs

Model	Description
<b>F-09</b>	Plug
<b>F-10</b>	Plug (long sleeve)

• Standard package (10 pcs)

- Robust metal shell
- Comfortable grip
- Cable O.D. up to 6.0 mm.

#### ■ Standoff Receptacle

Model	Description
<b>RJ-JR</b>	Jack to Jack

• Standard package: 20 pcs by insulation color

- Insulation color is available in 5 colors (red, green, blue, yellow, white).
- VSWR 1.2 @ 100 MHz

#### ■ Flush-mount Receptacles

Model	Description	Flange Type
<b>RJ-RU</b>	RCA - Solder	ITT XLR-F77
<b>RJ-RUD</b>		Neutrik D
<b>RJ-RUDB</b>		Neutrik D (Black)
<b>RJ-JRU</b>	RCA - RCA	ITT XLR-F77
<b>RJ-JRUD</b>		Neutrik D
<b>RJ-JRUDB</b>		Neutrik D (Black)
<b>RJ-BCJRU</b>	RCA - BNC	ITT XLR-F77
<b>RJ-BCJRUD</b>		Neutrik D
<b>RJ-BCJRUDB</b>		Neutrik D (Black)

• Standard package: 20 pcs by insulation color

- Three types of flanges are available.
- Insulation color is available in 5 colors (red, green, blue, yellow, white).
- VSWR 1.2 @ 100 MHz

#### <Panel Hole Dimensions>

RJ-JR (*)	ITT XLR-F77 Flange	Neutrik D Flange

(\*) RJ-JR accepts insulation bushing IU-7/16; in this case, panel hole for IU-7/16 should be adopted (see page 32)



**RCAP - C3A**



**F-09**



**F-10**



**RJ - JR**

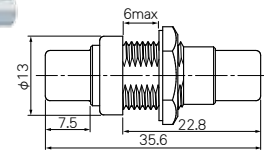

**RJ - JR**



**RJ - RU**

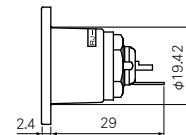

**RJ - RU**



**RJ - JRUD**

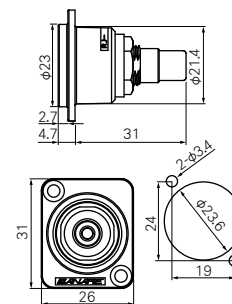

**RJ - JRUD**



**RJ - BCJRU**

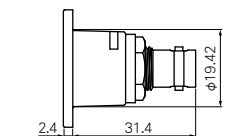

**RJ - BCJRU**

F Connectors

This type is used in such applications as home television receivers for cable television (CATV) systems.

■ Crimp Plugs

Model	Suitable Cable		Center Pin	Sleeve	Boot	Die Set
	Canare	Others				
FP-C25HD	L-2.5CHD	—	BN1003B	BN7129	—	TCD-35CA
FP-C3	L-3C2VS, L-3C2V, V*-3C	—	BN1002B	BN7003A	CB24	TCD-35CA
FP-C31	L-3C2W	—	BN1002B	BN7011	CB25	TCD-31C
FP-C3F	L-3CFB, V*-3CFB	—	BN1003B	BN7003A	CB24	TCD-35CA
FP-C4	LV-61S	8241, 8279, RG-59B/U	BN1003B	BN7015A	CB25	TCD-4CA, TCD-451CA
FP-C4F	L-4CFB, V*-4CFB	1505A, 1505ANH, 8212, 8241F, 9167, 9259, 9659	BN1004B	BN7015A	CB25	TCD-4CA, TCD-451CA
FP-C5	L-5C2VS, L-5C2V, V*-5C	—	BN1004B	BN7016	CB26	TCD-35CA
FP-C52	L-5C2W	—	BN1004B	BN7014	—	TCD-451CA
FP-C53A	L-4.5CHD	1694A, 9066, 9116, 9118, 9248	BN1005B	BN7046	CB26	TCD-35CA
FP-C55A	—	1695A, 89120, 87120, 633948, 9116P	BN1005B	BN7045A	—	TCD-35CA
FP-C5F	L-5CFB, V*-5CFB	—	BN1005B	B75004A	CB26	TCD-5CF, TCD-55FA
FP-C71A	—	7731A, 9064, 9292, 1617A, 9011	BN1041A	BN7021A	—	TCD-7CA
FP-C7FA	L-7CFB	—	BN1030A	BN7021A	—	TCD-7CA

• Standard package (20pcs/100pcs)

- Lock mechanism improves reliability by preventing shifting or detaching of the center pin.
- The tools and cable stripper can be used for the Canare crimp BNC plugs as well, thus saving on extra equipment.
- VSWR of 1.1 or less up to 2 GHz.
- Designed for indoor use.

Be sure to use Canare Crimp Tool

■ Standoff Receptacle

Model	Description
FJ-JR	Jack to Jack
FJ-FPC	PC Board Straight Mount

• Standard package (20pcs/100pcs)

- VSWR of 1.1 or less up to 2 GHz. <Fig. 1>
- Accept insulation bushing IU-7/16. See page 32 for more information.

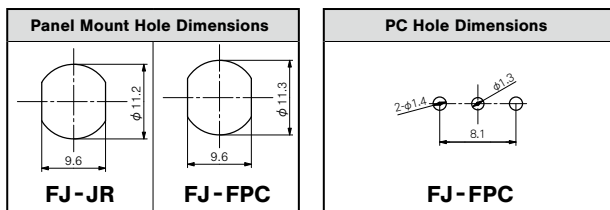

FP-C4

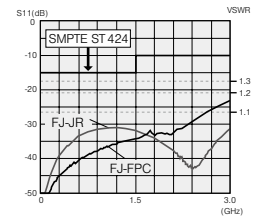

Fig.1 Return loss for FJ-FPC and FJ-JR



FJ-JR



FJ-FPC

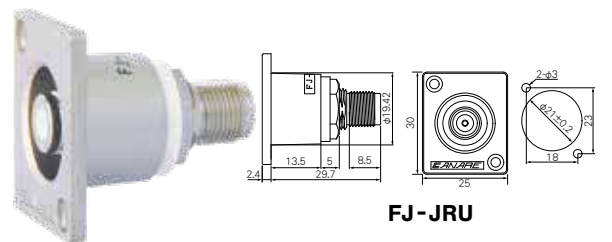

FJ-JRU

■ Flush-mount Receptacles

Model	Description	Flange Type
FJ-JRU	Jack to Jack	ITT XLR-F77
FJ-JRUD		Neutrik D
FJ-JRUDB		Neutrik D (Black)

• Standard package (20pcs)

- Three types of flanges are available.

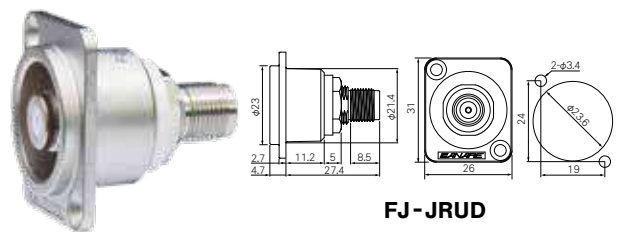

FJ-JRUD

Phone Plugs

Model	Description
F-11	3.5 mm Mini Phone TS
F-12	3.5 mm Mini Phone TRS
F-15	6.3 mm (1/4") TS Phone
F-16	6.3 mm (1/4") TRS Phone

• Standard package (10pcs)

- Featuring a properly cable crimp system ensures long life reliability.
- Suited to cables up to 6.0 mm in outer diameter.

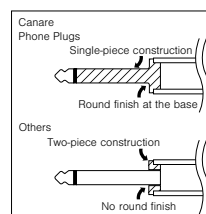

Canare's durable design



# Connectors

## 50Ω BNC Connectors

### 50Ω BNC Crimp Plugs

VSWR of 1.1 or less up to 2 GHz, 1.2 or less up to 4 GHz.

#### ■ Straight

Model	Suitable Cable	Center Pin	Sleeve	Boot	Die Set
BP-C3	L-3D2V, 3D-2V	BN1023A	BN7003A	CB03	TCD-35D
BP-C31	L-3D2W, 3D-2W	BN1023A	BN7011	CB04	TCD-3151D
BP-C4	RG-58C/U, RG-58A/U	BN1024A	BN7030A	CB03	TCD-35D
BP-C5	L-5D2V, 5D-2V	BN1025B	BN7016	CB05A	TCD-35D
BP-C51	L-5D2W, 5D-2W	BN1025B	BN7002	—	TCD-3151D
BP-C5FA	L-5DFB, 5D-FB	BN1016C	B75004A	CB05A	TCD-35DF TCD-55FA
BP-C51F	L-5DFBW-PE	BN1016C	BN7002	—	

• Standard package (20pcs)

#### ■ Right Angle

Model	Suitable Cable	Center Pin	Sleeve	Die Set
BP-LC31	L-3D2W, 3D-2W	BN1023A	BN7011	TCD-3151D
BP-LC51	L-5D2W, 5D-2W	BN1025B	BN7002	

• Standard package (20pcs)

- Lock mechanism used on insulation improves reliability by preventing shifting or detaching of the contact pins.
- Elongated body design for straight type enables easy attachment and removal.
- Gold plating on the contact pin prevents deterioration, even after years of use.
- Use of crimping to attach the connectors ensures quick, reliable installation.

Be sure to use Canare Crimp Tool



BP-C5



BP-LC31

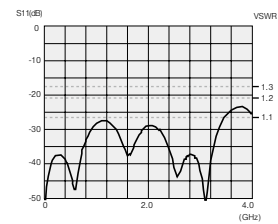

Return loss for BP-C31



BJ-JR

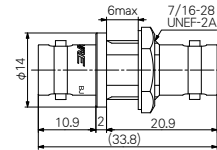

BJ-JR



BJ-JRU

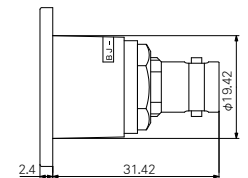

BJ-JRU

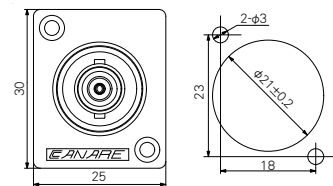

### 50Ω BNC Receptacles

#### ■ Standoff

Model	Description
BJ-JR	Jack to Jack

• Standard package (20pcs)

- Mounting hole size is same as that for BCJ-R/1 connector.

#### ■ Flush-mount Receptacles

Model	Description	Flange Type
BJ-JRU	Jack to Jack	ITT XLR-F77
BJ-JRUD		Neutrik D

• Standard package (20pcs)

- Two types of flanges are available.
- Flush-mount receptacle prevents damage on the jack.



BJ-J

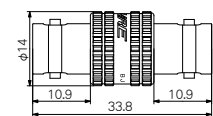

BJ-J

### 50Ω BNC Extension Adapter

Model	Description
BJ-J	Jack to Jack

• Standard package (20pcs)

- VSWR of 1.1 or less up to 4 GHz.

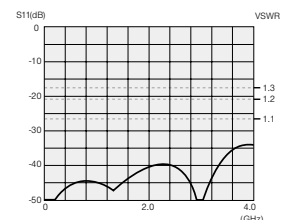

Return loss for BJ-J

50Ω TNC Crimp Plugs

■ Straight

Model	Suitable Cable	Boot	Die Set
TNP-C3	L-3D2V, 3D-2V	CB03	TCD-35D
TNP-C31	L-3D2W, 3D-2W	CB04	TCD-3151D
TNP-C4	RG-58C/U, RG-58A/U	CB03	TCD-35D
TNP-C5	L-5D2V, 5D-2V	CB05A	
TNP-C51	L-5D2W, 5D-2W	—	TCD-3151D
TNP-C5F	L-5DFB, 5D-FB	CB05A	TCD-35DF TCD-55FA

• Standard package (20pcs)

■ Right Angle

Model	Suitable Cable	Die Set
TNP-LC31	L-3D2W, 3D-2W	TCD-3151D
TNP-LC51	L-5D2W, 5D-2W	

• Standard package (20pcs)

- VSWR of 1.1 or less up to 2 GHz, 1.2 or less up to 4 GHz.
- Canare crimp design ensures quick and reliable installation

Be sure to use Canare Crimp Tool



TNP-C3

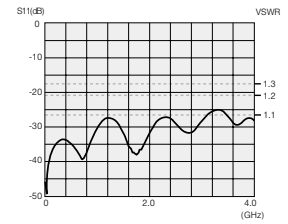

Return loss for TNP-C3

50Ω N Crimp Plugs

■ Straight

Model	Suitable Cable	Boot	Die Set
NP-C31	L-3D2W, 3D-2W	CB04	TCD-3151D
NP-C51	L-5D2W, 5D-2W	—	
NP-C5F	L-5DFB, 5D-FB	CB05A	TCD-35DF TCD-55FA
NP-C51F	L-5DFBW-PE	—	TCD-35DF TCD-55FA

• Standard package (20pcs)

■ Right Angle

Model	Suitable Cable	Die Set
NP-LC31	L-3D2W, 3D-2W	TCD-3151D
NP-LC51	L-5D2W, 5D-2W	

• Standard package (20pcs)

■ Straight Jack

Model	Suitable Cable	Boot	Die Set
NJ-C5F	L-5DFB, 5D-FB	CB05A	TCD-35DF TCD-55FA

• Standard package (20pcs)

- VSWR of 1.1 or less up to 2 GHz, 1.2 or less up to 4 GHz.
- Canare crimp design ensures quick and reliable installation

Be sure to use Canare Crimp Tool



NP-C51



NP-LC31

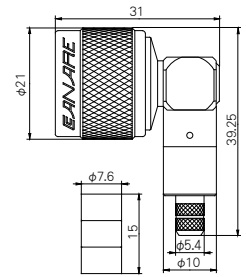

NP-LC31

50Ω SMA Crimp Plugs

■ Straight

Model	Suitable Cable	Die Set
SMAP-C1	1.5D-QEW	TCD-1DB
SMAP-C31A	L-3D2W, 3D-2W	TCD-3151D
SMAP-C3F	L-3DFB	TCD-35DF
SMAP-C51	L-5D2W, 5D-2W	TCD-3151D
SMAP-C5F	L-5DFB, 5D-FB	TCD-35DF, TCD-55FA

• Standard package (20pcs)

■ Straight Jack

Model	Suitable Cable	Die Set
SMAJ-C3F	L-3DFB	TCD-35DF
SMAJ-C51	L-5D2W, 5D-2W	TCD-3151D
SMAJ-C5F	L-5DFB, 5D-FB	TCD-35DF, TCD-55FA

• Standard package (20pcs)

- VSWR of 1.1 or less up to 2 GHz, 1.2 or less up to 4 GHz. (SMAP-C1: VSWR of 1.2 or less up to 2 GHz)
- Canare crimp design ensures quick and reliable installation (SMAP-C1 has solder center contact)

Be sure to use Canare Crimp Tool



SMAP-C1

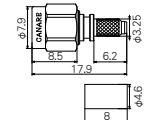

SMAP-C1



SMAP-C31A



SMAJ-C3F

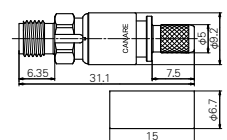

SMAJ-C3F

# Connectors

## Cable Stripper, Crimp Tools

### Coaxial Cable Stripper

Three internal circular steel blades perform precise, extremely clean and easy stripping.

Model	Preset to
<b>TS100E</b>	LV-77S-L-5CFB, V*-5CFB, V*-5C, LV-61S-L-4CFB, V*-3C
<b>TS100U</b>	L-2.5CHD, 1855A, 1505A, 1694A

- For most Canare BNC, DIN, RCA and F crimp plugs.
  - Rotary knob to select 5 different cable setups.
  - Make your own cable setting within cable O.D. 4mm~11mm
  - Hex wrench is attached on the lid top for quick adjustment.
  - One replacement blade included, and also sold separately.
- Replacement blade: TSC (1pc)

#### Note:

The following types of cables may not be accurately processed by Canare's TS100 Cable Stripper, owing to their construction.

1. Cables employing such hard jacket material as polyethylene.
2. Cables employing such particularly soft insulator material as high foam polyethylene.
3. Cables employing steel wire and semirigid pipe for outer conductor.

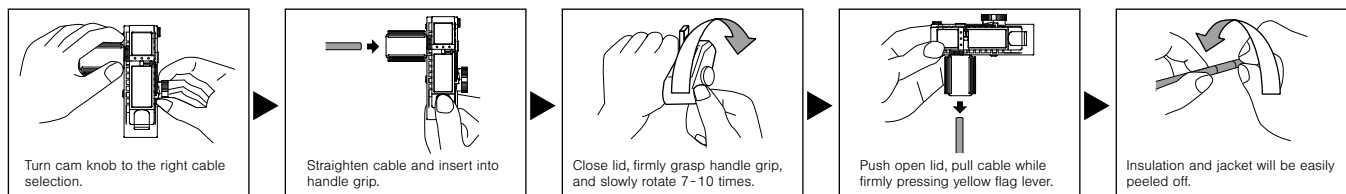

TS100E

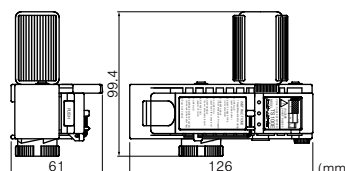

### Crimp Tools

Canare crimp tool offers reliable high-quality crimping performance in an easy-to-use design.

#### Die Sets

Model	Pin crimp		Sleeve crimp		Model
	#1 (mm)	#2 (mm)	#3 (mm)	#4 (mm)	
<b>TCD-1DB</b>	—	—	3.94	—	<b>TC-1</b>
<b>TCD-31C</b>	1.37	—	6.75	—	<b>TC-1</b>
<b>TCD-3151D</b>	1.92	—	8.36	6.75	<b>TC-1</b>
<b>TCD-316C</b>	1.35	—	9.4	6.75	<b>TC-1</b>
<b>TCD-35CA</b>	1.35	—	7.6	5.85	<b>TC-1</b>
<b>TCD-35D</b>	1.92	—	7.6	5.85	<b>TC-1</b>
<b>TCD-35DF</b>	1.92	2.1	8.05	5.82	<b>TC-1</b>
<b>TCD-4CA</b>	1.35	—	6.48	—	<b>TC-1</b>
<b>TCD-451CA</b>	1.35	—	8.36	6.4	<b>TC-1</b>
<b>TCD-5CF</b>	1.31	—	8.05	—	<b>TC-1</b>
<b>TCD-5HD</b>	1.87	—	8.05	—	<b>TC-1</b>
<b>TCD-55FA</b>	1.35	2.1	8.05	—	<b>TC-1</b>
<b>TCD-55UHD</b>	1.62	—	8.05	—	<b>TC-1</b>
<b>TCD-57C</b>	1.62	—	8.5	—	<b>TC-1</b>

#### Hand Crimp Tools

#### Die Sets

Model	Pin crimp		Sleeve crimp		Model
	#1 (mm)	#2 (mm)	#3 (mm)	#4 (mm)	
<b>TCD-65C</b>	1.92	—	9.4	7.6	<b>TC-1</b>
<b>TCD-67HD</b>	2.1	—	10.2	—	<b>TC-1</b>
<b>TCD-7CA</b>	1.87	—	10.2	—	<b>TC-1</b>
<b>TCD-8HD</b>	2.4	—	11.26	—	<b>TC-2</b>
<b>TCD-96C</b>	1.92	—	11.26	9.4	<b>TC-2</b>
<b>TCD-D253F</b>	1.1	—	5.1	5.85	<b>TC-1</b>
<b>TCD-D534F</b>	1.27	—	7.55	6.4	<b>TC-1</b>

#### Hand Crimp Tools

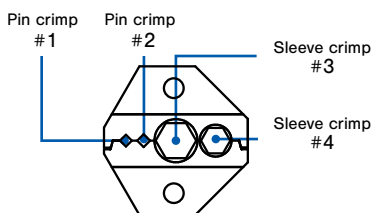

#### Accessories

Model	Description	Length
<b>TB-2A</b>	Tool case	—
<b>BET-BNC</b> <small>Coming Soon</small>	Extraction tool for BNC straight plug	300 mm
<b>BET-MBNC</b>	Extraction tool for MBNC series	300 mm
<b>BET-DIN</b>	Extraction tool for DCP-C series	300 mm
<b>BET-D/H</b> <small>New</small>	Extraction tool for DCP-C & HBCP series	300 mm



TB-2A  
(tools and connectors not included)

- Select the appropriate die set to suit the individual connector
- Hand crimp tool is required for die set, and sold separately
- Die set are interchangeable



TC-1



BET-BNC



BET-MBNC



BET-DIN



BET-D/H



**Crimp Connector Assembly Instructions**

	<p><b>Confirm compatibility of the connector and cable prior to assembly.</b></p> <ol style="list-style-type: none"> <li>Slide the crimp sleeve over the cable and strip the jacket, braided shield, and insulation of the coaxial cable as shown at left.             <ul style="list-style-type: none"> <li>For cables with stranded inner conductor, twist the strands in the same direction as plied after removing the insulation.</li> <li>For a crimp sleeve with steps, slip it over the cable from the stepped end, as in the diagram.</li> <li>If any metal foil shield is left on the cable, it may get stuck in the mouth of connector, making insertion impossible.</li> <li>Remove all stray strands and offcuts of the metal foil shield to avoid possible short circuiting.</li> <li>Make sure the inner conductor is free of all insulation debris and offcuts to ensure complete crimping.</li> </ul> </li> </ol>
	<ol style="list-style-type: none"> <li>Place the center contact pin of the connector on the inner conductor of the cable and crimp the center contact pin at the correct position (without remaining a gap) as shown at left, using the specified crimp tool and die set.             <ul style="list-style-type: none"> <li>To confirm the crimping properly, measure the crimp height after removing burrs with a knife. If it is not within the ideal value range, adjust the crimp tool.</li> <li>Do not crimp the center contact pin at the stepped root end.</li> <li>Confirm the center contact pin is crimped straight to the inner conductor. If the center contact pin is slanted, align it gently.</li> </ul> </li> </ol>
	<ol style="list-style-type: none"> <li>Hold the cable and push it into the connector body until the center contact is locked in place. You may feel a click sound when the center contact is locked.             <ul style="list-style-type: none"> <li>Pull the cable gently (less than 4.5 lbs or 19.6 N) to confirm that is locked.</li> </ul> </li> </ol>
	<ol style="list-style-type: none"> <li>Slide crimp sleeve up against connector body over the braided shield until it butts against the connector body. Center the die over the crimp sleeve and crimp in place, using the specified crimp tool and die set.             <ul style="list-style-type: none"> <li>Do not pull the cable while crimping is executed.</li> </ul> </li> </ol>

**Adjusting Crimp Tool**

**1. Measuring Crimping height**  
 Crimp height is measured after the crimp is made. As shown in the figure, the sum of the measured values for both directions is divided by two to arrive at the crimp height. The ideal value range for the BCP-A3 connector, for example, is 1.4 mm to 1.5 mm. When this value is lower (overcrimping occurs) than the recommended crimp height, the crimp becomes very hard. A value higher (undercrimping occurs) than the recommended value can result in increased electrical resistance and a physically weaker crimp. Either digital calipers or a micrometer should be used for measuring crimp height.

**2. Measuring Frequency**  
 Crimp height is measured prior to commencing use of the crimp tool and always when changing the crimping die. After this, the crimp height is regularly measured after about each 1,000 crimps.

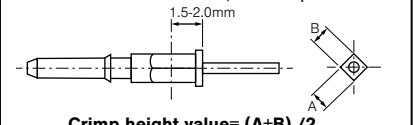

Refer to the separately included manual for the appropriate crimp height values for individual connectors.

**3. Tool Measuring Procedures**  
 Crimp force increases and crimp height decreases when the tool's adjuster dial is turned in the direction of the 9. The dial is adjusted by first releasing it using a screw driver.



**FAQ**

- Q** Does it matter in which direction crimp sleeves are attached?
- A** For BCP-A3-use and other non-stepped (straight type) crimp sleeves, it does not matter in which direction the crimp sleeve is attached. The attachment direction also does not matter for BCP-A5F-use and other specific-use types that have a chamfer (groove) at one end of the crimp sleeve. However, stepped crimp sleeves such as those for BCP-C1, etc. are directional and must be attached in the direction shown in the diagram below, with the cable threaded through the sleeve starting from the end with the step (that is, the end with smaller-diameter hole).
- 
- Q** What should be done with a metal foil shield?
- A** Strip the metal foil shield to the root of the braided shield (to the edge of the jacket). If any metal foil shield is left on the cable, it may get stuck in the mouth of connector, making insertion impossible.
- Q** Why do some BNC plugs made by other companies have a sharp point at the tip of the central contact? Are these compatible with Canare's BNC receptacles?
- A** The central contact is pointed in conformance with the JIS standard for 50Ω BNC connectors. The central contacts on Canare's connectors conform to the MIL standard, and therefore are not pointed. These two different shapes simply offer different ways to guide the plug into the female receptacle and have no direct effect on contact quality.

The actual contact surfaces on Canare's BNC connectors are designed in conformance with JIS standards and therefore pose no compatibility problems.

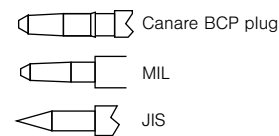

- Q** Is it possible to use cables not listed in the connector compatibility table as long as they are close to the dimensions of those listed?
- A** No. While connection may be possible, performance may be adversely affected. Even if the connection appears to work, factors such as electrical instability, weak cable contact strength and others may cause problems during actual use. Therefore, it is necessary to test and evaluate whether it is actually possible to use the configuration in question. Particular caution should be used when crimping is involved.
- Q** What is meant by "cable contact strength"?
- A** Cable contact strength refers to the maximum load borne by the cable when exerting tensile force to remove it from the connector. For Canare products, "cable contact strength" refers to the contact strength of a cable's outer conductor, not including the pull-out strength of the central contact or the contact strength of the inner conductor.
- Q** What is the approximate insertion loss associated with connectors?
- A** The value varies depending on the connector, but for BNC plugs, the value is approximately 0.1 dB per plug (DC-2 GHz).

# Connectors

## Crimp Tools

### Cables to Connector Cross-Reference

See page 45-46, for 50Ω cables and connectors.  
See page 48, for more information about the crimp height.  
These tables include cables of other brands such as Belden, Draka, and Gepeco.

#### ■ BNC, Slim BNC, F, RCA

Cable	BNC			Slim BNC	F	RCA	Multi-pin	Suitable Die Set	Crimp Height
	BCP-D/B	BCP-A/C	BCP-LC	MBCP-C	FP-C	RCAP-C	MCM/MCF		
L-1.5C2VS/V*-1.5C		BCP-C1						TCD-1DB	N/A (solder pin)
1.5C-2V		BCP-A25							1.40 - 1.47
L-2.5CFB		BCP-A25F		MBCP-C25F		RCAP-C25F			
1855A	BCP-B26								
1855P									
L-2.5CHD/L-2.5CHLT	BCP-B25HD				FP-C25HD	RCAP-C25HD		TCD-35CA	1.40 - 1.50
VDM230									
1855ENH	BCP-B28								
HD PRO 0.6/2.8 AF									
1506A		BCP-A32							
L-2.5CHWS	BCP-B25HW								
V4-2.5CHW									
L-3C2V/L-3C2VS		BCP-A3					MC*-V5C3		
V3-3C/V4-3C		BCP-A3	BCP-LC3		FP-C3	RCAP-C3A			
V5-3C		BCP-VA3					MC*-V5C3		
L-3CFB	BCP-B3F	BCP-A3F	BCP-LC3F	MBCP-C3F	FP-C3F	RCAP-C3F		TCD-35CA	
V*-3CFB									
L-3C-AHD		BCP-A3AHD							
L-3.3CUHD	BCP-D33UHD								
1695A		BCP-A55			FP-C55A				
VSD2001TS									
L-3C2W		BCP-A31			FP-C31			TCD-31C	
L-3CFW	BCP-B31F								
V*-3CFW									
LV-61S		BCP-A4		MBCP-C4	FP-C4	RCAP-C4A			
RG-59B/U								TCD-4CA or TCD-451CA	1.40 - 1.50
L-4CFB/V*-4CFB				MBCP-C4F	FP-C4F	RCAP-C4F			
1505A, 1505ANH	BCP-B4F	BCP-A4F							
HD PRO 0.8/3.7 AF									
VPM2000									
L-4CHD									
1505F		BCP-A42				RCAP-C42		TCD-31C	
L-4.5CHD	BCP-B53			MBCP-C53	FP-C53A	RCAP-C53			
1694A									
HD PRO 1.0/4.8 AF	BCP-B56								
L-4.5CHWS	BCP-B45HW							TCD-35CA	
L-5C2V/L-5C2VS		BCP-A5							
V*-5C		BCP-A5	BCP-LC5		FP-C5	RCAP-C5A			
BCP-VA5									
BCP-A77						RCAP-C77			
LV-77S									
L-5CFB	BCP-B5F	BCP-A5F (*1)	BCP-LC5F	MBCP-C5F	FP-C5F	RCAP-C5F		TCD-5CF or TCD-55FA excluding BCP-A5F (*1)	
V*-5CFB									
L-5CFW	BCP-B51F								
V*-5CFW									
8281F		BCP-A77				RCAP-C77			
L-5C2W		BCP-A52			FP-C52			TCD-451CA	
L-5CHD		BCP-C5HD						TCD-5HD	1.90 - 2.00
L-5.5CUHD	BCP-D55UHD							TCD-55UHD	
L-5.5CUHWS	BCP-D55UHW								1.62 - 1.72
4794R	BCP-D57							TCD-57C	
L-6CHD		BCP-C6HD							
L-7CHD		BCP-C7HD						TCD-67HD	2.15 - 2.25
L-7CFB		BCP-C7FA			FP-C7FA				
7731A		BCP-C71A						TCD-7CA	1.90 - 2.00
9292					FP-C71A				
L-8CHD/L-8CUHD	BCP-D8UHD							TCD-8HD	2.44 - 2.54
GS-6						RCAP-C3GS		TCD-35D	2.01 - 2.20

\*1: Suitable die set for BCP-A5F is TCD-35CA

#### ■ Micro BNC, DIN1.0/2.3, 4K-DIN

Cable	Micro BNC	DIN	4K-DIN	Suitable Die Set	Crimp Height
	HBCP-D	DCP-C	MDM/MDF		
L-2.5CHD/L-2.5CHLT	HBCP-D25HD	DCP-C25HD		TCD-D253F	1.08 - 1.16
1855A					
VDM230					
L-2.5CHWS	HBCP-D25HW	DCP-C25HW			
V4-2.5CHW			MD*-V4C25HW		
L-3CFB		DCP-C3F			
L-3.3CUHD	HBCP-D33UHD				
L-4CFB				TCD-D534F	1.25 - 1.33
1505A		DCP-C4F			
VPM2000					
L-4CHD					
L-4.5CHD	HBCP-D53	DCP-C53			
1694A					
VSD2001					

#### ■ Video Patch Plugs

Cable	Video Plug	Suitable Die Set	Crimp Height
L-2.5CHWS	VWP-C25HW MVP-C25HW	TCD-D253F	N/A (solder pin)
	MCVP-C25HW SVP-C25HW	TCD-D253F	1.08 - 1.16
LV-61S	VWP-C4A MVP-C4	TCD-4CA or TCD-451CA	N/A (solder pin)
RG-59B/U			

Be sure to use in the suitable combination of cable, connector, and die set

110Ω-75Ω Impedance Transformers

Passively convert AES/EBU digital audio signals from 110Ω/XLR3 output to a 75Ω BNC coaxial cable and then back again to a 110Ω/XLR3 input.

■ Adapter Type

Model	Description
BCJ-XJ-TRC	XLR3 (F) - BNC Jack
BCJ-XP-TRC	XLR3 (M) - BNC Jack
BCJ-XJ-A10TRC	XLR3 (F) - BNC Jack, 10dB Attenuation Pad

■ Panel Mount Type

Model	Description (Front - Back)	Flange Type
XJ3F-TRC-BCJ	XLR3 (F) - BNC Jack	ITT XLR-F77
XJ3M-TRC-BCJ	XLR3 (M) - BNC Jack	
BCJ-TRC-XP3F	BNC Jack - XLR (F)	
BCJ-TRC-XP3M	BNC Jack - XLR (M)	
XJ3F-A10TRC-BCJ	XLR3 (F) - BNC Jack, 10dB Attenuation Pad	
BCJ-A10TRC-XP3F	BNC Jack - XLR3 (F), 10dB Attenuation Pad	

- SMPTE 276M and AES3 transmission standards
- Coaxial transmission of 2 channel digital audio
- Allows longer cable runs than 110Ω twisted pair
- AES/EBU signal distribution using Canare 75Ω video patchbays

BCJ-XJ-TRC / BCJ-XP-TRC

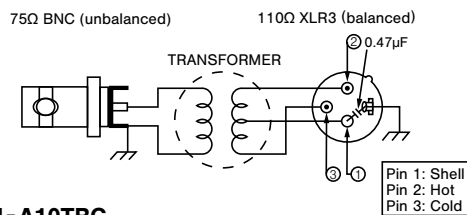

BCJ-XJ-A10TRC

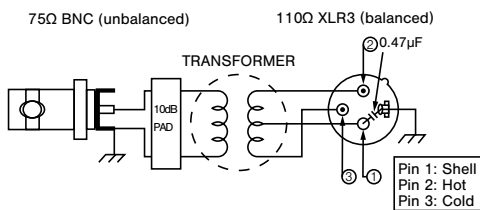

110Ω-75Ω Impedance Transformer: Input/Output Level Performance

AES/EBU Transmitter (V)	Transformer Out (V)	AES/EBU Transmitter (V)	Transformer Out - 10dB Pad (V)
2.0	1.60	2.0	0.50
3.0	2.39	3.0	0.75
4.0	3.18	4.0	1.01
4.5	3.60	4.5	1.13
5.0	3.98	5.0	1.26
6.0	4.78	6.0	1.51
7.0	5.58	7.0	1.76
8.0	6.38	8.0	2.02
9.0	7.18	9.0	2.27
10.0	7.98	10.0	2.52

BCJ-XJ-TRC/BCJ-XP-TRC

BCJ-XJ-A10TRC



BCJ-XJ-TRC



BCJ-XP-TRC



BCJ-XJ-A10TRC



XJ3F-TRC-BCJ



BCJ-TRC-XP3M

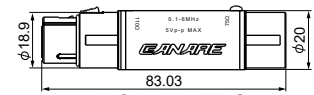

BCJ-XJ-TRC

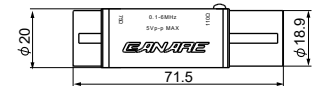

BCJ-XP-TRC

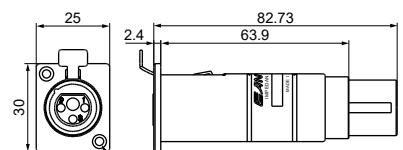

XJ3F-TRC-BCJ

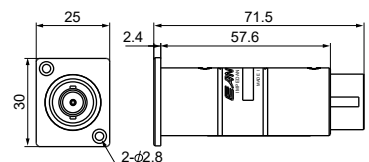

BCJ-TRC-XP3M

Panel Hole Dimensions

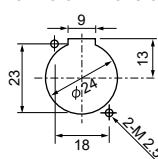

Technical Trend

Fiber-Optic Systems

Connectors

Cables

Panels & Patchbays

Multichannel Systems

Cable Assemblies

### Considerations When Configuring and Selecting Cables for Microphone Systems

With the growing demand of recent years for both greater physical comfort and savings in energy consumption, systems incorporating digital control based on the latest advances in electronics are coming into wider use for air conditioning and lighting systems. As all these systems come on line, we cannot help but be reminded of the fact that the wiring used for these digital control systems generates pulse-based electromagnetic noise of the kind that affects the very delicate signals used in microphone lines.

Microphone cables are designed to carry a range of signals that span the spectrum from 1/100 of a volt (10 mV) to 1/1,000,000 (1  $\mu$ V). One small error in wiring procedure or cable selection and the entire microphone system turns into an antenna collecting the surrounding noise.

The following section uses a question and answer format to cover a list of the essential points for configuring microphone systems.

#### Q1 Under what sort of conditions should a two-conductor microphone cable be used?

The two-conductor microphone cable is suited to environments where noise is not such a great factor and the audio signals are in the comparatively high -20 dB to 0 dB level range. In such cases, the two-conductor cable offers the advantages of smaller diameter and lower cost. Of course if microphone level, rather than line level, is the criterion being used, star quad cable should be used instead.

#### Q2 Under what conditions should star quad microphone cable be used?

This type is used for environments with a higher noise factor and where audio signals are in the low -50 dB or less range. This type of cable performs well under noise conditions that exceed the capacity of the two-conductor shielded cable, effectively shielding out over ninety percent more noise. (See Figs. 1, 2)

However, should this type be routed alongside a power cable of any significant capacity it should probably be encased in metal conduit just to be safe.

#### Q3 Isn't star quad cable expensive?

The cost for this type of cable has fallen significantly in recent years. Several decades ago, cost was so prohibitive a factor that only large musical auditoriums and broadcasting facilities could afford them. Canare succeeded in developing a low-cost star quad cable using aluminum foil in 1981. In addition to traditional professional facilities, this type gained wide use in such non-traditional areas as wedding halls and school lecture rooms.

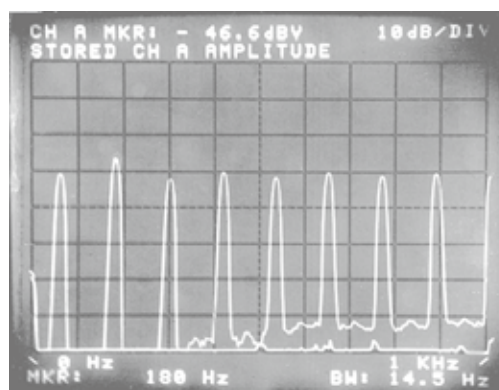

Fig. 1 Noise induced in two-conductor shielded cable (MVVS)

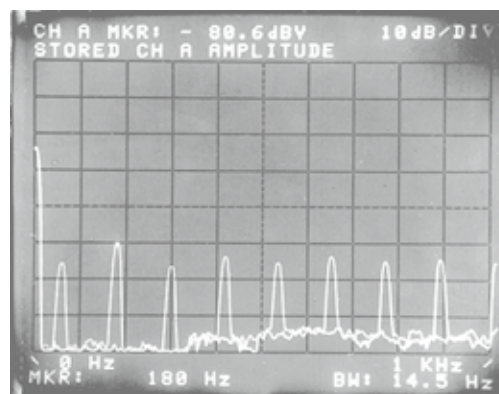
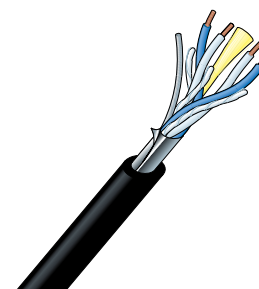

Fig. 2 Noise induced in star quad cable (Canare L-4E5AT)

<Test conditions>

1. Flush along power cables for 20 m distance
2. Power cable connected to lighting fixture dimmed to 50% capacity with load of 1 kW.
3. The noise induced in the audio cable was boosted by 50 dB in the head amplifier and viewed on a spectrum analyzer.



Star quad cable with aluminum foil shield

### Q4 When avoiding use of metal conduit, how far away should microphone cable be from power cables?

When foregoing the use of protective metal conduit, use the graph shown in Fig. 3 as a general guide for distancing cables. Note that ignoring basic guidelines for positioning cables can easily result in noise induction problems which are very difficult to deal with later. Encasing microphone cables in metal conduits is highly recommended for applications that utilize the delicate signal range.

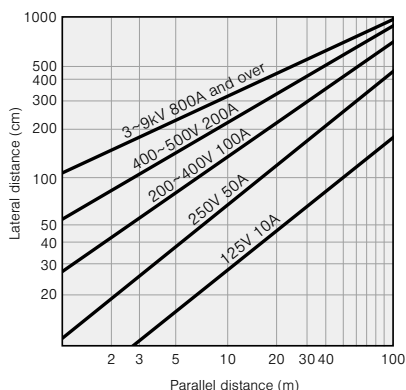

**Fig. 3 Distances for positioning microphone and power cables**

<Requisite conditions>  
 1. Cables are the star quad type.  
 2. Power cables are in the circular cab tire configuration.

### Q5 What considerations are required when using a rack for strong electric current?

The same as for the preceding question when metal conduit is not used.

### Q6 Would there be any problem with routing the cables through a flexible metal conduit?

The flexible conduit would certainly help to reduce noise but would not be as effective as a rigid metal conduit. Use the graph in Fig. 4 as a guide for distancing cables.

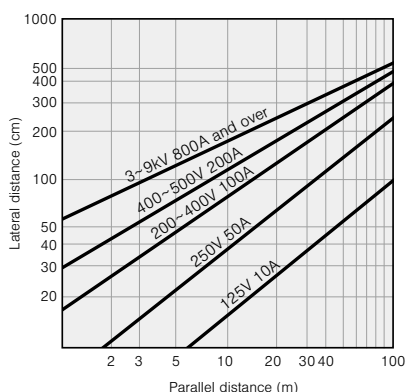
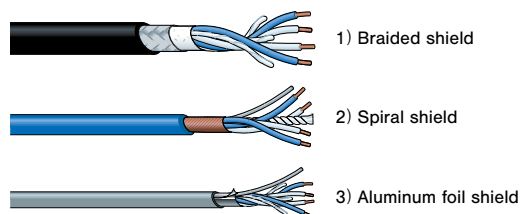

**Fig. 4 Distances for positioning microphone and power cables when routing microphone cables via flexible metal conduit**

<Requisite conditions>  
 1. Cables are the star quad type routed through flexible metal conduit.  
 2. Metal conduit is grounded using appropriate level of resistance.  
 3. Power cables are in the circular cab tire configuration.

### Q7 What are the criteria for choosing between the many different types of microphone cables?

As all are designed to provide electromagnetic shielding there is not that much basic difference in shielding performance. However, they do differ in various specific characteristics. Cable type should be selected according to specific requirements. (See Fig. 5)



**Fig. 5 Types of star quad microphone cables**

#### • Braided Shield

The braided copper shield is designed to maintain effective shielding performance, regardless of how many times the cable is unwound, bent, twisted or rewound. It is ideal for use as handheld microphone cables or extension cables. This type is more expensive than other types as it is braided very finely to ensure a highly impenetrable shield. Cable termination requires seasoned expertise.

#### • Spiral Shield

The spiral shield consists of several copper wires wound tightly around the cable in a spiral wind. The shielding effect is heightened by winding the shield on twice, each time from different directions in what is referred to as the “double-spiral shield.” The cost range for the spiral shield cable lies roughly mid way between the braided shield and the aluminum foil shield cable. Although cable termination operations are comparatively simple, the spiral shield tends to deteriorate when flexed too frequently. It is designed for stationary installation.

#### • Aluminum Foil Shield

The aluminum foil shield cable consists of aluminum foil fused onto a polyester film and wound around the cable in the form of a tape. Cable termination involves a simple operation and the cable is relatively inexpensive. The aluminum foil cable is recommended for use as stationary cabling.

Aluminum foil cable with a Kevlar cable filler is highly recommended for areas where cables will be routed through metal conduit. The Kevlar filler protects the cable as it passes through the conduit, preventing cable breakage or shorting, even when intense stress is applied to the cable. The aluminum foil cable is currently widely used in function halls and multipurpose track and field stadiums.

### AWG is for Indicating conductor size

AWG is the abbreviation for American Wire Gauge. For solid center conductor, numbers are decided by conductor O.D. and for stranded center conductor, numbers are decided by conductor cross sectional area. The AWG numbers for conductors used at Canare are listed in Table 1.

AWG	Conductor cross sec. area (mm <sup>2</sup> )	AWG	Conductor cross sec. area (mm <sup>2</sup> )
13	2.81	22	0.34, 0.37, 0.39
14	2.18	23	0.29, 0.30, 0.31
15	1.75	24	0.20, 0.22, 0.23
16	1.27	25	0.18
18	1.0	26	0.14, 0.15
20	0.51, 0.56	28	0.08, 0.09
		31	0.04

**Table 1: AWG Numbers for Cables Used by Canare**

# Cables

## Star Quad Cables

### The Star Quad Story

Canare Star Quad obtains its name from the 4-conductor style construction that minimizes the "loop area" between twists of the conductors. This "double balanced" pairing, reduces susceptibility to electromagnetically induced noise. The improvement in noise rejection is so noticeable, that even SCR dimmer noise (stage lighting consoles), is reduced to less than 1/10 the level found in other 2-conductor microphone cables.

Canare Star Quad is designed for use with microphones but is also excellent for all line-level signals (e.g. mixer to power amps). The 4-conductor Star Quad arrangement, cancels electromagnetically

induced noise from SCR dimmer packs, fluorescent lighting ballasts and AC power transformers. Handling noise is prevented by use of cotton filler material. Excellent frequency response is maintained due to special irradiated polyethylene insulation which provides a low capacitance dielectric.

Canare Star Quad cable with braided shields is super flexible. We use large numbers of thin wire strands in the copper conductors and overall braided shield. We extrude a special compound PVC outer jacket that remains pliant at extremely low temperatures with no wait between cold shipping and installation.

#### Filler

Canare selects cotton, jute and /or exotic polyester fibers for packing. These fillers prevent stretching and twisting of the inner conductors which can cause noise. Additionally, paper, Mylar and/or cloth tape, bind conductors so cables hold their shape.

#### Shield

Canare does not use spiral (serve) shields because they can spread apart with use. Our shields are more difficult to manufacture because we use many thin copper strands in a densely woven braid. The shields are super flexible and offer outstanding noise rejection.

#### Conductors

All Canare microphone cables utilize high-conductivity, annealed copper wires, stranded to form flexible conductors and shields.

#### Insulation

Canare cables utilize special polymer compounds that reduce capacitive "R-C" filter roll off within the cable and prevent high voltage breakdown. By irradiating the material, the polymer becomes extensively cross-linked, chemically inert, water resistant, and remains flexible at very low temperatures. Irradiated PE is superior to ordinary polyethylene because it is heat resistant. Canare insulation will not shrink back, flow or char when soldering, so you save initial and rework time, and achieve more reliable connections.

#### Jacket

Canare uses specially formulated PVC compounds that combine to make a tough, strong and durable outer jacket with excellent flexibility. These qualities are retained even at very low temperatures, so Canare cables will not stiffen or crack. Available in 10 attractive colors.

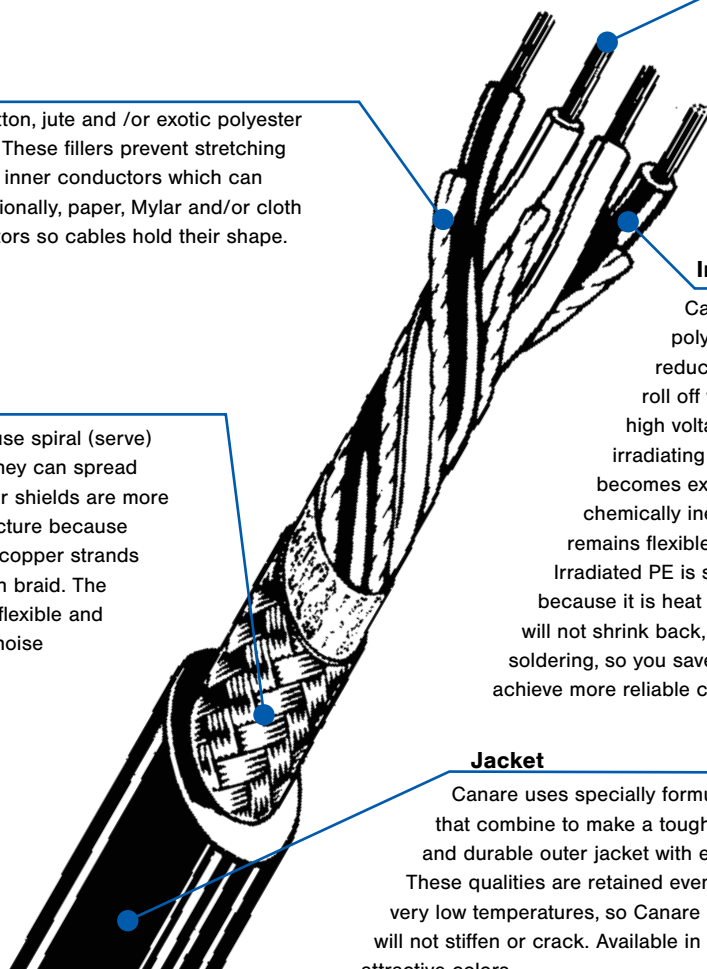

In order to maximize noise rejection, Star Quad must be properly wired to the XLR-3 connector (or terminal block).

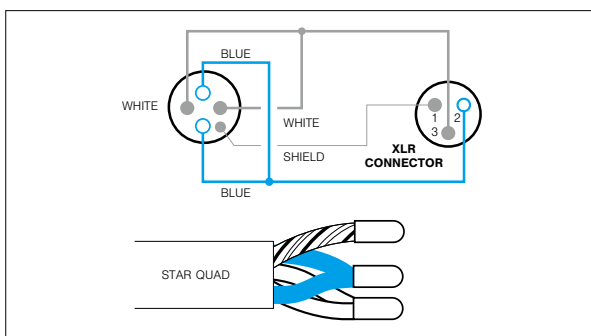

Because the shield density on Canare Cable is very high, it is somewhat difficult to push back the braid and pull the inner conductors through. Instead, we strongly recommend unbraiding the shield by "combing" it out with a pointed tool, beginning at the end of the cable.

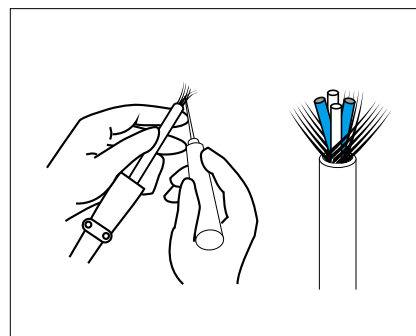

Star Quad Microphone Cables (Single)

Effectively reduce noise levels to 1/10 that of general-purpose, 2-conductor shielded cables.

Aluminum Foil Shield

Type	Model	Sales units	Nom. O.D.	Weight	Composition			Electrical characteristics				
					No. of cond.	Cross sec. area (AWG) and cond. comp.	Twist pitch	Shield	Cond. DCR	Shield DCR	Nom. cap.*	Nom. cap.**
		m	mm	kg/100m		mm <sup>2</sup> /(AWG) Q'ty/mm	mm		Ω/100m	Ω/100m	pF/m	pF/m
	L-4E3AT	200 500	3.0	1.2	4	0.08(28) 7/0.12A	16	AL foil	24.6	—	—	—
	L-4E5AT	100 200 400	5.0	3.3	4	0.18(25) 16/0.12A	21	AL foil	10.7	—	164	222
	L-4E5ATG		5.0	3.3	4	0.18(25) OFC 1/0.18+30/0.08	21		11.1	—	164	222
	L-4E6AT		6.2	5.0	4	0.31(23) 12/0.18A	25		6.4	—	150	210
	L-4E6ATG		5.8	4.6	4	0.34(22) OFC 1/0.18+63/0.08	35		5.5	—	150	210
	L-4E5AT-WBS	100 200 400	6.8	8.9	4	0.18 (25) 16/0.12A	21	AL foil + double braid	10.7	—	164	222
	L-4E6AT-WBS		8.6	12.3	4	0.31 (23) 12/0.18A	25		6.4	—	150	210

Insulation: Cross-linked PE Jacket: PVC Dielectric strength: 500V AC/min.

\*Capacitance between conductors \*\*Capacitance between conductor and shield.

L-4E\*AT Series

- Designed for fixed installations
- Aluminum foil shielding provides 100% coverage
- DuPont Kevlar\* filler can resist stretching of cable when pulled through conduit. (excluding L-4E3AT)
- Foil shield and drain wire offer quick assembly work
- L-4E\*ATG has an OFC conductor
- L-4E\*AT-WBS has a high-density double-braided shield. Its foil and braided shield are insulated by inner jacket.

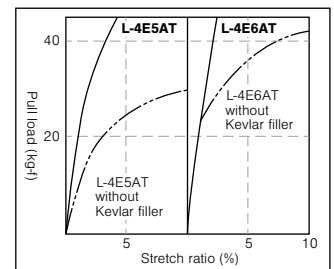
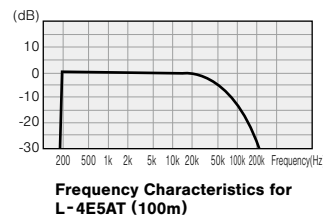

Braided Shield

Type	Model	Sales units	Nom. O.D.	Weight	Composition			Electrical characteristics				
					No. of cond.	Cross sec. area (AWG) and cond. comp.	Twist pitch	Shield Coverage (braid)	Cond. DCR	Shield DCR	Nom. cap.*	Nom. cap.**
		m	mm	kg/100m		mm <sup>2</sup> /(AWG) Q'ty/mm	mm	%	Ω/100m	Ω/100m	pF/m	pF/m
	L-4E5C	100 200	4.8	3.4	4	0.15(26) 30/0.08A	18	96%	13.0	2.4	162	200
	L-4E6S		6.0	4.8	4	0.20(24) 40/0.08A	20	94%	9.8	3.1	150	185
	L-4E5	100 200 400	4.8	3.5	4	0.15(26) 30/0.08A	18	96%	13.0	1.9	162	200
	L-4E6		6.5	6.1	4	0.23(24) 20/0.12A	25	96%	8.6	1.6	144	187
	L-4E6-WBS	100 200	7.0	8.4	4	0.23 (24) 20/0.12A	25	96% & 95%	8.6	1.0	144	187

Insulation: Cross-linked PE Jacket: PVC Dielectric strength: 500V AC/min.

\*Capacitance between conductors. \*\*Capacitance between conductor and shield.

L-4E5C, L-4E6S

- Bend resistant design: the conductor consists of ultrafine 0.08 mm strands offers excellent durability.
- High-density braided shield

L-4E5, L-4E6

- High-density braided shield
- Drain wire included

L-4E6-WBS

- High-density double-braided shield
- Drain wire included

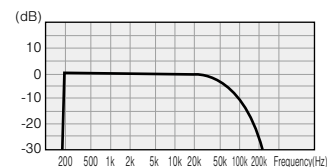

Frequency Characteristics for L-4E6S (100m)

# Cables

## Star Quad Cables

### Multichannel Star Quad Microphone Cables

#### Aluminum Foil Shield

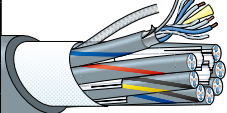
Type	Model	No. of ch.	Sales units	Nom. O.D.	Weight	No. of cond.	Unit composition			Electrical characteristics			
							Cross sec. area (AWG) and cond. comp.	Twist pitch	Ch. O. D.	Cond. DCR	Shield DCR	Nom. cap.*	Nom. cap.**
							mm <sup>2</sup> /(AWG) Q'ty/mm	mm	mm	Ω/100m	Ω/100m	pF/m	pF/m
 L-4E4-8AT Jacket color: <b>GRY</b>	L-4E3-2AT	2	100 200 500	8.5	7.5	8	0.08(28) 7/0.12A	16	3.0	24.8	-	-	-
	L-4E3-4AT	4		10.0	11	16							
	L-4E3-8AT	8		13.8	19	32							
	L-4E3-12AT	12		15.6	26	48							
	L-4E3-16AT	16		17.2	32	64							
	L-4E3-24AT	24		21.3	47	96							
	L-4E4-2AT	2		10.5	12	8	0.18(25) 16/0.12A	21	3.7	10.8	-	164	222
	L-4E4-4AT	4		12.3	17	16							
	L-4E4-8AT	8		16.9	31	32							
	L-4E4-12AT	12		18.9	41	48							
	L-4E4-16AT	16		20.9	50	64							
	L-4E4-24AT	24		26.1	76	96							

Insulation: Cross-linked PE (blue-blue, white-white) Jacket, inner Jacket: PVC Dielectric strength: 500V AC/min. \*Capacitance between conductors \*\*Capacitance between conductor and shield.

#### L-4E3-\*\*AT, L-4E4-\*\*AT

- The multichannel microphone cable is the cable of choice for music auditorium and studio facilities where noise prevention and audio quality are the prime considerations.
- Each unit contains the highly pull-resistant Kevlar\* cable filler.
- \*Kevlar is a trademark of DuPont.
- Drain wire included in each unit.

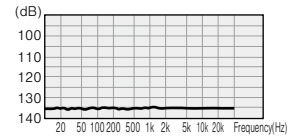
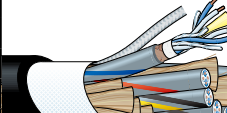

Fig. 1 Crosstalk Characteristics for L-4E4-4AT (100m)

#### Braided Shield

Type	Model	No. of ch.	Sales units	Nom. O.D.	Weight	No. of cond.	Unit composition			Electrical characteristics				
							Cross sec. area (AWG) and cond. comp.	Twist pitch	Shield coverage (braid)	Ch. O.D.	Cond. DCR	Shield DCR	Nom. cap.*	Nom. cap.**
							mm <sup>2</sup> /(AWG) Q'ty/mm	mm	%	mm	Ω/100m	Ω/100m	pF/m	pF/m
 L-4E3-8P Jacket color: <b>BLK</b> (L-4E3-2H) <b>GRY</b>	L-4E3-2H	2	100 200 500	8.9	9.5	8	0.08(28) 7/0.12A	16	93%	3.4	24.9	3.4	145	170
	L-4E3-2P	2		8.9	8.2	8								
	L-4E3-4P	4		10.9	13	16								
	L-4E3-8P	8		15.3	26	32								
	L-4E3-12P	12		17.4	36	48								
	L-4E3-16P	16		18.9	46	64								
	L-4E3-24P	24		24.0	70	96	0.15(26) 30/0.08A	18	95%	4.0	13.1	2.4	162	200
	L-4E4-2P	2		11.1	13	8								
	L-4E4-4P	4		13.4	21	16								
	L-4E4-8P	8		18.2	34	32								

Insulation: Cross-linked PE (blue-blue, white-white) Jacket, inner jacket: PVC Dielectric strength: 500V AC/min. \*Capacitance between conductors \*\*Capacitance between conductor and shield.

#### L-4E3-2H, L-4E3-\*\*P, L-4E4-\*\*P

- Ideal multichannel cable for PA and live events where cables are laid down and taken back up on a regular basis.
- Each unit of L-4E3-2P and L-4E3-2H contains the highly pull-resistant Kevlar\* cable filler.
- \*Kevlar is a trademark of DuPont.
- The L-4E3-2H is the reinforced version containing a stainless steel wire support.

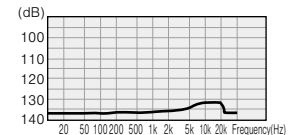
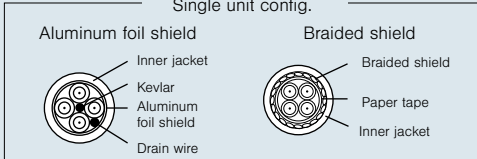

Fig. 1 Crosstalk Characteristics for L-4E4-4P (100m)

#### ■ Cross-sectional View

Single unit config.



2ch 4ch 8ch 12ch 16ch 24ch

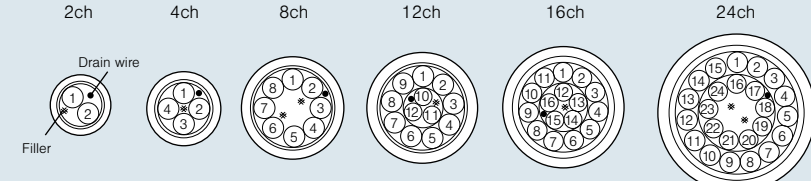

Aluminum foil shield: Inner jacket, Kevlar, Aluminum foil shield, Drain wire

Braided shield: Braided shield, Paper tape, Inner jacket





Channel color code: Spiral marks on inner jacket (gray).

Unit no.	1	2	3	4	5	6	7	8	9	10	11	12	13	14	15	16	17	18	19	20	21	22	23	24
Spiral mark	RED	BLU	YEL	GRN	BRN	-	BLU/BLK	YEL/BLK	GRN/BLK	BRN/BLK	BLK	BLU/ORN	YEL/ORN	GRN/ORN	BRN/ORN	ORN	BLU/PNK	YEL/PNK	GRN/PNK	BRN/PNK	PNK	BLU/WHT	YEL/WHT	GRN/WHT



Two-Conductor Shielded Cables (Single)

Aluminum Foil Shield

Type	Model	Sales units	Nom. O.D.	Weight	No. of cond.	Composition		Electrical characteristics			
						Cross sec. area (AWG) and cond. comp.	Twist pitch	Cond. DCR	Shield DCR	Nom. cap.*	Nom. cap.**
						mm <sup>2</sup> /(AWG) Q'ty/mm	mm	Ω/100m	Ω/100m	pF/m	pF/m
 Jacket colors: GRY, BLK	L-2B2AT	200 500	3.2	1.3	2	0.18(25) 16/0.12A	25	10.5	—	73	120
 Jacket color: GRY	L-2B2AL	200	3.2	1.2	2	0.18(25) 7/0.18TA Overall tin coated	20	11.3	—	—	—
 Jacket colors: GRY, BLK, SEPIA	L-2E5AT	200	5.0	4.0	2	0.31(23) 12/0.18A	30	6.2	—	79	140
 Jacket color: GRY	L-2E5AL	200 500	5.0	3.7	2	0.29(23) 7/0.23TA Overall tin coated	30	6.8	—	—	—

Insulation: Cross-linked PE (polyethylene for L-2E5AL and L-2B2AL) Jacket: PVC Dielectric strength: 500V AC/min. \*Capacitance between conductors \*\*Capacitance between conductor and shield.

L-2B2AT, L-2E5AT

- Ideal for internal rack wiring.
  - Drain wire included.
  - The L-2E5AT contains the Tetoron cable filler reinforcement material.
- <Fig. 1>

L-2B2AL, L-2E5AL

- Cables for connecting devices with which wrapping tools can be used.
- Drain wire included.

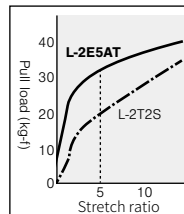

Fig. 1 Pull Load and Stretch Ratio for Cable

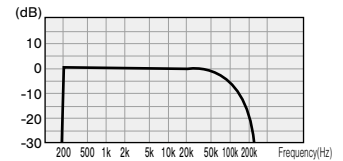



Fig. 2 Frequency Characteristics for L-2B2AT (100m)

Braided Shield

Type	Model	Sales units	Nom. O.D.	Weight	No. of cond.	Composition			Electrical characteristics			
						Cross sec. area (AWG) and cond. comp.	Twist pitch	Shield coverage (braid)	Cond. DCR	Shield DCR	Nom. cap.*	Nom. cap.**
						mm <sup>2</sup> /(AWG) Q'ty/mm	mm	%	Ω/100m	Ω/100m	pF/m	pF/m
 Jacket colors: BLK, RED, ORN, YEL, BLU, GRY	L-2T2S	100 200	6.0	4.6	2	0.30(23) 60/0.08A	20	94%	6.5	3.1	70	106
 Jacket color: BLK	L-2E5	200	4.6	3.0	2	0.15(26) 30/0.08A	18	97%	12.7	2.2	63	117

Insulation: Cross-linked PE Jacket: PVC Dielectric strength: 500V AC/min. \*Capacitance between conductors \*\*Capacitance between conductor and shield.



L-2T2S, L-2E5

- Braid coverage of 94% and above provides dense shielding that blocks out electromagnetic noise.
- L-2T2S consists of 60 ultra-fine 0.08 mm strands (30 for L-2E5) in a stranded format that offers excellent durability.
- Highly pliable and durable PVC used for jacket. (Brittle temp. -49°C)

# Cables

## Two-Conductor Shielded Cables

### ■ Spiral Shield

Type	Model	Sales units	Nom. O.D.	Weight	No. of cond.	Composition			Electrical characteristics			
						Cross sec. area (AWG) and cond. comp.	Twist pitch	Shield coverage	Cond. DCR	Shield DCR	Nom. cap.*	Nom. cap.**
						mm <sup>2</sup> /(AWG) Q'ty/mm	mm	%	Ω/100m	Ω/100m	pF/m	pF/m
 <b>MS202</b> Jacket color: <b>BLK</b>	<b>MS202</b>	200	2.8	1.4	2	0.18 (25) 1/0.18TA + 30/0.08TA	25	91% (spiral)	11.3	3.2	74	145
 <b>MS203</b> Jacket color: <b>GRY</b>		200	3.5	2.1	2	0.31(23) 12/0.18TA	30	91% (spiral)	6.5	2.3	—	—

Insulation : Cross-linked PE    Jacket : PVC    Dielectric strength : 500V AC/min.

\*Capacitance between conductors \*\*Capacitance between conductor and shield.

### MS202

- Ideal for analog audio internal rack wiring.
- Composite conductors with 1 of 0.18 mm and 30 of 0.08 mm strands.
- Drain wire included.

### MS203

- Ideal for internal rack wiring.
- Drain wire included.

## Two-Conductor Shielded Multichannel Cables

### ■ Aluminum Foil Shield

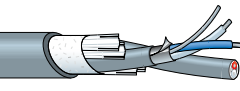
Type	Model	No. of ch.	Sales units	Nom. O.D.	Weight	No. of cond.	Unit composition			Electrical characteristics			
							Cross sec. area (AWG) and cond. comp.	Twist pitch	Ch. O. D.	Cond. DCR	Shield DCR	Nom. cap.*	Nom. cap.**
							mm <sup>2</sup> /(AWG) Q'ty/mm	mm	mm	Ω/100m	Ω/100m	pF/m	pF/m
 <b>L-2E4-2AL</b> Jacket color: <b>GRY</b>	<b>L-2E4-2AL</b>	2	100 200 500	8.6	7.6	4	0.29(23) 7/0.23TA Overall tin coated	30	3.7	6.9	—	81	144
	<b>L-2E4-4AL</b>	4		10.8	13	8							
	<b>L-2E4-8AL</b>	8		14.9	24	16							
	<b>L-2E4-12AL</b>	12		16.9	32	24							
	<b>L-2E4-16AL</b>	16		18.8	40	32							

Insulation : Cross-linked PE    Jacket : PVC    Dielectric strength : 500V AC/min.

\*Capacitance between conductors \*\*Capacitance between conductor and shield.

### L-2E4-AL Series

- Used as cables for connecting devices with which wrapping tools can be used.
- Drain wire included in each unit.

No.	Dot line markings
1	—
2	— —
3	— — —
4	— — — —
5	— — — — —
6	— — — — — —
7	— — — — — — —
8	— — — — — — — —
9	— — — — — — — — —
0	— — — — — — — — — —

■ Cross-sectional View

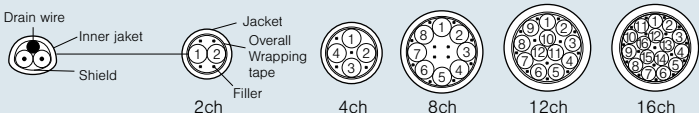

Single unit config.    Drain wire    Inner jacket    Jacket    Overall Wrapping tape    Shield    Filler

2ch    4ch    8ch    12ch    16ch

■ Channel color code : color-coded insulation and dot line markings (ch 1 to 10 : red, ch 11 to 16 : blue) on inner jacket (gray).

Unit no.	1	2	3	4	5	6	7	8	9	10	11	12	13	14	15	16
Insulation color	RED/WHT	BLU/WHT	YEL/WHT	GRN/WHT	BRN/WHT	GRY/WHT	BLU/BLK	YEL/BLK	GRN/BLK	BRN/BLK	GRY/BLK	BLU/ORN	YEL/ORN	GRN/ORN	BRN/ORN	GRY/ORN

## Aluminum Foil Shield

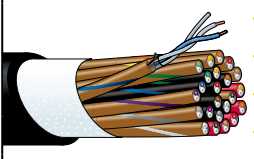
Type	Model	No. of ch.	Sales units	Nom. O.D.	Weight	No. of cond.	Unit composition			Electrical characteristics			
							Cross sec. area (AWG) and cond. comp.	Twist pitch	Ch. O. D.	Cond. DCR	Shield DCR	Nom. cap.*	Nom. cap.**
							mm <sup>2</sup> /(AWG) Q'ty/mm	mm	mm	Ω/100m	Ω/100m	pF/m	pF/m
 <b>M202-24AT</b> Jacket color: <b>BLK</b>	<b>M202-2AT</b>	2	100 200 500	6.5	4.8	4	0.18(25) 16/0.12A	30	—	10.5	—	75	135
	<b>M202-4AT</b>	4		8.1	9.0	8							
	<b>M202-8AT</b>	8		11.1	16	16							
	<b>M202-12AT</b>	12		12.5	18	24							
	<b>M202-16AT</b>	16		13.8	24	32							
	<b>M202-24AT</b>	24		16.8	32	48							
	<b>M202-32AT</b>	32		18.6	40	64							
 <b>MR202-24AT</b> Jacket color: <b>BLK</b>	<b>MR202-2AT</b>	2	100 200 500	6.7	4.5	4	0.18(25) 7/0.18A	25	2.7	10.7	—	76	142
	<b>MR202-4AT</b>	4		7.6	6.2	8							
	<b>MR202-8AT</b>	8		11.0	13	16							
	<b>MR202-12AT</b>	12		12.7	19	24							
	<b>MR202-16AT</b>	16		14.0	23	32							
	<b>MR202-24AT</b>	24		17.4	34	48							
	<b>MR202-32AT</b>	32		19.1	44	64							

Insulation: Cross-linked PE Jacket: PVC Dielectric strength: 500V AC/min.

\*Capacitance between conductors \*\*Capacitance between conductor and shield.

### M202-AT Series

- Multichannel cable featuring light weight and slim form. At only 16kg for a 50 m length of 24 channel cable, the M202-AT achieves a 47% weight reduction over previous Canare cables.
- Each channel is individually isolated using insulated (PET) aluminum foil shield. <Fig. 1>
- Contains the highly pull-resistant Kevlar cable filler.
- Drain wire included.

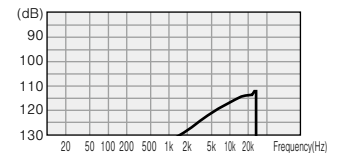
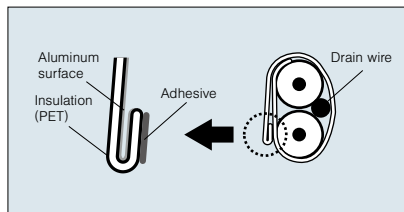

Crosstalk Characteristics for M202-24AT (100m)

Fig. 1 Aluminum Foil Shield

### Note:

This series does not have inner jacket, so it cannot be used for fantails.

#### Cross-sectional View

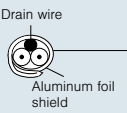
Single unit config. 

Drain wire, Jacket, Wrapping tape, Filler, Kevlar, Aluminum foil shield

2ch, 4ch, 8ch, 12ch, 16ch, 24ch, 32ch

#### Channel color code:

Unit no.	1	2	3	4	5	6	7	8	9	10	11	12	13	14	15	16	17	18	19	20	21	22	23	24	25	26	27	28	29	30	31	32
Insulation color	RED/WHT	BLU/WHT	YEL/WHT	GRN/WHT	BRN/WHT	GRY/WHT	BLU/BLK	YEL/BLK	GRN/BLK	BRN/BLK	GRY/BLK	BLU/ORN	YEL/ORN	GRN/ORN	BRN/ORN	GRY/ORN	BLU/PNK	YEL/PNK	GRN/PNK	BRN/PNK	GRY/PNK	BLU/RED	YEL/RED	GRN/RED	BRN/RED	GRY/BLU	BLU/BLU	GRN/BLU	BRN/BLU	GRN/YEL	BRN/YEL	GRY/YEL

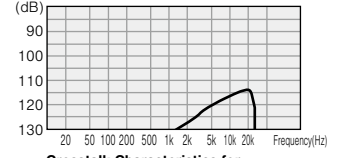

Crosstalk Characteristics for MR202-24AT (100m)

### MR202-AT Series

Our bestselling two-conductor multichannel cable featuring AWG25 stranded conductor, 100% shielding by aluminum foil, and drain wire.

- Studio interconnect, portable snake system
- Each channel identified per resistor color-coding
- Aluminum foil shield and drain wire for easy terminate

### Note:

Not appropriate for heavy-duty applications.

#### Cross-sectional View

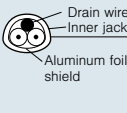
Single unit config. 

Drain wire, Inner jacket, Jacket, Overall Wrapping tape, Filler, Aluminum foil shield

2ch, 4ch, 8ch, 12ch, 16ch, 24ch, 32ch

#### Channel color code: Inner jacket color coding and spiral markings.\* Insulation inside units: one is clear and the other bears the same color as the spiral markings.

Unit no.	1	2	3	4	5	6	7	8	9	10	11	12	13	14	15	16	17	18	19	20	21	22	23	24	25	26	27	28	29	30	31	32
Insulation color	BRN	RED	ORN	YEL	GRN	BLU	PPL	GRY	WHT	BLK	BRN	RED	ORN	YEL	GRN	BLU	PPL	GRY	WHT	BLK	BRN	RED	ORN	YEL	GRN	BLU	PPL	GRY	WHT	BLK	BRN	RED
Spiral markings	BRN	RED	ORN	YEL	GRN	BLU	PPL	GRY	WHT	BLK	-	RED	ORN	YEL	GRN	BLU	PPL	GRY	WHT	BLK	BRN	-	ORN	YEL	GRN	BLU	PPL	GRY	WHT	BLK	BRN	RED
Inner jacket color	BLK																BRN															

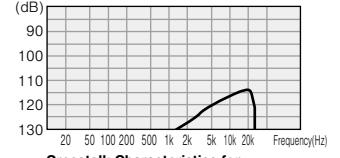

Crosstalk Characteristics for MR202-24AT (100m)

# Cables

## Two-Conductor Shielded Cables

### ■ Spiral Shield

Type	Model	No. of ch.	Sales units	Nom. O.D.	Weight	No. of cond.	Unit composition				Electrical characteristics			
							Cross sec. area (AWG) and cond. comp.	Twist pitch	Shield coverage	Ch. O. D.	Cond. DCR	Shield DCR	Nom. cap.*	Nom. cap.**
							mm <sup>2</sup> /(AWG) Q'ty/mm	mm	%	mm	Ω/100m	Ω/100m	pF/m	pF/m
 <b>MS202-8P</b> Jacket color: <b>BLK</b>	<b>MS202-2P</b>	2	100 200 500	7.1	5.9	4	0.18 (25) 1/0.18TA + 30/0.08TA	25	91% (spiral)	2.8	11.4	3.3	74	145
	<b>MS202-4P</b>	4		8.2	9.2	8								
	<b>MS202-8P</b>	8		10.9	16.0	16								
	<b>MS202-12P</b>	12		13.6	24.2	24								

Insulation: Cross-linked PE Jacket: PVC Dielectric strength: 500V AC/min.

\*Capacitance between conductors \*\*Capacitance between conductor and shield.

### MS202-P Series

- Multichannel cable for analog audio.
- Composite conductors with 1 of 0.18 mm and 30 of 0.08 mm strands.
- Easy-to-use color-coded units and spiral shield.
- Drain wire included in each unit.

■ Cross-sectional View

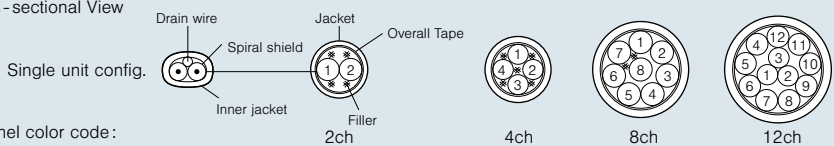

■ Channel color code:

Unit no.	1	2	3	4	5	6	7	8	9	10	11	12
Insulation color	BRN	RED	ORN	YEL	GRN	BLU	PPL	GRY	WHT	BLK	BRN	RED
Spiral markings	BRN	RED	ORN	YEL	GRN	BLU	PPL	GRY	WHT	BLK	-	RED
Inner jacket color	BLK										BRN	

### ■ Spiral Shield

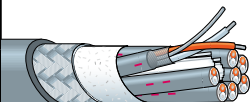
Type	Model	No. of ch.	Sales units	Nom. O.D.	Weight	No. of cond.	Unit composition				Overall shield coverage (braid)	Electrical characteristics			
							Cross sec. area (AWG) and cond. comp.	Twist pitch	Shield coverage	Ch. O. D.		Cond. DCR	Shield DCR	Nom. cap.*	Nom. cap.**
							mm <sup>2</sup> /(AWG) Q'ty/mm	mm	%	mm		Ω/100m	Ω/100m	pF/m	pF/m
 <b>MS203-8BS</b> Jacket color: <b>GRY</b>	<b>MS203-2BS</b>	2	100 200 500	8.9	11.0	4	0.31(23) 12/0.18TA	30	91% (spiral)	3.5	79%	6.6	2.3	—	—
	<b>MS203-4BS</b>	4		10.3	15.8	8					80%				
	<b>MS203-8BS</b>	8		13.5	27.0	16									

Insulation: Cross-linked PE (orange, white) Jacket: PVC Dielectric strength: 500V AC/min.

\*Capacitance between conductors \*\*Capacitance between conductor and shield.

### MS203-BS Series

- Multichannel version of MS203. (See page 57)
- Overall braided shield enables robust shielding performance.
- Drain wire included in each unit.

No.	Dot line markings
1	—
2	—
3	—
4	—
5	—
6	—
7	—
8	—
9	—
0	—



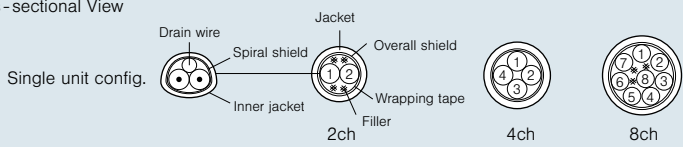

■ Cross-sectional View



■ Unit ID: by dot line markings

**AES/EBU Digital Audio Cables**

Ideal for conveying digital audio signals in conformance with AES/EBU and IEC standards.

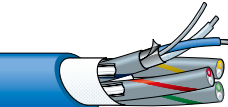
Type	No. of ch.	Model	Sales units	Nom. O.D.	Weight	Unit composition			Electrical characteristics				Charac-teristic impedance	Attenua-tion	
						Cross sec. area (AWG) and cond. comp.	Twist pitch	Shield coverage (braid)	Unit O.D.	Cond. DCR	Shield DCR	Nom. cap.*			Nom. cap.**
			m	mm	kg/100m	mm <sup>2</sup> /(AWG) Q'ty/mm	mm	%	mm	Ω/100m	Ω/100m	pF/m	pF/m	Ω	dB/100m (3 MHz)
 Jacket color: <b>BLU</b>	1	<b>DA206</b>	100 200	7.3	7.5	0.56(20) 7/0.32A	60	95%	—	3.3	1.4	48	73	110	2.6
 Jacket color: <b>BLU</b>	1	<b>DA202</b>	100 200	5.0	3.6	0.18(25) 7/0.18A	32	95%	—	10.6	2.0	48	—	110	5.1
 Jacket color: <b>BLU</b>	1	<b>DA202AT</b>	100 200	4.0	1.6	0.18(25) 7/0.18A	38	—	—	10.6	—	45	—	110	6.7
 Jacket color: <b>BLU</b>	1	<b>DA203AL</b>	100 200	6.0	4.2	0.29(23) 7/0.23TA Overall tin coated	45	—	—	6.8	—	48	95	110	5.4
 Jacket color: <b>BLU</b>	2	<b>DA202F-2P</b>	100 200 500	7.7	6.7	0.18(25) 7/0.18TA	25	91% Spiral shield	3.0	11.3	3.0	47	95	110	5.6
	4	<b>DA202F-4P</b>		8.8	10										
	8	<b>DA202F-8P</b>		11.5	17										
 Jacket color: <b>BLU</b>	2	<b>DA203-2AL</b>	100 200 500	11.8	12	0.29(23) 7/0.23TA Overall tin coated	42	—	4.9	6.9	—	48	95	110	5.4
	4	<b>DA203-4AL</b>		13.8	18										
	8	<b>DA203-8AL</b>		19.3	33										
	12	<b>DA203-12AL</b>		21.9	44										

Insulation : Cross-linked PE (DA202F-P : Cross-linked foam PE) Jacket : PVC Dielectric strength : 500V AC/min. \*Capacitance between conductors \*\*Capacitance between conductor and shield.

**DA206, DA202**

- PE rod configuration ensures consistent 110 Ω impedance with large or small bends in cable during installation.
- DA206 ideal for digital audio paths up to 360 m\*.
- DA202 ideal for digital audio paths up to 180 m\*.
- DA202 contains a drain wire.

**DA202AT**

- Designed for internal cabling connections on racks.
- Ideal for digital audio paths up to 140 m\*.
- Drain wire included.

\*Condition : AES3 SR48kHz

**DA203-AL Series**

- Wrapping tool can be used.
- Ideal for digital audio paths up to 170 m\*.
- Drain wire included in each unit.

**DA202F Series**

- Slim and lightweight.
- DA202F-8P designed to fit snugly with D-sub 25 pin connector.
- Cross-linked foam PE insulation.
- Ideal for digital audio paths up to 140 m\*.
- Drain wire included in each unit.

■ Channel Color Coding

DA202F-P: by the insulator color & the spiral markings on the inner jacket (blue).

Unit no.	1	2	3	4	5	6	7	8
Insulator color	BRN, WHT	RED, WHT	ORG, WHT	YEL, WHT	GRN, WHT	BLU, WHT	PPL, WHT	GRY, WHT
Spiral markings	BRN	RED	ORN	YEL	GRN	-	PPL	GRY

DA203-AL: by the insulator color & the spiral markings on the inner jacket (gray).

Unit no.	1	2	3	4	5	6	7	8	9	10	11	12
Insulator color	RED, WHT	BLU, WHT	YEL, WHT	GRN, WHT	BRN, WHT	GRY, WHT	BLU, BLK	YEL, BLK	GRN, BLK	BRN, BLK	GRY, BLK	BLU, ORG
Spiral markings	RED	BLU	YEL	GRN	BRN	-	BLU, BLK	YEL, BLK	GRN, BLK	BRN, BLK	BLK	BLU, ORG

■ Cross-sectional View for DA202F-P & DA203-AL

Single unit config.

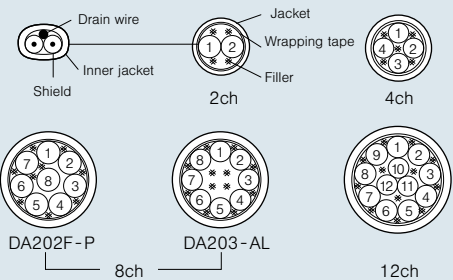

# Cables

## Speaker Cables

### Speaker Cables (Single)

Four-conductor configuration minimizes noise and polyethylene insulation reduces induction rate to boost frequency characteristics

#### 4-conductor Speaker Cable

Type	Model	Pair cross-sec. mm <sup>2</sup>	Sales units m	Nom. O.D. mm	Weight kg/100m	Composition			Electrical characteristics		
						No. of cond.	Cross sec. area (AWG)	Cond. comp.	Twist pitch	Cond. DCR	Nom. capacitance*
							mm <sup>2</sup> /(AWG)	Q'ty/mm	mm	Ω/100m	pF/m
 4S8 Jacket colors for 4S6: GRV, BLK, RED, BLU, CRE 4S8, 4S11, 4S6G: GRV, BLK 4S8G, 4S11G: GRV	4S6	1.0	100 200 400	6.4	5.4	4	0.51(20)	20/0.18A	45	3.7	125
	4S8	2.5		8.3	9.5	4	1.27(16)	50/0.18A	70	1.5	145
	4S11	4.3		10.7	16	4	2.18(14)	41/0.26A	100	0.9	146
	4S6G	1.0		6.4	5.4	4	0.51(20)	20/0.18(OFC)	45	3.7	125
	4S8G	2.5		8.3	9.5	4	1.27(16)	50/0.18(OFC)	70	1.5	145
	4S11G	4.3		10.7	16	4	2.18(14)	41/0.26(OFC)	100	0.9	146

Insulation: polyethylene (red, translucent red, white, translucent white) Jacket: PVC Dielectric strength: 500V AC/min.

\*Capacitance between conductors.

#### 4S6, 4S8, 4S11

- High-performance PVC jacket, resistant to bending and twisting.
- 4S6 designed to fit snugly with Cannon XLR.

#### 4S6G, 4S8G, 4S11G

- The G versions feature oxygen-free copper (OFC, JIS H3510) conductors.

#### 4-conductor Speaker Cable for Fixed Installation

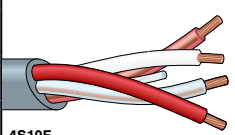
Type	Model	Pair cross-sec. mm <sup>2</sup>	Sales units m	Nom. O.D. mm	Weight kg/100m	Composition			Electrical characteristics		
						No. of cond.	Cross sec. area (AWG)	Cond. comp.	Twist pitch	Cond. DCR	Nom. capacitance*
							mm <sup>2</sup> /(AWG)	Q'ty/mm	mm	Ω/100m	pF/m
 4S10F Jacket colors for 4S10F, 4S12F, 4S14F, 4S18F: GRV, BLK 4S10FG, 4S12FG: GRV	4S10F	3.5	100 200 400 1000	9.6	15	4	1.75(15)	33/0.26A	100	1.1	144
	4S12F	5.6		11.6	22	4	2.81(13)	35/0.32A	120	0.7	152
	4S14F	8.0		14.0	32	4	4.02(12)	50/0.32A	120	0.5	—
	4S18F	14.2		17.5	53	4	7.08(9)	88/0.32A	150	0.3	—
	4S10FG	3.5		9.6	15	4	1.75(15)	33/0.26(OFC)	100	1.1	144
	4S12FG	5.6		11.6	22	4	2.8(13)	35/0.32(OFC)	120	0.7	152

Insulation: polyethylene (red, translucent red, white, translucent white) Jacket: PVC Dielectric strength: 500V AC/min.

\*Capacitance between conductors.

#### 4S10F, 4S12F, 4S14F, 4S18F

- Special supple jacket designed for use in building conduits.

#### 4S10FG, 4S12FG

- The G versions feature oxygen-free copper (OFC, JIS H3510) conductors.

### Multichannel Speaker Cables

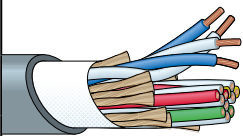
Type	Model	Pair cross-sec. mm <sup>2</sup>	Sales units m	Nom. O.D. mm	Weight kg/100m	Unit composition			Electrical characteristics		
						No. of cond.	Cross sec. area (AWG) and cond. comp.	Twist pitch	Ch. O.D.	Cond. DCR	Nom. capacitance*
							mm <sup>2</sup> /(AWG) Q'ty/mm	mm	mm	Ω/100m	pF/m
 S410-4P Jacket color: GRV	S410-4P	2.0	100 200 500	15.0	26	16	1.0(18) 127/0.10(OFC)	50	5.1	1.9	165
	S410-6P	2.0		18.3	39	24					
	S410-8P	2.0		21.6	53	32					

Insulation: Polyethylene Jacket: PVC Dielectric strength: 500V AC/min.

\*Capacitance between conductors.

#### S410-P Series

- Low crosstalk performance
- Ideal for use in multi-way speaker systems.
- Oxygen-free copper (OFC, JIS H3510) conductors.

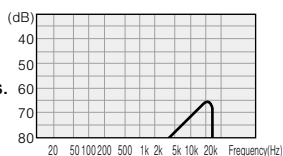
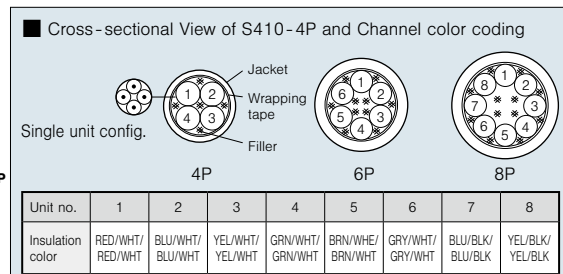



Fig. 1 Crosstalk Characteristics for S410-4P



2-conductor Speaker Cable

Type	Model	Sales units	Nom. O.D.	Weight	Composition				Electrical characteristics	
					No. of cond.	Cross sec. area (AWG)	Cond. comp.	Twist pitch	Cond. DCR	Nom. capacitance*
						mm <sup>2</sup> /(AWG)	Q'ty/mm			
 2S11F Jacket colors: <b>GRY BLK</b>	2S7F	100 200 400	6.8	5.2	2	1.27 (16)	50/0.18A	50	1.5	56
	2S9F		8.9	8.7	2	2.18 (14)	41/0.26A	60	0.9	56
	2S11F		11.1	14	2	3.62 (12)	45/0.32A	80	0.5	55
	2S14F		13.8	21	2	5.63 (10)	70/0.32A	90	0.3	55
	2S7FG		6.8	5.2	2	1.27 (16)	50/0.18(OFC)	50	1.5	56
	2S9FG		8.9	8.7	2	2.18 (14)	41/0.26(OFC)	60	0.9	56
	2S11FG		11.1	14	2	3.62 (12)	45/0.32(OFC)	80	0.5	55
	2S14FG		13.8	21	2	5.63 (10)	70/0.32(OFC)	90	0.3	55

Insulation: polyethylene (orange, white) Jacket: PVC Dielectric strength: 500V AC/min. \*Capacitance between conductors.

- 2S7F, 2S9F, 2S11F, 2S14F**
- Special supple jacket designed for use in building conduits.
- 2S7FG, 2S9FG, 2S11FG, 2S14FG**
- The G versions feature oxygen-free copper (OFC, JIS H3510) conductors.

Multicore Speaker Cable

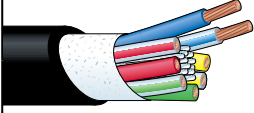
Type	Model	Sales units	Nom. O.D.	Weight	Composition			Electrical characteristics	
					No. of cond.	Cross sec. area and cond. comp.	Cond. O. D.	Cond. DCR	Nom. capacitance*
						mm <sup>2</sup> /(AWG) Q'ty/mm			
 8S15G Jacket color: <b>BLK</b>		100	14.9	33.0	8	2.49 (14) 98/0.18 (OFC)	3.26	0.7	51

Insulation: polyethylene Jacket: PVC Dielectric strength: 500V AC/min. \*Capacitance between adjacent conductors.

- 8S15G**
- Eight-core speaker cable ideally suited for use with Neutrik speakON NL8 and a line array speaker.
  - Oxygen-free copper (OFC, JIS H3510) conductors.

Technical Note

Four-conductor Configuration Minimizes Noise

Speaker cable must accommodate relatively high signal levels, typically tens to hundreds of watts of RMS power. Electromagnetic interference (EMI) can radiate from these speaker lines directly into adjacent low voltage cables (i.e. microphone, video, lines, etc.). Canare solves this problem by using a 4-conductor "Star Quad" configuration in all of our 4S-series speaker cables. Because every conductor is located the same distance from center, the opposing magnetic fields are cancelled out. Attenuation of magnetic field radiation is superior when compared to a standard 2-conductor speaker wire.

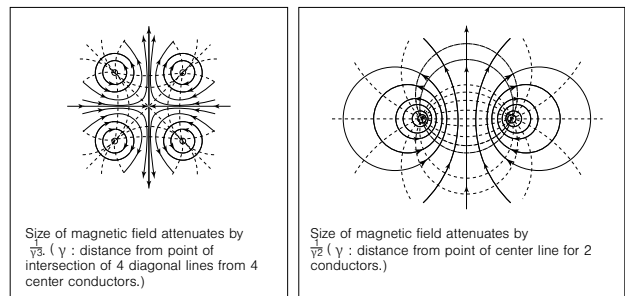

Four-conductor cable Two-conductor cable

Selecting the Right Speaker Cable

Always try to keep speaker cables as short as possible and select cable models that offer a higher damping factor; 20-50 for music (i.e. connect sound) and 10-20 for speech (i.e. sport stadiums). The greater the damping factor (DF), the better the ability to control speaker excursion to create sharp, clear quality in the low end frequency range.

$$\text{damping factor} = \frac{\text{speaker impedance}}{\text{power amp. output impedance} + \text{cable cond. resist. for total loop}}$$

As the above formula shows, a higher conductor resistance causes a lower damping factor, which prevents even top quality power amps from performing at peak optimum levels.

Speaker Cable Length obtained from the Damping Factor (reference)

Model	Cross-sec. Area	Cond. Resist.	Cond. Resist. for Total Loop	Cable Length (m)	
	mm <sup>2</sup> /AWG	Ω/100m	Ω/m	DF = 20	DF = 50
4S6(G)	1.02/17 (pair)	1.85	0.037	9.5	3.0
4S8(G)	2.52/14 (pair)	0.75	0.015	23.3	7.3
4S11(G)	4.36/11 (pair)	0.45	0.009	38.9	12.2
4S10F(G)	3.50/15 (pair)	0.55	0.011	31.8	10.0
4S12F(G)	5.62/13 (pair)	0.35	0.007	50.0	15.7
4S14F(G)	8.00/12 (pair)	0.25	0.005	70.0	22.0
4S18F(G)	14.16/9 (pair)	0.15	0.003	116.7	36.7
S410-*P	2.00/18 (pair)	0.95	0.019	18.4	5.8
2S7F(G)	1.27/16	1.5	0.030	11.7	3.7
2S9F(G)	2.18/14	0.9	0.018	19.4	6.1
2S11F(G)	3.62/12	0.5	0.010	35.0	11.0
2S14F(G)	5.63/10	0.3	0.006	58.3	18.3
8S15G	2.49/14	0.7	0.014	25.0	7.9

Conditions: Speaker impedance = 8 Ω, Power amplifier output impedance = 0.05 Ω

Technical Trend  
Fiber-Optic Systems  
Connectors  
Cables  
Panels & Patchbays  
Multichannel Systems  
Cable Assemblies

# Cables

## OFC Line, A/V Composite Cables

### OFC Line Cables

Type	Model	Sales units	Nom. O.D.	Weight	Inner cond.		Insulation	Outer conductors	Electrical characteristics		
					Cross sec. area (AWG) and cond. comp.	Nom. O.D.			Nom. O.D.	Shield construction and coverage	Chan. DCR
					m	mm	kg/100m	mm <sup>2</sup> /(AWG) Q'ty/mm	mm	mm	mm/ends/carriers
	<b>GS-4</b>	200	4.0	2.7	0.39(22) 50/0.1(OFC)	0.82	1.82	Carbon plastic shield + 0.1 (OFC)/6/16 93%	4.7	3.1	—
	<b>GS-6</b>	100 200	5.8	5.0	1.0(18) 127/0.1(OFC)	1.3	3.0	Carbon plastic shield + 0.1 (OFC)/8/16 92%	1.8	2.5	160

Insulation: polyethylene Jacket: PVC Dielectric strength: 500V AC/min.

\*Capacitance between conductor to shield.

#### GS-4, GS-6

- Outer conductor of fine 0.1 mmφ OFC strands provide a highly flexible braided configuration. (See photographs A and B)



- Center conductor with 127 fine 0.1 mmφ strands (50 for GS-4) increases durability.

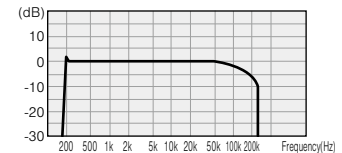
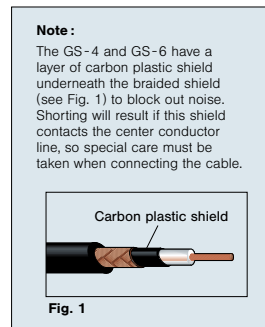







Fig. 2 Frequency Characteristics for GS-6 (100m, 100Ω → 1MΩ load)

### A/V Composite Cables

Used for linking audio video equipment and as extensions for video cameras.

Type	Model	Sales units	Nom. O.D.	Weight	Unit type V: Video A: Audio C: Control line	Unit composition			Electrical characteristics	
						Cross sec. area Conductor comp.	Shield coverage	Unit O.D.	Characteristic impedance	Attenuation
						mm <sup>2</sup> /(AWG) Q'ty/mm	%	mm	Ω	dB/100m (10 MHz)
	 <b>A2V1</b>	100 200	9.7	11	V Video 3C-2V × 1	0.20(25) 1/0.5A	97% (braid)	4.4	75	4.1
	A Audio L-2B2AT × 2				Refer to L-2B2AT	Aluminum foil shield	3.2	—	—	
	 <b>A2V2-L</b>		11.0	16	V Video 3C-2V × 2	0.20(25) 1/0.5A	97% (braid)	4.4	75	4.1
	A Audio L-2B2AT × 2				Refer to L-2B2AT	Aluminum foil shield	3.2	—	—	
	 <b>A2V1B</b>		11.1	13	V Video 3C-2VS × 1	0.18(25) 7/0.18A	97% (braid)	4.4	75	4.5
					A Audio 4E3 Unit × 2	0.08(28) 7/0.12A	93% (braid)	3.4	—	—
	 <b>A2V2B</b>		12.3	17	V Video 3C-2VS × 2	0.18(25) 7/0.18A	97% (braid)	4.4	75	4.5
					A Audio 4E3 Unit × 2	0.08(28) 7/0.12A	93% (braid)	3.4	—	—
 <b>A3V2-FB</b>	12.4	17	V Video 3CFB Unit × 2	0.33(22) 1/0.65A	91% (braid) + Aluminum foil	4.4	75	3.7		
			A Audio L-2B2AT × 3	Refer to L-2B2AT	Aluminum foil shield	3.2	—	—		

Jacket: PVC Dielectric strength: 500V AC/min.

#### A2V1, A2V2-L

- Designed for fixed installation.

#### A2V1B, A2V2B

- Ideal for locations requiring cable bending.



#### A3V2-FB

- 3 balanced audio channels and 2 video coax channels for ENG, EFP, or OB applications.

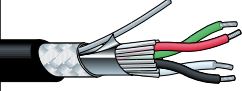

DMX Cables

Designed for DMX 512: commonly used to stage lighting control.

Type	Model	Sales units	Nom. O.D.	Weight	No. of cond.	Conductors		Shield		Cond. DCR	Characteristic impedance
						Cross sec. area (AWG) and cond. comp.	Twist pitch	Foil	Braid comp. (coverage)		
						mm <sup>2</sup> /(AWG) Q'ty/mm	mm		mm/ends/carries		
 Jacket colors: <b>BLK   GRN   WHT</b>	<b>DMX203-2P</b>	100 200 500	7.9	7.9	4 (2 pair)	0.35(22) 44/0.10TA	25	AL	0.10TA/10/24 (94%)	5.9	110
 Jacket color: <b>BLK</b>	<b>DMX203</b>	100 200	6.0	5.0	2 (1 pair)	0.35 (22) 44/0.10TA	45	AL	0.10TA/10/24 (94%)	5.8	110
 Jacket color: <b>BLK</b>	<b>DMX403</b>	100 200	6.5	6.2	4 (quad)	0.35 (22) 44/0.10TA	50	AL	0.10TA/10/24 (94%)	5.8	110

Insulation: Cross-linked PE Jacket: Frame retardant PVC Dielectric strength: 500V AC/min.

**DMX203-2P**

- Standard DMX cable
- PE filler rods ensure consistent 110Ω impedance





**DMX203**

- Single-pair cable suitable for RDM (Remote Device Management) bidirectional communication.
- PE filler rods ensure consistent 110Ω impedance

**DMX403**

- Slim profile 4-conductor cable
- Can be easily inserted into Neutrik NC5 connector.
- More flexible than DMX203-2P

RS422 Cables

Type	Cross-section view	Model	Sales units	Nom. O.D.	Weight	Unit type	Unit composition			Overall Shield coverage	Conductor resistance	Characteristic impedance	
							Cross sec. area (AWG) and cond. comp.	Shield coverage	Unit O.D.				
							mm <sup>2</sup> /(AWG) Q'ty/mm	%	mm				%
 Jacket color: <b>BLK</b>		<b>A2C3</b>	100 200 500	6.5	5.5	A	Digital lines two conductor shielded × 2	0.09(28) 7/0.127TA	90% Spiral shield	2.5	—	25.3	110
						C	Control lines 0.2mm <sup>2</sup> × 3	0.22(24) 11/0.16TA	—	1.24			
 Jacket color: <b>BLK</b>		<b>A2C3-SS</b>	100 200 500	7.0	7.2	A	Digital lines two conductor shielded × 2	0.09(28) 7/0.127TA	90% Spiral shield	2.5	91% Spiral shield	25.3	110
						C	Control lines 0.2mm <sup>2</sup> × 3	0.22(24) 11/0.16TA	—	1.24			

Insulation: Cross-linked foam PE Jacket: Frame retardant PVC Dielectric strength: 500V AC/min.

**A2C3**



- Short distance version of the RS422 class cables.
- Irradiated foam core PE used for the insulation in the digital signal unit.

**A2C3-SS**

- Created by adding an overall spiral shield to the A2C3 to heighten shielding performance.

### Ethernet Cables

#### Flexible and Rugged

Type	Model	Shield type	Sales units	Nom. O.D.	Weight	Conductors			Insertion loss		
						Cross sec. area & composition	DCR	Impedance	100 MHz	250 MHz	500 MHz
						mm <sup>2</sup> /(AWG) Q'ty/mm	Ω/100m	Ω	dB/100m	dB/100m	dB/100m
 Jacket color: <b>BLK</b>	<b>New</b> <b>RJC6A-4P-SFM</b> <b>CAT6A</b>	Overall foil and braid (SF/UTP)	100 200	8.6	8.9	0.26 (23) 1/0.57A	8.2	100	19.1	31.1	45.3
 Jacket color: <b>BLK</b>	<b>RJC5E-4P-WJ</b> <b>CAT5e</b>	N/A (U/UTP)	100 200	7.4	5.4	0.22 (24) 1/0.53A	8.8	100	22.0	—	—
 Jacket color: <b>BLK</b>	<b>RJC5ES-4P-BS</b> <b>CAT5e</b>	Overall braid (S/UTP)	100 200	6.7	6.1	0.22 (24) 7/0.20A	9.5	100	44.0	—	—

Insulation: polyethylene Jacket: PVC Dielectric strength: 700V AC/min (RJC6A-4P-SFM), 350V AC/min (others)

#### RJC6A-4P-SFM

- Flexible and easy-to-use CAT6A STP cable.
- 23 AWG solid conductors
- High-density braided shield (87% coverage)
- Abrasion resistance PVC jacket





#### RJC5E-4P-WJ

- Flexible and easy-to-use CAT5e UTP cable.
- 24 AWG solid conductors

#### RJC5ES-4P-BS

- Super flexible CAT5e STP cable for short distance. (max. 50 m)
- 24 AWG stranded conductors
- High-density braided shield (90% coverage)

#### Standard

Type	Model	Shield type	Sales units	Nom. O.D.	Weight	Conductors			Insertion loss(dB/100m)		
						Cross sec. area & composition	DCR	Impedance	100 MHz	250 MHz	500 MHz
						mm <sup>2</sup> /(AWG) Q'ty/mm	Ω/100m	Ω			
 Jacket colors: <b>BLK RED BLU LB WHT</b>	<b>New</b> <b>RJC6A-4P-F</b> <b>CAT6A</b>	Overall foil (F/UTP)	100 200	7.5	5.2	0.23 (24) 1/0.54A	9.4	100	19.1	31.1	45.3
 Jacket colors: <b>BLK LB</b>	<b>RJC6-4P-F</b> <b>CAT6</b>	Overall foil (F/UTP)	100 200	7.0	5.0	0.23 (24) 1/0.54A	9.4	100	19.8	32.8	—
 Jacket color: <b>BLK</b>	<b>RJC6-4P+</b> <b>CAT6</b>	N/A (U/UTP)	305	6.0	3.8	0.23 (23) 1/0.55A	9.4	100	19.8	32.8	—
 Jacket color: <b>LB</b>	<b>RJC5E-4P+</b> <b>CAT5e</b>	N/A (U/UTP)	305	5.0	3.0	0.20 (24) 1/0.50A	9.4	100	22.0	—	—

Insulation: polyethylene Jacket: PVC Dielectric strength: 700V AC/min.

#### RJC6A-4P-F

- Standard CAT6A STP cable
- Tightly twisted 24 AWG solid conductors
- Length markings on jacket

#### RJC6-4P+

- Standard CAT6 UTP cable
- 23 AWG solid conductors
- Length markings on jacket
- UL 444 type CM
- Packaged in a pull box

#### RJC6-4P-F

- Standard CAT6 STP cable
- 24 AWG solid conductors
- Length markings on jacket



#### RJC5E-4P+

- Standard CAT5e UTP cable
- 24 AWG solid conductors
- Length markings on jacket
- UL 444 type CM
- Packaged in a pull box

75Ω Coaxial Cables

Analog to digital. HD to UHD. Canare 75Ω coaxial cable series expands the range of choices for any kind of video formats.

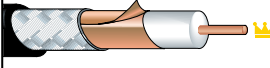
Ultra Coax **12G-SDI**

Type	Model	Sales units	Nom. O.D.	Weight	Inner cond.		Insulation	Outer conductors		Inner cond. resist.	Outer cond. resist.	Static capacity	Characteristic impedance	Attenuation	NVP
					Comp.	O.D.		Foil	Braid comp. (coverage)						
		m	mm	kg/100m	(AWG) Q'ty/mm	mm	mm	mm/ends/carriers	Ω/km	Ω/km	pF/m	Ω	dB/100m (6 GHz)	%	
	 L-3.3CUHD	100 200	5.5	4.1	(21) 1/0.75A	0.75	3.3	Cu	0.12TA/8/16 (92%)	41.4	14.9	55	75	68.5	82
	L-5.5CUHD	100 200 500 1000	7.7	7.1	(16) 1/1.35A	1.35	5.55	Cu	0.12TA/8/24 (91%)	12.8	10.3	52	75	39.1	86
	L-8CUHD	100 200 500 1000	11.1	14.1	(13) 1/2.00A	2.00	8.26	Cu	0.16TA/8/24 (90%)	5.8	6.3	52	75	27.9	86

Jacket colors for L-3.3CUHD, L-5.5CUHD: **BLK** **BRN** **GRN** **PPL**  
L-8CUHD: **BLK**





Jacket: PVC Dielectric strength: 1000V AC/min.

L-CUHD Series

- Specially designed for 12G-SDI
- The max. transmission distance of 4K UHD over L-5.5CUHD single link able to reach 100 m or longer\*.  
\*Depending on receiving equipment.
- As handy as conventional coaxial cables.
- Copper foil and high-density tinned copper braided shielding.
- Highly-foamed multi-layer PE insulation

Note 1: Designed for fixed installation, please avoid repeated bending or external pressure.  
Note 2: Cable strippers (TS100 series) cannot be used for L-5.5CUHD and L-8CUHD.

Super Coax

Type	Model	Sales units	Nom. O.D.	Weight	Inner cond.		Insulation	Outer conductors		Inner cond. resist.	Outer cond. resist.	Static capacity	Characteristic impedance	Attenuation	NVP
					Comp.	O.D.		Foil	Braid comp. (coverage)						
		m	mm	kg/100m	(AWG) Q'ty/mm	mm	mm	mm/ends/carriers	Ω/km	Ω/km	pF/m	Ω	dB/100m (1.5 GHz)	%	
	 L-2.5CHD	100 200	4.2	2.6	(23) 1/0.59A	0.59	2.59	AL	0.12TA/7/16 (95%)	66.9	16.9	53	75	43.1	82
	L-4CHD		6.1	5.2	(20) 1/0.82A	0.82	3.68	AL	0.14TA/8/16 (95%)	36.4	11.4	53	75	30.6	82
	 L-4.5CHD		7.0	6.2	(18) 1/1.02A	1.02	4.57	AL	0.14TA/6/24 (91%)	23.3	9.9	53	75	25.1	81
	L-5CHD		7.7	7.4	(17) 1/1.20A	1.20	4.9	AL	0.14TA/7/24 (93%)	16.1	8.2	53	75	22.5	85
	L-6CHD		8.9	9.0	(16) 1/1.40A	1.40	6.1	AL	0.14TA/8/24 (92%)	11.8	7.7	53	75	19.0	83
	 L-7CHD		10.2	13.0	(14) 1/1.80A	1.80	7.3	AL	0.16TA/8/24 (92%)	7.1	6.1	53	75	15.9	84
	L-8CHD		11.1	13.5	(12) 1/2.00A	2.00	8.2	AL	0.16TA/8/24 (89%)	5.8	6.3	53	75	14.1	84
	L-2.5CHLT	100 200	4.2	1.8	(23) 1/0.59A	0.59	2.59	AL	0.14TCCA/6/16 (95%)	66.9	21.5	53	75	43.1	82

Jacket colors: **BLK** and others

Jacket: PVC Dielectric strength: 1000V AC/min.

L-CHD Series

- Best suited to 3G-SDI/HD-SDI transmission.
- Highly-foamed PE insulation allows further improvement in the attenuation characteristics.
- Multi-layer insulation in which to each layer is given a different foaming ratio is used to increase strength.
- High-density tinned copper braided shield with aluminum foil brings excellent shielding.
- Solid conductor

L-2.5CHLT





- Ideal for an O.B. van installation.
- Tinned copper-clad aluminum (CCA) braided shield brings an advantage in weight-saving.
- 30% lighter than L-2.5CHD, yet the same attenuation.
- Space-saving slim design: O.D. 4.2 mm
- High-density braided shield with aluminum foil
- Highly-foamed PE insulation
- Solid conductor

Note 1: Designed for fixed installation, please avoid repeated bending or external pressure.  
Note 2: L-2.5CHLT has less connection strength with the connector BCP-B25HD compared with L-2.5CHD.  
Note 3: Availability for Cable Stripper TS100 Series:  
OK: L-2.5CHD and L-2.5CHLT, N/A: others

# Cables

## 75Ω Coaxial Cables

### Mobile Coax

Type	Model	Sales units	Nom. O.D.	Weight	Inner cond.		Insulation	Outer conductors		Inner cond. resist.	Outer cond. resist.	Static capacity	Characteristic impedance	Attenuation	NVP
					Comp.	O.D.		Foil	Braid comp. (coverage)						
					m	mm	kg/100m	(AWG) Q'ty/mm	mm	mm	mm/ends/carriers	Ω/100m	Ω/100m	pF/m	Ω
	<b>L-5.5CUHWS</b>	100 200	8.1	8.9	(16) 7/NA	1.30	5.56		0.10TA/10/24 (92%) 0.10TA/10/24 (90%)	1.4	0.6	54	75	16.7	82.5
	Jacket colors: <b>BLK</b> and others														
	<b>L-2.5CHWS</b>	100 200	4.2	3.2	(24) 7/0.20A	0.6	2.6		0.10TA/8/16 (95%) 0.10TA/9/16 (94%)	8.5	1.0	53	75	37.4	81
	Jacket colors: <b>BLK</b> and others														
	<b>L-4.5CHWS</b>	100 200	7.2	6.6	(20) 7/0.34A	1.02	4.57		0.10A/8/24 (93%) 0.10A/9/24 (95%)	3.3	0.8	53	75	22.8	79.5
	Jacket colors: <b>BLK</b> and others														
	<b>L-3CFW</b>	100 200	5.8	5.1	(22) 1/0.65A	0.65	3.1		0.12A/5/24 (94%) 0.12A/6/24 (94%)	5.5	0.7	55	75	33.1	79
	<b>L-5CFW</b>	1000	7.7	8.1	(18) 1/1.05A	1.05	5.0		0.12A/7/24 (93%) 0.12A/9/24 (96%)	2.1	0.5	55	75	19.4	79
Jacket colors: <b>BLK</b> and others															

Jacket: PVC Dielectric strength: 1000V AC/min.

#### L-5.5CUHWS **12G-SDI** Coming Soon

- Specially designed for 12G-SDI mobile applications
- Flexible and low loss structure
- Highly-foamed PE insulation
- High-density double braided shield

#### L-CFW Series

- Designed for mobile applications
- Solid center conductor
- Foamed PE insulation
- High-density double braided shield

#### L-CHWS Series

- Designed for mobile applications
- Flexible stranded center conductor
- Highly-foamed PE insulation
- High-density double braided shield

**Note:** Cable strippers (TS100 series) cannot be used for Mobile Coax.

### Low Loss Coax

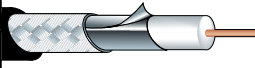
Type	Model	Sales units	Nom. O.D.	Weight	Inner cond.		Insulation	Outer conductors		Inner cond. resist.	Outer cond. resist.	Static capacity	Characteristic impedance	Attenuation	NVP
					Comp.	O.D.		Foil	Braid comp. (coverage)						
					m	mm	kg/100m	(AWG) Q'ty/mm	mm	mm	mm/ends/carriers	Ω/100m	Ω/100m	pF/m	Ω
	<b>L-2.5CFB</b>	100 200	4.0	2.4	(25) 1/0.50A	0.50	2.4	AL	0.12TA/6/16 (92%)	9.3	2.0	55	75	37.0	79
	<b>L-3CFB</b>		5.5	4.0	(22) 1/0.65A	0.65	3.1	AL	0.14TA/6/16 (91%)	5.5	1.6	55	75	29.1	79
	<b>L-4CFB</b>		6.1	4.9	(20) 1/0.80A	0.80	3.7	AL	0.14TA/8/16 (93%)	3.6	1.1	55	75	23.6	79
	<b>L-5CFB</b>		7.7	7.3	(18) 1/1.05A	1.05	5.0	AL	0.14TA/7/24 (93%)	2.1	0.8	55	75	17.7	79
	<b>L-7CFB</b>		10.2	13.0	(15) 1/1.50A	1.50	7.3	AL	0.18TA/8/24 (95%)	1.0	0.5	55	75	13.4	79
Jacket colors for L-2.5CFB: <b>BLK</b> L-3CFB: <b>BLK</b> and others L-4CFB: <b>BLK</b> and others L-5CFB: <b>BLK</b> and others L-7CFB: <b>BLK</b>															



Jacket: PVC Dielectric strength: 1000V AC/min.

#### L-CFB Series

- Suited to HD video signals
- High-density tinned copper braided shield with aluminum foil
- Solid center conductor
- Foamed PE insulation

**Note:** Designed for fixed installation, please avoid repeated bending or external pressure.

■ Standard Coax (Solid PE Insulation)

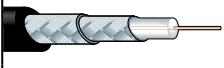
Type	Model	Sales units	Nom. O.D.	Weight	Inner cond.		Insulation	Outer conductors		Inner cond. resist.	Outer cond. resist.	Static capacity	Characteristic impedance	Attenuation	NVP
					Comp.	O.D.		O.D.	Braid composition (coverage)						
		m	mm	kg/100m	(AWG) Q'ty/mm	mm	mm	mm	mm/ends/carriers	Ω/100m	Ω/100m	pF/m	Ω	dB/100m (10 MHz)	%
 <b>L-3C2VS</b> Jacket colors: <b>BLK</b> and others	<b>L-1.5C2VS</b>	200	2.9	1.3	(31) 7/0.09A	0.27	1.6		0.10A/5/16 (94%)	41.9	3.3	69	75	8.7	66
	<b>L-3C2VS</b>	100 200	5.5	4.5	(25) 7/0.18A	0.54	3.1		0.12A/7/16 (94%)	10.5	1.9	67	75	4.5	66
	<b>LV-61S</b>	153	6.1	5.0	(24) 7/0.20A	0.60	3.6		0.12A/6/24 (95%)	8.5	1.3	67	75	3.8	66
	<b>L-5C2VS</b>	100 200	7.4	6.8	(22) 7/0.26A	0.78	4.8		0.12A/7/24 (93%)	5.0	1.2	67	75	2.9	66
 <b>L-3C2V</b> Jacket colors: <b>BLK</b> and others	<b>L-2.5C2V</b>	100 200	4.0	2.4	(26) 1/0.40A	0.40	2.4		0.12TA/6/16 (94%)	19.2	2.1	69	75	5.2	66
	<b>L-3C2V</b>		5.4	4.3	(25) 1/0.50A	0.50	3.1		0.14TA/5/24 (97%)	9.3	1.2	67	75	4.1	66
	<b>L-5C2V</b>		7.4	7.2	(20) 1/0.80A	0.80	4.9		0.14TA/7/24 (94%)	3.6	0.8	67	75	2.5	66
 <b>L-3C2W</b> Jacket color: <b>BLK</b>	<b>L-3C2W</b>	100 200	6.5	7.0	(25) 1/0.50A	0.50	3.1		0.14TA/5/24 (97%) 0.14TA/5/24 (93%)	9.3	0.6	67	75	4.1	66
	<b>L-5C2W</b>		8.3	11.0	(20) 1/0.80A	0.80	4.9		0.14TA/7/24 (94%) 0.14TA/7/24 (95%)	3.6	0.4	67	75	2.5	66
	<b>LV-77S</b>	153	7.7	9.0	(22) 7/0.26A	0.78	4.8		0.12A/7/24 (92%) 0.12A/8/24 (95%)	5.0	0.6	67	75	3.4	66

Jacket: PVC Dielectric strength: 1000V AC/min.

**L-1.5C2VS, L-3C2VS, L-5C2VS, LV-61S**

- Ideal for locations requiring cable bending.
- Flexible stranded center conductor
- High-density braided shield
- LV-61S is equivalent to RG-59B/U

**L-2.5C2V, L-3C2V, L-5C2V**

- Solid center conductor
- High-density tinned copper braided shield

**L-3C2W, L-5C2W**

- Solid center conductor
- High-density tinned copper double braided shield

**LV-77S**

- Ideal for locations requiring cable bending.
- Flexible stranded center conductor
- High-density double braided shield

**Note:** Cable strippers (TS100 series) cannot be used for L-1.5C2VS, L-3C2W, L-5C2W and LV-77S

Analog HD Coax

Type	Model	Sales units	Nom. O.D.	Weight	Inner cond.		Insulation	Outer conductors		Inner cond. resist.	Outer cond. resist.	Static capacity	Characteristic impedance	Attenuation	NVP
					Comp.	O.D.		O.D.	Foil						
		m	mm	kg/100m	(AWG) Q'ty/mm	mm	mm	mm	mm/ends/carriers	Ω/100m	Ω/100m	pF/m	Ω	dB/100m (10 MHz)	%
 Jacket colors: <b>BLK</b>   <b>WHT</b>	<b>L-3C-AHD</b>	300	5.5	3.0	(21) 1/0.75A	0.75	3.3	AL	0.14AL/4/24 (84%)	4.1	3.7	55	75	2.5	82

Jacket: PVC Dielectric strength: 1000V AC/min.

**L-3C-AHD**

- Cost effective aluminum alloy braided shield
- Recommended for an analog high definition video surveillance system.
- Fits for AHD, HD-TVI and HD-CVI, and also for HD-SDI or EX-SDI
- Highly-foamed PE insulation for better transmission characteristics
- Packaged in REELEX pull box

**Nominal Attenuation**

dB/100m

NTSC D1 7MHz	NTSC WD1 10MHz	AHD 1080/30p 36MHz	HD-TVI 1080/30p 48MHz	EX-SDI 1080/30p 135MHz	270 MHz	HD-SDI 750MHz	3G-SDI 1500MHz
2.0	2.5	4.9	5.7	10.1	14.3	24.2	34.7

**Note 1:** The aluminum braid cannot be soldered. BNC crimp plug for L-3C-AHD: BCP-A3AHD (see page29)

**Note 2:** Designed for fix installation

# Cables

## 75Ω Coaxial Cables



### 75Ω Triaxial Cables

Type	Model	Sales units	Nom. O.D.	Weight	Inner cond.		Insulation 1		Outer cond.1		Insulation 2		Outer cond.2		Electrical characteristics		
					Comp.	O.D.	O.D.	Braid coverage and comp.	O.D.	Braid coverage and comp.	Inner cond. resistance	Outer cond. resistance	Static capacity	Charac-teristic impedance	Atten-uation	NVP	
					(AWG) Q'ty/mm	mm	mm	mm/ends/carriers	mm	mm/ends/carriers	Ω/100m	Ω/100m	pF/m				Ω
m	mm	kg/100m															
 L-5CFTX Jacket colors: <b>BLK</b> <b>RED</b> <b>GRN</b>	L-5CFTX	100 200	8.8	12.0	(19) 1/1.0A	1.0	4.8	0.14A/6/24 (91%)	6.4	0.16A/8/24 (95%)	2.3	—	55	75	2.2	79	
	L-4CFTX	100 200	9.1	10.5	(20) 1/0.80A	0.80	3.7	0.14A/7/16 (93%)	5.5	0.14A/7/24 (94%)	3.64	—	55	75	3.0	79	
	L-7CFTX	100 200 500	11.0	15.4	(16) 1/1.40A	1.40	6.5	0.14A/8/24 (93%)	8.7	0.14A/8/24 (88%)	1.18	—	55	75	1.7	79	

Insulation : 1: foamed PE 2: polyethylene Dielectric strength : 1000V AC/min.

- For digital or analog broadcast camera applications.
- Abrasion-resistance PVC jacket.

### 75Ω Multichannel Coaxial Cables

Type	Model	No. of ch.	Sales units	Nom. O.D.	Weight	Unit composition						Inner cond. resist.	Outer cond. resist.	Charac-teristic impedance	Atten-uation	NVP	
						Inner cond.		Insulation		Outer conductors							Unit O.D.
						Comp.	O.D.	O.D.	Foil	Braid comp. (coverage)	mm						
m	mm	kg/100m	(AWG) Q'ty/mm	mm	mm	mm/ends/carriers	mm	Ω/100m	Ω/100m	Ω	dB/100m (750 MHz)	%					
 V4-CFB Jacket color: <b>BLK</b> Insulation: Foamed PE	V3-3CFB	3	100 500	11.5	14	(22) 1/0.65A	0.65	3.1	AL	0.14TA/6/16 (91%)	4.4	5.6	1.6	75	29.1	79	
	V4-3CFB	4		13.0	19												
	V5-3CFB	5		14.2	23												
	V3-4CFB	3		12.9	18	(20) 1/0.80A	0.80	3.7	AL	0.14TA/8/16 (93%)	5.0	3.6	1.1	75	24.3	79	
	V4-4CFB	4		14.4	23												
	V5-4CFB	5		16.1	29												
	V3-5CFB	3		17.1	29	(18) 1/1.05A	1.05	5.0	AL	0.14TA/7/24 (93%)	6.5	2.1	0.8	75	17.7	79	
	V4-5CFB	4		18.8	36												
	V5-5CFB	5		21.1	46												
 V4-2.5CHW Jacket color: <b>BLK</b> Insulation: Highly-foamed PE	V4-2.5CHW	4	100 500	13.0	21	(23) 1/0.59A	0.59	2.59	—	0.10TA/8/16 (95%) 0.10TA/9/16 (94%)	4.2	6.7	1.0	75	35.7	81	
	V3-3CFW	3	100 500	13.0	22	(22) 1/0.65A	0.65	3.1	—	0.12A/5/24 (94%) 0.12A/6/24 (94%)	4.9	5.6	0.7	75	33.1	79	
V4-3CFW	4	14.6		28													
V5-3CFW	5	16.2		34													
V3-5CFW	3	18.4		36	(18) 1/1.05A	1.05	5.0	—	0.12A/7/24 (93%) 0.12A/9/24 (96%)	7.0	2.1	0.5	75	19.4	79		
V4-5CFW	4	20.4		47													
V5-5CFW	5	22.4		58													
 V4-C Jacket color: <b>BLK</b> Insulation: Solid PE	V3-1.5C	3	100 500	7.4	7.3	(31) 7/0.09A	0.27	1.55	—	0.10A/5/16 (94%)	2.6	42.3	3.3	75	—	66	
	V4-1.5C	4		8.4	9.4												
	V5-1.5C	5		9.2	11												
	V3-3C	3		11.5	15	(25) 7/0.18A	0.54	3.1	—	0.14A/5/24 (97%)	4.4	10.6	1.1	75	43.2	66	
	V4-3C	4		13.0	20												
	V5-3C	5		14.2	24												
	V3-5C	3		15.5	26	(22) 7/0.26A	0.78	4.8	—	0.12A/7/24 (93%)	6.0	5.1	1.2	75	29.2	66	
	V4-5C	4		17.1	33												
	V5-5C	5		19.2	39												

Jacket PVC Dielectric strength : 1000V AC/min.

#### V-CFB Series

- Low-loss multichannel coax for fixed installations.

#### V-CHW, V-CFW Series

- Mobile multichannel coax developed for digital video signals.

Note: Cable strippers (TS100 series) cannot be used for V-CHW, V-CFW, and V-1.5C.

#### V-C Series

- Our long selling standard multichannel coax with flexible stranded center conductor.
- Ideal for component video signals.

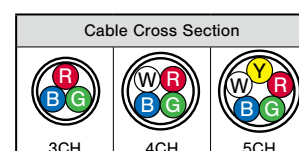

# Technical Note

## Many types of video coax. What're the differences and how select?

In brief, there are three of essential factors: 1) center conductor, 2) insulation, and 3) shield. Each factor has its advantage and disadvantage as described below:

- 1) Center Conductor: two types existing, "Solid" and "Stranded". Stranded conductor is more flexible and therefore the best choice for mobile and stage use.
- 2) Insulation: includes "Solid", "Foamed", and "Highly-foamed" types. Foamed and highly-foamed insulation would perform better attenuation, compared to the solid type thus they are often selected for hi-def video. However, since foamed and high-foamed insulation contain the air physically, they are weak to external pressure. You should pay attention to where and how the cables are installed.
- 3) Shield: we have "Braided" and "Braided with aluminum foil" type. Braided shields include single, double, or triple layers as well as bare copper or tinned copper. Braided with aluminum foil offers perfect screening, but they are not suitable for repeated bending and mobile applications due to the foil's lack of strength. In that case, it's better to choose "Braided".

**Braided Shield**



**Double-Layer Braided Shield**



**Braided Shield with Aluminum Foil**



## What is Propagation Delay?

Propagation delay refers to the time required for a signal to be transmitted from one end of connection to another. In the case of cable transmission, this greatly depends on the materials and construction of the actual cable, and large differences in delay can cause transmission errors if they exceed the receiver delay tolerance.

The following table shows the differences in coaxial cable propagation delay time relative to the insulation type.

### Propagation Delay Caused by Coaxial Cable Insulation (reference)

Insulation	Propagation Delay
Solid PE	5.0 ns/m
Foamed PE	4.2 ns/m
Highly-Foamed PE	3.7 ns/m

### Typical Transmission Distance as per SMPTE Standard

SMPTE Designation	ST 259 SD-SDI				ST 344	ST 292	ST 424	ST 2082-1
	NTSC	PAL	525/625 (4:3)	525/625 (16:9)	540 Mbps-SDI	HD-SDI	3G-SDI	12G-SDI
Video Format	NTSC	PAL	525/625 (4:3)	525/625 (16:9)	525/625 (4:3) p60	2K 1080i	2K 1080p	4K UHD
Bit Rate	143 Mb/s	177 Mb/s	270 Mb/s	360 Mb/s	540 Mb/s	1.5 Gb/s	3 Gb/s	12 Gb/s
Clock	143 MHz	177 MHz	270 MHz	360 MHz	540 MHz	1.485 GHz	2.97 GHz	11.88 GHz
Cable Loss @ 1/2 Clock	30 dB @ 72 MHz	30 dB @ 88 MHz	30 dB @ 135 MHz	30 dB @ 180 MHz	30 dB @ 270 MHz	20 dB @ 750 MHz	30 dB @ 1.5 GHz	40 dB @ 6 GHz
Model	m	m	m	m	m	m	m	m
L-2.5CFB	265	242	199	172	139	54	55	32
L-2.5CHD	314	287	237	206	168	66	69	43
L-2.5CHLT	314	287	237	206	168	66	69	43
L-3CFB	344	314	257	222	179	68	69	42
L-3.3CUHD	461	422	306	265	215	85	90	58
L-4CFB	422	314	315	272	220	84	86	52
L-4CHD	447	410	337	294	238	93	98	61
L-5CFB	563	513	420	364	294	112	114	68
L-4.5CHD	551	504	415	361	293	115	119	74
L-5CHD	614	562	464	403	327	128	133	82
L-6CHD	766	700	575	499	403	154	158	95
L-5.5CUHD	769	697	566	491	400	155	161	102
L-7CHD	902	824	678	589	476	184	188	116
L-8CHD	1034	937	769	681	545	208	212	131
L-8CUHD	1034	937	789	681	555	219	227	143
L-2.5CHWS	275	247	198	171	138	53	54	32
V4-2.5CHW	288	258	208	178	144	56	57	34
L-3CFW	319	288	230	197	158	60	60	35
L-4.5CHWS	447	405	322	280	225	87	90	(*1)
L-5CFW	535	483	384	333	267	103	105	(*1)
L-5.5CUHWS	625	566	447	389	312	119	121	(*1)

\*The above values are distances when cable loss reaches a typical attenuation specified by SMPTE standard at 1/2 clock frequency.

\*These values are not equivalent to actual transmission distances, which depends on the equalized distance of receiver.

\*Please check with vendor of receiver for equalized distance and reference cable to calculate actual transmission distance.

(\*1)Distance may vary depending on conditions. Contact Canare for the proper information.

# Cables

## 75Ω Coaxial Cables

### 75Ω Coax Cable Nominal Attenuation

dB/100m



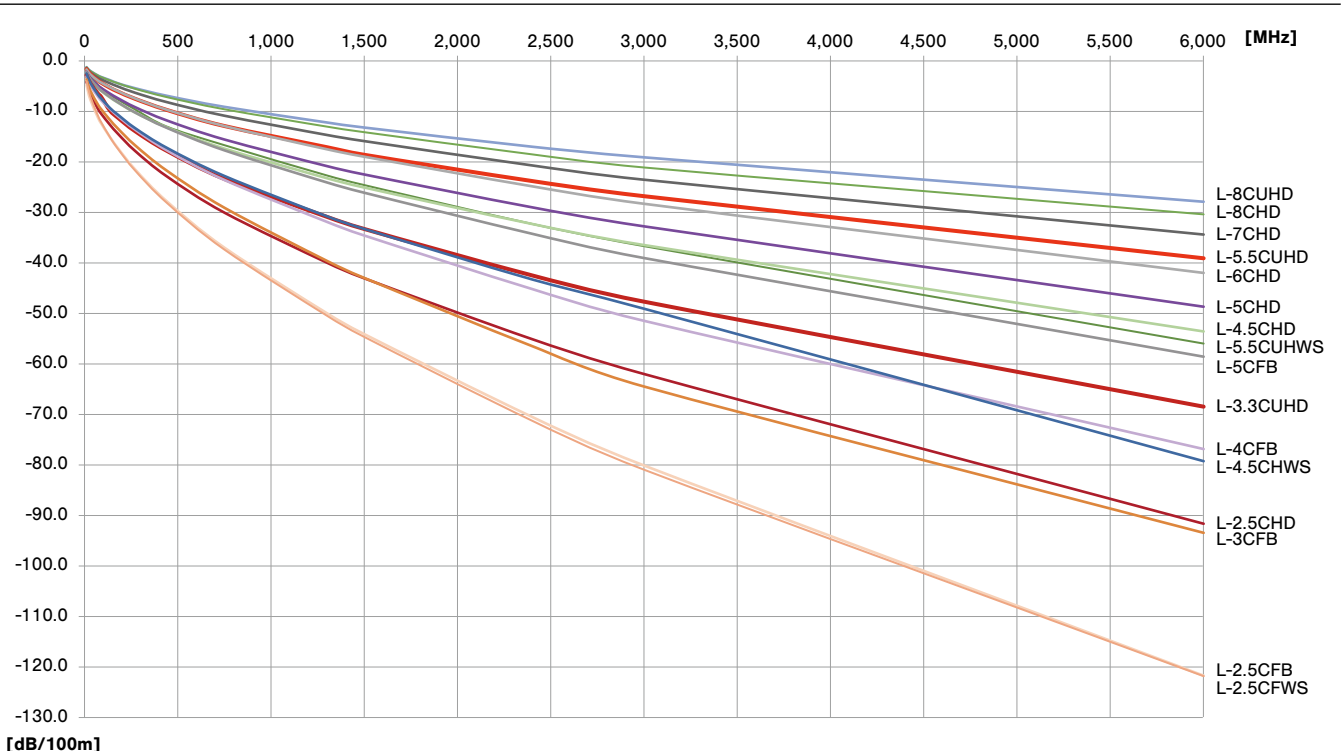

Model	Frequency											
	10MHz	30MHz	72.0MHz	88.0MHz	135MHz	180MHz	270MHz	750MHz	1.3GHz	1.5GHz	3GHz	6GHz
L-1.5C2VS/V*-1.5C	8.7	15.2	23.8	26.4	32.9	38.1	47.1	80.5	108.6	117.5	173.4	—
L-2.5CFB	4.8	7.6	11.3	12.4	15.1	17.4	21.5	37.0	50.0	54.1	80.2	121.8
L-2.5CHD/L-2.5CHLT	4.1	6.5	9.5	10.4	12.6	14.5	17.8	30.2	40.0	43.1	62.0	91.7
L-2.5CHWS	4.0	7.0	10.9	12.1	15.1	17.5	21.7	37.4	50.5	54.7	81.0	121.9
V4-2.5CHW	3.8	6.7	10.4	11.6	14.4	16.8	20.7	35.7	48.3	52.3	77.4	115.9
L-3C2V/L-3C2W	4.1	7.2	11.3	12.5	15.7	18.3	22.8	40.0	54.9	59.7	90.5	—
L-3C2VS/V*-3C	4.5	7.9	12.4	13.7	17.2	20.0	24.8	43.2	58.9	63.9	96.0	—
L-3CFB/V*-3CFB	3.7	5.9	8.7	9.5	11.7	13.5	16.7	29.1	39.6	43.0	64.5	93.5
L-3CFW/V*-3CFW	3.4	5.9	9.4	10.4	13.0	15.2	18.9	33.1	45.4	49.4	74.8	114.2
L-3.3CUHD	2.8	4.4	6.5	7.1	9.8	11.3	13.9	23.4	30.9	33.3	47.7	68.5
L-4CFB	3.0	4.8	7.1	7.8	9.5	11.0	13.6	23.6	31.9	34.6	51.5	76.9
V*-4CFB	3.0	4.9	7.2	7.9	9.7	11.2	13.9	24.3	33.2	36.0	54.3	83.8
L-4CHD	2.9	4.6	6.7	7.3	8.9	10.2	12.6	21.3	28.4	30.6	44.3	65.1
L-4.5CHD	2.3	3.7	5.4	6.0	7.2	8.3	10.2	17.4	23.2	25.1	36.5	53.6
L-4.5CHWS	2.5	4.3	6.7	7.4	9.3	10.7	13.3	22.8	30.8	33.3	49.1	79.3
L-5C2V/L-5C2W	2.5	4.5	7.1	7.9	9.9	11.6	14.4	25.7	35.6	38.9	59.9	94.8
L-5C2VS/V*-5C	2.9	5.1	8.1	9.0	11.3	13.2	16.5	29.3	40.8	44.4	68.3	108.0
L-5CFB/V*-5CFB	2.2	3.6	5.3	5.8	7.1	8.2	10.2	17.7	24.1	26.1	39.1	58.6
L-5CFW/V*-5CFW	2.1	3.6	5.6	6.2	7.8	9.0	11.2	19.4	26.2	28.4	42.2	70.5
L-5CHD	2.1	3.3	4.9	5.3	6.5	7.4	9.1	15.6	20.8	22.5	32.8	48.7
L-5.5CUHD	1.6	2.6	3.9	4.3	5.3	6.1	7.5	12.9	17.1	18.6	26.8	39.1
L-5.5CUHWS	1.7	3.1	4.8	5.3	6.7	7.7	9.6	16.7	22.7	24.6	36.7	56.0
L-6CHD	1.7	2.7	3.9	4.3	5.2	6.0	7.4	12.9	17.5	19.0	28.3	42.0
L-7CFB	1.6	2.5	3.8	4.2	5.1	6.0	7.5	13.4	18.8	20.5	32.0	53.6
L-7CHD	1.4	2.3	3.3	3.6	4.4	5.1	6.3	10.9	14.7	15.9	23.5	34.4
L-8CHD	1.2	2.0	2.9	3.2	3.9	4.4	5.5	9.6	13.0	14.1	21.1	30.4
L-8CUHD	1.2	2.0	2.9	3.2	3.8	4.4	5.4	9.1	12.2	13.2	19.1	27.9
LV-61S	3.8	6.6	10.4	11.6	14.5	16.9	20.9	36.6	49.9	54.2	81.7	126.0
LV-77S	2.9	5.2	8.1	9.0	11.3	13.1	16.3	28.6	—	—	—	—

75Ω Low Loss Coax Cable Attenuation Chart





50Ω Coaxial Cables

Type	Model	Sales units	Nom. O.D.	Weight	Inner cond.		Insulation		Outer conductors		Inner cond. resist.	Outer cond. resist.	Static capacity	Characteristic impedance	Attenuation
					Comp.	O.D.	O.D.	Foil	Braid comp. (coverage)						
					(AWG) Q'ty/mm	mm	mm		mm/ends/ carriers						
 <b>L-3D2V</b> Jacket: PVC Color: <b>GRY</b>	<b>L-3D2V</b>	100	5.3	4.5	(20) 7/0.32A	0.96	3.0	—	0.14TA/5/24 (98%)	3.3	1.2	100	50	4.5	
	<b>L-5D2V</b>	200	7.3	7.9	(15) 1/1.40A	1.40	4.8	—	0.14TA/7/24 (95%)	1.2	0.8	100	50	2.5	
 <b>L-3D2W</b> Jacket: PVC Color: <b>GRY</b>	<b>L-3D2W</b>	100	6.4	7.3	(20) 7/0.32A	0.96	3.0	—	0.14TA/5/24 (98%) 0.14TA/5/24 (96%)	3.3	0.6	100	50	4.5	
	<b>L-5D2W</b>	200	8.0	11.0	(15) 1/1.40A	1.40	4.8	—	0.14TA/7/24 (95%) 0.14TA/7/24 (96%)	1.2	0.4	100	50	2.5	
 <b>L-5DFB</b> Jacket: PVC Color: <b>BLK</b>	<b>L-5DFB</b>	100	7.6	8.5	(14) 1/1.80A	1.80	5.0	AL	0.14TA/6/24 (90%)	0.7	1.1	84	50	2.5	
 <b>L-5DFBW-PE</b> Jacket: PE Color: <b>BLK</b>	<b>L-5DFBW-PE</b>	100	8.0	10.4	(14) 1/1.80A	1.80	5.0	AL	0.14TA/7/24 (93%) 0.14TA/8/24 (95%)	0.7	0.4	84	50	2.3	

Insulation: polyethylene Dielectric strength: 1000V AC/min

**L-3D2V, L-5D2V**

- Tinned copper braided shield

**L-3D2W, L-5D2W**

- Tinned copper double braided shield

**L-5DFB**

- Low-loss foamed PE insulation
- Tinned copper braided shield with aluminum foil.

**Note:** Designed for fixed installation.

**L-5DFBW-PE**

- Ideal for digital microwave communication systems
- PE jacket for fixed outdoor installation
- Low-loss foamed PE insulation
- Tinned copper double braided shield with aluminum foil

**Note:** Designed for fixed installation.

■ 50Ω Coax Cable Nominal Attenuation

dB/100m

Model		Frequency													
		10 MHz	130 MHz	470 MHz	600 MHz	710 MHz	714 MHz	800 MHz	1240 MHz	1260 MHz	1575 MHz	1700 MHz	2000 MHz	2400 MHz	2600 MHz
50Ω	<b>L-3D2V/L-3D2W</b>	4.5	17.3	35.4	40.7	44.9	45.1	48.2	62.6	63.2	72.5	76.0	84.1	94.4	99.3
	<b>L-5D2V/L-5D2W</b>	2.5	9.6	19.6	22.6	25.0	25.1	26.8	35.0	35.3	40.5	42.5	47.1	53.0	55.8
	<b>L-5DFB</b>	2.5	7.5	14.6	16.8	18.5	18.5	19.8	25.5	25.8	29.4	30.8	33.9	37.9	39.9
	<b>L-5DFBW-PE</b>	2.3	6.8	14.0	16.0	17.5	17.6	18.7	23.9	24.1	27.3	28.5	31.3	34.8	36.5

# Panels and Patchbays

## 75Ω Video Patchbays

### Overview

Video patchbays, as a backup or a final means for safety in a routing system, often face high demand on stable and constant patching connections and contacts. Over the decades, Canare has focused on these essentials and has developed the solutions for the latest video format such as 4K/8K.

The following table will help finding the right panels for you.

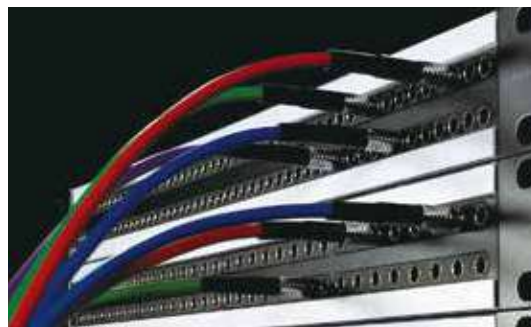

### Product Finder









Page	74	75	76	77	78
Applications	4K/8K 12G-SDI 6G-SDI	4K/8K 12G-SDI 6G-SDI	2K/4K 3G-SDI HD-SDI	2K/4K 3G-SDI HD-SDI	2K/4K 3G-SDI HD-SDI
Patchbays					
	32MCK-ST*	32SVK-ST	48MC*	32MD-ST*	2xDV*
Channels	32	32	48	32	20, 24, 26
Rack Unit	1RU	1RU, 1.5RU	1RU	1RU, 2RU, 4RU	1RU, 2RU
Additional Panel Option	—	2RU	1.5RU, 2RU	1.5RU	—
Jacks					
	MCVJK-STW/S	SVJK-S/L	MCVJ-W/S	MDVJ-STW/S	DVJB-W/S
Self Terminating	Yes	No	Yes	Yes	Yes
Front	Canare Micro	Canare Single	Canare Micro	Mini-WECO	WECO
Rear	BNC	BNC	DIN 1.0/2.3	BNC	BNC
NET Weight (approx.)	2.8 kg	1RU: 1.7 kg 1.5RU: 2.4 kg	2.3 kg	1RU: 2.9 kg 2RU: 3.9 kg 4RU: 8.0 kg	20DV: 2.4 kg (1RU) 24DV: 2.7 kg (1RU) 26DV: 2.8 kg (1RU)
SMPTE	ST 2081-x ST 2082-x		ST 292 ST 424 ST 425-x		
Features	Mechanical switch with Dust-proof Shutter	MUSA style Hassle-free patching	Mechanical switch with Dust-proof Shutter	100% sealed rotary switch	100% sealed rotary switch
Patch Cord/U-Link					
	MCVPC**	SVP-ULK SVP**	MCVPC**	MVPC**	VPC**

WECO: Western Electric Company (W.E. standard)

## Technical Note

### Dual Video Jack Normalling Chart

There are two types of dual video jacks: Normal Through and Straight Through. In Canare, these are identified at the end of the model name, W means the former and S means the latter. The following chart explains the differences between two types.

W type (Normal Through)				S type (Straight Through)			
Video Port: No Patch		BNC Port: Signal thru as Arrowed	Signal routes between top and bottom BNC without the use of Video plugs.	Video Port: No Patch		BNC Port: Both Signal Terminated	Two independent single jacks in a dual housing.
Video Port: Patch Upper		BNC Port: Lower Terminated	Inserting a Video Patch Cord into front "upper" port automatically terminates signal path into the lower 75Ω load.	Video Port: Patch Upper		BNC Port: Lower Terminated	Inserting a Video Patch Cord into front "upper" port automatically terminates signal path into the lower 75Ω load.
Video Port: Patch Lower		BNC Port: Upper Terminated	Inserting a Video Patch Cord into front "lower" port automatically terminates signal path into the upper 75Ω load.	Video Port: Patch Lower		BNC Port: Upper Terminated	Inserting a Video Patch Cord into front "lower" port automatically terminates signal path into the upper 75Ω load.
Video Port: Patch Both		BNC Port: Signal thru as Arrowed	Inserting Video Patch Cords into both front ports inputs and/or outputs signal.	Video Port: Patch Both		BNC Port: Signal thru as Arrowed	Inserting Video Patch Cords into both front ports inputs and/or outputs signal.

75Ω Staggered Video Patchbays

The next-generation 12G-ready video patchbays with newly developed staggered dual video jacks.

■ Patchbays **12G-SDI**

Model	Panel Size	Loaded Video Jacks
<b>32MCK-ST</b>	1RU	32 × MCVJK-STW
<b>32MCK-STs</b>	1RU	32 × MCVJK-STs

Standard panel color: Black. Available in 5 colors. see page 79.

Key Features and Benefits

- 12G-SDI: SMPTE ST 2082-1 compliant
- 32 channels of I/O into 1RU
- Staggered BNC rear jacks
- Dust-proof shutter
- Included a sheet of channel designator for easy identification.
- Can be recessed 25 mm.
- Lightweight aluminum alloy video jacks

Note: Be sure to use with Canare Micro Video Patch Cords.



■ Dual Video Jacks

Model	Description	Rear Jacks
<b>MCVJK-STW</b>	Normal through, Staggered rear jacks	BNC
<b>MCVJK-STs</b>	Straight through, Staggered rear jacks	BNC

■ Micro Video Plug

Model	Suitable Cable	Boot	Die Set
<b>MCVP-C25HW</b>	L-2.5CHWS	—	TCD-D253F

\*Standard package: 20 pcs

\*The plug is specifically designed for MCVJ and MCVJK jacks.

■ Accessories

Model	Description
<b>MCVPC**</b>	Canare Micro patch cords (see page 83)
<b>BCJ-MCVP</b> <span style="color:red">New</span>	BNC (female) to Micro Video plug conversion adapter (10 pcs)
<b>BET-BNC</b> <span style="color:gray">Coming Soon</span>	BNC extraction tool (see page 47)
<b>PH50B</b>	Patch cord holder for MCVPC**
<b>MCVJ-DC</b>	Dust cap for MCVJK (black, 100 pcs)
<b>MJ2-M32CK-1U-***</b>	Unloaded panels (see page 81)

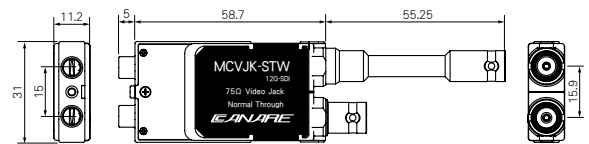
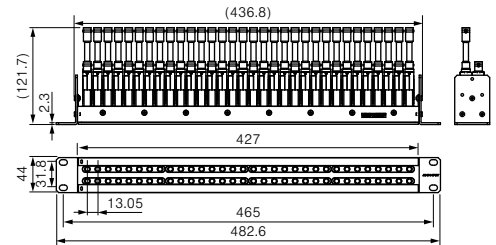

■ Return Loss & Isolation

Model	MCVJK-STW	MCVJK-STs
RL	BNC-BNC : Normal Through	—
	BNC-Video : Patch Through	15 dB or greater @ 1.5 GHz 10 dB or greater @ 3 GHz 7 dB or greater @ 6 GHz 4 dB or greater @ 12 GHz
	BNC-Self Termination	15 dB or greater @ 1.5 GHz 10 dB or greater @ 3 GHz 7 dB or greater @ 6 GHz 4 dB or greater @ 12 GHz
Isolation	45 dB or greater @ 6 GHz	45 dB or greater @ 6 GHz

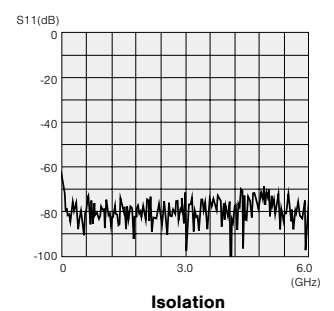
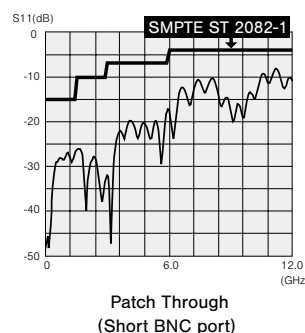
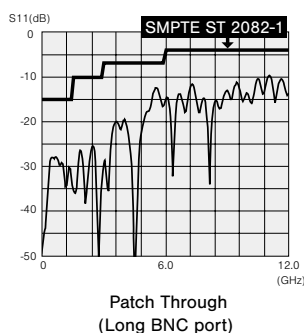
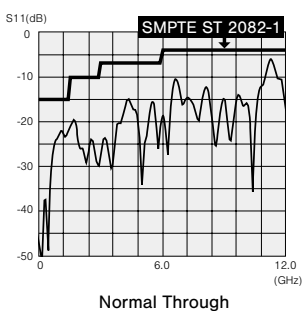

Return Loss for MCVJK-STW

Technical Trend

Fiber-Optic Systems

Connectors

Cables

Panels & Patchbays

Multichannel Systems

Cable Assemblies

# Panels and Patchbays

## 75Ω Video Patchbays

### 75Ω Single Video Patchbay

The true 12G-SDI video patching system: Canare exclusive 12G capable single jacks, convenient looping plug, flexible patch cords, and 75Ω termination video plug. This MUSA style solution exceeds 4K/8K UHD requirements. 1RU, 1.5RU, or 2RU panel options available.

#### ■ Patchbay **12G-SDI**

Model	Panel Size	Loaded Video Jacks
<b>32SVK-ST</b>	1RU	32 × SVJK-L 32 × SVJK-S
<b>32SVK-ST-1.5U</b>	1.5RU	32 × SVJK-L 32 × SVJK-S

**New**

Standard panel color: Black. Available in 9 colors. see page 79.

#### Key Features and Benefits

- 12G-SDI: SMPTE ST 2082-1 compliant
- Return loss performance: 15dB@12GHz
- 40% lighter than 32MCK-ST/32MD-ST
- 32 channels of I/O into 1RU or 1.5RU
- Canare original hassle-free patching design
- Staggered BNC rear jacks
- Can be recessed 25 mm.
- Included a sheet of channel designator for easy identification

**Note:** Be sure to use with Canare Single Video Patch Cords.



#### ■ Single Video Jacks

Model	Description	Rear Jack
<b>SVJK-L</b>	Long type	BNC
<b>SVJK-S</b>	Short type	BNC

\*Adapter plates: SVJK-AP should be used for loading the jacks. Call for the details.

#### ■ Single Video Plug

Model	Suitable Cable	Boot	Die Set
<b>SVP-C25HW</b>	L-2.5CHWS	CB02	TCD-D253F

\*Standard package: 20 pcs

#### ■ U-link and Termination Plugs

Model	Description
<b>SVP-ULK</b>	U-link/Looping plug
<b>SVP-TK</b>	Termination plug (standard package 20 pcs)

#### ■ Accessories

Model	Description
<b>SVPC**</b>	Canare SV patch cords (see page 83)
<b>BET-BNC</b> <small>Coming Soon</small>	BNC extraction tool (see page 47)
<b>PH50A</b>	Patch cord holder for SVPC**
<b>SVJK-DC</b>	Dust cap for SVJK (black, 10 pcs)
<b>MJ2-M32-U-***</b>	Unloaded panels (see page 81)

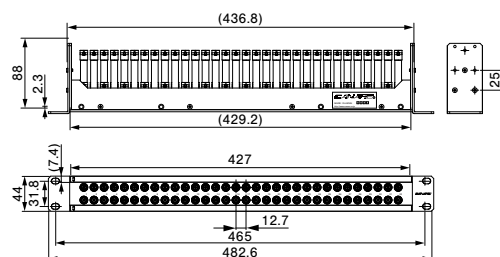
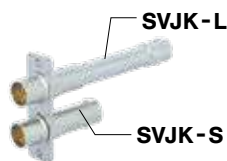
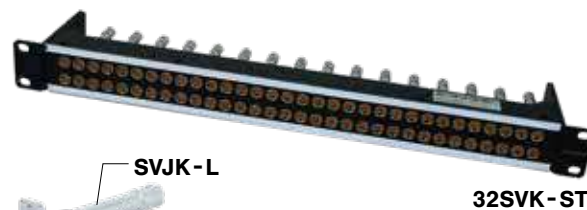

#### ■ Return Loss

Model	SVJK-S, SVJK-L	SVP-TK	SVP-ULK
@ 3 GHz	26 dB or greater	25 dB or greater	20 dB or greater
@ 6 GHz	20 dB or greater	20 dB or greater	15 dB or greater
@ 12 GHz	15 dB or greater	10 dB or greater	10 dB or greater

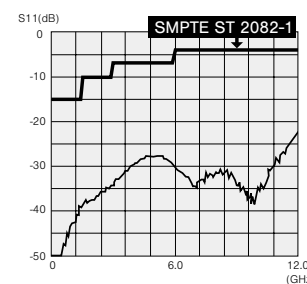
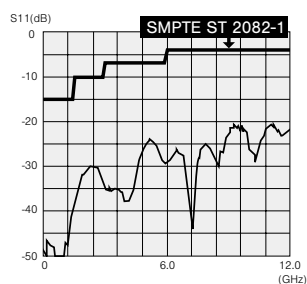
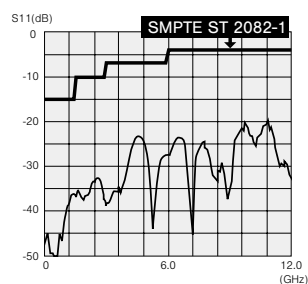
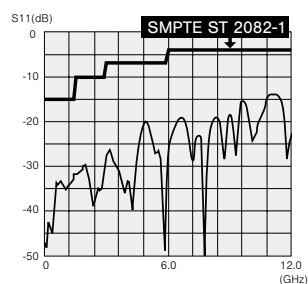

**75Ω Micro Video Patchbays**

Our unique, thinnest and lightest video jacks realize ultimate space efficiency.

**■ Patchbays**

Model	Panel Size	Loaded Video Jacks
<b>48MC</b>	1RU	48 × MCVJ-W
<b>48MCS</b>	1RU	48 × MCVJ-S

Standard panel color: Black. Available in 5 colors. Contact for more details.

**Key Features and Benefits**

- High density 48 channels of I/O into 1RU design.
- Video jack weights 35 g and is half of our conventional one.
- Space and weight saving; beneficial to O.B. vans
- DIN 1.0/2.3 rear jacks.
- Dust-proof shutter
- Included a sheet of channel designator for easy identification.
- Can be recessed 25 mm.
- 3G-SDI: SMPTE ST 424 compliant

**Note:** Be sure to use with Canare Micro Video Patch Cords.



**■ Dual Video Jacks**

Model	Description	Rear Jacks
<b>MCVJ-W</b>	Normal through	DIN 1.0/2.3
<b>MCVJ-S</b>	Straight through	DIN 1.0/2.3

**■ Micro Video Plug**

Model	Suitable Cable	Boot	Die Set
<b>MCVP-C25HW</b>	L-2.5CHWS	—	TCD-D253F

\*Standard package: 20 pcs

\*The plug is specifically designed for MCVJ and MCVJK jacks.

**■ Accessories**

Model	Description
<b>MCVPC**</b>	Canare Micro patch cords (see page 83)
<b>BCJ-MCVP</b> <span style="color:red">New</span>	BNC (female) to Micro Video plug conversion adapter (10 pcs)
<b>BET-DIN</b>	Extraction tool for DCP-C series (see page 47)
<b>BET-D/H</b> <span style="color:red">New</span>	
<b>PH50B</b>	Patch cord holder for MCVPC**
<b>MCVJ-DC</b>	Dust cap for MCVJ (black, 100 pcs)

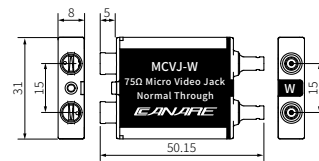
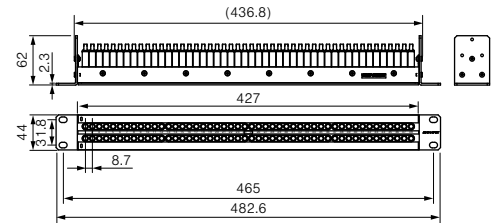

**■ Return Loss & Isolation**

Model	MCVJ-W	MCVJ-S
RL	DIN-DIN: Normal Through	20 dB or greater @ 3 GHz
	DIN-Video: Patch Through	20 dB or greater @ 3 GHz
	DIN-Self Termination	10 dB or greater @ 3 GHz
Isolation	45 dB or greater @ 3 GHz	45 dB or greater @ 3 GHz

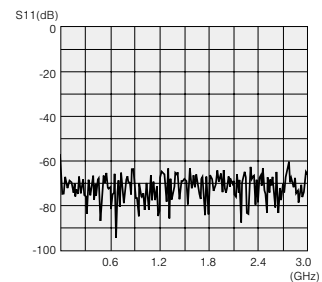
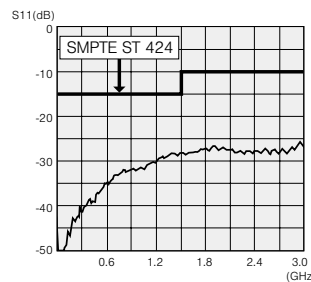
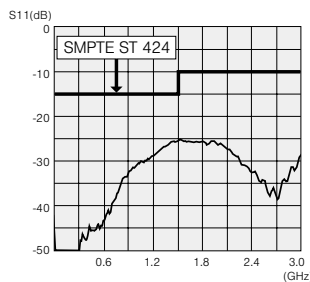

Normal Through

Patch Through

Isolation

Return Loss for MCVJ-W

Technical Trend

Fiber-Optic Systems

Connectors

Cables

Panels & Patchbays

Multichannel Systems

Cable Assemblies

# Panels and Patchbays

## 75Ω Video Patchbays

### 75Ω Staggered Mid-size Video Patchbays

3G-ready mid-size video jacks allow for more efficient use of rack space.

#### ■ Patchbays

Model	Panel Size	Loaded Video Jacks
<b>32MD-ST</b>	1RU	32 × MDVJ-STW
<b>32MD-ST-S</b>	1RU	32 × MDVJ-ST-S
<b>32MD-ST-2U</b>	2RU	32 × MDVJ-STW
<b>32MD-ST-S-2U</b>	2RU	32 × MDVJ-ST-S
<b>32MD-ST-4U</b>	4RU	96 × MDVJ-STW
<b>32MD-ST-S-4U</b>	4RU	96 × MDVJ-ST-S

Standard panel color: Black. Available in 9 colors. see page 79.

#### Key Features and Benefits

- 32 channels of I/O into 1 or 2RU, 96 channels of I/O into 4RU.
- Rotary Switch Technology with dual-contact construction.
- Can be recessed 25 mm (except 4RU type).
- Wide designation strip (2RU, 4RU type).
- Lightweight aluminum alloy video jacks.

**Note:** Be sure to use with Mini-WECO Video Patch Cords.



**32MD-ST-S**

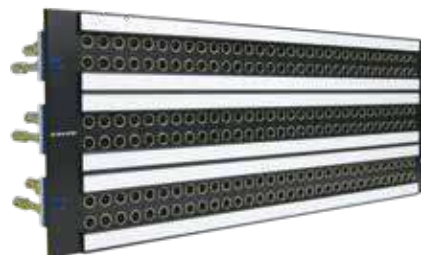

**32MD-ST-4U**

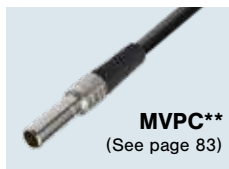

**MVPC\*\***  
(See page 83)

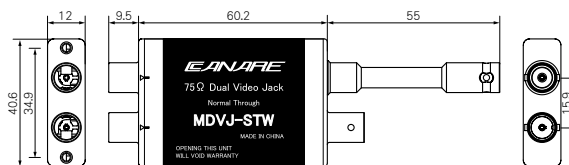

#### ■ Dual Video Jacks

Model	Description	Rear Jacks
<b>MDVJ-STW</b>	Normal through, Staggered rear jacks	BNC
<b>MDVJ-ST-S</b>	Straight through, Staggered rear jacks	BNC



**MVP-C4**

#### ■ Mini-WECO Video Plugs

Model	Suitable Cable	Boot	Die Set
<b>MVP-C25HW</b>	L-2.5CHWS	CB25	TCD-D253F
<b>MVP-C4</b>	LV-61S, RG-59B/U, Belden 8241, 8279, 88241	CB25	TCD-451CA TCD-4CA

\*Standard package: 20 pcs

#### ■ Accessories

Model	Description
<b>MVPC**</b>	Mini WECO patch cords (see page 83)
<b>MVPC**-HW</b>	Mini WECO patch cords (see page 83)
<b>BCJ-MVP</b>	BNC (female) to Mini-WECO plug conversion adapter (10 pcs)
<b>BET-BNC</b> <small>Coming Soon</small>	BNC extraction tool (see page 47)
<b>PH50A</b>	Patch cord holder for MVPC**
<b>MVJ-DC</b>	Dust cap for MDVJ (color: black 40 pcs)
<b>MJ2-M32-U-***</b>	Unloaded panels (see page 81)
<b>VJ2-M32-4U</b>	

\*BCJ-MVP is recommended to use with Slim BNC plug (see page 30).

#### ■ Return Loss & Isolation

Model	MDVJ-STW	MDVJ-ST-S	
RL	BNC-BNC: Normal Through	—	
	BNC-Video: Patch Through	26 dB or greater @ 750 MHz 20 dB or greater @ 2.4 GHz 10 dB or greater @ 3 GHz	26 dB or greater @ 750 MHz 20 dB or greater @ 2.4 GHz 10 dB or greater @ 3 GHz
	BNC-Self Termination	26 dB or greater @ 750 MHz 20 dB or greater @ 1.5 GHz 10 dB or greater @ 3 GHz	26 dB or greater @ 750 MHz 20 dB or greater @ 1.5 GHz 10 dB or greater @ 3 GHz
Isolation	35 dB or greater @ 1.5 GHz 20 dB or greater @ 3.0 GHz	35 dB or greater @ 1.5 GHz 20 dB or greater @ 3.0 GHz	

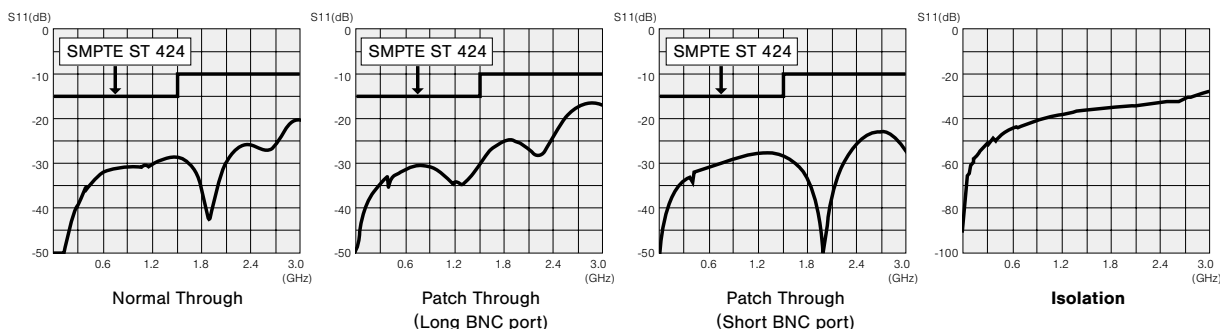

**Return loss for MDVJ-STW**

75Ω Video Patchbays

3G-ready HD-SDI video patchbays featuring Canare's uniquely-developed rotary switches.

■ Patchbays

Model	Panel Size	Loaded Video Jacks
20DV	1RU	20 × DWJB-W
24DV		24 × DWJB-W
26DV		26 × DWJB-W
20DVS	1RU	20 × DWJB-S
24DVS		24 × DWJB-S
26DVS		26 × DWJB-S
20DV-2U	2RU	20 × DWJB-W
24DV-2U		24 × DWJB-W
26DV-2U		26 × DWJB-W
20DVS-2U	2RU	20 × DWJB-S
24DVS-2U		24 × DWJB-S
26DVS-2U		26 × DWJB-S

Standard panel color: Black. Available in 9 colors. see page 80.

Key Features and Benefits

- Rotary Switch Technology with dual-contact construction.
- Can be recessed 25 mm.
- Wide designation strip (2RU type).
- Lightweight aluminum alloy video jacks.

Note: Be sure to use with WECO Video Patch Cords.



■ Dual Video Jacks

Model	Description	Rear Jacks
DVJB-W	Normal through	BNC
DVJB-S	Straight through	BNC

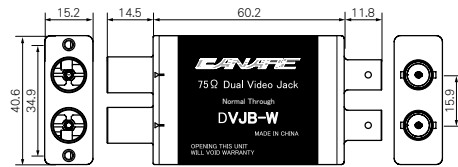

■ WECO Plugs

Model	Suitable Cable	Boot	Die Set
VWP-C25HW	L-2.5CHWS	CB04	TCD-D253F
VWP-C4A	LV-61S, RG-59B/U, Belden 8241, 8279, 88241	CB04	TCD-451CA TCD-4CA

\*Standard package: 20 pcs

■ Accessories

Model	Description
VPC**-WC	WECO patch cords (see page 83)
VPC**-HW-WC	WECO patch cords (see page 83)
BCJ-VWP	BNC (female) to WECO plug conversion adapter
BET-BNC <small>Coming Soon</small>	BNC extraction tool (see page 47)
PH50A	Patch cord holder for VPC**
VJ-DC	Duct cap for DVJB (black, 40 pcs)
VJ2-V**-*U-***	Unloaded panels (see page 81)

■ Return Loss & Isolation

Model	DVJB-W	DVJB-S	
RL	BNC-BNC: Normal Through	—	
	BNC-Video: Patch Through	26 dB or greater @ 750 MHz 20 dB or greater @ 2.4 GHz 10 dB or greater @ 3 GHz	26 dB or greater @ 750 MHz 20 dB or greater @ 2.4 GHz 10 dB or greater @ 3 GHz
	BNC-Self Termination	26 dB or greater @ 750 MHz 20 dB or greater @ 1.5 GHz 10 dB or greater @ 3 GHz	26 dB or greater @ 750 MHz 20 dB or greater @ 1.5 GHz 10 dB or greater @ 3 GHz
Isolation	35 dB or greater @ 1.5 GHz 20 dB or greater @ 3.0 GHz	35 dB or greater @ 1.5 GHz 20 dB or greater @ 3.0 GHz	

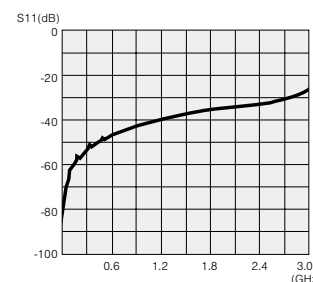
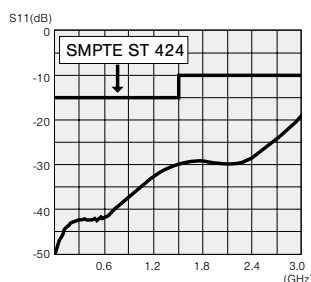
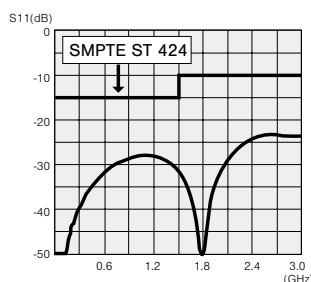

Return loss for DVJB-W

Technical Trend

Fiber-Optic Systems

Connectors

Cables

Panels & Patchbays

Multichannel Systems

Cable Assemblies

# Panels and Patchbays

## 75Ω Video Patchbays

### Ordering Information

#### Mid-Size 3G/12G Video Patchbays

32 MD - ST S - 8 - 2U

Jack Type

<b>MCK</b>	12G Dual
<b>SVK</b>	12G Single
<b>MD</b>	3G Dual

Signal Path

<b>Blank</b>	Normal through
<b>S</b>	Straight through

\* MCK and MD only.

Panel Color

<b>Blank</b>	<b>Black</b>
<b>1</b>	<b>Brown</b>
<b>2</b>	<b>Red</b>
<b>3</b>	<b>Orange</b>
<b>4</b>	<b>Yellow</b>
<b>5</b>	<b>Green</b>
<b>6</b>	<b>Blue</b>
<b>7</b>	<b>Purple</b>
<b>8</b>	<b>Gray</b>
<b>9</b>	<b>White</b>

\* for 4RU, black only.

Rack Unit

<b>Blank</b>	1RU
<b>1.5U</b>	1.5RU *
<b>2U</b>	2RU **
<b>4U</b>	4RU **

\* 1.5RU and 2RU are available for SVK and MD.  
\*\* for 4RU, MD only.

32MD-ST

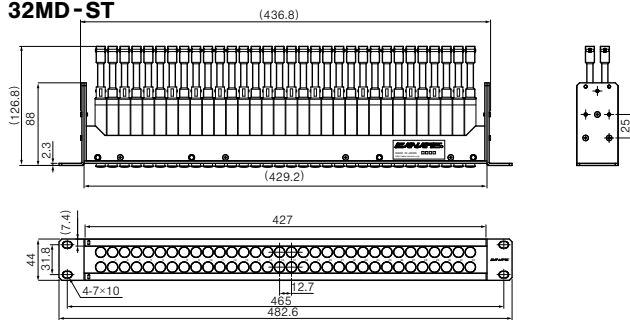

32SVK-ST-1.5U

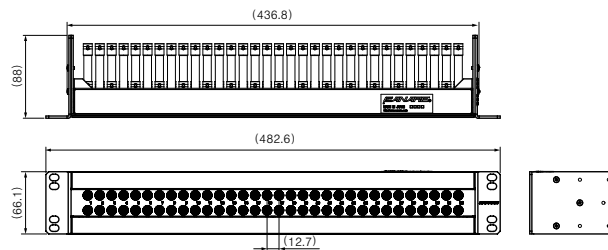

32MD-ST-2U

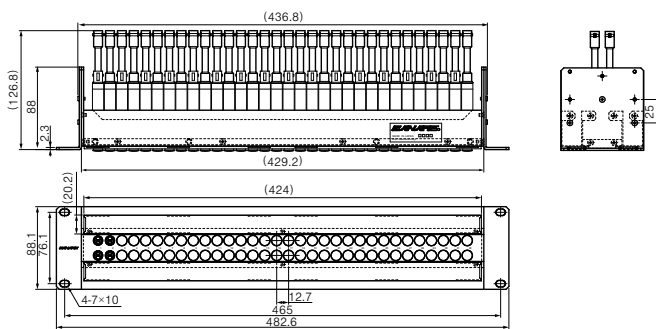

32MD-ST-4U

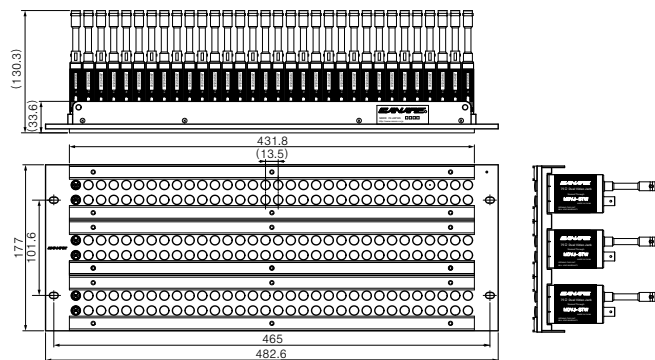



Ordering Information

WECO Video Patchbays

**24 DV S - 8 - 2U**

Number of Channels

20	20 Channels
24	24 Channels
26	26 Channels

Signal Path

Blank	Normal through
S	Straight through

Panel Color

Blank	Black
1	Brown
2	Red
3	Orange
4	Yellow
5	Green
6	Blue
7	Purple
8	Gray
9	White

Rack Unit

Blank	1RU
2U	2RU

20DV

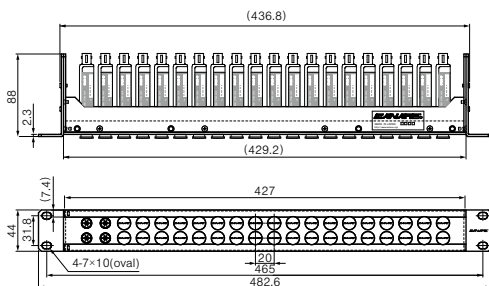

24DV

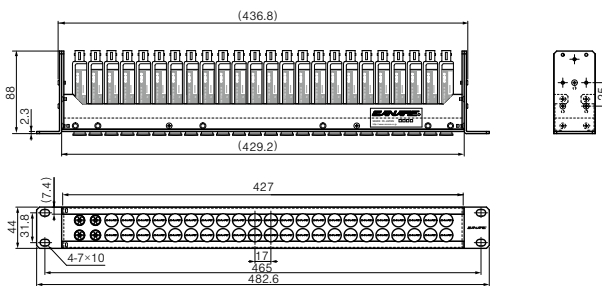

26DV-2U

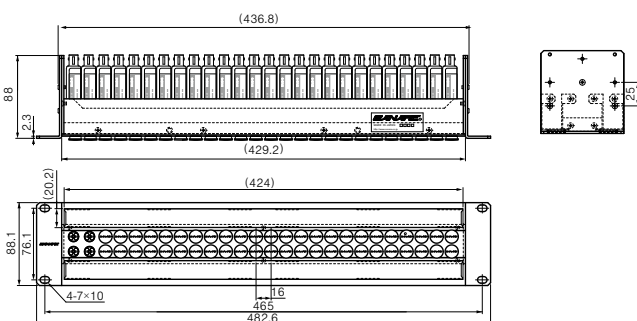

Designation Strip Dimensions

- 1RU : 426 mm × 6.2 mm
- 1.5RU: 426.5 mm × 16.7 mm
- 2RU : 420 mm × 18.4 mm
- 4RU : 431.8 mm × 13.2 mm

Note:

- 1) 4RU type is available in black color only.
- 2) 4RU type can not be recessed.

Technical Trend  
Fiber-Optic Systems  
Connectors  
Cables  
Panels & Patchbays  
Multichannel Systems  
Cable Assemblies

# Panels and Patchbays

## Unloaded Video Jack Panels

### Unloaded Video Jack Panels

Model	Panel Size	Description
VJ2-V20-1U-***	1RU	20 ch (40 holes), for DVJB
VJ2-V20-2U-***	2RU	20 ch (40 holes), for DVJB
VJ2-V24-1U-***	1RU	24 ch (48 holes), for DVJB
VJ2-V24-2U-***	2RU	24 ch (48 holes), for DVJB
VJ2-V26-1U-***	1RU	26 ch (52 holes), for DVJB
VJ2-V26-2U-***	2RU	26 ch (52 holes), for DVJB
MJ2-M32-1U-***	1RU	32 ch (64 holes), for MDVJ and SVJK
MJ2-M32-1.5U-*** <span style="color: red; font-weight: bold;">New</span>	1.5RU	32 ch (64 holes), for MDVJ and SVJK
MJ2-M32-2U-***	2RU	32 ch (64 holes), for MDVJ and SVJK
VJ2-M32-4U	4RU	96 ch (3 × 32 ch, 192 holes), for MDVJ, Black
MJ2-M32CK-1U-***	1RU	32 ch (32 slots), for MCVJK

\*\*\*: Please refer to the ordering information below.

#### <Ordering Information>

##### Mid-Size 3G/12G Video Patchbays

\* for 4RU, one model only: VJ2-M32-4U

**MJ2 - M32** CK - **1U** - BLK

Jack Type: Blank SVJK, MDVJ; CK MCVJK

Rack Unit: Blank 1RU; 1.5U 1.5RU \*\*; 2U 2RU \*\*

\*\* for SVJK and MDVJ only.

BLK	Black
BRN	Brown
RED	Red
ORG	Orange
YEL	Yellow
GRN	Green
BLU	Blue
PPL	Purple
GRY	Gray
WHT	White

##### WECO Video Patchbays

**VJ2 - V** 24 - **1U** - BLK

Channels: 20 20 Channels; 24 24 Channels; 26 26 Channels

Rack Unit: 1U 1RU; 2U 2RU

BLK	Black
BRN	Brown
RED	Red
ORG	Orange
YEL	Yellow
GRN	Green
BLU	Blue
PPL	Purple
GRY	Gray
WHT	White

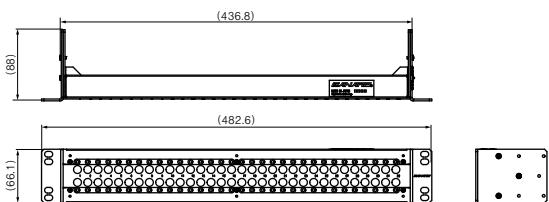

MJ2-M32-1.5U-BLK

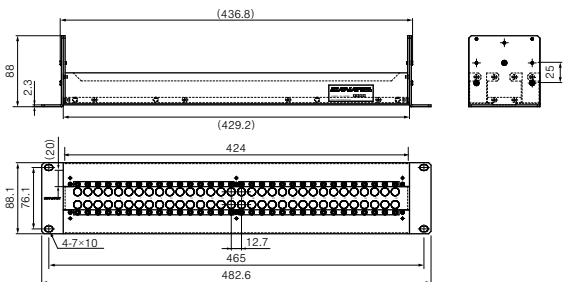

MJ2-M32-2U-BLK

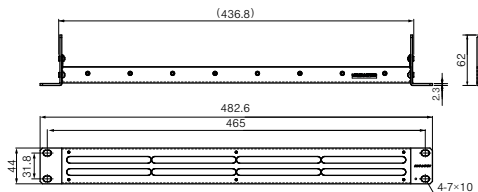

MJ2-M32CK-1U-BLK

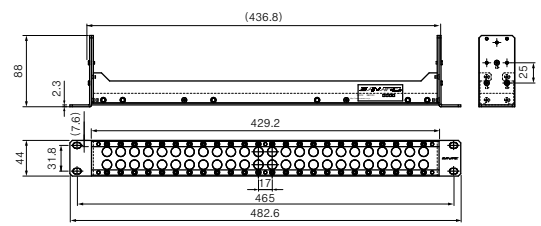

VJ2-V24-1U-BLK

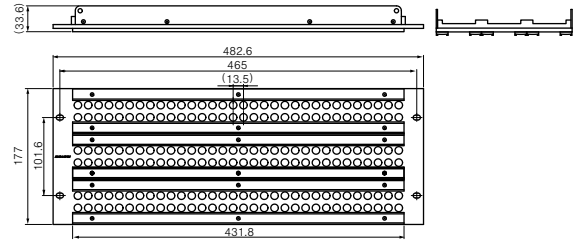

VJ2-M32-4U

#### Designation Strip Dimensions

- 1RU : 426 mm × 6.2 mm
- 1.5RU: 426.5 mm × 16.7 mm
- 2RU : 420 mm × 18.4 mm
- 4RU : 431.8 mm × 13.2 mm

#### Note:

- 1) 4RU type is available in black color only.
- 2) 4RU type can not be recessed.

RS422 Patchbays

Model	Panel Size	Connectors	
		Front Panel	Rear Panel
RS-422-1U-16	1RU	Bantam	D sub 9P(F) × 16
RS-422-1U-24	1RU	Bantam	D sub 9P(F) × 24
RS-422-2U-32	2RU	Bantam	D sub 9P(F) × 32
RS-422-2U-48	2RU	Bantam	D sub 9P(F) × 48

- The RS422 serial signal used for VTR remote applications can now be switched with Bantam patchbay ease.
- D sub screws are M2.6

\* Listed above items are other manufacturer's products.



RS-422-2U-48

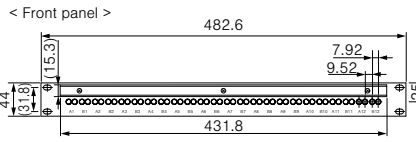
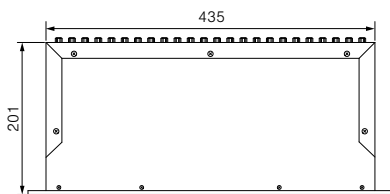
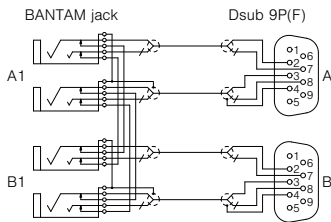

RS-422-1U-24

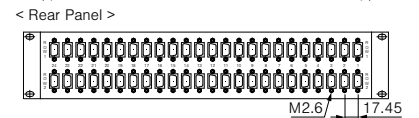
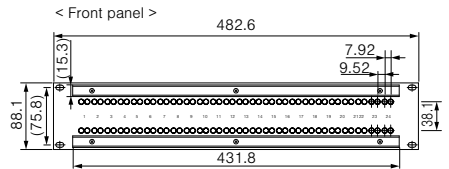

RS-422-2U-48

Technical Trend

Fiber-Optic Systems

Connectors

Cables

Panels & Patchbays

Multichannel Systems

Cable Assemblies

# Panels and Patchbays

## Video Patch Cords

### Video Patch Cords

#### Canare Micro

For 32MCK-ST or 48MC

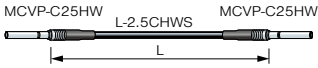
Type	Model	Length (m)
 MCVP-C25HW L-2.5CHWS MCVP-C25HW L	MCVPC003	0.3
	MCVPC005	0.5
	MCVPC01	1

BLK BRN RED YEL GRN BLU PPL

Canare Micro



#### Canare Single

For 32SVK

Type	Model	Length (m)
 SVP-C25HW L-2.5CHWS SVP-C25HW L	SVPC003	0.3
	SVPC005	0.5
	SVPC01	1

BLK BRN RED YEL GRN BLU PPL

Canare Single



#### Mini-WECO

For 32MD-ST and Mini-WECO patchbays

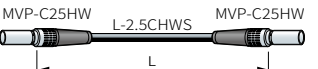
Type	Model	Length (m)
 MVP-C4 LV-61S MVP-C4 L	MVPC003	0.3
	MVPC005	0.5
	MVPC01	1
 MVP-C25HW L-2.5CHWS MVP-C25HW L	MVPC003-HW <b>New</b>	0.3
	MVPC005-HW <b>New</b>	0.5
	MVPC01-HW <b>New</b>	1

BLK RED YEL GRN BLU



BLK BRN RED YEL GRN BLU PPL

Mini-WECO



#### WECO

For 2\*DV and WECO patchbays

Type	Model	Length (m)
 VWP-C4A LV-61S VWP-C4A L	VPC003-WC	0.3
	VPC005-WC	0.5
	VPC01-WC	1
 VWP-C25HW L-2.5CHWS VWP-C25HW L	VPC003-HW-WC <b>New</b>	0.3
	VPC005-HW-WC <b>New</b>	0.5
	VPC01-HW-WC <b>New</b>	1

BLK BRN RED ORN YEL GRN BLU PPL GRY WHI

BLK BRN RED YEL GRN BLU PPL

WECO



#### Canare Micro Conversion

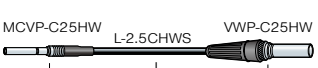
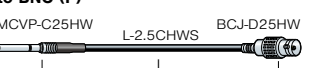

Type	Model	Length (m)
<b>to Mini-WECO</b>  MCVP-C25HW L-2.5CHWS MVP-C25HW L	MCVPC003-MVP	0.3
	MCVPC005-MVP	0.5
	MCVPC01-MVP	1
<b>to WECO</b>  MCVP-C25HW L-2.5CHWS VWP-C25HW L	MCVPC003-VWP	0.3
	MCVPC005-VWP	0.5
	MCVPC01-VWP	1
<b>to BNC (F)</b>  MCVP-C25HW L-2.5CHWS BCJ-D25HW L	MCVPC002-BJ	0.2

BLK BRN RED YEL GRN BLU PPL

BLK BRN RED YEL GRN BLU PPL

BLK BRN RED YEL GRN BLU PPL

#### Mini-WECO Conversion

Type	Model	Length (m)
<b>to BNC (F)</b>  MVP-C4 LV-61S BCJ-C4 L	MVPC002-BJ	0.2
<b>to BNC (M)</b>  MVP-C4 LV-61S BCP-A4 L	MVPC02A-BP	2
	MVPC05A-BP	5

BLK RED YEL GRN BLU

BLK RED YEL GRN BLU

**Pre-Loaded A/V Connector Panels**

**Key Features and Benefits**

- BNC and XLR types are available.
- Clear plastic cover, full screen desi-strip
- Variety of panel options
- Most popular panel holes XLR F77 and Neutrik D available

**XLR Connector Panels**

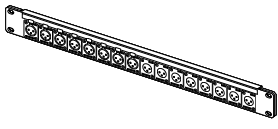
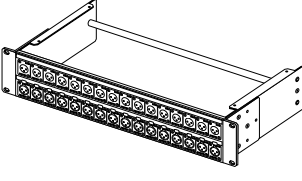
Type	Panel Size	Model	Loaded Connector	Panel P/N	Dimensions (mm)
 <p>161U-X12F</p>	1RU	<b>161U-X1F</b>	XLR3-31-F77 (16 pcs)	1U-AS1	44 × 482.6 × 39.7
		<b>161U-X2F</b>	XLR3-32-F77 (16 pcs)		44 × 482.6 × 26.6
		<b>161U-X12F</b>	XLR3-31-F77 (8 pcs, Left) XLR3-32-F77 (8 pcs, Right)		44 × 482.6 × 39.7
		<b>161U-B1</b>	NC3FD-LX-B (16 pcs)	1U-AS1D	44 × 482.6 × 31.3
		<b>161U-B2</b>	NC3MD-LX-B (16 pcs)		44 × 482.6 × 23.6
 <p>162U-X21</p>	2RU	<b>162U-X21</b>	XJ3M-P3FA (16 pcs, Upper Row) XJ3F-P3MA (16 pcs, Lower Row)	2U-AS7	88.1 × 482.6 × 217
		<b>162U-X22</b>	XJ3M-P3FA (32 pcs, 2 rows)		

**BNC Connector Panels**

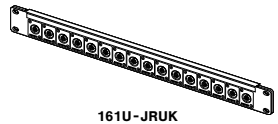
Type	Panel Size	Model	Loaded Connector	Panel P/N	Dimensions (mm)
 <p>161U-JRUK</p>	1RU	<b>161U-JRUK</b>	BCJ-JRUK (16 pcs)	1U-AS1	44 × 482.6 × 31.4
		<b>161U-JRUDB</b>	BCJ-JRUDB (16 pcs)	1U-AS1D	44 × 482.6 × 29.1
	2RU	<b>162U-JRUK</b>	BCJ-JRUK (32 pcs, 2 rows)	2U-AS7	88.1 × 482.6 × 217

**XLR3 Panel Mount Adapters**

Model	Description		Flange Type
	Front	Rear	
<b>XJ3M-P3FA</b>	XLR 3pin (M)	XLR 3pin (F)	ITT XLR-F77
<b>XJ3M-P3MA</b>	XLR 3pin (M)	XLR 3pin (M)	
<b>XJ3F-P3FA</b>	XLR 3pin (F)	XLR 3pin (F)	
<b>XJ3F-P3MA</b>	XLR 3pin (F)	XLR 3pin (M)	

- XJ3 series are XLR3 full compatible.
- XLR jack to jack extremely reduce installation hours.

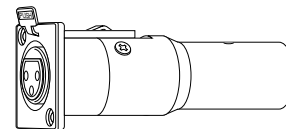

**XJ3F-P3MA**

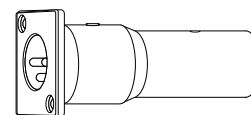

**XJ3M-P3MA**

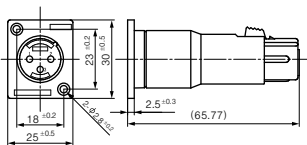

**XJ3M-P3FA**

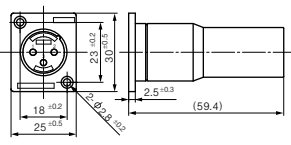

**XJ3M-P3MA**

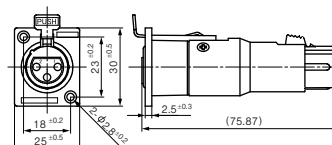

**XJ3F-P3FA**

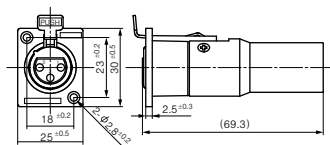

**XJ3F-P3MA**

**Blank Panels**

Model	Description
<b>BP-DXF (20 pcs)</b>	Snap-on blank panels for both ITT XLR-F77/Neutrik D holes
<b>BP-XF (10 pcs)</b>	Blank panels for ITT XLR-F77 hole with screws
<b>BP-D (10 pcs)</b>	Blank panels for Neutrik D hole with screws

**BP-DXF**

- Easy and quick snap-on mounting without any tools
- Can be used for both ITT XLR-F77 and Neutrik D holes

**Note:** Panel thickness range: t 1.2 to t 2.3 mm



**BP-DXF**

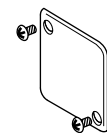

**BP-XF**

# Panels and Patchbays

## Connector Panels

### Unloaded A/V Connector Panels

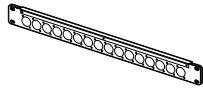
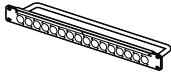
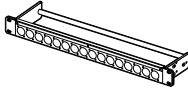
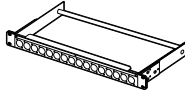
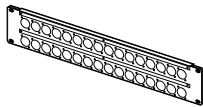
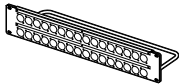
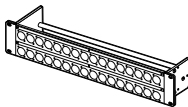
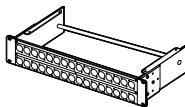
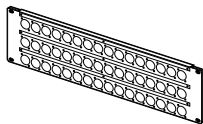
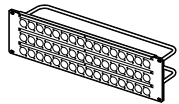
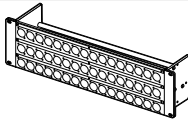
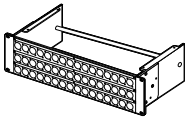
Panel Type	AS1 (D)	AS3 (D)	AS5 (D)	AS7 (D)
Description	Flat panel	Flat panel w/cable tie bar	Variable panel w/cable tie bar short type	Variable panel w/cable tie bar Long type
1RU 16 holes × 1 row				
Model	1U-AS1 (D)	1U-AS3 (D)	1U-AS5 (D)	1U-AS7 (D)
Depth (mm)	—	64.8	100	217
2RU 16 holes × 2 rows				
Model	2U-AS1 (D)	2U-AS3 (D)	2U-AS5 (D)	2U-AS7 (D)
Depth (mm)	—	64.8	100	217
3RU 16 holes × 3 rows				
Model	3U-AS1 (D)	3U-AS3 (D)	3U-AS5 (D)	3U-AS7 (D)
Depth (mm)	—	64.8	100	217

Variable panel can be recessed 25 mm.

### Ordering Information

Panel Height,

Number of holes and Rows

1U	1RU, 16 holes, 1row
2U	2RU, 32 holes, 2rows
3U	3RU, 48 holes, 3rows

1U - AS3 D — Hole Type

Blank ITT XLR-F77 Type

D Neutrik D Type

Panel Type

AS1	Flat panel
AS3	Flat panel w/cable tie bar
AS5	Variable panel w/ cable tie bar - short depth
AS7	Variable panel w/ cable tie bar - long depth

**Note:** Depending on their length, some connectors can not be mounted on the panel with a cable tie bar installed.

### Related Products

Model	Description
M-MA1U02	1RU mounting brackets for a Variable panel, 2 pcs. (left and right)
M-MA2U02	2RU mounting brackets for a Variable panel, 2 pcs. (left and right)
M-MA3U02	3RU mounting brackets for a Variable panel, 2 pcs. (left and right)
DS10-AS4	Designation strip for Canare A/V connector panels, 2 pcs.

### Examples of Custom-Made Connector Panels

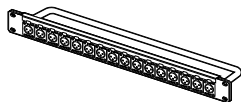

1U-AS3 + XLR3-31-F77 × 16

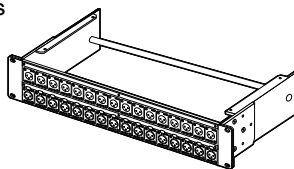

2U-AS7 + XLR3-32-F77 × 16  
XLR3-31-F77 × 16

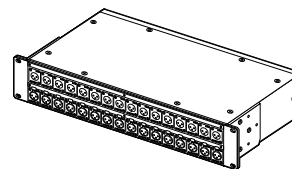

2U-AS7 (box type)  
Connectors can be mounted on the both side.

**Connectors** Canare Flush-mount BNC, F, RCA and XLR (ITT XLR-F77 or Neutrik D type) are available.

### Options

- A) Rear Panel A connector panel can be mounted on the rear.
- B) Box Type A connector panel, top plate and bottom plate can be mounted on the rear.
- C) Recessed Variable panel can be recessed 25 mm by changing the screw positions of the mounting brackets and can be recessed either 50 mm or 75 mm by changing the mounting brackets to M-MA\*U02.

Options	AS1 (D)	AS3 (D)	AS5 (D)	AS7 (D)
A) Rear Panel	N/A	N/A	Available	Available
B) Box Type	N/A	N/A	N/A	Available
C) Recessed	N/A	N/A	Available	Available

Audio Patchbays

The gold alloy cross bar contact, which features a low faulty contact rate, is used for the jacks.

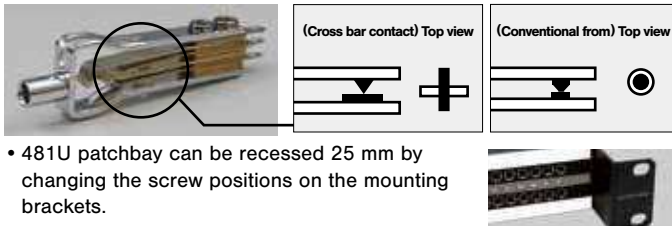

- 481U patchbay can be recessed 25 mm by changing the screw positions on the mounting brackets.

Model	Description	Connector
481U - 820AQ	Bantam Patchbay	820AQ × 96

Model	Description	Connector
48 - 12A/820AQ/EIA	Bantam Patchbay	820AQ × 96
32 - 12A/620A/EIA	Skini Patchbay	620A × 64
612A/320A/EIA	Maxi Patchbay	320A × 52

\* Listed above items are other manufacturer's products.



Bantam patch panel 481U-820AQ



Bantam patch panel 48-12A/820AQ/EIA



BC \* M

(See page 98 for patch cords.)

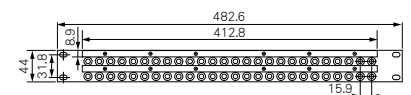
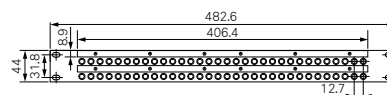
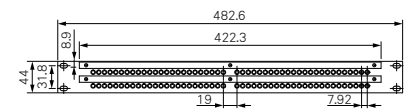
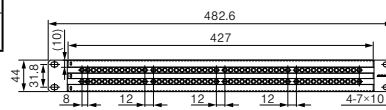

Audio Patchbays Related Products

Model	Description
320A	Maxi Jack
620A	Skini Jack
820AQ	Bantam Jack
ABJ-DC	Bantam Jack Dust Cap (100 pcs/pkg)
NP3TMC-B	Maxi/Skini Plug
PH50A	Maxi/Skini/Video Patch Cord Holder
PH50B	Bantam Patch Cord Holder
DS10-AS1	Designation Strip for Bantam (2 pcs.)
DS10-AS2	Designation Strip for Skini (2 pcs.)
DS10-AS3	Designation Strip for Maxi (2 pcs.)

\* Listed above items are other manufacturer's products.

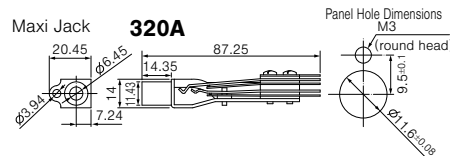
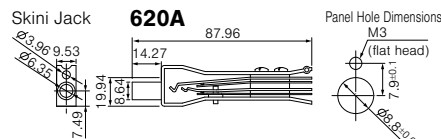
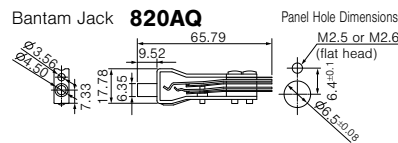

Patch Cord Holder

Capable up to 50 patch cords. Easy to install on the wall or side of rack. PH50A for Maxi/Skini, Video cords. PH50B for Bantam cords.

Technical Note

Audio Patchbay Normalling Descriptions

Output from a device is obtained from the upper row, while input to a device is normally connected to the lower row.

Users can select from the following three types of connecting functions.

<Wiring formats connecting upper and lower connectors>

F: Full normal connection

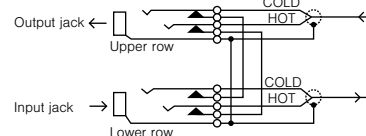

Full Normal Format (series)

The upper (output) row is connected to the lower row (input) in the state when a plug is not inserted. When a plug is inserted in the upper jack to obtain a signal, the signal is not connected to the lower jack. A signal can be entered by inserting a plug in the lower jack. In this case the signal is not connected to the upper jack.

H: Half normal connection

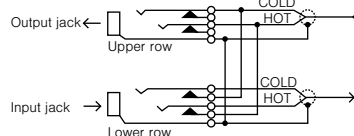

Half Normal Format (half-parallel)

The upper (output) row is connected to the lower row (input) in the state when a plug is not inserted. When a plug is inserted in the upper jack to obtain a signal, the signal is connected to the lower jack. This format allows the signal to be obtained in parallel. The signal can be prevented from going to the lower jack by inserting a dummy plug. Signals are input by inserting a plug in the lower jack. In this case the signal is not connected to the upper jack.

W: Double normal connection

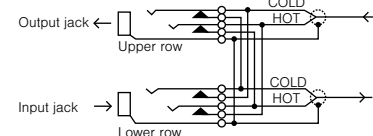

Double Normal Format (series-parallel)

The upper (output) row is connected to the lower row (input) in the state when a plug is not inserted. When a plug is inserted in the upper jack to obtain a signal, the signal is connected to the lower jack. This format allows the signal to be obtained in parallel. The signal can be prevented from going to the lower jack by inserting a dummy plug. A signal can be entered by inserting another plug in the lower jack. Note that the signal in this case is connected to the upper jack. This can be prevented by inserting a dummy plug.

# Panels and Patchbays

## Audio Patchbays

### Wired Box

Type	Model	Size	Connector	
			Front	Rear
Bantam	481U-WBF	1RU	820AQ × 96	90-602 × 4
	481U-WBH	1RU	820AQ × 96	90-602 × 4
	481U-WBW	1RU	820AQ × 96	90-602 × 4
	481U-WBS	1RU	820AQ × 96	90-602 × 4
	48WB-F	1RU	820AQ × 96	90-602 × 4
	48WB-H	1RU	820AQ × 96	90-602 × 4
	48WB-W	1RU	820AQ × 96	90-602 × 4
Skini	32WB-F	1RU	620A × 64	90-602 × 4
	32WB-H	1RU	620A × 64	90-602 × 4
	32WB-W	1RU	620A × 64	90-602 × 4
Maxi	26WB-F	1RU	320A × 52	90-602 × 4
	26WB-H	1RU	320A × 52	90-602 × 4
	26WB-W	1RU	320A × 52	90-602 × 4

\*481U-WB\* can be recessed 25 mm  
 \*90-602 connector is identical to  
 ELCO 00-8016-090-\*\*\*-702V connector

90-602



Bantam wired box **481U-WB\***



Bantam wired box **48WB-\***



Maxi wired box **26WB-\***



Skini wired panel **32XP-\***

### Wired Panels

Type	Model	Panel 1		Panel 2	
		Size	Connector	Size	Connector
Bantam	48XP-F	1RU	820AQ × 96	3RU × 2	XLR3-31-F77 × 48 XLR3-32-F77 × 48
	48XP-H	1RU	820AQ × 96	3RU × 2	XLR3-31-F77 × 48 XLR3-32-F77 × 48
	48XP-W	1RU	820AQ × 96	3RU × 2	XLR3-31-F77 × 48 XLR3-32-F77 × 48
Skini	32XP-F	1RU	620A × 64	4RU	XLR3-31-F77 × 32 XLR3-32-F77 × 32
	32XP-H	1RU	620A × 64	4RU	XLR3-31-F77 × 32 XLR3-32-F77 × 32
	32XP-W	1RU	620A × 64	4RU	XLR3-31-F77 × 32 XLR3-32-F77 × 32

\*Cables are 2 meters in length.

#### Normaling Options

481U-WB\* — F: Full normal  
 48WB-\* — H: Half normal  
 48XP-\* — W: Double normal  
 — S: Single (No normal)



**TC\*\*B**

(See page 98 or patch cords)

### 90-602 Connector Format (Wired box)

<Rear panel>

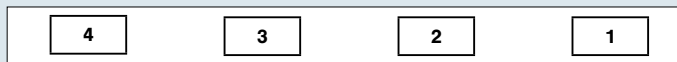

Bantam Lower row 25~48 ch Upper row 25~48 ch Lower row 1~24 ch Upper row 1~24 ch  
 Skini Lower row 17~32 ch Upper row 17~32 ch Lower row 1~16 ch Upper row 1~16 ch  
 Maxi Lower row 14~26 ch Upper row 14~26 ch Lower row 1~13 ch Upper row 1~13 ch

90-602 connector is mated with 90-608 connector.  
 90-608 requires either 125 or 525 contact and 90-T cover for assembling.

<Wired box side>

<Cable side>

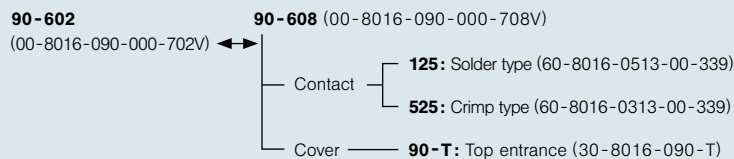

\*The numbers in parentheses are ELCO ordering codes.  
 \*\* Contact extraction tool: 06-1877-04.  
 Crimping pliers for 525: 06-1001-015 (AWG #18), 06-1001-016 (AWG #20-#22), 06-1001-017 (AWG #24-#26).

### Wiring Table for 90-602

	Maxi		Skini		Bantam		HOT	COLD	SHIELD
1	14	1	17	1	25	A	H	R	
2	15	2	18	2	26	B	J	S	
3	16	3	19	3	27	C	K	T	
4	17	4	20	4	28	D	L	U	
5	18	5	21	5	29	E	M	V	
6	19	6	22	6	30	F	N	W	
7	20	7	23	7	31	X	AE	AM	
8	21	8	24	8	32	Y	AF	AN	
9	22	9	25	9	33	Z	AH	AP	
10	23	10	26	10	34	AA	AJ	AR	
11	24	11	27	11	35	AB	AK	AS	
12	25	12	28	12	36	AC	AL	AT	
13	26	13	29	13	37	BJ	BS	BY	
			14	30	14	38	BK	BT	BZ
			15	31	15	39	BL	BU	CA
			16	32	16	40	BM	BV	CB
					17	41	BN	BW	CC
					18	42	BP	BX	CD
					19	43	CF	CN	CW
					20	44	CH	CP	CX
					21	45	CJ	CR	CY
					22	46	CK	CS	CZ
					23	47	CL	CT	DA
					24	48	CM	CU	DB



### Snake Trunk



### Junction Box



### Fantail



### Cable Reel Snake



### System Example

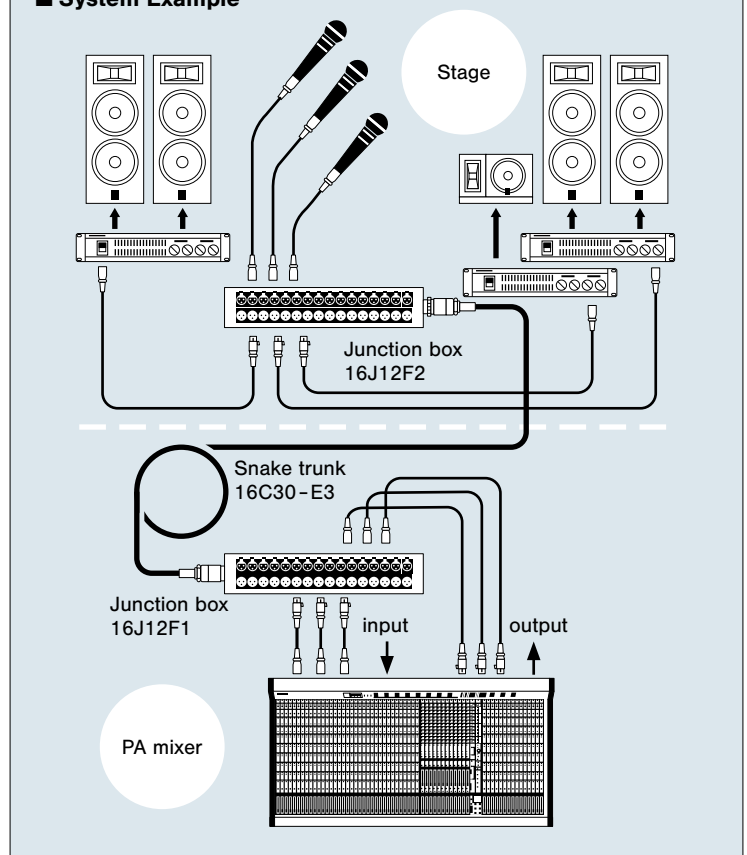

### Connectors used with Canare multichannel cable system

Cable mount	Panel mount	Cable mount	Panel mount
XLR3-11C (female)	XLR3-32-F77 (male)	XLR3-12C (male)	XLR3-31-F77 (female)
For multichannel cable Plug	For Junction box Receptacle	For multichannel cable Plug	For Junction box Receptacle
NK27-21C-R (female) + NK-AD1-R (barrel extension)	NK27-32S-R (male)	FK37-21C-R (female) + FK-AD2-R (barrel extension)	FK37-32S-R (male)
NK27-22C-R (male) + NK-AD1-R (barrel extension)	NK27-31S-R (female)	FK37-22C-R (male) + FK-AD2-R (barrel extension)	FK37-31S-R (female)
D/MS3106B32A-10S (female) + EB-02 (barrel extension) + D/MS3057-20A (cable clamp)	D/MS3102A32A-10P (male)	D/MS3106B36-73S (female) + EB-03 (barrel extension) + D/MS3057-24A (cable clamp)	D/MS3102A36-73P (male)

# Multichannel Systems

## Snake Trunks, Cable Reel Snakes

### Snake Trunks

### Cable Reel Snakes

8 CH

**L-4E3**

Star quad, Braided shield



Connector: NK27-21C 3/4-R, NK27-22C 3/4-R  
Cable: L-4E3-8P (black)  
Rubber bushing: AN3420-12 + Heat Shrink Tube

Model	Length	Weight
<b>8C05-E3</b>	5m	1.6kg
<b>8C10-E3</b>	10m	3.0kg
<b>8C30-E3</b>	30m	8.4kg
<b>8C50-E3</b>	50m	13.8kg

**M2**

Two-cord, AT shield



Connector: NK27-21C 3/4-R, NK27-22C 3/4-R  
Cable: M202-8AT (black)  
Rubber bushing: AN3420-10, 12 + Heat Shrink Tube

Model	Length	Weight
<b>8C10-M2</b>	10m	1.7kg
<b>8C30-M2</b>	30m	4.5kg
<b>8C50-M2</b>	50m	7.3kg

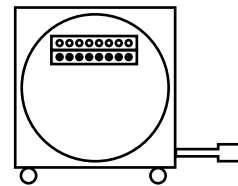

Connector: NK27-21C-3/4-R  
Cable: L-4E3-8P (black)

Model	Length	Weight	Cable reel
<b>8R30-E3</b>	30m	18.1kg	R380
<b>8R50-E3</b>	50m	23.0kg	R380

12 CH



Connector: NK27-21C 7/8-R, NK27-22C 7/8-R  
Cable: L-4E3-12P (black)  
Rubber bushing: AN3420-16

Model	Length	Weight
<b>12C05-E3</b>	5m	2.1kg
<b>12C10-E3</b>	10m	3.9kg
<b>12C30-E3</b>	30m	11.1kg
<b>12C50-E3</b>	50m	18.3kg



Connector: NK27-21C 3/4-R, NK27-22C 3/4-R  
Cable: M202-12AT (black)  
Rubber bushing: AN3420-10, 12 + Heat Shrink Tube

Model	Length	Weight
<b>12C10-M2</b>	10m	2.1kg
<b>12C30-M2</b>	30m	5.8kg
<b>12C50-M2</b>	50m	9.3kg

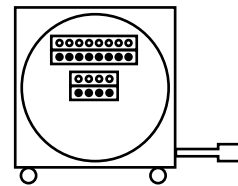

Connector: NK27-21C-7/8-R  
Cable: L-4E3-12P (black)

Model	Length	Weight	Cable reel
<b>12R30-E3</b>	30m	20.6kg	R380
<b>12R50-E3</b>	50m	30.4kg	R460

16 CH



Connector: FK37-21C 7/8-R, FK37-22C 7/8-R  
Cable: L-4E3-16P (black)  
Rubber bushing: AN3420-16

Model	Length	Weight
<b>16C05-E3</b>	5m	2.6kg
<b>16C10-E3</b>	10m	4.9kg
<b>16C30-E3</b>	30m	14.1kg
<b>16C50-E3</b>	50m	23.3kg



Connector: FK37-21C 7/8-R, FK37-22C 7/8-R  
Cable: M202-16AT (black)  
Rubber bushing: AN3420-10, 12, 16

Model	Length	Weight
<b>16C10-M2</b>	10m	2.7kg
<b>16C30-M2</b>	30m	7.5kg
<b>16C50-M2</b>	50m	12.3kg

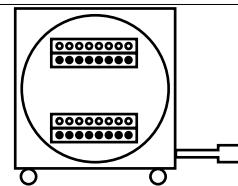

Connector: FK37-21C-7/8-R  
Cable: L-4E3-16P (black)

Model	Length	Weight	Cable reel
<b>16R30-E3</b>	30m	24.1kg	R380
<b>16R50-E3</b>	50m	36.1kg	R460

24 CH



Connector: <D/MS3106B32A-10S+D/MS3057-20A> x 2  
Cable: L-4E3-24P (black)  
Rubber bushing: AN3420-20

Model	Length	Weight
<b>24C05-E3</b>	5m	4.3kg
<b>24C10-E3</b>	10m	7.7kg
<b>24C30-E3</b>	30m	21.7kg
<b>24C50-E3</b>	50m	35.7kg

Extension Cord <D/MS3101A32A-10P+D/MS3057-20A> x 2  
Cable: L-4E3-24P (black)

Model	24C005-E3MS22
-------	---------------



Connector: <D/MS3106B32A-10S+D/MS3057-20A> x 2  
Cable: M202-24AT (black)  
Rubber bushing: AN3420-16, 20 + Heat Shrink Tube

Model	Length	Weight
<b>24C10-M2</b>	10m	4.0kg
<b>24C30-M2</b>	30m	10.4kg
<b>24C50-M2</b>	50m	16.8kg

Extension Cord <D/MS3101A36-73P+D/MS3057-24A> x 2  
Cable: M202-32AT (black)

Model	32C005-M2MS22
-------	---------------

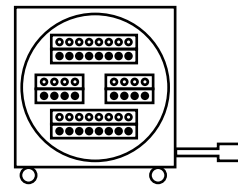

Connector: D/MS3106B32A-10S  
Cable: L-4E3-24P (black)

Model	Length	Weight	Cable reel
<b>24R30-E3</b>	30m	34.6kg	R460

32 CH











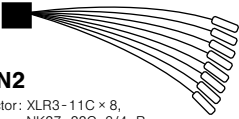
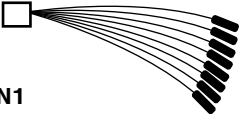
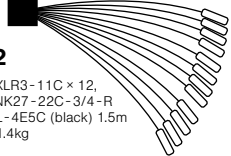
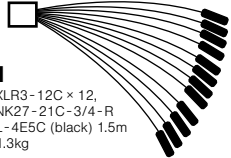

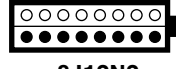
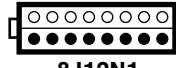
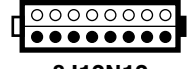
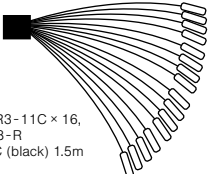
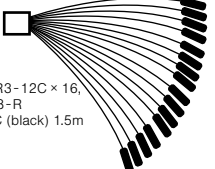
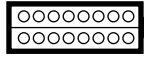

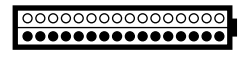
Connector: <D/MS3106B36-73S+D/MS3057-24A> x 2  
Cable: M202-32AT (black)  
Rubber bushing: AN3420-16, 20, 24

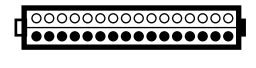
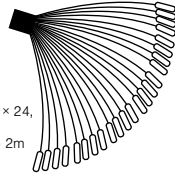
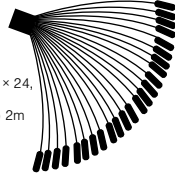
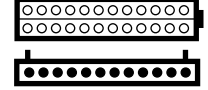
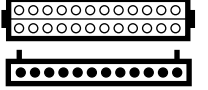
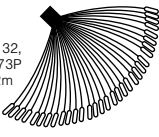
Model	Length	Weight
<b>32C10-M2</b>	10m	4.8kg
<b>32C30-M2</b>	30m	13.1kg
<b>32C50-M2</b>	50m	21.0kg

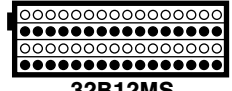
□ ○ : Female  
■ ● : Male

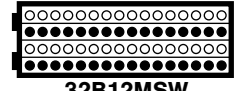
Note: Connecting cables 24C005-E3MS22 and 32C005-M2MS22 are to be used to interconnect snake trunks only and they do not mate with our other standard snake system.

Fantails	Junction Boxes		
<p><b>8S1N2</b> Connector: XLR3-11C × 8, NK27-22C-3/4-R Cable: L-4E6S (black) 1.5m Weight: 1.1kg</p>  <p><b>8S2N1</b> Connector: XLR3-12C × 8, NK27-21C-3/4-R Cable: L-4E6S (black) 1.5m Weight: 1.0kg</p> 	Single XLR per channel	Parallel XLR per channel	Parallel XLR per channel MultiPin feed through
<p><b>12S1N2</b> Connector: XLR3-11C × 12, NK27-22C-3/4-R Cable: L-4E5C (black) 1.5m Weight: 1.4kg</p>  <p><b>12S2N1</b> Connector: XLR3-12C × 12, NK27-21C-3/4-R Cable: L-4E5C (black) 1.5m Weight: 1.3kg</p> 	 <p><b>8B1N2</b> Connector: XLR3-31-F77 × 8, NK27-32S-R × 1 Weight: 0.9kg</p>  <p><b>8B2N1</b> Connector: XLR3-32-F77 × 8, NK27-31S-R × 1 Weight: 1.1kg</p>	 <p><b>8J12N2</b> Connector: XLR3-31-F77 × 8, XLR3-32-F77 × 8, NK27-32S-R × 1 Weight: 1.5kg</p>  <p><b>8J12N1</b> Connector: XLR3-31-F77 × 8, XLR3-32-F77 × 8, NK27-31S-R × 1 Weight: 1.5kg</p>	 <p><b>8J12N12</b> Connector: XLR3-31-F77 × 8, XLR3-32-F77 × 8, NK27-31S-R × 1, NK27-32S-R × 1 Weight: 1.6kg</p>
<p><b>16S1F2</b> Connector: XLR3-11C × 16, FK37-22C-7/8-R Cable: L-4E5C (black) 1.5m Weight: 1.9kg</p>  <p><b>16S2F1</b> Connector: XLR3-12C × 16, FK37-21C-7/8-R Cable: L-4E5C (black) 1.5m Weight: 1.7kg</p> 	 <p><b>16B1F2</b> Connector: XLR3-31-F77 × 16, FK37-32S-R × 1 Weight: 1.6kg</p>  <p><b>16B2F1</b> Connector: XLR3-32-F77 × 16, FK37-31S-R × 1 Weight: 1.3kg</p>	 <p><b>16J12F2</b> Connector: XLR3-31-F77 × 16, XLR3-32-F77 × 16, FK37-32S-R × 1 Weight: 2.5kg</p>  <p><b>16J12F1</b> Connector: XLR3-31-F77 × 16, XLR3-32-F77 × 16, FK37-31S-R × 1 Weight: 2.5kg</p>	 <p><b>16J12F12</b> Connector: XLR3-31-F77 × 16, XLR3-32-F77 × 16, NK27-31S-R × 1, FK37-32S-R × 1 Weight: 2.6kg</p>
<p><b>24S1MS2</b> Connector: XLR3-11C × 24, D/MS3101A32A-10P Cable: L-4E5C (black) 2m</p>  <p><b>24S2MS2</b> Connector: XLR3-12C × 24, D/MS3101A32A-10P Cable: L-4E5C (black) 2m</p> 		 <p><b>24B12MS</b> Connector: XLR3-31-F77 × 24 (on top), XLR3-32-F77 × 24 (12 on each side), D/MS3102A32A-10P Weight: 2.7kg</p>	 <p><b>24B12MSW</b> Connector: XLR3-31-F77 × 24 (on top), XLR3-32-F77 × 24 (12 on each side), D/MS3102A32A-10P × 2 Weight: 3.0kg</p>
<p><b>32S1MS2</b> Connector: XLR3-11C × 32, D/MS3101A36-73P Cable: L-4E5C (black) 2m</p>  <p><b>32S2MS2</b> Connector: XLR3-12C × 32, D/MS3101A36-73P Cable: L-4E5C (black) 2m</p> 		 <p><b>32B12MS</b> Connector: XLR3-31-F77 × 32, XLR3-32-F77 × 32, D/MS3102A36-73P Weight: 5.3kg</p>  <p><b>32B12MWF1</b> Connector: XLR3-31-F77 × 32, XLR3-32-F77 × 32, D/MS3102A36-73P × 2, FK37-31S-R × 2 Weight: 6.0kg</p>	 <p><b>32B12MSW</b> Connector: XLR3-31-F77 × 32, XLR3-32-F77 × 32, D/MS3102A36-73P × 2 Weight: 5.5kg</p>  <p><b>32B12MF1</b> Connector: XLR3-31-F77 × 32, XLR3-32-F77 × 32, D/MS3102A36-73P × 1, FK37-31S-R × 2 Weight: 5.7kg</p>

Technical Trend

Fiber-Optic Systems

Connectors

Cables

Panels & Patchbays

Multichannel Systems

Cable Assemblies

# Multichannel Systems

## Pin Assignments, Reels

### Multichannel Connector Pin Assignments

Ch No.	Cable Unit Identification		32ch		24ch		16ch		8ch / 12ch		
	L-4E3	M202	D/MS3102A36-73 D/MS3106B36-73		D/MS3102A32A-10 D/MS3106B32A-10		FK37		NK27		
	Spiral Marker Color	Insulator Color Identifying Color Common Identifying Color	HOT	COLD	HOT	COLD	HOT	COLD	HOT	COLD	
1	RED	RED • WHT	A	B	A	B	1	2	1	3	
2	BLU	BLU •	C	D	C	D	3	4	4	5	
3	YEL	YEL •	F	H	F	G	5	6	6	7	
4	GRN	GRN •	J	K	H	J	8	9	8	9	
5	BRN	BRN •	L	M	K	L	10	11	11	12	
6	N/A	GRY •	N	P	N	O	12	13	13	14	
7	BLU • BLK	BLU • BLK	R	S	P	R	14	15	15	16	
8	YEL • BLK	YEL •	T	U	S	T	16	17	17	18	
9	GRN • BLK	GRN •	V	W	U	V	21	22	19	20	
10	BRN • BLK	BRN •	Y	Z	X	Y	23	24	22	23	
11	BLK	GRY •	a	b	Z	a	25	26	24	25	
12	BLU • ORN	BLU • ORN	c	d	b	c	27	28	26	27	
13	YEL • ORN	YEL •	f	g	d	e	29	30	SHIELD		
14	GRN • ORN	GRN •	h	i	g	h	32	33	10		
15	BRN • ORN	BRN •	j	k	j	k	34	35			
16	ORN	GRY •	m	n	m	n	36	37			
17	BLU • PNK	BLU • PNK	u	v	p	q	SHIELD				
18	YEL • PNK	YEL •	w	x	s	t	19				
19	GRN • PNK	GRN •	y	z	u	v					
20	BRN • PNK	BRN •	AA	AB	w	x					
21	PNK	GRY •	AC	AD	AB	z					
22	BLU • WHT	BLU • RED	AE	AF	AA	AC					
23	YEL • WHT	YEL •	AH	AJ	AD	AF					
24	GRN • WHT	GRN •	AL	AM	AG	AE					
25	—	BRN •	AN	AP	SHIELD						
26	—	GRY •	AR	AS	E						
27	—	YEL • BLU	AT	AU							
28	—	GRN •	AV	AW							
29	—	BRN •	AX	AY							
30	—	GRN • YEL	AZ	BA							
31	—	BRN •	BC	BD							
32	—	GRY •	BE	BF							
			SHIELD								
			E	q	t						
			X	r	AK						
			p	s	BB						

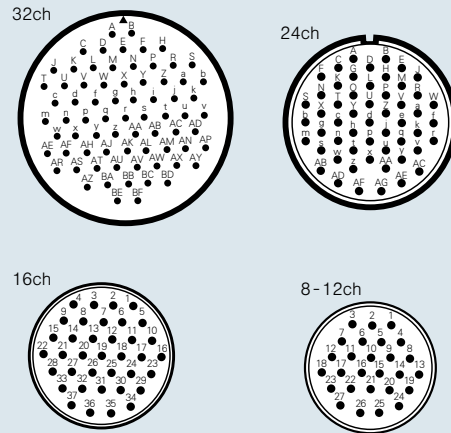

#### ■ Connection Method

##### L-4E3 Types:

Identify the channel number by the color of the spiral marker on the inner jacket (gray). The unit is 4-core construction and the insulator colors are blue, blue, white, and white. Connect these with the same colored cores, so that the blue cores are connected to Hot and the white cores to Cold.

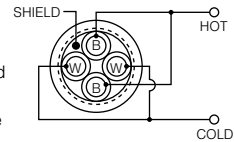

##### M202 Types:

The unit is 2-core construction, with the channel number identified by the insulator color (a combination of the identifying color and common identifying color). Connect the identifying color core to Hot, and the common identifying color core to Cold.

#### ■ Connections to XLR Connectors

Polarity	HOT	COLD	SHIELD
Pin No.	2	3	1

## Lightweight Cable Reels New

### Lightweight plastic cable reels made by Schill™

Model	Flange Dim.	Description	Weight
<b>RGT310.RM</b>	310 mm	with auxiliary reel	1.8 kg
<b>RGT380.RM</b>	380 mm		4.8 kg
<b>RGT310.MFK</b>	310 mm	with latching door	1.4 kg
<b>RGT380.MFK</b>	380 mm		4.3 kg

Color: dark blue

- Canare and Schill™ collaboration
- \*Schill™ is a trademark of Schill GmbH & Co. KG
- Easy to carry around
- High quality resin: durable, weatherproof and lightweight.
- Locking brake
- Latching door type (MFK) allows you to store cable connector inside reel.
- Canare special colored flange
- Rough estimate of maximum cable lengths (cable O.D.)
- RGT310: L-4E6S 120 m (6 mm)
- RGT380: L-5CFW 130 m (7.7 mm)
- RJC6A-4P-SFM 110m (8.6 mm)
- LF-2SM9N 100m (9.2 mm)



**RGT310.RM**



**RGT380.MFK**



**RGT380.MFK**  
door open

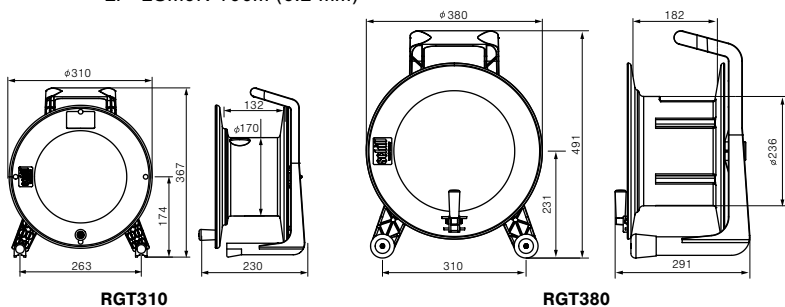

**RGT310**

**RGT380**

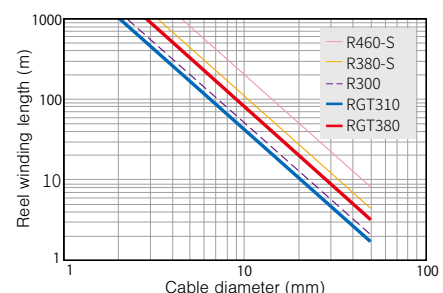

**Cable winding length reference chart**

**Cable Reels**

**Dependable cable reels Dependable steel reels with 3-speed brake**

Model	Flange Dim.	Description	Feature	Weight
<b>R300-S</b>	300 mm	with auxiliary reel	stackable	4.6 kg
<b>R380-S</b>	380 mm		w/caster	8.3 kg
<b>R460-S</b>	460 mm		w/caster	9.9 kg
<b>R300</b>	300 mm	cable hole on hub (no exit)	stackable	4.3 kg
<b>R300-L</b>	300 mm	connector trench on hub (no holes)	stackable	4.4 kg
<b>R300-CN</b>	300 mm	XLR3 receptacles on hub and flange	stackable	4.6 kg
<b>R300-BN</b>	300 mm	BNC receptacles on hub and flange	stackable	4.6 kg

Color: black

- 3-speed brake : lock/soft/free
- Oilless bearing
- Tubular steel E brace construction
- Parallel wired M & F XLR3s for genderless connection (R300-CN)

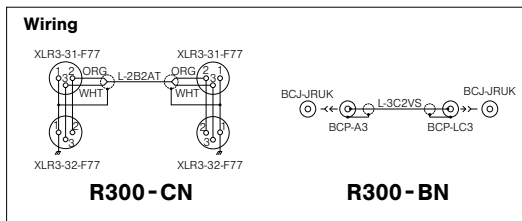

**Reels with Cable Assemblies**

**Cable reels with detachable cables**

Model	Cable reel	Description			Weight (kg)
		Inner end	Cable	Outer end	
<b>CR100-CN</b>	R300-CN	XLR3-12C	L-4E6S(100m)	XLR3-11C	9.6
<b>CR100-S</b>	R300-S	XLR3-12C	L-4E6S(100m)	XLR3-11C	9.6
<b>CR90-BN</b>	R300-BN	BCP-H5B	L-5C2VS(90m)	BCP-H5B	10.5



**Dimensions**

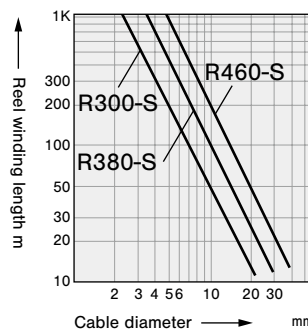
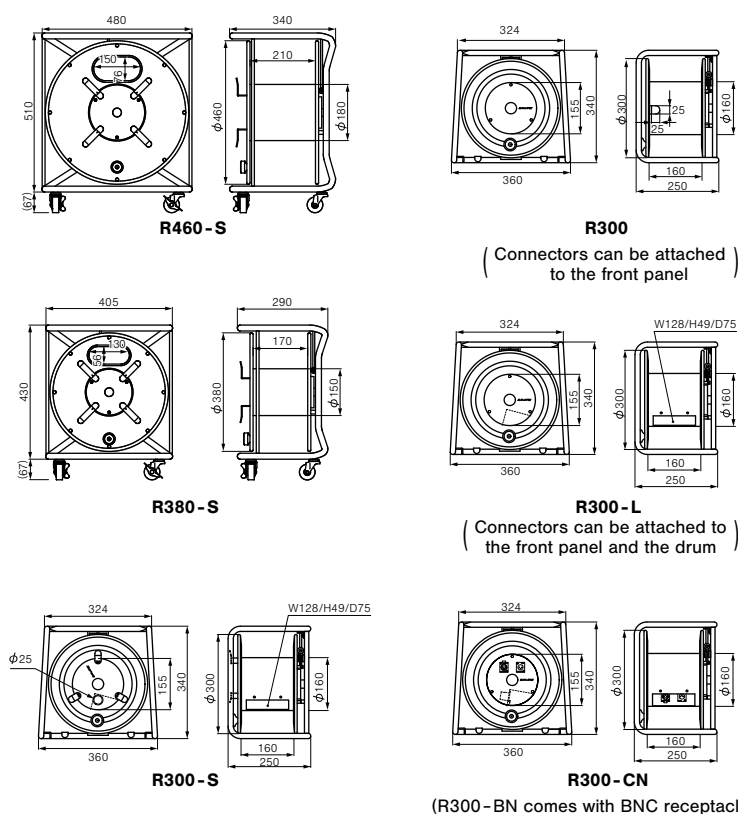

Cable winding length reference chart

<Wind length conversion formula>

$$R300-S \text{ (S, L, CN)} \quad L = \frac{8448}{D^2} \times 0.6 \text{ (m)} \quad R460-S \quad L = \frac{33852}{D^2} \times 0.6 \text{ (m)}$$

$$R380-S \quad L = \frac{18207}{D^2} \times 0.6 \text{ (m)} \quad D: \text{cable outer diameter (mm)} \quad L: \text{wind length}$$

# Cable Assemblies

## BNC

- High quality and reliable Canare assemblies are ideal for any interconnection including broadcast, professional A/V, and telecommunication.
- Custom assembly configurations can be special ordered at affordable cost and quick lead-time.



### ■ BNC 12G-SDI

For fixed installation

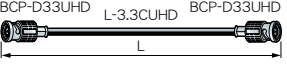
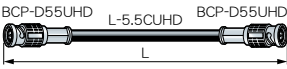
Type	Model	Length (m)
BNC (M) - BNC (M) Crimp  	D3.3UHDC005E	0.5
	D3.3UHDC01E	1
	D3.3UHDC015E	1.5
	D3.3UHDC02E	2
	D3.3UHDC03E	3
	D3.3UHDC05E	5
	D3.3UHDC10E	10
BNC (M) - BNC (M) Crimp  	D5.5UHDC01E	1
	D5.5UHDC03E	3
	D5.5UHDC05E	5
	D5.5UHDC10E	10
	D5.5UHDC20E	20
	D5.5UHDC30E	30
	D5.5UHDC50E	50
	D5.5UHDC70E	70
	D5.5UHDC100E	100

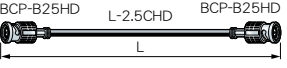
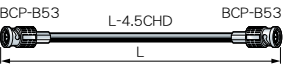

### ■ BNC

For fixed installation

Type	Model	Length (m)
BNC (M) - BNC (M) Crimp  	D3FBC005E	0.5
	D3FBC01E	1
	D3FBC015E	1.5
	D3FBC02E	2
	D3FBC03E	3
	D3FBC05E	5
	D3FBC10E	10
BNC (M) - BNC (M) Crimp  	D2.5HDC005E	0.5
	D2.5HDC01E	1
	D2.5HDC015E	1.5
	D2.5HDC02E	2
	D2.5HDC03E	3
	D2.5HDC05E	5
	D2.5HDC10E	10
BNC (M) - BNC (M) Crimp  	D4.5HDC03E	3
	D4.5HDC05E	5
	D4.5HDC10E	10
	D4.5HDC15E	15
	D4.5HDC20E	20

### ■ BNC

For mobile applications

Type	Model	Length (m)
BNC (M) - BNC (M) Crimp  	D3C005A-S	0.5
	D3C01A-S	1
	D3C02A-S	2
	D3C03A-S	3
	D3C05A-S	5
	D3C10A-S	10
BNC (M) - BNC (M) Crimp  	D5C005A-S	0.5
	D5C01A-S	1
	D5C015A-S	1.5
	D5C03A-S	3
	D5C05A-S	5
	D5C10A-S	10
	D5C15A-S	15
	D5C20A-S	20

### ■ BNC - DIN

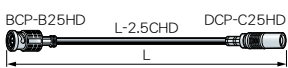
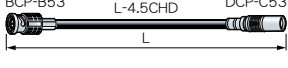
Type	Model	Length (m)
BNC (M) - DIN (M) Crimp  	D2.5HDC005E-D	0.5
	D2.5HDC01E-D	1
	D2.5HDC015E-D	1.5
	D2.5HDC02E-D	2
	D2.5HDC03E-D	3
	D2.5HDC05E-D	5
	D2.5HDC10E-D	10
BNC (M) - DIN (M) Crimp  	D4.5HDC03E-D	3
	D4.5HDC05E-D	5
	D4.5HDC10E-D	10
	D4.5HDC15E-D	15
	D4.5HDC20E-D	20

### ■ BNC - RCA

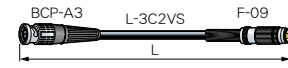
Type	Model	Length (m)
BNC (M) - RCA (M)  	D3C01A-SR	1
	D3C03A-SR	3
	D3C05A-SR	5

### ■ BNC water-proof New

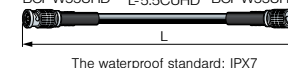
Type	Model	Length (m)
BNC (M) - BNC (M) <span style="color: red;">12G-SDI</span>   The waterproof standard: IPX7	WD5.5UHDC20	20
	WD5.5UHDC30	30
	WD5.5UHDC50	50

Sold separately: BNC Cap: BCP-DC (20pcs) • BCP-W55UHD is not for sale.

Micro BNC

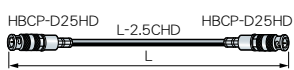
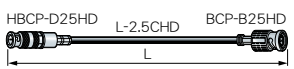
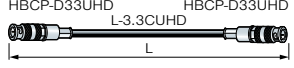
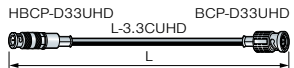
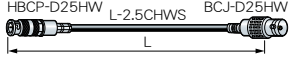
Type	Model	Length (m)	
<b>Micro BNC (M) - Micro BNC (M) Crimp</b> 	DM2.5HDC005	0.5	
	DM2.5HDC01	1	
	DM2.5HDC015	1.5	
	DM2.5HDC02	2	
	DM2.5HDC03	3	
	DM2.5HDC05	5	
	DM2.5HDC10	10	
<b>Micro BNC (M) - BNC (M) Crimp</b> 	DM2.5HDC005E-BP	0.5	
	DM2.5HDC01E-BP	1	
	DM2.5HDC015E-BP	1.5	
	DM2.5HDC02E-BP	2	
	DM2.5HDC03E-BP	3	
	DM2.5HDC05E-BP	5	
	DM2.5HDC10E-BP	10	
<b>Micro BNC (M) - Micro BNC (M) Crimp</b> <b>12G-SDI</b> 	DM3.3UHDC03 <b>New</b>	3	
	DM3.3UHDC05 <b>New</b>	5	
	DM3.3UHDC10 <b>New</b>	10	
	DM3.3UHDC15 <b>New</b>	15	
	DM3.3UHDC20 <b>New</b>	20	
	<b>Micro BNC (M) - BNC (M) Crimp</b> <b>12G-SDI</b> 	DM3.3UHDC03E-BP <b>New</b>	3
		DM3.3UHDC05E-BP <b>New</b>	5
DM3.3UHDC10E-BP <b>New</b>		10	
DM3.3UHDC15E-BP <b>New</b>		15	
DM3.3UHDC20E-BP <b>New</b>		20	
<b>Micro BNC (M) - BNC (F) Crimp</b> 	DM2.5HWSC002E-BJ	0.2	



DM2.5HDC

DIN

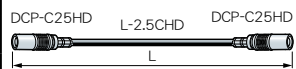
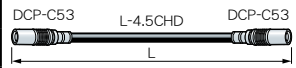
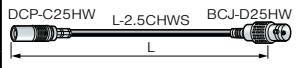
Type	Model	Length (m)
<b>DIN (M) - DIN (M) Crimp</b> 	DN2.5HDC005	0.5
	DN2.5HDC01	1
	DN2.5HDC015	1.5
	DN2.5HDC02	2
	DN2.5HDC03	3
	DN2.5HDC05	5
	DN2.5HDC10	10
<b>DIN (M) - DIN (M) Crimp</b> 	DN4.5HDC03	3
	DN4.5HDC05	5
	DN4.5HDC10	10
	DN4.5HDC15	15
	DN4.5HDC20	20
<b>DIN (M) - BNC (F) Crimp</b> 	<b>New</b> DN2.5HWSC002E-BJ	0.2

RCA (Video)

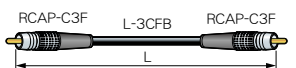
Type	Model	Length (m)
<b>RCA (M) - RCA (M) Solder</b> 	DRC01-S	1
	DRC03-S	3
	DRC05-S	5
<b>RCA (M) - RCA (M) Crimp</b> 	DRC10-F3	10
	DRC15-F3	15
	DRC20-F3	20
	DRC30-F3	30
	DRC40-F3	40

Triax

Cables used for connections such as those between broadcast cameras and CCUs.

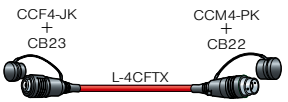
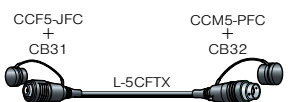
Type	Model	Length (m)
<b>Triaxial (F) - Triaxial (M)</b> U.S. preferred type 	TXC10-K	10
	TXC20-K	20
	TXC30-K	30
	TXC50-K	50
	TXC100-K	100
	TXC150-K	150
	TXC200-K	200
<b>Triaxial (F) - Triaxial (M)</b> EU preferred type 	TXC10-F	10
	TXC20-F	20
	TXC30-F	30
	TXC50-F	50
	TXC100-F	100
	TXC150-F	150
	TXC200-F	200

Technical Trend

Fiber-Optic Systems

Connectors

Cables

Panels & Patchbays

Multichannel Systems

Cable Assemblies

# Cable Assemblies

## Ethernet

### ■ Cat6A (Flexible STP) New

Easy routing

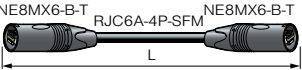
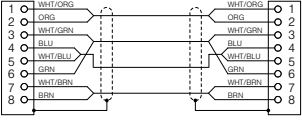
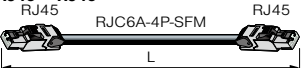
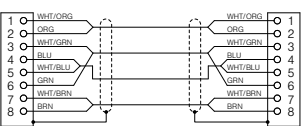
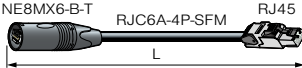
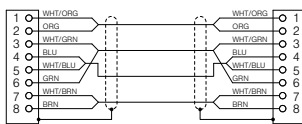
Type	Model	Length (m)	
<b>etherCON - etherCON</b>  NE8MX6-B-T RJC6A-4P-SFM NE8MX6-B-T  T568B (Straight)	ETC6A-03-N	3	
	ETC6A-05-N	5	
	ETC6A-10-N	10	
	ETC6A-20-N	20	
	ETC6A-30-N	30	
	ETC6A-50-N	50	
	ETC6A-70-N	70	
	ETC6A-100-N	100	
	<b>RJ45 - RJ45</b>  RJ45 RJC6A-4P-SFM RJ45  T568B (Straight)	ETC6A-03-T	3
		ETC6A-05-T	5
ETC6A-10-T		10	
ETC6A-20-T		20	
ETC6A-30-T		30	
ETC6A-50-T		50	
ETC6A-70-T		70	
ETC6A-100-T		100	
<b>etherCON - RJ45</b>  NE8MX6-B-T RJC6A-4P-SFM RJ45  T568B (Straight)		ETC6A-01-TN	1
		ETC6A-02-TN	2
	ETC6A-03-TN	3	
	ETC6A-05-TN	5	
	ETC6A-10-TN	10	



ETC6A-\*\*-N



ETC6A\*\*-T

### ■ Cat5e (Flexible UTP)

Easy routing

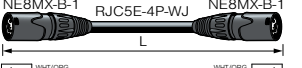
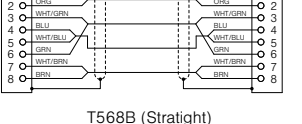
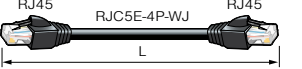
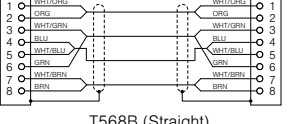
Type	Model	Length (m)	
<b>etherCON - etherCON</b>  NE8MX-B-1 RJC5E-4P-WJ NE8MX-B-1  T568B (Straight)	ETC10L-B	10	
	ETC30L-B	30	
	ETC50L-B	50	
	ETC70L-B	70	
	ETC100L-B	100	
	<b>RJ45 - RJ45</b>  RJ45 RJC5E-4P-WJ RJ45  T568B (Straight)	ETC10L-M	10
		ETC30L-M	30
		ETC50L-M	50
		ETC70L-M	70
		ETC100L-M	100

### ■ Cat5e (Flexible STP)

For short distance (max. 50 m)

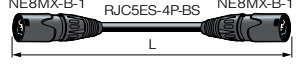
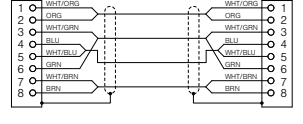
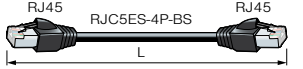
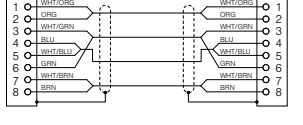
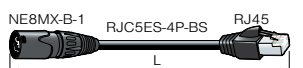
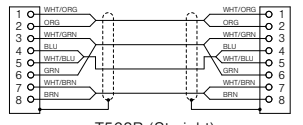
Type	Model	Length (m)
<b>etherCON - etherCON</b>  NE8MX-B-1 RJC5E-4P-BS NE8MX-B-1  T568B (Straight)	ETC003S-B	0.3
	ETC005S-B	0.5
	ETC01S-B	1
	ETC015S-B	1.5
	ETC02S-B	2
	ETC03S-B	3
	ETC05S-B	5
	ETC07S-B	7
	ETC10S-B	10
	ETC15S-B	15
<b>RJ45 - RJ45</b>  RJ45 RJC5E-4P-BS RJ45  T568B (Straight)	ETC003S-M	0.3
	ETC005S-M	0.5
	ETC01S-M	1
	ETC015S-M	1.5
	ETC02S-M	2
	ETC03S-M	3
	ETC05S-M	5
	ETC07S-M	7
	ETC10S-M	10
	ETC15S-M	15
<b>etherCON - RJ45</b>  NE8MX-B-1 RJC5E-4P-BS RJ45  T568B (Straight)	ETC20S-M	20
	ETC30S-M	30
	ETC50S-M	50
	ETC01S-BM	1
	ETC02S-BM	2

### ■ Cat6A (Standard STP) New

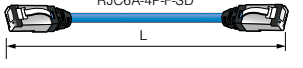
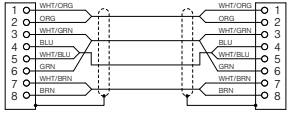
Type	Model	Length (m)
<b>RJ45 - RJ45</b>  RJ45 RJC6A-4P-F-SD RJ45  T568B (Straight)	NC6AFSD-01	1
	NC6AFSD-015	1.5
	NC6AFSD-02	2
	NC6AFSD-03	3
	NC6AFSD-05	5
	NC6AFSD-07	7
	NC6AFSD-10	10
	NC6AFSD-15	15
	NC6AFSD-20	20
	NC6AFSD-25	25
	NC6AFSD-30	30
	NC6AFSD-35	35
	NC6AFSD-40	40
	NC6AFSD-45	45
	NC6AFSD-50	50
NC6AFSD-70	70	

• RJC6A-4P-F-SD is not for sale.



**Cat6 (Standard STP)**

Type	Model	Length (m)
<p>T568B (Straight)</p>	<b>NC6F-01</b>	1
	<b>NC6F-015</b>	1.5
	<b>NC6F-02</b>	2
	<b>NC6F-03</b>	3
	<b>NC6F-05</b>	5
	<b>NC6F-07</b>	7
	<b>NC6F-10</b>	10
	<b>NC6F-15</b>	15
	<b>NC6F-20</b>	20
	<b>NC6F-25</b>	25
	<b>NC6F-30</b>	30
	<b>NC6F-35</b>	35
	<b>NC6F-40</b>	40
	<b>NC6F-45</b>	45
	<b>NC6F-50</b>	50
	<b>NC6F-70</b>	70
	<b>NC6F-100</b>	100

**Cat6 (Standard UTP)**

Type	Model	Length (m)
<p>T568B (Straight)</p>	<b>NC6-003</b>	0.3
	<b>NC6-005</b>	0.5
	<b>NC6-01</b>	1
	<b>NC6-015</b>	1.5
	<b>NC6-02</b>	2
	<b>NC6-03</b>	3
	<b>NC6-05</b>	5
	<b>NC6-07</b>	7
	<b>NC6-10</b>	10
	<b>NC6-15</b>	15
	<b>NC6-20</b>	20
	<b>NC6-25</b>	25
	<b>NC6-30</b>	30
	<b>NC6-35</b>	35
	<b>NC6-40</b>	40
	<b>NC6-45</b>	45
	<b>NC6-50</b>	50

**Cat5e (Standard UTP)**

Type	Model	Length (m)
<p>T568B (Straight)</p>	<b>NC5E-003</b>	0.3
	<b>NC5E-005</b>	0.5
	<b>NC5E-01</b>	1
	<b>NC5E-015</b>	1.5
	<b>NC5E-02</b>	2
	<b>NC5E-03</b>	3
	<b>NC5E-05</b>	5
	<b>NC5E-07</b>	7
	<b>NC5E-10</b>	10
	<b>NC5E-15</b>	15
	<b>NC5E-20</b>	20
	<b>NC5E-25</b>	25
	<b>NC5E-30</b>	30
	<b>NC5E-35</b>	35
	<b>NC5E-40</b>	40
	<b>NC5E-45</b>	45
	<b>NC5E-50</b>	50

**Quad-Cat5e New**

Type	Model	Length (m)
	<b>4ETCS-30-T</b>	30
	<b>4ETCS-50-T</b>	50

**RS422**

Used for RS422 serial signals.

Type	Model	Length (m)
	<b>DC01-9JE22</b>	1
	<b>DC03-9JE22</b>	3
	<b>DC05-9JE22</b>	5
	<b>DC07-9JE22</b>	7
	<b>DC10-9JE22</b>	10
	<b>DC20-9JE22</b>	20
	<b>DC30-9JE22</b>	30

**DMX**

Used for controlling stage and studio lighting equipment.

Type	Model	Length (m)	
<p><b>NC5 (F) - NC5 (M) Standard</b></p>	<b>DMC01-B</b>	1	
	<b>DMC03-B</b>	3	
	<b>DMC05-B</b>	5	
	<b>DMC10-B</b>	10	
	<b>DMC20-B</b>	20	
	<b>DMC30-B</b>	30	
	<b>DMC50-B</b>	50	
	<b>DMC100-B</b>	100	
	<p><b>NC5 (F) - NC5 (M) Thinner</b></p>	<b>DM4C01-B</b>	1
		<b>DM4C02-B</b>	2
<b>DM4C03-B</b>		3	
<b>DM4C05-B</b>		5	
<b>DM4C10-B</b>		10	
<b>DM4C20-B</b>		20	
<b>DM4C30-B</b>		30	
<b>DM4C50-B</b>		50	
<b>DM4C100-B</b>		100	
<p><b>NC5 (F) - NC5 (M) Thinnest (pins 4 &amp; 5 unconnected)</b></p>		<b>DM2C01-B</b>	1
	<b>DM2C02-B</b>	2	
	<b>DM2C03-B</b>	3	
	<b>DM2C05-B</b>	5	
	<b>DM2C10-B</b>	10	
	<b>DM2C20-B</b>	20	
	<b>DM2C30-B</b>	30	
	<b>DM2C50-B</b>	50	
	<b>DM2C100-B</b>	100	

Technical Trend

Fiber-Optic Systems

Connectors

Cables

Panels & Patchbays

Multichannel Systems

Cable Assemblies

# Cable Assemblies

## XLR, Phone

### XLR3

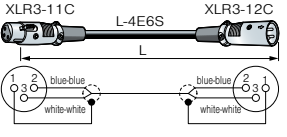
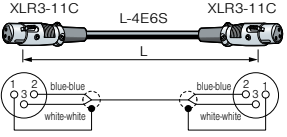
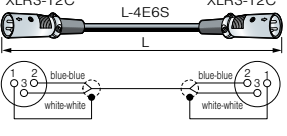
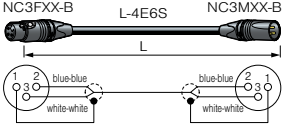
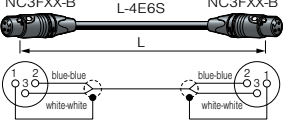
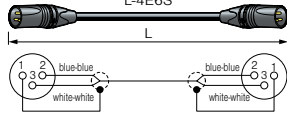
Type	Model	Length (m)
<b>XLR3 (F) – XLR3 (M)</b> 	EC003	0.3
	EC005	0.5
	EC01	1
	EC015	1.5
	EC02	2
	EC03	3
	EC05	5
	EC07	7
	EC10	10
	EC15	15
EC20	20	
<b>Color Legend:</b> BLK BRN RED ORN YEL GRN BLU PPL GRY WHT		
<b>XLR3 (F) – XLR3 (F)</b> 	EC003-X11	0.3
	EC005-X11	0.5
	EC01-X11	1
	EC015-X11	1.5
	EC02-X11	2
	EC03-X11	3
	EC05-X11	5
	EC10-X11	10
	EC15-X11	15
	EC20-X11	20
<b>Color Legend:</b> BLK BRN RED ORN YEL GRN BLU PPL GRY WHT		
<b>XLR3 (M) – XLR3 (M)</b> 	EC003-X22	0.3
	EC005-X22	0.5
	EC01-X22	1
	EC015-X22	1.5
	EC02-X22	2
	EC03-X22	3
	EC05-X22	5
	EC10-X22	10
	EC15-X22	15
	EC20-X22	20
<b>Color Legend:</b> BLK BRN RED ORN YEL GRN BLU PPL GRY WHT		
<b>NC3 (F) – NC3 (M)</b> 	EC003-B	0.3
	EC005-B	0.5
	EC01-B	1
	EC015-B	1.5
	EC02-B	2
	EC03-B	3
	EC05-B	5
	EC07-B	7
	EC10-B	10
	EC15-B	15
EC20-B	20	
<b>Color Legend:</b> BLK BRN RED ORN YEL GRN BLU PPL GRY WHT		
<b>NC3 (F) – NC3 (F)</b> 	EC003-B11	0.3
	EC005-B11	0.5
	EC01-B11	1
	EC015-B11	1.5
	EC02-B11	2
	EC03-B11	3
	EC05-B11	5
	EC10-B11	10
	EC15-B11	15
	EC20-B11	20
<b>Color Legend:</b> BLK BRN RED ORN YEL GRN BLU PPL GRY WHT		
<b>NC3 (M) – NC3 (M)</b> 	EC003-B22	0.3
	EC005-B22	0.5
	EC01-B22	1
	EC015-B22	1.5
	EC02-B22	2
	EC03-B22	3
	EC05-B22	5
	EC10-B22	10
	EC15-B22	15
	EC20-B22	20
<b>Color Legend:</b> BLK BRN RED ORN YEL GRN BLU PPL GRY WHT		

### Phone

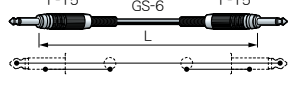
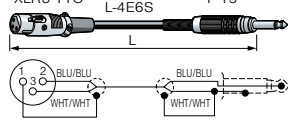
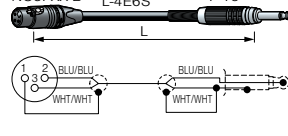
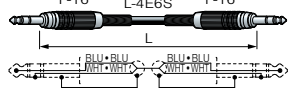
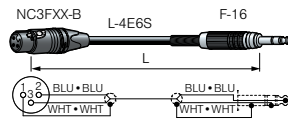
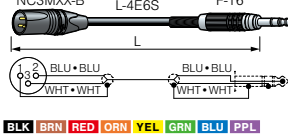
Type	Model	Length (m)
<b>Mono Phone (M) – Mono Phone (M)</b> 	LC018	1.8
	LC03	3
	LC05	5
	LC07	7
<b>Color Legend:</b> BLK RED ORN YEL GRN BLU		
<b>XLR3 (F) – Mono Phone (M)</b> 	PC03	3
	PC05	5
	PC07	7
	PC10	10
<b>Color Legend:</b> BLK BRN RED ORN YEL GRN BLU PPL GRY WHT		
<b>NC3 (F) – Mono Phone (M)</b> 	PC03-B	3
	PC05-B	5
	PC07-B	7
<b>Color Legend:</b> BLK BRN RED ORN YEL GRN BLU PPL GRY WHT		
<b>Stereo Phone (M) – Stereo Phone (M)</b> 	SPC01	1
	SPC03	3
	SPC05	5
	SPC07	7
	SPC10	10
	SPC15	15
	SPC20	20
<b>Color Legend:</b> BLK BRN RED ORN YEL GRN BLU PPL GRY WHT		
<b>NC3 (F) – Stereo Phone (M)</b> 	SPC02-B1	2
	SPC05-B1	5
<b>Color Legend:</b> BLK BRN RED ORN YEL GRN BLU PPL GRY WHT		
<b>NC3 (M) – Stereo Phone (M)</b> 	SPC02-B2	2
	SPC05-B2	5
<b>Color Legend:</b> BLK BRN RED ORN YEL GRN BLU PPL GRY WHT		

**RCA (Audio)**

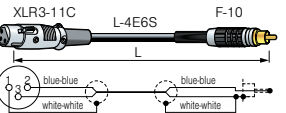
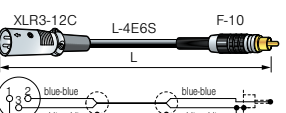
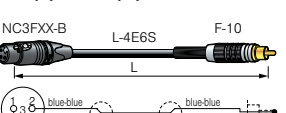
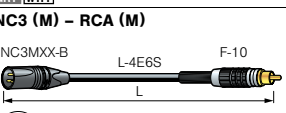
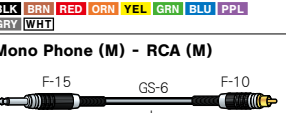
Type	Model	Length (m)
<b>RCA (M) – RCA (M)</b>  BLK RED ORN YEL GRN BLU	RC018	1.8
	RC03	3
	RC05	5
<b>XLR3 (F) – RCA (M)</b>  BLK BRN RED ORN YEL GRN BLU PPL GRY WHT	RC02 - X1	2
	RC05 - X1	5
<b>XLR3 (M) – RCA (M)</b>  BLK BRN RED ORN YEL GRN BLU PPL GRY WHT	RC02 - X2	2
	RC05 - X2	5
<b>NC3 (F) – RCA (M)</b>  BLK BRN RED ORN YEL GRN BLU PPL GRY WHT	<b>New</b> RC02 - B1	2
	<b>New</b> RC05 - B1	5
<b>NC3 (M) – RCA (M)</b>  BLK BRN RED ORN YEL GRN BLU PPL GRY WHT	<b>New</b> RC02 - B2	2
	<b>New</b> RC05 - B2	5
<b>Mono Phone (M) - RCA (M)</b>  BLK RED ORN YEL GRN BLU	QC018	1.8
	QC03	3
	QC05	5

**Audio Patch (Bantam)**

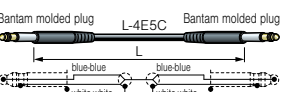
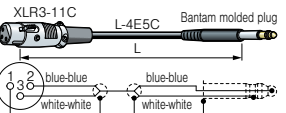
Type	Model	Length (m)
<b>Bantam (M) – Bantam (M)</b>  BLK RED ORN YEL GRN BLU GRY	BC003M	0.3
	BC006M	0.6
	BC009M	0.9
<b>XLR3 (F) – Bantam (M)</b>  BLK RED ORN YEL GRN BLU GRY	BC02M - X1	2
	BC02M - X2	2



BC003M

**Speaker**

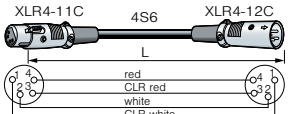
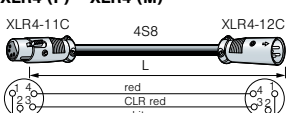
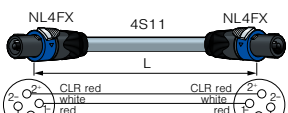
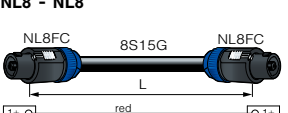
Type	Model	Length (m)
<b>XLR4 (F) – XLR4 (M)</b>  BLK RED BLU GRY CRE	SC003	0.3
	SC005	0.5
	SC01	1
	SC05	5
	SC10	10
	SC15	15
<b>XLR4 (F) – XLR4 (M)</b>  BLK GRY	SC05 - S8	5
	SC10 - S8	10
	SC15 - S8	15
<b>NL4 – NL4</b>  BLK GRY	SC05 - NL	5
	SC10 - NL	10
	SC15 - NL	15
	SC20 - NL	20
<b>NL8 – NL8</b>  BLK	SC30 - NL	30
	SC03 - 8NL	3
	SC05 - 8NL	5
	SC10 - 8NL	10
	SC20 - 8NL	20
SC30 - 8NL	30	
SC50 - 8NL	50	

**Audio Patch (Skini/Maxi)**

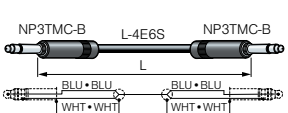
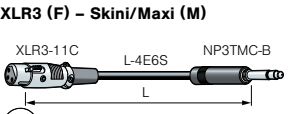
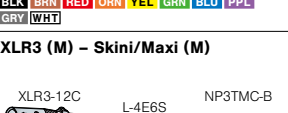
Type	Model	Length (m)
<b>Skini/Maxi (M) – Skini/Maxi (M)</b>  BLK BRN RED ORN YEL GRN BLU PPL GRY WHT	TC003B	0.3
	TC005B	0.5
	TC01B	1
<b>XLR3 (F) – Skini/Maxi (M)</b>  BLK BRN RED ORN YEL GRN BLU PPL GRY WHT	TC02B - X1	2
	TC05B - X1	5
<b>XLR3 (M) – Skini/Maxi (M)</b>  BLK BRN RED ORN YEL GRN BLU PPL GRY WHT	TC02B - X2	2
	TC05B - X2	5



TC003B

Technical Trend

Fiber-Optic Systems

Connectors

Cables

Panels & Patchbays

Multichannel Systems

Cable Assemblies

# Cable Assemblies

## Digital Audio, Analog Audio

### ■ AES/EBU Digital Audio

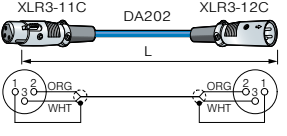
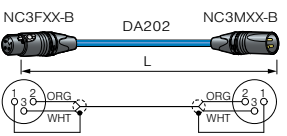
Type	Model	Length (m)
<b>XLR3 (F) - XLR3 (M)</b> 	DAC03	3
	DAC05	5
	DAC10	10
	DAC20	20
	DAC30	30
<b>NC3 (F) - NC3 (M)</b> 	DAC003 - B <b>New</b>	0.3
	DAC005 - B <b>New</b>	0.5
	DAC01 - B <b>New</b>	1
	DAC02 - B <b>New</b>	2
	DAC03 - B <b>New</b>	3
	DAC05 - B <b>New</b>	5
	DAC10 - B <b>New</b>	10
	DAC20 - B <b>New</b>	20
	DAC30 - B <b>New</b>	30

### ■ AES/EBU Digital Audio (Multi)

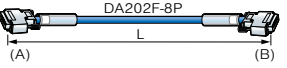
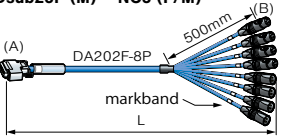
Type	Model	Length (m)
<b>Dsub25P (M) - Dsub25P (M)</b> 	8DAC02 - ##	2
	8DAC03 - ##	3
	8DAC05 - ##	5
	8DAC07 - ##	7
	8DAC10 - ##	10
	8DAC30 - ##	30
<b>Dsub25P (M) - NC3 (F/M)</b> 	8DACS02 - #B12	2
	8DACS03 - #B12	3
	8DACS05 - #B12	5
	8DACS07 - #B12	7
	8DACS10 - #B12	10
	8DACS30 - #B12	30

\* Please use following information to fill in the '#' in the model above.

### <Ordering Information>

Model	Brands (ref.)	A-side		B-side	
		Screws	Wiring	Screws	Wiring
8DAC**-DD	Digidesign	4-40	Individual-A	4-40	Individual-B
8DAC**-TT	TEAC	M2.6	Individual-A	M2.6	Individual-B
8DAC**-YY	YAMAHA	M2.6	Common-A	M2.6	Common-B
8DAC**-DT	Digidesign - TEAC	4-40	Individual-A	M2.6	Individual-B
8DAC**-DY	Digidesign - YAMAHA	4-40	Individual-A	M2.6	Common-B
8DAC**-TY	TEAC - YAMAHA	M2.6	Individual-A	M2.6	Common-B
8DACS**-DB12	Digidesign	4-40	Individual-A	N/A	2: Hot 3: Cold 1: Shield
8DACS**-TB12	TEAC	M2.6	Individual-A	N/A	
8DACS**-YB12	YAMAHA	M2.6	Common-A	N/A	

### <Wiring>

#### Individual - A

Ch. No.	Color Coding	HOT	COLD	SHIELD	N.C.
1	BLU/BRN	24	12	25	13
2	BLU/RED	10	23	11	
3	BLU/ORG	21	9	22	
4	BLU/YEL	7	20	8	
5	BLU/GRN	18	6	19	
6	BLU/-	4	17	5	
7	BLU/PPL	15	3	16	
8	BLU/GRY	1	14	2	

#### Individual - B

Ch. No.	Color Coding	HOT	COLD	SHIELD	N.C.
1	BLU/BRN	18	6	19	13
2	BLU/RED	4	17	5	
3	BLU/ORG	15	3	16	
4	BLU/YEL	1	14	2	
5	BLU/GRN	24	12	25	
6	BLU/-	10	23	11	
7	BLU/PPL	21	9	22	
8	BLU/GRY	7	20	8	

#### Common - A

Ch. No.	Color Coding	HOT	COLD	SHIELD	N.C.
1	BLU/BRN	1	14	10	9
2	BLU/RED	2	15		
3	BLU/ORG	3	16		
4	BLU/YEL	4	17		
5	BLU/GRN	5	18		
6	BLU/-	6	19		
7	BLU/PPL	7	20		
8	BLU/GRY	8	21		

#### Common - B

Ch. No.	Color Coding	HOT	COLD	SHIELD	N.C.
1	BLU/BRN	5	18	10	9
2	BLU/RED	6	19		
3	BLU/ORG	7	20		
4	BLU/YEL	8	21		
5	BLU/GRN	1	14		
6	BLU/-	2	15		
7	BLU/PPL	3	16		
8	BLU/GRY	4	17		

### ■ Analog Audio (Multi)

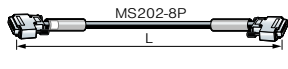
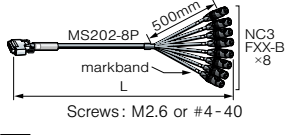
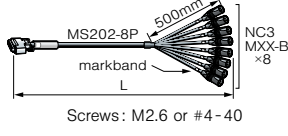
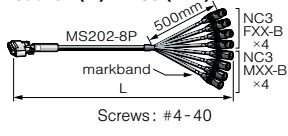
Type	Model	Length (m)
<b>Dsub25P (M) - Dsub25P (M)</b> 	8MC02 - #	2
	8MC03 - #	3
	8MC05 - #	5
	8MC07 - #	7
	8MC10 - #	10
<b>Dsub25P (M) - NC3 (F)</b> 	8MCS02 - #B1	2
	8MCS03 - #B1	3
	8MCS05 - #B1	5
	8MCS07 - #B1	7
	8MCS10 - #B1	10
	8MCS30 - #B1	30
<b>Dsub25P (M) - NC3 (M)</b> 	8MCS02 - #B2	2
	8MCS03 - #B2	3
	8MCS05 - #B2	5
	8MCS07 - #B2	7
	8MCS10 - #B2	10
	8MCS30 - #B2	30
<b>Dsub25P (M) - NC3 (F/M)</b> 	8MCS02 - CB12	2
	8MCS03 - CB12	3
	8MCS05 - CB12	5
	8MCS07 - CB12	7
	8MCS10 - CB12	10
	8MCS30 - CB12	30

\* Please choose between A: M2.6 and C: #4-40, and fill in the '#' in the model with A or C.  
e.g. 8MC02-A, 8MCS02-CB1

### <Wiring for 8MC/8MCS>

Ch. No.	Color Coding	Dsub25P			N.C.	NC3		
		HOT	COLD	SHIELD		HOT	COLD	SHIELD
1	BLK/BRN	24	12	25	13	2	3	1
2	BLK/RED	10	23	11		2	3	1
3	BLK/ORG	21	9	22		2	3	1
4	BLK/YEL	7	20	8		2	3	1
5	BLK/GRN	18	6	19		2	3	1
6	BLK/BLU	4	17	5		2	3	1
7	BLK/PPL	15	3	16		2	3	1
8	BLK/GRY	1	14	2		2	3	1

**Premium HDMI Cable** New Premium High Speed HDMI Cable with Ethernet

Type	Model	Length (m)	O.D. (mm)	
 <p>*HDM07P and HDM09P are <b>BLK</b> only.</p> <p><b>BLK</b> <b>WHT</b></p>	HDM006P	0.6	4.5	
	HDM01P	1		
	HDM015P	1.5		
		HDM02P	2	5.7
		HDM03P	3	
		HDM05P	5	6.5
		HDM07P	7	9.0
		HDM09P	9	

- Premium HDMI certified
- Tested for reliable 4K UHD performance
- Supports 4K60p and up to 18 Gbps bandwidth
- Seamless and robust plugs



HDM\*\*P (white)

**High Speed HDMI Cable with Ethernet**

Type	Model	Length (m)	O.D. (mm)
 <p><b>BLK</b></p>	HDM006AE	0.6	6.0
	HDM01AE	1	
	HDM015AE	1.5	
	HDM02AE	2	
	HDM03AE	3	
		HDM05AE	5

- Supports 4K30p and up to 10.2 Gbps bandwidth
- Cost effective

**High Speed HDMI Extension Cable** New

Type	Model	Length (m)	O.D. (mm)
 <p><b>BLK</b></p>	HDM003E-FM	0.3	5.7
	HDM02E-FM	2	6.5

- Male to Female
- Supports 4K30p and up to 10.2 Gbps bandwidth

**Active HDMI Cable** Supports ARC & HEC

Type	Model	Length (m)	O.D. (mm)
 <p>Source-side      Monitor-side</p> <p><b>BLK</b></p>	HDM07AE-EQ	7	7.1
	HDM10AE-EQ	10	
	HDM15AE-EQ	15	
		HDM20AE-EQ	20

- HDMI cable with built-in equalizer Note: The cables are directional
- Longer distances than passive cables
- Supports 4K30p and up to 10.2 Gbps bandwidth

**Durable Active HDMI Cable** HEC not supported

Type	Model	Length (m)	O.D. (mm)
 <p>Source-side      Monitor-side</p> <p><b>NB</b></p>	HDM10M-EQ	10	8.0

- Flexible and durable: easy to install Note: The cables are directional
- 10 meters transmission with built-in equalizer
- Supports 4K30p and up to 10.2 Gbps bandwidth

**HDMI Active Optical Cable** New ARC & HEC not supported

Type	Model	Length (m)	O.D. (mm)
 <p><b>BLK</b></p>	APF10-HDM	10	5.8
	APF15-HDM	15	
	APF20-HDM	20	
	APF30-HDM	30	
	APF50-HDM	50	
	APF70-HDM	70	
	APF100-HDM	100	

- HDMI cable with Plastic Optical Fiber (POF)
- Supports 4K60p and up to 18 Gbps bandwidth
- Long cable runs
- Slim and lightweight
- Flexible and durable
- Free from EMI/RFI

Note: The cables are directional

**Active Optical Cable with Detachable Connectors** New





ARC & HEC not supported

Type	Model	Length (m)	O.D. (mm)
 <p><b>BLK</b></p>	APF10-DCON	10	5.8
	APF15-DCON	15	
	APF20-DCON	20	
	APF30-DCON	30	
	APF50-DCON	50	
	APF70-DCON	70	
	APF100-DCON	100	

- Designed for cabling solutions including a compact core cable unit: APF-DCON, and additional detachable interfaces: HDMI, DVI, or DP.
- Performance qualified to 20,000 cycles of bending test.
- Flexible and durable
- Slim and lightweight
- Supports 4K60p

**Interface Connector Options**

Cables and Detachable Connectors are sold separately.

Type	Model	Plug Type
	DCON-HDT	Source(TX) HDMI Type A
	DCON-HDR	Display(RX) HDMI Type A
	DCON-DVT	Source(TX) DVI-D
	DCON-DVR	Display(RX) DVI-D
	DCON-DPT	Source(TX) DisplayPort

**HDMI with USB-A(5V)**

Equipped with USB power supply for power insufficient condition.

Type	Model	Plug Type
	DCON-HDE-SET	HDMI Type A with Built-in Equalizer

Be sure to attach these connectors to both ends of the cable when using it. Sales unit; 2pcs package only

**Interface Options**

Source(TX)	Resolution	Display(RX)	Source(TX)	Resolution	Display(RX)
HDMI Type D	4K60p	HDMI Type D	DCON-DVT	4K30p	HDMI Type D
HDMI Type D	4K60p	DCON-HDR	DCON-DVT	4K30p	DCON-HDR
HDMI Type D	DVI-D	DCON-DVR	DCON-DPT	4K60p	HDMI Type D
DCON-HDT	4K60p	DCON-HDR	DCON-DPT	4K60p	DCON-HDR
DCON-HDT	4K60p	HDMI Type D	DCON-DPT	DVI-D	DCON-DVR
DCON-HDT	DVI-D	DCON-DVR	DCON-HDE-SET	4K60p	DCON-HDE-SET
DCON-DVT	DVI-D	DCON-DVR			

# Cable Assemblies

## HDMI, DVI, VGA

### HDMI Extender

Extends uncompressed HDMI signal up to 100 meters over a Cat6 STP cable.

Model	In the Box
<b>HDE100CP-EXA</b>	TX unit, RX unit, IR cables, AC/DC adapter, wall mount tabs, and RS-232 cable mount connectors.

#### Key Features and Benefits

- Up to 100 m\* at 1080p @ 60 Hz or WUXGA
- Up to 70 m\* at 4K @ 30 Hz
- Power over Ethernet (PoE)
- HDCP 1.4/2.2 passthrough
- CEC passthrough
- RS-232 and 20 to 60 Hz wideband IR extension.
- TX unit can be purchased individually as a HDBaseT transmitter. (Model: HDE100CP-TXA. Contact us for more details.)

\* The transmission distance may vary depending on a cable type and environmental factors.  
 \* Recommended cable: Cat6 STP 24 AWG  
 \* HEC and ARC not supported

#### <Connection Example>

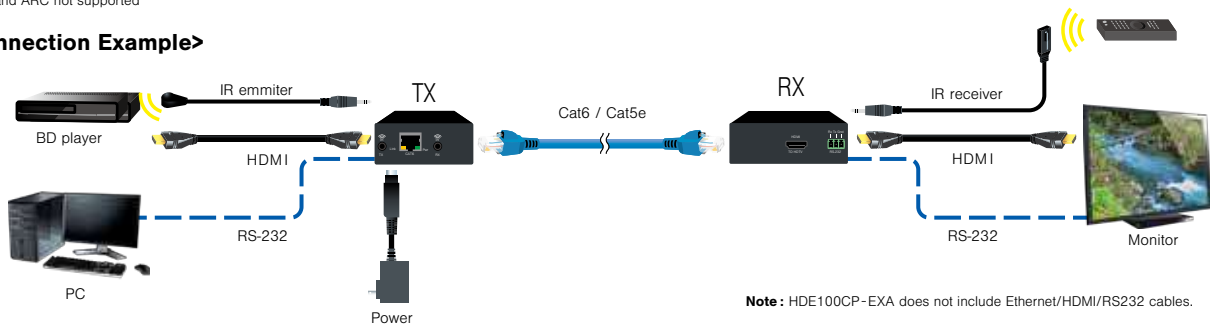

Note: HDE100CP-EXA does not include Ethernet/HDMI/RS232 cables.



**HDE100CP-EXA**

TX: 115 × 29 × 71 mm, 160 g  
 RX: 115 × 29 × 83 mm, 170 g



### DVI-D Dual Link

VESA-DDC Plug and Play compliant

Type	Model	Length (m)
<p>Screws: #4-40 UNC inch thread</p>	<b>DVID01A</b>	1
	<b>DVID015A</b>	1.5
	<b>DVID02A</b>	2
	<b>DVID03A</b>	3
	<b>DVID05A</b>	5

### DVI-HDMI

DVI-D Single Link to HDMI

Type	Model	Length (m)
<p>Screws: #4-40 UNC inch thread</p>	<b>DVI01-HDMA</b>	1
	<b>DVI015-HDMA</b>	1.5
	<b>DVI02-HDMA</b>	2
	<b>DVI03-HDMA</b>	3
	<b>DVI05-HDMA</b>	5

Note: DVI cannot carry audio signal.

### VGA



VESA-DDC Plug and Play compliant.  
 5VDC-1.7CF series are enhanced by low-loss coax unit.

Type	Model	Length (m)
<p>Screws: #4-40 UNC inch thread</p>	<b>5VDC015-1.7CF</b>	1.5
	<b>5VDC02-1.7CF</b>	2
	<b>5VDC03-1.7CF</b>	3
	<b>5VDC05-1.7CF</b>	5
	<b>5VDC10-1.7CF</b>	10
	<b>5VDC15-1.7CF</b>	15
<p>e-CON male plug and lock nuts included</p>	<b>5VDC20-1.7CF</b>	20
	<b>HDR15F-EJ1.5CA</b>	0.13

• V5D2P-1.7CF is not for sale.

**VGA**

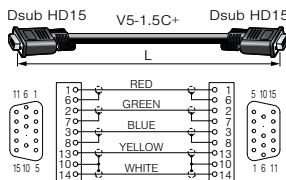
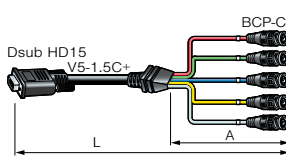
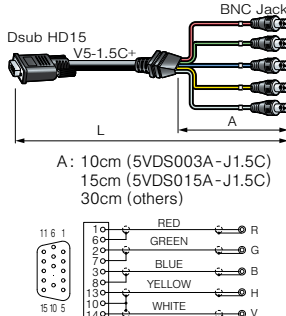
Not compatible with VESA-DDC Plug and Play.

Type	Model	Length (m)
<b>HD-15 (M) – HD-15 (M)</b>  <p>Screws: #4-40 UNC inch thread</p>	<b>5VDC015A - 1.5C</b>	1.5
	<b>5VDC02A - 1.5C</b>	2
	<b>5VDC03A - 1.5C</b>	3
	<b>5VDC05A - 1.5C</b>	5
	<b>5VDC10A - 1.5C</b>	10
	<b>5VDC15A - 1.5C</b>	15
	<b>5VDC20A - 1.5C</b>	20
<b>HD-15 (M) – BNC (M)</b>  <p>Screws: #4-40 UNC inch thread A: 15cm (5VDS015A-1.5C) 30cm (others)</p>	<b>5VDS015A - 1.5C</b>	1.5
	<b>5VDS02A - 1.5C</b>	2
	<b>5VDS03A - 1.5C</b>	3
	<b>5VDS05A - 1.5C</b>	5
	<b>5VDS10A - 1.5C</b>	10
<b>HD-15 (M) – BNC (F)</b>  <p>Screws: #4-40 UNC inch thread</p>	<b>5VDS003A - J1.5C</b>	0.3
	<b>5VDS015A - J1.5C</b>	1.5
	<b>5VDS02A - J1.5C</b>	2
	<b>5VDS03A - J1.5C</b>	3
	<b>5VDS05A - J1.5C</b>	5
	<b>5VDS10A - J1.5C</b>	10
<b>HD-15 (M) – BNC (F)</b>  <p>Lock nuts included</p>	<b>HDR15F - J1.5CA</b>	0.13



5VDS02A - 1.5C

**VGA with Audio**

VESA-DDC Plug and Play compliant

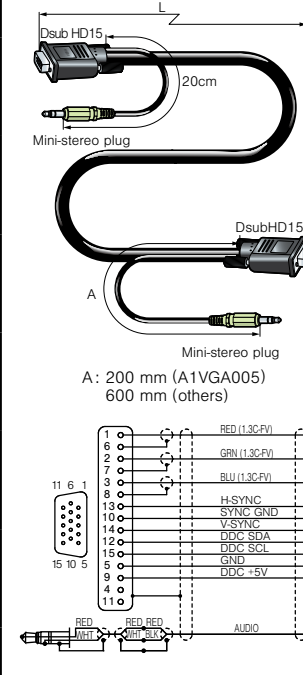
Type	Model	Length (m)
<b>HD-15 (M) – HD-15 (M) 3.5 mm TRS</b>  <p>Screws: #4-40 UNC inch thread</p>	<b>A1VGA005</b>	0.5
	<b>A1VGA0075</b>	0.75
	<b>A1VGA01</b>	1
	<b>A1VGA015</b>	1.5
	<b>A1VGA02</b>	2
	<b>A1VGA03</b>	3
	<b>A1VGA05</b>	5
	<b>A1VGA10</b>	10

**3 RCA Video & Audio**

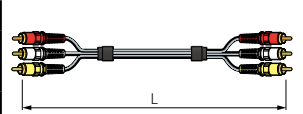
Type	Model	Length (m)
<b>RCA - RCA</b> 	<b>3RCS003</b>	0.3
	<b>3RCS005</b>	0.5
	<b>3RCS01</b>	1
	<b>3RCS015</b>	1.5
	<b>3RCS02</b>	2
	<b>3RCS03</b>	3
	<b>3RCS05</b>	5
	<b>3RCS10</b>	10
	<b>3RCS15</b>	15
	<b>3RCS20</b>	20
<b>3RCS30</b>	30	

**2 RCA Stereo Audio**

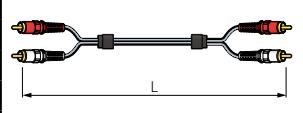
Type	Model	Length (m)
<b>RCA - RCA</b> 	<b>2RCS003</b>	0.3
	<b>2RCS005</b>	0.5
	<b>2RCS01</b>	1
	<b>2RCS015</b>	1.5
	<b>2RCS02</b>	2
	<b>2RCS03</b>	3
	<b>2RCS05</b>	5
	<b>2RCS10</b>	10
	<b>2RCS15</b>	15
	<b>2RCS20</b>	20
<b>2RCS30</b>	30	

Technical Trend

Fiber-Optic Systems

Connectors

Cables

Panels & Patchbays

Multichannel Systems

Cable Assemblies

👑: Bestselling products

0	06-1001-***	87	24B12MS	90	32MD-ST-2U	77	
	06-1877-04	87	24B12MSW	90	32MD-ST-4U	77	
1	125	87	24C**-E3	89	32MD-ST5	77	
	10PSA-JP	14	24C**-M2	89	32MD-ST5-2U	77	
	12B1N2	90	24C005-E3MS22	89	32MD-ST5-4U	77	
	12B2N1	90	24DV	78	32S1MS2	90	
	12C**-E3	89	24DV-2U	78	32S2MS2	90	
	12C**-M2	89	👑 24DVS	78	<b>New</b> 32SVK-ST-1.5U	75	
	12FS**-S	27	24DVS-2U	78	32SVK-ST	75	
	12J12N1	90	24FS**-S	27	32WB-*	87	
	12J12N12	90	24R30-E3	89	32XP-*	87	
	12J12N2	90	24S1MS2	90	3RCS**	102	
	12R**-E3	89	24S2MS2	90	3U-AS*	85	
	12S1N2	90	26DV	78	3U-AS* D	85	
	12S2N1	90	👑 26DV-2U	78	4	48-12A/820AQ/EIA	86
	14347 CLEANER	22	26DVS	78	481U-820AQ	86	
	161U-B1	84	26DVS-2U	78	481U-WB*	87	
	161U-B2	84	26WB-*	87	48MC	76	
	161U-JRUBD	84	2FM3Z2S**-DLS	28	48MCS	76	
	161U-JRUK	84	2FS**-S	27	48WB-*	87	
	161UPSC-**	14	2FSZ2S**A-DLS	27	48XP-*	87	
	161U-X12F	84	2PSC	14	<b>New</b> 4ETCS-**-T	96	
	161U-X1F	84	2RCS**	102	4FO-M3-**-LS	28	
	161U-X2F	84	👑 2S11F	62	4FO-M3-**-SS	28	
	162U-JRUK	84	2S11FG	62	4FS**-S	27	
	162U-X21	84	2S14F	62	4FS**T-LS	26	
	162U-X22	84	2S14FG	62	4FS**T-SS	26	
	16B1F2	90	👑 2S7F	62	4FS**T-ST	26	
	16B2F1	90	2S7FG	62	👑 4S10F	61	
	16C**-E3	89	👑 2S9F	62	4S10FG	61	
	16C**-M2	89	2S9FG	62	👑 4S11	61	
	16FS**-S	27	2U-AS*	85	4S11G	61	
	16J12F1	90	2U-AS* D	85	👑 4S12F	61	
	16J12F12	90	3	320A	86	4S12FG	61
	16J12F2	90	32-12A/620A/EIA	86	4S14F	61	
	16R**-E3	89	32B12MF11	90	4S18F	61	
	16S1F2	90	32B12MS	90	👑 4S6	61	
	16S2F1	90	32B12MSW	90	4S6G	61	
	1U-AS*	85	32B12MWF11	90	👑 4S8	61	
	1U-AS* D	85	32C**-M2	89	4S8G	61	
2	20DV	78	32C005-M2MS22	89	5	525	87
	👑 20DV-2U	78	👑 32MCK-ST	74	5VDC**-1.7CF	101	
	20DVS	78	32MCK-ST5	74	5VDC**A-1.5C	102	
	20DVS-2U	78	👑 32MD-ST	77	5VDS**A-1.5C	102	



5VDS**A-J1.5C	102	B75004A	29, 30, 43, 44, 45	BCJ-JRUBK	32
<b>6</b> 612A/320A/EIA	86	BC**M	98	BCJ-JRUDK	32
620A	86	BC02M-X1	98	BCJ-JRUK	32
6FS** - S	27	BC02M-X2	98	BCJ-KCM	40
6PSC- **	14	<b>New</b> BCAA-BL	35	<b>New</b> BCJ-MCVP	74, 76
<b>8</b> 820AQ	86	<b>New</b> BCAA-BS	35	BCJ-MVP	77
8B1N2	90	<b>New</b> BCAA-RL	35	BCJ-R	32
8B2N1	90	<b>New</b> BCAA-RS	35	BCJ-R/1	32
8C** - E3	89	<b>New</b> BCAA-TL	35	BCJ-RCAP	37
8C** - M2	89	<b>New</b> BCAA-TS	35	BCJ-RPC	34
8DAC** - ##	99	BCA-RL	36	BCJ-RPC/1	34
8DACS** - #B12	99	BCA-RS	36	BCJ-RU	32
8FS** - S	27	BCA-TL	36	BCJ-RUC1	32
8J12N1	90	BCA-TS	36	BCJ-RUD	32
8J12N12	90	BCJ-A10TRC-XP3F	50	BCJ-RUDB	32
8J12N2	90	BCJ-BPC2P	33	BCJ-TRC-XP3F	50
8MC** - #	99	BCJ-BPCK	33	BCJ-TRC-XP3M	50
8MCS** - #B1	99	BCJ-BPLH2PA	33	BCJ-VWP	78
8MCS** - #B2	99	BCJ-BPLH3PA	33	BCJ-XJ-A10TRC	50
8MCS** - CB12	99	BCJ-BPLHA	33	<b>Crown</b> BCJ-XJ-TRC	50
8R** - E3	89	BCJ-BPLHK	33	<b>Crown</b> BCJ-XP-TRC	50
8S15G	62	<b>New</b> BCJ-BPLHK2P	33	BCP-A25	29
8S1N2	90	BCJ-C4	31	BCP-A25F	29
8S2N1	90	BCJ-D25HD	31	BCP-A3	29
<b>9</b> 90-60*	87	BCJ-D25HW	31	BCP-A31	29
90-T	87	BCJ-D33UHD	31	BCP-A32	29
<b>A</b> A1VGA**	102	BCJ-DC	37	BCP-A3AHD	29
A2C3	64	BCJ-DC-CH	37	BCP-A3F	29
A2C3-SS	64	BCJ-DCJ	39	<b>Crown</b> BCP-A4	29
A2V1	63	BCJ-FC1	32	BCP-A42	29
A2V1B	63	BCJ-FC1-7/16	32	BCP-A4F	29
A2V2B	63	BCJ-FKCM	40	BCP-A5	29
A2V2-L	63	BCJ-FPC	34	BCP-A52	29
A3V2-FB	63	<b>Crown</b> BCJ-FPC02	34	BCP-A55	29
ABJ-DC	86	BCJ-FPLHA	34	BCP-A5F	29
<b>New</b> AKU-20LFYG	35	<b>Crown</b> BCJ-FPLV01	34	BCP-A77	29
<b>New</b> AKU-20SFYG	35	BCJ-FPLV-12G	34	<b>Crown</b> BCP-B25HD	29
<b>New</b> APF** - DCON	100	BCJ-FPLVA	34	BCP-B25HW	29
<b>New</b> APF** - HDM	100	BCJ-FPLV-L	34	BCP-B26	29
ASPT-1	20	<b>New</b> BCJ-HBCJK	38	BCP-B28	29
<b>B</b> B11014E	29, 30, 43	BCJ-JK	31	BCP-B31F	29
B11015E	29, 30, 43	BCJ-JRK	32	<b>Crown</b> BCP-B3F	29
B11016E	29, 30, 43	BCJ-JRUD	32	<b>Crown</b> BCP-B45HW	29
B11020D	29, 30, 43	BCJ-JRUBK	32	<b>Crown</b> BCP-B4F	29

# Index

## 👑: Bestselling products

BCP-B51F	29	BN1012B	30	BN7114	42
👑 BCP-B53	29	BN1016C	45	BN7120	42
BCP-B56	29	BN1018A	29	BN7121	42
👑 BCP-B5F	29	BN1023A	45	BN7129	29, 43, 44
BCP-C1	30	BN1024A	45	BN7136	39
BCP-C5HD	30	BN1025B	45	BN7138	39
BCP-C6HD	30	BN1030A	44	BN7141	38, 39
BCP-C71A	30	BN1041A	44	BN7143	29
BCP-C7FA	30	BN1043A	30	BN7147	29
👑 BCP-C7HD	30	BN1082A	30	BN7155	38
👑 BCP-D33UHD	29	BN1083A	30	BN7157	38
👑 BCP-D55UHD	29	BN1093	43	BN7158	31
Coming Soon BCP-D55UHW	29	BN1131	42	BN7159	31
BCP-D57	29	BN1135	42	BN9078A	41
BCP-D8UHD	29	BN1139	30	BN9079B	41
<b>New</b> BCP-DC	93	BN1148	39	BN9127A	42
BCP-DCJ	39	BN1157	39	BN9128B	42
BCP-H31F	31	BN1158	39	BN9182A	42
BCP-H3B	31	BN1174	29	BN9194	42
BCP-H45HW	31	BN1175	29	BP-C**	45
BCP-H5/1	31	BN1181	29	BP-D	84
BCP-H51F	31	BN1192	29	BP-DXF	84
BCP-H5B	31	BN1198	38	BP-LC**	45
BCP-LC3	30	BN1199	38	BP-XF	84
BCP-LC3F	30	BN1200	38	<b>C</b> CB01	31
BCP-LC5	30	BN1204	31	CB02	31
BCP-LC5F	30	BN1205	31	CB03	31
BCP-RCAJ	37	BN7002	29, 45	CB04	31
BCP-TK	31	BN7003A	29, 30, 31, 38, 39, 43, 44, 45	CB05A	31
BCP-TK-CH	31	BN7011	29, 43, 44, 45	CB22	42
BCP-VA3	29	BN7014	29, 44	CB23	42
BCP-VA5	29	BN7015A	29, 30, 39, 43, 44	CB24	31
Coming Soon BET-BNC	47	BN7016	29, 30, 43, 44, 45	CB25	31
<b>New</b> BET-D/H	38, 47	BN7021A	30, 44	CB26	31
BET-DIN	47	BN7022	30	CB31	42
BET-MBNC	47	BN7026A	29	CB32	42
BJ-J	45	BN7029C	29, 30, 43	CCF4-JK	42
BJ-JR	45	BN7030A	45	CCF4-JKR	42
BJ-JRU	45	BN7045A	29, 44	CCF5-JFC	42
BJ-JRUD	45	BN7046	29, 30, 44	CCF5-JFRC	42
BN1002B	44	BN7052A	29	CCF7-JFC	42
BN1003B	44	BN7074A	30	CCF7-JFRC	42
BN1004B	44	BN7079	43	CCM4-PK	42
BN1005B	44	BN7113	42	CCM4-PKR	42

CCM5-PFC	42	DCF02	42	DVJB-S	78
CCM5-PFRC	42	DCJ-C25HW-ML	41	DVJB-W	78
CCM7-PFC	42	DCJ-FEM	39	<b>E</b> EC**	97
CCM7-PFRC	42	DCJ-JR	39	EC**-B	97
CLETOP 2.5/2.0	22	DCJ-LR	39	EC**-B11	97
COF-12B	24	DCJ-LR/1	39	EC**-B22	97
COF-13C	24	DCM01	41	EC**-X11	97
COF-32A	24	DCM02	42	EC**-X22	97
COF-33B	24	DCM02	42	EE12G-100	8
COPS3-FF*A	23	DCM03	42	<b>New</b> EO12G-100A-**	8
COPS3-FM*A	23	<b>New</b> DCON-DPT	100	EO12G-100B	8
COPS-FF*A	23	<b>New</b> DCON-DVR	100	EO3G-100	9
COPS-FM*A	23	<b>New</b> DCON-DVT	100	EO3G-100A-**	9
COU-BP*A	24	<b>New</b> DCON-HDE-SET	100	EO3G-200	9
COU-CV*	24	<b>New</b> DCON-HDR	100	EO-500-**	10
COUS-FF*A	24	<b>New</b> DCON-HDT	100	ETC**L-B	95
COUS-FM*A	24	DCP-C25HD	39	ETC**L-M	95
CR100-CN	92	DCP-C25HW	39	ETC**S-B	95
CR100-S	92	DCP-C25HW-ML	41	ETC**S-BM	95
CR90-BN	92	DCP-C3F	39	ETC**S-M	95
<b>D</b> D/MS3057-**A	89	DCP-C4F	39	<b>New</b> ETC6A-**-N	95
D/MS3101A	89, 90	DCP-C53	39	<b>New</b> ETC6A-**-T	95
D/MS3102A	90	DM2.5HDC**	94	<b>New</b> ETC6A-**-TN	95
D/MS3106B	89	DM2.5HDC**E-BP	94	<b>F</b> <b>👑</b> F-09	43
D2.5HDC**E	93	DM2.5HWSC002E-BJ	94	F-10	43
D2.5HDC**E-D	93	DM2C**-B	96	F-11	44
D3.3UHDC**E	93	<b>New</b> DM3.3UHDC**	94	F-12	44
D3C**A-S	93	<b>New</b> DM3.3UHDC**E-BP	94	F-15	44
D3C**A-SR	93	DM4C**-B	96	F-16	44
D3FBC**E	93	DMC**-B	96	FCBA4-F*5W*	15
D4.5HDC**E	93	DMX203	64	FCBA4-F*5W*-PV	15
D4.5HDC**E-D	93	DMX203-2P	64	FCBA-F*3W*-3G	16
D5.5UHDC**E	93	DMX403	64	FCBA-F*3W*-3G-PV	16
D5C**A-S	93	DN2.5HDC**	94	<b>New</b> FCBK4-F*5W*-12G	15
<b>👑</b> DA202	60	<b>New</b> DN2.5HWSC002E-BJ	94	<b>New</b> FCBK4-F*5W*-12G-PV	15
<b>👑</b> DA202AT	60	DN4.5HDC**	94	<b>New</b> FCBK-F*3W*-12G	16
<b>👑</b> DA202F-*P	60	DRC**-F3	94	<b>New</b> FCBK-F*3W*-12G-PV	16
DA203-**AL	60	DRC**-S	94	FCC**-7N	18
DA203AL	60	DS10-AS1	86	FCC**-7T	19
DA206	60	DS10-AS2	86	FCC**-9T	19
DAC**	99	DS10-AS3	86	FCC**A-WJ	17
<b>New</b> DAC**-B	99	DS10-AS4	85	<b>👑</b> FCC**N	17
DC**-9JE22	96	DVI**-HDMA	101	FCC**N-FMRC	20
DCF01	41	DVID**A	101	FCC**N-FRCM	20

👑: Bestselling products

<b>New</b> FC-CV-F-SET-**	17	FP-C5F	44	L-2E5AL	56
<b>New</b> FC-CV-M-SET-**	17	FP-C71A	44	👑 L-2E5AT	56
FCE-*	24	FP-C7FA	44	👑 L-2T2S	56
FCF02N-OCM	21	FS2C**A-LS	27	👑 L-3.3CUHD	66
FCM02N-OCF	21	FS2C**A-SS	27	L-3C2V	68
FCS003A-FR	23	FS2C**A-SS/LS	27	L-3C2VS	68
FCS003A-MR	23	FS3C**A-S	27	L-3C2W	68
FCS015A-FR	20	<b>G</b> GS-4	63	L-3C-AHD	68
FCS015A-MR	20	👑 GS-6	63	👑 L-3CFB	67
FCT-FC RED	22	<b>H</b> <b>New</b> HBCJ-FEMK	38	L-3CFW	67
👑 FCT-FCKIT RED	22	<b>New</b> HBCJ-JRK	38	L-3D2V	72
FCT-FCLB RED	22	<b>New</b> HBCJ-LRK	38	L-3D2W	72
FCT-OC RED	22	<b>New</b> HBCJ-LRK/1	38	👑 L-4.5CHD	66
FCT-OCKIT RED	22	HBCP-D25HD	38	👑 L-4.5CHWS	67
FCT-OCLB RED	22	HBCP-D25HW	38	👑 L-4CFB	67
FCWDM16A	13	HBCP-D33UHD	38	L-4CFTX	69
FCWDM8/1A	13	HBCP-D53	38	L-4CHD	66
FCWDM8/1A-13	13	HDE100CP-EXA	101	L-4E3-**AT	55
FCWDM8/2A	13	HDE100CP-TXA	101	L-4E3-**P	55
FCWDM8/2A-13	13	HDM**AE	100	L-4E3-2H	55
FCWDM-8B	13	HDM**E-EQ	100	L-4E3AT	54
FCWDM-8B-13	13	<b>New</b> HDM**E-FM	100	👑 L-4E4-**AT	55
FDM-*	13	<b>New</b> HDM**P	100	L-4E4-*P	55
FJ-FPC	44	HDM10M-EQ	100	L-4E5	54
FJ-JR	44	HDR15F-EJ1.5CA	101	👑 L-4E5AT	54
FJ-JRU	44	HDR15F-J1.5CA	102	L-4E5ATG	54
FJ-JRUD	44	<b>I</b> IBC Brand Cleaner	22	L-4E5AT-WBS	54
FJ-JRUDB	44	IU-7/16	32	L-4E5C	54
FK37-2°C	89, 90	IU-FC*-SET	20	L-4E6	54
FK37-3*S	90	<b>K</b> KC1.2R-****-L	40	👑 L-4E6AT	54
FM32C**-LS	28	KC1.2R-****-S	40	L-4E6ATG	54
FM32C**-SS	28	KC1.2R-****-SL	40	L-4E6AT-WBS	54
FM32C**-SS/LS	28	KCM-LR	40	👑 L-4E6S	54
FM33C**-S	28	KCM-PC	40	L-4E6-WBS	54
FP-C25HD	44	<b>L</b> L-1.5C2VS	68	👑 L-5.5CUHD	66
FP-C3	44	L-2.5C2V	68	<b>Coming Soon</b> L-5.5CUHWS	67
FP-C31	44	L-2.5CFB	67	L-5C2V	68
FP-C3F	44	👑 L-2.5CHD	66	L-5C2VS	68
FP-C4	44	L-2.5CHLT	66	L-5C2W	68
FP-C4F	44	L-2.5CHWS	67	👑 L-5CFB	67
FP-C5	44	L-2B2AL	56	L-5CFTX	69
FP-C52	44	👑 L-2B2AT	56	L-5CFW	67
FP-C53A	44	L-2E4-**AL	57	L-5CHD	66
FP-C55A	44	L-2E5	56	L-5D2V	72

L-5D2W	72	MDVJ-STW	77	OE-501	10
L-5DFB	72	<b>New</b> MJ2-M32-1.5U-***	81	OM6C**	25
L-5DFBW-PE	72	MJ2-M32-1U-***	81	OM6S**-JR	25
L-6CHD	66	MJ2-M32-2U-***	81	OM6S**-PR	25
L-7CFB	67	MJ2-M32CK-1U-***	81	<b>P</b> PC**	97
L-7CFTX	69	M-MA*U02	85	PC**-B	97
<b>👑</b> L-7CHD	66	<b>👑</b> MR202-**AT	58	PH50A	75, 77, 78, 86
L-8CHD	66	MS202	57	PH50B	74, 76, 86
L-8CUHD	66	MS202-**P	59	PSM2-**	14
LC**	97	MS203	57	<b>Q</b> QC**	98
LF-2SM16	17	MS203-*BS	59	<b>R</b> R300	92
LF-2SM7N	18	MVJ-DC	77	R300-BN	92
LF-2SM7T	19	MVPC**	83	R300-CN	92
<b>👑</b> LF-2SM9N	17	MVPC**A-BP	83	R300-L	92
LF-2SM9T	19	<b>New</b> MVPC**-HW	83	<b>👑</b> R300-S	92
LF-M32-*C-EM	28	MVPC002-BJ	83	<b>👑</b> R380-S	92
LF-M3R4-12C-EM	28	MVP-C25HW	77	<b>👑</b> R460-S	92
LF-SM2-**C	26	MVP-C4	77	RC**	98
LF-SM2T-4C	26	<b>N</b> NC5E-**	96	<b>New</b> RC**-B1	98
<b>👑</b> LV-61S	68	NC6-**	96	<b>New</b> RC**-B2	98
LV-77S	68	<b>New</b> NC6AFSD-**	95	RC**-X1	98
<b>M</b> M202-**AT	58	NC6F-**	96	RC**-X2	98
MBCP-C25F	30	NCJ-BCJR	37	RCAP-C25F	43
MBCP-C3F	30	NCP-H8HD	37	RCAP-C25HD	43
MBCP-C4	30	NDT-DIN	39	RCAP-C3A	43
MBCP-C4F	30	<b>New</b> NDT-HBC	38	RCAP-C3F	43
MBCP-C53	30	NJ-C5F	46	RCAP-C3GS	43
MBCP-C5F	30	NK27-2*C	89, 90	RCAP-C42	43
MCF-V5C3	41	NK27-3*S	90	RCAP-C4A	43
MCM-V5C3	41	NP3TMC-B	86	RCAP-C4F	43
MCVJ-DC	74, 76	NP-C**	46	RCAP-C53	43
MCVJK-ST5	74	NP-LC**	46	RCAP-C5A	43
MCVJK-STW	74	<b>Q</b> OCC**-7N	21	RCAP-C5F	43
MCVJ-S	76	OCC**-7T	21	RCAP-C77	43
MCVJ-W	76	OCC**-9T	21	<b>New</b> RGT310.MFK	91
MCVPC**	83	OCC**-N	21	<b>New</b> RGT310.RM	91
MCVPC**-MVP	83	OCC**N-FMRC	21	<b>New</b> RGT380.MFK	91
MCVPC**-VWP	83	OCC**N-FRCM	21	<b>New</b> RGT380.RM	91
MCVPC002-BJ	83	OCC**-WJ	21	RJ-BCJRU	43
MCVP-C25HW	74, 76	OCS**-FR	21	RJ-BCJRUD	43
MDF-V4C25HW	41	OCS**-MR	21	RJ-BCJRUDB	43
MDF-V4JRU	41	OE12G-101B	8	RJC5E-4P+	65
MDM-V4C25HW	41	OE3G-101	9	RJC5E-4P-WJ	65
MDVJ-ST5	77	OE3G-201	9	RJC5ES-4P-BS	65

RJC6-4P+	65	TCD-451CA	47	V*-5CFB	69
RJC6-4P-F	65	TCD-4CA	47	V*-5CFW	69
<b>New</b> RJC6A-4P-F	65	TCD-55FA	47	V4-2.5CHW	69
<b>New</b> RJC6A-4P-SFM	65	TCD-55UHD	47	VJ2-M32-4U	81
RJ-JR	43	TCD-57C	47	VJ2-V20-1U-***	81
RJ-JRU	43	TCD-5CF	47	VJ2-V20-2U-***	81
RJ-JRUD	43	TCD-5HD	47	VJ2-V24-1U-***	81
RJ-JRUDB	43	TCD-65C	47	VJ2-V24-2U-***	81
RJ-RU	43	TCD-67HD	47	VJ2-V26-1U-***	81
RJ-RUD	43	TCD-7CA	47	VJ2-V26-2U-***	81
RJ-RUDB	43	TCD-8HD	47	VJ-DC	78
RS-422-1U-**	82	TCD-96C	47	<b>New</b> VPC**-HW-WC	83
RS-422-2U-**	82	TCD-D253F	47	VPC**-WC	83
<b>S</b> S410-*P	61	TCD-D534F	47	VWP-C25HW	78
SC**	98	TNP-C**	46	VWP-C4A	78
SC**-8NL	98	TNP-LC**	46	<b>W</b> <b>New</b> WD5.5UHDC**	93
SC**-NL	98	TRM-100	12	<b>New</b> WEPZ0258	14
SC**-S8	98	TRM-101	12	<b>New</b> WMM0190	14
SMAJ-C**	46	TRM-210	11	<b>X</b> XJ3F-A10TRC-BCJ	50
SMAP-C**	46	TRM-210A-**	11	XJ3F-P3FA	84
SPC**	97	TRM-211	11	XJ3F-P3MA	84
SPC**-B1	97	TRM-220	12	XJ3F-TRC-BCJ	50
SPC**-B2	97	TRM-220A-**	12	XJ3M-P3FA	84
SVJK-AP	75	TRM-221	12	XJ3M-P3MA	84
SVJK-DC	75	TRM-230	12	XJ3M-TRC-BCJ	50
SVJK-L	75	TRM-231	12		
SVJK-S	75	TRM-300A-G**	11		
SVPC**	83	TRM-300-G31	11		
SVP-C25HW	75	TRM-300-G55	11		
SVP-TK	75	TRM-400	12		
SVP-ULK	75	TRM-401	12		
<b>T</b> TB-2A	47	TRM-540	10		
TC**B	98	TRM-540A-**	10		
TC**B-X1	98	TRM-541	10		
TC**B-X2	98	<b>TS100E</b>	47		
TC-1	47	TS100U	47		
TC-2	47	TXC**-F	94		
TCD-1DB	47	TXC**-K	94		
TCD-3151D	47	<b>V</b> V*-1.5C	69		
TCD-316C	47	V*-3C	69		
TCD-31C	47	V*-3CFB	69		
TCD-35CA	47	V*-3CFW	69		
TCD-35D	47	V*-4CFB	69		
TCD-35DF	47	V*-5C	69		

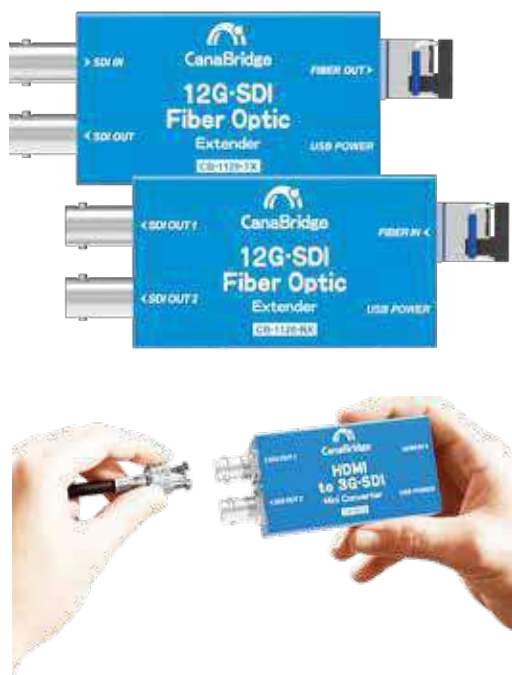

## About CanaBridge

*The professionals' choice*

A sub brand "CanaBridge" is established by Canare. Providing simple and affordable solutions of video signals, bridging long lasting Canare users between new generation of SNS video creators.

CanaBridge video converters will give you smart move on HDMI, 3G-SDI, and 12G-SDI interconnects. Canare engineers its development and quality verification. All CanaBridge products are equipped with light weight and sleek aluminum chassis.

## CanaBridge **5** Identities

### **01** *Superb Combination*

We raised the bar on mini converters solutions. CanaBridge converters connected with Canare products are superb combination.

### **02** *Professional Support*

Canare is here to assist you all the time. All CanaBridge products include one-year hassle free exchange program. In addition, We will provide the best sales support as well as after sale service.

### **03** *Stable Performance*

CanaBridge converters will deliver stable performance even under demanding environments. It meets your expectation without any surprises.

### **04** *Fully Engineered*

Canare engineers invest engineering effort and whole enthusiasm into CanaBridge products. Verified technical accuracies and put it into original aluminum case.

### **05** *Solid*

CanaBridge has been looking at cutting-edge technologies, appropriate materials, and standardized processes.

CanaBridge

*Lifetime Support*  
CanaBridge 5 Identities Guarantees

**5** CanaBridge  
Identities Guarantees 

# Video Converters

CanaBridge

## 12G-SDI Solutions

### CB-1120 (TX and RX) New

12G-SDI Fiber Optic Extender

#### Key Features and Benefits

- 12G/6G/3G-SDI input & loopout on transmitter
- Dual 12G-SDI outputs on receiver
- Supports up to 12G bandwidth
- SDI input automatic switching SD, HD, 3G, 6G, 12G-SDI
- 10km transmission distance



12G-SDI

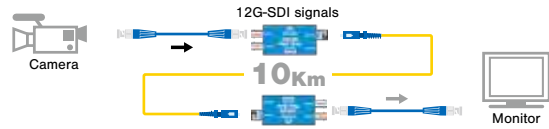

CB-1120-TX

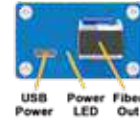
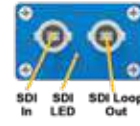

CB-1120-RX

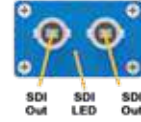
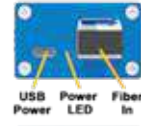

#### Specifications

Model	CB-1120 (TX and RX)
Power	Micro USB
Power Consumption	2.0W (Max)
Voltage Range	USB 3.3-5.5 V
Dimension	72.4 × 41 × 24.6 mm
Net Weight	Transmitter: 115 g, Receiver: 115 g
Gross Weight	960g

### CB-8130 New

12G-SDI 1 × 5 Reclocking Distribution Amplifier

#### Key Features and Benefits

- 12G/6G/3G/HD/SD-SDI multi-rate signal processing
- 5 buffered and re-clocked outputs
- Support DVB-ASI signal (OUT1, 4, 5)
- Automatic cable equalization and signal retiming
- All ancillary data is passed to the outputs



12G-SDI

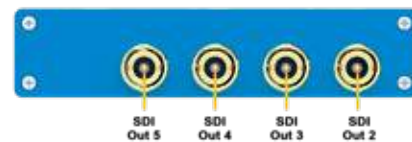
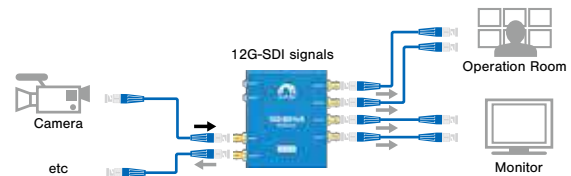

#### Specifications

Model	CB-8130
Power Supply	Threaded locking DC connector
Voltage Range	DC 6-23 V
Power Consumption	3W (Max)
Dimension	125.5 × 102 × 27.5 mm
Net Weight	310 g
Gross Weight	950 g

*Lifetime Support*

*CanaBridge 5 Identities Guarantees*

**5** CanaBridge Identities Guarantees



**3G-SDI Solutions**

**CB-2011**  
3G-SDI to HDMI mini Converter

**CB-2012**  
HDMI to 3G-SDI mini Converter

**Key Features and Benefits**

- Being made for Broadcast equipment
- Powered Anywhere
- Pocket Size and Easy to Mount

**Specifications**

Model	CB-2011	CB-2012
Power	Micro USB	
Power Consumption	2.5W (Max)	2W (Max)
Voltage Range	USB 3.3-5.5 V	
Dimension	72.4 × 41 × 24.6 mm	
Net Weight	110 g	
Gross Weight	470 g	

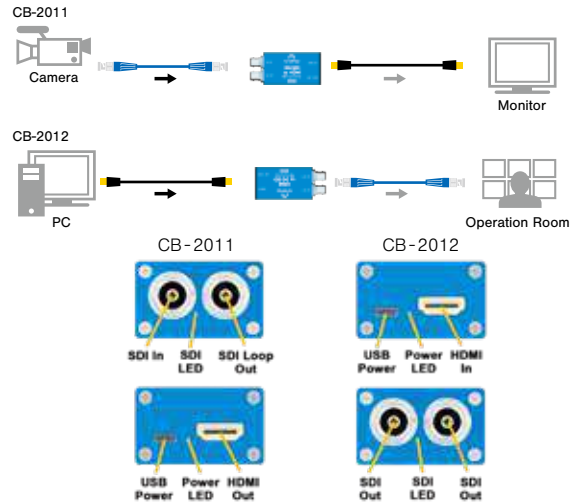

**CB-2021**  
3G-SDI to HDMI & AV Scaling Converter

**Key Features and Benefits**

- Up/down scaling and frame rate conversion
- AES/EBU or Analog Audio Embedding & De-embedding
- Input signal automatic detection and configuration
- LED indicators for power and signal lock



**Specifications**

Model	CB-2021
Power	Threaded locking connector
Power Consumption	6W (Max)
Voltage Range	DC 6-24 V
Dimension	125.5 × 101.4 × 27.5 mm
Net Weight	310 g
Gross Weight	995 g

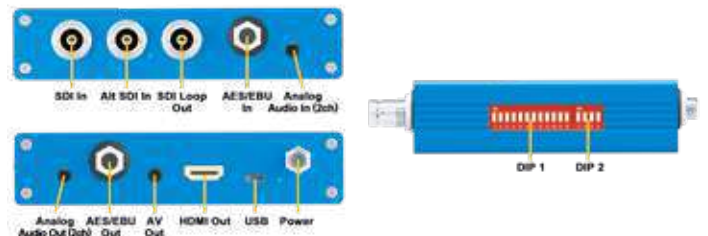
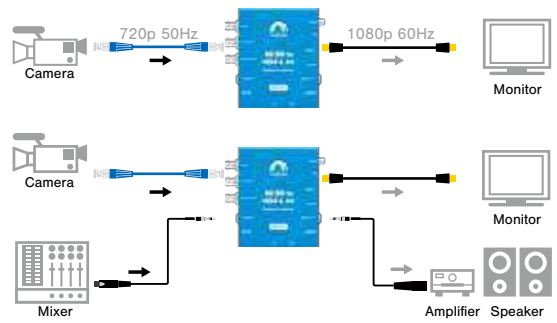

**CB-2022**  
HDMI & AV to 3G-SDI Scaling Converter

**Key Features and Benefits**

- Up/down scaling and frame rate conversion
- AES/EBU or Analog Audio Embedding & De-embedding
- Input signal automatic detection and configuration
- LED indicators for power and signal lock



**Specifications**

Model	CB-2022
Power	Threaded locking connector
Power Consumption	6W (Max)
Voltage Range	DC 6-15 V
Dimension	125.5 × 101.4 × 27.5 mm
Net Weight	310 g
Gross Weight	995 g

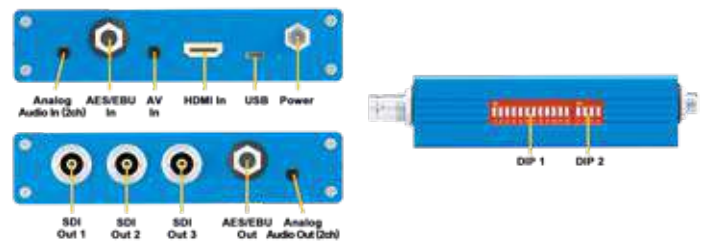
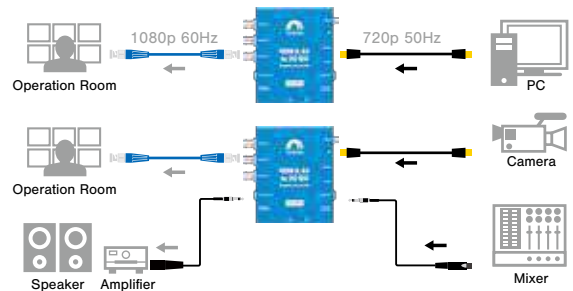

# Video Converters

CanaBridge

## 3G-SDI Solutions

### CB-8010

3G-SDI 1 × 4 Distribution Amplifier

#### Key Features and Benefits

- Automatically detects SD, HD and 3G-SDI
- 4 buffered and re-clocked outputs
- 3G/HD/SD-SDI multi-rate signal processing
- Output 2 & 4 support DVB-ASI signal
- Automatic cable equalization and signal retiming



#### Specifications

Model	CB-8010
Power	Micro USB or Threaded locking DC connector
Power Consumption	1.5W (Max)
Voltage Range	USB 5V, DC 5-17 V
Dimension	125.5 × 101.4 × 27.5 mm
Net Weight	310 g
Gross Weight	920 g

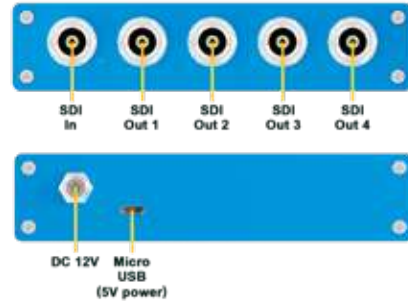
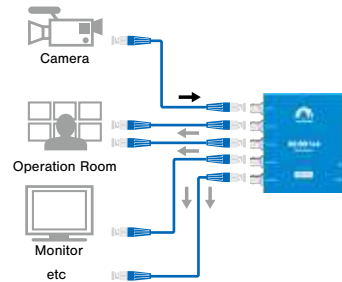

### CB-1010 (TX and RX)

3G-SDI Fiber Optic Extender

#### Key Features and Benefits

- 20km transmission distance
- Support 3Gbit Level A and Level B (all formats)
- SFP/LC Fiber transmitter & receiver
- SDI equalization and re-clocking
- 3G-SDI input & loopout on transmitter

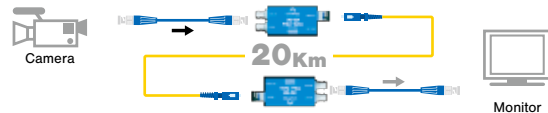

CB-1010-TX

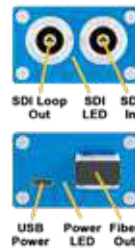

CB-1010-RX

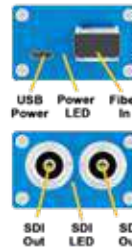

#### Specifications

Model	CB-1010 (TX and RX)
Power	Micro USB
Power Consumption	1.5W (Max)
Voltage Range	USB 3.3-5.5 V
Dimension	72.4 × 41 × 24.6 mm
Net Weight	Transmitter: 115 g, Receiver: 115 g
Gross Weight	750 g



Lifetime Support

CanaBridge 5 Identities Guarantees

5

CanaBridge  
Identities Guarantees





## Headquarters

### Canare Electric Co., Ltd.

5F, LIVMO Rising Bldg., 3-19-1 Shinyokohama, Kohoku-ku,  
Yokohama-shi, Kanagawa, 222-0033 Japan

Phone: +81-45-620-7332

Fax: +81-45-620-7364

[www.canare.co.jp/en/](http://www.canare.co.jp/en/)



## Sales Subsidiaries

### United States

Canare Corporation of America  
45 Commerce Way, Unit C, Totowa, New Jersey, 07512 U.S.A.  
Phone: +1-973-837-0070  
[www.canare.com](http://www.canare.com)

### South Korea

Canare Corporation of Korea  
4F Canare Bldg, 202-21, Heojun-ro, Gangseo-gu, Seoul, 07532 Korea  
Phone: +82-2-2668-2560  
[www.canare.co.kr](http://www.canare.co.kr)

### Taiwan

Canare Corporation of Taiwan  
3F, No.512-7, Yuanshan Road, Zhonghe District, New Taipei City 235, Taiwan R.O.C.  
Phone: +886-2-2222-1010  
[www.canare.com.tw](http://www.canare.com.tw)

### China

Canare Electric Corporation of Tianjin  
Room 1806, Full Tower, 9 Dongsanhuan Middle Road, Chaoyang District, Beijing, 100020 China  
Phone: +86-10-85911490  
[www.canare.com.cn](http://www.canare.com.cn)

### Singapore

Canare Singapore Private Ltd.  
Blk 4012 Ang Mo Kio, Avenue 10, #02-08/09 Techplace 1, 569628 Singapore  
Phone: +65 6293 5692  
[www.canare.com.sg](http://www.canare.com.sg)

### India

Canare Electric India Private Ltd.  
104, 1st Floor, CSC, L-Pocket, Sarita Vihar, New Delhi-110076 Delhi - India  
Phone: +91-11-41052365  
[www.canare.in](http://www.canare.in)

### Germany

Canare Europe GmbH  
Hoffeldstr. 104, Hof 4, 40235 Düsseldorf, Germany  
[www.canare.eu](http://www.canare.eu)  
Phone: +49 211 9173 4503

### UAE

Canare Middle East FZCO  
Bld. No: QD-06 WH/27 Dafza Industrial Park, Dubai, United Arab Emirates  
Phone: +971 43233450  
[www.canare-me.com](http://www.canare-me.com)

