

KD-4X4

HDMI Matrix Switcher capable of switching up to
4 HDMI Sources/Inputs to 4 Independent Zones/Outputs

Set Up Guide



Key Digital® Champion Series™ HDMI® Matrix Switchers are designed and engineered to offer the best in quality, performance, and reliability while providing a cost effective HDMI matrixing solution. KD-4X4 enables any HDMI Source to be viewed on any HDMI Output/Display at any time and in any combination. KD-4X4 maintains crystal-clear, pristine picture and sound quality, while supporting all HD and SD video standards, including 1080p/60 and 3D, and is switchable via pushbutton, IR, and RS-232 control.

Key digital®

The Experts in Digital Video Technology and Solutions™

Key Digital®, led by digital video pioneer Mike Tsinberg, develops and manufactures high quality, cutting-edge technology solutions for virtually all applications where high quality video imaging is important. Key Digital® is at the forefront of the video industry for Home Theater Retailers, Custom Installers, System Integrators, Broadcasters, Manufacturers, and Consumers.



521 East 3rd Street, Mount Vernon, NY 10553
Phone :: 914.667.9700 Fax :: 914.668.8666
Web :: www.keydigital.com

HDMI®
HIGH-DEFINITION MULTIMEDIA INTERFACE

CE FC ROHS COMPLIANT WEEE COMPLIANT

Key digital®

The Experts in Digital Video Technology and Solutions™

Table of Contents

About KD-4X4	2
Connections, Buttons and LEDs	4
Application Example	6
Quick Setup Guide	7
Settings	7
Remote Control	8
RS-232 Commands	8
Specifications	10
Important Product Warnings & Safety Instructions	12
How to Contact Key Digital®	13
Warranty Information	13



About KD-4X4

Description

- › KD-4X4 is an HDMI Matrix switcher capable of switching 4 independent Sources/Inputs to 4 independent Zones/Outputs

Key Features

- › Internal EDID Library features 9 default EDID configurations, in addition to native EDID data for any Output/Display
- › Supports all SD, HD, and VESA (VGA, SVGA, XGA, WXGA, SXGA, UXGA) resolutions up to 1080p (60Hz & 50Hz)
 - › **SD & HD:** 480i, 480p, 720p, 1080i, 1080p
 - › **VESA / VGA (RGBHV):** From 640x480p up to 1920x1200p
- › Full support for HDMI® 1.4 Features: **3D Ready, 4K Resolution Support, HDMI 1.3a/b, 12-bit Deep Color and HDCP**
- › Supports lossless compressed digital audio:
 - › Dolby® TrueHD, Dolby® Digital Plus and DTS™-HD Master Audio



Key Benefits

- › Key Digital's Buffered Matrix Technology™ allows up to 4 HDMI sources to be independently switched to 4 Displays or Zones at any time and in any combination
- › LED Link Lights indicate connectivity between KD-4X4 and each input & output device
- › Serial IR, Optical IR, Front Panel & RS-232 control
- › Supports major control systems such as AMX®, Control4®, Crestron®, RTI®, Universal®
- › Rack Mountable (1U) with included rack ears

Accessories

- › (1) External 12 Volt 2 Amp power supply (110V-240V 50/60Hz)
- › (1) IR Remote Control with batteries
- › (1 pair) Rack mounting ears
- › (8) HDMI Clips
- › Setup Guide
- › Warranty Card

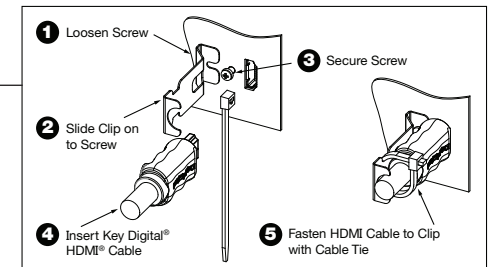

Mounting:

- › Rack mount: Secure the rack ears to each side of the KD-4X4 with the supplied hardware. Then, fasten the unit to the rack rails with the included machine screws.

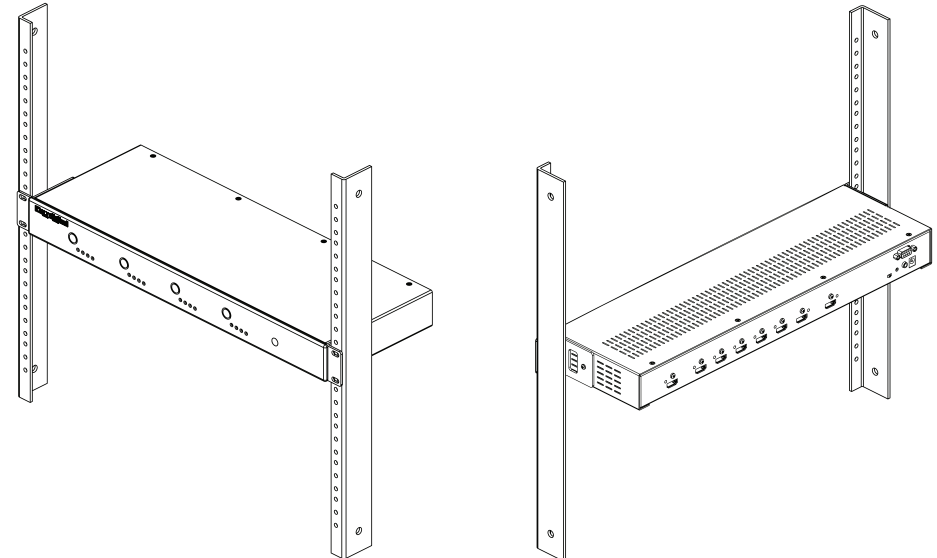

Connections, Buttons and LEDs

Rear Panel Connections:

All connections to the KD-4X4 are found on the rear panel of the unit. Refer to the illustrations below for port assignments while making connections

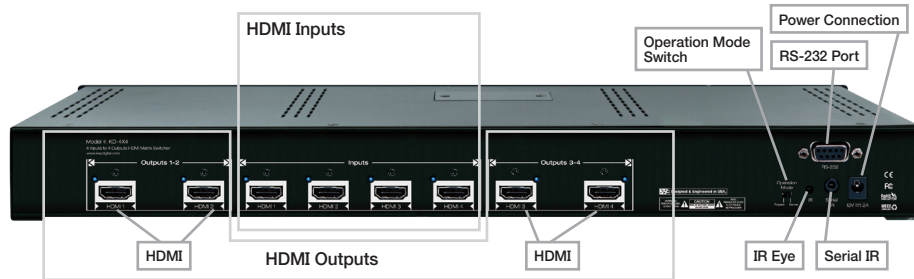

Connections

› **HDMI Inputs:** The 4 HDMI Inputs are located in the center of the back panel. The Inputs have a blue LED which will light when a source is connected and synced.



› **HDMI Outputs:** There are 4 HDMI Outputs in pairs located on either side of the HDMI Inputs. The Outputs have a blue LED which will light when a output device is connected and synced.

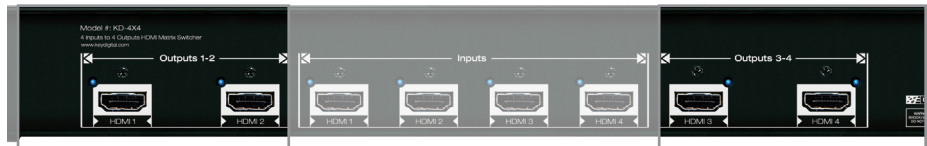

› The **RS-232, Serial IR, Optical IR Sensor, Operation Mode Switch** and **Power connections** are located on the right side of the back panel. The Operation Mode switch is used to update the unit's firmware which is done using the DB9/RS-232 port. The firmware version as well as all RS-232 commands is available through the RS-232 command 'H'. A detailed list of RS-232 commands is available later in this guide.

› If newer firmware is made available, complete updating instructions will be included with it. Check the Key Digital website for any firmware updates.



Front Panel Buttons and LED's:



- › There are 4 Output buttons along the front panel.
- › Each press of an Output button cycles through each of the 4 Inputs.
- › A blue LED will indicate which Input has been selected for each Output button.
- › There is also an Optical IR window located on the right side of the front panel for the remote control signals.

Application Example

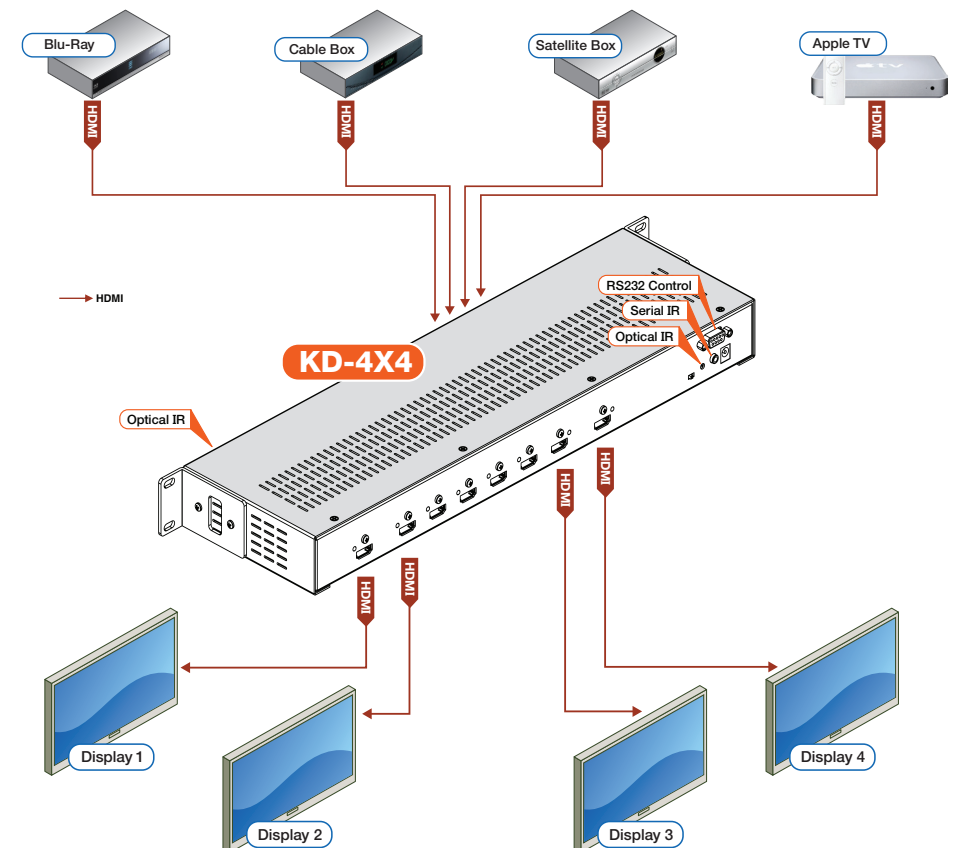

Quick Setup Guide:

1. Begin with the KD-4X4 and all input/output devices turned off and power cables removed.
2. Connect HDMI sources to the appropriate input ports on the KD-4X4.
3. Connect HDMI outputs to the appropriate output device (display, projector, AV Receiver, etc).
4. Connect power to the KD-4X4 as well as to all other input and output devices and turn them on.
5. Operate the KD-4X4 switcher via front panel buttons, IR Remote, Serial IR or RS-232 control.

Operation:

After performing the setup above, the unit is ready for operation.

There are several options for controlling the unit. Commands can be issued via IR remote control, RS-232 or by using the front panel buttons. Note that the advanced commands are available only via the RS-232 protocol.

Settings

The KD-4X4 features a library of 9 internal EDID (Extended Display Identification Data) files, in addition to allowing any Input source to receive a copy of the EDID information of any selected Output connected via HDMI. The default EDID setting is "01" – 1080i w/ PCM 2ch Digital Audio. Changing to EDID settings may be necessary when connecting to or from an AV Receiver, or for passing 3D content derived from a Cable or Satellite source if the default EDID has problems. They can also speed up the switching process with cable or satellite sources.

The possible EDID settings can range from '01' to '09'. ('01' is the default).

01	1080i w/ PCM 2ch Digital Audio	06	3D w/ Dolby Audio
02	1080i w/ HD Audio	07	3D w/ HD Audio
03	1080p w/ PCM 2ch Digital Audio	08	DVI VESA 1280x1024
04	1080p w/ HD Audio	09	DVI VESA 1920x1200
05	3D w/ PCM 2ch Digital Audio		

When selecting an EDID from the library (settings 01-09), your source device will "see" the KD-4X4 EDID choice instead of the displays EDID, over riding the displays own EDID information.

If your display is not capable of accepting the video resolution or audio type selected, you may not see a picture or sound. In this case please choose another more compatible EDID, or use the default EDID.

EDID settings can only be changed through the RS-232 command protocol. See the RS-232 command section below for a list of EDID commands available.

Remote Control

You may control the KD-4X4 switching commands by using the supplied IR Remote control. There are 4 groups of controls, one group for each Output. Each Input can be selected by pressing the Input numbers 1-4.

IR Extender:

You may want to use an IR extender, such as the KD-IRKIT300: Front and Rear panel sensors are available for use with the IR extender. A wired IR serial connector is also provided at the rear of the unit.

Wired IR Extender KD-IRB3099 Unit included in the KD-IRKIT300 uses a 3.5mm male-to-male Mono cable.

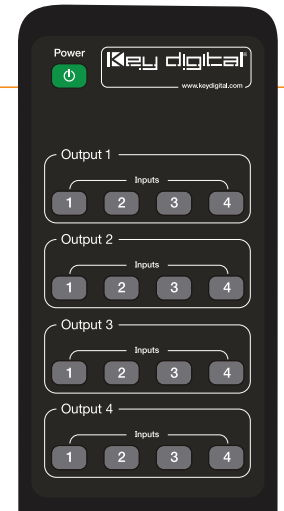
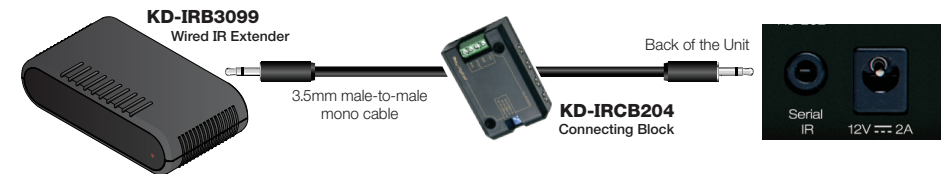

RS-232 Commands:

The KD-4X4 provides access to all functions when used with an RS-232 control system.

The connection protocol is as follows:

- » Baud rate: 57,600
- » Data Bits: 8
- » Parity: None
- » Stop Bits: 1
- » Flow Control: None
- » Carriage Return: Required
- » Line Feed: Required

RS-232 cable pin out

Pin 5 – Ground

Pin 3 – Receive

Pin 2 – Transmit

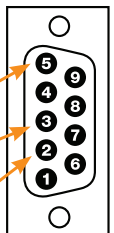

NOTE: All commands are case-insensitive. Spaces are shown for clarity; all commands should not have any spaces. Every command below requires a carriage return at the end of the string for the command to be executed. If a new line character is received, a prompt should be sent back.

System Commands:

- › **H:** **Help** - Help command. List of all RS-232 commands and Firmware version.
- › **STA:** **Status Command** - Displays unit status for all internal variables such as Video Input, and EDID selected for each Input.
- › **PF:** **Power Off** - Power Off command
- › **PN:** **Power ON** - Power ON command

Commands:

Video Switch:

- › **'SP O xx SI yy'** To switch the desired Video Input to the desired Output:
- › Where xx = the Output number [01-04] –OR- [A] for 'All'
- › Where yy = the Input number [01-04] –OR- [U, D] for 'Up,' Down' respectively.
- › 'U/D' will increase/decrease the input number from its current position.
- › This command will switch Inputs to your desired Output.
- › *Example:* To switch Input 3 to Output 1, issue the command; **'SPO01SI03'**
- › *Example:* To incrementally switch the Input Up from its present number for Output 1, issue the command: **'SPO01SIU'**
- › *Example:* To switch All Outputs to Input 3, issue the command: **'SPOASI03'**

EDID Copy and Default EDID Library:

- › **'SP C EDID xx H/D yy'**: To Copy EDID to Input from HDMI Output, or from a Default Library
- › Where xx = Input numbers [01=04] –OR- [A] for 'All' Inputs
- › Where H = EDID Copy from HDMI Output
- › Where D = Default EDID Library selection (see list below)
- › Where yy = Output numbers [01-04] when 'H' variable is selected –OR- Default EDID library settings [01-09] when 'D' variable is selected.
- › This command will either copy the EDID information from a selected Output to a specific Input (or All Inputs), or, write EDID information from an internal library of default EDID settings to a specific Input (or All Inputs).
- › *Example:* To copy the EDID information from HDMI Output 2 to Input 4, issue the command: **'SPCEDID04H02'**
- › *Example:* To write the EDID information from the built-in default EDID library using default EDID 1 to Input 2, issue the command; **'SPCEDID02D01'**
- › **Below are listed the Default EDID Library selections 01-09:**

01	1080i w/ PCM 2ch Digital Audio	06	3D w/ Dolby Audio
02	1080i w/ HD Audio	07	3D w/ HD Audio
03	1080p w/ PCM 2ch Digital Audio	08	DVI VESA 1280x1024
04	1080p w/ HD Audio	09	DVI VESA 1920x1200
05	3D w/ PCM 2ch Digital Audio		

Front Panel Buttons Enabled/Disabled:

- › **'SP C FB E/D'**
- › Where 'E' will Enable the front panel buttons and 'D' will Disable the front panel buttons.
- › *Example:* To Disable the front panel buttons, issue the command; **'SPCFBD'**

Reset to Factory Defaults:

- › **'SP C DF xx'**
- › Where 'xx' = [01-09] and is the default EDID library loaded during a factory reset.
- › This command will return the unit to its factory default settings including a user chosen default EDID setting. (See above for a list of possible default EDID library settings available)
- › *Example:* To reset the unit to factory default with an EDID setting of 1080i 2CH PCM, issue the command; **'SPCDF01'**
- › *Example:* To reset the unit to factory default with an EDID setting of 3D 1080p 2CH PCM, issue the command; **'SPCDF07'**

Specifications

Technical:

- › **Input (Each):** 1 HDMI Connector, Type A, 19 Pin Female
- › **Output (Each):** 1 HDMI Connector, Type A, 19 Pin Female
- › **Bandwidth:** TMDS bandwidth 10.2 Gb/s
- › **Control:** Front panel push buttons and LED's; IR sensor front/rear; RS-232 Tx/Rx lines with full bi-directional operation
- › **Video/Audio Matrix Switching:** Full matrix switching for HDMI Video & Audio, DVI Video
- › **Deep Color Support:** Supports digital video formats in Deep Color Mode at up to 10 bits/ color with all HDMI and HDCP technologies
- › **HDMI® and HDCP Licensing:** Fully licensed and compatible with all HDMI and HDCP technologies
- › **Compliance with HDMI Standards:** Supports 3D, 4K HDMI 1.4 features, HDMI 1.3a/b, HDMI 1.2, HDMI 1.1, DVI 1.1, and HDCP
- › **Link:** Single Link
- › **EDID Control:** Each input EDID is either a choice of any of the active zone displays connected via HDMI to the outputs or from internal library of 9 default EDID's
- › **Lossless Compressed Digital Audio:** Support lossless compressed digital audio: Dolby® TrueHD, Dolby® Digital Plus and DTS™-HD Master Audio
- › **DDC Signal (Data):** Input DDC Signal: 5 Volts p-p (TTL)
- › **HDMI Video/Audio Signal:** Input Video Signal: 1.2 Volts p-p
- › **DDC Communication:** EDID and HDCP Bi-directional Transparency from Display to Source
- › **Wired IR:** modulated IR signal input, 0-5V TTL or -10to +10V.
- › **Power:** External Power Supply. 12V/2A

General:

- » **Regulation:** CE, FCC, RoHS, WEEE
- » **Rack Mount:** 1U, Full Rack Width (rack ears included)
- » **Enclosure:** Black Metal
- » **Product Dimensions:** 17.125" W x 5.50" D x 1.75" H
- » **Shipping Dimensions:** 26" W x 12.6" D x 7.28" H
- » **Product Weight:** 4.05 lb.
- » **Shipping Weight:** 6 lb



Important Product Warnings:

1. Connect all cables before providing power to the unit.
2. Test for proper operation before securing unit behind walls or in hard to access spaces.
3. If installing the unit into wall or mounting bracket into sheet-rock, provide proper screw support with bolts or sheet-rock anchors.
4. Do not bind or group any power or electrical wiring/cables with system's input or output cables.
5. Any connections or disconnections should be made while the unit is powered off.



Safety Instructions.

Please be sure to follow these instructions for safe operation of your unit.

1. Read and follow all instructions.
2. Heed all warnings.
3. Do not use this device near water.
4. Clean only with dry cloth.
5. Install in accordance with the manufacturer's instructions.
6. Do not install near any heat sources such as radiators, heat registers, stoves, or other apparatus (including amplifiers) that produce heat.
7. Only use attachments/accessories specified by the manufacturer.
8. Refer all servicing to qualified service personnel. Servicing is required when the device has been damaged in any way including:
 - » Damage to the power supply or power plug
 - » Exposure to rain or moisture



You **MUST** use the Power Supply provided with your unit or you **VOID** the Key Digital® Warranty and risk damage to your unit and associated equipment.

How to Contact Key Digital®

System Design Group (SDG)

For system design questions please contact us at:

- » Phone: 914-667-9700
- » E-mail: sdg@keydigital.com

Technical Support

For technical questions about using Key Digital® products, please contact us at:

- » Phone: 914-667-9700
- » E-mail: tech@keydigital.com

Repairs and Warranty Service

Should your product require warranty service or repair, please obtain a Key Digital® Return Material Authorization (RMA) number by contacting us at:

- » Phone: 914-667-9700
- » E-mail: rma@keydigital.com

Feedback

Please email any comments/questions about the manual to:

- » E-mail: customersupport@keydigital.com

Warranty Information

All Key Digital® products are built to high manufacturing standards and should provide years of trouble-free operation. They are backed by a limited two-year parts and labor warranty.