



Multi Split Systems



Why Choose Mitsubishi Electric?

Whether it's consistent heating and cooling for the home or office, Mitsubishi Electric offers you state-of-the-art technology that is quiet, simple to use, reliable and above all energy efficient.

Mitsubishi Electric Inverter Multi-Split Systems fulfill the air conditioning needs of up to 8 rooms with a single outdoor unit. Perfect for apartments and two-storey homes.

MITSUBISHI ELECTRIC

Space Savings

The Mitsubishi Electric Inverter Multi-split System is designed to allow several indoor units to be connected to a single outdoor unit. This enhances exterior aesthetics by reducing the number of outdoor units necessary, while also providing an easy and economical way of adding indoor units at any time.

Flexible Choice

Offering the ability to select up to 8 indoor units for a single outdoor unit, with the cooling capacities of outdoor units ranging from 5.2 to 15.5kW and an array of different models to suit specific applications. You will be hard pressed to find a better match for your building dimensions and comfort requirements.

Quiet Control

Comfort without the noise, based on smooth operation and innovative features such as automatic selection of low-noise mode when operation load is low. Choose a wall-mounted model to create a comfortable space where noise levels are at a level where soothing peace and quiet can be enjoyed.

Economical Operation

Efficient operation is achieved through heating/cooling only the desired space, cutting waste by preventing air conditioning of areas where it's not needed. Using an individual air conditioner for each required space allows more economical performance. Combining this concept with the latest innovative inverter technologies, we are able to offer industry-leading levels of energy-efficient operation for both heating and cooling.



Contents

Comfortable and energy-efficient	4
A single outdoor unit for up to 8 rooms	5
Inverter Technologies Selection	6
Indoor Unit Compatability	8
Indoor Unit Line-up	9
FH Series	10
EF Series	12
GE Series	13
MFZ Series	14
SLZ Series	15
PLA Series	16
SEZ Series	17
PEAD Series	18
PLA-KA Series	19
MXZ Series	20
Branch Box Features	21
Controls	22
Wi-Fi	23
Feature Glossary	24
Specifications	26

Comfortable and Energy-efficient

MXZ-6D120VA

An Ideal Match for Apartments

The air conditioning needs of an entire house or apartment (up to 6 rooms) can be met with one compact single-fan outdoor unit.



Optimum Comfort for up to 6 rooms with a Single Outdoor Unit

In addition to fitting into the same installation space as the MXZ-4C80 and MXZ-5D100 outdoor units, this powerful unit can manage the cooling/heating requirements of up to 6 rooms. The utilisation of a single fan has reduced constraints related to unit height as well. An improved cooling capacity of up to 13.5kW (MAX) makes it possible to accommodate diverse installation requests.

Significant Energy Savings

Cutting-edge inverter technologies achieve an impressively high Annual Energy Efficiency Ratio (AEER) of 3.18 and Annual Coefficient of Performance (ACOP) of 3.45.

Smaller MXZ with 2, 3, 4, 5 or 6 ports

(example of MXZ-6D120VA system)

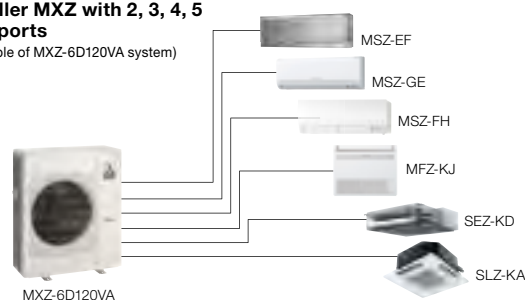

MXZ-6D120VA

Smaller MXZ with 2, 3, 4, 5 or 6 ports (example of MXZ-6D120VA system)

A single outdoor unit for up to 8 rooms

MXZ-8B160VA

Mitsubishi Electric's best Solution for Two Storey Homes

Powerful yet quiet, the new Power Multi is specially designed for use in typical Australian houses. Connecting with a 10kW indoor unit allows you to create an ideal environment in first floor, while you can stop operation in ground floor. Cool & heat in only necessary space to make your life much smarter than ever.

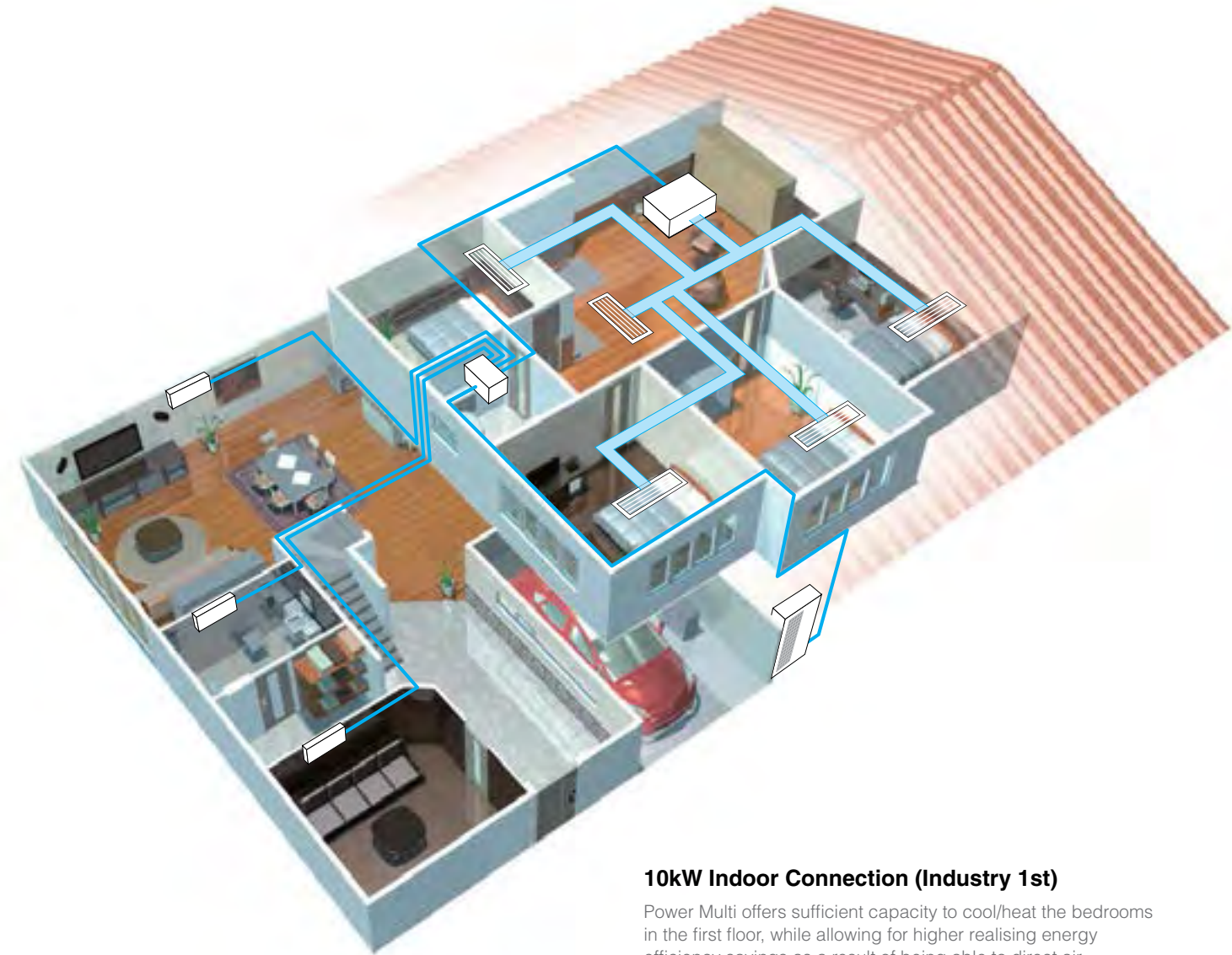

10kW Indoor Connection (Industry 1st)

Power Multi offers sufficient capacity to cool/heat the bedrooms in the first floor, while allowing for higher realising energy efficiency savings as a result of being able to direct air conditioning to only where it is needed. It is the perfect solution for the comfort needs in typical Australian houses.

Significant Energy Savings

The Power Multi System is equipped with Mitsubishi Electric's cutting-edge inverter technologies, achieving an impressively high Annual Energy Efficiency Ratio (AEER) of 3.06 and Annual Coefficient of Performance (ACOP) of 3.45.

*Only PLA-RP100BA and PEAD-RP100JAA

Power Multi MXZ-8B160VA

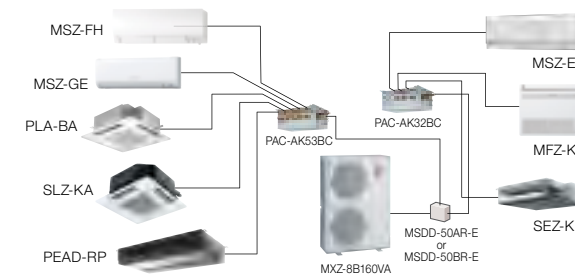

Power Multi MXZ-8B160VA

Inverter Technologies

Mitsubishi Electric inverters ensure superior performance including the optimum control of operation frequency. As a result, optimum power is applied in all cooling/heating ranges and maximum comfort is achieved while being energy efficient.

That's the Mitsubishi Electric promise.

Inverters - How do they work?

Inverters electronically control the electrical voltage, current and frequency of electrical devices such as the compressor motor in an air conditioner. They receive information from sensors monitoring operating conditions, and adjust the revolution speed of the compressor, which directly regulates air conditioner output. Optimum control of operation frequency results in energy efficiency and providing the most comfortable room environment.

Economic Operation

Impressively low operating cost is a key advantage of inverter air conditioners. We've combined advanced inverter technologies with cutting-edge electronics and mechanical technologies to achieve a synergistic effect that enables improvements in cooling/heating performance efficiency. Better performance and energy efficiency are the result.

True Comfort

Simple comparison of air conditioner operation control with and without an inverter.

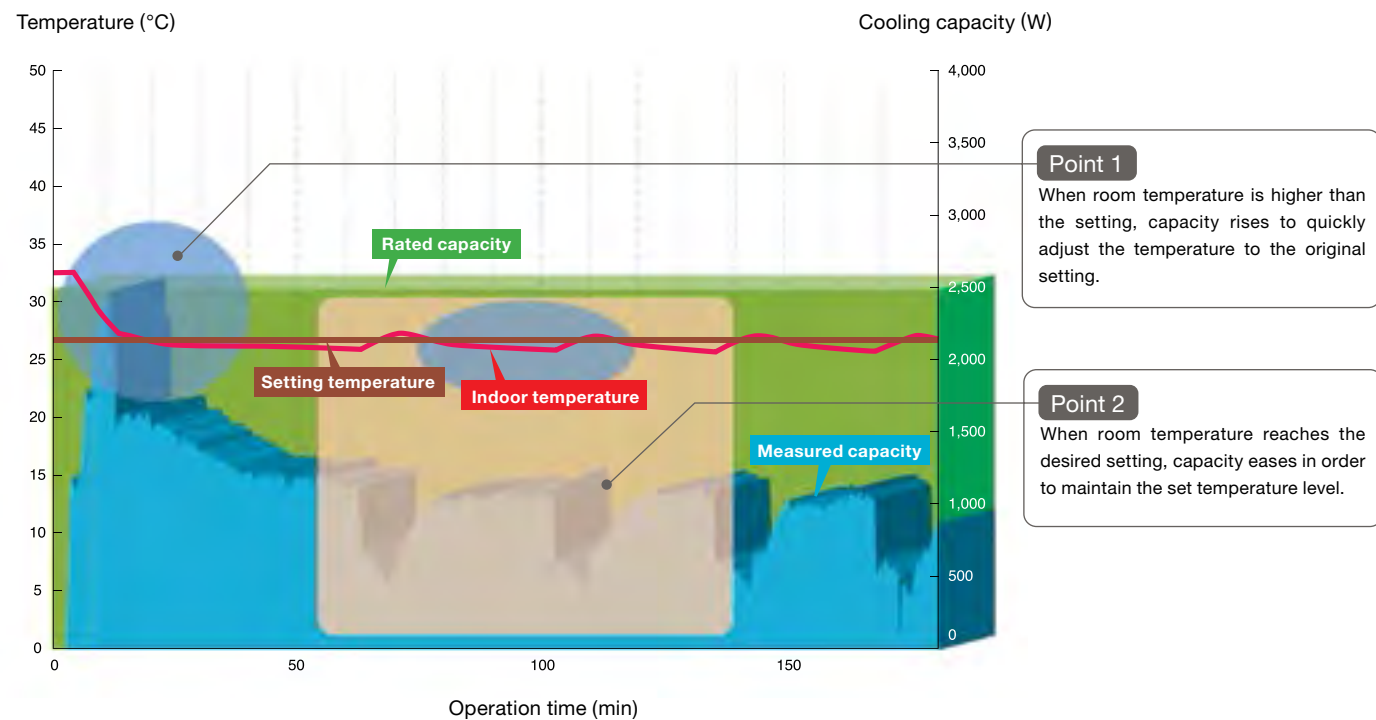

Point 1: Quick and Powerful

Increasing the compressor motor speed by controlling the operation frequency ensures powerful output at start-up and brings the room temperature to the comfort zone faster than units not equipped with an inverter. Hot rooms are cooled, and cold rooms are heated faster and more efficiently.

Point 2: Room Temperature Maintenance

The compressor motor operating frequency and the change of room temperature are monitored to calculate the most efficient waveform to maintain the room temperature in the comfort zone. This eliminates the large temperature swings common with non-inverter systems, and guarantees a pleasant, comfortable environment.

MORE ADVANTAGES WITH MITSUBISHI ELECTRIC

Reluctance DC Rotary Compressor

Powerful neodymium magnets are used in the rotor of the reluctance DC motor. More efficient operation is realised by strong magnetic and reluctance torques produced by the magnets.

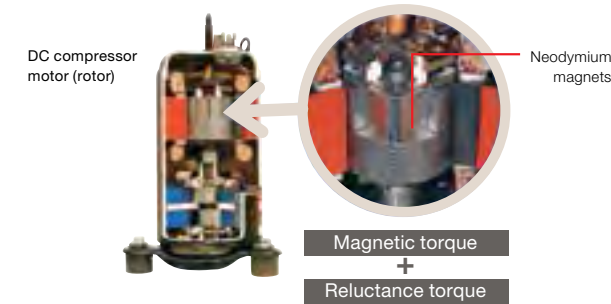

Highly Efficient DC Scroll Compressor

Higher efficiency has been achieved by adding a frame compliance mechanism to the DC scroll compressor. The mechanism allows movement in the axial direction of the frame supporting the cradle scroll, thereby greatly reducing leakage and friction loss, and ensuring extremely high efficiency at all speeds.

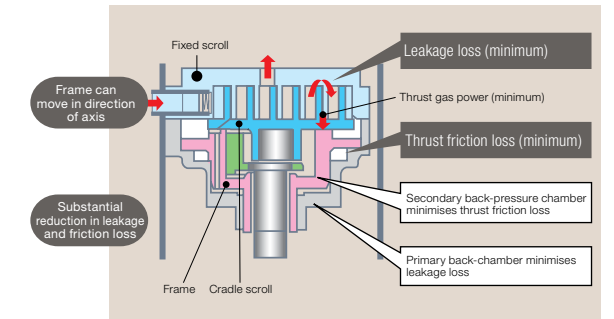

Power Receiver and Twin LEV Control

Mitsubishi Electric has developed a power receiver and twin linear expansion valves (LEV) circuit that optimise compressor performance. This technology ensures optimum control in response to operating waveform and outdoor temperature. Operating efficiency has been enhanced by tailoring the system to the characteristics of R410A refrigerant.

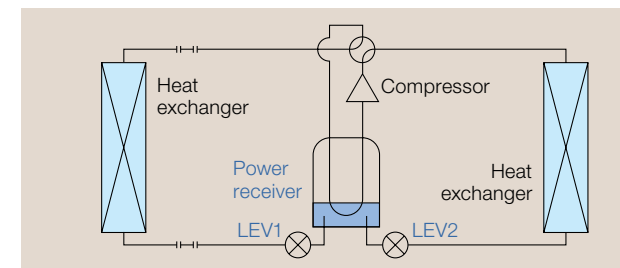

Grooved Piping

High-performance grooved piping is used in heat exchangers to increase the heat exchanging area.

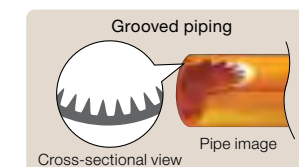

Vector Wave ECO Inverter

This inverter monitors the varying compressor motor frequency and creates the most efficient waveform for the motor speed. As a result, operating efficiency in all speed ranges is improved, less power is used and energy consumption reduced.

Smooth wave pattern

Inverter size has been reduced using insert-molding, where the circuit pattern is molded into the synthetic resin. To ensure quiet operation, soft PWM control is used to prevent the metallic whine associated with conventional inverters.

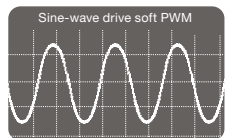

DC Fan Motor

A highly efficient DC motor drives the fan of the outdoor unit. Efficiency is much higher than an equivalent AC motor.

Selection

STEP 1		SELECT INDOOR UNITS		
Select the indoor unit to be installed in each room.				
Wall-mounted	Floor-standing	4-way ceiling cassette	Ceiling suspended	Ceiling concealed
 MSZ-FH  MSZ-EF  MSZ-GE  MSZ-GE	 MFZ-KJ*	 SLZ-KA  PLA-RP	 PCA-KA	 PEAD-RP  SEZ-KD

* When MFZ-KJ indoor unit(s) is connected to MXZ, please refer to the note on page 31.

STEP 2		SELECT OUTDOOR UNITS		
Select the best outdoor unit based on the number of indoor units and overall system capacity required.				
2-port Connect up to 2 indoor units	3-port Connect up to 3 indoor units	4-port Connect up to 4 indoor units	8-port Connect up to 8 indoor units*	
 MXZ-2D52VA	 MXZ-3D54VA	 MXZ-4D71VA	 Outdoor Unit MXZ-8B140VA MXZ-8B160VA	
 MXZ-5D100VA	 MXZ-2D120VA	 MXZ-4D80VA	 Branch Boxes PAC-AK32BC PAC-AK53BC	

* Connection to indoor units requires an appropriate branch box (distribution piping is required when connecting two branch boxes).

STEP 3		CHECK SYSTEM COMPATABILITY	
Possible combinations depends on the outdoor unit chosen. Please check the following points.			
CHECK INDOOR UNITS Refer to the Indoor Unit Compatibility Table to check if the indoor units selected can be used with the outdoor unit selected. (Indoor units not listed in the table cannot be used.)		CHECK INDOOR UNITS CAPACITY COMBINATION Refer to the Combination Table on the website to check if the capacity combination of the indoor unit selected is connectable. (Combinations not listed cannot be connected.)	
If the desired combination cannot be found, please change either the indoor or outdoor unit to match one of the combinations shown in the tables.			

Indoor Unit Compatibility

SELECT FROM A WIDE RANGE OF STYLISH INDOOR UNITS

For an attractive installation and optimum use of indoor space, choose the system that best matches your needs from 35 models of 5 types including wall-mounted, floor-standing, ceiling-concealed, 4-way ceiling-cassette and ceiling-suspended units.

Refer to the following table to check if an indoor unit can be used with an outdoor unit. Combinations not listed in the table cannot be used.

Indoor Unit		Outdoor Unit		MXZ-							
		2D52VA	3D54VA	4D71VA	4D80VA	5D100VA	6D120VA	8B140VA	8B160VA		
M SERIES	Wall-mounted	MSZ-FH25VA	✓	✓	✓	✓	✓	✓	✓	✓	✓
		MSZ-FH35VA	✓	✓	✓	✓	✓	✓	✓	✓	✓
		MSZ-FH50VA		✓	✓	✓	✓	✓	✓	✓	✓
		MSZ-EF22VE	✓	✓	✓	✓	✓	✓	✓	✓	✓
		MSZ-EF25VE	✓	✓	✓	✓	✓	✓	✓	✓	✓
		MSZ-EF35VE	✓	✓	✓	✓	✓	✓	✓	✓	✓
		MSZ-EF42VE	✓	✓	✓	✓	✓	✓	✓	✓	✓
		MSZ-EF50VE	✓	✓	✓	✓	✓	✓	✓	✓	✓
		MSZ-GE22VAD	✓	✓	✓	✓	✓	✓	✓	✓	✓
		MSZ-GE25VAD	✓	✓	✓	✓	✓	✓	✓	✓	✓
		MSZ-GE35VAD	✓	✓	✓	✓	✓	✓	✓	✓	✓
		MSZ-GE42VAD	✓	✓	✓	✓	✓	✓	✓	✓	✓
		MSZ-GE50VAD	✓	✓	✓	✓	✓	✓	✓	✓	✓
		MSZ-GE60VAD			✓	✓	✓	✓	✓	✓	✓
		MSZ-GE71VAD				✓	✓	✓	✓	✓	✓
MSZ-GE80VAD						✓	✓	✓	✓		
Floor-standing	MFZ-KJ25VE	✓*	✓*	✓*	✓*	✓*	✓*	✓*	✓*	✓*	
	MFZ-KJ35VE	✓*	✓*	✓*	✓*	✓*	✓*	✓*	✓*	✓*	
	MFZ-KJ50VE		✓*	✓*	✓*	✓*	✓*	✓*	✓*	✓*	
S SERIES	4-way Cassette	SLZ-KA25VAQ(L)	✓	✓	✓	✓	✓	✓	✓	✓	
		SLZ-KA35VAQ(L)	✓	✓	✓	✓	✓	✓	✓	✓	
		SLZ-KA50VAQ(L)		✓	✓	✓	✓	✓	✓	✓	
	Ceiling-concealed	SEZ-KD25VAQ(L)	✓	✓	✓	✓	✓	✓	✓	✓	
		SEZ-KD35VAQ(L)	✓	✓	✓	✓	✓	✓	✓	✓	
		SEZ-KD50VAQ(L)		✓	✓	✓	✓	✓	✓	✓	
SEZ-KD60VAQ(L)				✓	✓	✓	✓	✓	✓		
SEZ-KD71VAQ(L)				✓	✓	✓	✓	✓			
P SERIES	4-way Cassette	PLA-RP60BA			✓	✓	✓	✓	✓	✓	
		PLA-RP71BA				✓	✓	✓	✓	✓	
		PLA-RP100BA							✓	✓	
	Ceiling-suspended	PCA-RP50KAQ		✓	✓	✓	✓	✓			
		PCA-RP60KAQ			✓	✓	✓	✓			
		PCA-RP71KAQ				✓	✓	✓			
	Ceiling-concealed	PEAD-RP71JAA				✓	✓	✓	✓	✓	
PEAD-RP100JAA								✓	✓		

*When MFZ-KJ indoor unit(s) is connected to MXZ, please refer to the note on page 31.

Indoor Unit Line-Up

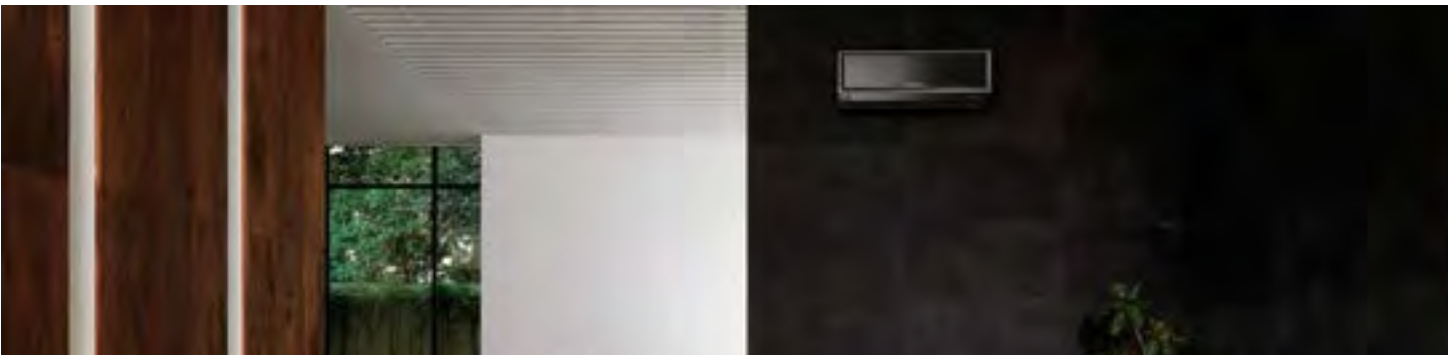

MSZ-FH Series

- Quiet 20dB noise level (FH25)
- Plasma Duo Filter (FH25/35/50)
- 3D i-See Sensor
- Quick Clean body



2.2kW	2.5kW	3.5kW	4.2kW	5.0kW	6.0kW	7.1kW	8.0kW	10.0kW
-	✓	✓	-	✓	-	-	-	-

MSZ-EF Series

Developed to complement modern interior room décor, MSZ-EF Series air conditioners are available in three colours specially chosen to blend in naturally wherever installed. The streamlined wall-mount indoor units have eloquent silver-bevelled edges, expressing sophistication and quality. Elegant, quiet and powerful, these air conditioners are the ideal answer, providing the best match scenario for interior design and maximum room comfort.

- Built-in Weekly Timer
- Appealing design matches any room décor
- Nano Platinum Filter
- Quiet 21dB noise level in 'Quiet Mode' (EF22/25/35)



2.2kW	2.5kW	3.5kW	4.2kW	5.0kW	6.0kW	7.1kW	8.0kW	10.0kW
-	✓	✓	-	✓	-	-	-	-

MSZ-GE Series

- Quiet 19dB noise level (GE22/25/35)
- Nano Platinum Filter (GE60/71/80)
- Built-in Weekly Timer (GE60/71/80)
- Quick Clean body
- Catechin Filter (GE22-50)



2.2kW	2.5kW	3.5kW	4.2kW	5.0kW	6.0kW	7.1kW	8.0kW	10.0kW
-	✓	✓	✓	✓	✓	✓	✓	-

MFZ-KJ Series

- Simple & Flat design
- Nano Platinum Filter
- Built-in Weekly Timer
- Built-in installation capability
- Multi-flow Vane (optimum air distribution)
- Trouble-free installation & maintenance



2.2kW	2.5kW	3.5kW	4.2kW	5.0kW	6.0kW	7.1kW	8.0kW	10.0kW
-	✓	✓	-	✓	✓*	-	-	-

*Single use only

SLZ Series

- Fresh-air intake
- Unit height of only 235mm
- Compact 2'x2' size for ceiling installation



2.2kW	2.5kW	3.5kW	4.2kW	5.0kW	6.0kW	7.1kW	8.0kW	10.0kW
-	✓	✓	-	✓	-	-	-	-

PLA Series

- 72 airflow patterns
- Fresh-air intake
- 3D i-See Sensor (optimal corner panel)
- High/Low ceiling modes



2.2kW	2.5kW	3.5kW	4.2kW	5.0kW	6.0kW	7.1kW	8.0kW	10.0kW
-	-	-	-	-	✓	✓	-	✓

INDUSTRY 1ST
10.0kW Indoor Connection

SEZ Series

- Compact Design
- Unit Height of only 200mm
- Three fan speeds and four static pressure levels

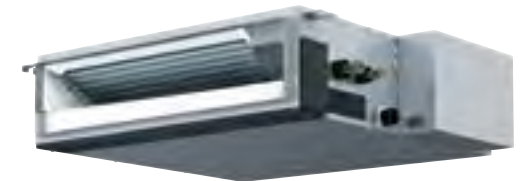

2.2kW	2.5kW	3.5kW	4.2kW	5.0kW	6.0kW	7.1kW	8.0kW	10.0kW
-	✓	✓	-	✓	✓	✓	-	-

PEAD Series

- Compact
- Lighter weight
- 30dB noise level in 'Low Mode' (71)



2.2kW	2.5kW	3.5kW	4.2kW	5.0kW	6.0kW	7.1kW	8.0kW	10.0kW
-	-	-	-	✓	-	✓	-	✓

INDUSTRY 1ST
10.0kW Indoor Connection

PCA-KA Series

- Stylish unit design
- 32dB noise level
- Fresh-air intake
- High/Low ceiling modes



2.2kW	2.5kW	3.5kW	4.2kW	5.0kW	6.0kW	7.1kW	8.0kW	10.0kW
-	-	-	-	✓	✓	✓	-	-

FH Series

The new FH series is the culmination of our air-cleaning, motion-sensor and airflow technologies and represent our efforts to create an air conditioner that put No.1 Priority on healthy living.

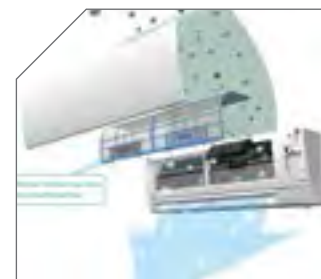

Plasma Filter

The Plasma Filter System is an advanced, multi-stage filtration system designed to effectively neutralise contaminants such as allergens, viruses and bacteria ensuring the circulation of fresh, clean air back into the room.

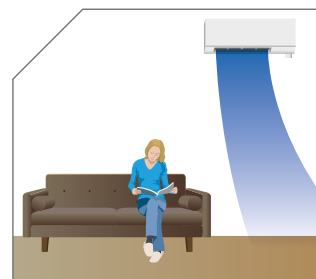

Indirect / Direct Airflow

The indirect airflow setting can be used when the flow of air feels too strong or direct. For example, it can be used during cooling to avert airflow and prevent body temperature from becoming excessively cooled.

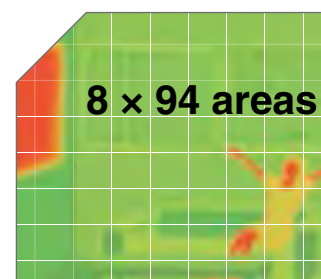

3D i-See Sensor

The FH Series is equipped with 3D i-see Sensor, an infrared-ray sensor that measures the temperature at distant positions. While moving to the left and right, eight vertically arranged sensor elements analyze the room temperature in three dimensions.

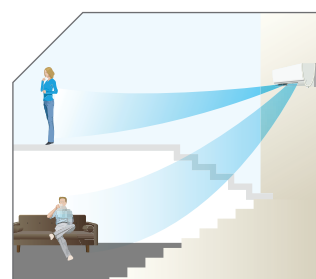

Dual Split Vane Technology

The unique dual split vane design allows airflow to be customised to suit different areas of the room, by independently directing air upwards, downwards or to the side.

FH SERIES FEATURES

- » Absence Detection
- » Econo Cool
- » Auto Vane
- » Anti-Mould Filter
- » Pure White
- » Compact
- » 24 Hour Timer
- » Auto Restart
- » Quick Clean
- » Weekly Timer
- » Natural Flow
- » Operating Temperature
Cooling at -10°C ~ -46°C
Heating at -15°C ~ 24°C
- » Vertical & Horizontal Swing
- » Auto Change Over
- » 3D i-See Sensor
- » Direct/Indirect Airflow

EF Series

The Streamlined wall-mounted indoor units have eloquent beveled edges, expressing sophistication and quality. Available in 3 stylish colours classic white, matte silver and glossy black to provide the best match scenario for diverse interior designs while simultaneously ensuring maximum room and energy savings.



Stylish Design

Developed to complement modern interior room decor, MSZ-EF Series is available in three colours glossy black, matte silver and classic white. Specially chosen to blend in naturally wherever installed.

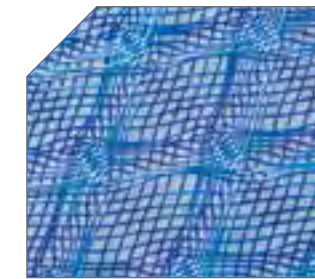

Platinum Filter

The Nano Platinum Deodorising Filter reduces airborne bacteria while improving air quality. The optional Electro Static Anti-Allergy Enzyme Filter effectively combats common allergens.



Quiet Comfort All Day

Mitsubishi Electric's advanced "Quiet Mode" fan speed setting provides super-quiet operation as low as 21dB for 25/ 35 models. This unique feature makes the MSZ-EF series ideal for use a tranquil environment.



Wi-Fi Control

Unlock the door to smarter cooling and heating for total home comfort. You can control and monitor your air conditioner from anywhere anytime via your smartphone, tablet or online account. Additional adapter MAC-558IF-E required per unit.

EF SERIES FEATURES

- » Econo Cool
- » Nano Platinum Filter
- » Auto Restart
- » Electrostatic Anti-Allergy Enzyme Filter
- » 24 Hour Timer
- » Weekly Timer
- » Operating Temperature
Heating at -15°C ~ 24°C
Cooling at -10°C ~ -46°C
- » Self Diagnosis
- » Auto Change Over

GE Series

The MSZ-GE units provide excellent energy-savings and operation is impressively quiet. A vast series line-up is ready to ensure comfortable room environments in response to your air conditioning needs.



Quiet Operation

A "Quiet Mode" setting has been added to the fan speed settings, ensuring super quiet operation below 19dB for model sizes 35 and under. Perfect for the bedroom; it's so quiet you'll check to see if it's on. (models 25/35)



Wi-Fi Control

Unlock the door to smarter cooling and heating for total home comfort. You can control and monitor your air conditioner from anywhere anytime via your smartphone, tablet or online account. Additional adapter MAC-558IF-E required per unit.



Wide & Long Airflow

The wide and long airflow modes allow the airflow direction to be adjusted, ensuring every corner of the room is comfortable. These modes are simply activated at the touch of a button on your remote controller. The long mode extends airflow by 12m to reach even the furthest point of large living rooms or enables kitchens to be reached in an open plan environment. (models 60/71/80)

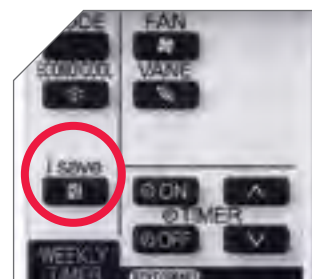

i-Save mode

"i-Save" is a simplified setting function that recalls the preferred (preset) temperature by pressing a single button on the remote controller. Press the same button twice to immediately return to the previous temperature setting. Using this function contributes to energy savings when, for example, leaving the room or going to bed.

GE SERIES FEATURES

- » Potentially Demand Response Capable
- » Econo Cool
- » Nano Platinum Filter
- » Electrostatic Anti-Allergy Filter
- » Auto Vane
- » Vertical Swing
- » Horizontal Swing
- » Wide, Long & Powerful
- » Pure White
- » Auto Change Over
- » Auto Restart
- » Only 19dB (models 22/25/35)
- » 24 Hour Timer
- » Weekly Timer 60/70/80
- » Self Diagnosis
- » Operating Temperature Cooling at -10°C ~ -46°C Heating at -15°C ~ 24°C

MFZ Series

FLOOR STANDING UNIT

High Capacity, Simple, Flat Design in Harmony with Living Spaces Raise the value of your room to the next level.

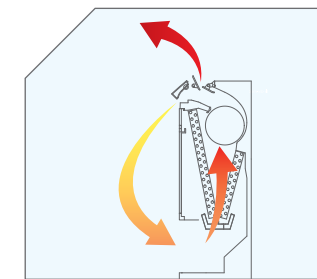

Rapid Heating Technology

MFZ Series ensures the perfect room temperature is reached faster with Rapid Heating Technology. Warm air is blown out in a downward direction and then sucked back into the unit to quickly raise the temperature of the air being blown out.



Slim, Sophisticated Design

Floor Consoles feature a new contemporary sleek design with linear beauty, harmonized with all types of interiors.



Multi Flow Vane

A Powerful blower provides optimum distribution of air from the upper and lower air outlets. The result is a comfortable environment with an even temperature throughout the room. Three uniquely shaped vanes control the airflow and allow the freedom to customize comfort according to preferences.



Wi-Fi Control

Unlock the door to smarter cooling and heating for total home comfort. You can control and monitor your air conditioner from anywhere anytime via your smartphone, tablet or online account. Additional adapter MAC-558IF-E required per unit.

MFZ SERIES FEATURES

- » Only 19dB (KJ 25/35)
- » Econo Cool
- » Anti-Allergy Enzyme (Standard Filter)
- » Horizontal Auto Vane
- » Horizontal Swing
- » Pure White
- » Built-In Weekly Timer
- » 24 Hour Timer
- » Auto Restart
- » Cooling at -10°C~46°C
- » Heating at -15°C~24°C
- » Self Diagnosis
- » Failure Recall
- » Vertical Airflow
- » Easy Installation (with leveling plate)

SLZ Series

CEILING-CASSETTE

Our compact, lightweight ceiling cassette units with 4-way airflow provide maximum comfort by evenly distributing airflow throughout the entire room.



Air Cleaning Filter

This built-in filter removes dust and other particulates, keeping the air purified and deodorised. The long-life filter in SLZ Series air conditioners can be used for approximately 2,500 hours with simple maintenance.



Compact Design

A design that is a perfect match for ceilings made using 2'x2' construction. The 4-way air outlet provides maximum comfort with evenly distributed airflow.

Fresh-Air Intake

A duct hole is provided in the main body, making it possible to intake fresh air from outside.

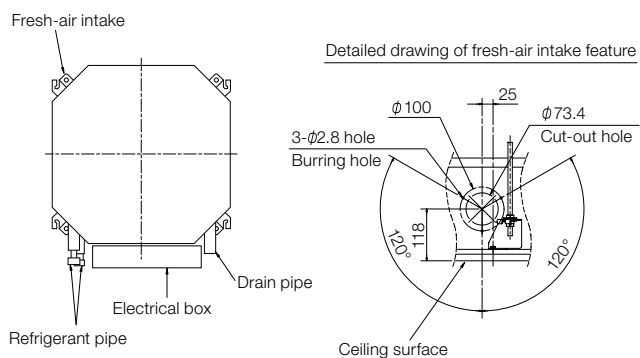

SLZ SERIES FEATURES

- » PAM Control
- » Long Life (2,500 Hour Filter)
- » Fresh Air Intake
- » Pure White
- » Auto Vane
- » Vertical Swing
- » 12 Hour Timer (SLZ-KA VAL)
- » Auto Restart
- » Cooling at -10°~46°C (KA25)
- » Cooling at -15°~43°C (KA50)
- » Heating at -15°~24°C
- » Controller (SLZ-KA VAQ)
- » Weekly Timer (SLZ-KA VAQ) (PAR-31MA)
- » Optional M-NET Connection
- » Optional Wi-Fi Control
- » Self Diagnosis (with wired R/C check code)
- » MXZ Connection
- » Failure Recall

PLA Series

CEILING-CASSETTE

The incorporation of wide air-outlet and the "i-See Sensor" enhances airflow distribution control, achieving an enhanced level of comfort throughout the room. The synergy of higher energy efficiency and more comfortable room environment results in the utmost user satisfaction.



i-see Sensor

A radiation-based sensor to monitor temperature throughout an entire room. When connected to the air conditioner control panel, "i-see Sensor" works to maximise room comfort.

Additional adapter PAC-SA1M8-E required.

Automatic Grille Lowering Function

An automatic grille lowering function is available for easy filter maintenance. The grille can be lowered a maximum of 4m from the ceiling in 8 steps, thus enabling easy cleaning of the air filter.

Additional adapter PLA-6BAJ required.

Optimum Airflow

Optimum airflow settings provide maximum comfort throughout the room.

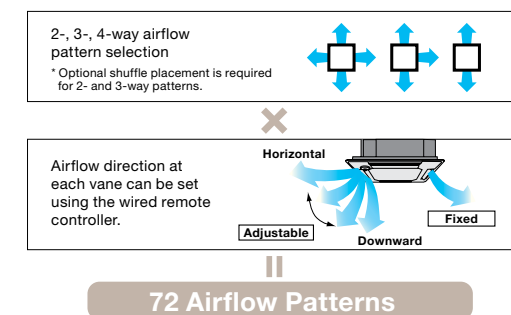

Wide Airflow

Wide-angle outlets distribute airflow to all corners of the room. The outlets are larger than those of previous models and the shape has been improved for better wide-angle ventilation.

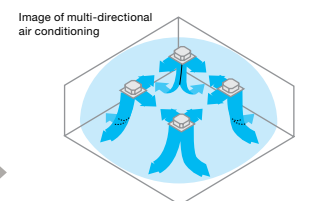
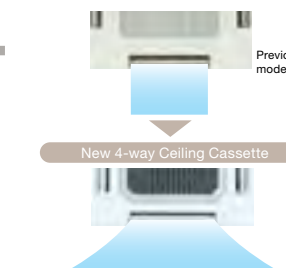

Individual Vane Setting + Wide Airflow

The combination of individual vane setting, which enables the optimal outlet setting for each room layout, and the wide airflow function works to ensure even temperature distribution throughout each room. The result is uniformly comfortable air conditioning.

PLA SERIES FEATURES

- » i-See Sensor Optional
- » Pure White
- » Auto Vane
- » Long Life Filter (2,500 Hour Filter)
- » Filter Check Signal
- » Fresh-air Intake
- » High Efficiency Filter (Optional)
- » Vertical Fin
- » Horizontal Fin
- » High Ceiling Mode
- » Low Ceiling Mode
- » Auto Fan Speed Mode
- » Self Timer
- » Auto Change Over
- » Auto Restart
- » Low Temp Cooling
- » Quiet Operation
- » Group Control (Optional)
- » M-NET Connection (Optional)
- » Wi-Fi Interface (Optional)
- » Cleaning Free pipe reuse
- » Drain Lift Up
- » Flare Connection
- » Self Diagnostic Function
- » Failure Recall Function

SEZ Series

CEILING-CONCEALED

Our concealed-ceiling unit has a reduced installation space height with impressively quiet operation. Comfortable operation for the living room, bedroom and other living spaces.

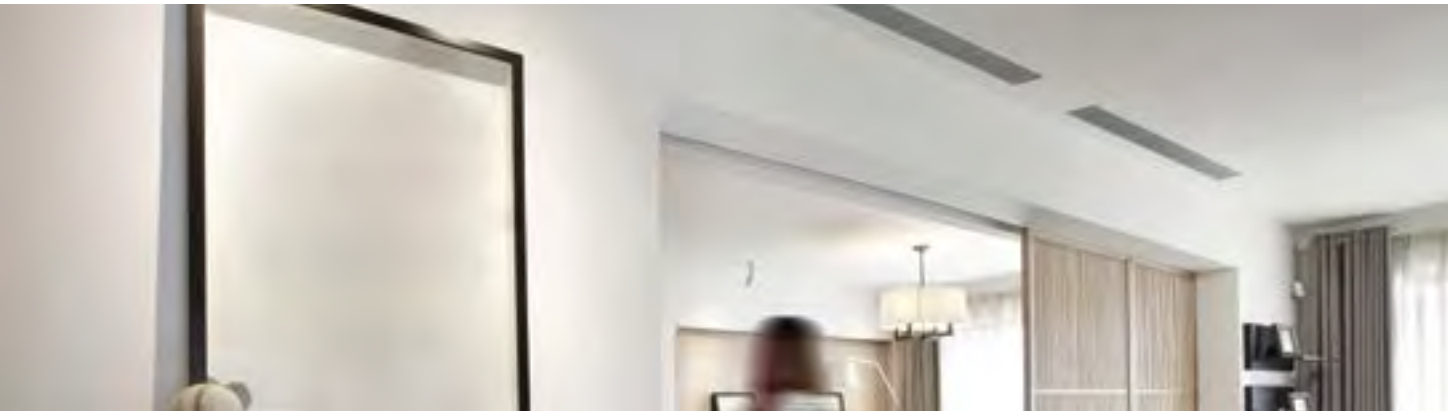

Compact Ceiling-Concealed Units

Only the intake-air grille and outlet vents are visible when using this ceiling-concealed indoor unit. The rest of the unit is conveniently hidden in the ceiling cavity, essentially leaving the ceiling and walls free of bulky looking devices and maintaining a high-class interior décor. The compact units require minimal space and can be installed in buildings with lowered ceilings, where exposed units were the rule in the past.

Dimension Comparison

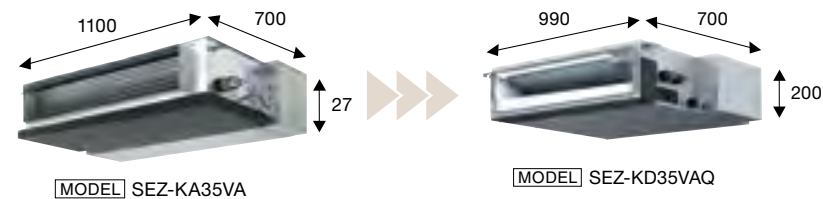

Width reduced by 110mm
Height reduced by 70mm

Increased Selection of Fan Speeds and Static Pressure Levels

DC fan motor settings have been increased to accommodate more application needs. Three fan speed settings (Low, Medium and High) and four static pressure levels (5, 15, 35 and 50Pa) are now available.

previous model	External static pressure
SEZ-KD25-71VA	5/15/35/50Pa
current model	30/50Pa
SEZ-KA35-71VA	

Four Levels Available for All Models

We've lowered the minimum static pressure level, resulting in less room noise when the optimum static pressure is selected.

External static pressure	SPL (low fan mode)	
	SEZ-KD	SEZ-KA
15Pa	23dB	30dB
35 class	30dB	31dB
50 class	30dB	32dB
60 class	30dB	32dB
71 class	30dB	32dB

Maximum Noise Reduced by up to 7dB

SEZ SERIES FEATURES

- » Auto Restart
- » Cooling at -10°~46°C (KA25/35)
- » Cooling at -15°~43°C (KA50)
- » Cooling at -15°~46°C (KA60/71)
- » Heating at -15°~24°C
- » Controller (SEZ-VAQ)
- » Optional Wi-Fi Control
- » Weekly Timer (SEZ-VAQ) (PAR-31MA)
- » Optional M-NET Connection
- » Flare Connection
- » Failure Recall
- » Self Diagnosis (with wired R/C check code)

PEAD Series

CEILING-CONCEALED

For elegance and style, the PEAD Series compliments the room environment with an aesthetically pleasing ceiling installation and high-pressure static fan. Long pipe work installation is supported, increasing freedom in the placement of indoor units.



Compact Indoor Units

The height of the current PEAD models has been unified to 250mm. Compared to the previous models, the height has been reduced by as much as 178mm, making installation possible in low ceilings with minimal clearance space.

Wide Selection of Fan Speeds and External Static Pressure

Five-stage external static pressure conversions and three fan speed selections are available. Capable of being set to a maximum of 125Pa, units are applicable to a wide range of building types.

Freedom in Installation

Versatile and easy installation is possible; for example, it is possible to adjust the distance between the air-intake and air-outlet vents to create the optimal airflow configuration.

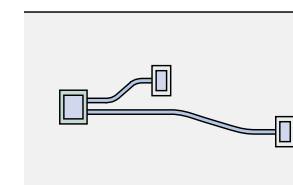

Long rectangular room

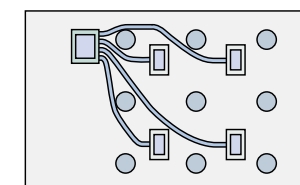

Room with fixed ceiling fixtures

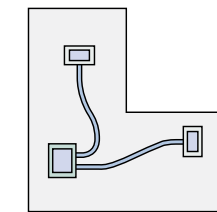

L-shaped room

PEAD SERIES FEATURES

- » Auto Change Over
- » Auto Restart
- » Quiet Operation
- » Group Control (Optional)
- » M-NET Connection (Optional)
- » Wi-Fi Interface (Optional)
- » Cleaning Free pipe reuse
- » Flare Connection
- » Self Diagnostic Function
- » Failure Recall Function

PCA-KA Series

CEILING-SUSPENDED

A stylish indoor unit design and airflow settings for both high and low-ceiling interiors expand installation possibilities. Together with exceptional energy-saving performance, these units are the solution to diversified air conditioning needs.



Equipped with Automatic Air-Speed Adjustment

In addition to the conventional 4-speed setting, units are now equipped with an automatic air-speed adjustment mode. This setting automatically adjusts the air-speed to conditions that match the room environment.

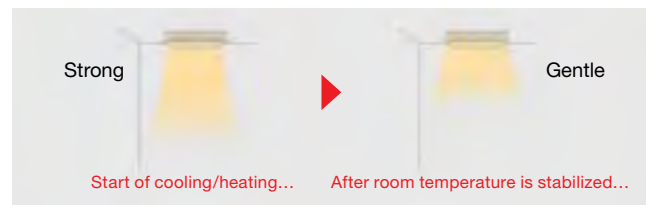

Equipped with High and Low Ceiling Modes

Units are equipped with high and low ceiling operation modes that make it possible to switch the airflow volume to match room height.

Fresh Outside-Air Intake

Units are equipped with a knock-out hole that enables the induction of fresh outside-air.

Class	High ceiling	Standard ceiling	Low ceiling
50	3.5m	2.7m	2.5m
60	3.5m	2.7m	2.5m
71	3.5m	2.7m	2.5m

Outside-air intake characteristics

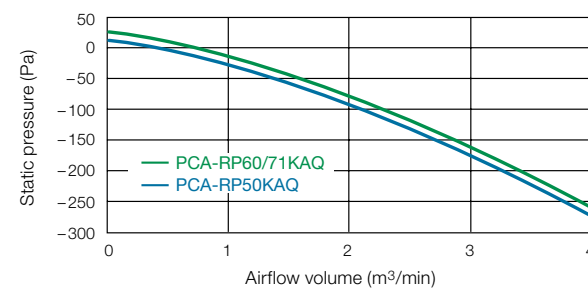

PCA-KA SERIES FEATURES

- » Long Life Filter (2,500 Hour Filter)
- » Filter Check Signal
- » Fresh-air Intake
- » Pure White
- » Auto Vane
- » High Efficiency Filter (Optional)
- » Vertical Fin
- » Horizontal Swing
- » High Ceiling Mode
- » Low Ceiling Mode
- » Auto Fan Speed Mode
- » Auto Change Over
- » Auto Restart
- » Quiet Operation
- » Group Control (Optional)
- » M-NET Connection (Optional)
- » Wi-Fi Interface (Optional)
- » Cleaning Free pipe reuse
- » Drain Lift Up
- » Flare Connection
- » Self Diagnostic Function
- » Failure Recall Function

MXZ Series

A selection of eight MXZ outdoor units with capacities ranging between 5.2 and 15.5kW can be matched with specific M, S and P Series indoor units to handle a variety of building layouts. The best solution for multi-system air conditioning needs.



Operation Lock

To accommodate specific-use applications, cooling or heating operation can be specified when setting the control board of the outdoor unit. A convenient option when a system needs to be configured for exclusive cooling or heating service.

For detailed information about all these functions, refer to the relevant installation manual.

Ampere Limit Adjustment

Dip switch settings can be used to adjust the maximum electrical current for operation. This function is highly recommended for managing energy costs. (For details, refer to the outdoor unit installation manual.)

* Maximum capacity is lowered with the use of this function.

Wiring/Piping Correction Function

Simply press a single button to confirm if piping and wiring are properly connected. Wiring errors are corrected automatically when discovered. This eliminates the need to confirm complicated wiring connections when expanding the system.

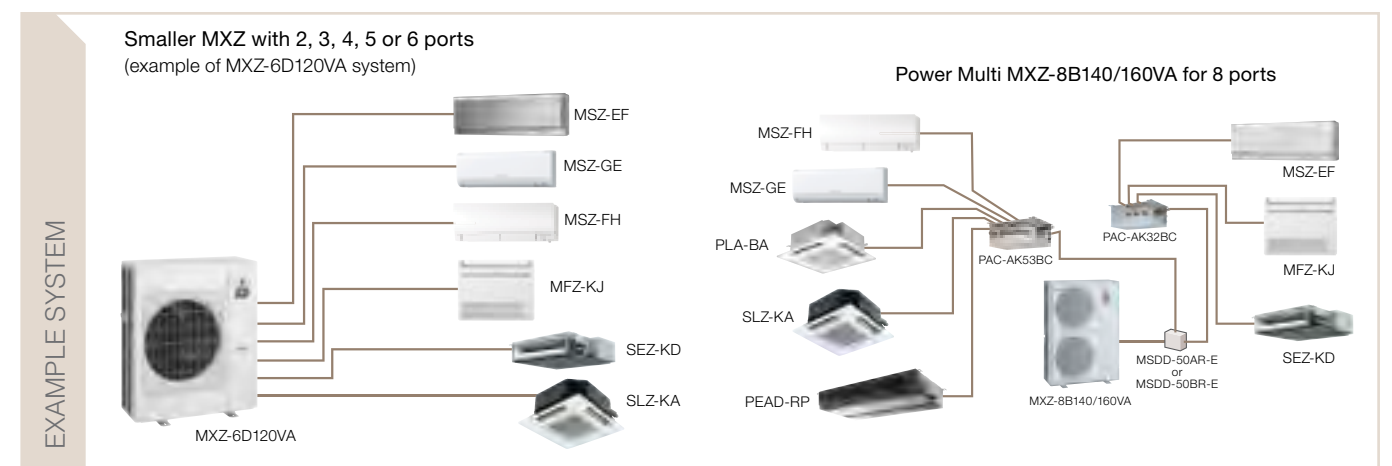
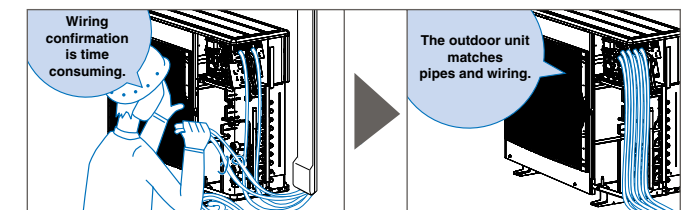

Branch Box Features

For MXZ-8B140VA/MXZ-8B160VA



PAC-AK53BC



PAC-AK32BC

Flexible Installation Indoor

The branch box can be installed in the ceiling, thus improving appearance. The piping length to the indoor units has been reduced. Maintenance is also easier through improved access to the circuit board and other inner parts by simply removing the side and bottom covers.

Flexible Installation Outdoor

The branch box can be installed outdoors by using the optional cover for outdoor installation. It can be suspended from the building eaves for easy maintenance access, eliminating the need for a special maintenance hole in the ceiling.

Brazing-Free, Quick Installation

All the piping leading to and from the branch box is connected using flare joints, which are easy to use and enable pipes to be connected quickly. The piping connection size differs according to the type and capacity of indoor units. Match the piping connection size for the indoor unit and branch box.

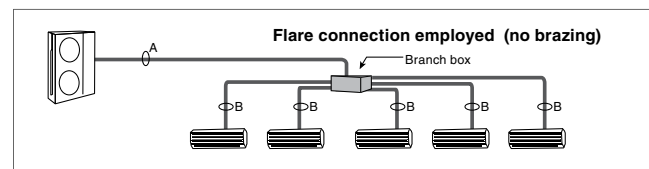
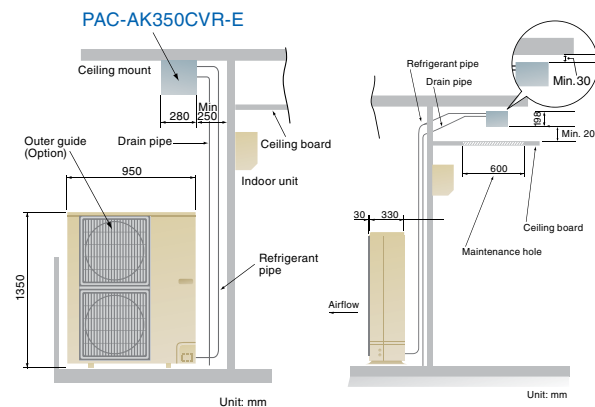

	A	B	
Liquid	ø9.52mm (ø3/8 in.)	PAC-AK53BC ø6.35 (ø1/4 in.) × 5	PAC-AK32BC ø6.35 (ø1/4 in.) × 3
Gas	ø15.58mm (ø5/8 in.)	ø9.52 (ø3/8 in.) × 4 + ø12.7 (ø1/2 in.) × 1	ø9.52 (ø3/8 in.) × 3

Controls

Making the most out of your air conditioner all starts with the controls, these allow you to create the comfort levels that match your demands. As air conditioners are becoming more advanced, so are the controls, to allow accuracy and ease of use to maximise the functionality of your air conditioner. The availability of handheld remotes, wired wall controllers, internet-connectable controllers, and central based zone controllers not only provide you with a wide variety of choice, but also allow optimised programming efficiency.



24 Hour Controller

This simple to use remote controller features a 24 hour timer, an easy to read display and variety of operating modes at the touch of a button. An On/Off timer allows users to set operating times on a daily basis. The 'i-Save' mode recalls the present temperature. This remote is standard for the GE25/35/42/50 series.



AE-200 10.4" LCD Touch Screen

Control up to 200 units, remote monitoring via web browser or personal computer via a LAN. Featuring a large, backlit high-resolution colour touch panel, easily visible making it easy to read and control units. Fan operation time as well as energy consumption can be displayed.



AT-50B 5" LCD Touch Screen

Simple operation at a touch with the ability to control up to 50 units. The AT-50B features both weekly and daily timer functions and night setback function. The backlit LCD lights up on touch and dims after a certain time period.



Weekly Remote Controller

With an easy to read display and a variety of operating modes at the touch of a button. This controller features a weekly and 24 hour timer, On/Off timer to set operating times on a daily basis. The 'i-Save' mode recalls the preset temperature. This remote is standard for the GE60/71/80 Series, EF series and FH series.



PAR-31MAA 7 Day Controller

The wall mounted 7 day controller is an optional upgrade with the ability to connect to all Mitsubishi Electric systems listed in this brochure. The PAR-31MAA allows you to program up to 8 stop/start patterns per day for up to 7 days at a time. Other features include a variety of operation control functions, error information, temperature range restriction, operation lock and multi-language display. The PAR-31 also offers the following at the touch of a button: LCD backlit screen, large, easy to read display and mode view for both icon and word display.

Wi-Fi Control

Wi-Fi Control unlocks the door to smarter heating or cooling, for total home comfort where ever you are.

This innovative technology connects your domestic high wall, floor mounted and ducted air conditioner to your smartphone, tablet or online account, giving you the freedom to fully control each unit on-the-go via an internet connection from anywhere in the world.

Wi-Fi CONTROL



Superior Customisation

This innovative technology places multiple functions of your air-conditioner at your fingertips. Turning the unit ON/OFF, adjusting set temperature, changing mode, fan speed and airflow direction are all possible.



Develop Operating Rules

Tailor your system to always meet your needs. Unlock the full potential of your air-conditioner, program your system to automatically turn on/off at specific times, change settings, and develop temperature rules to ensure superior comfort day after day.



Control Multiple Units

Customise the settings of each air-conditioner in your home. Purchase multiple adaptors to manage all air-conditioners independently on the same account to ensure complete control over your system. The result is a tailored system to your needs.

Optional upgrade adaptor required

Wi-Fi FEATURES

- » View & control from anywhere in the world
- » Enhance energy savings
- » Set up 7 day weekly schedule
- » Wireless connection using WPS



FEATURE GLOSSARY

Energy Efficiency

Felt Temperature Control *i-see Sensor*

Conventional air conditioners monitor the air temperature at the top of a room to control room temperature and fail to take foot-level temperature, that which has the strongest impact on room comfort, into consideration.

The "3D i-See Sensor" monitors the floor temperature and estimates the "felt temperature" (i.e. The temperature felt by people in the room). The airflow speed and temperature are adjusted to prevent over-cooling/heating, thereby reducing energy consumption.

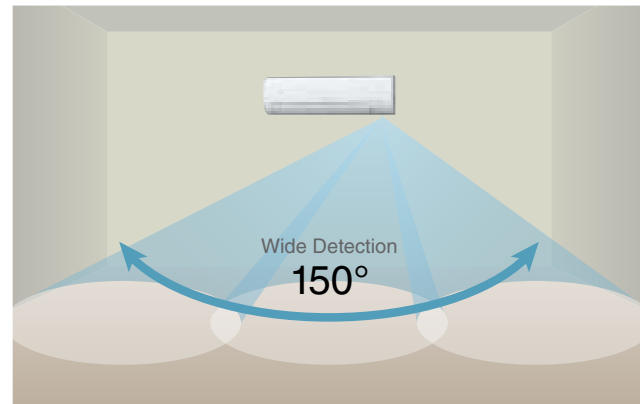

The "3D i-See Sensor" sweeps from side-to-side automatically monitoring the floor temperature over a wide area spanning 150°.

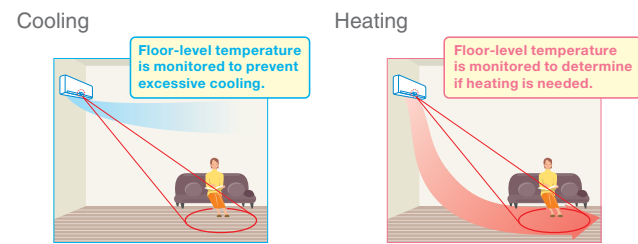

Demand Function (Offsite Modification)

It is possible to reduce electricity consumption within a range from 0 to 100% by performing the following onsite installation. The demand function can be enabled by adding a commercially available input contact point On/Off switch to the CNDM connector (the contact point demand input, optional parts.)

- Incorporate the "Adapter for external input (PAC-SC36NA)" into the circuit.
- By switching SW7-1 on the control circuit board for the outdoor unit, the following power consumption restrictions (compared to rated power) can be set.

SW7-1	Power consumption when SW2 is on
OFF	0% (Forced compressor stop)
ON	50%

Econo Cool Energy Saving Feature

"Econo Cool" is an intelligent temperature control feature that adjusts the amount of air directed towards the body based on the air-outlet temperature. The setting temperature can be raised by as much as 2°C without any loss in comfort, thereby realising a gain in energy efficiency.

(Function only available during manual cooling operation.)

	Conventional	Econo Cool
Ambient temperature	35°C	35°C
Set temperature2	5°C2	7°C
Perceived temperature	30°C	29.3°C

A comfortable room environment is maintained even when setting the temperature 2°C higher than the conventional cooling mode.

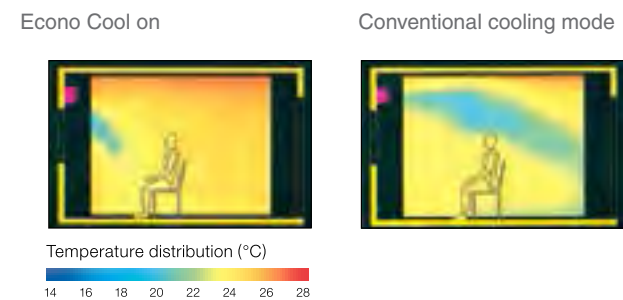

Area Temperature Monitor

The "3D i-See Sensor" monitors the whole room in sections and directs the airflow to areas of the room where the temperature does not match the temperature setting. (When cooling the room, if the middle of the room is detected to be hotter, more airflow is directed towards it.) This helps to prevent unnecessary cooling/heating and contributes to higher energy efficiency.

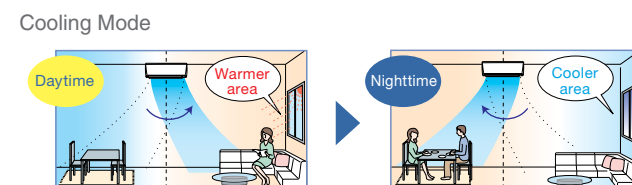

Attractive

Pure White

Pure white is adopted for the unit colour; white expressing the essence of cleanliness and easily matching virtually all interior décor.

Auto Vane

The vane closes automatically when the air conditioner is not running, concealing the air outlet and creating a flat surface that is aesthetically appealing.

FEATURE GLOSSARY

Air Quality

Plama Duo *Plasma Duo Filter Systems*

Units are equipped with a pre-filter and two special filters that perform plasma air cleaning and plasma purification functions (Plasma Duo). The plasma system remove bad odours and bacterial particulates of micron- and nanometre-size from the air.

Fresh-Air Intake

Indoor air quality is enhanced by the direct intake of fresh exterior air.

Anti-Allergy Enzyme Filter

The anti-allergy enzyme filter works to trap allergens such as molds and bacteria and decompose them using enzymes retained in the filter.

High-Efficiency Filter

This high-performance filter has a much finer mesh compared to standard filters, and is capable of capturing minute particulates floating in the air that were not previously caught.

Nano Platinum Filter

The filter has a large capture area and incorporates nanometre-sized platinum- ceramic particles that work to kill bacteria and deodourise the circulating air.

Catechin Filter

Catechin is a bioflavonoid by-product of green tea with both antiviral and antioxidant qualities. It also has an excellent deodourising effect, which is why Mitsubishi Electric uses the compound in its air conditioner filters. In addition to improving air quality, it prevents the spreading of bacteria and viruses throughout the room. Easily removed for cleaning and maintenance, when the filter is washed regularly the deodourising action is rated to last more than 10 years.

Long-life Filter

A special process for the entrapment surface improves the filtering effect, making the maintenance cycle longer than that of units equipped with conventional filters.

Filter Check Signal

Air conditioner operating time is monitored, and the user is notified when filter maintenance is necessary.

Electrostatic Anti-allergy Enzyme Filter

This function features both the Air Cleaning Filter and Anti-allergy Enzyme Filter.

*These filters are not medical devices and the care/cleaning instructions in the relevant uses manual must be followed for proper functioning.)

Air Distribution

Horizontal Fin

The air outlet vane swings up and down so that the airflow is spread evenly throughout the room.

Vertical Fin

The air outlet fin swings from side to side so that the airflow reaches every part of the room.

High Ceiling Mode

In the case of rooms with high ceilings, the outlet-air volume can be increased to ensure that air is circulated all the way to the floor.

Low Ceiling Mode

If the room has a low ceiling, the airflow volume can be reduced for less draft.

Auto Fan Speed Mode

The airflow speed mode adjusts the fan speed of the indoor unit automatically according to the present room conditions.

Wide & Long Airflow

The wide and long airflow function is especially beneficial for large spaces, helping to ensure that air is well circulated and reaches every corner of the room.

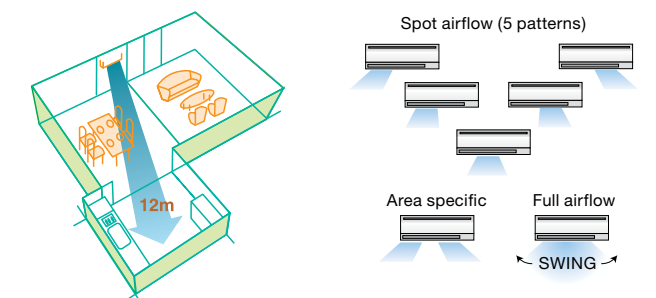

Wide Airflow

This unique airflow system distributes air horizontally over a wide-ranging 150° in heating mode and 100° in cooling mode. Simply press the Wide Swing icon on the remote controller to select the desired airflow from seven different patterns.

Long Airflow

Use this function to ensure that the airflow circulates to areas far across the room. Press the Long Airflow icon on the remote controller to extend reach up to as far as 12 metres from the unit.

FEATURE GLOSSARY

Installation

Cleaning-Free Pipe Reuse (2D52/3D54/4D71/4D80/5D100/6D120)

The application of pipe reuse technology makes it possible to reuse piping, thereby allowing cleaning-free re-use of air conditioning systems that use R22 refrigerant.

* The existing piping can not be reused if the outer diameter and the thickness of the existing piping do not meet applicable specifications or damage to piping is found. (3D54/4D71/4D80/5D100/6D120)

Wiring/Piping Correction Function

The push of a single button is all that is required to confirm that piping and wiring are properly connected. Corrections are made automatically if a wiring error is detected, eliminating the need for complicated wiring confirmation work when expanding the number of rooms served. (For details, refer to the outdoor unit installation manual.)

* This function cannot be used when the outdoor temperature is below 0°C. The correction process requires 10–20 minutes, and only works when the unit is set to the Cooling mode.

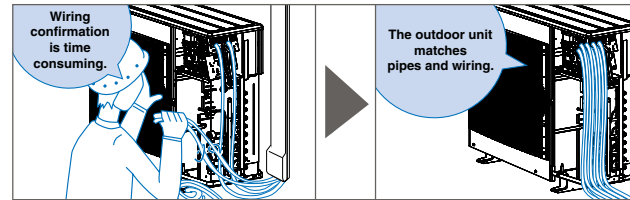

Flare Connection

Flare connection to cooling pipe work is possible.

Drain Pipe

A built-in drain pump enables drain piping to be raised.

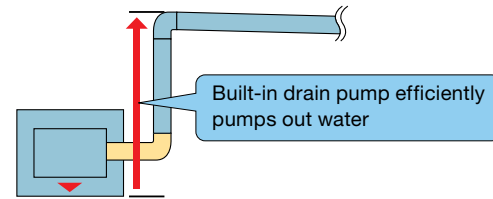

Maintenance

Quick Clean Body

The cover panel can be quickly removed for washing and the airflow vents can be opened without any special tools, making it easy to clean the inside of the air conditioner in minutes. Periodic cleaning of the air conditioner is recommended to maintain optimum operating and energy efficiency.

The cover panel can be quickly removed for washing and the airflow vents can be opened without any special tools, making it easy to clean the inside of the air conditioner in minutes. Periodic cleaning of the air conditioner is recommended to maintain optimum operating and energy efficiency.



Open the vents to clean and reach into clean the fan



Exclusive Quick Clean Kit (Optional)

Our exclusive "Quick Clean Kit" can be easily connected to a household vacuum cleaner for quick and easy cleaning of the heat exchanger.*

*It is highly recommended that rubber gloves be worn when cleaning the heat exchanger; touching it with bare hands may lead to injury.

Mitsubishi Electric's "Quick Clean Kit" helps to prevent increases in electricity consumption by as much as 30%*

Always clean the heat exchanger, fan and air vent to ensure proper performance and economical operation.

* Electricity cost comparison of operation between two units at a fixed temperature; one with 8g of dirt on one fan and the other fan clean. Based on in-house data.

Heat exchanger

Electricity consumption increases up to 5%*

Fan

Electricity consumption increases up to 25%*

Air vent

Self-Diagnostic Function Check Code Display

Check codes are displayed on the remote controller or the operation indicator to inform the user of malfunctions detected.

Failure Recall Function

Operation failures are recorded, allowing confirmation when needed.

Outdoor Unit Specifications

Type			Up to 2 Indoor Units	Up to 3 Indoor Units	Up to 4 Indoor Units	Up to 5 Indoor Units	Up to 6 Indoor Units		
Model Name *1			MXZ-2D52VA	MXZ-3D54VA	MXZ-4D71VA	MXZ-4D80VA	MXZ-5D100VA	MXZ-6D120VA	
Power Supply [V, Phase, Hz, Source]			230V, Single, 50Hz, Outdoor unit power supply						
Cooling	Capacity	Rated	kW	5.2	5.4	7.1	8.0	10.0	12.0
		Min. - Max.	kW	1.1 - 6.0	2.9 - 6.8	3.7 - 8.8	3.7 - 9.2	3.9 - 11.0	3.5 - 13.5
	Power Input [Indoor+Outdoor]		kW	1.40	1.25	1.88	2.07	3.09	3.61
	AEER/EER *2 [Indoor+Outdoor]			3.67 / 3.71	3.95 / 4.32	3.50 / 3.78	3.59 / 3.86	3.07 / 3.24	3.18 / 3.32
	Running Current *2 [Indoor+Outdoor]		A	6.3	5.5	8.3	9.1	13.6	15.9
	Sound Pressure Level [Outdoor]	Silent - Rated	dB(A)	46 - 50	45 - 50	45 - 50	46 - 51	49 - 53	51 - 53
Air Volume [Outdoor]		ℓ/s	525	648	648	910	973	987	
Heating	Capacity	Rated	kW	6.1	7.0	8.0	8.8	10.0	13.5
		Min. - Max.	kW	1.0 - 7.0	2.6 - 9.0	3.4 - 10.7	3.4 - 11.6	4.1 - 14.0	3.5 - 16.5
	Power Input [Indoor+Outdoor]		kW	1.59	1.61	1.84	2.13	2.63	3.75
	ACOP/COP *2 [Indoor+Outdoor]			3.80 / 3.84	4.06 / 4.35	4.03 / 4.35	3.86 / 4.13	3.58 / 3.80	3.45 / 3.60
	Running Current *2 [Indoor+Outdoor]		A	7.1	7.1	8.1	9.4	11.6	16.5
	Sound Pressure Level [Outdoor]	Silent - Rated	dB(A)	49 - 53	48 - 53	48 - 54	46 - 51	49 - 59	53 - 57
Air Volume [Outdoor]		ℓ/s	532	755	778	833	1050	1158	
Number of Connectable Indoor Units	Min. - Max.		2	2 - 3	2 - 4	2 - 4	2 - 5	2 - 6	
Breaker Size		A	15	25	25	25	25	32	
Outdoor Dimensions	Height	mm	550	710	710	915	915	1070	
	Width	mm	800	840	840	900	900	900	
	Depth	mm	285	330	330	320	320	320	
Weight		kg	37	57	58	69	70	87	
Ext. Piping	Diameter	Liquid (ø)	mm	6.35 × 2	6.35 × 3	6.35 × 4	6.35 × 4	6.35 × 5	6.35 × 6
		Gas (ø)	mm	9.52 × 2	9.52 × 3	9.52 × 3 + 12.7 × 1	9.52 × 3 + 12.7 × 1	9.52 × 4 + 12.7 × 1	9.52 × 5 + 12.7 × 1
	Max. Length	Total - Each	m	30 - 20	50 - 25	60 - 25	70 - 25	80 - 25	80 - 25
Max. Height *3		m	15 / 10	15 / 10	15 / 10	15 / 10	15 / 10	15 / 10	
Refrigerant Chargeless Piping Length		m	20	40	40	40	40	60	
Guaranteed Operating Range [Outdoor unit]	Cooling	°C	-10 - +46	-10 - +46	-10 - +46	-10 - +46	-10 - +46	-10 - +46	
	Heating	°C	-15 - +24	-15 - +24	-15 - +24	-15 - +24	-15 - +24	-15 - +24	

*1 Model name shows rated cooling capacity when max. number of indoor units are connected.
MXZ-5D100VA: Rated at 10kW when 5 indoor units are connected.

*2 Figures represented in power input, running current and AEER/ACOP are when connected with indoor units below.
MXZ-2D52VA → MSZ-GE35VAD × 2
MXZ-3D54VA → MSZ-GE25VAD × 3
MXZ-4D71VA → MSZ-GE25VAD × 4
MXZ-4D80VA → MSZ-GE25VAD × 4
MXZ-5D100VA → MSZ-GE25VAD × 5
MXZ-6D120VA → MSZ-GE25VAD × 6

*3 If the outdoor unit is installed higher than the indoor unit, max height is reduced to 10m.

(Rating Conditions) Cooling: Indoor 27°C, D.B./19°C, W.B. Outdoor 35°C, D.B./24°C, W.B.
Heating: Indoor 20°C, D.B. Outdoor 7°C, D.B./6°C, W.B.

Type			Up to 8 Indoor Units		
Model Name			MXZ-8B140VA	MXZ-8B160VA	
Power Supply [V, Phase, Hz, Source]			230V, Single, 50Hz, Outdoor unit power supply		
Cooling	Capacity	Rated	kW	14.0	15.5
			kW	3.80	4.62
	AEER/EER *1 [Indoor+Outdoor]			3.32 / 3.52	3.06 / 3.21
	Running Current *1 [Outdoor]		A	16.6	20.3
	Sound Pressure Level [Outdoor]	Silent - Rated	dB(A)	47 - 50	48 - 51
	Air Volume [Outdoor]		ℓ/s	1,670	1,770
Heating	Capacity	Rated	kW	16.0	18.0
			kW	3.95	4.82
	ACOP/COP *1 [Indoor+Outdoor]			3.70 / 3.91	3.45 / 3.61
	Running Current *1 [Outdoor]		A	17.3	21.2
	Sound Pressure Level [Outdoor]	Rated	dB(A)	52	54
	Air Volume [Outdoor]		ℓ/s	1,670	1,770
Number of Connectable Indoor Units	Min. - Max.		2 - 8	2 - 8	
Breaker Size		A	40	40	
Outdoor Dimensions	Height	mm	1,350	1,350	
	Width	mm	950	950	
	Depth	mm	330	330	
Weight		kg	129	129	
Ext. Piping	Diameter	Liquid (ø)	mm	9.52 × 1	9.52 × 1
		Gas (ø)	mm	15.88 × 1	15.88 × 1
Max. Length	Total - Each	m	115 - 70	115 - 70	
Max. Height *2		m	30 / 20	30 / 20	
Refrigerant Chargeless Piping Length		m	40	40	
Guaranteed Operating Range [Outdoor unit]	Cooling	°C	-5 - +46	-5 - +46	
	Heating	°C	-15 - +21	-15 - +21	

*1 Figures represented in power input, running current and AEER/ACOP are when connected with indoor units below.
MXZ-8B140VA → MSZ-GE22VAD × 3 + MSZ-GE25VAD × 3
MXZ-8B160VA → MSZ-GE22VAD × 7

*2 The maximum height is 20m when installing an outdoor unit positioned lower than indoor unit.

Type			Branch Box		
Model Name			PAC-AK53BC	PAC-AK32BC	
Number of Connectable Indoor Units			Max. 5	Max. 3	
Power Supply [V, Phase, Hz, Source]			230V, Single, 50Hz, Outdoor unit power supply		
Total Input			kW		
Operating Current			A		
Drain Hose Size			mm		
Dimensions [H × W × D]			mm		
Weight			kg		
Piping [Diameter]	Branch [Indoor side]	Liquid	mm	6.35 × 5	6.35 × 3
		Gas	mm	9.52 × 4, 12.7 × 1	9.52 × 3
	Main [Outdoor side]	Liquid	mm	9.52	
		Gas	mm	15.88	
Connection Method		Flared			
Wiring	To Indoor Unit	3-wire + Earth wire			
	To Outdoor Unit	3-wire + Earth wire			

Maximum Piping Length (Total Length)						
Model	30m	50m	60m	70m	80m	115m
MXZ-2D52VA	✓					
MXZ-3D54VA		✓				
MXZ-4D71VA			✓			
MXZ-4D80VA				✓		
MXZ-5D100VA					✓	
MXZ-6D120VA						✓
MXZ-8B140VA						✓
MXZ-8B160VA						✓

Indoor Unit Specifications

MSZ-EF (Wall-mounted: Stylish type)						
Model Name		MSZ-EF22VE (W/B/S)	MSZ-EF25VE (W/B/S)	MSZ-EF35VE (W/B/S)	MSZ-EF42VE (W/B/S)	MSZ-EF50VE (W/B/S)
Fan Speed		Quiet-Lo-Mid-Hi-SHi-Auto				
Cooling	Airflow [min-max]	ℓ/s 67 - 175	67 - 175	67 - 175	97 - 172	97 - 183
	Sound Pressure Level [min-max]	dB 21 - 42	21 - 42	21 - 42	28 - 42	30 - 43
Heating	Airflow [min-max]	ℓ/s 67 - 198	67 - 198	67 - 212	92 - 212	107 - 220
	Sound Pressure Level [min-max]	dB 21 - 45	21 - 45	21 - 46	28 - 48	30 - 49
Dimensions	Height	mm 299				
	Width	mm 895				
	Depth	mm 195				
Weight	kg	11.5				
Pipe Size [Liquid/Gas]	mm	ø6.35 / ø9.52			ø6.35 / ø12.7	

W: White, B: Black, S: Silver SHi → Super High

MSZ-FH (Wall-mounted: Deluxe type)				
Model Name		MSZ-FH25VE	MSZ-FH35VE	MSZ-FH50VE
Fan Speed		Lo-Mid-Hi-SHi-Auto		
Cooling	Airflow [min-max]	ℓ/s 78 - 193	78 - 193	123 - 207
	Sound Pressure Level [min-max]	dB 23 - 42	24 - 42	31 - 44
Heating	Airflow [min-max]	ℓ/s 78 - 220	78 - 220	120 - 243
	Sound Pressure Level [min-max]	dB 24 - 44	24 - 44	29 - 46
Dimensions	Height	mm 305 (+17)		
	Width	mm 925		
	Depth	mm 234		
Weight	kg	13.5		
Pipe Size [Liquid/Gas]	mm	ø6.35 / ø9.52		ø6.35 / ø12.7

SHi → Super High

MSZ-GE (Wall-mounted: Standard type)										
Model Name		MSZ-GE22VAD	MSZ-GE25VAD	MSZ-GE35VAD	MSZ-GE42VAD	MSZ-GE50VAD	MSZ-GE60VAD	MSZ-GE71VAD	MSZ-GE80VAD	
Fan Speed		Quiet-Lo-Mid-Hi-SHi-Auto								
Cooling	Airflow [min-max]	ℓ/s 68 - 188	68 - 188	68 - 212	97 - 213	108 - 252	163 - 305	162 - 298	162 - 298	
	Sound Pressure Level [min-max]	dB 19 - 42	19 - 42	19 - 43	26 - 46	28 - 49	29 - 49	30 - 49	30 - 49	
Heating	Airflow [min-max]	ℓ/s 68 - 192	68 - 192	68 - 192	97 - 218	108 - 242	163 - 305	170 - 298	170 - 298	
	Sound Pressure Level [min-max]	dB 19 - 42	19 - 42	19 - 43	26 - 46	28 - 48	29 - 49	30 - 49	30 - 49	
Dimensions	Height	mm 295							325	
	Width	mm 798							1,100	
	Depth	mm 232							238	
Weight	kg	10						16		
Pipe Size [Liquid/Gas]	mm	ø6.35 / ø9.52			ø6.35 / ø12.7		ø6.35 / ø15.88		ø9.52 / ø15.88	

SHi → Super High

MFZ-KJ (Compact floor-standing)				
Model Name		MFZ-KJ25VE	MFZ-KJ35VE	MFZ-KJ50VE
Fan Speed		Quiet-Lo-Mid-Hi-SHi-Auto		
Cooling	Airflow [min-max]	ℓ/s 65 - 136	65 - 136	93 - 176
	Sound Pressure Level [min-max]	dB 20 - 39	20 - 39	27 - 44
Heating	Airflow [min-max]	ℓ/s 65 - 161	65 - 161	100 - 233
	Sound Pressure Level [min-max]	dB 19 - 41	19 - 41	29 - 50
Dimensions	Height	mm 600		
	Width	mm 750		
	Depth	mm 215		
Weight	kg	15		
Pipe Size [Liquid/Gas]	mm	ø6.35 / ø9.52		ø6.35 / ø12.7

SHi → Super High

SLZ-KA (Compact cassette)				
Model Name		SLZ-KA25VAQ (L)	SLZ-KA35VAQ (L)	SLZ-KA50VAQ (L)
Fan Speed		Lo-Mid-Hi		
Cooling	Airflow [min-max]	ℓ/s 133 - 167	133 - 183	133 - 183
	Sound Pressure Level [min-max]	dB 28 - 37	29 - 38	30 - 39
Heating	Airflow [min-max]	ℓ/s 133 - 167	133 - 183	133 - 183
	Sound Pressure Level [min-max]	dB 28 - 37	29 - 38	30 - 39
Dimensions	Height	mm 235 (20)		
	Width	mm 570 (650)		
	Depth	mm 570 (650)		
Weight (): Panel	kg	16.5 (3)		
Pipe Size [Liquid/Gas]	mm	ø6.35 / ø9.52		ø6.35 / ø12.7

*SLZ-KA VAQ: No remote controller included. *SLZ-KA VAL: Equipped with a wireless remote controller.

PLA-RP (4-way cassette)				
Model Name		PLA-RP60BA	PLA-RP71BA	PLA-RP100BA
Fan Speed		Lo-Mi1-Mi2-Hi-Auto		
Cooling	Airflow [min-max]	ℓ/s 200 - 300	233 - 350	334 - 501
	Sound Pressure Level [min-max]	dB 28 - 32	28 - 34	32 - 40
Heating	Airflow [min-max]	ℓ/s 200 - 300	233 - 350	334 - 501
	Sound Pressure Level [min-max]	dB 28 - 32	28 - 34	32 - 40
Dimensions	Height	mm 258 (35)		
	Width	mm 840 (950)		
	Depth	mm 840 (950)		
Weight (): Panel	kg	23 (6)		25 (6)
Pipe Size [Liquid/Gas]	mm	ø6.35 / ø15.88		ø9.52 / ø15.88

SEZ-KD (Compact ceiling-concealed)						
Model Name		SEZ-KD25VAQ (L)	SEZ-KD35VAQ (L)	SEZ-KD50VAQ (L)	SEZ-KD60VAQ (L)	SEZ-KD71VAQ (L)
Fan Speed		Lo-Mid-Hi-Auto				
Cooling	Airflow [min-max]	ℓ/s 92 - 150	117 - 183	167 - 250	200 - 300	200 - 333
	Sound Pressure Level [min-max]	dB 23 - 30	23 - 33	30 - 37	30 - 38	30 - 40
Heating	Airflow [min-max]	ℓ/s 92 - 150	117 - 183	167 - 250	200 - 300	200 - 333
	Sound Pressure Level [min-max]	dB 23 - 30	23 - 33	30 - 37	30 - 38	30 - 40
Static Pressure	Pa	5/15/35/50				
Dimensions	Height	mm 200				
	Width	mm 790	990		1,190	
	Depth	mm 700				
Weight	kg	18	21	23	27	
Pipe Size [Liquid/Gas]	mm	ø6.35 / ø9.52		ø6.35 / ø12.7	ø6.35 / ø15.88	ø9.52 / ø15.88

*SEZ-KD VAQ: No remote controller included. *SEZ-KD VAL: Equipped with a wireless remote controller.

PEAD-RP (Ceiling-concealed)				
Model Name		PEAD-RP71JAA	PEAD-RP100JAA	
Fan Speed		Lo-Mid-Hi		
Cooling	Airflow [min-max]	ℓ/s 292 - 350 - 417	400 - 483 - 567	
	Sound Pressure Level [min-max]	dB 30 - 34 - 39	33 - 38 - 42	
Heating	Airflow [min-max]	ℓ/s 292 - 350 - 417	400 - 483 - 567	
	Sound Pressure Level [min-max]	dB 30 - 34 - 39	33 - 38 - 42	
Static Pressure	Pa	30/50/70/100/125		
Dimensions	Height	mm 250		
	Width	mm 1,100	1,400	
	Depth	mm 732		
Weight	kg	29	38	
Return Air Spigot Size	mm	1,058 × 210		1,358 × 210
Supply Air Spigot Size	mm	1,060 × 178		1,360 × 178
Pipe Size [Liquid/Gas]	mm	ø9.52 / ø15.88		

*No remote controller included. Note: With PEAD models, the total capacity of indoor units need to be 100% of the outdoor unit capacity as maximum.

PCA-RP (Ceiling-suspended)				
Model Name		PCA-RP50KAQ	PCA-RP60KAQ	PCA-RP71KAQ
Fan Speed		Lo-Mi1-Mi2-Hi-Auto		
Cooling	Airflow [min-max]	ℓ/s 167 - 250	250 - 317	267 - 333
	Sound Pressure Level [min-max]	dB 32 - 40	33 - 40	35 - 41
Heating	Airflow [min-max]	ℓ/s 167 - 250	250 - 317	267 - 333
	Sound Pressure Level [min-max]	dB 32 - 40	33 - 40	35 - 41
Dimensions	Height	mm 230		
	Width	mm 960	1,280	
	Depth	mm 680		
Weight	kg	25	32	
Pipe Size [Liquid/Gas]	mm	ø6.35 / ø12.7		ø6.35 / ø15.88

*No remote controller included.

When MFZ-KJ indoor unit(s) is connected to MXZ, please charge additional refrigerant according to the following chart.

No. of MFZ-KJ indoor units		1 unit	2 units	3 units	4 units	
MXZ-2D52VA	Pipe Length	~20m	100g additional (Total 1400g)	200g additional (Total 1500g)	-	-
		~30m	100 g+((L-20) m×20 g/m)	200 g+((L-20) m×20 g/m)	-	-
MXZ-3D54VA	Maximum Amount of Refrigerant		1600g	1700g	-	-
		~40m	100g additional (Total 2800g)	200g additional (Total 2900g)	300g additional (Total 3000g)	-
MXZ-4D71VA	Pipe Length	~50m	100 g+((L-40) m×20 g/m)	200 g+((L-40) m×20 g/m)	300 g+((L-40) m×20 g/m)	-
		~60m	100g additional (Total 2800g)	200g additional (Total 2900g)	300g additional (Total 3000g)	400g additional (Total 3100g)
	Maximum Amount of Refrigerant		3000g	3100g	3200g	-
		~40m	100 g+((L-40) m×20 g/m)	200 g+((L-40) m×20 g/m)	300 g+((L-40) m×20 g/m)	400 g+((L-40) m×20 g/m)
		~60m	100 g+((L-40) m×20 g/m)	200 g+((L-40) m×20 g/m)	300 g+((L-40) m×20 g/m)	400 g+((L-40) m×20 g/m)
	Maximum Amount of Refrigerant		3200g	3300g	3400g	3500g



For more information contact

www.mitsubishielectric.com.au

Call 1300 722 228

Distributed and guaranteed throughout Australia by

MITSUBISHI ELECTRIC AUSTRALIA PTY. LTD.

(Incorporated in New South Wales) A.B.N. 58 001 215 792

