

# Measuring Strain with Strain Gages

Publish Date: Oct 28, 2013

## Overview

This tutorial is part of the National Instruments Measurement Fundamentals series. Each tutorial in this series will teach you a specific topic of common measurement applications by explaining theoretical concepts and providing practical examples. This tutorial introduces and explains the concepts and techniques of measuring strain with strain gages.

[For more in-depth guidance on making strain measurements, visit the how-to guide.](#)

To find more information on the Measurement Fundamentals series, return to the [NI Measurement Fundamentals Main Page](#).

## Table of Contents

1. [What Is Strain?](#)
2. [The Strain Gage](#)
3. [Strain Gage Measurement](#)
4. [Signal Conditioning for Strain Gages](#)
5. [Data Acquisition Systems for Strain Gage Measurements](#)
6. [Relevant NI Products](#)

### 1. What Is Strain?

Strain is the amount of deformation of a body due to an applied force. More specifically, strain ( $\epsilon$ ) is defined as the fractional change in length, as shown in Figure 1.

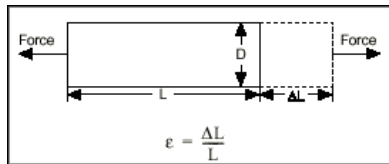

Figure 1. Definition of Strain

Strain can be positive (tensile) or negative (compressive). Although dimensionless, strain is sometimes expressed in units such as in./in. or mm/mm. In practice, the magnitude of measured strain is very small. Therefore, strain is often expressed as microstrain ( $\mu\epsilon$ ), which is  $\epsilon \times 10^{-6}$ .

When a bar is strained with a uniaxial force, as in Figure 1, a phenomenon known as Poisson Strain causes the girth of the bar,  $D$ , to contract in the transverse, or perpendicular, direction. The magnitude of this transverse contraction is a material property indicated by its Poisson's Ratio. The Poisson's Ratio  $\nu$  of a material is defined as the negative ratio of the strain in the transverse direction (perpendicular to the force) to the strain in the axial direction (parallel to the force), or  $\nu = \epsilon_{\perp} / \epsilon$ . Poisson's Ratio for steel, for example, ranges from 0.25 to 0.3.

### 2. The Strain Gage

While there are several methods of measuring strain, the most common is with a strain gage, a device whose electrical resistance varies in proportion to the amount of strain in the device. The most widely used gage is the bonded metallic strain gage.

The metallic strain gage consists of a very fine wire or, more commonly, metallic foil arranged in a grid pattern. The grid pattern maximizes the amount of metallic wire or foil subject to strain in the parallel direction (Figure 2). The cross-sectional area of the grid is minimized to reduce the effect of shear strain and Poisson Strain. The grid is bonded to a thin backing, called the carrier, which is attached directly to the test specimen. Therefore, the strain experienced by the test specimen is transferred directly to the strain gage, which responds with a linear change in electrical resistance. Strain gages are available commercially with nominal resistance values from 30 to 3,000  $\Omega$ , with 120, 350, and 1,000  $\Omega$  being the most common values.

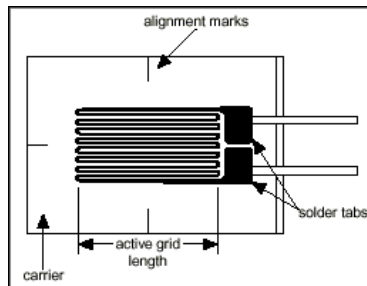

Figure 2. Bonded Metallic Strain Gage

It is very important that the strain gage be properly mounted onto the test specimen so that the strain is accurately transferred from the test specimen, through the adhesive and strain gage backing, to the foil itself.

A fundamental parameter of the strain gage is its sensitivity to strain, expressed quantitatively as the gage factor (GF). Gage factor is defined as the ratio of fractional change in electrical resistance to the fractional change in length (strain):

$$GF = \frac{\Delta R/R}{\Delta L/L} = \frac{\Delta R/R}{\epsilon}$$

The gage factor for metallic strain gages is typically around 2.

### 3. Strain Gage Measurement

In practice, strain measurements rarely involve quantities larger than a few millistrain ( $\epsilon \times 10^{-3}$ ). Therefore, to measure the strain requires accurate measurement of very small changes in resistance. For example, suppose a test specimen undergoes a strain of 500 me. A strain gage with a gage factor of 2 will exhibit a change in electrical resistance of only  $2(500 \times 10^{-6}) = 0.1\%$ . For a 120  $\Omega$  gage, this is a change of only 0.12  $\Omega$ .

To measure such small changes in resistance, strain gages are almost always used in a bridge configuration with a voltage excitation source. The general Wheatstone bridge, illustrated in Figure 3, consists of four resistive arms with an excitation voltage,  $V_{EX}$ , that is applied across the bridge.

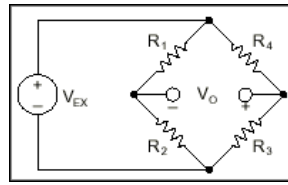

Figure 3. Wheatstone Bridge

The output voltage of the bridge,  $V_O$ , is equal to:

$$V_O = \left[ \frac{R_3}{R_3 + R_4} - \frac{R_2}{R_1 + R_2} \right] \cdot V_{EX}$$

From this equation, it is apparent that when  $R_1/R_2 = R_4/R_3$ , the voltage output  $V_O$  is zero. Under these conditions, the bridge is said to be balanced. Any change in resistance in any arm of the bridge results in a nonzero output voltage.

Therefore, if you replace  $R_4$  in Figure 3 with an active strain gage, any changes in the strain gage resistance will unbalance the bridge and produce a nonzero output voltage. If the nominal resistance of the strain gage is designated as  $R_G$ , then the strain-induced change in resistance,  $\Delta R$ , can be expressed as  $\Delta R = R_G \cdot GF \cdot \epsilon$ , from the previously defined Gage Factor equation. Assuming that  $R_1 = R_2$  and  $R_3 = R_G$ , the bridge equation above can be rewritten to express  $V_O/V_{EX}$  as a function of strain (see Figure 4). Note the presence of the  $1/(1+GF \cdot \epsilon/2)$  term that indicates the nonlinearity of the quarter-bridge output with respect to strain.

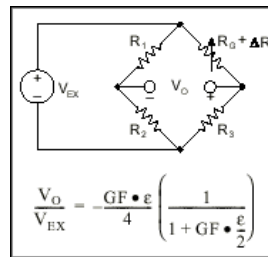

Figure 4. Quarter-Bridge Circuit

Ideally, you would like the resistance of the strain gage to change only in response to applied strain. However, strain gage material, as well as the specimen material to which the gage is applied, also responds to changes in temperature. Strain gage manufacturers attempt to minimize sensitivity to temperature by processing the gage material to compensate for the thermal expansion of the specimen material for which the gage is intended. While compensated gages reduce the thermal sensitivity, they do not totally remove it.

By using two strain gages in the bridge, you can further minimize the effect of temperature. For example, Figure 5 illustrates a strain gage configuration where one gage is active ( $R_G + \Delta R$ ) and a second gage is placed transverse to the applied strain. Therefore, the strain has little effect on the second gage, called the dummy gage. However, any changes in temperature affect both gages in the same way. Because the temperature changes are identical in the two gages, the ratio of their resistance does not change, the voltage  $V_O$  does not change, and the effects of the temperature change are minimized. NOTE: In the Wheatstone bridge configuration, the active gage and the dummy gage should be on the same vertical leg of the bridge.

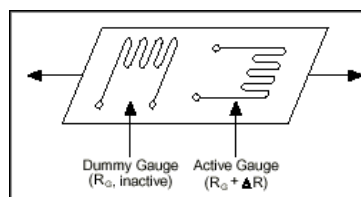

Figure 5. Use of Dummy Gauge to Eliminate Temperature Effects

The sensitivity of the bridge to strain can be doubled by making both gages active in a half-bridge configuration. For example, Figure 6 illustrates a bending beam application with one bridge mounted in tension ( $R_G + \Delta R$ ) and the other mounted in compression ( $R_G - \Delta R$ ). This half-bridge configuration, whose circuit diagram is also illustrated in Figure 6, yields an output voltage that is linear and approximately doubles the output of the quarter-bridge circuit.

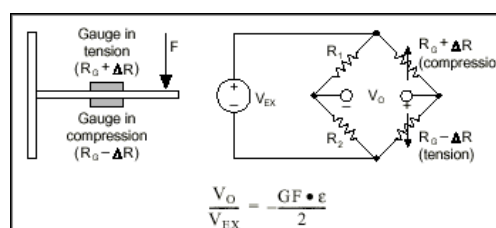

Figure 6. Half-Bridge Circuit

Finally, you can further increase the sensitivity of the circuit by making all four of the arms of the bridge active strain gages in a full-bridge configuration. The full-bridge circuit is shown in Figure 7.

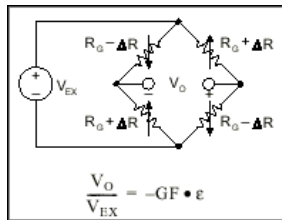

Figure 7. Full-Bridge Circuit

The equations given here for the Wheatstone bridge circuits assume an initially balanced bridge that generates zero output when no strain is applied. In practice, however, resistance tolerances and strain induced by gage application generate some initial offset voltage. This initial offset voltage is typically handled in two ways. First, you can use a special offset-nulling, or balancing, circuit to adjust the resistance in the bridge to rebalance the bridge to zero output. Alternatively, you can measure the initial unstrained output of the circuit and compensate in software. This topic is discussed in greater detail later.

The equations given above for quarter-, half-, and full-bridge strain gage configurations assume that the lead wire resistance is negligible. While ignoring the lead resistance may be beneficial to understanding the basics of strain gage measurements, doing so in practice can be a major source of error. For example, consider the 2-wire connection of a strain gage shown in Figure 8a. Suppose each lead wire connected to the strain gage is 15 m long with lead resistance  $R_L$  equal to 1  $\Omega$ . Therefore, the lead resistance adds 2  $\Omega$  of resistance to that arm of the bridge. Besides adding an offset error, the lead resistance also desensitizes the output of the bridge.

You can compensate for this error by measuring the lead resistance  $R_L$  and accounting for it in the strain calculations. However, a more difficult problem arises from changes in the lead resistance due to temperature fluctuations. Given typical temperature coefficients for copper wire, a slight change in temperature can generate a measurement error of several microstrain.

Using a 3-wire connection can eliminate the effects of variable lead wire resistance because the lead resistance affects adjacent legs of the bridge. As seen in Figure 8b, changes in lead wire resistance,  $R_{L2}$ , do not change the ratio of the bridge legs  $R_3$  and  $R_G$ . Therefore, any changes in resistance due to temperature cancel out each other.

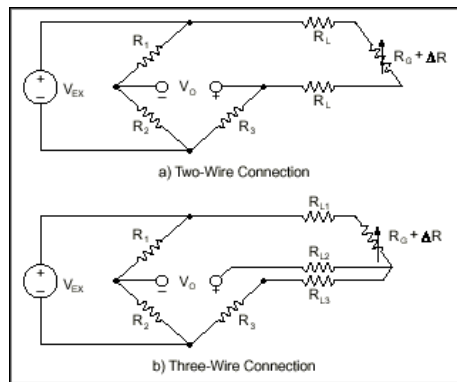

Figure 8. 2-Wire and 3-Wire Connections of Quarter-Bridge Circuit

#### 4. Signal Conditioning for Strain Gages

Strain gage measurement involves sensing extremely small changes in resistance. Therefore, proper selection and use of the bridge, signal conditioning, wiring, and data acquisition components are required for reliable measurements. To ensure accurate strain measurements, it is important to consider the following:

- Bridge completion
- Excitation
- Remote sensing
- Amplification
- Filtering
- Offset
- Shunt calibration

**Bridge Completion** – Unless you are using a full-bridge strain gage sensor with four active gages, you need to complete the bridge with reference resistors. Therefore, strain gage signal conditioners typically provide half-bridge completion networks consisting of high-precision reference resistors. Figure 9a shows the wiring of a half-bridge strain gage circuit to a conditioner with completion resistors  $R_1$  and  $R_2$ .

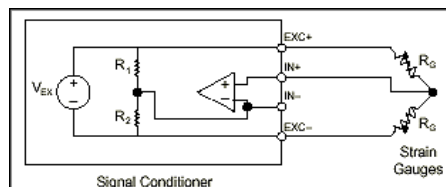

Figure 9a. Connection of Half-Bridge Strain Gage Circuit

**Excitation** – Strain gage signal conditioners typically provide a constant voltage source to power the bridge. While there is no standard voltage level that is recognized industry wide, excitation voltage levels of around 3 and 10 V are common. While a higher excitation voltage generates a proportionately higher output voltage, the higher voltage can also cause larger errors because of self-heating.

**Remote Sensing** – If the strain gage circuit is located a distance away from the signal conditioner and excitation source, a possible source of error is voltage drop caused by resistance in the wires connecting the excitation voltage to the bridge. Therefore, some signal conditioners include a feature called remote sensing to compensate for this error. Remote sense wires are connected to the point where the excitation voltage wires connect to the bridge circuit, as seen in Figure 9b. The extra sense wires serve to regulate the excitation supply through negative feedback amplifiers to compensate for lead losses and deliver the needed voltage at the bridge.

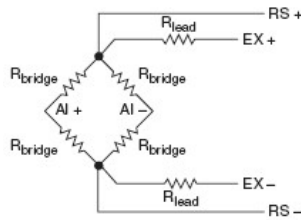

Figure 9b. Remote Sensor Error Compensation

**Amplification** – The output of strain gages and bridges is relatively small. In practice, most strain gage bridges and strain-based transducers output less than 10 mV/V (10 mV of output per volt of excitation voltage). With 10 V excitation, the output signal is 100 mV. Therefore, strain gage signal conditioners usually include amplifiers to boost the signal level to increase measurement resolution and improve signal-to-noise ratios.

**Filtering** – Strain gages are often located in electrically noisy environments. It is therefore essential to be able to eliminate noise that can couple to strain gages. Lowpass filters, when used with strain gages, can remove the high-frequency noise prevalent in most environmental settings.

**Offset Nulling** – When a bridge is installed, it is very unlikely that the bridge will output exactly zero volts when no strain is applied. Slight variations in resistance among the bridge arms and lead resistance will generate some nonzero initial offset voltage. Offset nulling can be performed by either hardware or software:

1. **Software Compensation** – With this method, you take an initial measurement before strain input is applied, and use this offset to compensate subsequent measurements. This method is simple, fast, and requires no manual adjustments. The disadvantage of the software compensation method is that the offset of the bridge is not removed. If the offset is large enough, it limits the amplifier gain you can apply to the output voltage, thus limiting the dynamic range of the measurement.

2. **Offset-Nulling Circuit** – The second balancing method uses an adjustable resistance, a potentiometer, to physically adjust the output of the bridge to zero. By varying the resistance of potentiometer, you can control the level of the bridge output and set the initial output to zero volts.

**Shunt Calibration** – The normal procedure to verify the output of a strain gage measurement system relative to some predetermined mechanical input or strain is called shunt calibration. Shunt calibration involves simulating the input of strain by changing the resistance of an arm in the bridge by some known amount. This is accomplished by shunting, or connecting, a large resistor of known value ( $R_s$ ) across one arm of the bridge, creating a known DR as seen in Figure 9c. The output of the bridge can then be measured and compared to the expected voltage value. The results are used to correct span errors in the entire measurement path, or to simply verify general operation to gain confidence in the setup.

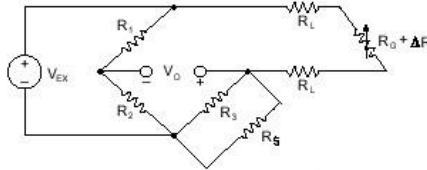

Figure 9c. Shunt Resistor Connected Across R3

## 5. Data Acquisition Systems for Strain Gage Measurements

Not sure what products you need? [Get Recommendations BETA](#)

### Using NI CompactDAQ with Strain Gages

NI CompactDAQ hardware provides the plug-and-play simplicity of USB to sensor and electrical measurements. The NI CompactDAQ system consists of an [NI cDAQ-9174](#) 4-slot or [NI cDAQ-9178](#) 8-slot USB 2.0-compliant chassis that can hold up to eight C Series I/O modules and connect to a PC using a 1.8 m USB cable. NI CompactDAQ delivers fast and accurate measurements with more than 45 self-contained measurement modules available. And with three timing engines, the [cDAQ-9174/9178](#) chassis can run analog modules at up to three different rates. Because all circuitry required for the specific measurement is contained in the C Series I/O module itself, you can connect many different types of sensors, including strain gages, directly to the modules.



Figure 10. NI cDAQ-9174/9178 Chassis with C Series I/O Modules

The [NI 9219](#) is a 4-channel universal C Series module designed for multipurpose testing in any NI CompactDAQ or CompactRIO chassis. With the NI 9219, you can measure several signals from sensors such as strain gages, RTDs, thermocouples, load cells, and other powered sensors. The channels are individually selectable, so you can perform a different measurement type on each of the four channels. The NI 9219 uses six-position spring terminal connectors in each channel for direct signal connectivity and contains built-in quarter-, half-, and full-bridge support.

For C Series I/O modules specifically designed for the measurement of strain gages, National Instruments offers the [NI 9235](#), [NI 9236](#), and the [NI 9237](#). These bridge modules contain all the signal conditioning required to power and measure bridge-based sensors simultaneously. The NI 9235 and NI 9236 have a higher channel count and include completion for quarter-bridge sensors. The NI 9237 supports up to four full- and half bridge sensors and can measure from quarter bridge strain gages using a completion accessory.

The NI 9237 can perform offset/null as well as shunt calibration and remote sense, making the module the best choice for low- to medium-channel-count strain and bridge measurements.

### Recommended Starter Kit for Strain Gage NI CompactDAQ System:

1. [cDAQ-9174](#) or [cDAQ-9178](#) chassis
2. [NI 9237](#) with an RJ50 cable and an NI 9949 (full and half bridge) or NI 9944/NI 9945 (quarter bridge)
3. Refer to [ni.com/sensors](http://ni.com/sensors) for recommended sensor vendors

### Using PXI with Strain Gages

PXI is a rugged PC-based platform that offers a high-performance, low-cost deployment solution for measurement and automation systems. PXI combines the PCI bus with the rugged, modular Eurocard mechanical packaging of CompactPCI and adds specialized synchronization buses and key software features. PXI can integrate a controller and provides up to 18 slots in a single chassis. There are timing and triggering lines on the backplane of the PXI chassis for tight synchronization of the various I/O modules. PXI Express delivers PCI Express data transfer technology to the PXI platform, increasing backplane bandwidth from 132 MB/s to 6 GB/s.



**Figure 11. PXI Express Chassis with SC Express Sensor Measurement Modules**

The **NI SC Express family** features PXI Express data acquisition modules with integrated signal conditioning for sensor measurements, such as strain gages and other Wheatstone bridge-based transducers. The **NI PXIe-4330** 8-channel simultaneous bridge input module offers 24-bit resolution, 0.02% accuracy and 25 kS/s per channel sample rate for high-performance strain measurements. The NI PXIe-4330 can perform quarter-, half-, and full bridge-based measurements with automatic synchronization features; the included driver software ensures tight synchronization across multiple modules and chassis with inter-channel skews as low as 5 parts per billion (PPB). This device offers per channel excitation from 0.625 to 10 V with remote sensing to compensate for error caused by resistance in the wires connecting the voltage source to the bridge. For added flexibility, built-in bridge completion (120  $\Omega$ , 350  $\Omega$ , and 1 k $\Omega$ ) and shunt calibration (50 k $\Omega$ , 100 k $\Omega$ ) are software-selectable on a per channel basis. The NI PXIe-4330 should be used with the NI TB-4330 front-mounting terminal block for screw terminal connectivity.

**Recommended Starter Kit for Strain Gage SC Express System:**

1. [NI PXIe-1073](#) chassis
2. [NI PXIe-4330](#) universal bridge input module with [TB-4330](#) for connectivity
3. Refer to [ni.com/sensors](http://ni.com/sensors) for recommended sensor vendors

**Using SCXI with Strain Gages**

National Instruments **SCXI** is a signal conditioning system for PC-based instrumentation applications. An SCXI system consists of a shielded chassis that houses a combination of signal conditioning input and output modules, which perform a variety of signal conditioning functions. You can connect many different types of sensors, including strain gages, directly to SCXI modules. The SCXI system operates as a front-end signal conditioning system for PC plug-in [data acquisition](#) devices (USB, PCI, and PCMCIA) or PXI data acquisition modules.

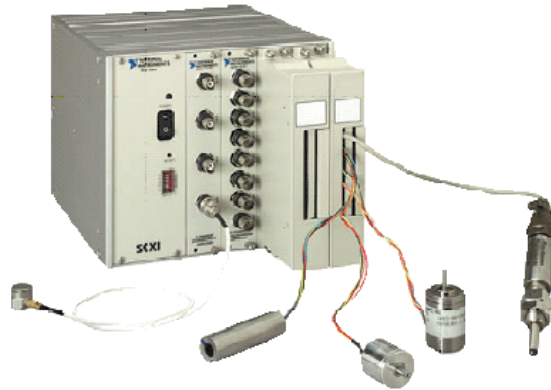

**Figure 12. SCXI Signal Conditioning System**

The **NI SCXI-1520** is an 8-channel universal strain gage input module that offers a variety of features for strain measurements. With this single module, signals from strain, force, torque, and pressure sensors can be easily read. The SCXI-1520 also offers a programmable amplifier and programmable four-pole Butterworth filter on each channel, and simultaneous sampling with track-and-hold circuitry. In addition, the SCXI-1520 system offers a half-bridge completion resistor network in the module and a socketed 350 W quarter-bridge completion resistor. Table 1 summarizes some additional features of the SCXI-1520 that relate to strain gage measurements.

**Table 1. SCXI-1520 Features for Strain Gages**

<b>Number of channels</b>	8
<b>Multiplexer scan rate</b>	Up to 333 kS/s <sup>1</sup>
<b>Amplifier gain</b>	1 to 1,000
<b>Excitation voltage source</b>	0.0 to 10.0 V in 0.635 V increments
<b>Excitation current drive</b>	29 mA throughout excitation voltage range
<b>Half-bridge completion</b>	Yes
<b>Offset nulling</b>	Yes
<b>Shunt calibration</b>	Yes
<b>Remote excitation sensing</b>	Yes

<sup>1</sup> Multiplexer scan rate depends on the data acquisition device.

**Recommended Starter Kit for Strain Gage SCXI Data Acquisition System:**

1. [USB-1600](#) USB Data Acquisition and Control Module for SCXI
2. [NI SCXI-1000](#) chassis
3. [SCXI-1520](#) with [NI SCXI-1314](#) terminal block
4. Refer to [ni.com/sensors](http://ni.com/sensors) for recommended sensor vendors

**6. Relevant NI Products**

Customers interested in this topic were also interested in the following NI products:

- [LabVIEW](#)

- [Data Acquisition \(DAQ\)](#)
- [Signal Conditioning](#)

For more tutorials, return to the [NI Measurement Fundamentals Main Page](#).

Download the [Complete Guide to Building a Measurement System](#) for a checklist of questions to consider for your application.