

hp
photosmart
730
series
digital
camera



user's manual



Trademark and copyright information

© Copyright 2003 Hewlett-Packard Company

All rights are reserved. No part of this document may be photocopied, reproduced, or translated to another language without the prior written consent of Hewlett-Packard Company.

The information contained in this document is subject to change without notice. Hewlett-Packard shall not be liable for errors contained herein or for consequential damages in connection with the furnishing, performance, or use of this material.

Microsoft® and Windows® are U.S. registered trademarks of Microsoft Corporation.

Apple®, Macintosh®, and Mac® are registered trademarks of Apple Computer, Inc.

MultiMediaCard™ is a trademark of Infineon Technologies AG.

SD logo is a trademark.



Table of Contents

Chapter 1:

Getting started	9
Camera parts	10
Status LCD	14
Setup	16
Attaching the wrist strap	16
Installing the batteries	16
Installing a memory card (optional)	17
Turning on power	18
Restoring previous settings	18
Choosing the language	18
Setting the date and time	19
Installing the software	20
Windows	20
Macintosh	21

Chapter 2:

Taking pictures and recording video clips	23
Taking still pictures	23
Recording video clips	24
Using live view	25
Using the focus brackets	26
Status screen	27
Using zoom	28
Optical zoom	28
Digital zoom	28
Using the flash	30
Changing the image quality	31
Recording audio	32
Changing capture modes	33
Using self-timer mode	35
Using burst mode	36

Using macro mode	36
Advanced capture settings	37
EV compensation	38
White balance	39
ISO speed	40
AE metering	41
Saturation	43
Sharpness	44
Setup	44
Chapter 3:	
Reviewing images and video clips	45
Using playback	45
Using the playback menu	47
Viewing thumbnail images	48
Rotating images	49
Deleting images	50
Recording and deleting audio clips	51
Magnifying images	52
Setup	52
Chapter 4:	
Using hp instant share	53
Using the share menu	54
Using hp instant share to print pictures	55
Using hp instant share to send images to destinations	56
Adding destinations to the share menu on the camera	56
Selecting hp instant share destinations for images	59
How hp instant share e-mails images	60

Chapter 5:	
Unloading, printing, and displaying images . . .	61
Unloading to a computer	61
Printing images	63
Displaying images on a TV	65
Chapter 6:	
Using the setup menu	67
Camera sounds	68
Date & time	68
USB configuration	69
TV configuration	70
Language	70
Move images to card	71
Chapter 7:	
Troubleshooting and support	73
Problems and solutions	73
Error messages on the camera	82
Error messages on the computer	90
Getting assistance	92
HP accessibility website	92
HP photosmart website	92
Support process	92
Phone support in the United States	94
Phone support in Europe, the Middle East, and Africa	95
Other phone support worldwide	97
Appendix A:	
Batteries and camera accessories	99
Managing batteries	99
Extending battery life	100
Rechargeable batteries	101
Power conservation	101
Purchasing camera accessories	102

Appendix B:	
Specifications	105

Chapter 1:

Getting started

Congratulations on your purchase of this digital camera! This camera has many features to enhance your picture-taking experience, including HP Instant Share™, direct printing capability, manual and automatic controls, on-camera Help, and an optional camera dock.

With HP Instant Share, you can easily select pictures on your camera to print or e-mail automatically the next time you connect the camera to your computer or printer. Your friends and family can easily receive and view your pictures in e-mail without being burdened by large file attachments. Or you can use the direct printing capability to any HP Photosmart printer or other select HP printer without ever connecting to your computer. What a great way to keep others close as you capture precious memories!

To further enhance your experience, you may purchase an HP Photosmart 8886 camera dock. The camera dock allows you to easily download images to a computer, send images to a printer or television, and recharge the camera batteries. It also provides a convenient home for your camera.



NOTE A dock insert is included in your camera box. Please do not discard it, because it enables your camera to use the HP 8886 camera dock. See the manual that comes with the camera dock for instructions on how to attach the dock insert to the camera dock.





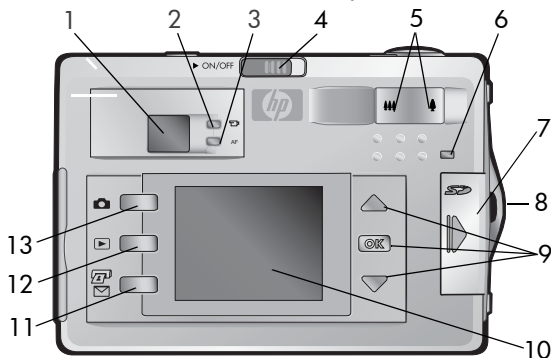







Camera parts

NOTE Refer to the pages in parentheses after the part names for more information about those parts.



#	Name	Description
1	Optical Viewfinder (page 25)	Allows you to frame the subject of the picture or video clip
2	 Video viewfinder light (red)	Solid —camera is recording video Blinking — Self-Timer is activated or there is an error (see Image Display for message)
3	AF Auto Focus viewfinder light (green)	Solid —camera is ready to take a picture (focus and exposure are locked) Blinking —camera is unable to focus, long exposure (hold steady), or there is an error (see Image Display for message)
4	 ON/OFF switch (page 18)	Turns the camera power on and off

#	Name	Description
5	Zoom lever:  Zoom Out  Zoom In (page 28)	Zooms out the lens to the wide angle position, and zooms in the lens to the telephoto position
6	Memory/USB light (page 18)	Solid orange —USB is connected Blinking orange —camera is either: starting up, charging the battery, sending/receiving USB, or reading from or writing to the memory card
7	Memory card door (page 17)	Allows access to insert or remove the memory card
8	Wrist strap mount (page 16)	Allows you to attach a wrist strap
9	  arrow buttons and OK button (page 37, 47)	  —allows you to move through menus and images on the Image Display OK —allows you to display the Capture and Playback menus and to select menu options
10	Image Display (page 25)	Allows you to frame pictures and video clips using Live View and review them afterward in Playback , and to view all the menus
11	  HP Instant Share button (page 54)	Turns the Share menu on and off on the Image Display
12	 Playback button (page 45)	Turns Playback on and off on the Image Display
13	 Live View button (page 25)	Turns Live View on and off on the Image Display

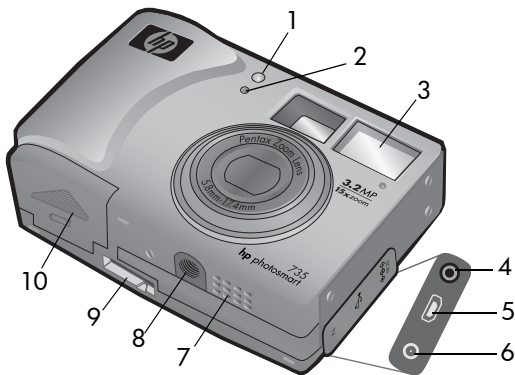

#	Name	Description
1	Video/Self-Timer light (page 35)	Solid red —camera is recording video Blinking red — Self-Timer is activated
2	Microphone (pages 32, 51)	Records audio clips
3	Flash (page 30)	Provides additional light to improve picture-taking
4	Power adapter connector (page 102)	Provides connection for optional HP AC power adapter
5	USB connector (pages 61, 63)	Provides connection for USB cable to a computer or printer
6	TV connector (page 65)	Provides connection for optional Audio/Video cable to a TV
7	Speaker	Plays camera sounds and audio clips
8	Tripod mount	Allows you to mount the camera to a tripod

#	Name	Description
9	Camera dock connector (page 102)	Provides connection to the optional HP 8886 camera dock
10	Battery door (page 16)	Allows access to insert and remove the batteries

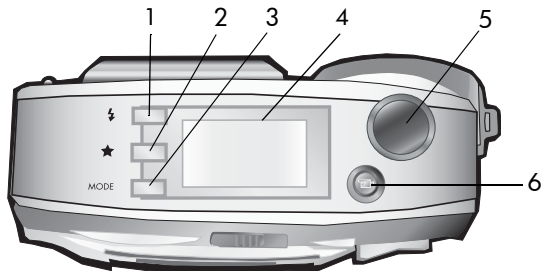







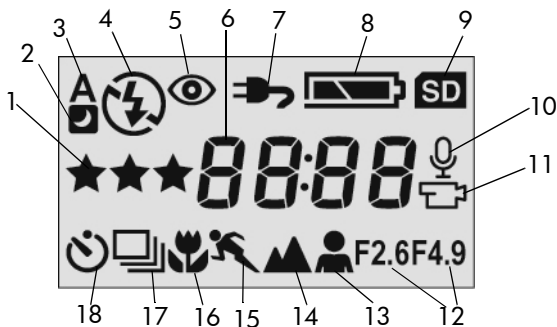









#	Name	Description
1	⚡ Flash button (page 30)	Selects the flash setting
2	★ Quality button (page 31)	Changes image quality from Good to Better to Best
3	MODE button (page 33)	Changes the capture mode to Self-Timer , Burst , Macro , or one of five different exposure settings.
4	Status LCD (page 14)	Displays camera settings and operating status

#	Name	Description
5	Shutter button (page 23)	Takes a picture. Push halfway down to lock focus and exposure, then all the way down to take picture. Hold down after picture is taken to record audio.
6	 Video button (page 24)	Records a video clip; press once to start and press again to stop

Status LCD



#	Icon	Indicates
1	★★★★	Image quality selection
2		Night mode flash setting is active
3		Auto flash is active

#	Icon	Indicates
4	 or 	Flash On is active or Flash Off is active
5		Red-eye Reduction Flash is active
6		Number of still images remaining or time remaining (for video and audio clips)
7		AC adapter is providing power
8		Battery condition
9		Memory card is in the camera
10		Audio is recording
11		Video is recording
12	2.6 / 4.9	F-stop is set to 2.6 or 4.9
13		Portrait mode is active
14		Landscape mode is active
15		Action mode is active
16		Macro setting is active
17		Burst setting is active
18		Self timer setting is active

Setup

Attaching the wrist strap

Attach the wrist strap to the wrist strap mount on the side of the camera as shown.

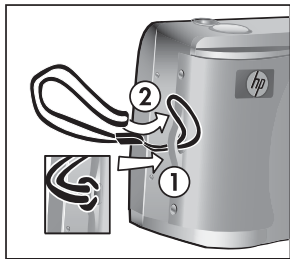

Installing the batteries

- 1 Open the battery door on the bottom of the camera.
- 2 Insert the batteries as indicated inside the door.
- 3 Close the battery door.

NOTE For more information about batteries, see **Managing batteries** on page 99.

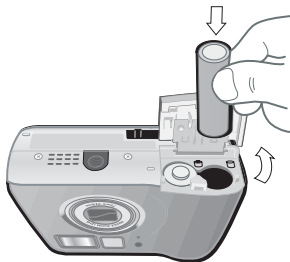

NOTE If you have rechargeable batteries, you can use the optional HP Photosmart 8886 camera dock or the optional HP AC power adapter to recharge batteries in the camera. For more information about these optional accessories, see **Purchasing camera accessories** on page 102.

Installing a memory card (optional)

Your camera contains 16 MB of internal memory that allows you to store images and video clips in your camera. However, you can use an optional memory card (purchased separately) instead to store images and video clips. For information on the memory cards that are supported with your camera, see **Purchasing camera accessories** on page 102.

NOTE If a memory card is installed in the camera, all new images and video clips will be stored only on the memory card. The internal memory and its file system are not available when a memory card is installed in the camera.

- 1 With the camera turned off and the back of the camera facing you, open the memory card door by sliding the door to the right.
- 2 Insert the memory card, making sure that it clicks into place.
- 3 Close the memory card door.

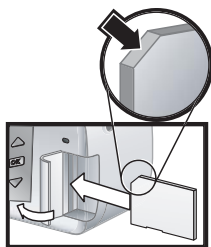

To remove a memory card, turn the camera off and open the memory card door, then push the memory card in, and it will spring outward from the slot.

Turning on power

Turn the camera on by sliding the
▶ ON/OFF switch to the right and then releasing it. The Memory/USB light will blink and then turn off when the camera is ready.

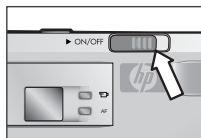

Restoring previous settings

Some of the camera settings do not remain set when the camera is turned off. To restore all camera settings that were in effect when the camera was last turned off, hold down the OK button when you turn on the camera.

Choosing the language

The first time you turn the camera on, the following screen appears and prompts you to choose a language.

- 1 Scroll to the language that you want by using the ▲ ▼ buttons.
- 2 Press the OK button to select the highlighted language.

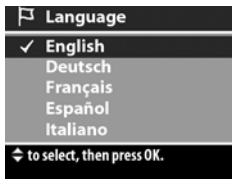

NOTE If you need to go back and change this setting later, you can do this in the Setup menu. See [Chapter 6: Using the setup menu](#) on page 67.

Setting the date and time

The camera has a clock that records the date and time at which you take each picture. This time stamp does not appear in the image itself, but is recorded in the image properties, which you can see when viewing the image on the computer.

The first time you turn the camera on, the following screen appears after you choose the language.

- 1 Press the **OK** button repeatedly until the preferred date format appears, and then press the **▼** button to highlight the date.
- 2 Press **OK** to select the first value, and then use the **▲** **▼** buttons to change it. Press **OK** to confirm. Set the remaining values in the same way (M = Month, D = Day, Y = Year).
- 3 Press the **▼** button to highlight the time format, and then press **OK** if you want to change it.
- 4 Press the **▼** button to highlight the time. Set the time values in the same way you set the date values in step 2.
- 5 When finished setting the date and time, press the **▼** button to highlight **Exit**, and then press **OK**.



NOTE If you need to go back and change this setting later, you can do this in the **Setup** menu. See **Chapter 6: Using the setup menu** on page 67.

Installing the software

The camera software allows you to unload images from the camera, view them, print them, and e-mail them. It also allows you to configure the **Share** menu on the camera.

See **Chapter 4: Using hp instant share** on page 53 for information about configuring the **Share** menu on the camera, and **Chapter 5: Unloading, printing, and displaying images** on page 61 for information about connecting the camera to a computer or printer.

NOTE A copy of this User's Manual is located on the HP Photo & Imaging software CD. Look in the `\docs\Readme` file on the CD to see where the manual in your language is located.

Windows

NOTE For the **HP Instant Share** component of the HP Photo & Imaging software to function properly on your Windows computer, you must have installed at least Internet Explorer 5.01 on Windows 2000 or XP, or Internet Explorer 5.01 Service Pack 2 on Windows 98, 98 SE, or Me.

- 1 Close all programs and temporarily disable any virus protection software running on your computer.
- 2 Insert the HP Photo & Imaging software CD into the CD drive of your computer. The installation window automatically appears.

NOTE If the installation window does not appear, click **Start**, and then click **Run**. Type `X:\Setup.exe`, where **X** is the letter of your CD drive.

- 3 Click **Next**, and then follow the on-screen instructions to install the software.

Your Windows CD may also include bonus software from other manufacturers. To install any bonus software:

- 1 Click **Start**, click **Run**, and in the **Open** box, type **X:\Bonus\setup.exe** (where **X** is the letter of your CD drive).
- 2 Click **OK**, and then follow the on-screen instructions to install the bonus software.

Macintosh

- 1 Close all programs and temporarily disable any virus protection software running on your computer.
- 2 Insert the HP Photo & Imaging software CD into the CD drive of your computer.
- 3 Double-click the CD icon on the computer desktop.
- 4 Double-click the installer icon, and then follow the on-screen instructions to install the software.

NOTE Before you can unload images from the camera to a Macintosh computer, you must first change the **USB Configuration** setting to **Disk Drive** in the **Setup** menu on the camera. See **Chapter 6: Using the setup menu** on page 67, and then see **USB configuration** on page 69.

Your Macintosh CD may also include bonus software from other manufacturers. To install any bonus software:

- 1 Double-click the **Bonus** folder icon.
- 2 Double-click the installer icon for the bonus software.
- 3 Follow the on-screen instructions to install the software.

Chapter 2:

Taking pictures and recording video clips

Taking still pictures

You can take a picture almost any time the camera is on, regardless of what is being shown on the Image Display.

- 1 Frame the subject for your picture in the viewfinder.
- 2 Hold the camera steady and press the **Shutter** button halfway down. The camera measures and then locks the focus and exposure. This **Focus Lock** feature allows you to focus on a subject that is not in the center of the picture, or to capture action shots more quickly by pre-focusing in the area where the action will occur.
- 3 Press the **Shutter** button all the way down to take the picture. The image appears for several seconds on the Image Display for instant review. During this time, the image is saved to memory, unless you choose to delete it by pressing the **OK** button.



In Step 2 above, one (or both) of the Viewfinder lights may start blinking. For an explanation of this, see the description for Viewfinder lights on page 10.

NOTE To achieve best focus in low light conditions, secure the camera to a tripod and make sure the focus area has sufficient contrast.

Recording video clips

1 Frame the subject for your video in the viewfinder.

2 Press and release the Video

 button to start recording video. Both the red viewfinder

light and the Video/Self-Timer light will turn on solid. A video  icon and a Time Remaining counter appear in the Status LCD and at the top of the Image Display (if it is on).

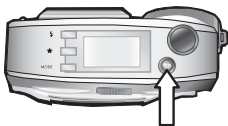

NOTE If you have the Self-Timer mode on (see **Using self-timer mode** on page 35), the camera will start recording 10 seconds after you press the  button.

3 To stop recording, press the  button again.

The length of a video clip is limited only by the amount of available memory. The camera calculates the Time Remaining (mm:ss) counter based on the amount of available memory (internal or memory card). The video ends when Time Remaining reaches zero or the  button is pressed again.

After recording has stopped, the last frame of the video clip remains on the Image Display for instant review. During this time, the video clip is saved to memory unless you choose to delete it by pressing the **OK** button.

NOTE Audio is automatically recorded with video clips.

Using live view



You can use the Image Display as a viewfinder to see a more accurate view of what your picture or video will look like. This is useful for close-up pictures and for instances in which framing your subject precisely is important.

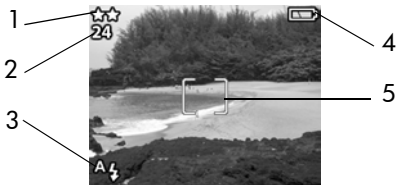

NOTE Using the Image Display consumes a lot of battery power. To preserve batteries, use the viewfinder instead.

To turn on **Live View**, press the **Live View**  button.

The following table describes the information that is displayed in the **Live View** screen when the camera settings are at their default values.



#	Icon	Description
1	★★★	Current image quality setting (1, 2, or 3 stars). If you press the Video button, the video icon () appears in this location.
2	24	Remaining pictures count (depends on how much space remains in memory). If you press the Video button, the time remaining for a video clip appears here.
3	A 	Auto flash icon will blink when the flash is charging.

#	Icon	Description
4		Battery level (actual icon shown depends on the state of your camera batteries; see Managing batteries on page 99).
5		Focus brackets (see the next section, Using the focus brackets).

NOTE If you change other camera settings, icons for those settings will also be displayed across the top and bottom of the **Live View** screen. For more information, see **Advanced capture settings** on page 37.

Using the focus brackets

The two brackets in the middle of the **Live View** screen show the focus region for the picture you are taking. When you press the **Shutter** button halfway down, the camera uses this focus region to measure and then lock the focus using this region. This is called **Focus Lock**.

The focus brackets turn green in the **Live View** screen and the **AF** viewfinder light turns on solid green when the image is in focus and the camera can lock the focus. However, the focus brackets turn red and the **AF** viewfinder light blinks green when the camera is unable to focus.

If the focus brackets turn red and the **AF** viewfinder light blinks, release the **Shutter** button, re-frame the subject for your picture, and then press the **Shutter** button halfway down again. If the camera still cannot focus after several tries, the lighting may be too low, or there may not be enough contrast in the focus region. Try using **Focus Lock** to focus on an object about the same distance away but in a higher-contrast region, then point the camera at the object you were originally trying to photograph.

If the focus brackets turn red, the **AF** viewfinder light blinks, and the **Macro**  icon is blinking on the Image Display, either the camera is set to **Macro** focus but detects the focus is further away than the macro (close-up) range, or the camera is set to **Normal** focus but detects the focus is closer than the normal range. For more information on the focus settings and their respective distance ranges, see **Using macro mode** on page 36.

NOTE When set to **Macro**  focus, the camera will not take a picture if it cannot find focus. However, when set to **Normal** focus (the default), the camera will still take a picture if it cannot find focus.

Status screen



When **Live View** is turned on and you change the flash, quality, or mode settings, a status screen will appear briefly on the Image Display, showing current camera settings, battery level, and the number of pictures remaining.

Using zoom

NOTE Zoom does not work while recording video clips.

Optical zoom

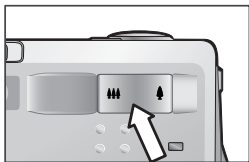

Optical zoom works like the zoom on a traditional film camera, with physical lens elements moving inside the camera to make the object of your picture appear closer.

Press the **Zoom Out**  and **Zoom In**  buttons to move the lens between wide angle and telephoto positions (1x to 3x).



Digital zoom

Unlike optical zoom, digital zoom uses no moving lens parts. The camera essentially crops the image, then uses interpolation to enlarge the image to give the appearance of the object in the picture being from 1x to 5x closer.

- 1 Press the **Zoom in**  button to optically zoom in to the maximum level, then release the button.
- 2 Press the **Zoom in**  button again and hold it until you reach the desired size in the Image Display. The picture enlarges in the Image Display (as do the focus brackets). The amount of digital zoom appears at the bottom of the Image Display.
- 3 Press the **Shutter** button to take the picture.









To turn digital zoom off and return to optical zoom, press the **Zoom Out**  button until digital zooming stops. Release the button, and then press the button again.

NOTE Digital zoom reduces the resolution of an image, so your picture will tend to be more pixilated than the same image taken with an optical zoom. If you just intend to e-mail an image or post it to a website, this loss of resolution will not be noticeable, but in situations where the highest quality counts (such as printing), skip the digital zoom and use the cropping tools in your image editing software to zero in on your subject.

Using the flash

NOTE The flash does not work while recording video clips.

To change the flash setting, press the **Flash**  button on the top of the camera until the desired setting appears on the Status LCD. If **Live View** is on, the icon also appears in the Image Display.

Icon	Setting	Description
	Auto	The camera measures the available light and fires the flash if necessary. This is the default setting.
	Red-eye Reduction	The camera measures light and fires the flash with red-eye reduction if necessary.
	Flash On	The camera always fires the flash. If the light is behind your subject, use this setting to increase the light on the front of your subject. This is called "fill-flash".
	Flash Off	The camera will not fire the flash. Use this setting when you do not want a flash (such as with distant objects). This may result in long exposures that will require using a tripod.
	Night	The camera fires the flash to illuminate objects in the foreground. It then continues to expose as if the flash had not fired to gather the background. This setting only works when taking pictures of still objects. Hold the camera steady to prevent blurry images. For best results, use a tripod.

NOTE The camera remains in the current flash setting until you change it or turn off the camera.

Changing the image quality

Image quality controls the resolution and compression settings that will be used to capture images. At higher settings, there will be greater detail visible in the images, but the file size of an image will be larger, and thus fewer pictures will fit in the internal memory or on the memory card.

To change the image quality setting, press the **Quality** ★ button until the desired setting appears on the Status LCD. If **Live View** is on, the icon also appears in the Image Display.

Setting	Icon	Description and capacity
Good	★	This is the most memory-efficient setting, ideal for images you want to e-mail or post to the Internet. At this setting, internal camera memory holds about 125 images, and a 16 MB memory card holds about 117 images.
Better	★★	This setting produces high-quality images and requires less memory than Best setting. This is recommended for printing images up to 20 by 25 cm (8 by 10 inches). This is the default quality setting. At this setting, internal camera memory holds about 19 images, and a 16 MB memory card holds about 18 images.
Best	★★★	This setting produces the highest-quality images and uses the most memory. This is recommended if you plan to enlarge images, or print images to a size larger than 20 by 25 cm (8 by 10 inches). At this setting, internal camera memory and a 16 MB memory card holds about 12 images.

Recording audio

NOTE This section applies only to still pictures. Audio is automatically recorded with video clips.

There are two ways to record an audio clip that will attach to a still picture.

- Record the audio while you are taking the picture (explained in this section).
 - Add an audio annotation to the picture later (or change the audio that was captured when the picture was taken). For details on how to do this, see **Recording and deleting audio clips** on page 51.
- 1** Press the **Shutter** button all the way down to take the picture (audio starts recording automatically).
 - 2** Continue to hold the **Shutter** button down to record the audio clip. If you let up on the **Shutter** button within two seconds of taking the picture, then the audio clip is discarded. If you keep holding the **Shutter** button down, the audio will continue recording as long as there is enough memory available.
 - 3** Audio recording stops either when you release the **Shutter** button, or the memory card is full, whichever comes first.

To review an audio clip, press the **Playback**  button on the camera and use the arrow buttons to navigate to the image containing the clip you want to hear.



To record a new audio clip, or to delete an audio clip, use the **Record Audio** section in the **Playback** menu. See **Using the playback menu** on page 47.



Changing capture modes

The **Mode** button on the top of the camera sets the camera to one of nine different capture modes. Each time you press the **Mode** button, the camera changes to the next capture mode. The sequence for the different settings is: **Normal**, **Self-Timer**, **Burst**, **Macro**, **Action**, **Landscape**, **Portrait**, **F2.6**, **F4.9**, and then repeat.

NOTE These settings do not have any effect on recording video clips unless specifically noted otherwise.



Each time you change the capture mode, an icon representing that capture mode appears in the Status LCD. If **Live View** is on, the icon also appears in the Image Display. The following table describes these different icons.

Icon	Setting	Description
None	Normal	Camera automatically selects focus, aperture and shutter speed. This is the default setting when the camera is first turned on.
	Self-Timer	Camera waits 10 seconds after the Video button or Shutter button is pressed to take a video clip or a picture. See Using self-timer mode on page 35.
	Burst	Camera quickly takes multiple still pictures (as long as the Shutter button is held down). See Using burst mode on page 36.
	Macro	Camera takes extreme close-up pictures. See Using macro mode on page 36.

Icon	Setting	Description
	Action	Camera biases toward faster shutter speeds and higher ISO speeds to stop action.
	Landscape	Camera biases toward smaller apertures and lower ISO speeds for better depth of focus and quality.
	Portrait	Camera biases toward wider apertures to blur the background and uses lower contrast for professional-looking portraits.
F2.6	Aperture Priority	Sets the camera aperture to F2.6 for a shallow depth of field (background is blurred). All other camera settings are automatic.
F4.9	Aperture Priority	Sets the camera aperture to F4.9 for a medium depth of field (background is slightly blurred). All other camera settings are automatic.

Using self-timer mode

- 1 Secure the camera to a tripod or set it on a stable surface.
- 2 Press the Mode button until the **Self-Timer**  icon appears in the Status LCD. If **Live View** is on, the icon also appears in the Image Display.
- 3 Frame the subject in the viewfinder.
- 4 The next steps depend on whether you are capturing a still picture or a video clip:

When capturing:	Procedure
Still picture	<ol style="list-style-type: none">1 Press the Shutter button halfway down for Focus Lock. The camera measures and then locks the focus and exposure. The camera will hold these settings until it takes the picture.2 Press the Shutter button all the way down. A 10-second countdown appears on the Status LCD. <p>If you immediately press the Shutter button all the way down without using Focus Lock, the camera will lock focus and exposure just before the end of the 10-second countdown. This is useful when one or more subjects will be entering the picture during the 10-second countdown period.</p> <p>You cannot record audio when using the Self-Timer, but you can add an audio clip later (see page 51).</p>
Video clip	<ol style="list-style-type: none">1 To start recording, press the Video  button and then release it. A 10-second countdown appears on the Status LCD.2 To stop recording the video clip, press the Video  button again.

NOTE The Video/Self-Timer light on the front of the camera blinks before the camera takes the picture or video clip.

Using burst mode

Burst is used to take multiple pictures in a row as quickly as the camera can.

- 1 Press the **Mode** button until the **Burst**  icon appears on the Status LCD. If **Live View** is on, the icon also appears in the Image Display.
- 2 Frame the subject and press the **Shutter** button all the way down and hold it.
- 3 Flash is disabled and the camera takes pictures as quickly as possible until the memory is full or the **Shutter** button is released.

Using macro mode

You can use the **Macro** focus setting for taking close-up pictures (from 0.1 m (4 inches) to 0.5 m (19.7 inches)).

- 1 Press the **Mode** button until the **Macro**  icon appears on the Status LCD. If **Live View** is on, the icon also appears in the Image Display.
- 2 Use the Image Display to frame the subject of the picture (the optical viewfinder will not give you an accurate representation of a picture taken in macro mode).
- 3 Press the **Shutter** button all the way down to take the picture.

Advanced capture settings

The **Capture** menu allows you to adjust various camera settings that affect the qualities of the images and video clips you capture with your camera. From this menu you can also access the **Setup** menu to set a number of preferences on the camera.

To display the **Capture** menu:

- 1 Press the **OK** button at any time when the Image Display is turned off, or when **Live View** is turned on in the Image Display.



- 2 Use the **▲ ▼** buttons to scroll through the **Capture** menu options.
- 3 Press the **OK** button to select a highlighted option and display its sub-menu.
- 4 Within a sub-menu, use the **▲ ▼** buttons and the **OK** button to change the setting for the **Capture** menu option.
- 5 To exit the **Capture** menu, highlight the **← EXIT CAPTURE MENU** option and press the **OK** button.

Each of the **Capture** menu settings is explained in detail on the following pages.

EV compensation

In difficult lighting conditions, you can use the **EV** (Exposure Value) **Compensation** setting to override the automatic exposure setting that the camera makes.

EV Compensation is useful in backlit scenes involving a person, or in scenes that contain many light objects (like a white house in the snow) or many dark objects (like a black cat on a dark background). Scenes containing many light objects or many dark objects could turn out gray without the use of EV Compensation. For a scene with many light objects, increase the EV Compensation to a positive number to produce a brighter result. For a scene with many dark objects, decrease the EV Compensation to darken the scene to be closer to black.

1 In the **Capture** menu, select **EV Compensation**.

2 In the **EV Compensation** menu, use the ▲ ▼ buttons to change the EV setting in 0.5 steps from -2.0 to +2.0. The new setting is applied to the **Live View** screen behind the menu, so you should be able to see the effect the setting will have on the picture.

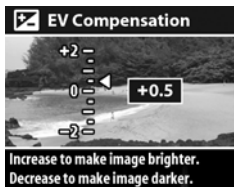

3 Press **OK** to save the setting and return to the **Capture** menu.

If the setting is anything other than the default setting of 0 (zero), the number value will appear at the top of the **Live View** screen.

The new setting remains in effect until it is changed again or until the camera is turned off.

White balance

Different kinds of lighting conditions cast different colors. For example, sunlight is more blue, while indoor tungsten light is more yellow. Scenes dominated by a single color may require an adjustment of the white balance setting to help the camera reproduce colors more accurately and ensure that whites appear white in the final picture. You can also adjust the white balance to produce creative effects. Using the **Sun** or **Tungsten** settings can produce a warmer look to the picture, and the **Shade** setting can make a sunset picture look more orange.

1 In the **Capture** menu, select **White Balance**.

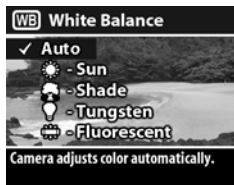

2 In the **White Balance** menu, use the ▲ ▼ buttons to select a setting. The new setting is applied to the **Live View** screen behind the menu, so you should be able to see the effect the setting will have on the picture.



3 Press **OK** to save the setting and return to the **Capture** menu.

The following table helps explain the settings in more detail.

Icon	Setting	Description
None	Auto	Camera automatically identifies and corrects for scene illuminance. This is the default setting, and the white balance is reset to Auto when you turn the camera off.
	Sun	Camera balances color assuming it is outdoors under sun or bright cloudy conditions.

Icon	Setting	Description
	Shade	Camera balances color assuming it is outdoors in shade, twilight, or dark cloudy conditions.
	Tungsten	Camera balances color assuming incandescent or halogen lighting (typically found in homes).
	Fluorescent	Camera balances color assuming fluorescent lighting.

If the setting is anything other than the default setting of **Auto**, the icon for the setting (in the table above) will appear at the top of the **Live View** screen.

The new setting remains in effect until it is changed again or until the camera is turned off.

ISO speed

The **ISO Speed** setting adjusts the sensitivity of the camera to light. The **Auto** setting works the best.

NOTE If the camera is in **Action**, **Landscape**, **Portrait**, **F2.6** or **F4.9** mode, the ISO speed will always be set to **Auto** and the ISO option in the **Capture** menu will be grayed out.

Lower ISO speeds will capture the best quality pictures with the least amount of noise or grain. If taking a picture in low light conditions without a flash at ISO 100, you may want to use a tripod.

Higher ISO speeds allow higher shutter speeds and thus can be used when taking pictures in dark areas without a flash, or when taking pictures of fast moving objects and you want to stop action. Higher ISO speeds produce pictures with more grain and thus lower quality.

- 1 In the **Capture** menu, select **ISO Speed**.
- 2 In the **ISO Speed** menu, use the ▲ ▼ buttons to select a setting.
- 3 Press **OK** to save the setting and return to the **Capture** menu.

If the setting is anything other than the default setting of **Auto**, the number value for the setting will appear at the top of the **Live View** screen.

The new setting remains in effect until it is changed again or until the camera is turned off.





AE metering

This setting allows you to specify which region of a scene the camera will use to calculate the exposure.

- 1 In the **Capture** menu, select **AE Metering**.
- 2 In the **AE Metering** menu, use the ▲ ▼ buttons to select a setting.
- 3 Press **OK** to save the setting and return to the **Capture** menu.



The following table helps explain the settings in more detail.

Icon	Setting	Description
	Average	Camera uses the entire scene region to measure and calculate exposure. Use this setting when you want everything in the picture to be used equally when calculating exposure.
None	Center-Weighted	Camera uses the center of the scene region to measure and calculate exposure. This setting is good to use when the subject is in the center of the frame. Exposure will be based more on the subject than on its surroundings. This is the default setting.
	Spot	Camera uses a small area in the center of the scene region to measure and calculate exposure. This can be useful in backlit scenes or when the subject is very dark or light compared to the rest of the scene. When using this setting, press the Shutter button halfway down to lock the exposure on the spot in the center, then recompose the scene as desired.

If the new setting is anything other than the default setting of **Center-Weighted**, the icon for the setting (in the table above) will appear at the top of the **Live View** screen.

The new setting remains in effect until it is changed again or until the camera is turned off.

Saturation

This setting allows you to determine how saturated the colors will be in your pictures.



1 In the **Capture** menu, select **Saturation**.

2 In the **Saturation** menu, use the ▲ ▼ buttons to select a setting. The new setting is applied to the **Live View** screen behind the menu, so you should be able to see the effect the setting will have on the picture.



3 Press **OK** to save the setting and return to the **Capture** menu.

The following table helps explain the settings in more detail.

Icon	Setting	Description
	High	Emphasizes more vivid colors in a scene. Outdoor landscape photography can use high saturation to create skies that are more blue, or sunsets that are more orange.
None	Medium	Colors will be normally saturated. This is the default setting.
	Low	Mutes colors to achieve a faded photographic look. When taking portrait pictures, low saturation can give a softer, more "natural" look to the subject.

If the new setting is anything other than the default setting of **Medium**, the icon for the setting (in the table above) will appear at the bottom of the **Live View** screen.

The new setting remains in effect (even if you turn the camera off) until it is changed again.

Sharpness

This option allows you to set how sharp the edges will be in your pictures.

1 In the **Capture** menu, select **Sharpness**.

2 In the **Sharpness** menu, use the ▲ ▼ buttons to select a setting. The new setting is applied to the **Live View** screen behind the menu, so you may be able to see the effect the setting will have on the picture.



3 Press **OK** to save the setting and return to the **Capture** menu.

The following table helps explain the settings in more detail.

Icon	Setting	Description
	High	The edges in your image will be more pronounced.
None	Medium	The edges in your image will have normal sharpness.
	Low	The edges in your image will be softer.

If the new setting is anything other than the default setting of **Medium**, the icon for the setting (in the table above) will appear at the bottom of the **Live View** screen.

The new setting remains in effect (even if you turn the camera off) until it is changed again.

Setup











For information about the **Setup** menu, see **Chapter 6: Using the setup menu** on page 67.

Chapter 3:

Reviewing images and video clips

You can use the **Playback** feature to review the images and video clips in your camera. In addition, the **Playback** menu allows you to delete images or video clips, rotate or magnify still images, and add, change, or delete audio clips.

Using playback

- 1 Press the **Playback**  button to activate **Playback** mode. The most recently taken or viewed image or video clip appears on the Image Display.
- 2 Use the   buttons to scroll through your images and video clips. Press and hold the   buttons to scroll automatically.
 - Still images that have audio clips attached to them will automatically play the audio clip. To replay the audio clip, press the  button. Pressing the  button before, during, or after audio playback skips to the next image.
 - Video clips will play automatically after a few seconds. To replay the video clip, press the  button. Pressing the  button before, during, or after video playback skips to the next image.
- 3 To turn the Image Display off after reviewing your images and video clips, press the **Playback**  button again.





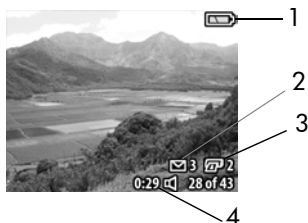

During **Playback**, some information about each image or video clip is also displayed. The following table describes the information.

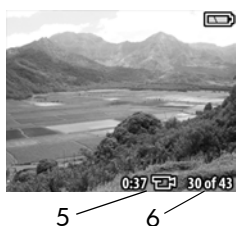

Still image



Video clip







#	Icon	Description
1	 or 	<ul style="list-style-type: none"> Battery level (actual icon shown depends on the state of your camera batteries). Camera is using AC power from the optional HP 8886 camera dock or HP AC power adapter.
2	 3	Indicates this image has been marked for e-mailing using HP Instant Share (this example shows that it will be e-mailed to 3 destinations).
3	 2	Indicates this image has been marked for printing using HP Instant Share (this example shows that 2 copies will be printed).
4	0:29 	Indicates this image has an audio clip and the clip is 29 seconds long.
5	0:37 	Indicates this is a video clip that is 37 seconds long.
6	30 of 43	Shows the current image number from the total number of images taken.

NOTE Other icons besides the e-mail  or print  icons may appear, depending on what other destinations have been selected for that image using **HP Instant Share**.

Using the playback menu

The **Playback** menu allows you to view additional information about each image, rotate still images, delete images, magnify still images, and add, change, or delete audio clips. From this menu you can also access the **Setup** menu to set a number of preferences on the camera.

To use the **Playback** menu:

- 1 Press the **Playback**  button to activate **Playback**, then use the   buttons to move to the image or video clip you want.
- 2 Press the **OK** button to display the **Playback** menu.
- 3 Use the   buttons to highlight the menu options on the left of the **Image Display**. In order to let you see more of the image you are reviewing, the label of each menu option only appears when you highlight the menu option.



NOTE In the **Playback** menu, an additional line of information about the image appears in the lower-right corner of the **Image Display**. It includes the date the picture was taken, the quality setting used, and the digital zoom setting used (if any).

- 4 To select a highlighted menu option, press **OK**. Each of the **Playback** menu options are explained later in this section.
- 5 To exit the **Playback** menu and return to viewing images in **Playback**, highlight the  **Exit Playback Menu** option and press **OK**.

Viewing thumbnail images



This **Playback** menu option lets you see up to nine images at a time, allowing you to quickly navigate to a specific image.

- 1** In **Playback** mode, press **OK** to display the **Playback** menu, then press **OK** again to select the **View Thumbnails** option.
- 2** Scroll through the thumbnail images using the ▲ ▼ buttons. The current image is highlighted with a yellow border. Information about the selected image appears at the bottom of the screen, such as whether it has been selected for **HP Instant Share**, whether it is a video clip, or whether an audio clip is attached to a still image.
- 3** Press the **OK** button to display the currently selected image or video clip.



Rotating images



NOTE This option works only with still images, not video clips.

- 1 In **Playback** mode, select the image you want, then press **OK** to display the **Playback** menu.
- 2 Select the  **Rotate** option and press **OK**. The image you were viewing in **Playback** is automatically rotated 90 degrees clockwise.
- 3 After the image has been rotated, you can rotate it again in either direction using the   buttons.
- 4 When you are ready to save the rotated image, press the **OK** button. The camera will save the rotated image, and then return to the **Playback** menu.



NOTE Before you press the **OK** button in step 4 above, you can cancel the rotation by pressing the **Live View** or **Playback** button.

Deleting images

- 1 In **Playback** mode, select the image you want, then press **OK** to display the **Playback** menu.
- 2 Select the  **Delete** option and press **OK**.
- 3 In the **Delete** sub-menu, use the   buttons to highlight the option you want, and then press **OK**. These options include:





- **Cancel**—Returns to the **Playback** menu without deleting anything.
- **This Image**—Deletes the currently displayed image or video clip, then returns to the **Playback** menu.
- **All Images in Memory (on Card)**—Deletes all of the images and video clips from internal memory or the memory card, then displays a screen verifying that there are no images left in memory.
- **Format Memory (Card)**—Deletes all of the images, video clips, and files from internal memory or the memory card, and then formats the internal memory or memory card. A screen appears verifying that there are no images left in memory.

NOTE Periodic formatting of the internal memory or memory card will keep it clean of file remnants that may cause the camera to lock up, save images slowly, or corrupt images.

Recording and deleting audio clips

NOTE This option works only with still images, not video clips.

After taking a still picture, you can go back later and add an audio clip to it. If an image already contains an audio clip, you can record a new clip or delete the current audio clip.

- 1 In **Playback** mode, select the image you want, then press **OK** to display the **Playback** menu.
- 2 Select the  **Record Audio** option.
- 3 If the image does not already have an audio clip, recording starts immediately. Recording will continue until you press **OK** again or the memory fills up (whichever comes first). A microphone icon () and an elapsed time counter appear in the middle of the Image Display during recording.



If the current image already has an audio clip, the  **Record Audio** menu option will take you to a sub-menu that allows you to keep the current audio clip, record a new clip, or delete the current clip.



Magnifying images

NOTE This option works only with still images, not video clips.

You can use this option to see a close-up of the image that is being shown in **Playback** mode. This option does not permanently alter the image in the camera.

- 1 In **Playback** mode, select the image you want, then press **OK** to display the **Playback** menu.
- 2 Select the **Magnify** option. This magnifies the current image to three times its size.
- 3 Scroll up or down in the image by using the ▲ ▼ buttons.
- 4 To scroll left and right, press **OK** to display the **Magnify** menu. Highlight the menu option called **Scroll Left/Right**, then press **OK**. Now you can use the ▲ ▼ buttons to scroll left and right in the image.
- 5 To magnify the image to six times its size, press **OK** to display the **Magnify** menu, then select ⚙ **Magnify More**.
- 6 To return to **Playback** mode, select the ↶ **Exit Magnify** option, or press the **Playback** ▶ button.



Setup

Selecting this **Playback** menu option displays the **Setup** menu. For information about the **Setup** menu, see **Chapter 6: Using the setup menu** on page 67.





Chapter 4:

Using hp instant share

This camera has an exciting feature called **HP Instant Share**. This feature lets you select images in the camera to be automatically sent to a variety of destinations the next time you connect the camera to your computer or to certain HP printers.

For example, right from the back of the camera you can select images that you want to have printed, then connect the camera to the computer or printer, and the selected images will be printed automatically.

As another example, you can select images in the camera to be automatically sent to e-mail addresses (including group lists), online albums, and a photo finishing service the next time you connect the camera to your computer.





When you press the **HP Instant Share (Share)** /  button on the camera, the most recently taken or viewed image appears on the Image Display, along with any print or other destinations that have been selected for the image. You can use the   buttons to scroll through the images to see destinations for the other images in the camera.

Visit www.hp.com/go/instantshare to see **HP Instant Share** in action.



Using the share menu

Pressing the Share  button causes the Share menu to appear in the Image Display. The following table describes each of the Share menu options.







#	Icon	Description
1		Print 1 Copy of current image when connected to a computer or printer. By default, the picture is printed 10 by 15 cm (4 by 6 inches).
2		Print 2 Copies of current image when connected to a computer or printer.
3		Customize this Menu... lets you add e-mail addresses and other destinations (such as Order Prints and Upload to HP Photo website) to the Share menu. See Adding destinations to the share menu on the camera on page 56.
4		Check mark indicates the destination has been selected for the currently displayed image. (You can select more than one destination per image.)



Using hp instant share to print pictures

- 1 Press the **Playback**  button to display the images in your camera, then use the   buttons to scroll to an image you want to print.

NOTE You cannot select video clips for printing.

- 2 Press the **Share** /  button to activate the **Share** menu, and then use the   buttons to scroll to the print option you want.
- 3 Press **OK** to select the print option, and a  appears over that print option. To un-select a print option, simply press **OK** again.

NOTE You can select both the **Print 1 Copy** and the **Print 2 Copies** print options for an image so that 3 copies of the image will be printed when connected to a computer or printer.

- 4 To select another image for printing, go back to step 1. When you are finished selecting all the images you want to print, simply press the **Playback**  button or select  **EXIT SHARE MENU**.
- 5 The next time you connect the camera to your computer or a compatible printer, the images you selected will be automatically printed. See **Chapter 5: Unloading, printing, and displaying images** on page 61 for information about connecting the camera to a computer or printer.

NOTE The **Share** menu creates a standard Digital Print Order Format (DPOF) file for print options.



Using hp instant share to send images to destinations

Using HP Instant Share to send images in your camera to various destinations involves three steps:

- 1 Adding destinations (e-mail addresses, online albums, a photo finishing service, etc.) to the camera's **Share** menu (using your computer and the camera together).
- 2 Selecting **HP Instant Share** destinations for images (using the **Share** menu on the camera).
- 3 Connecting the camera to your computer to send the images you selected. Your computer must have access to the Internet to complete this step.

Adding destinations to the share menu on the camera

NOTE You will need an Internet connection to complete this procedure on a Windows computer.

- 1 Turn on the camera, and then press the **Share**  button.
- 2 Highlight the **Customize this Menu...**  option and press the **OK** button. A message on the Image Display appears asking you to connect the camera to your computer.

NOTE If your computer is running Windows XP, when you connect the camera to your computer in the next step, a dialog box will display that requests you to **Select the program to launch for this action**. Simply click on **Cancel** to close this dialog box.

- 3 Connect the camera to your computer by using the USB cable or the optional HP 8886 camera dock. This activates the Camera Share Menu Setup Wizard.

- 4 From the first window of the Wizard on the computer, click on **Retrieve from Camera**.
- 5 In the screen called **Modify Share Menu**:
 - On Macintosh, click on the **Add...** button.
 - On Windows, check to see that **HP Instant Share E-mail** is visible above the **Add...** button, then click on the **Add...** button.
- 6 If you are using a:
 - Macintosh computer, add the e-mail addresses you want. Then skip to step 8.
 - Windows computer, you will be asked to sign in to HP's Passport program. HP Passport allows you to create a secure account for the photos you share using **HP Instant Share** services. The first time you see this screen, you will need to register as a new user. Follow the instructions on the screen to register.
- 7 Once you have successfully registered, sign in to HP Passport, and then the **HP Instant Share E-mail Setup** screen will appear. Here, you can either enter individual e-mail addresses or create group distribution lists, and specify how you want them to appear in the camera's **Share** menu. You can also enter a subject and message to go with all e-mails that will be sent to each e-mail address or distribution list. After completing the form, click **Next**. In the confirmation screen that appears, click **Finish**.











- 8 The names you specified for your newly added e-mail destinations or group distribution lists should now appear in the **Modify Share Menu** screen (in the **Current Share Menu** section). To add additional e-mail addresses or distribution lists to the camera **Share** menu, repeat steps 5-7 on Windows, or steps 5-6 on Macintosh. If you are using a Windows computer, you will not need to sign in to the HP Passport program again.

NOTE You can have a maximum of 32 **Share** destinations (such as individual e-mail addresses or group distribution lists) in the **Share** menu on your camera in addition to **Print 1 Copy** and **Print 2 Copies**.

- 9 When you have finished adding **Share** destinations, click on either **Save to Camera** on a Windows computer or **Next** on a Macintosh computer to add the new addresses or distribution lists to the camera's **Share** menu. When the computer confirms that the addresses or lists were saved to your camera, disconnect the camera from the computer, and press the **Share**  button to view the new destinations in the **Share** menu.
- 10 You are now ready to select images on the camera to be e-mailed. See the next section for how to do this.

Selecting hp instant share destinations for images

You can select any number of HP Instant Share destinations for each still image in your camera. For example, you can select a specific image to go to 10 e-mail destinations (including group lists), an online album, and to a professional-quality photo finisher. However, you cannot select **HP Instant Share** destinations for video clips.

- 1 Press the **Playback**  button to display the images in your camera, then use the   buttons to scroll to an image you want.
- 2 Press the **Share** /  button to activate the **Share** menu, and then use the   buttons to scroll to the **HP Instant Share** destination that you want to select.
- 3 Press **OK** to select the destination, and a  appears next to that destination. (You can select more than one destination or print option for an image.) To un-select a destination, simply press **OK** again.
- 4 To select one or more destinations for another image, go back to step 1. When you are finished selecting **HP Instant Share** destinations, press the **Playback**  button or select  **EXIT SHARE MENU**.
- 5 The next time you connect the camera to your computer, the images you selected for e-mail will be sent to their respective destinations. See **Chapter 5: Unloading, printing, and displaying images** on page 61 for information about connecting the camera to a computer.

How hp instant share e-mails images

The way images are e-mailed via HP Instant Share works differently on Windows and Macintosh computers.

Windows	Images are not e-mailed as attachments. Rather, a message is sent to each e-mail address that you selected in the Share menu. The message contains thumbnail images of the pictures you selected for that address, as well as a link to a web page where the recipient can view the images. From that web page, the recipient can do things like reply to you, print the images, save images to their computer, forward images, and more. This makes it easy for people who use different e-mail programs to be able to see your images without the difficulty of dealing with e-mail attachments.
Macintosh	Images are e-mailed directly to recipients using the default e-mail program on your computer.

Chapter 5: Unloading, printing, and displaying images

Once you have taken pictures, you can unload them from your camera to a computer, print them directly to a printer, or display them on a television.

Unloading to a computer

NOTE If you are using the HP 8886 camera dock to do this task, see the *HP 8886 Camera Dock User's Manual*.

NOTE If you are using a Macintosh computer, you must first change the USB configuration setting to **Disk Drive** in the **Setup** menu. See **USB configuration** on page 69.

- 1 Your camera came with a special USB cable for connecting the camera to a computer. Connect the larger end of that USB cable to the computer.
- 2 Open the rubber door on the side of the camera and connect the small end of the USB cable to the USB connector on the camera.

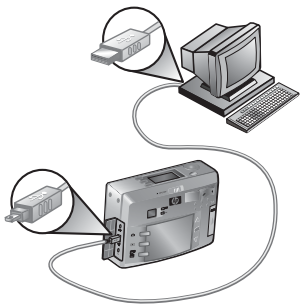

NOTE If your computer is running Windows XP, when you turn on the camera in the next step, a dialog box may appear that requests you to **Select the program to launch for this action**. Simply click on **Cancel** to close this dialog box.

- 3 Turn on the camera. The HP Image Unload software will launch on your computer. If you have set the software to automatically unload the images in the camera, the images will automatically unload to the computer. Otherwise, in the **Welcome** screen, click **Start Unload**. If there were any images in the camera that were selected in the **Share** menu for printing or **HP Instant Share** destinations, those actions are started after the images have been unloaded to the computer.
- 4 When the unload screen on the computer says **Finished**, your images have been saved and shared. You can now disconnect the camera from the computer.

NOTE To unload images to a computer that does not have the HP Photo & Imaging software installed on it, change the **USB Configuration** setting to **Disk Drive** in the **Setup** menu. See **USB configuration** on page 69. This allows the camera to appear as another disk drive on the computer so that you can easily copy the image files from the camera to the hard drive of your computer.

NOTE If you used a memory card in your camera, another way to unload images from the card to a computer is to use a memory card reader or one of the memory card slots available in HP Photosmart printers. See the manual for your HP Photosmart printer for instructions on how to do this.

Printing images

NOTE If you are using the HP 8886 camera dock to do this task, see the **HP 8886 Camera Dock User's Manual**.

To print images that have been unloaded to the computer, you can use the HP Photo & Imaging software that was shipped with the camera.

You can also connect the camera directly to any HP Photosmart printer or to any other HP printer with front panel USB ports, then print images selected from the camera **Share** menu or all images in the camera.

To print directly to an HP Photosmart printer or to any other HP printer with front panel USB ports:

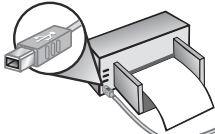
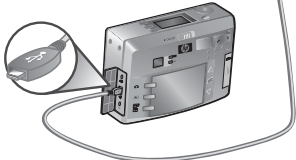
- 1 Turn on the camera.
- 2 Check that the printer is turned on and is online. (There should be no blinking lights on the printer or error messages displayed about the printer.) Load paper into the printer, if needed.
- 3 Your camera came with a special USB cable for connecting the camera directly to a printer. Connect the square end of the USB cable to the printer.
- 4 Open the rubber door on the side of the camera and connect the small end of the USB cable to the USB connector on the camera.

The **Print Setup** menu displays on the camera. If you already selected images to print from the camera **Share** menu, the number of images selected will be shown, as in this example. Otherwise, **Images: ALL** will be displayed.

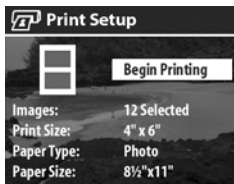

- 5 Adjust the settings in the **Print Setup** menu by using the ▲ ▼ buttons to highlight a menu option and the **OK** button to change the setting for each option.

NOTE There is a print preview in the **Print Setup** screen showing the page layout that will be used for printing images. This print preview updates as you change the settings for the **Print Size** and **Paper Size**.

- 6 Press the **OK** button to begin printing.

NOTE If you used a memory card in your camera, another way to print images directly from the card is to insert the card into the appropriate memory card slot available in HP Photosmart printers. See the manual for your HP Photosmart printer for instructions on how to do this.

Displaying images on a TV

Images in your camera can easily be displayed as a slideshow on almost any TV (television).

NOTE If you are using the HP 8886 camera dock to do this task, see the **HP 8886 Camera Dock User's Manual**.

- 1** To connect the camera directly to a TV, you need an A/V (Audio/Video) cable. The A/V cable is included in the HP 8886 camera dock kit, or may be purchased separately (see **Purchasing camera accessories** on page 102).
- 2** Your camera will send either an NTSC or PAL video signal to a TV. The NTSC format is used primarily in North America and Japan, while the PAL format is used primarily in Europe. This setting is done for you when you set the language of the camera. If you want to change the video signal format, change the **TV Configuration** setting in the **Setup** menu. See **TV configuration** on page 70.
- 3** Your camera will be the source for the TV signal (just like a VCR or a camcorder), so you must set the TV to take video input from an external video source (your camera) instead of the antenna or cable TV. Refer to the TV user's manual for directions on how to do this.
- 4** Turn on the camera, then connect the A/V cable to the A/V inputs on the TV and to the TV connector on your camera.

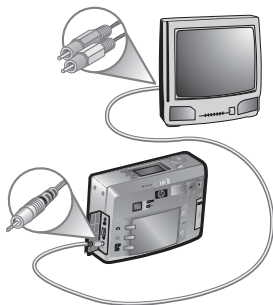

The camera starts a slideshow of each image, playing any attached audio clip or video clip, and then fading to the next image. You can also manually scroll through the images by pressing the ▲ ▼ buttons.

NOTE The Image Display on the camera turns off when the camera is connected to a TV. However, you can still use the **Playback** and **Share** menus while connected to the TV, since the menus will display on the TV screen.

Chapter 6: Using the setup menu

- 1 To display the **Setup** menu, open either the **Playback** or **Capture** menu and use the ▲ ▼ buttons to highlight the **Setup** menu option. (For information about these other menus, see **Using the playback menu** on page 47 and **Advanced capture settings** on page 37.)

Playback Menu



Capture Menu

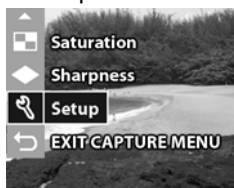

- 2 Use the ▲ ▼ buttons to scroll through the **Setup** menu options.
- 3 Press the **OK** button to select a highlighted option and display its sub-menu.
- 4 Within a sub-menu, use the ▲ ▼ buttons and the **OK** button to change the setting for the **Setup** menu option.
- 5 To exit the **Setup** menu, highlight the ◀ **EXIT SETUP MENU** option and press the **OK** button.



Camera sounds

This **Setup** menu option allows you to set the volume level of the camera sounds, or turn camera sounds off.

Camera sounds are the sounds that the camera makes when you turn it on, press a button, or take a picture. Camera sounds are not the audio sounds recorded with images or video clips.

The default setting is **Low**.

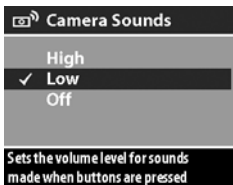

Date & time

This **Setup** menu option allows you to set the current date and time, as well as the date/time format, for the camera. This is usually done when you first set up the camera, but you may need to re-set the date and time when you are travelling to different time zones, or when the batteries are removed from the camera for more than 10 minutes.

To set the date, time, and date/time format, follow the same procedure used in **Setting the date and time** on page 19.



USB configuration

This **Setup** menu option determines how the camera appears when connected to a computer.

- **Digital Camera**—Causes the computer to recognize the camera as a digital camera using the Picture Transfer Protocol (PTP) standard. This is the default setting on the camera.
- **Disk Drive**—Causes the computer to recognize the camera as a disk drive using the Mass Storage Device Class (MSDC) standard.

Use this table as a guide for which USB Configuration setting to use with your computer:

HP Photo & Imaging software:	Windows	Macintosh
Installed	Digital Camera	Disk Drive
Not installed	Disk Drive	Digital Camera (OSX systems)



TV configuration

This **Setup** menu option sets the format of the video signal for displaying camera images on a television (TV) that is connected to the camera with an optional Audio/Video cable or HP 8886 camera dock.



- **NTSC**—format used primarily in North America and Japan
- **PAL**—format used primarily in Europe

The default setting depends on the language that you selected when you powered on the camera for the first time.

For more information on connecting the camera to a TV, see either **Displaying images on a TV** on page 65 when using an optional Audio/Video cable, or the **HP 8886 Camera Dock User's Manual** when using the camera dock.

Language

This **Setup** menu option sets the language of the camera interface, including the text in menus and on the Image Display. The default setting is **English**.

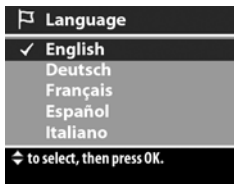

To set the language on the camera, follow the same procedure used in **Choosing the language** on page 18.

Move images to card

This **Setup** menu option lets you move images from the camera's internal memory to a memory card. It appears in the **Setup** menu only if a memory card is installed and internal memory contains at least one image.

If there is room to move all the internal files to the memory card, then this confirmation screen appears. If you select **Yes** to move images, they are moved to the card, and all moved images are deleted from internal memory.



If only some of the images will fit on the memory card, this screen appears which allows you to move as many images as the card will hold. The moved images will be deleted from internal memory, and the images that could not be moved will be retained in internal memory.



NOTE When a memory card is inserted, only the images on the card can be viewed on the Image Display. To view the images stored in internal memory, remove the memory card.

Chapter 7: Troubleshooting and support

Problems and solutions

NOTE If you still cannot solve your problem after reviewing the troubleshooting information provided in the following table, you can run diagnostic tests on your camera to try to isolate and solve the problem yourself. The diagnostic tests for this digital camera are provided on the following website:

www.hp.com/support

Problem	Possible cause	Solution
The camera does not turn on.	The batteries are functioning incorrectly, are dead, are installed incorrectly, or are missing.	<p>The charge in the batteries can be low or completely drained. Try installing new or recharged batteries.</p> <p>Ensure that the batteries are inserted correctly.</p> <p>Do not use ordinary alkaline batteries. For best results, use photo-lithium batteries or rechargeable NiMH batteries. If you must use alkaline batteries, use high-grade "ultra" or "premium" varieties.</p>

Problem	Possible cause	Solution
The camera does not turn on. (continued)	The HP AC adapter is not connected to the camera, or is not plugged into a power outlet.	Ensure that the HP AC power adapter is: <ul style="list-style-type: none"> ● connected to the power adapter connector of the camera ● plugged into a working electrical outlet
	The HP AC power adapter is not functioning correctly.	Ensure that the HP AC adapter is not damaged or defective and is plugged into a working electrical outlet.
	The memory card is defective or contains corrupt images.	Remove the memory card.
I replace the camera batteries frequently.	The NiMH batteries you are using were recharged incorrectly, or have drained on their own because they have not been used lately.	When NiMH batteries are brand new or have not been used in several months, they should be charged and fully drained 3-4 times to reach optimum capacity. Also, NiMH batteries discharge on their own when not in use and when not installed in the camera. So if you have not used them in a week or more, they may benefit from being charged.

Problem	Possible cause	Solution
I replace the camera batteries frequently. (continued)	Extended Image Display use for Live View or video recording, excessive flash use, and excessive zooming consume a lot of battery power.	Minimize the use of Live View and video, especially if using ordinary alkaline batteries. Also use the flash and zoom only when necessary.
		Use an HP AC power adapter to power the camera when you are using the Image Display for an extended period of time, or use the viewfinder instead of the Image Display whenever possible. Do not use ordinary alkaline batteries. For best results, use photo-lithium batteries or rechargeable NiMH batteries. If you must use alkaline batteries, use high-grade "ultra" or "premium" varieties. (See page 99)
The camera batteries will not charge.	Rechargeable batteries are not inserted.	Install NiMH batteries. Lithium and alkaline batteries cannot be recharged.
	Batteries are already charged.	Battery charging will not start if the batteries were recently charged. Try charging them again after they have drained awhile.

Problem	Possible cause	Solution
The camera batteries will not charge. (continued)	Battery voltage is too low for charging to start.	The camera will not attempt to charge batteries that may be damaged or over-discharged. Remove the batteries from the camera and charge them in an external battery charger, then try them in the camera again. If this does not work, it is likely that one or more of the batteries are bad. Purchase new NiMH batteries and try again.
	The wrong AC power adapter is being used.	Use only the HP AC power adapter approved for use with this camera. See Purchasing camera accessories on page 102.
	The batteries are damaged or bad.	NiMH batteries degrade over time and can fail. If the camera detects a problem with the batteries, it will not start charging or will stop charging prematurely. Purchase new batteries.
The Memory/USB light blinks as if the batteries are being recharged, but there are no batteries installed.	The camera does not recognize that there are no batteries installed.	Do nothing. The blinking is harmless and should stop after 5-30 minutes.

Problem	Possible cause	Solution
The wrong date and/or time is shown.	The batteries died or were removed from the camera for too long.	The date and time will be maintained for about 10 minutes without batteries installed. Reset the date and time by using the Date & Time option in the Setup menu. (See page 68, 68)
The camera does not respond when I press a button.	The camera is turned off or has shut down.	Turn on the camera, or turn it off and then on again.
	The camera is connected to a computer.	Most of the camera buttons, except for the ► ON/OFF switch, do not respond when the camera is connected to a computer. If they respond, it is only to turn the Image Display on if it is off, or, in some cases, turn the Image Display off if it is on.
	The batteries are drained.	Replace or recharge the batteries.
	Images in the memory card may be corrupted.	Remove the memory card.
	The camera has stopped operating.	Reset the camera by holding the ► ON/OFF switch in the ON position until the Image Display turns on.

Problem	Possible cause	Solution
A long delay occurs between pressing the Shutter button and the camera taking a picture.	The camera needs time to lock focus and exposure.	Use Focus Lock . (See page 23.)
	The camera is taking a long exposure.	Use a tripod or the flash.
	The camera is set to Red-eye Reduction .	It will take longer to take a picture with Red-eye Reduction set to On . The shutter is delayed because of the additional flash. In turn, make sure your subjects wait for the second flash.
The camera does not take a picture when I press the Shutter button.	You did not press the Shutter button hard enough.	Press the Shutter button all the way down.
	The memory storage is full (either internal or card).	Unload images from the camera to your computer, then delete all images from internal memory or the memory card. Move images from internal memory to a memory card to free up internal memory, or replace the card with a new one.
	The memory card is locked.	Switch the locking tab on the memory card to the unlocked position.
	The flash is recharging.	Wait until the flash has recharged before taking another picture.

Problem	Possible cause	Solution
The camera does not take a picture when I press the Shutter button. (continued)	The camera is still saving the last picture you took.	Wait a few seconds for the camera to finish processing the image, and then press the Shutter button.
	Images in the memory (internal or card) may be corrupted.	Format the memory. (See page 50)
My image is blurry.	Your subject was too close to the camera lens.	Use Macro mode for close-up shots. Do not try to get closer than the camera's minimum focus range (See Using macro mode on page 36)
	You moved the camera while you took the picture.	Hold the camera steady as you press the Shutter button or use a tripod.
	The light is low and the flash is set to Flash Off .	In dim light, the camera requires a longer exposure. Use a tripod to hold the camera steady, improve lighting conditions, or the flash To Flash On (see page 30).
	The camera focused on the wrong thing, or was unable to focus.	Use Focus Lock . (See page 23.)

Problem	Possible cause	Solution
My image is too bright.	The flash provided too much light.	Use the Flash Off setting (see Using the flash on page 30).
	You were too close to the subject to use the flash.	Move back from the subject or set the flash to Flash Off and take the picture again.
	A natural or artificial source other than the flash provided too much light.	Try taking the picture from a different angle. Avoid pointing the camera directly toward a bright light or reflective surface on a sunny day. Use the Flash On setting (see page 30) or adjust the Exposure Compensation (see page 38).
	The scene had many dark objects, such as a black dog on a black couch.	Decrease the Exposure Compensation (see page 38) so the dark objects in the scene will not look “washed-out”.

Problem	Possible cause	Solution
My image is too dark.	There was not enough light.	Wait for natural lighting conditions to improve, add indirect lighting, or adjust the Exposure Compensation (see page 38).
	The flash was on, but the subject was too far away.	Make sure your subject is within the flash working distance (see Appendix B: Specifications on page 105) or try turning flash off (will require a longer exposure).
	A light shone behind the subject.	Use the Flash On setting (see page 30) to brighten the subject. Or adjust the Exposure Compensation (see page 38).
	Your finger blocked the flash.	Be sure to move your fingers away from the flash when you take a picture.
	The scene had many light-colored objects, such as a white dog in snow.	Increase the Exposure Compensation (see page 38) so the light-colored objects in the scene will not look “muddy.”

Error messages on the camera

Message	Possible cause	Solution
BATTERIES DEPLETED Camera is shutting down	Battery power is too low to continue operation.	Replace or recharge batteries, or use an optional HP AC adapter.
Batteries are too low for Live View	Battery power is too low to use Live View on the Image Display.	Take pictures with the optical viewfinder instead of the Image Display. Replace or recharge batteries, or use an optional HP AC adapter.
Batteries are too low to record a video clip	Battery power is too low and the camera will shut down soon.	Either recharge or replace the batteries.
Batteries cannot be charged	Either an error occurred during charging, an AC power disruption occurred during charging, the wrong AC power adapter is being used, batteries are defective, or no batteries are installed in the camera.	Retry charging the batteries a couple of times. If that fails, purchase new batteries and try again.

Message	Possible cause	Solution
Unsupported card	The card in the memory slot is not a memory card or is not a supported memory card.	Ensure that the memory card is the proper type for your camera. (See Appendix B: Specifications on page 105.)
Card is wrong format	The card is an unsupported format, such as FAT32.	Press OK (this should display the Format Card screen) or format the memory card by using the Format Card option in the Delete menu. This will delete all data on the card.
The card requires formatting	The memory card needs to be formatted.	Press OK (this should display the Format Card screen) or format the memory card by using the Format Card option in the Delete menu. This will delete all data on the card.
Card is unreadable	The memory card is not a supported card or the card is corrupted.	Ensure that the memory card is the proper type for your camera. (See Storage on page 105.) If it is the proper type, it is probably corrupted. Replace the memory card.
Unable to format	The memory card is damaged or unsupported	Replace the memory card.

Message	Possible cause	Solution
The card is locked	The locking tab on the side of the memory card is in the locked position.	Switch the locking tab to the unlocked position or insert a new card.
Insufficient memory on the card	Not enough room to copy any files from internal memory to the card.	Unload images from the camera to your computer, then delete all images on the memory card. Or replace the card with a new one.
Error saving video	Memory card was removed before the camera was finished writing to the card.	Always wait until the Memory/USB light stops blinking before removing the card from the camera.
1st screen: No card in camera 2nd screen: Error saving image Please reinsert the card	Memory card was removed before the camera was finished writing to the card.	Reinsert the memory card. Always wait until the Memory/USB light stops blinking before removing the card from the camera.
Invalid date	An attempt was made to enter an invalid date (such as 2/31/2003).	Press OK to clear the message, and then enter a valid date.

Message	Possible cause	Solution
Unsupported image file	You tried to magnify, rotate, to print an image that was taken with another camera.	Press OK to clear the message. You cannot do those operations on files that were not created by your camera.
Insufficient space in memory (on card) to complete request.	Insufficient room in internal memory or on the memory card to rotate an image.	Free up space on the card by deleting some images, or perform the rotation using computer software.
Communication error	Camera received an error code from the HP software on the computer.	Disconnect the USB cable (or lift the camera out of the HP camera dock), then re-connect and try again.
Charging Flash...	The camera is recharging the flash.	It takes longer to charge the flash when the batteries are low. If you see this message a lot, you may need to replace or recharge the batteries.
Card full or Memory full	Insufficient room in internal memory or on the memory card to save more images.	Unload images from the camera to your computer, then delete all images from the memory card or internal memory. Or put a new memory card in the camera.

Message	Possible cause	Solution
No images in memory or No images on card	There are no images or video clips in the camera and you are trying to review them.	Take some pictures or video clips.
Cannot display image	Possibly comes from copying images to the memory card from a computer, or a corrupted image caused by the camera not shutting down properly.	Use the HP software to edit the images copied on the memory card. Also, do not remove batteries or the memory card when the camera is turned on.
Unable to focus	The subject did not provide enough contrast for the camera to focus properly.	Use Focus Lock before taking the picture (see page 23).
Shaking hand icon	Camera is preparing to take a picture.	Camera must be held very still due to long exposure.
Focus too far	The focus distance is beyond where the camera can focus.	Make sure the camera is not set to Macro focus.

Message	Possible cause	Solution
Focus too close	The focus distance is closer than the camera can focus.	Set the camera to Macro focus, or if set to Macro focus, move further away from the subject. See Using macro mode on page 36.
Unknown USB device	The camera is connected to a USB device that it does not recognize.	Make sure that the camera is connected to a supported printer or computer.
Unable to communicate with printer	There is no connection between the camera and printer.	Make sure the cable is connected between the camera or HP 8886 camera dock and the printer. If that does not work, turn off the camera and disconnect it. Turn the printer off and then on again. Re-connect the camera and turn it on.
	A supported printer is either turned off or not connected to the camera.	Make sure the camera is connected to a supported printer and that the printer is turned on.
Selected print size is larger than selected paper size	Print size is larger than paper size in the Print Setup menu.	Change either print size or paper size in the Print Setup menu.

Message	Possible cause	Solution
Unsupported printer	The printer is an unsupported device.	Connect the camera to a supported printer, such as an HP Photosmart printer or another HP printer with front panel USB ports. Or connect the camera to a computer and print from there instead.
Disengage photo tray, or select smaller paper size	The selected paper size cannot be used with the printer photo tray.	Disengage the printer photo tray, or change the paper size.
Printer top cover is open	The printer is open.	Close the top cover of the printer.
Incorrect or missing print cartridge	The printer cartridge is the incorrect model or is missing.	Install a new printer cartridge, turn the printer off, then turn it back on.
Printer has a paper jam	There is a paper jam.	Turn off the printer. Clear the paper jam, and then turn on the printer.
Printer is out of paper	Your printer is out of paper.	Load paper into the printer, and then press the OK or Continue button on the printer. To cancel the print job, press the OK button on the camera.

Message	Possible cause	Solution
Printing canceled	The print job has been canceled.	Press the OK button on the camera. Complete the print request again.
Any error code numbers that appear	The camera may have a hardware or firmware problem.	Turn the camera off and then on again. If the problem persists, call HP Support (see page 92).

Error messages on the computer

Message	Possible cause	Solution
Connection between the imaging device and computer failed	The camera might be connected to a computer through a USB hub.	Try connecting the camera directly to the computer, or disconnect other devices attached to the USB hub.
The software cannot retrieve the Share Menu information from your camera	The computer needs to write files to memory during HP Instant Share setup, but the memory is either full, or the memory card is locked.	Make room on the internal memory or memory card. If you are using an SD memory card, unlock it by switching the locking tab on the card to the unlocked position.
Computer cannot find the connected camera	The camera is turned off.	Turn on the camera.
	The camera is not working correctly.	Try connecting the camera directly to an HP Photosmart printer or an HP printer with front panel USB ports, and print an image. This will verify that the image, memory card, USB connection, and the USB cable are functioning correctly, or not.
	The cable is not connected correctly.	Make sure that the cable is firmly connected to the computer and camera.

Message	Possible cause	Solution
Computer cannot find the connected camera (continued)	The camera is set to the Digital Camera setting in the USB Configuration sub-menu of the Setup menu. But the computer cannot recognize the camera as a digital camera.	Change the USB Configuration setting to Disk Drive in the Setup menu. (See USB configuration on page 69.) This allows the camera to appear as another disk drive on the computer so that you can easily copy the image files from the camera to the hard drive of your computer.
	The camera is connected to the computer through a USB hub, and your USB hub is not compatible with the camera.	Connect the camera directly to a USB port on the computer.
	You are using the HP 8886 camera dock and forgot to press the Save/Print button.	Press the Save/Print  button on the dock.
	The memory card is locked (SD cards only)	Switch the locking tab on the memory card to the unlocked position.
	The USB connection failed.	Reboot the computer.

Getting assistance

This section contains support information for your digital camera, including support website information, an explanation of the support process, and support phone numbers.

HP accessibility website

Customers with disabilities can get help by visiting www.hp.com/hpinfo/community/accessibility/prodserv.

HP photosmart website

Visit www.photosmart.hp.com or www.hp.com/photosmart for the following information:

- Tips on using your camera more effectively and creatively
- HP digital camera driver updates and software
- Register your product
- Subscribe to newsletters, driver and software updates, and support alerts

Support process

The HP support process works most effectively if you perform the following steps in the order specified:

- 1 Review the troubleshooting section of this User's Manual, which starts on page 73.
- 2 Access the HP Consumer Support Website for support. If you have access to the Internet, you can obtain a wide range of information about your digital camera. Visit the HP website for product help, drivers, and software updates at www.hp.com/support.

Support is available in the following languages: Dutch, English, French, German, Italian, Portuguese, Spanish, Swedish, Traditional Chinese, Simplified Chinese, Japanese, Korean. (Danish, Finnish, and Norwegian support information is available in English only.)

- 3** Access HP e-support. If you have access to the Internet, connect with HP via e-mail by going to: www.hp.com/support. You will receive a personal reply from an HP Consumer Support technician. E-mail support is available in the languages listed at that website.
- 4** Contact your local HP dealer. If your digital camera has a hardware failure, take it to your local HP dealer for a solution. Service is free during your digital camera's limited warranty period. After the warranty period, the dealer will quote a service charge.
- 5** Contact HP Consumer Support for support by phone. Please consult the following website to check the details and conditions of phone support in your country/region: www.hp.com/support. As a part of HP's continuing efforts to improve phone support information services, we advise you to check the HP website on a regular basis for new information regarding service features and delivery. If you cannot solve the problem using the above options, call HP while you are in front of your computer and digital camera. For faster service, please be prepared to provide the following information:
 - The digital camera's model number (located on the front of the camera)
 - The digital camera's serial number (located on the bottom of the camera)
 - The computer's operating system

- The version of the digital camera software (located on the camera's CD label)
- Messages displayed at the time the situation occurred

The applicable conditions for HP phone support are subject to change without notice.

Telephone support is free from the date of purchase for the period specified unless otherwise noted.

Locations	Free Phone Support Period
Africa	30 days
Asia Pacific	1 year
Canada	1 year
Europe	1 year
Latin America	1 year
Middle East	30 days
United States	1 year

Phone support in the United States

Support is available both during and after the warranty period.

Within the period of your warranty, telephone support is provided free of charge. Call (208) 323-2551. If this is a long distance call for you, long distance charges will apply. US phone support is available in both English and Spanish 24 hours a day, 7 days a week (days and hours of support may change without notice).

After the warranty period, call (208) 323-2551. Charges are \$25.00 per issue, and are charged to your credit card. If you think your HP product needs service, call HP Consumer Support, which can help determine if service is required.

Phone support in Europe, the Middle East, and Africa

HP Consumer Support phone numbers and policies may change. Visit the following website to check the details and conditions of phone support in your country/region: www.hp.com/support.

Algeria +213 (0)61 56 45 43

Austria +43 (0)820 87 4417

Bahrain +973 800 728

Belgium 070 300 005 (Dutch)
070 300 004 (French)

Czech Republic +42 (0) 2 6130 7310

Denmark +45 70202845

Egypt +20 02 532 5222

Finland +358 (0)203 66 767

France +33 (0) 892 6960 22 (Euro 0.34/min)

Germany +49 (0)180 5652 180 (Euro 0.12/min)

Greece +30 10 60 73 603

Hungary +36 (0) 1 382 1111

Ireland 1890 923902

Israel +972 (0) 9 830 4848

Italy 848 800 871

Luxembourg 900 40 006 (French)
900 40 007 (German)

Morocco +212 224 04747

Netherlands 0900 2020 165 (Euro 0.10/minute)

Norway +47 815 62 070

Poland +48 22 865 98 00

Portugal 808 201 492

Romania +40 1 315 44 42

Russian Federation +7 095 797 3520 (Moscow)
+7 812 346 7997 (St Petersburg)

Saudi Arabia +966 800 897 14440

Slovakia +421 2 6820 8080

South Africa 086 000 1030 (inside RSA)
+27-11 258 9301 (outside RSA)

Spain 902 010 059

Sweden +46 (0) 77 120 4765

Switzerland 0848 672 672 (German, French, Italian—
Peak time 0.08 CHF/Outside peak 0.04 CHF)

Tunisia +216 1 891 222

Turkey +90 216 579 71 71

Ukraine +7 (380 44) 490-3520

United Arab Emirates 800 4910

United Kingdom +44 (0)870 010 4320

Other phone support worldwide

HP Consumer Support phone numbers and policies may change. Visit the following website to check the details and conditions of phone support in your country/region:
www.hp.com/support.

Argentina +54 0 810 555 5520

Australia +61 (3) 8877 8000 (or local (03) 8877 8000)

Brazil +55 (11) 3747 7799 (Grande São Paulo)
+55 0800 157751 (outside Grande São Paulo)

Canada +1 905 206 4663 (during the warranty period)
+1 877 621 4722 (after the warranty period)

Central America and the Caribbean +1 800 711 2884

Chile +56 800 22 5547 (Post-sales Business Computing)
+56 800 360 999 (Post-sales Home Computing)

China +86 (10) 6564 5959

Colombia +57 9 800 114 726

Guatemala +502 1 800 999 5105

Hong Kong SAR +852 3002 8555

India 1 600 112267 or +91 11 682 6035 (Hindi & English)

Indonesia +62 (21) 350 3408

Japan 0570 000 511 (inside Japan)
+81 3 3335 9800 (outside Japan)

Korea, Republic of +82 (2) 3270 0700 (Seoul)
0 80-999-0700 (outside Seoul)

Malaysia +60 1 800 805 405

Mexico +52 58 9922 (Mexico City)
+52 01 800 472 6684 (outside Mexico City)

New Zealand +64 (9) 356 6640

Peru +51 0 800 10111

Philippines +63 (2) 867 3551

Puerto Rico +1 877 2320 589

Singapore +65 6272 5300

Taiwan +886 0 800 010055

Thailand +66 (2) 661 4000

United States +1 (208) 323-2551

Venezuela +58 0 800 4746 8368





Vietnam +84 (0) 8 823 4530

Appendix A: Batteries and camera accessories

Managing batteries

When the batteries are removed from the camera, the date and time settings are preserved for approximately 10 minutes. If the camera is without batteries for longer than 10 minutes, the clock is set to the last date and time at which the camera was used. You may be prompted to update the date and time.

The following battery levels may be displayed on the Status LCD and Image Display.

Icon	Description
	Batteries have 30-100 percent battery life remaining.
	Batteries have 10-30 percent battery life remaining.
	Batteries have less than 10 percent remaining. Camera will power down soon. Live View is disabled.
	Camera is operating on AC power

The camera uses two AA batteries. Do not use ordinary alkaline batteries. For best results, use photo-lithium or rechargeable NiMH batteries. If you must use alkaline batteries, use high-grade “ultra” or “premium” varieties.

NOTE If you do not intend to use your camera for extended periods of time (more than a month), we strongly recommend that you remove the batteries.

Extending battery life

- Minimize the use of **Live View** and video, especially when using alkaline batteries.
- Use the viewfinder to frame pictures instead of the Image Display. Leave the Image Display off whenever possible.
- Use zoom only when necessary.
- Use the **Auto** flash setting rather than **Flash On**.
- Minimize power cycling. If you expect to average more than one picture every five minutes, leave the camera on rather than turning it off after each shot. This minimizes the number of times the lens has to extend and retract.
- Use an optional HP AC adapter or HP 8886 camera dock when the camera will be on for extended periods of time, or when unloading pictures to your computer, printing, or connecting to the TV.

Rechargeable batteries

Nickel Metal Hydride (NiMH) batteries can be recharged by using a battery charger. NiMH batteries can also be recharged in the camera when the camera is connected to an optional HP AC adapter or HP 8886 camera dock. Batteries are fully recharged via the optional HP AC adapter or camera dock in 15 hours.

Some things to keep in mind when using NiMH batteries are:

- Always recharge both NiMH batteries at the same time. One low-charged battery will reduce the battery life for both batteries in the camera.
- For NiMH batteries to reach optimal capacity and performance, they should first be discharged completely and recharged four separate times.
- NiMH batteries discharge when not in use, whether they are installed in a device (such as in the camera) or not. If they have not been used for more than two weeks, recharge them before using them again.

Power conservation

To conserve battery power, the Image Display turns off automatically if there is no button activity for 60 seconds. If no buttons are pressed for 6 minutes, the camera turns off (unless it is printing or connected to a computer or TV).

Purchasing camera accessories

You can purchase additional accessories for your camera from your local retailer or online at www.hpshopping.com. Some accessories for this digital camera are listed below:

- HP Photosmart 8886 camera dock (includes a camera dock, remote control, two rechargeable NiMH batteries, audio/video cable, USB cable, and an AC power adapter):
 - United States and Canada—C8886A #A2L
 - Mexico, Brazil, Chile, Argentina, and Uruguay—C8886A #ABM
 - Korea, Australia, and New Zealand—C8886A #UUF
 - Europe (except for the United Kingdom, see the next option below)—C8886A #AC2
 - United Kingdom and South Africa—C8886A #ABU
- HP Photosmart Digital Camera Deluxe Starter Kit (C8889A for North America, C8884B #UUS for continental Europe, and C8884B #ABU for the United Kingdom).
Contents include:
 - Padded camera case
 - Battery recharger
 - 4 rechargeable NiMH batteries
 - DC car adapter for battery recharger
 - 32 MB SD memory card
- HP Photosmart Digital Camera Starter Kit (Y1789B, option #A2L for North America, #UUS for continental Europe, and #ABU for the United Kingdom).
Contents include:
 - Padded camera case
 - Battery recharger
 - 4 rechargeable NiMH batteries

- HP Photosmart 3.3V AC power adapter (HP supports only HP AC power adapters and other accessories expressly approved by HP):
 - United States and Canada—C8912 #A2L
 - Korea, Australia, and New Zealand—C8912 #UUF
 - Europe—C8912 #UUS
- Memory card—Secure digital (SD) or MultiMediaCard™ (MMC) 128 MB is the largest memory card tested by HP. Larger sizes of cards have not been tested, but they should work - use at your own risk. This product only supports the use of MMC memory cards that have been verified compliant to the MultiMediaCard™ specification as of January 2000. Compliant MMC memory cards have the MultiMediaCard™ logo on the card. The following memory cards are available from HP:
 - 32 MB SD card—C8895A
 - 64 MB SD card—C8896A
 - 128 MB SD card—C8897A
- HP Photosmart padded camera case (C8905A)
- HP audio/video accessory cable to connect to a television (TV).

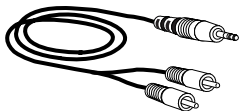

NOTE You can also use any Y-adapter audio cable with dual RCA plugs on one end and a 1/8 inch (3.175 mm) mini-stereo jack on the other end. You will also need an adapter plug that accepts a 1/8 inch (3.175 mm) jack and fits into a 3/32 inch (2.38 mm) jack.

Appendix B:

Specifications

Feature	Description
Resolution	<i>Still Pictures:</i> <ul style="list-style-type: none">● 3.34 MP (2140 by 1560 total pixel count)● 3.24 MP (2088 by 1550 effective pixel count) <i>Video clips:</i> <ul style="list-style-type: none">● 320 x 240 total pixel count
Sensor	Diagonal 6.67X mm (1/2.7-inch, 4:3 format) CCD
Color depth	30-bit (10 bits by 3 colors)
Storage	<ul style="list-style-type: none">● 16 MB internal Flash memory● Slot for memory card; Secure Digital (SD) or MultiMediaCard™ (MMC) memory card supported (see page 103) Number of images that can be saved in memory (internal or card) depends on the image quality setting (see page 31)
Lens	<i>Focal length:</i> <ul style="list-style-type: none">● Wide—5.8 mm—17.4 mm● Telephoto—17.4 mm● 35 mm equivalent approximately 38 mm—114 mm) <i>F-Number:</i> <ul style="list-style-type: none">● Wide—f/2.6 to f/4.9● Telephoto—f/5.0 to f/9.0
Viewfinder	Zooming optical viewfinder

Feature	Description
Zoom	3x optical, 5x digital zoom <ul style="list-style-type: none"> ● Wide—38 mm ● Telephoto—114 mm
Focus	TTL auto focus. <i>Focus settings:</i> <ul style="list-style-type: none"> ● Normal (default)—auto focus range of 0.4 m (15.75 in) to infinity ● Macro—auto focus range of 0.1 to 0.5 m (4 to 19.7 in), zoom range of 1x to 5x
Shutter speed	1/1500 to 1/3 seconds
Tripod mount	Yes
Built-in flash	1 to 6 second recharge
Flash working distance	3.0 m (9.8 ft) (guide number 7.8) at wide zoom setting
External flash	No
Flash settings	Auto (default), Auto with Red-eye Reduction, Flash On, Night with Red-eye Reduction, Flash Off
Image Display	1.5-inch LED backlit, TFT LCD with 61,380 pixels
Status LCD	Flash settings, AC/Battery, Memory Card, quality setting, remaining image count, video timer, video capture, audio capture, Self-Timer, Burst, Macro, Action, Landscape, Portrait, Aperture setting

Feature	Description
Image capture modes	<ul style="list-style-type: none"> ● Still (default) ● Self-Timer—10 second delay standard (both still and video) ● Burst—0.9 frames per second, maximum of 6 images ● Video—19 frames per second streaming to memory, maximum length limited only by available memory
Audio capture	<ul style="list-style-type: none"> ● Still pictures—Audio can be captured with each still picture by holding down Shutter button or added later (in the Playback menu), maximum length limited only by available memory ● Video—Audio captured automatically with video
Exposure Mode settings	Auto (default), Action, Landscape, Portrait, Aperture Priority (F/2.6 and F/4.9)
Exposure Compensation	Can be set manually from -2.0 to +2.0 EV (Exposure Value) in 0.5 EV increments
White Balance settings	Auto (default), Sun, Shade, Tungsten, Fluorescent
AE Metering settings	Average, Center-Weighted (default), Spot
ISO Speed settings	Auto (default), manually selectable 100, 200, 400
Color settings	Full Color (default)
Quality settings	<ul style="list-style-type: none"> ★★★ — Best ★★ — Better (default) ★ — Good
Saturation	Low, Medium (default), High
Sharpness	Low, Medium (default), High
Contrast	Not adjustable

Feature	Description
Playback magnification	Yes, approximately 3x and 6x
Compression format	<ul style="list-style-type: none"> ● JPEG (EXIF) for still images ● AVI for video clips
Interfaces	<ul style="list-style-type: none"> ● USB to a computer or HP Photosmart, some HP DeskJet, and some HP All-in-One multi-function printers ● Audio/Video out to TV ● DC IN 3.3Vdc @ 2500mAs ● HP 8886 camera dock
Standards	<ul style="list-style-type: none"> ● PTP (15740) ● MSDC transfer ● NTSC/PAL ● JPEG ● AVI ● DPOF 1.1 ● EXIF 2.2 ● DCF 1.0
External Body Dimensions	105 mm (L) by 45 mm (W) by 70 mm (H) 4.1 in (L) by 1.8 in (W) by 2.8 in (H)
Weight	240 grams (8.8 ounces) without batteries
Temperature range	<p><i>Operational:</i></p> <ul style="list-style-type: none"> ● 5° C to 45° C (41° F to 113° F) ● 15% to 85% relative humidity <p><i>Storage:</i></p> <ul style="list-style-type: none"> ● -30° C to 65° C (-22° F to 149° F) ● 15% to 90% relative humidity

Feature	Description
Power	<p>The camera has a maximum steady state power consumption of 2.64 Watts (800mA @ 3.3Vdc).</p> <p>Power sources include:</p> <ul style="list-style-type: none"> ● 2 AA batteries (2 non-rechargeable AA batteries included). Acceptable batteries include photo-lithium, “ultra” or “premium” grade high energy alkaline, or rechargeable NiMH. NiMH batteries can be recharged in the camera using the optional HP AC adapter or HP 8886 camera dock. ● Optional HP AC adapter (Input: 100-240Vac; Output: 3.3-3.7Vdc @ 2500mA). <ul style="list-style-type: none"> • United States and Canada—C8912 #A2L • Europe—C8912 #UUS • Korea, Australia, and New Zealand—C8912 #UUF ● Optional HP 8886 camera dock (different product numbers for each area - see Purchasing camera accessories on page 102). ● DC car adapter <p>Slow trickle recharging in camera with optional HP AC adapter or HP 8886 camera dock (100% in 15 hours).</p> <p>Automatic advanced power management.</p>
Warranty	HP 1 year exchange warranty

Index

A

- AA batteries 99
- AC power adapter
 - connector on camera 12
 - HP part number 109
 - purchasing 103
- accessories for camera 102
- action exposure mode 34
- AE Metering, setting 41
- AF viewfinder light 10
- alkaline batteries 99
- Aperture Priority (Av) setting 34
- Arrow buttons 11
- audio clips
 - record 12, 32, 51
- audio/video (TV)
 - cable 103
 - connector 65
 - connector on camera 12
- automatic exposure, override 33
- Av Aperture Priority setting 34

B

- batteries
 - door on camera 13
 - extend life of 100
 - icons 99
 - install 16
 - levels 99
 - rechargeable 101
 - types to use 99
- Best quality setting
 - description 31
- Better quality setting

- description 31
- blinking lights
 - Memory/USB 11
 - Self-Timer 12
 - viewfinder 10
- bonus software 21
- brackets on display screen 26
- brightening an image 38
- burst mode 36
- buttons on camera 10

C

- camera accessories 102
- Camera Sounds setting 68
- camera specifications 105
- camera, turn on/off 18
- Capture menu 37
- capture modes 33
- close-up pictures 36
- compression format 108
- computer
 - connect camera to 61
- connections
 - as a USB Mass Storage Device
 - Class (MSDC) 69
 - to computer 61
 - to printer 63
 - to TV 65
- connectors
 - AC power adapter on camera 12
 - audio/video (TV) 12, 65
 - camera dock 13
 - USB 12

consumer support 92

D

darkening an image 38

Date & Time setting 19, 68

delete

audio clips 51

from memory card 50

images during instant review
23

video clips during instant
review 24

diagnostic tests for camera 73

Digital Print Order Format 55

digital zoom 28

disk drive, camera as 69

display images and video clips
on TV 66

display, using 25

DPOF 55

E

e-mail

addresses, customizing the
Share menu 56

images from computer 62

empty batteries icon 99

enlarge image 52

error messages

on camera 82

on computer 90

Exposure Compensation setting
38

Exposure Mode setting 33

F

files

delete from memory card 50

DPOF 55

size versus quality 31

flash

button 13

range 106

settings 30

using 30

focus

lock 23, 26

range 106

setting 36

focus brackets, using 26

format memory card 50

full batteries icon 99

G

Good quality setting
description 31

H

help from consumer support 92

HP AC power adapter

connector on camera 12

purchasing 103

HP camera dock

connect to 13

description 9

dock insert 9

purchasing 102

HP Instant Share

description 9, 53

Share button 11, 53

Share menu 54

turn on/off 53

HP web sites 92

I

icons

- AE metering settings 42
- battery levels 99
- capture mode settings 33
- EV compensation 38
- flash settings 30
- image quality settings 31
- in Live View screen 25
- ISO speed settings 41
- on Status LCD 14
- saturation settings 43
- Share menu 54
- sharpness settings 44
- white balance settings 39

Image Display

- description 11
- status screen 27
- using 25

images

- AE Metering setting 41
- brightening 38
- darkening 38
- delete 50
- Exposure Mode setting 33
- ISO Speed setting 40
- magnify 52
- moving from internal memory
 - to memory card 71
- number remaining 25
- Red-eye Reduction setting 30
- rotate 49
- Saturation setting 43
- Sharpness setting 44
- thumbnails 48
- too dark/light 38
- unloading camera to
 - computer 61

White Balance setting 39

install

- batteries 16
- HP camera dock 9
- memory card 17
- software 20, 21
- wrist strap 16

instant review 23, 24

internal memory

- moving images to memory
 - card 71
- pictures remaining 25

ISO Speed, setting 40

L

landscape exposure mode 34

Language setting

- change 70
- choose at first startup 18

LEDs (lights) on camera

- Memory/USB 11
- Self-Timer 12
- viewfinder 10

lights

- on camera 11, 12

Live View

- button 11
- using 25

lock focus 23, 26

M

Macintosh computer

- bonus software 21
- connect to 61
- install software 21
- USB setting on camera 69

Macro focus setting 36

magnify image 52

- memory card
 - delete files 50
 - door 11
 - install 17
 - moving images from internal memory 71
 - pictures remaining 25
 - purchasing 103
- Memory/USB light 11
- menus
 - Capture 37
 - Playback 47
 - Share 54
- messages
 - on camera 82
 - on computer 90
- microphone 12
- MODE button 13

N

- NiMH batteries 99
- number of pictures remaining in memory 25

O

- OK button 11
- online manual, location 20
- optical viewfinder 10
- optical zoom 28
- over-exposing an image 38
- override automatic exposure 33

P

- photo-lithium batteries 99
- Picture Transfer Protocol 69
- pictures
 - instant review 23
 - share 53

- take close-up pictures 36
- take multiple (burst) 36
- take self-timer 35
- take stills 23
- Playback
 - turn on/off 11
 - using 45
- Playback button 11
- Playback menu 47
- portrait exposure mode 34
- power
 - battery level icons 99
 - restoring previous settings 18
 - specifications 109
 - switch 10
 - turn on/off 18
- power adapter, HP AC
 - connector on camera 12
 - purchasing 103
- previous settings, restoring 18
- print images
 - directly from camera 63
 - from computer 63
 - using HP Instant Share 53
- printer
 - connect to camera 63
- problems, troubleshooting 73
- product support 92
- PTP 69

Q

- quality
 - button for selecting 13
- quality settings
 - effect on image file size 31

R

- range
 - Exposure Compensation 107
 - flash 106
 - F-number 105
 - focus 106
- rechargeable batteries 101
- record
 - audio clips 12, 32, 51
 - video clips 24
- Red-eye Reduction, setting 30
- remaining pictures count 25
- restoring previous settings 18
- review, instant 23, 24
- reviewing images and video clips 45
- rotate images 49

S

- Saturation setting 43
- Self-Timer light 12
- Self-Timer mode 35
- settings, restoring previous 18
- Setup menu, using 67
- Share button 11
- Share menu
 - customize 56
 - description 54
 - e-mail service 56
 - printing options 55
 - using 54
- share pictures 53
- Sharpness setting 44
- Shutter button
 - description 14
 - lock exposure and focus 26
- shutter speed
 - range 106

- slideshow, display on TV 66
- software, install 20, 21
- sounds of camera 68
- space remaining in memory 25
- specifications 105
- Status LCD, description 14
- status screen 27
- still pictures, take 23
- support for consumers 92

T

- technical support 92
- thumbnail images, view 48
- Time & Date setting 19, 68
- tripod mount 12
- troubleshoot problems 73
- turn on/off
 - camera power 18
 - camera sounds 68
 - HP Instant Share 53
 - Image Display 11, 25
 - Playback 45
- TV (television)
 - cable to connect camera 103
 - configuration setting 70
 - connect camera to 65
 - connector on camera 12

U

- under-exposing an image 38
- unloading images
 - camera to computer 61
- USB
 - configuration setting 69
 - connector on camera 12

V

- Video button 14
- video clips
 - instant review 24
 - record 24
- Video mode
 - use 24
- Video viewfinder light 10
- viewfinder 10
- viewfinder lights 10
- viewing images and video clips 45

W

- web sites for HP 92
- White Balance, setting 39
- Windows computer
 - bonus software 21
 - connect to 61
 - install software 20
- wrist strap
 - attaching to camera 16
 - mount on camera 11

Z

- zoom
 - specifications 106
 - use optical or digital 28
- Zoom Out/In buttons 11