

# Settings & Preferences

Press and hold the SEN and BRT buttons to access Preferences. To exit Preferences, simply wait a few seconds without pressing a button. The unit will display **Completed** to confirm your selections.

**NOTE** selecting **Russian** language during first startup uses default band settings with the following exceptions: Strelka **On**, Ka Band **Off**.

## Press SEN to go from one category to the next

User Mode **Advanced\***  
**Novice**

Pilot **Scanning\***  
**Full Word**

Arrow Mode **Single\***  
**Multiple**  
**Band**

Display Color **Blue\*/Green/Red/Amber**

Speed Display **On\***  
**Off**

Cruise Alert **30 kph\***  
**Off / 20-160 kph**

Over Speed **110 kph\***  
**Off / 20-160 kph**

Over Speed Limit **Speed Limit\***  
**Off / Speed Limit / 5 Over / 7 Over / 10 Over / 15 Over / 20 Over / 25 Over**

Meter Mode **Standard**  
**Standard FR1\***

**Standard FR2**

**Spec FR1**

**Spec FR2**

**Expert FR**

**Simple**

## Press VOLUME + or - to change your setting within a category

Access and customize all Settings and Preferences  
Access and customize units and display color, (all other Settings are set to factory defaults)

*NOTE: Switch back to advance mode to view all Preferences.*

Scanning Bar with Full Word  
Full Word: Auto, Auto NoX, AutoLoK or Highway

Displays a single threat-direction arrow only for the primary alert  
Displays threat-direction arrows for multiple alerts  
Displays color-coded threat-direction arrows for multiple alert bands  
X = green, K = blue, Ka/Laser = red

Set color to match your vehicle's dash display

Displays current speed  
Displays battery voltage

Offers double beep alert tones below specified speed

Reminds you when you exceed a specified speed

Reminds you when you reach specified speed at or over the speed limit

Displays primary alert band with front signal strength bar graph

Displays primary alert band with front and rear signal strength bar graphs

Displays primary alert band with primary and secondary front and rear signal strength bar graphs

Displays primary alert band with numeric frequency and front and rear signal strength bar graphs

Displays primary alert band with numeric frequency, and primary and secondary front and rear signal strength bar graphs

Displays up to four alert bands with front and rear signal strength bar graphs for each

Simple messages replace alert band and signal strength bar graphs:

**Caution** (if traveling below cruise alert limit)

**Slow Down** (if traveling above cruise alert limit)

Tones	<b>Standard*</b> <b>Standard+</b>	Standard alert tones Standard alert tones for primary alert and double-beep tones for additional alerts
	<b>Mild</b>	Mild doorbell chime alert tones
AutoMute	<b>Low / Med* / High / Off</b>	Automatically reduces audio to preferred volume during alert
AutoLearn	<b>On / Off*</b>	Automatically stores and locks out false alarms
Units	<b>English / Metric*</b>	Units for distance and speed
Language	<b>English* / Spanish / Russian / Chinese</b>	Language for voice and text
Voice	<b>On* / Off</b>	Voice announcements
GPS Filter	<b>On* / Off</b>	Enables GPS-powered features
AutoPower	<b>Off</b>	Power turns on or off depending on your vehicle's ignition type (constant power or switched)
	<b>1 Hour</b>	Powers off automatically after 1 hour
	<b>2 Hours</b>	Powers off automatically after 2 hours
	<b>4 Hours*</b>	Powers off automatically after 4 hours
	<b>8 Hours</b>	Powers off automatically after 8 hours
		<i>NOTE: AutoPower only works with constant power ignition.</i>
		<i>NOTE: If AutoPower is on, to save screen life the display screen goes blank after 30 minutes without moving. Display screen will turn on automatically after you reach 10MPH.</i>
Band Enables	<b>Default*</b> <b>Modified</b>	Default Settings Band Enables have been modified from their default settings

**Press BRT to go from one Band category to the next**

**Press VOLUME + or – to change your setting within a category**

X Band	<b>On / Off*</b>		
K Band	<b>On / Off*</b>	Freq: 24.050 – 24.250 GHz	
		<i>NOTE: When K Band is off, you can select separate segments of the band to turn on or off.</i>	
KN1	<b>On* / Off</b>	Freq: 24.050 – 24.110 GHz	
KN2	<b>On* / Off</b>	Freq: 24.110 – 24.175 GHz	
KN3	<b>On* / Off</b>	Freq: 24.175 – 24.250 GHz	
KN4	<b>On* / Off</b>	Freq: 23.950 – 24.050 GHz	
Strelka	<b>On / Off*</b>	Strelka detection	
MultaRadar CD	<b>On* / Off</b>	MultaRadar CD detection	
MultaRadar CT	<b>On* / Off</b>	MultaRadar CT detection	
Gatso	<b>On* / Off</b>	Gatso detection	
Ka Band	<b>On* / Off</b>	Freq: 33.400-36.000 GHz	
		<i>NOTE: When Ka Band is off, you can select separate segments of the band to turn on or off.</i>	
KaN1	<b>On / Off*</b>	Freq: 33.400 – 33.700 GHz	KaN6 <b>On / Off*</b> Freq: 34.800 – 35.160 GHz
KaN2	<b>On / Off*</b>	Freq: 33.700 – 33.900 GHz	KaN7 <b>On / Off*</b> Freq: 35.160 – 35.400 GHz
KaN3	<b>On* / Off</b>	Freq: 33.900 – 34.200 GHz	KaN8 <b>On* / Off</b> Freq: 35.400 – 35.600 GHz
KaN4	<b>On* / Off</b>	Freq: 34.200 – 34.600 GHz	KaN9 <b>On / Off*</b> Freq: 35.600 – 35.840 GHz
KaN5	<b>On* / Off</b>	Freq: 34.600 – 34.800 GHz	KaN10 <b>On / Off*</b> Freq: 35.840 – 36.000 GHz
Laser	<b>On* / Off</b>		
Marker Enables	<b>Default*</b> <b>Modified</b>	Default Settings Marker Enables have been modified from their default settings	

## Press BRT to go from one Marker category to the next

Other	<b>On* /Off</b>
Redlight	<b>On* / Off</b>
Red & Speed	<b>On* / Off</b>
Speed Cam	<b>On* / Off</b>
Speed Trap	<b>On* / Off</b>
Avg Speed Cam	<b>On* / Off</b>
HOV Lane	<b>On* / Off</b>

Clear Locations **Marked Lockouts Defender Format**

## Press VOLUME + or - to change your setting within a category

Other location
Red light camera
Red light & speed camera
Speed camera
Speed trap
Average speed camera
High occupancy vehicle lane camera

*NOTE: User cannot mark average speed and HOV lane cameras*  
Clear all user Marked locations. Press BRT button to confirm  
Clear all lockouts. Press BRT button to confirm  
Clear all DEFENDER data. Press BRT button to confirm  
Clear DEFENDER database, all markers, and all lockouts  
Press BRT button to confirm

Wi-Fi **On\* /Off**

Turns Wi-Fi Connect on or off

Bluetooth **On\* /Off**

Turns Bluetooth on or off

Auto Update **Off/Database/  
Firmware/All\***

Automatically checks for selected updates when detector is powered on

Wi-Fi Update **Database  
Firmware**

Perform Database update. Press BRT to confirm  
Perform Firmware update. Press BRT to confirm

### \*Default Setting

## Notes for Settings & Preferences

For descriptions of features and functions available when connected to ESCORT Live, visit [EscortRadar.com](http://EscortRadar.com) and download the MAX 360c Owner's Manual.

To view serial number and software revision press MRK and MUTE while powering on detector.

To restore MAX 360c to its original factory Settings, press and hold MRK and BRT while turning the power on. A "Restored" message will display, acknowledging the reset.

## Software Updates

In its factory default setting, immediately after MAX 360c has connected to a Wi-Fi network you will be prompted to install any available firmware and database updates. See **Using Wi-Fi Connect** on page 5 for connection instructions.

The MAX 360c operating firmware and red light and speed camera database can also be updated using a USB A/Mini B cable (not included) connected to a computer using our detector software tools found on our web site. In order to have access to these updates, please register your MAX 360c at [www.EscortRadar.com](http://www.EscortRadar.com)

# Warranty

## ESCORT One Year Limited Warranty

**What this warranty covers:** Escort, Inc. ("Escort") warrants your Product against all defects in materials and workmanship.

**For how long:** One (1) year from the date of original purchase from an authorized Escort dealer.

**What we will do:** If a breach of warranty occurs, Escort, at its discretion, will either repair or replace your Product free of charge.

**What we will not do:** Escort will not pay shipping charges that you incur for sending your Product to us.

**What you must do to maintain this warranty:** Show original proof of purchase or receipt from an authorized Escort dealer.

**Warranty exclusions:** This warranty does not apply to your product under any of the following conditions: 1. The serial number has been removed or modified. 2. Your product has been subjected to misuse or damage (including water damage, physical abuse, and/or improper installation). 3. Your product has been modified in any way. 4. Your receipt or proof-of-purchase is from a nonauthorized dealer or internet auction site, including E-bay, U-bid, or other non-authorized resellers. 5. You are not the original purchaser of the Product from an authorized dealer or did not receive it as a gift from the original purchaser of the Product from an authorized dealer.

**To obtain service:** 1. Contact ESCORT (1-800-543-1608) to obtain a Return Authorization Number. 2. Properly pack your Product and include: your name, complete return address, written description of the problem with your Product, daytime telephone number, and a copy of the original proof of purchase or receipt. 3. Label the outside of the package clearly with your Return Authorization Number. Ship the Product pre-paid (insured, for your protection) to: ESCORT, Inc., 5440 West Chester Rd., West Chester, OH 45069.

**LIMITATION OF WARRANTY:** The obligations set forth above are ESCORT's sole obligations and your exclusive remedy. **ESCORT makes no other express warranty. Any implied warranty of merchantability or fitness for a particular purpose that may be applicable to the Product is limited in duration to the duration of this warranty.** Some States do not allow limitations on how long an implied warranty lasts, so the above limitation may not apply to you. **ESCORT SHALL NOT BE LIABLE FOR CONSEQUENTIAL, SPECIAL OR INCIDENTAL DAMAGES INCLUDING, WITHOUT LIMITATION, DAMAGES ARISING OUT OF THE USE, MISUSE OR MOUNTING OF THE PRODUCT.**

Some States do not allow the exclusion or limitation of incidental or consequential damages, so the above limitation or exclusion may not apply to you. ESCORT is not responsible for products lost in shipment between the owner and our service center.

**Other legal rights:** This warranty gives you specific legal rights, and you may also have other rights which vary from State to State.

# Contact Us

## Accessories



+420 731 03 06 06



Escortradar.eu

Designed in the USA by Escort, Inc.  
Manufactured in the Philippines

ESCORT Inc.  
5440 West Chester Road  
West Chester OH 45069

Sales / Service +420 731 03 06 06

www.EscortRadar.eu

©2018 ESCORT Inc. ESCORT®, MAX 360c®, Defender®, AutoLearn®, TrueLock™, AutoSensitivity™, SpecDisplay™, ExpertMeter™, ESCORT Live™, IVT Filter™, SmartMute™ and EZ Mag Mount™ are trademarks of ESCORT, Inc.

FCC NOTE: Modifications not expressly approved by the manufacturer could void the user's FCC granted authority to operate the equipment.

FCC ID: QKLM6C. CONTAINS FCC ID: TFB-1003.

This device complies with part 15 of the FCC rules. Operation is subject to the following two conditions: (1) This device may not cause harmful

ESCORT Live Compatible



The Bluetooth® word mark and logos are registered trademarks owned by Bluetooth SIG, Inc. and any use of such marks by ESCORT is under license.

**INTERNATIONAL**

Quick Reference

# ESCORT<sup>®</sup> MAX 360c

360° Radar/Laser Detector with  
Alert-Signaling Arrows



**MAX 360c** | Intelligent 360° Radar  
Laser Detection



360° Directional  
Alert Arrows



Connected Car's Wi-Fi  
Provides Crowd Sourced  
Alerts & Software Updates



GPS Intelligence  
Rejects False Alerts



ESCORT Live App  
Provides Crowd-  
Sourced Alerts



Lightning Fast Response



**360°  
ALERTS**

**55** **49** **lengua española**  
Spanish

**55** **49** **中国语音**  
Chinese

**55** **49** **русский язык**  
Russian

# Congratulations



MAX 360c

You've just purchased the MAX 360c International with 360° directional arrows, GPS-based intelligence, plus Bluetooth® and Wi-Fi connectivity.

Go to [EscortRadar.com](http://EscortRadar.com) for the full featured MAX 360c International Owner's Manual.

Guía de Referencia Rápida Española traducida y manual con todas las funciones también son disponibles a [www.EscortRadar.com](http://www.EscortRadar.com)

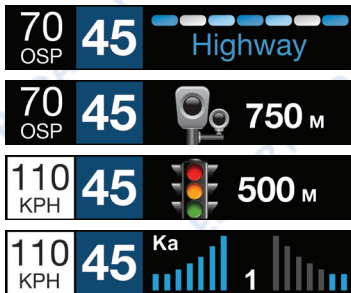

*MAX 360c features a new multi-color OLED display. Brilliant graphics illuminate intuitive icons that identify the type of threat at a glance.*

# MAX 360c Features

- Front and rear radar receivers offer 360° ticket protection.
- Threat direction arrows report the direction an alert is coming from.
- MAX 360c's GPS location-based intelligence automatically locks out false alerts and allows you to mark locations for future reference.
- Using Wi-Fi, MAX 360c gives you wireless access to ESCORT's DEFENDER Database, which warns you of verified speed traps, speed cameras, and red light cameras.
- MAX 360c with built in Bluetooth® and Wi-Fi technology, gives you access to ESCORT's award-winning app, ESCORT Live. Our exclusive real-time ticket-protection network which warns you of upcoming alerts received and reported by other users in the area, and gives you access to local speed limit data for over-speed alerts.



**Live Ready!**

3 6 0 ° I N T E L L I G E N T L O N G - R A N G E  
R A D A R - L A S E R D E T E C T I O N



# Registration and ESCORT Live

Before downloading ESCORT Live, you must first register your device. Be sure to have your device nearby, as you will need its serial number.

- 1 Visit [www.EscortRadar.com](http://www.EscortRadar.com) and click Product Registration.
- 2 Click the "Registration for all devices" link.
- 3 Follow the onscreen instructions to register your device.

Be sure to write down the username and password you create, as you will need this information to access and download ESCORT Live. (You will also receive an e-mail with this information, once you have registered your device.)

## For iPhone:

- 1 Ensure MAX 360c power is ON
- 2 Open the App Store on your iPhone and search for **ESCORT Live Radar**.
- 3 Follow the onscreen instructions to download **ESCORT Live Radar** and then open the app.
- 4 When prompted, enter the username and password you created when registering your product at [EscortRadar.com](http://EscortRadar.com).
- 5 Press the Settings button  then select **Devices**.
- 6 You should see **MAX 360c INTL** listed with Not Connected underneath.  
Press the **MAX 360c INTL** device entry and when prompted select Pair.
- 7 The Bluetooth icon on the MAX 360c display will appear to confirm that it is paired to your iPhone.

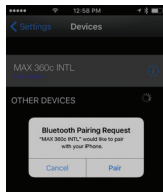

## For Android based smartphones:

- 1 Ensure MAX 360c power is ON.
- 2 On your smartphone go to Bluetooth® Settings and make sure that Bluetooth® is ON.
- 3 Press Scan for devices and wait for the device list to populate, **MAX 360c INTL** Live should appear under Available devices.
- 4 Press the **MAX 360c INTL** device entry.
- 5 The Bluetooth icon on the MAX 360c display will appear to confirm that it is paired to your smartphone.
- 6 Open Google Play on your smartphone and search for **Escort Live Radar**.
- 7 Follow the onscreen instructions to download **Escort Live Radar** and then open the app.
- 8 When prompted, enter the username and password you created when registering your product at [EscortRadar.com](http://EscortRadar.com).
- 7 Open the app, walk through the tutorial, and you're ready to hit the road!



# Installation

Your new detector comes with our latest **EZ Mag Mount™**. Simply tilt the display end of the detector up and slide it onto the mounting bracket. The magnetic mount holds the detector in place. To remove the detector from the mount, simply lift the display end of the detector and the detector releases from the mount.

## Mounting Tips:

- Center of windshield between driver and passenger.
- Ensure clear view of road ahead and sky above.
- Avoid windshield wipers and heavily tinted areas.

## To mount the detector in your vehicle:

- 1 Remove paper backing from EZ Mag Mount™ StickyCup.
- 2 Ensure the locking clamp is open.

- 3 Firmly press EZ Mag Mount™ StickyCup onto windshield and close the locking clamp to secure.
- 4 To adjust view, loosen thumb wheel and adjust angle of mounting bracket. Tighten thumb wheel to secure.
- 5 Tilt the display end of the detector slightly upward and engage with the flanged edge of the mounting bracket. The EZ Mag Mount™ magnet holds the detector in place.
- 6 To remove the detector, simply lift the display end of the detector upward. The detector will release from the mount.
- 7 To remove mount from windshield, release locking clamp and pull tab on top of StickyCup.

## EZ Mag Mount™ Care Instructions:

Should the EZ Mag Mount™ StickyCup accumulate debris and lose its stickiness, simply rinse under warm water, gently wipe off debris and allow to air dry.

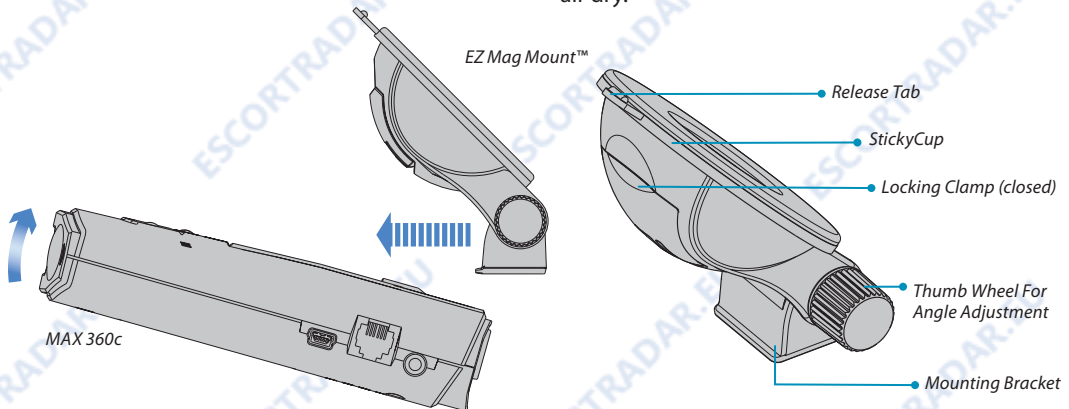



# Controls & Features

## Using MAX 360c

- 1 Plug small end of SmartCord USB into modular jack on MAX 360c and large end of SmartCord USB into your car's lighter/accessory socket.
- 2 MAX 360c should power on automatically. If not, press the device's power button. 

## Using Wi-Fi Connect

To connect MAX 360c to your connected vehicle's Wi-Fi network.

- 1 Follow the directions on page 3 to register your MAX 360c, download the ESCORT Live app and pair the MAX 360c to your smartphone.
- 2 Connect your smartphone to your connected vehicle's Wi-Fi hotspot.
- 3 In the ESCORT Live app press Settings, select **Wi-Fi Settings** then **Connect to Wi-Fi Network**.
- 4 Enter your connected vehicle's Wi-Fi network password.

The speed limit indicator on the MAX 360c display will change to white indicating that it is connected to a Wi-Fi network (see page 6).

## Earphone Jack

Connects to optional 3.5 mm stereo earphone 

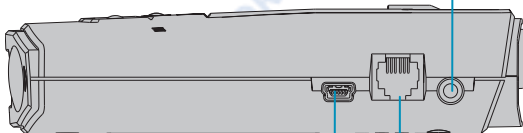

## Mini USB Jack

Connects to your computer via USB A / Mini B cable for downloading software updates 

## Modular Jack

Connects to SmartCord USB for powering your device 

## Using SmartCord USB

### • Mute Button:

- Press to mute the audio for a specific alert.
- Press three times to lock out a false alert.
- Press twice while receiving a locked-out alert to unlock.
- When connected to ESCORT Live press and hold mute button on unit or cord to manually report to other users a verified X or K-band alert, or a police officer observing traffic.

• **Alert Light:** Blinks red when receiving a radar or laser alert.

• **Power Light:** Lights green when receiving power.

• **USB Charging Port:** Charge smartphones, tablets and other USB-charged Devices.



## Modular Connector

Plugs into detector jack 

## SmartCord USB Adapter

Connects to lighter/accessory socket 

# Controls & Features

**Mount Area**  
The EZ Mag Mount™ attaches to device here

**Sensitivity (SEN)**  
Press to adjust detector sensitivity (Auto, Auto NoX, AutoLoK, and Highway)

**Power**   
Press to turn MAX 360c on or off

**Brightness (BRT)**  
Press to adjust display brightness (Min, Med, Max, Auto, Dark)

**Volume**  
Press and hold + or – to adjust volume



**Mark Location (MRK)**  
To mark a location for future alerts, press MRK twice, then VOL + or – to select the type of marker, then MRK again to confirm. Press twice while receiving marker alert to unmark

**Display**  
Current speed  
**Display**  
Alert area

**Mute**  
Press to mute an alert; press three times to lock out a false alert; press twice while receiving a locked-out alert to unlock

**Display (OSP)**  
OverSpeed alert setting, can be adjusted in Preferences. **Bluetooth** icon will appear here when paired to phone. Speed limit data will appear here when receiving ESCORT Live data from smartphone's **Bluetooth** or from vehicle's **Wi-Fi**.

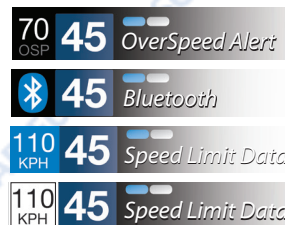

Data from Bluetooth

Data from Wi-Fi