

micro-revue

70/71



SENNHEISER

25 JAHRE

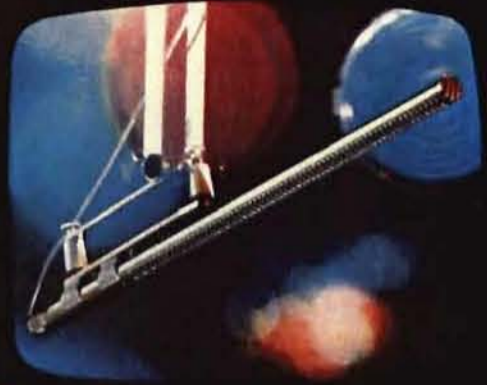

SENNHEISER ELECTRONIC · 3002 BISSENDORF/HANN. · TELEFON (0 51 30)

Contents

	Page
	3
	7
Product Group 1	
Dynamic Microphones	
Studio Microphone MD 21	16
Studio Cardioid Microphone MD 421	18
Super Cardioid Microphone MD 411 HLM	20
Super Cardioid Dynamic Microphone MD 402 LM	22
Studio Microphone MD 211 N	24
Goose Neck Cardioid Microphone MD 408 N	25
Lavalier Microphone MD 214 N	26
Microphones for Musicians MD 409 N and MD 415 N	28
Noise Cancelling Microphone MD 4 and Anti-Feedback Microphone MD 420	30
Probe Measuring Microphone MD 321 N	31
Accessories	44
Product Group 2	
Transistorized Condenser Microphones	
Condenser Microphones with Integral Transistorized RF Circuitry	32
Transistorized Condenser Microphone MKH 105	34
Transistorized Condenser Microphones MKH 110 and MKH 110-1	35
Lavalier Condenser Microphones MKH 124 and MKH 125	36
Transistorized Condenser Microphone MKH 405	38
Transistorized Condenser Microphone MKH 415	40
Transistorized Condenser Microphone MKH 815	42
Microphone Accessories	44
Product Group 3	
Magnetic Microphones	
Magnetic Lapel Microphone MM 23	54
Magnetic Lapel Microphone MM 28	54
Magnetic Microphone Capsules MM 21 and MM 26	55
Magnetic Subminiature Microphone Capsule MM 301	55
Product Group 4	
Dynamic Stereo Headphones	
Stereo Headphones HD 110 and Microphone/Headphone Combination HMD 110	56
Stereo HiFi Headphones HD 414	57
3-Channel Junction Box HZA 414	58
Stick Headphones HD 412	59
Product Group 5	
Magnetic Earphone Capsules	
Earphone Capsule HM 35	60
Sub-Miniature-Earphone-Capsule HM 401	60
Stetosets HZS 21 and HZS 22	61
Dynamic Earphone for Dictating Machines HD 404	62
Earphone Accessories	62
Product Group 6	
HiFi Stereo Reproducer HS 303 "Philharmonic"	
Philharmonic	63
Loudspeaker Amplifier Unit VKL 303	64
Stereo Mixer VMS 303 for Philharmonic System	66
Universal HiFi Microphone Preamplifier VV 303	67
Product Group 7	
Radio Microphone System "Mikroport" SM 1008	
Transmitter SK 1008	68
Plug-in Microphones MD 1008 and MD 4008	70
Receiver EM 1008	71
Radio Microphone Accessories:	
Telescopic Aerial TA 203, MD 405 T and MD 214-1	72
Pocket Receiver T 203	73
Product Group 8	
Transformers	
Transformers	74
Product Group 9	
Studio Equipment	
Transmitter SER 1 and Receiver ER 2	76
Receiver ER 3	78
Studio Pocket Transmitter SK 1007	79
Portable 4-Channel Mixer M 101	80
Mixer Control Unit ML 101	82
Studio Monitors VKL 303-1 and VKL 303-4	83
Product Group 10	
Audio Test Equipment	
Audio Test Equipment	86
Vacuum Tube Voltmeter RV 56	87
Vacuum Tube Voltmeter RV 55	88
Harmonic Distortion Bridge KB 55	89
Weighting Filter Unit FO 55	90
Weighting Filter FO 2	92
Balancing Transformer RVZ 11	92
Impedance Tester ZP 2	93
Resistance Decades RD 1 and RD 2	94
Capacitance Decade CD 1	94
Inductance Decades LD 1, LD 2 and LD 3	94
Sennheiser Representatives	95

Contents in Alphabetical Order

	Page
A	
Accessories	44
Audio Test Equipment	86
B	
Balancing Transformer RVZ 11	92
C	
Capacitance Decade CD 1	94
Condenser Microphones with Integral Transistorized RF Circuitry	32
D	
Dynamic Earphone for Dictating Machines HD 404	62
E	
Earphone Capsule HM 35	60
Earphone Accessories	62
G	
Goose Neck Cardioid Microphone MD 408 N	25
H	
Harmonic Distortion Bridge KB 55	89
I	
Impedance Tester ZP 2	93
Inductance Decades LD 1, LD 2 and LD 3	94
Interesting Facts about Microphones	7
Introduction, Sennheiser 25 years	3
L	
Lavalier Microphone MD 214 N	26
Lavalier Condenser Microphones MKH 124 and MKH 125	36
Loudspeaker Amplifier Unit VKL 303	64
M	
Magnetic Lapel Microphone MM 23	54
Magnetic Lapel Microphone MM 28	54
Magnetic Microphone Capsules MM 21 and MM 26	55
Magnetic Subminiature Microphone Capsule MM 301	55
Microphone Accessories	44
Microphones for Musicians MD 409 N and MD 415 N	28
Mixer Control Unit ML 101	82
N	
Noise Cancelling Microphone MD 4 and Anti-Feedback Microphone MD 420	30
P	
Philharmonic	63
Plug-in Microphones MD 1008 and MD 4008	70
Pocket Receiver T 203	73
Portable 4-Channel Mixer M 101	80
Probe Measuring Microphone MD 321 N	31
R	
Radio Microphone Accessories:	
Telescopic Aerial TA 203, MD 405 T and MD 214-1	72
Receiver EM 1008	71
Receiver ER 3	78
Resistance Decades RD 1 and RD 2	94
S	
Sennheiser Representatives	95
Stereo Headphones HD 110 and Microphone/Headphone Combination HMD 110	56
Stereo HiFi Headphones HD 414	57
Stereo Mixer VMS 303 for Philharmonic System	66
Stetosets HZS 21 and HZS 22	61
Stick Headphones HD 412	59
Studio Cardioid Microphone MD 421	18
Studio Microphone MD 211 N	24
Studio Microphone MD 21	16
Studio Monitors VKL 303-1 and VKL 303-4	83
Studio Pocket Transmitter SK 1007	79
Sub-Miniature-Earphone-Capsule HM 401	60
Super Cardioid Dynamic Microphone MD 402 LM	22
Super Cardioid Microphone MD 411 HLM	20
T	
3-Channel Junction Box HZA 414	58
Transformers	74
Transistorized Condenser Microphone MKH 105	34
Transistorized Condenser Microphones MKH 110 and MKH 110-1	35
Transistorized Condenser Microphone MKH 405	38
Transistorized Condenser Microphone MKH 415	40
Transistorized Condenser Microphone MKH 815	42
Transmitter SK 1008	68
Transmitter SER 1 and Receiver ER 2	76
U	
Universal HiFi Microphone Preamplifier VV 303	67
V	
Vacuum Tube Voltmeter RV 56	87
Vacuum Tube Voltmeter RV 55	88
W	
Weighting Filter Unit FO 55	90
Weighting Filter FO 2	92



1945 At the end of the Second World War, the then Dr. F. Sennheiser started together with about twelve co-workers his "Laboratory Wennebostel" in this old farmhouse located in a village called Wennebostel, just south of the Luneburger Heide in West Germany.



1946 Because of its good acoustical qualities, radio stations began to purchase the first dynamic microphone MD 2 which had been completely developed by "Labor W".



1949 Thanks to the early research in dictating microphones, close contacts were made with the major dictating machine manufacturers all over the world and today Sennheiser is still considered the leader in this field.



1950 The very first power amplifier of the Company complied, almost without exception, with the terms of the Hi-Fi Norm DIN 45500 which were established only many years later.

44
86
92
94
32
62
60
62
25
89
93
94
7
3
26
36
64
54
54
55
55
44
28
82
30
63
70
73
80
31
72
71
78
94
95
56
57
66
61
59
18
24
16
83
79
60
22
20
58
74
34
35
38
40
42
68
76
67
87
88
90
92



1951 The Company went into the production of highly specialized audio transformers of complicated design, thus consolidating its contact with the electronic industry.



1952 Magnetic transducers for dictating machines as well as for hearing-aids opened up new markets; the magnetic subminiature microphone MM 301 formed the basis for the manufacture of miniature hearing aids.



1954 The dynamic professional microphone MD 21 has become one of the most widely used microphones by reporters at radio and TV stations and is considered even today the cornerstone in the entire program of the Company.

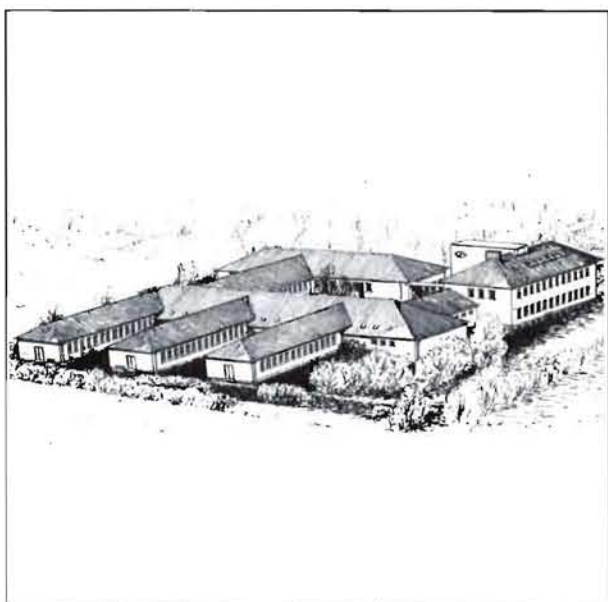

1955 The Company employed at that time more than 250 people. The foundation for an ambitious new building was laid which would fit harmoniously into the rural landscape.



1958 With a staff that had increased in the meantime to 450 people the name of the Company was changed from "Laboratory Wennebostel" to "Sennheiser electronic". The first wireless microphone system "Mikroport" left the factory.



1960 The promising professional dynamic directional microphone MD 421 was introduced at the Hannover Fair. So far well over 100,000 units have been sold all over the world.

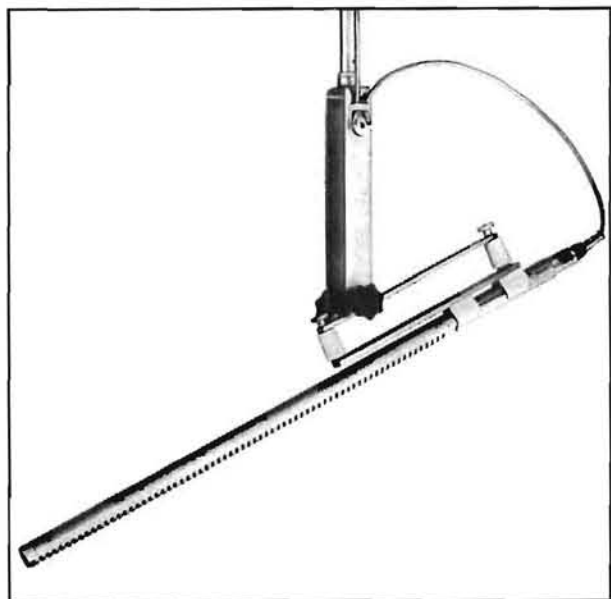

1961 Also with regard to condenser microphones Sennheiser electronic started to offer something special. "Shotgun" microphones make it possible to keep the microphone for television and film use always out of the camera range.



1965 With the new stereo set "Philharmonic", speakerbox and amplifier were incorporated for the first time into so-called amplifier/speakerboxes and are now in use at radio and TV stations.

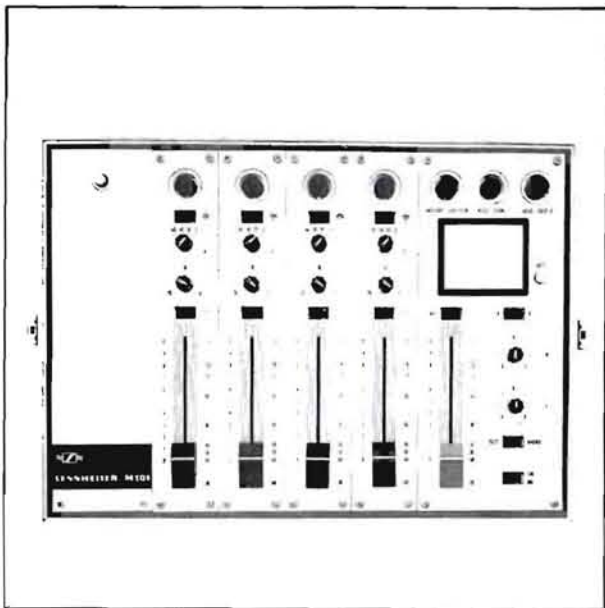

1967 With the portable audio mixer M 101 Sennheiser electronic consolidated its position in the studio-equipment field since this new item closed a gap in the market especially as far as small sound units were concerned.

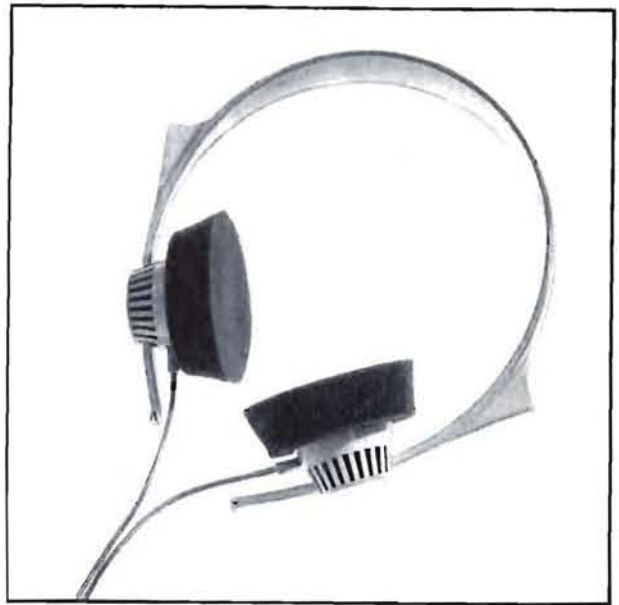

1968 The biggest success in the new product group "dynamic headphones" was — and still is — the "Open-Air" stereo headphone HD 414. Over 150,000 units are in use so far.

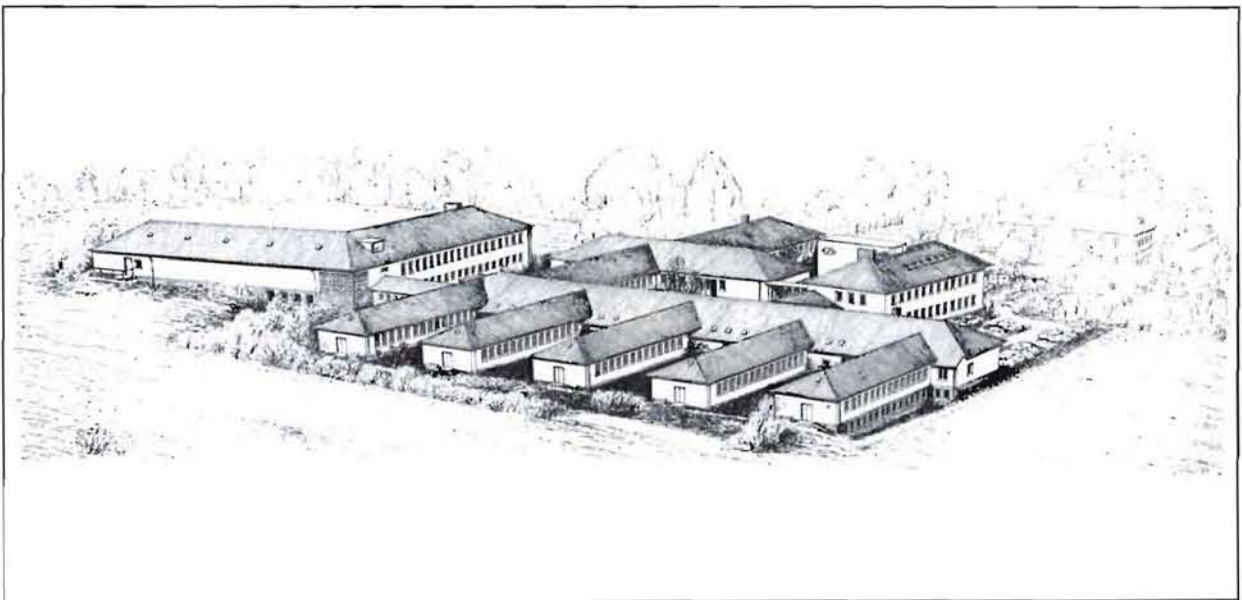

1970 The Company with more than 750 employees is still headed by Professor Dr. F. Sennheiser, who has been lecturing for years at the Institute of Technology in Hannover, Germany. Research, design and planning are being carried out in an ambitious new building complex. At the same time the manu-

facturing program is being consolidated and the volume of public relations activity has been increased, as planned.

Also in the current year, when the Company will celebrate its 25th anniversary, it will keep on tackling all new tasks with great energy and initiative.

Interesting facts about microphones

Niere = Cardioid
Kugel = Omnidirectional
Acht = Figure Eight
Keule = "Club shaped" super directional characteristic
Super Kardioid = Super Cardioid

In the following specifications technical terms arise which we would like to explain.

1. Sound and Sound-Waves

Sound in physical terms means vibration of air particles, small fluctuations of air pressure which spread like waves from a source of sound. A space in which this is occurring is referred to as a sound-field. It is the purpose of a microphone to convert sound-waves into electrical energy. The quality of a microphone is its ability to effect this conversion accurately.

2. Sound Pressure

The human ear responds to the change in pressure in a sound-wave. The amplitude of the pressure variations is measured in μbar (equivalent to dynes per square centimeter). A steady pressure of one μbar represents one millionth of the pressure of the atmosphere which surrounds us. If you listen to someone speaking in a normal voice at a distance of about two feet the alternating pressure which your ears are detecting is about one μbar .

The world is slowly changing from this old system of units and the μbar is gradually being replaced by the new unit of sound pressure, the Newton per square meter (N/m^2). This is a unit from the new international MKSA* system. Engineers and Scientists have been using this system for some time since it has a number of advantages over the old CGS** system from which the Microbar derives. There is a simple relationship between the Newton per square metre and the Microbar: $1 \text{ N}/\text{m}^2 = 10 \mu\text{bar}$.

3. Microphone Characteristics, Directivity

Like the human ear many commonly used microphones respond to the alternating pressure in the sound-wave and convert these fluctuations of pressure into electrical energy. With such microphones the sound pressure acts on the outside of the diaphragm only. This means in practice that they respond to sounds from all directions equally well. They have, as it is called, an approximately omnidirectional characteristic.

There is also an important group of microphones which are useful because they respond to sound pressure gradient. This means in practice the pressure difference between adjacent points in a sound-field. In this type of microphone the back of the diaphragm is also exposed to the sound-field but through an acoustic labyrinth. The result of this type of construction is that the microphone does not respond equally to sound

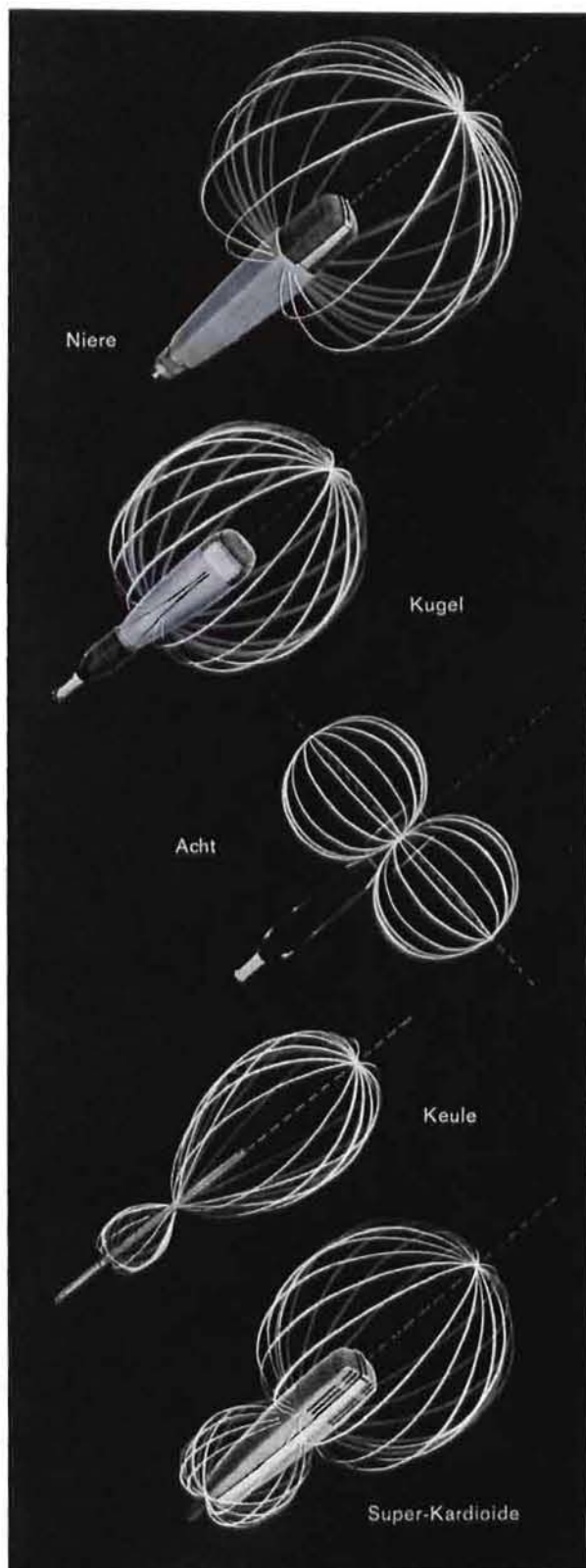

* The MKSA system uses basic units of the meter, kilogram, second and ampere, and all other units are derived from these.

** The CGS system works on the basis of the centimeter, gram and second, and the electrical units are related to these.

from all directions. There are various types of directional microphones, those with a cardioid characteristic, those with a super-cardioid characteristic, and also the figure 8 characteristic. The cardioid characteristic is particularly interesting since it represents a maximum sensitivity in the forward direction with a minimum pick-up of random sounds reflected from the walls of a room. Since this type of microphone has the properties which are expected from a cardioid microphone particularly accentuated, the characteristic is frequently referred to as a super-cardioid.

In another design a cancellation (or interference tube) is fitted in front of the microphone diaphragm. This results in a particularly directional type of microphone having an almost cone-shaped directional pattern.

Directional microphones show to particular advantage in difficult acoustical conditions e. g. in reverberant (live) rooms, for sound reinforcement use where the microphone may be close to the loudspeaker, and for "spotting" soloists in stereo recordings.

The illustrations on the opposite page show the directional characteristics of various types of microphones. The white cages around the microphones represent their directional patterns.

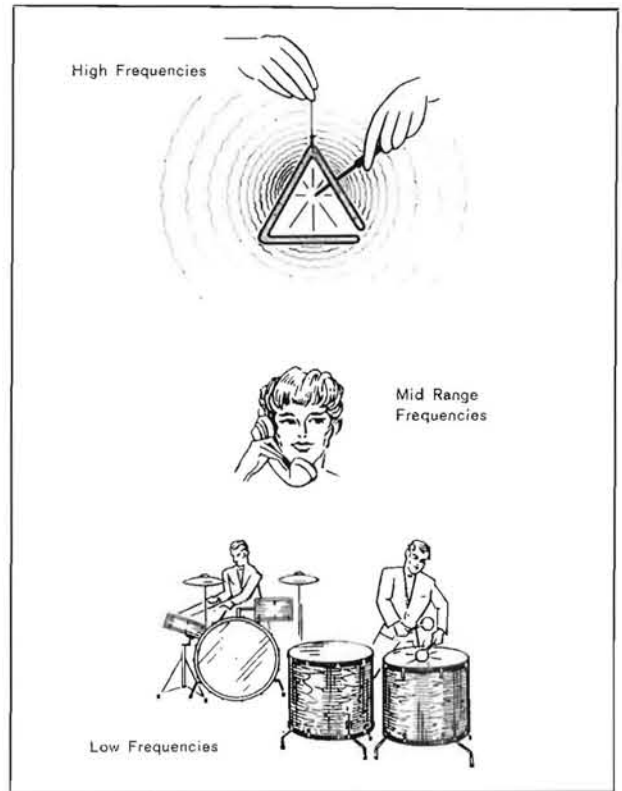

4. Frequency, Frequency Response

The quality of a microphone is determined by its capacity to convert all sounds into electrical vibrations equally well, over the whole audio spectrum. The pitch of a sound, its frequency, is measured in hertz (Hz) = cycles per second. The higher the pitch, the higher is the frequency. The human ear can perceive sound vibrations from approximately 16 Hz up to 15,000 Hz (15 kHz). For the recording of music a microphone should have an equal response to sounds from 50 Hz up to 15,000 Hz. For intelligibility of speech it is sufficient for the microphone to have a response from about 200 Hz up to 5 kHz.

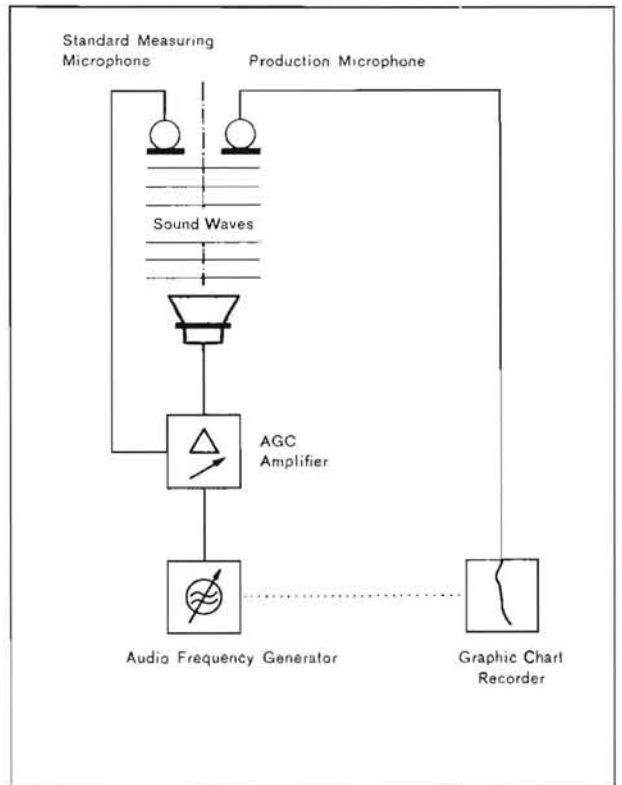

5. Frequency Response, Sensitivity and the Decibel

In order to record objectively a microphone's capacity to translate acoustical sounds into electrical impulses, a frequency response curve is drawn. It illustrates the variation of sensitivity with frequency of a microphone. The usual way of making this measurement is shown on page 5. Sounds of varying frequency emitted by the loudspeaker in a dead room are picked up by the test microphone, amplified and recorded on the frequency response chart.

The sensitivity is the alternating voltage measured in mV (Millivolt) at the output of the microphone which results when a sound-wave with a sound pressure of 1 μ bar falls on the microphone. The sensitivity figures quoted in our data sheets refer to measurements made in a "free field" condition with the microphone unterminated and are normally quoted in millivolts per μ bar. In the MKSA system sensitivity would be quoted in

$\frac{V \cdot m^2}{N}$ (Volts per Newton/m²). There is a simple

relation between the two systems as shown.

$$1 \text{ mV}/\mu\text{bar} = 10 \frac{\text{mV} \cdot \text{m}^2}{\text{N}}$$

So for example the free field sensitivity of the Sennheiser moving coil microphone MD 21 is approximately 0.2 mV/ μ bar (0.2 millivolts per microbar). In the MKSA system this would be shown as

$$2 \frac{\text{mV} \cdot \text{m}^2}{\text{N}}$$

For magnetic microphones it is customary to quote the sensitivity with the microphone terminated. The value of the terminating resistance is quoted. The measurement of the sensitivity of a microphone is performed with the sound-wave falling perpendicularly on the membrane of the microphone and unless otherwise stated all frequency response curves are recorded in the same way (on the axis). To judge the variation of frequency response with angle of incidence of sound particularly with directional microphones, other frequency response curves are often shown typically for sound incidence of 90°, 135° and 180° to the axis of the microphone. The difference between the response at 0° and at 180°, i. e. the front and the back of the microphone is frequently referred to as the front to back ratio of a microphone with a

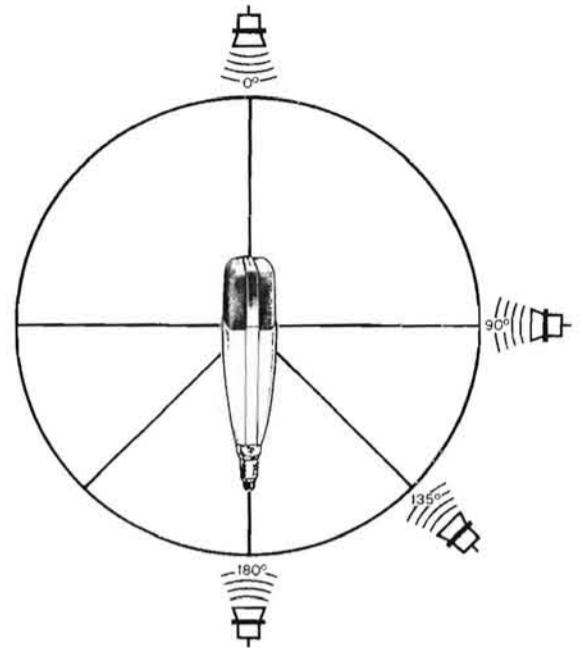

cardioid characteristic. To interpret a frequency response curve it is necessary to be able to assess quickly the various ratios of measured values of sensitivity at different frequencies. In electroacoustics a logarithmic scale is used for the portrayal of the various values whose unit is the Decibel (dB). The dB scale expresses the measured values in a logarithmic relationship. Thus two (values of electrical power) which have a ratio of 10 to 1 are said to be different by 10 dB, and two electrical voltages having a ratio of 10 to 1 have a difference of 20 dB. Thus we have:

0 dB voltage ratio	1 : 1
3 dB voltage ratio (approx.)	1 : 1,4
6 dB voltage ratio (approx.)	1 : 2
10 dB voltage ratio (approx.)	1 : 3,16
20 dB voltage ratio	1 : 10
40 dB voltage ratio	1 : 100

Datas are quoted in dB to enable one to assess quickly the relationship between two measured values eg. different parts of one frequency response curve or in comparison of two response curves or sensitivities.

Let us examine two examples of frequency response curves. The first example is the frequency response curve of an omnidirectional studio microphone.

The frequency response curve is flat over a wide frequency range. The decrease in sensitivity at 20 Hz compared with the sensitivity at 1 kHz is of the order of 4 dB. You will notice a gentle rise in the on-axis response (0°) at the higher frequencies (above 5,000 Hz) — in practice this is frequently a desirable feature. This high frequency rise can be traced to a "pressure doubling" effect which occurs at the diaphragm of every microphone at high frequencies. For sound-waves incident from the side of the diaphragm this pressure doubling effect is absent. This is shown in the dotted response curve (90°).

Example 1:
Omnidirectional Microphone MKH 105

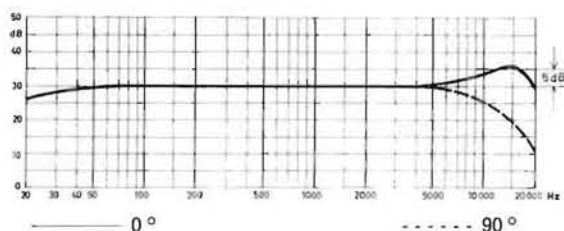

Example two, the response curve of a studio microphone with a cardioid characteristic.

The response curves are smooth over the range 40 Hz to 20 kHz. The on-axis response shows a gentle rise towards the high frequency end of the scale. The drop at 40 Hz compared to 1 kHz is about 6 dB. The curve for sound approaching the back of the microphone (180°) is 26 dB below the curve for on-axis sound-waves (at 1000 Hz). The front to back ratio is therefore 26 dB at this frequency. The front to back ratio is maintained over a wide frequency range (the distance between the two curves varies only a little with frequency), likewise the curve for incidence at 90° has a very constant spacing from the on-axis response. From this we conclude

Example 2:
Cardioid Microphone MKH 405

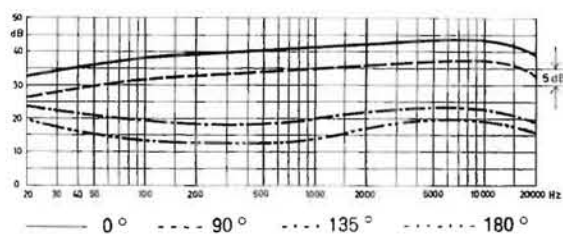

that this microphone has a very accurate cardioid characteristic over a wide frequency range. For precise stereo recordings it is important that the microphone should have a smooth frequency response for the 90° incident sound. Any central sound source is picked up equally by the two directional microphones from their sides.

In our data sheets every microphone has a stated frequency response. In production small variations occur. The dotted curves on the frequency response chart show the maximum tolerances allowable. In production every Sennheiser microphone is tested acoustically in an anechoic chamber and the frequency response is recorded.

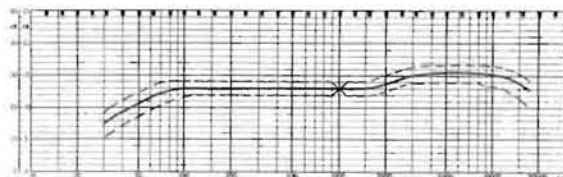

Nominal Frequency Response Curve (with Tolerance Limits)

6. Polar Diagram, Directivity

The directional properties of microphones can be demonstrated by means of a polar diagram. The polar diagram shows the shape of the directional characteristic of a microphone (omni, cardioid, etc.).

A microphone is placed in a sound-field in an anechoic chamber at a fixed frequency and is rotated slowly. The relative sensitivity of the microphone for sound approaching it at varying angles is recorded. The sensitivity to sound on the axis of the microphone (0°) is taken as a reference of 1.0. The sensitivity of the microphone at any given angle is shown on the polar diagram by the distance of the response curve from the centre of the diagram.

For example let us show you the polar diagram of the studio cardioid microphone MD 421. For the sake of clarity the diagram is shown in two halves. Instead of plotting the six response curves all together, the response for 250 Hz, 1 kHz and 4 kHz are shown on the left half of the diagram and the response for 500 Hz, 2 kHz and 8 kHz are shown on the right-hand half of the diagram. Of course each response curve would continue as a mirror image of the opposite half of the circle.

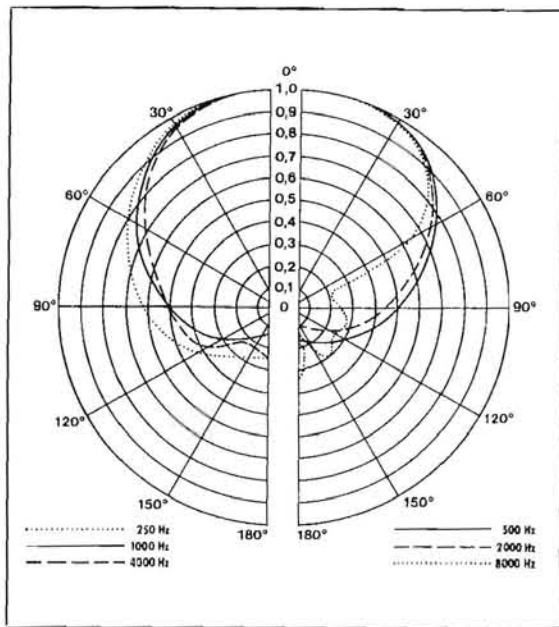

MD 421 Polar Diagram

The purpose of a directional microphone is to suppress unwanted sounds. The measure of the power of a microphone in this regard is the so-called directivity factor of the microphone which can be calculated from the directional characteristics. The directivity factor indicates how much greater the total power input of the room sound would be if a microphone with the same axial sensitivity had an omnidirectional characteristic. For an ideal cardioid microphone the directivity index would have a value of 3. This means in practice because the directivity index is related to acoustic power, and the acoustic power decreases as the square of the speaking distance, you can increase the speaking distance by a factor $\sqrt{3}$ (= 1,73 times) compared with an omni directional microphone of the same sensitivity. If an omnidirectional microphone and a cardioid microphone are placed in the same room and arranged so that the omnidirectional microphone is 1 m and the cardioid microphone is 1,73 m from the speaker, the percentage of room "acoustic sound" will be the same for the two microphones. Obviously if the two microphones were at the same speaking distance the cardioid microphone would give a more "intimate sound" than the omnidirectional microphone.

In certain situations it is better to have a microphone with a super-cardioid characteristic having a directivity index of 4 and even more so with microphones having a cone type characteristic such as the Sennheiser gun microphone MKH 805. The MKH 805 has a directivity index in the middle frequencies of approximately 6 and the index increases from 3 at low frequencies to 11 at high frequencies.

7. Source Resistance, Electrical Impedance

Every microphone has, as a source of electrical currents, an internal resistance and electrical impedance known as its source impedance. It is quoted in ohms usually at a frequency of 1,000 Hz. It is important to know the value of this source impedance so that the microphone can be optimally matched to the impedance of the following amplifier. With dynamic microphones (moving coil microphones) this source impedance is frequently 200 Ω . To connect such a low impedance microphone to a high impedance amplifier one should use a step-up transformer.

The effective internal resistance of the microphone is increased by the square of the turns ratio of the transformer. For example if the transformer turns ratio is 1 to 20, the internal resistance of the microphone of 200 Ω would be increased to a value of $200 \Omega \times 400 = 80,000 \Omega$. In this case it would be advisable for the input impedance of the amplifier to be above this value (80,000 Ω) otherwise a transformer with a smaller turns ratio would be required. Suitable transformers are available from Sennheiser in various values. Some of the dynamic microphones have built-in transformers for direct connection to high impedance amplifiers. These microphones also have an alternative low impedance output direct from the moving coil (see paragraph 10).

8. Minimum Load Resistance

Sometimes microphones have a quoted nominal impedance. This nominal impedance (nominal terminating impedance) of a microphone is the value of the electrical resistance into which the microphone is designed to work, i. e. "a 200 Ω " microphone is intended to work into an impedance of 200 Ω . For microphones with a built-in amplifier e. g. the Sennheiser condenser microphones, it is most important that the minimum load resistance values quoted in the data sheets are observed otherwise distortion will result, since the source impedance of these microphones is considerably lower than their nominal impedance.

9. Overload Levels

Dynamic microphones can withstand such high sound pressure levels that it is hardly necessary to quote an overload level. It is different with condenser microphones since excessively high sound levels can cause distortion in the amplifying circuits.

10. Balanced and Unbalanced Microphones

Microphones can be connected to amplifiers and tape recorders with either balanced or unbalanced connections. In the balanced connection both signal leads are isolated from ground. The two wires from the microphone could therefore be interchanged without affecting the signal. This would, however, reverse the "phase" of the microphone and where microphones are being used in pairs for stereo recording or a "multi-mike" situation, the phase of the microphone is important. DIN 45 594 is the European standard for the phasing of microphones.

For unbalanced connections only single core shielded cable would be required since the cable shield acts as the second conductor for microphone signals. However, even for unbalanced connections it is better to use a two core shielded cable with the second inner core of the cable acting as the ground return for the microphone so that hum currents are not induced in this lead. The advantage of balanced connections is, amongst other things, that when long cable runs are used and with only moderate shielding of the cable, interference signals induced in the cable such as hum and switching clicks will cancel in the input transformer of the following amplifier. The balanced connection is almost always used in studio installations where long cable runs are typical.

The danger of interference in unbalanced circuits using relatively short cables with effective shielding, is not too serious and is often used by amateurs because of its simplicity and because most low priced amplifiers and tape recorders have unbalanced input circuits.

High impedance outputs from microphones are always unbalanced, and the high impedance input of amplifiers are also always unbalanced. However, very good shielding is required and only short cables can be used.

In the following data sheets on our microphones you will see the following codes used: N, HL, HLM, LM or -2.

The suffix N indicates that the microphone is fitted with a cable connector to the DIN standard 41 524 and is connected according to the DIN standard 45 594 for low impedance balanced connection to pins 1 and 3. Such microphones can be connected with up to 200 m of two core shielded cable without the addition of a step-up transformer, to tape recorders or amplifiers with low impedance inputs. For high impedance inputs it is essential to use a step-up transformer at the amplifier end of the cable. On pages 74 and 75 you can see further details of cable transformers.

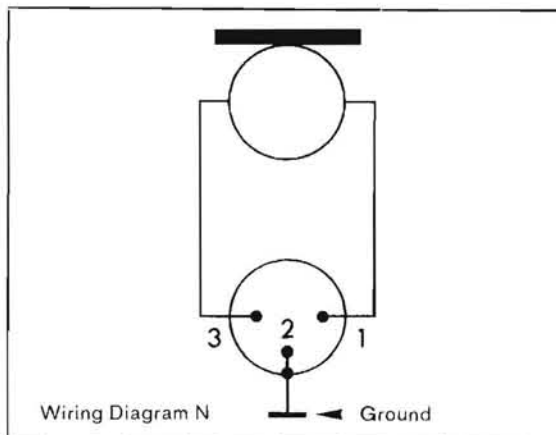

The suffix HL added to the type number of a Sennheiser microphone indicates that this microphone has a built-in transformer and that both high and low impedance outputs are available at the cable connector wired according to DIN 45 594. It is because of the built-in transformer that the HL type microphone costs a little extra. HL type microphones can be connected directly to all vacuum tube operated tape recorders and amplifiers having a high impedance input but with a maximum cable length of 2 m. An HL type microphone will also connect directly to a low impedance amplifier input and with relatively long cables. Where a long cable is required to an amplifier or tape recorder having a high impedance input, a step-up transformer must be used such as type TM 514 HL which has only a short connection between the transformer and the amplifier input and will not affect the sound quality.

ne is
stan-
o the
anced
ones
core
ep-up
s with
ce in-
ormer
es 74
cable

The suffix HLM which is applied to our microphone MD 411 HLM indicates a triple impedance facility. Such a microphone has the high and low impedance facilities of an HL microphone and also a medium impedance output. The microphone connector is wired according to DIN 45594 as shown in the diagram opposite. The medium impedance output is particularly suitable for transistorized tape recorders and amplifiers. The circuit diagram HLM shows that the switching from HL to M is effected by an internal switch. The HLM facility is universal. It enables connection of the microphone to any type of amplifier or tape recorder.

Microphones wired as per diagram LM do not have this connective capacity. Basically, they are microphones with an M switch which means that they are designed for medium impedance transistorized recorders. However, the bridge between contacts 1 and 3 makes it possible to use them for low impedance unbalanced inputs (as per diagram L, connections 3 and 2).

The suffix -2 indicates a microphone with a balanced output and fitted with a large Tuchel connector T 3079/2 wired according to DIN standard 41624. There is no acoustical difference between this and other parallel types mentioned below.

The suffix-U indicates a low impedance microphone with a balanced output and fitted with a XLR-type three prong male connector.

The following mode of connection is advised: For equipment with high impedance inputs, use, if possible, low impedance microphones with step-up transformers. One is then free to use any desired length of microphone cable. If you need only 2 m of microphone cable, an HL or HLM microphone will be more economical since it can be connected directly without a cable transformer. For transistorized equipment the medium impedance M connection is the simplest possibility. In general the high sensitivity of Sennheiser microphones enables the low impedance version to be connected directly to transistorized amplifiers and tape recorders. Long cables may be used in this connection.

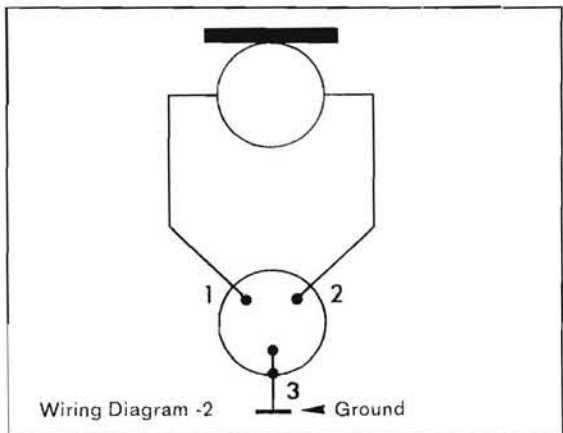
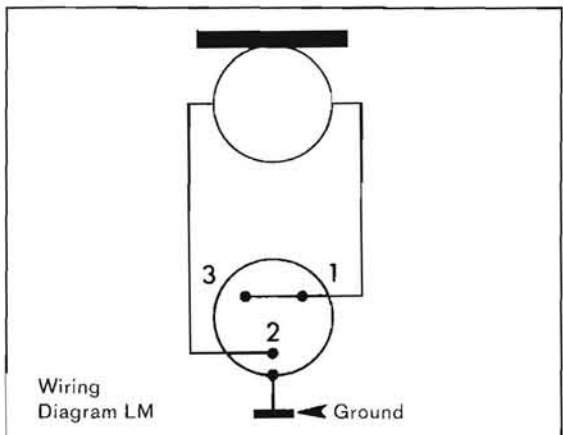
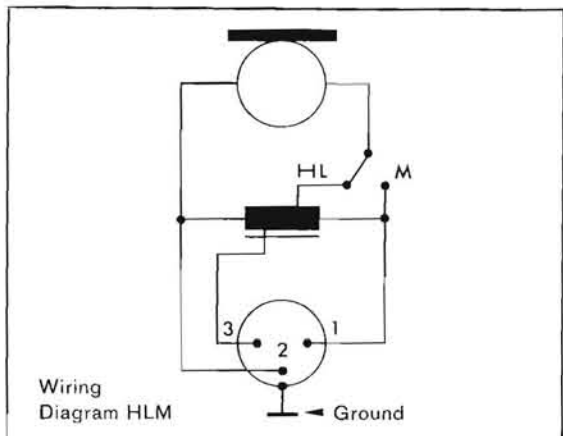
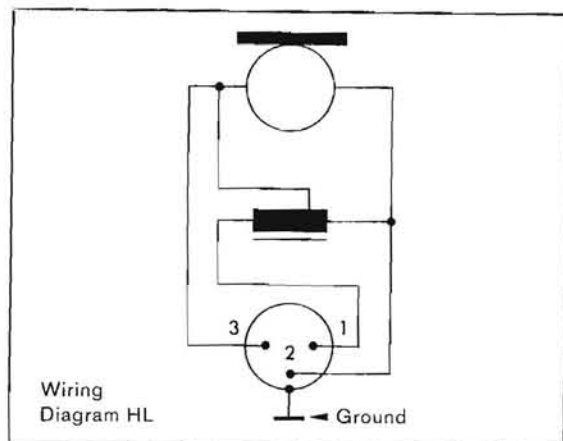

of a
s mi-
both
ple at
DIN
ormer
extra.
rectly
s and
t with
micro-
mpe-
long
o an
mpe-
t be
nly a
and
ound

11. Noise Voltage, Equivalent Noise, Signal to Noise Ratio

If you bring a microphone into a completely noise free room and connect it to a very good amplifier, you will notice a hiss or rustling sound which originates from the microphone. In dynamic microphones this noise is caused by the thermal agitation of electrons in the resistance of the moving coil of the microphone. In condenser microphones this noise derives from several sources.

The noise output of a microphone can be measured with a voltmeter and a weighting network to the DIN standard 45405. The weighting network is an equalizer which has a frequency response which simulates the response of the human ear to attenuate sounds and enables the measuring instrument to give an indication of the subjective effect of the noise. The DIN standard requires the use of a peak reading measuring instrument to follow the weighting network.

From the noise voltage and the sensitivity of the microphone the equivalent noise output can be derived in which 2×10^{-4} μbar is used as a reference level. 2×10^{-4} μbar represents in practice the threshold of hearing of the human ear at 1,000 Hz. With the help of the equivalent noise figure it is possible to compare the noise properties of various microphones with one another and as a matter of fact, independently of the sensitivity of these microphones.

If the equivalent noise of a microphone is 24 dB and that of another microphone 28 dB, one could say that the first microphone can successfully record sounds which are 4 dB quieter than the second and furthermore, that the noise output of the microphone corresponds to an acoustic noise with a level of 24 or 28 dB above the threshold of hearing.

Unfortunately, the measurement of noise voltages and consequently of equivalent noise, is not uniformly handled. Other weighting networks as opposed to the German standard are used by other manufacturers and instead of peak reading measurements, the RMS value is used. The DIN standard 45591 stipulates that the noise voltage with a noise measurement system according to DIN 45405 should be used. Sennheiser microphones are calibrated according to this standard and this should be borne in mind when making comparisons with other types of microphones.

Now according to new international standards the idea of loudness should only be used for subjective comparisons with a 1,000 Hz tone. There is such a discrepancy between existing measuring instruments and the subjective values that this concept can no longer be used. For this reason the concept of equivalent noise volume will eventually be deleted. Thus there will be no recognition for the concept of equivalent noise voltage. In order to overcome these difficulties in this volume of *Micro-Review* for the first time, in addition to the equivalent noise figure, a signal to noise ratio is quoted. This signal to noise ratio relates to a standard sound pressure level of $1 \text{ N/m}^2 = 10 \mu\text{bar}$. This sound pressure represents the peak sound level of normal speech at a speaking distance of 30 cm and also represents a typical sound level in a musical performance. One can therefore say that the signal to noise ratio is comparable with a practical situation and can be compared with the signal to noise ratio of tape recorders, amplifiers, etc. A conversion to the old equivalent noise concept is quite simple when it is known that 1 N/m^2 is equivalent to a sound level of 94 dB. From this 94 dB the signal to noise ratio figure is subtracted to arrive at the equivalent noise figure. If for example the signal to noise ratio is 60 dB the equivalent noise figure would be 34 dB.

Our Cover

The majority of broadcast stations in Germany and throughout the world are using studio equipment made by Sennheiser Electronic. During the past 25 years Sennheiser microphones in particular proved to be a reliable aid to the radio, television

and motion picture industries. Sennheiser products have made many friends — not only in the studio but also in the home. Our cover shows a few photographs of TV shows in which Sennheiser products are being used i. e.:

- 1 A pop group using the MD 421.
- 2 The MK 12 condenser microphone worn on the lapel is, due to its minute size, hardly noticeable. The SK 1007 transmitter is carried inside the coat pocket.
- 3 The MD 214 N Lavalier microphone shock-mounted to eliminate contact noises, is widely used because of its superior frequency response.
- 4 The outstanding quality of the MD 421 makes it the most popular microphone among professional entertainers.
- 5 The HD 414, already famous for its superb frequency response, became even more widely known after it received a price winning award for its industrial design from the German Government. It is shown here during a television newscast.
- 6 The omnidirectional microphone MD 21 is often used in studios for interviewing purposes. But also soloists can be seen on TV using this "work-horse" most frequently.
- 7 Throughout Europe the MD 421 has become the standard microphone in the television and broadcast industries.
- 8 This picture you will hardly ever see on TV. Because of the extremely directional pattern of the MKH 805 and 815 condenser "shot gun" microphones, they are used on a boom. These microphones pick up the sound at a large distance, thus enabling the cameraman to take his picture without showing the microphone.
- 9 In the center of the Sennheiser products is the HD 414 stereo headset of which more than 150,000 units have been sold during the past two years.

micro-revue
70/71



SENNHEISER
25 JAHRE



SENNHEISER ELECTRONIC 3002 BISSENDORF/HANNOVER TELEFON (0 51 30) 80 11 TELEX 09 2423

Product Group 1 Dynamic Microphones



Studio Microphone MD 21

The dynamic studio microphone MD 21 is one of the most successful produced by Sennheiser. In the last 15 years over 270,000 of these models have been manufactured, with a significant proportion of these being used in radio and television studios throughout the world.

This microphone has become an international standard for quality and reliability in dynamic microphones. How has this come about? The German Broadcasting networks were in need of a reliable high quality microphone for general purpose use. The MD 21 was developed to meet this need. The rugged die-cast casing will withstand heavy treatment but the smooth frequency response meets the stringent requirements of broadcasting authorities. In particular, the 5 dB lift in response between 2,000 and 15,000 cycles, gives the added presence required by the networks. Being an omnidirectional pressure-operated microphone the MD 21 is relatively insensitive to wind noise and is most suitable for exterior use. For outdoor environments a windshield is available as an accessory, Type MZW 22.

MD 21 Types

MD 21 N The standard low impedance type, wired as diagram N (pages 12 and 13). Balanced output.

MD 21 HL Dual impedance type, wired as diagram HL (pages 12 and 13).

MD 21-2 Low impedance, balanced output, fitted with large Tuchel connector, type T 3079/2.



Photo: H. E. Müller

Marie Louise during a broadcast
for the Norddeutsche Rundfunk

Technical Data



Rudi Carrell during one of his TV shows.

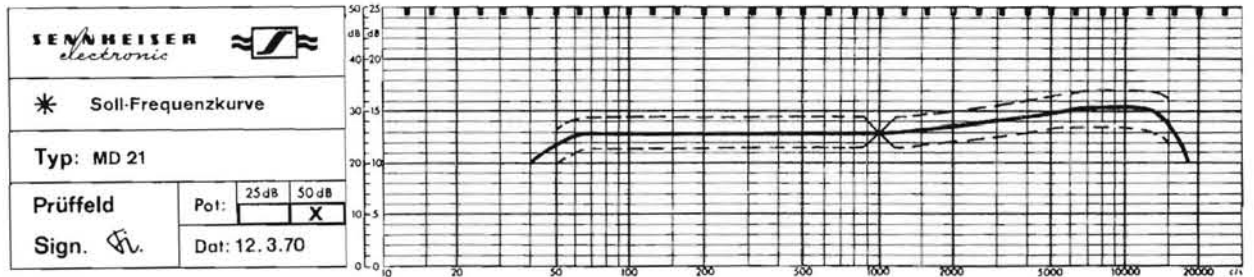

Nominal frequency response curve (with tolerance limits) MD 21

	MD 21 N	MD 21-2	MD 21 HL
Acoustical mode of operation	Pressure sensitive transducer	Pressure sensitive transducer	Pressure sensitive transducer
Frequency range	40 - 18,000 Hz	40 - 18,000 Hz	40 - 18,000 Hz
Tolerance limits	± 3 dB	± 3 dB	± 3 dB
	of reference curve from	of reference curve from	of reference curve from
	50 Hz to 15,000 Hz	50 Hz to 15,000 Hz	50 Hz to 15,000 Hz
Sensitivity at 1,000 Hz	0.2 mV/μbar	0.2 mV/μbar	2.5 mV/μbar, 2.0 mV/μbar
	± 3 dB	± 3 dB	± 3 dB
Output level ref. 1 mW/10 dynes/cm ²	- 53 dbm	- 53 dbm	- 53 dbm and - 54 dbm
EIA rating	- 145.8 db	- 145.8 db	- 145.8 db and - 150 db
Impedance	200 ohm	200 ohm	30,000 ohm 200 ohm
Directional characteristics	omnidirectional	omnidirectional	omnidirectional
Connector	T 3260	T 3079/2	T 3260
Pin connections	1 + 3: signal 2 & case: ground	1 + 2: signal 3 & case: ground	H: 1 + 2: case: ground L: 2 + 3: case: ground
Cable connectors	T 3261	T 3080/2	T 3261
Stray magnetic field interference	≤ 100 μV/50 mG	≤ 100 μV/50 mG	≤ 100 μV/50 mG
Dimensions	120 x 46 x 46 mm	120 x 46 x 46 mm	120 x 46 x 46 mm
Weight	10 oz.	10 oz.	10 oz.

We reserve the right to alter the specifications especially with regards to technical improvements.

Studio Cardioid Microphone MD 421



Probably the most famous of all Sennheiser microphones. So popular with Radio and Television users that Sennheiser were able to go into mass production and bring this superb studio microphone within the price range of the serious amateur.

To date more than 100,000 of these microphones have been supplied throughout the world. The outstanding quality and cardioid characteristic have made this microphone very popular in many radio and television studios. Almost every European radio and television station uses this microphone.

The individual frequency response chart that comes with every microphone will look like the solid curve on the opposite page. The dotted lines show the narrow tolerance limits allowed on a production microphone.

From 2,000 Hz to 17,000 Hz there is a smooth 5 dB increase in the response curve to add presence to the recording.

The cardioid directional characteristic is the other feature that allows natural sound recordings to be made in difficult situations such as small rooms with bad acoustics. Average front to back ratio of 18 dB. Suited for sound reinforcement installations — pop groups and all situations where a microphone has to be used near a loudspeaker. In such situations the variable bass attenuator will allow maximum clarity and presence particularly when the MD 421 is used close to the mouth.

MD 421 types

MD 421 N is the low impedance version, wired according to diagram N (pages 12 and 13). It is fitted with a standard Tuchel connector T 3260.

MD 421 HL is the dual impedance version, wired according to diagram HL (pages 12 and 13). Connector as for MD 421 N.

MD 421-2 is low impedance as the MD 421 N but is fitted with the large Tuchel connector T 3079/2.

MD 421-U is low impedance as the MD 421 N but is fitted with XLR-type three prong male connector.

Models MD 421 N and MD 421 HL only are fitted with a variable bass attenuator. The attenuator is marked: M (music) = flat response, S (speech) = max. bass cut.

Added to the MD 421 range are the MD 421 HL de luxe and MD 421 N de luxe. These microphones are finished in black and gold consequently are naturally preferred by musicians for stage work and festive occasions.



Well known Teldec-Star Paola during a recording session with a MD 421

Technical Data

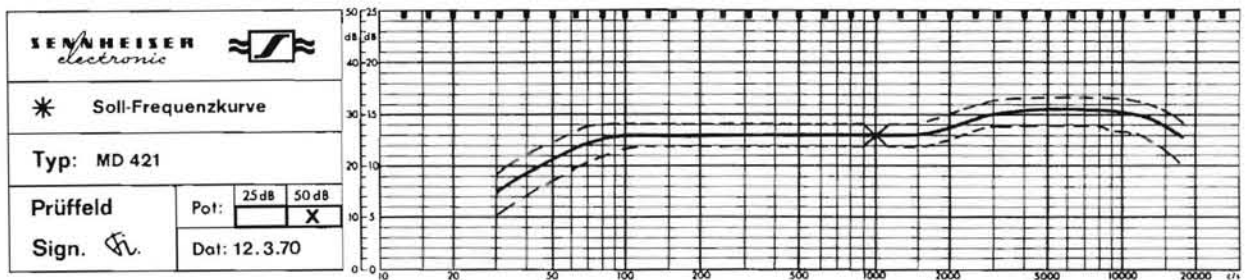
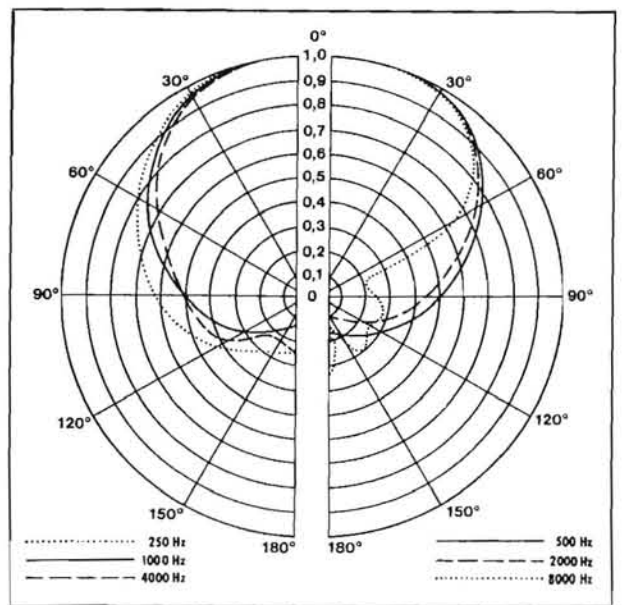

Nominal frequency response curve (with tolerance limits) MD 421
Every MD 421 is supplied with its own factory frequency response curve.

	MD 421 N	MD 421-2	MD 421 HL
Acoustical mode of operation	Pressure gradient	Pressure gradient	Pressure gradient
Frequency range	30 - 17,000 Hz	30 - 17,000 Hz	30 - 17,000 Hz
Tolerance limits	See frequency response curve above	See frequency response curve above	See frequency response curve above
Sensitivity (1 kHz)	0.2 mV/ μ bar \pm 3 dB	0.2 mV/ μ bar \pm 3 dB	0.2 mV/ μ bar & 2.0 mV/ μ bar \pm 3 dB
Output level ref. 1 mW/10 dynes/cm ²	- 53 dbm	- 53 dbm	- 53 dbm and - 54 dbm
EIA rating	- 145.8 db	- 145.8 db	- 145.8 db and - 150 db
Impedance (1 kHz)	200 Ω	200 Ω	200 Ω & 24 k Ω
Directional characteristics	Cardioid	Cardioid	Cardioid
Front to back ratio	18 dB - 2 dB	18 dB - 2 dB	18 dB - 2 dB
Bass attenuator	Yes	No	Yes
Output plug	T 3260	T 3079/2	T 3260
Cable connectors	T 3261/1	T 3080/2	T 3261/1
Connections	1 + 3: signal 2 & case: ground	1 + 2: signal 3 & case: ground	1 + 2 high Ω 2 + 3 Low Ω case: ground
Sensitivity to magnetic fields	approx. 5 μ V/50 mG	approx. 5 μ V/50 mG	approx. 5 μ V/50 mG
Dimensions	177 x 48 x 46 mm	177 x 48 x 46 mm	177 x 48 x 46 mm
Weight	14 oz.	14 oz.	14 oz.

We reserve the right to alter the specifications especially with regards to technical improvements.

Super Cardioid Dynamic Microphone MD 411 HLM



Although the MD 411 HLM microphone is very similar in appearance to that of the MD 421, it was specifically designed for the amateur recordist and costs less than half the price of the MD 421. Naturally some of the features in the MD 421 had to be omitted. The cable is connected permanently to the microphone, and the compensating coil for magnetic leakage fields has been omitted. There is also no bass attenuator.

However, from the home recordist's point of view, the MD 411 has some advantages over its big brother. The amateur does not normally have the advantage of an acoustically treated studio for his recordings and therefore requires a microphone with superior directional properties to remove the unpleasant effects of room echoes. The MD 411 has been designed with this situation in mind.

The response at the sides of a true cardioid microphone such as the MD 421 is reduced only slightly compared with the response on the axis. The MD 411 however, is a super-cardioid whose response is greatly attenuated at the sides of the microphone. A glance at the polar diagram on page 21 shows clearly the superb directional properties of the MD 411 HLM at all frequencies.

Stereo recordings are outstanding made with a pair of MD 411s because of the accuracy of the directional characteristics over the whole audio spectrum. The frequency response is consistent from one microphone to the next, and even in this economical design, the response is controlled to meet the HiFi standard DIN 45 500.

The built-in triple impedance transformer enables the MD 411 HLM to be connected directly to any tape recorder. High impedance (H) = 25,000 ohms for tube recorders; Medium impedance (M) = 800 ohms for transistorized recorders; Low impedance (L) = 200 ohms for recorders of either type, fitted with low impedance input circuitry.

A selector switch on the underside of the microphone gives a choice of high and low impedance or medium impedance connection, as shown on the diagram on page 13.

The MD 411 HLM comes complete with its table stand-floor stand-adaptor and zip-up cushioned case.



The super-cardioid microphone MD 411 HLM
being used for commentary recording

Technical Data

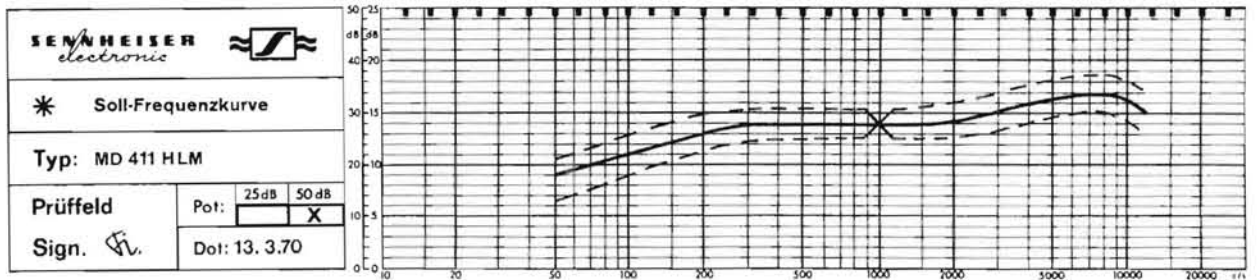
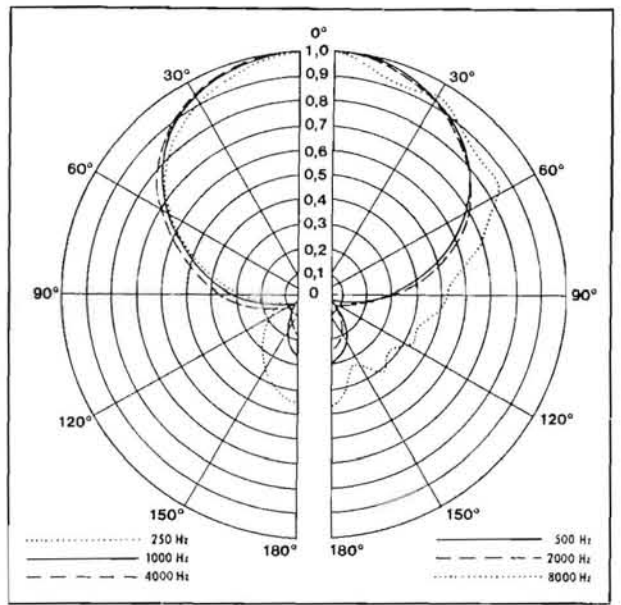

Nominal frequency response curve (with tolerance limits) MD 411 HLM

MD 411 HLM

<p>Acoustic mode of operation</p> <p>Directional characteristic</p> <p>Side attenuation at 120°</p> <p>Directivity index</p> <p>Frequency range</p> <p>Tolerance limits</p> <p>Sensitivity at 1 kHz</p> <p>Output level ref. 1 mW/10 dynes/cm²</p> <p>EIA rating</p> <p>Impedance</p> <p>Pin connections: case to screen</p> <p style="padding-left: 20px;">Switch to "M"</p> <p style="padding-left: 20px;">Switch to "HL"</p> <p>Output plug</p> <p>Cable socket required</p> <p>Dimensions</p> <p>Weight</p> <p>Weight of stand</p>	<p>Pressure gradient</p> <p>Super-cardioid</p> <p>≥ 20 dB - 2 dB</p> <p>≥ 3.5 - 0.2</p> <p>50 Hz to 12,000 Hz</p> <p>to HiFi standard DIN 45 500</p> <table border="0" style="width: 100%;"> <tr> <td style="text-align: center;">M</td> <td style="text-align: center;">H</td> <td style="text-align: center;">L</td> </tr> <tr> <td style="text-align: center;">0.25 mV/μbar</td> <td style="text-align: center;">1.25 mV/μbar</td> <td style="text-align: center;">0.12 mV/μbar</td> </tr> <tr> <td style="text-align: center;">- 57.1 dbm</td> <td style="text-align: center;">- 58.1 dbm</td> <td style="text-align: center;">- 57.5 dbm</td> </tr> <tr> <td style="text-align: center;">- 150 db</td> <td style="text-align: center;">- 154 db</td> <td style="text-align: center;">- 150 db</td> </tr> <tr> <td style="text-align: center;">800 Ω ± 15 %</td> <td style="text-align: center;">25 kΩ ± 20 %</td> <td style="text-align: center;">200 Ω ± 20 %</td> </tr> </table> <table border="0" style="width: 100%;"> <tr> <td style="text-align: center;">1 & 2</td> <td style="text-align: center;">-</td> <td style="text-align: center;">-</td> </tr> <tr> <td style="text-align: center;">-</td> <td style="text-align: center;">1 & 2</td> <td style="text-align: center;">2 & 3</td> </tr> </table> <p>Mas 30 (Continental 3 pin)</p> <p>Mak 30 S (Continental 3 pin)</p> <p>140 x 38 x 38 mm</p> <p>8 ozs.</p> <p>2 ozs.</p>	M	H	L	0.25 mV/μbar	1.25 mV/μbar	0.12 mV/μbar	- 57.1 dbm	- 58.1 dbm	- 57.5 dbm	- 150 db	- 154 db	- 150 db	800 Ω ± 15 %	25 kΩ ± 20 %	200 Ω ± 20 %	1 & 2	-	-	-	1 & 2	2 & 3
M	H	L																				
0.25 mV/μbar	1.25 mV/μbar	0.12 mV/μbar																				
- 57.1 dbm	- 58.1 dbm	- 57.5 dbm																				
- 150 db	- 154 db	- 150 db																				
800 Ω ± 15 %	25 kΩ ± 20 %	200 Ω ± 20 %																				
1 & 2	-	-																				
-	1 & 2	2 & 3																				

We reserve the right to alter the specifications especially with regards to technical improvements.

Super Cardioid Dynamic Microphone MD 402 LM

A high quality but medium priced microphone to meet the needs of the recording novice was long overdue. The MD 402 from Sennheiser electronic fills this gap without sacrificing the well known Sennheiser quality. Special care has been taken to design a microphone for the widest possible range of users.

The steel body of the MD 402 is insensitive against shocks and drops. It contains a high quality and acoustically sensitive dynamic system capable of fulfilling all the wishes of the demanding amateur. The wide frequency range together with the super cardioid characteristics ensure best results even in noisy or reverberant surroundings. The "built-in-windscreen" not only protects the sensitive capsule but also suppresses the annoying pop and windnoises when used closely. This special feature ensures good quality recordings even for the unexperienced.

The MD 402 LM is connected in the medium impedance configuration (see pages 12 and 13) so that it can be used directly with about 90 % of all tape-recorders at present on the market. If only a high impedance microphone input is available the TS 514 M transformer-adapter must be used which is fitted a 5 meter long extension cable. A detailed description of this adapter can be found in the accessory program on page 53. The standard 1.5 meter connecting cable provided uses a three prong male connector as per DIN 41 524.



Baby's talk is going to be recorded for the family's archives with the MD 402 LM.

Technical Data

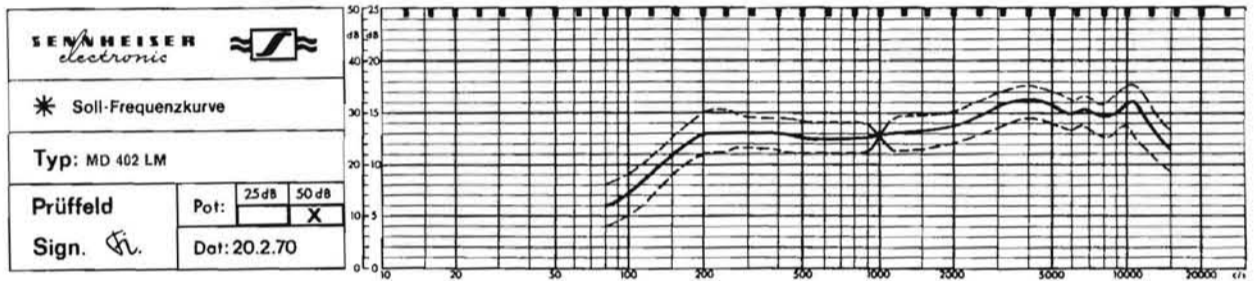
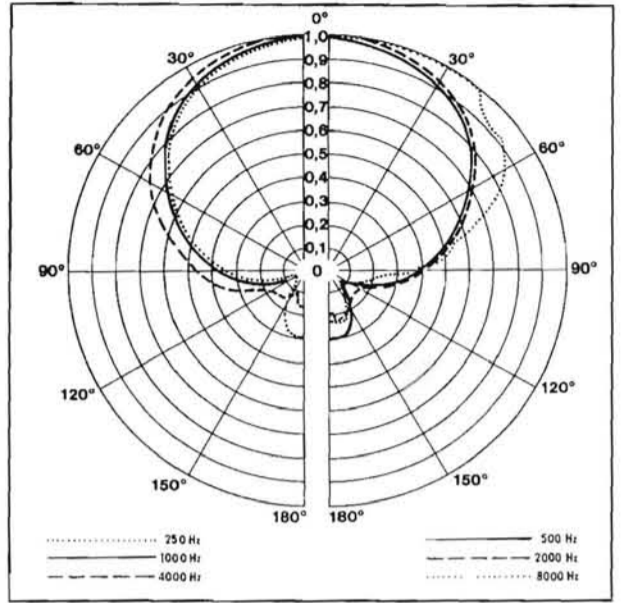

Nominal frequency response curve (with tolerance limits) MD 402 LM

MD 402 LM

Acoustic mode of operation	pressure gradient
Frequency range	80 ... 12,500 Hz
Tolerance limits	see graph
Directional characteristics	super cardioid
Attenuation at 120°	20 dB - 2 dB
Directivity index	3.5 - 0.2
Sensitivity at 1 kHz	0.23 mV/μbar ± 3 dB
Impedance	750 Ω
Load	4 kΩ
Pin connections	1 = 3 → coil 2 → ground
Connectors	DIN 41 524, Mas 30
Cable socket required	DIN 41 524, Mak 30 S
Dimensions	21 mm φ x 145 mm
Weight	appror. 185 grams with cable
Length of cable	1.5 meter

We reserve the right to alter the specifications especially with regards to technical improvements.

Studio Microphone MD 211 N



Perhaps one of the finest moving coil microphone in the world. The frequency response shown below can be seen to be so smooth and so wide in range that the MD 211 N might almost be considered to be a condenser microphone. Its small size and elegant design have made it equally as popular with orchestral recording engineers as with pop groups. The test certificate and frequency response curve issued with every MD 211 N bears testimony to the fact, that no microphone leaves the factory having a deviation of more than 2.5 dB from the nominal response from 40 to 20,000 cycles per second. The extended low frequency response enables the recording of organ pedal notes with thrilling realism, while the smooth response over the treble range gives a natural quality seldom heard with a moving coil microphone. Not only does this microphone have an outstanding frequency response, it is rugged and suitable for exterior use.

A windshield, Type MZW 201, is available.

The MD 211 N has a low impedance balanced output, wired according to diagram N page 12.

For use with tape recorders with high impedance inputs use step-up cable transformer TM 513 N.

This microphone is also available with Cannon XLR connector, the model number is MD 211 U.

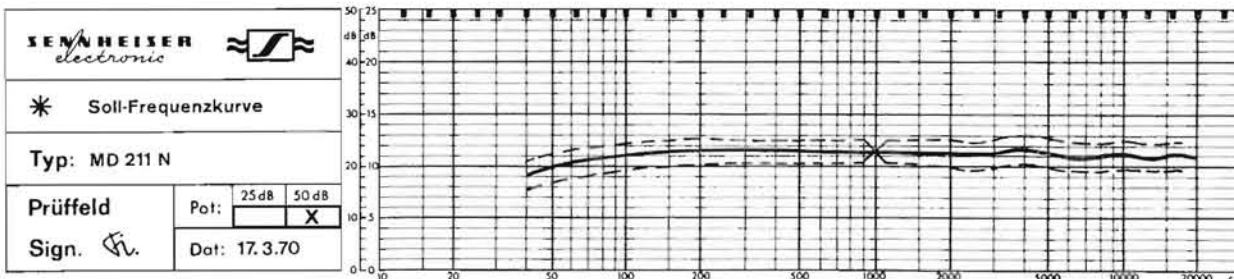

Nominal frequency response curve (with tolerance limits) MD 211 N

Every MD 211 is supplied with an individually plotted frequency response curve.

Technical Data

MD 211 N

Acoustical mode of operation	Pressure sensitive transducer
Frequency range	40 - 20,000 Hz
Tolerance limits	± 2.5 dB from reference curve (above) from 40 to 20,000 Hz
Sensitivity at 1,000 Hz	0.13 mV/ μ bar ± 2.5 dB
Output level ref. 1 mW/10 dynes/cm ²	- 56.8 dbm
EIA rating	- 149.3 db
Impedance at 1,000 Hz	> 200 ohms
Directional characteristic	Omnidirectional
Connector	T 3260 or XLR
Pin connections	T 3260 = 1 + 3, signal, 2 & case, ground XLR = 2 + 3: signal, 1: ground
Cable connector	T 3261/1
Leakage magnetic field sensitivity	40 μ V/50 mG
Dimensions	Diameter 22 mm, length 120 mm
Weight	5 oz.

We reserve the right to alter the specifications especially with regards to technical improvements

Goose Neck Directional Microphone MD 408 N

Frequently there is a requirement for a microphone to be mounted on a flexible goose neck. This usually means paying for a microphone and a goose neck in addition. Not in this case.

The MD 408 N is a super cardioid microphone built-on-to a goose neck stand, complete with a silent operating on-off switch. The result is an elegant but unobtrusive design which looks well in architectural installations for sound reinforcement applications and, mounted on a floor stand, provides a high class microphone for use on stage. In both situations the directional pattern of this inexpensive microphone provides a superior result, which will be of great advantage for the recording Amateur as well.

The advantages of the directional pattern of the MD 408 N are increased by the extremely smooth frequency response — extending to 14,000 Hz — which greatly reduces the usual tendency to acoustical feedback or "howl round".

The MD 408 N is wired according to diagram N on page 12.

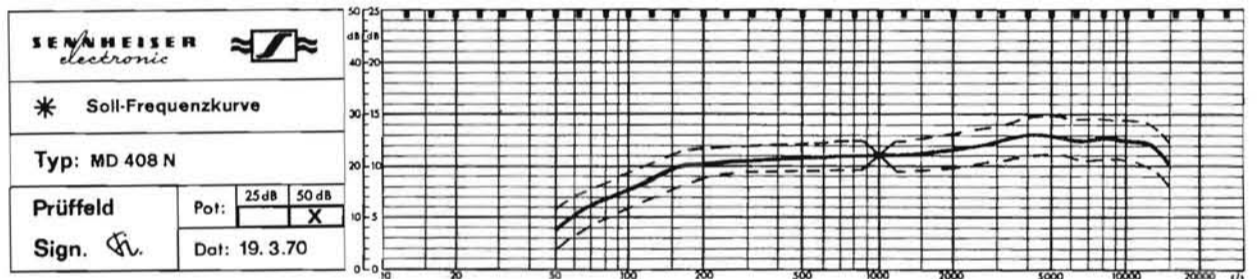

Nominal frequency response curve (with tolerance limits) MD 408 N

Technical Data

MD 408 N

Acoustical mode of operation	Pressure gradient transducer
Frequency range	60 - 14,000 Hz
Tolerance limits	± 3 dB from the reference curve above
Sensitivity at 1,000 Hz	0.13 mV/μbar ± 3 dB
Output level ref. 1 mW/10 dynes/cm ²	- 56.8 db
EIA rating	- 149.3 db
Impedance at 1,000 Hz	200 ohms nominal
Directional characteristic	Super-cardioid
Sound reduction at 150° to axis above 1,000 Hz	± 15 dB - 3 dB
Connector	T 3260
Pin connections	1 + 3: signal (balanced) 2 & case: ground
Cable connector	T 3261/1
Dimensions	Head 40 mm diameter Length of stem 300 mm
Weight	10 ozs. approx

We reserve the right to alter the specifications especially with regards to technical improvements.

Lavalier Microphone MD 214 N

This is a very special microphone with a number of unique features. A considerable research program was undertaken to determine the best way to achieve the natural response of the human voice when a microphone is worn against the chest. If a microphone with a flat frequency response is used in this position, the resonance of the chest and the interference of clothing combined produce a tubby and unnatural sound. It was found that the most natural voice quality was achieved when a microphone with a flat response was equalized to have a response with a dip at 700 cycles in order to reduce the effect of the chest resonance, and a 5 dB peak between 3,000 and 10,000 cycles, to overcome the masking effect of clothing. To achieve this, Sennheiser uses the capsule of the MD 211 N microphone in conjunction with an electrical equalizer.

A further problem with Lavalier microphones is the interference of rustle — caused by rubbing of the housing and cable against clothes. To reduce this effect the capsule of the MD 214 N is springmounted inside the case. The rectangular section of this case has the additional advantage that the microphone is less inclined to roll from one side to the other on the wearer's chest. The MD 214 N is a pressure operated moving-coil microphone and has therefore an omnidirectional characteristic. A feature which will be appreciated by service departments is that in case the microphone cable is damaged it can be changed quickly and easily by removing the screw link at the base of the microphone.

MD 214 Types

MD 214 N has a balanced low impedance output, wiring as diagram N (page 12 and 13).

MD 214-1 * has the same impedance as MD 214 N but is fitted with a 6 pin Tüchel connector for use with the Sennheiser Mikroport radio microphone.

MD 214 CM has the same impedance and is fitted with Cannon XLR male connector.

MD 214 CM same as above, but with Cannon XLR female connector.

* Technical Data page 72



The MD 214 during a broadcast for the Norddeutsche Rundfunk
Photo: H. E. Müller

Technical Data



Teldec-Star Manuela with the Lavalier microphone MD 214 N

Photo: Teldec

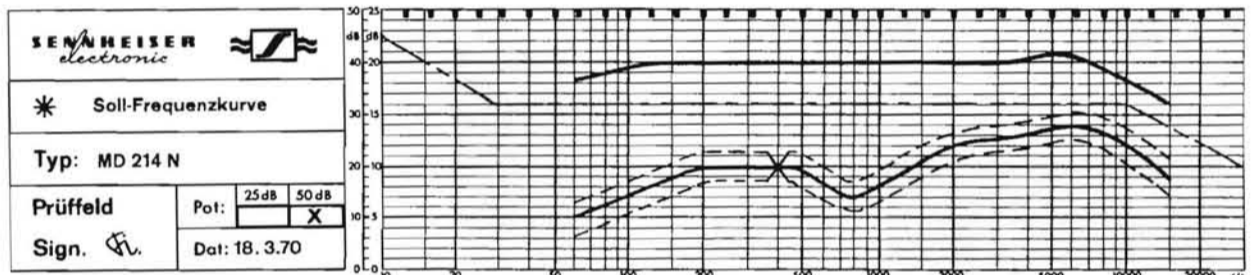

Upper curve: Frequency response used as a lavalier microphone
 Lower curve: Frequency response in a free soundfield on axis

Every MD 214 is supplied with an individually plotted frequency response curve.

MD 214 N

Acoustical mode of operation	Pressure sensitive transducer
Frequency range	60 to 15,000 Hz
Tolerance limits	± 2.5 dB from the special response curve (shown above)
Sensitivity at 1,000 Hz	0.10 mV/μbar ± 2.5 dB
Output level ref. 1 mW/10 dynes/cm ²	- 59 dbm
EIA rating	- 151.8 db
Impedance at 1,000 Hz	≥ 200 ohms
Directional characteristic	Omnidirectional
Connector	T 3260 or XLR
Pin connections	T 3260 = 1 + 3; signal, 2 & case: ground XLR = 2 + 3; signal, 1: ground
Cable connector	T 3261/1
Magnetic field sensitivity	8 μV/50 mG
Dimensions	75 x 28 x 28 mm
Weight	5 oz. without cable 11 oz. approx. with cable

We reserve the right to alter the specifications especially with regards to technical improvements.

Microphones for Musicians

The studio dynamic cardioid microphone type MD 421 as described on pages 14 and 15 has been used successfully by professional musicians for many years, both for live stage work and recording purposes.

The popularity of this microphone increased in stage application with the advent of the black and gold version MD 421 de luxe. As an all purpose music microphone the MD 421 series is excellent, however, it became obvious, particularly with the increasing demand on the beat scene for a good vocalist microphone, that Sennheiser electronic should produce such a unit. This in mind design laboratory developed the MD 409 N and the MD 415 N.

The MD 409 N dynamic microphone was designed for stand mounting to be used by instrumentalists who are unable to hold microphones, yet the properties of the microphone will allow the user to come within close proximity without distortion or exaggerating the bass response. The anti feedback properties built into the capsule allow the microphone to be used within a few feet of the loudspeaker without experiencing any "howl round". The MD 409 is fitted with a silent operating ON/OFF switch. The bass response in the MD 409 and MD 415 has been specially calibrated to avoid any bass overload when a vocalist is operating within a few inches of the diaphragm.

The MD 415 N has been especially designed for the vocalist. With all the acoustical features of the MD 409 N the MD 415 can be quickly released from a floor stand providing the MZA 415 microphone adaptor is used. An anti popping shield is built over the diaphragm for close work and the microphone case is turned in brass for ruggedness. Both the MD 415 and the MD 409 are finished in black and gold. The output of both microphones is balanced and wired to the N standard (page 12) and can be used with long cables.



MD 415 N

MD 409 N

Technical Data

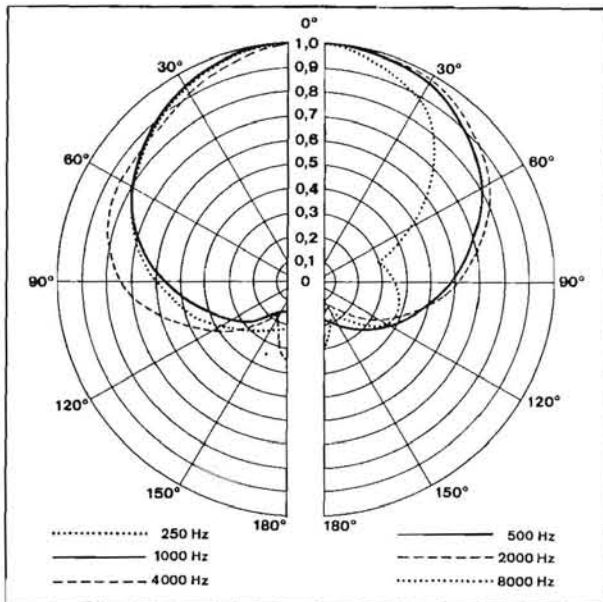

Polar diagram MD 409 N

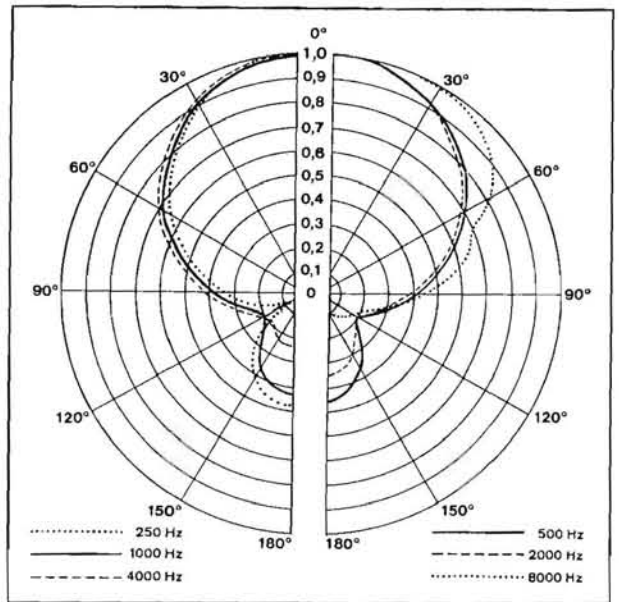

Polar diagram MD 415 N

MD 409 N

Acoustical mode of operation	Pressure gradient transducer
Frequency range	50 - 15,000 Hz
Directional characteristic	Super-cardioid
Attenuation at 145° at 1,000 Hz	≥ 14 dB
Sensitivity at 1,000 Hz	0.18 mV/μbar
Impedance at 1,000 Hz	200 ohms
Output socket	T 3260
Cable connector	T 3261/1
Pin connections	1 + 3: signal 2 + case: ground
Dimensions	55 mm x 35 mm x 195 mm
Weight	12 oz.

MD 415 N

Acoustical mode of operation	Pressure gradient transducer
Frequency range	60 - 15,000 Hz
Directional characteristic	Super-cardioid
Attenuation at 1,000 Hz	≥ 18 dB
Sensitivity at 1,000 Hz	0.12 mV/μbar ± 3 dB
Impedance at 1,000 Hz	300 ohms
Output socket	T 3260
Cable connector	T 3261/1
Pin connections	1 + 3: signal 2 + case: ground
Dimensions	35 mm Φ, 140 mm length
Weight	11 oz.

We reserve the right to alter the specifications especially with regards to technical improvements.

Noise Cancelling Microphone MD 4-2 and Anti-Feedback Microphone MD 420-2

Close talking microphones are necessary in many situations today — railway stations, noisy factories, sport stadiums, airport concourses, touring coaches, etc. A close talking microphone operates by having both sides of its diaphragm exposed to the sound waves. It is therefore insensitive to distant sounds, since their sound waves reach both sides of the diaphragm simultaneously and largely cancel out. In use the microphone is held close to the speaker's mouth, so that more sound energy reaches the front of the diaphragm than the rear. Cancellation of the wanted sound is therefore avoided.

The MD 4 is a close talking microphone, designed to be held to one side of the mouth. The fidelity of response at high frequencies — vital for clarity in public address systems — is ensured by the acoustic duct in front of the diaphragm. Since this microphone has a figure eight response to distant sounds, it can be rotated to reduce further interference with a particularly disturbing noise. The MD 4-2T is an alternative version with a built-in on-off switch. The MD 420 is also a close talking microphone designed to be used in front of the mouth, but does not require to be quite as close to the mouth as the MD 4. The principle of operation is similar, but the MD 420 is designed to have a super-cardioid characteristic. Since it is used further from the mouth, a more natural voice reproduction is achieved.

The natural sound quality and the outstanding anti feedback features of the MD 420 are ideal advantages to use this microphone with beat groups and on stage for public address.

Both microphones are available without switch as model numbers MD 4-2 and MD 420-2. If the microphones are equipped with switch a T is added to the type number. A shorter version MD 420-9 is also available for mounting on a gooseneck.

All models are wired according to diagram -2 (see page 13).



Noise Cancelling Microphone MD 4-2



Anti-Feedback Microphone MD 420-2

Technical Data

	MD 4-2 MD 4-2T	MD 420-2 MD 420-2T
Acoustical mode of operation	Pressure gradient transducer	Pressure gradient transducer
Frequency range	50 - 10,000 Hz	200 - 10,000 Hz
Frequency response	Special for close speaking	Special for close speaking
Sensitivity at 1,000 Hz	0.16 mV/ μ bar approx.	0.18 mV/ μ bar approx.
Output level ref. 1 mW/10 dynes/cm ²	- 55 dbm	- 54 dbm
EIA rating	- 147.5 db	- 146.5 db
Impedance at 1,000 Hz	200 Ω	200 Ω
Directional characteristic	Figure of 8 cardioid at high frequencies	Super cardioid
Attenuation at 1,000 Hz	at 90° \approx 20 dB	at 120° \approx 18 dB - 3 dB
Switch	on type MD 4-2T	on type MD 420-2T
Output socket	T 3079/2	T 3079/2
Pin connections	1 + 2: signal 3 + case: ground	1 + 2: signal 3 + case: ground
Cable connector	T 3080/2	T 3080/2
Dimensions	Head 60 mm ϕ Length 180 mm	35 mm ϕ 130 mm
Weight	13 oz.	4 oz.

We reserve the right to alter the specifications especially with regards to technical improvements



MD 420-9

Probe Measuring Microphone MD 321 N

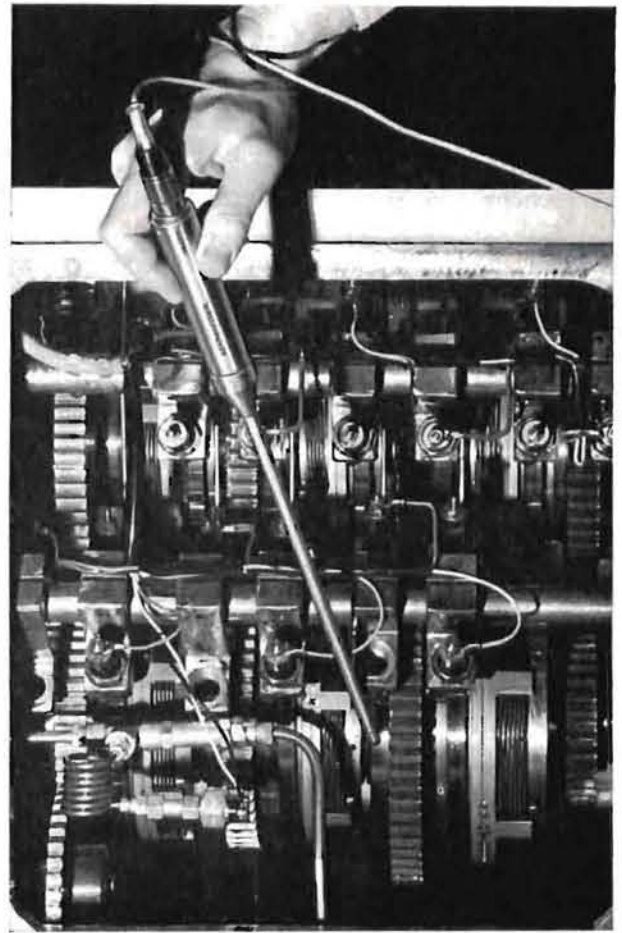

This new probe microphone is designed primarily for industrial acoustic measurements. As the curves testify it has an unusually smooth frequency response. The dotted lines on the frequency response curve show the limits of production tolerance of plus or minus 2.5 dB.

The MD 321 N is intended for use in trouble shooting and noise suppression of machinery since the probe can be inserted into inaccessible corners to pick up, e. g., the sound of a defective bearing or a noisy gear wheel.

For acoustic measurements the small size of the probe permits measurements to be made without disturbance of the sound field.

The probe tube is detachable and can be replaced easily and quickly in case of accident or damage. An important feature is that this probe has especially been designed to be used in high temperature environments e. g. for measurements of sound levels in hot exhaust gases.

The MD 321 N is wired according to diagram N on page 12. Balanced output.

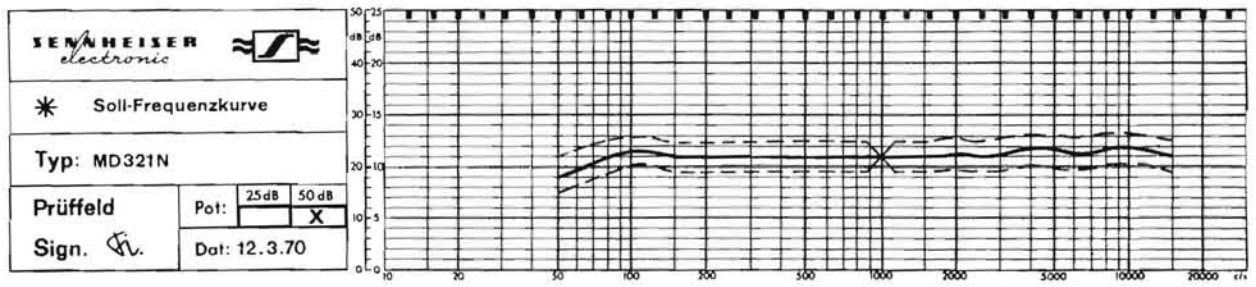

Nominal frequency response curve (with tolerance limits) MD 321 N

Every MD 321 N is supplied with an individually plotted frequency response curve.

Technical Data

MD 321 N

Acoustical mode of operation	Pressure sensitive transducer
Frequency range	50 - 15,000 Hz
Tolerance limits	See above graph
Sensitivity at 1,000 Hz	0.045 mV/ μ bar \pm 3 dB
Output level ref. 1 mW/10 dynes/cm ²	- 66 dbm
EIA rating	- 158.7 db
Max. sound level for 3% distortion at 400 Hz	3 mbar
Impedance	200 Ω
Directional characteristic	Omnidirectional
Output connector	T 3260
Pin connections	1 + 3: signal 2 + case: ground
Cable connector	T 3261/1
Magnetic field sensitivity	23 μ V/50 mG
Dimensions	25 mm \varnothing , 440 mm length, Tube 8 mm \varnothing
Weight	10 oz.

We reserve the right to alter the specifications especially with regards to technical improvements

Product Group 2

Transistorized Condenser Microphones

It is a well-known fact that condenser microphones can cope with the most difficult problems in recording mainly because the moving part of a condenser microphone consists of only a feather-light membrane.

In conjunction with the small dimensions of the elements, exceptionally good electro-acoustical characteristics can be achieved.

So far condenser microphones were known to be not as rugged as dynamic microphones. Therefore they were often only used in studios or similar localities. Today there are no objections to using condenser microphones outdoors. Especially the condenser microphones made by Sennheiser are famous for their durability when used under various climatic conditions.

The Radio Frequency System

Throughout the range of Sennheiser condenser microphones the capacitive transducing element is part of a radio frequency circuit. This means that unlike conventional condenser microphones, the capsule operates at a low impedance. There is no high polarizing voltage on the diaphragm and, in consequence, the microphone is less sensitive to physical shock, humidity and changes of temperature.

The capsule is not required to operate with the diaphragm in a critical balance between maximum capacity and high voltage arc-over. The extremely low noise level of the Sennheiser microphones is obtained by the use of a crystal controlled radio frequency oscillator. The high "Q" of the crystal oscillator reduces the random radio frequency noise. The noise output of the microphone approaches the theoretical noise limit. This fact can be substantiated by measuring the noise output in free air and then placing the microphone in a vacuum; the low noise level in free air will be reduced even further in a vacuum, due to the fact that the microphone noise is mainly caused by the random motion of the air molecules rather than by the microphone circuit itself. The high signal output of the Sennheiser condenser microphones means that the signal to noise ratio of the microphone amplifier is of little importance and for this reason even a poor quality microphone amplifier will appear to have a good signal to noise ratio when used with a Sennheiser microphone.

Connection

The requirements for the voltage matching system employed demand a low impedance of the source compared to the load represented by the amplifier input. The impedance characteristic versus the frequency of the amplifier input as well as of the microphone thus do not influence the frequency response. The source impedance of the Sennheiser condenser microphones is only approximately 20 ohms and the amplifier input impedance can have any value as long as it is at least 200 ohms.

Sennheiser condenser microphones generate high audio voltages, approximately 25 dB above that of dynamic microphones. Accordingly, even very long connection cables may be used without the danger of noise pickup. Before entering the amplifier, the level may have to be attenuated in order to avoid overmodulation of the first stage.

Power Supplies

Sennheiser electronic introduced the audio wire powering system, sometimes called A-B powering. This has become a German engineering standard DIN 45 595 and is being used by the German Federal Radio and TV Networks. The dc current for the condenser microphone goes through the audio conductors, and regular microphone cables as for dynamic microphones (2 conductors plus shield) can be used. Compared to another recent powering system, the phantom circuit, our A-B powering is isolated from ground and cable shield. Interference voltages on the cable shield will not be introduced into the microphone circuit.

The simplest power supply is the battery adapter MZA 6-2 which can be inserted into the cable. Nine mercury cells HG 625 allow a continuous operation up to 60 hours.

For fixed installations, a dual ac line connected power supply Model MZN 5-1 is available.

The microphones may also be powered directly from the amplifier, as it is done for instance in the Sennheiser mixer M 101, the Nagra IV tape recorder by Kudelski (with QPM-3-5) or the SP 7 tape recorder by Stellavox.

Unbalanced microphone inputs can also be accommodated as shown in the sketch. The diagram below shows the output and overload level versus the supply dc voltage.

In larger studio installations, a central dc-power supply may be advantageous. For each microphone channel, a switch is provided to disconnect the dc if dynamic microphones shall be used. There is no danger of damaging a dynamic microphone should

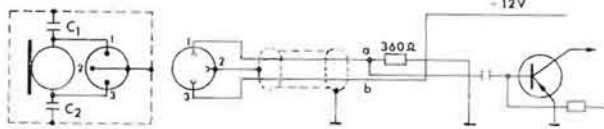
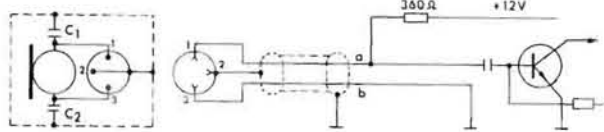

A-B powering system for unbalanced inputs

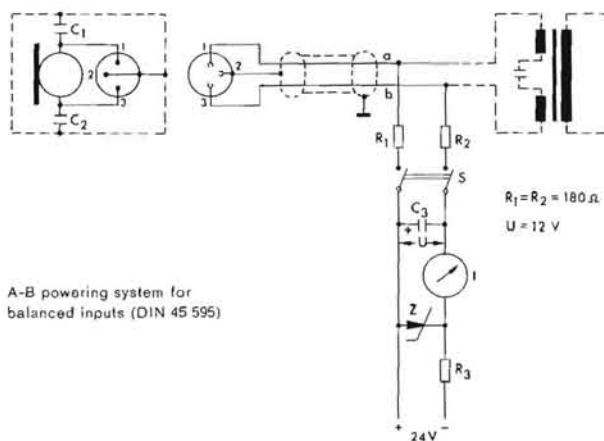
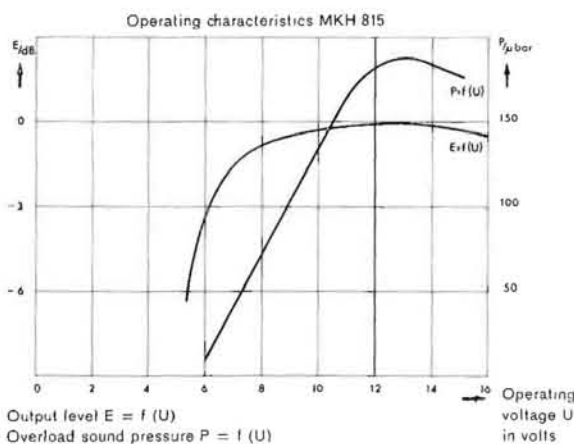

A-B powering system for balanced inputs (DIN 45 595)

it be forgotten to switch off the dc. Small meters can be inserted into the circuit to indicate as to whether the circuit is closed and the correct microphone has been connected.

Another possibility is to install separate lines for dynamic and condenser microphones with transfer switches at the console.

Insensitivity to Interference

Since the condenser microphones have a high output level, typically 20 dB higher than a dynamic microphone, the cable is less susceptible to pick-up and interference. The microphone itself has a highly efficient radio frequency filter which has the secondary advantage that it provides a short circuit to radio frequency signals that might be picked up in a long microphone cable. The full range of RF condenser microphones are now fitted with silicon transistors for maximum long term reliability.

Transistorized Condenser Microphone MKH 105

The model MKH 105 is a pressure operated condenser microphone with omnidirectional characteristics. The microphone diaphragm is a gold plated hostaphan membrane. As shown below, the frequency response extends from 20 to 20,000 Hz and is free from peaks and dips.

The MKH 105 is remarkably insensitive to handling noise and is therefore suitable both for studio use and for location work where the highest possible quality is required. By virtue of the omnidirectional characteristic the MKH 105 has the lowest sensitivity to wind noise of all types of microphone.



Shmuel Rodensky is being interviewed with a MKH 105

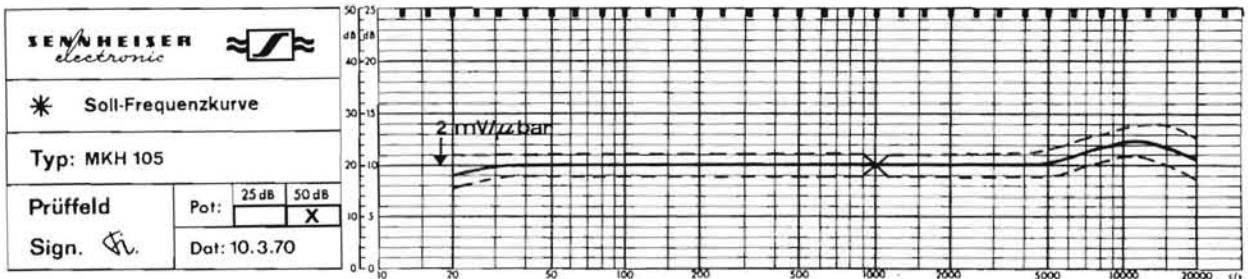

Nominal frequency response curve (with tolerance limits) MKH 105
Every MKH 105 is supplied with an individually plotted frequency response curve.

Technical Data

MKH 105



Acoustic mode of operation	Pressure receiver
Directional characteristic	Omnidirectional
Frequency range	20 to 20,000 Hz
Output level ref. 1 mW/10 dynes/cm ²	- 27 dbm
EIA Rating	- 121.5 db
Impedance	Approx. 10 ohms balanced, ungrounded 200 ohms
Minimum matching load	Approx. 7 μvolts
Weighted noise voltage (DIN 45 405)	Approx. 19 dB
Equivalent noise level	Approx. 25 dB
DIN 5045-A-Filter	≤ 5 %
DIN 45 405	10 volts ± 1 volt
Total harmonic distortion at 100 μbar	Approx. 5 ma
Power supply voltage	- 10 to + 70 ° C (14 ° to 158 ° F)
Operating current	1/4 in. diameter, 5 in. long
Temperature range	3.2 oz.
Dimensions	Tuchel T 3262
Weight	audio, + 10 volts
Connector	audio, + 10 volts
Contact 1	audio, - 10 volts
Contact 2	shield
Contact 3	
Plug shell	

We reserve the right to alter the specifications especially with regards to technical improvements.

Transistorized Condenser Microphones

MKH 110 and MKH 110-1



Both microphones are specially designed for instrumentation purposes. Since the principle of operation of the Sennheiser condenser microphones allows the frequency response to extend down to zero Hz, the low frequency limit of response is set by the capsule design. In the MKH 110 the response extends down to one Hz and in the MKH 110-1 the response extends to 0.1 Hz. The other difference between the two microphone types relates to their sensitivity. The MKH 110 has a higher sensitivity, nominally 2 mV/μbar, whereas the MKH 110-1 has a relatively low sensitivity of 0.2 mV/μbar. The difference in sensitivity implies a similar difference in overload level. The MKH 110 will respond to a maximum level of 200 μbar, while the MKH 110-1 will give an undistorted response to sound levels as far as 5000 μbar.

Both microphones are intended for military and research purposes and have been designed to

operate over an extremely wide temperature range. Silicon transistors are used throughout, and the capsule itself has been especially designed for operation under extreme temperatures.

In order that the frequency response not be limited by the small value of the coupling capacitor in the output circuit, the audio output on pin 1 of the microphone is connected directly to the output amplifier without a blocking capacitor. There is, therefore, a DC voltage of approximately 3 volts on this pin and a blocking capacitor must be fitted in the microphone amplifier.

Unlike the studio microphones the MKH 110 and 110-1 operate with a positive battery supply with respect to ground. See the diagram below.

$$C = \frac{2}{\omega (r + 90 \Omega)}$$

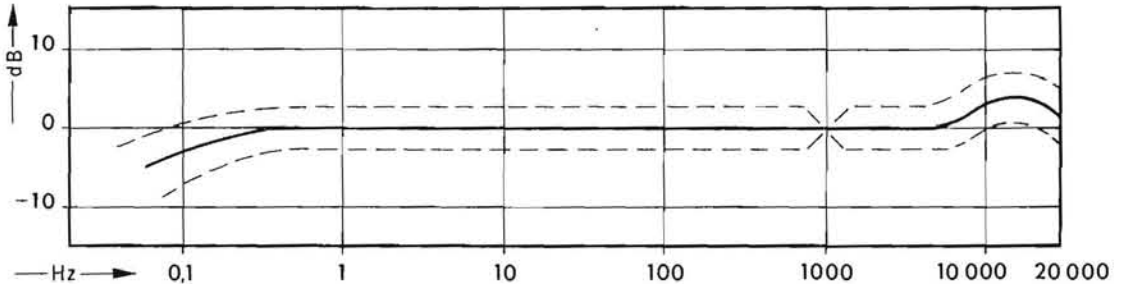

Nominal frequency response curve (with tolerance limits) MKH 110-1

Every MKH 110 is supplied with an individually plotted frequency response curve.

Technical Data

	MKH 110	MKH 110-1
Acoustical mode of operation	Pressure transducer	Pressure transducer
Directional characteristic	Omnidirectional	Omnidirectional
Frequency range	1.0 to 20,000 Hz	0.1 to 20,000 Hz
Sensitivity	2 mV/μbar ± 2 dB	0.2 mV/μbar ± 3 dB
Output impedance	Approx. 90 Ω	Approx. 90 Ω
Minimum load impedance required	Approx. 2000 Ω	Approx. 2000 Ω
Equivalent noise voltage (DIN 45405)	31 ± 3 dB	47 ± 3 dB
Signal to noise ratio ref. 1 N/m ²	63 dB	47 dB
Maximum sound level	200 μbar	5000 μbar
Supply voltage	8 V ± 1 V	8 V ± 1 V
Current consumption	Approx. 8 mA	Approx. 8 mA
Temperature range	-35 °C to +70 °C	-35 °C to +70 °C
Dimensions	20 mm φ x 126 mm	20 mm φ x 126 mm
Weight	Approx. 90 g	Approx. 90 g
Output plug	Tuchel T 3262	Tuchel T 3262
Connections	1... AF (+3 V) 2... 0 3... +8 V	1... AF (+3 V) 2... 0 3... +8 V

We reserve the right to alter the specifications especially with regards to technical improvements.

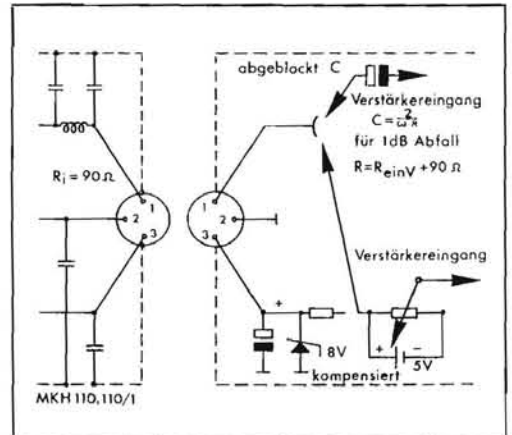

Condenser Lavalier Microphones MKH 124 and MKH 125



The continuing demand for a small high quality Lavalier microphone prompted Sennheiser electronic to design the MKH 124 and MKH 125. These microphones are an extension of the Sennheiser studio condenser microphone line. The electronic circuitry is basically similar, but in order to achieve the extremely small size of the complete microphone the membrane diameter is only 6 millimeters.

The smooth, resonance-free response of a condenser microphone provides a clear and natural sound which cannot be obtained with other microphones. The omnidirectional characteristics of the microphone make it largely insensitive to handling and rubbing noises. The frequency response rises smoothly and slowly above 1,000 Hz to compensate for the loss of the higher frequencies caused by the position of the microphone; for the same reason the low frequencies are attenuated. The complete microphone consists of two parts, the miniature microphone which can be fastened to clothes by a clip and the electronic unit which contains the radio frequency transistor system which can be connected directly to a wireless microphone transmitter and kept in the coat pocket.

The microphone part MK 12 is identical for the MKH 124 and MKH 125 microphone and can be purchased separately to be connected directly to the wireless transmitter SK 1007 which contains the radio frequency system for the condenser microphone. The MKH 124 is a complete microphone system with an unbalanced output which may be connected directly to other wireless microphone transmitters, e. g. the SK 1005 and the SK 1008. The MKH 125 which comprises the microphone part MK 12 and the electronic unit MH 125 has a balanced output with power supply requirements similar to the other Sennheiser series of "05" condenser microphones. The microphone is supplied with 5 meters of cable between the microphone and the electronic unit. The cable may be extended to a maximum of 20 meters without impairing the performance.



An MC uses the MK 12 as a wireless microphone

Technical Data

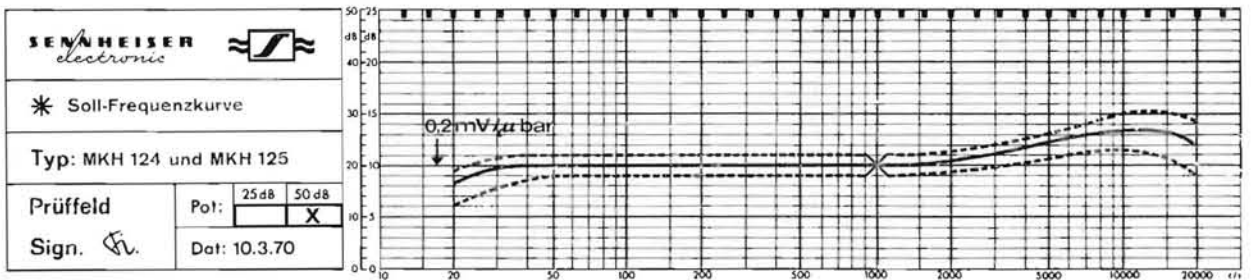
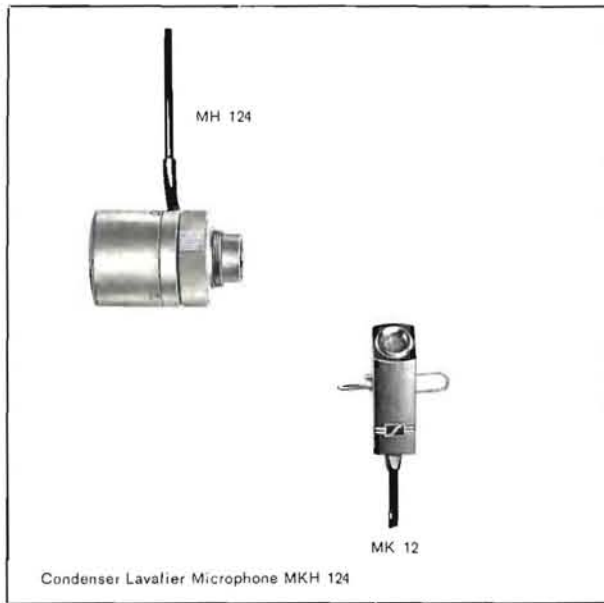

Nominal frequency response curve (with tolerance limits) MKH 124 and MKH 125
 Every MKH 124 and MKH 125 is supplied with an individually plotted frequency response curve

	MKH 124	MKH 125
Frequency range	20 to 20,000 Hz	20 to 20,000 Hz
Sensitivity	Approx. 0.32 mV/μbar	Approx. 2 mV/μbar
EIA rating	- 131.5 db	- 121.5 db
Impedance	Approx. 150 Ω	Approx. 10 Ω
Minimum matching load	Approx. 200 Ω	Approx. 200 Ω
Equivalent noise voltage (DIN 45 405)	Approx. 32 dB	Approx. 32 dB
Signal to noise ratio ref. 1 N/m ²	59 dB	59 dB
Supply voltage	8 V ± 1 V	10 V ± 1 V
Current consumption	Approx. 5 mA	Approx. 6 mA
Temperature range	- 10 to + 70 °C	- 10 to + 70 °C
Dimensions		
Microphone section	11.5 x 36 x 12 mm	11.5 x 36 x 12 mm
Electronic section	27 mm Ø, 41 mm long	19 mm Ø, 128 mm long
Weight of microphone	Approx. 3.2 oz.	Approx. 3.2 oz.
Output plugs		
Microphone to electronic section	Lemo F 00250/AG/3 and Lemo RC 00250/AG/3	Lemo F 00250/AG/3 and Lemo RA 00250
Electronic section to amplifier	Tuchel T 3400/1	Tuchel T 3262
Connections		
Microphone section	1 pole Lemo RF plug	1 pole Lemo RF plug
Electronic section	4 ... AF	1 ... AF, + 10 V
	1, 2, 5, ... 0	2 case
	3 ... - 8 V	3 ... AF, - 10 V

We reserve the right to alter the specifications especially with regards to technical improvements.

Transistor Condenser Microphone MKH 405



The condenser microphone MKH 405 is a pressure gradient transducer with a cardioid characteristic. The directionality is accurately maintained over the full frequency range which makes this microphone

particularly suitable for stereo recording, film and television use. The frequency response is extremely smooth and free from resonances between 40 and 20,000 Hz as shown on the response curve opposite.



Christian Müller during a broadcast for the NDR

Photo: H. E. Müller



Technical Data

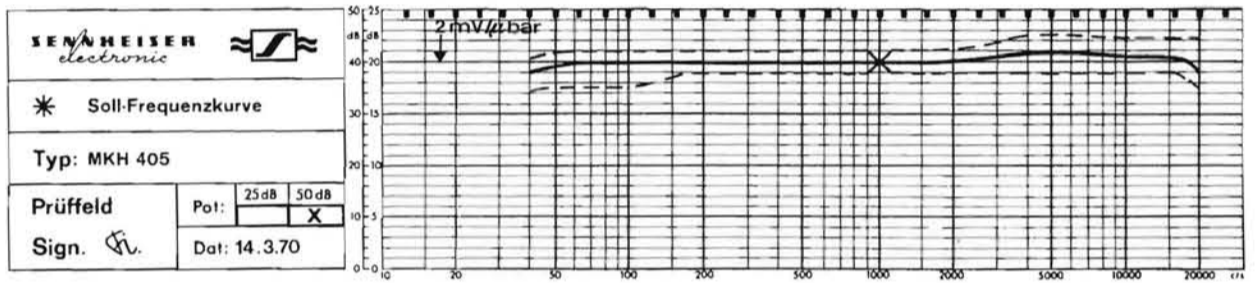
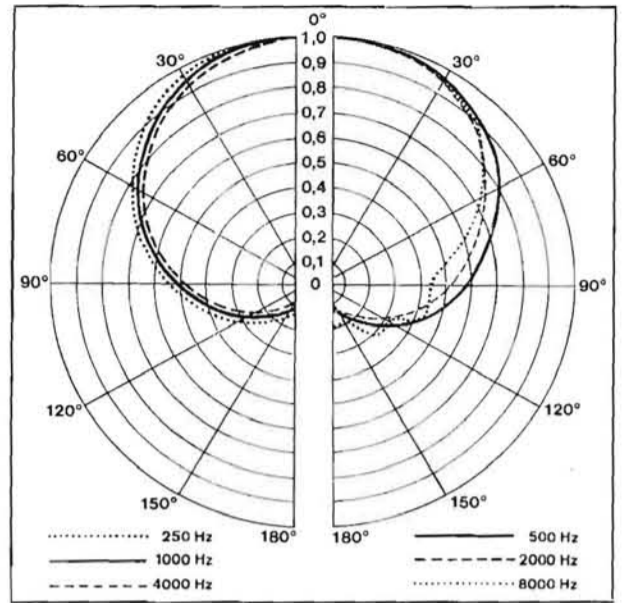

Frequency response (with tolerance limits) MKH 405
Every MKH 405 is supplied with its individually plotted frequency response curve.

MKH 405

Acoustic mode of operation	pressure gradient receiver
Directional characteristic	cardioid
Frequency range	40 to 20,000 Hz
Output level ref. 1 mW/10 dynes/cm ²	- 27 dbm
EIA Rating	- 121.5 dB
Impedance	approx. 10 ohms
Minimum matching load	200 ohms
Weighted noise voltage (DIN 45 405)	approx. 7 μvolts
Equivalent noise level	
DIN 5045-A-Filter	approx. 19 dB
DIN 45 405	approx. 25 dB
Total harmonic distortion at 100 μbar	≤ 5 %
Power supply voltage	10 volts ± 1 volt
Operating current	approx. 5 ma
Temperature range	- 10 ° to + 70 ° C (14 ° to 158 ° F)
Dimensions	1/4 inch diameter, 5 7/16 inch long
Weight	3.5 oz.
Connector	Tuchel T 3262
Contact 1	audio, + 10 volts
Contact 2	shield
Contact 3	audio, - 10 volts
Plug shell	shield

We reserve the right to alter the specifications especially with regards to technical improvements.

Transistorized Condenser Microphone MKH 415

The condenser microphone MKH 415 is a modern combination of a pressure gradient receiver microphone and an interference microphone.

The directional pattern is a cardioid one at low and medium frequencies. At a frequency of more than 2000 Hz the pattern is club-shaped. The advantage of the MKH 415 over the MKH 405 is — due to a considerably higher acoustical membrane pressure — its greatly reduced sensitivity to wind and pop effects as well as breathing sound and rustle of clothing.

Furthermore, the close-talking effects of the microphone are relatively small. This microphone is therefore particularly suited for use by soloists, and its unusual length of 10 " makes it also very desirable for reporters.

The MKH 415 can generally be used without a windscreen or a shockmount. For outside recordings the windscreen MZW 415 is recommended and for recordings affected by mechanical vibrations the shockmount MZS 415 is suggested.



Technical Data

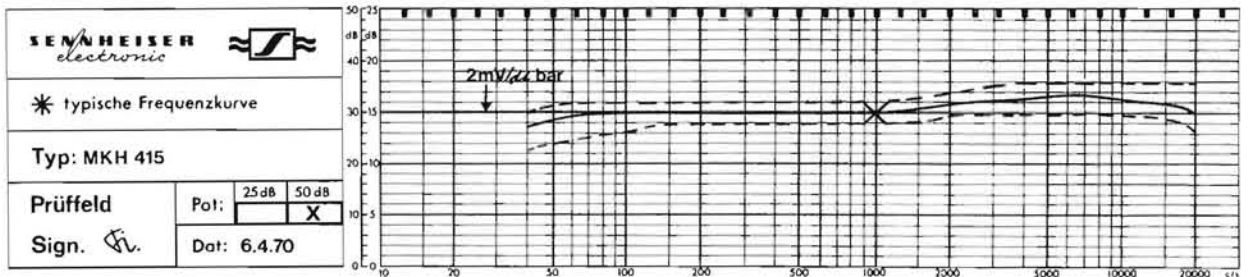
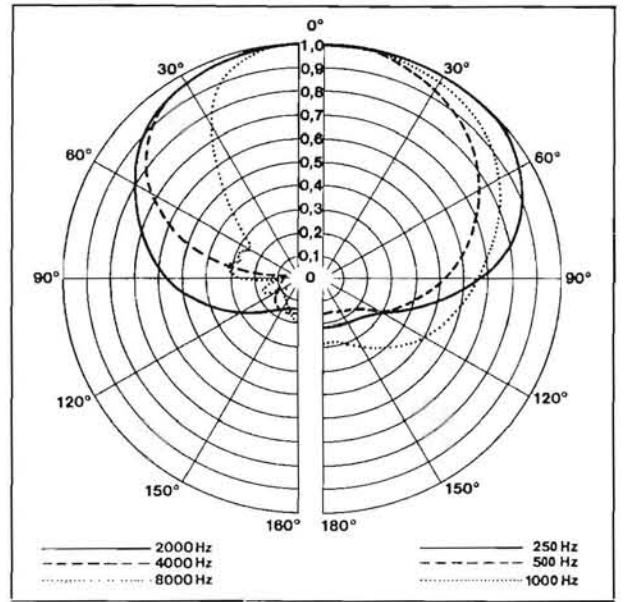

Frequency response (with tolerance limits) MKH 415
Every MKH 415 is supplied with its individually plotted frequency response curve.

MKH 415

<p>Acoustic mode of operation</p> <p>Directional characteristic</p> <p>Frequency range</p> <p>Output level ref. 1 mW/10 dynes/cm²</p> <p>EIA Rating</p> <p>Impedance</p> <p>Overload sound pressure</p> <p>Minimum matching load</p> <p>Signal to noise ratio</p> <p>Power supply voltage</p> <p>Operating current</p> <p>Temperature range</p> <p>Dimensions</p> <p>Weight</p> <p>Connector</p> <p>Contact 1</p> <p>Contact 2</p> <p>Contact 3</p>	<p>gradient interference receiver</p> <p>cardioid-narrow beam</p> <p>40 to 20,000 Hz</p> <p>- 21 dbm</p> <p>- 121.5 dB</p> <p>approx. 20 ohms</p> <p>balanced</p> <p>ungrounded</p> <p>300 μbar</p> <p>200 ohms</p> <p>71 dB</p> <p>12 volts ± 2 volts</p> <p>approx. 6 ma</p> <p>- 10 ° to + 70 ° C (14 ° to 158 ° F)</p> <p>3/4 inch diameter, 10 inch long</p> <p>6.1 oz.</p> <p>XLR</p> <p>shield</p> <p>audio, + 12 volts</p> <p>audio, - 12 volts</p>
---	---

We reserve the right to alter the specifications especially with regards to technical improvements.

Transistorized Condenser Microphone MKH 815



The MKH 815 is a condenser microphone with excellent directional properties; it is the successor to the well-known MKH 805. Even at a large distance the microphone can be used without any loss of sound quality. A very smooth directional frequency response is being achieved through a special combination of the interference principle and the pressure gradient principle. To be used in television and film studios whenever the microphone has to be out of

the camera range. In spite of its unusual length the MKH 815 is, due to special measures, relatively insensitive to wind and pop effects. However, when the microphone is being turned quickly or when used outside, it is advisable to use the windscreens MZW 804. Especially good is the signal-to-noise ratio. With this microphone the most difficult sound recordings can often be made with outstanding quality of sound.



Technical Data

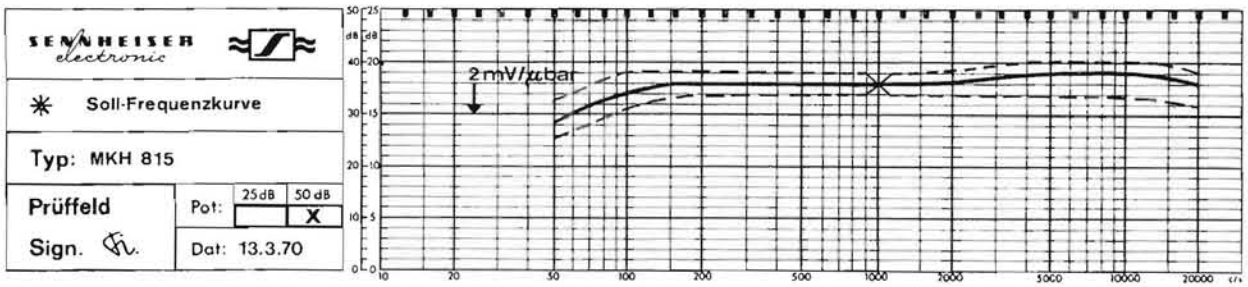
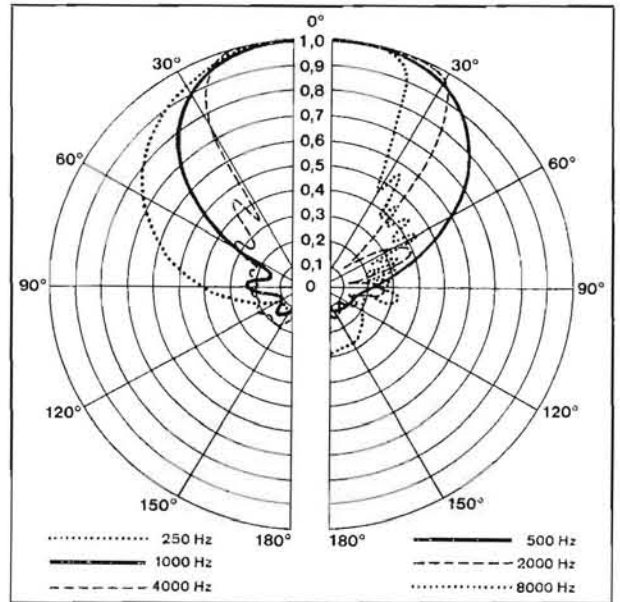

Frequency response (with tolerance limits) MKH 815
 Every MKH 815 is supplied with its individually plotted frequency response curve.

Sennheiser electronic		MKH 815	
* Soll-Frequenzkurve			
Typ: MKH 815			
Prüffeld	Pot:	25 dB	50 dB
	Sign.		X
		Dat: 13.3.70	

MKH 815	
Acoustic mode of operation	interference receiver
Directional characteristic	narrow beam
Frequency range	50 to 20,000 Hz
Output level ref. 1 mW/10 dynes/cm ²	- 21 dbm
EIA Rating	- 115.4 dB
Impedance	approx. 10 ohms, balanced, ungrounded
Overload sound pressure	150 μbar
Minimum matching load	200 ohms
Equivalent noise level (DIN 45 405)	approx. 20 dB
Total harmonic distortion at 50 μbar	≤ 5 %
Power supply voltage	12 volts ± 2 volts
Operating current	approx. 5 ma
Temperature range	- 10 ° to + 70 ° C (14 ° to 158 ° F)
Dimensions	3/4 inch diameter, 22 inch long
Weight	14 oz.
Connector	Tuchel T 3262
Contact 1	shield
Contact 2	audio, + dc
Contact 3	audio, - dc
Plug shell	shield

We reserve the right to alter the specifications especially with regards to technical improvements.

Microphone Accessories

The microphones are shown vertically and the accessories horizontally. Those marked ● can be connected directly or by means of a screw thread. Those marked ▲ indicate indirect connection e. g. by means of flexible shafts.

	Windshields								Desk Stands						Mounting Flange	Table Clamp	Flexible Shafts			Floor Stands			Adapter Bar
	MZW 22	MZW 30	MZW 201	MZW 411	MZW 415	MZW 421	MZW 804	MZW 815	MZT 12	MZT 21	MZT 104	MZT 105	MZT 415	MZT 421	MZT 141	MZT 237	MZH 141	MZH 142	MZH 21	MZS 142	MZS 144	MZS 210	MZS 235
Dynamic Microphones	MD 4-2														▲	▲	●			▲	▲	▲	▲
	MD 4-2T														▲	▲	●			▲	▲	▲	▲
	MD 21 HL	●								●						●			●	●	●	●	●
	MD 21 N	●								●						●			●	●	●	●	●
	MD 21-2	●							●						▲	●	●		●	●	●	●	●
	MD 211 N		●	●							●	●				▲		●		▲	▲	▲	▲
	MD 214 N																						
	MD 321 N																▲			▲	▲	▲	▲
	MD 402 LM		●																				
	MD 408 N													●			●			●	●	●	●
	MD 409 N																●		●	●	●	●	●
	MD 411 HLM				●												●		●	●	●	●	●
	MD 415 N		●														●		●	●	●	●	●
	MD 420-2		●							●						▲	▲	●		▲	▲	▲	▲
	MD 420-2T		●							●						▲	▲	●		▲	▲	▲	▲
	MD 420-9		●																				
	MD 421 HL	●									●					●			●	●	●	●	●
	MD 421 N	●									●					●			●	●	●	●	●
MD 421-2	●									●					●	▲	●	●	●	●	●	●	
Transistorized Condenser Microphones	MKH 105		●	●							●	●	●		▲	▲		●		▲	▲	▲	▲
	MKH 110		●	●							●	●	●		▲	▲		●		▲	▲	▲	▲
	MKH 110-1		●	●							●	●	●		▲	▲		●		▲	▲	▲	▲
	MKH 124																						
	MKH 125																						
	MKH 405		●	●							●	●	●		▲	▲		●		▲	▲	▲	▲
	MKH 415					●							●										
	MKH 815										●	●									▲	▲	▲
Radio Microphones	SK 1008					●						▲			▲					▲	▲	▲	▲

The accessories shown on the following pages marked  are suitable for dynamic microphones.

Floor Stands				Adapter Bar	Shockmounts	Boom Arm	Cables	Cable Preamplifiers		Roll-off Filter	Battery Packs	Mains Units			Cable Transformers				Explanation for marking ▲														
MZS 142	MZS 144	MZS 210	MZS 235	MZS 105	MZS 805	SZS 1008	MZS 211	DAV 5	DA 1 HL	DA 7 N	DA 7 NL	DA 7 NM	DV 7 HL	DV 7 M	DV 7 N	KA 1	KA 7	MZK 12	MZV 125	KAT 15	KAT 25	MZF 5	MZA 6-2	MZN 4-4	MZN 5-1	TB 501	TM 514 N	TM 514 HL	TM 513	TS 514 M			
▲	▲	▲	▲				▲	●																			●	▲	▲				
▲	▲	▲	▲					●					●						▲								●	▲	▲				
●	●	●	●				●	●	●	●	●	●			●				▲								▲	●	▲	▲			
●	●	●	●				●	●	●	●	●	●							▲								●	▲	▲				
▲	▲	▲	▲				▲	●	●	●	●	●			●				▲								▲	●	▲	▲			
				▲				●	●	●	●	●			●				▲								▲	●	▲	▲			
								●	●	●	●	●							▲								▲	●	▲	▲			
●	●	●	●				●	●	●	●	●	●			●				▲								▲	●	▲	▲			
●	●	●	●				●	●	●	●	●	●			●				▲								▲	●	▲	▲			
●	●	●	●				●	●	●	●	●	●			●				▲								▲	●	▲	▲			
▲	▲	▲	▲				▲	●																			●	▲	▲	▲			
▲	▲	▲	▲				▲	●											▲								●	▲	▲	▲			
								●	●																			▲	●	▲	▲		
								●	●																			▲	●	▲	▲		
▲	▲	▲	▲				▲																					●	▲	▲	▲		
▲	▲	▲	▲				▲	●																				●	▲	▲	▲		

▲ Indicates connection by means of flexible shaft etc.

▲ Indicates connection by means of flexible shaft etc.

The accessories shown on the following pages marked  are suitable for condenser microphones.



Windshield MZW 22

The MZW 22 is designed to fit the MD 21 and MD 421 series of microphones. The diameter of the glass fibre and polyester screen is 80 mm.



Windscreen MZW 30

Oval foam windscreen for transistorized condenser microphones MKH 105, MKH 110, MKH 405 and for dynamic microphones MD 211 N, MD 402 LM, MD 415 N, MD 420-2, MD 420-2T and MD 420-9. Maximum diameter of the smallest side $\pm 2\frac{1}{2}$ ".



Windshield MZW 421

An alternative windshield for the MD 21 and MD 421 series of microphones. The flexible windshield is made from open cell sponge. Diameter 80 mm.



Windscreen MZW 415

This foam windscreen is especially designed for the transistorized condenser microphone MKH 415. Maximum diameter of the smallest side 2", length ± 8 ".



Windshield MZW 411

Sponge windshield MZW 411 fits the super cardioid microphone MD 411 HLM. It is recommended for all close speaking and outdoor applications. Diameter 80 mm.



Windshield MZW 201

Sponge windshield MZW 201 fits the condenser microphones MKH 105, MKH 405 and the studio dynamic microphone MD 211. Diameter 80 mm.



Windshield MZW 804

The windshield MZW 804 is designed for the MKH 805 directional microphone and is used in conjunction with the MZS 805 boom suspension or the MZP 804 pistol grip. Length 670 mm, diameter 80 mm.



Desk Stand MZT 12

This stand is fitted with a large Tuchel socket T 3005. It accepts dynamic microphones MD 21-2, MD 420-2, MD 420-2T. Dimensions 168 x 100 x 70 mm.



Desk Stand MZT 421

A heavy diecast metal stand for the MD 421 series of studio microphones. The swan neck microphone MD 408 and other swan neck adaptors may be attached to this stand by using the MZA 421 adaptor. Dimensions of the stand 127 x 112 x 22 mm.



Desk Stand MZT 21

A diecast metal stand for the studio microphone MD 21 N and MD 21 HL. Dimensions 102 x 64 x 25 mm.



Desk Stand MZT 105

A stable and unobtrusive stand for Studio use. It will accept the MKH 105, MKH 405 and MD 211 N.



Desk Stand MZT 415

A stable and solid stand for studio use. The microphone connector can be plugged into the mount. To be used with the following microphones: MKH 415, MKH 105, MKH 110, MKH 405 and MD 211 N.



Desk Stand MZT 104

A lightweight plastic stand. The swivel clip may be detached and mounted on all floor stands having a 3/8" thread. For use with microphones MKH 105, MKH 405 and MD 211 N.



Screw on Socket MZT 141

This socket fits the swan neck MZH 141. The socket is intended to be screwed to the floor or to a desk for a permanent installation.



Table Clamp MZT 237

The clamp has a 3/8" thread for use with swan neck extensions or the two-microphone adaptor bar MZS 235.

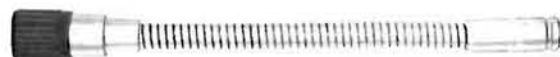

12" Swan Neck MZH 141

The MZH 141 can be attached to our floor stands MZS 144, MZS 142 and MZS 210 or any other stand fitted with a 3/8" thread. For permanent installations use in conjunction with screw on adaptor MZT 141. Fitted with Tuchel socket T 3005 for microphones MD 21-2, MD 4-2, MD 4-2T, MD 420-2, MD 420-2T, MD 421-2.



8" Swan Neck MZH 142

A swan neck complete with 2 metres of microphone cable and fitted with a miniature Tuchel socket T 3261/1. The cable is terminated with a standard DIN 3-pin connector. The MZH 142 can be fitted to all floor stands having a 3/8" thread, and will accept lightweight microphones such as the MD 211.



8" Swan Neck MZH 21

This swan neck is fitted with a 3/8" male and female thread, and may be used with all microphones and stands having a 3/8" thread.



Lightweight Floor Stand MZS 142

A telescopic collapsible stand supplied in a waterproof transit cover. The stand will extend to a maximum height of 5' 3" and closes to 17". The MZS 142 is fitted with a 3/8" thread.

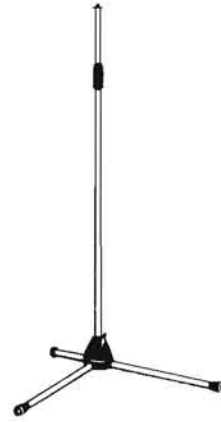

Floor Stand MZS 144

The height of this studio floor stand is adjustable between 3' and 5' 6". The detachable legs are rubber tipped. The MZS 144 is fitted with a 3/8" thread.

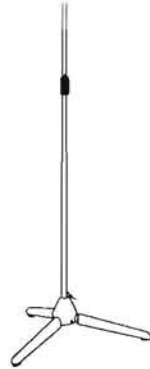

De Luxe Floor Stand MZS 210

A heavy duty studio floor stand with anti-vibration mounts concealed in the legs. The height is adjustable between 3' and 5' 6". The legs will fold together for ease in transportation. The MZS 210 is fitted with a 3/8" thread.



Twin Microphone Adapter Bar MZS 235

A 9" bar which fits all Sennheiser and other stands with 3/8" threads, enabling two microphones to be fitted on one stand. Particularly useful for stereo.



Anti-Vibration Suspension MZS 105

A combined swivel and anti-vibration suspension for use with microphones MKH 105 and MKH 405. The MZS 105 is supplied complete with a 5/8" - 3/8" thread adapter.



Microphone Boom Suspension MZS 805

A heavy duty anti-vibration suspension for the MKH 805 microphone. The MZS 805 terminates in a 3/8" thread.



Microphone Boom Arm MZS 211

The MZS 211 will fit on all Sennheiser and other stands fitted with a 3/8" thread. The boom arm is fully adjustable for length and angle, and is itself fitted with a 3/8" thread. Maximum extension 30".



Floor Stand Suspension SZS 1008

With this accessory the wireless microphone transmitter SK 1008 can be mounted on a floor- or desk stand. To be used together with thread adapter MZH 216.



Power Supply MZN 5-1

Power supply for microphones MKH 105, MKH 405, and MKH 805. Stabilized and filtered power for two microphones. Dimensions 100 x 170 x 55 mm.



MZV 125

60 Ω coaxial cable 15 ft long for the extension of MK 12 microphone to MH 124 or MH 125.

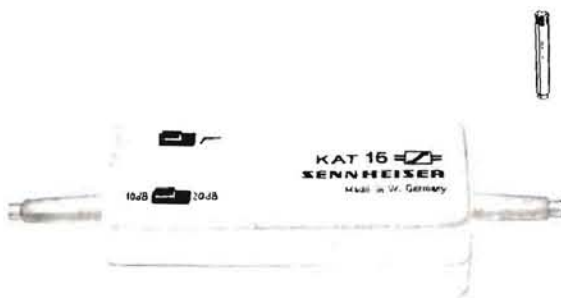

Transistor Pre-Amplifier KAT 15

The pre-amplifier KAT 15 enables Sennheiser condenser microphones MKH 105, MKH 405 and MKH 805 to be powered from the accessory socket of the Nagra III. Fitted with switchable bass cut and 10 dB attenuator.



Dual Input Microphone Pre-Amplifier KAT 25

A combined pre-amplifier and voltage stabilizer for use with Nagra III tape recorders. Two Sennheiser condenser microphones can be used simultaneously and powered from the Nagra III batteries. Channel 1 has a 20 dB attenuator and connects to the microphone input of the Nagra. Channel 2 has a 15 dB amplification and connects to the Nagra accessory socket. The bass cut switch operates on both channels simultaneously. For use with MKH 105, 405 and 805. Dimensions 170 x 60 x 28 mm.



Roll off Filter MZF 5

A roll off filter MZF 5 for use with microphones MKH 105, 405 and 805 may be fitted between the battery supply unit and the microphone input. Fitted with a Tuchel connector at either end. Attenuation at 100 Hz – 6 dB. Attenuation at 50 Hz \geq 15 dB.



Battery Adapter MZA 6-2

A lightweight power supply for condenser microphones MKH 105, 125, 405 and 805. The battery adapter is fitted with a Tuchel connector at either end and may be fitted at any convenient place in the microphone cable. The battery pack will accept 9 mercury cells (Mallory RM 625). One set of 9 cells has a nominal life of 60 – 70 hours.



Power Supply Unit MZN 4-4

Power supply for microphones MKH 110 and 110-1. Stabilized and filtered for two microphones. The power supply can be connected at any convenient point along the microphone cable. Dimensions 100 x 170 x 55 mm.

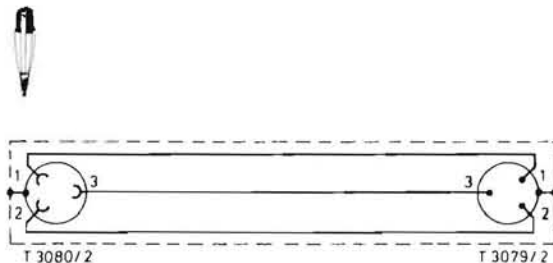

Length: 5 m

Connecting Cable DAV 5

Fitted with a female Tuchel coupling T 3080/2 to connect to all dynamic microphones fitted with the male Tuchel connector T 3079/2. The other end of the 3 lead shielded cable is fitted with the male Tuchel T 3079/2 connector.

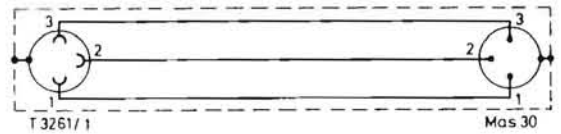

Length: 1.5 m

Connecting Cable DA 1 HL

Connects all dynamic microphones fitted with 3 prong plugs as per DIN 41524. The 3 lead shielded cable is fitted with the 3 prong coupling as per DIN 41524 (e. g. T 3261/1). The other end is fitted with a male connector (e. g. Mas 30).

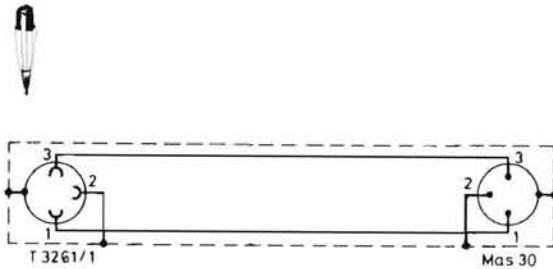

Length: 7.5 m

Connecting Cable DA 7 N

Connects all low impedance dynamic microphones fitted with 3 prong connector as per DIN 41524. The 7.5 metre 2 lead shielded cable is fitted with a coupling (e.g. T 3261/1) and a male connector (e. g. Mas 30).

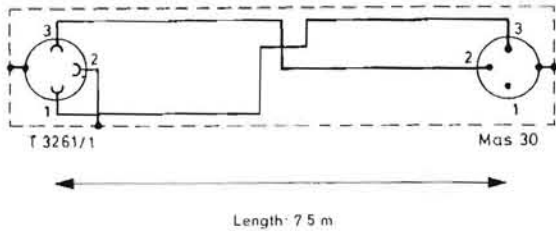

Connecting Cable DA 7 NL

Connects low impedance balanced (N) microphones to low impedance unbalanced inputs (L). Coupling as per DIN 41 524 (e. g. Tüchel T 3261/1) and 3 prong male connector (e. g. Mas 30).

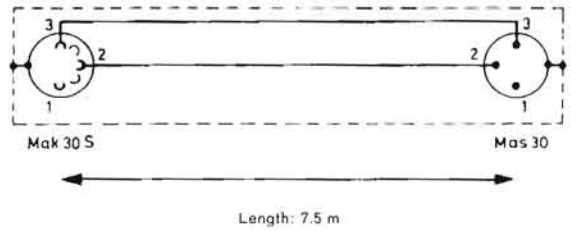

Extension Cable DV 7 HL

To be used with HL-microphones with 3 prong connector as per DIN 41 524. Connects low impedance unbalanced microphones. Fitted with Mas 30 connector (DIN 41 524) and a coupling Mak 30 S.

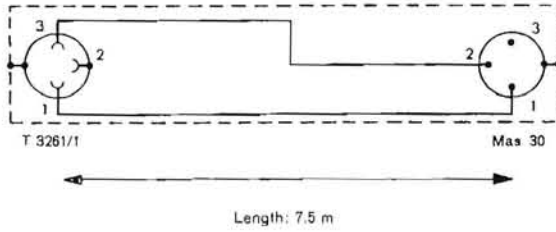

Connecting Cable DA 7 NM

Intended for use with low impedance balanced microphones fitted with 3 prong connector as per DIN 41 524. The 2 lead shielded cable is fitted with the connector Mas 30 and a coupling Tüchel T 3261/1.

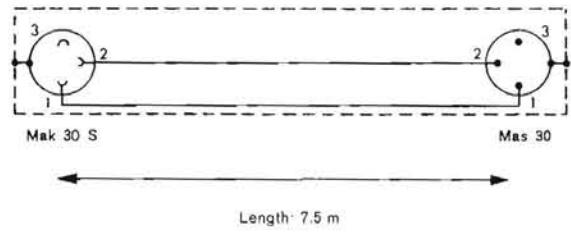

Extension Cable DV 7 M

Intended for use with microphones of medium impedance into medium impedance inputs. The 2 lead shielded cable is wired as per DIN 41 524 with connectors (e.g. Mas 30 male connector and coupling Mak 30 S).

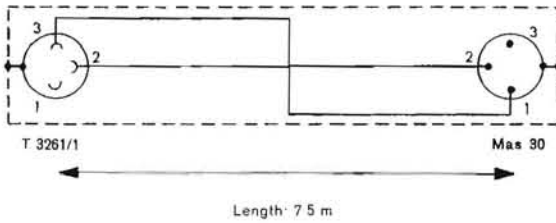

Connecting Cable DA 7 LM

To be used to connect low impedance unbalanced microphones fitted with standard connector as per DIN 41 524 to medium impedance inputs. The 2 lead shielded cable is fitted with male connector (e. g. Mas 30) and coupling (e. g. Tüchel T 3261/1) as per DIN 41 524.

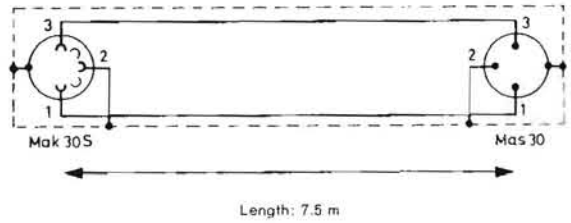

Extension Cable DV 7 N

For use with low impedance microphones fitted with standard connector as per DIN 41 524. The 2 lead shielded cable is fitted with the necessary connectors (e. g. Mas 30 and coupling Mak 30 S).

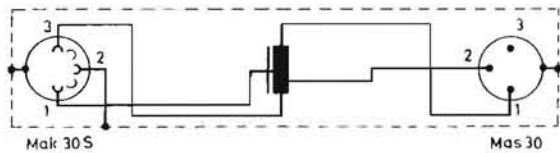

Wiring diagram TM 514 N

Cable Transformer TM 514 N

To be used to connect low impedance (200Ω) balanced microphones to high impedance inputs. The microphone side of the cable is fitted with a DIN standard coupling and 5 m of shielded cable, the equipment side with 0.4 m of shielded cable and the 3 pin standard connector Mas 30. Pin connections of coupling: 1 and 3 \rightarrow microphone coil, 2 and housing \rightarrow ground, male connector: 1 \rightarrow input, 2 \rightarrow ground, connector housing \rightarrow shield. Transformation ratio is 1 : 16.

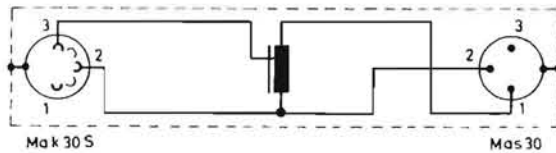

Wiring diagram TM 514 HL

Cable Transformer TM 514 HL

To be used to connect HL-microphones to high impedance inputs. Wiring of the coupling: 2 and 3 \rightarrow microphone coil, connector housing \rightarrow shield. Wiring of male connector: 1 \rightarrow input, 2 \rightarrow ground, connector housing \rightarrow shield. Transformation ratio is 1 : 16.

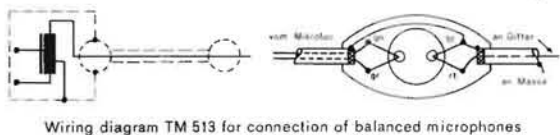

Wiring diagram TM 513 for connection of balanced microphones

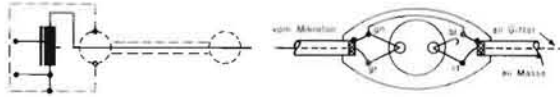

Wiring diagram TM 513 for connection of unbalanced microphones

Cable Transformer TM 513

The universal transformer which may be fitted with any connector. The equipment side is fitted with 0.5 m 1 lead shielded cable. Transformation ratio is 1 : 20. Source impedance: 200Ω . The above wiring diagrams show the possibilities for connection of balanced and unbalanced microphones.

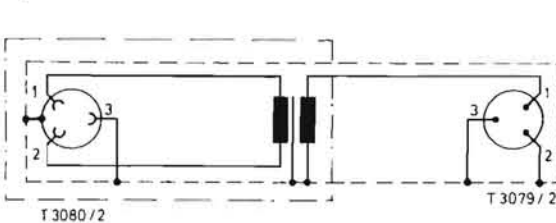

Wiring diagram TB 501

Cable Transformer TB 501

The highest quality of the Sennheiser wide band transformers. The TB 501 is fitted on the microphone side with the 3 pin Tuchel connector T 3080 and on the equipment side with 0.75 m shielded cable with the 3 pin male Tuchel connector T 3079/2. Pin connections on receptacle: 1 and 2 \rightarrow microphone coil, 3 and connector housing \rightarrow shield. Male connector: 1 \rightarrow input, 2 and 3 \rightarrow ground.

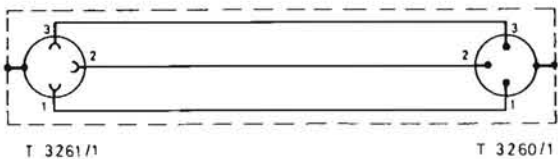

Connection Cable KA 1 and KA 7

Both cables differ only in length; the KA 1 is 1.5 m and KA 7 is 7.5 m long. Both are intended for use with the transistor condenser microphones MKH 105, 405, 415, 805, 815 and the lapel microphone MKH 125, also for MKH 110 and 110-1. The cables KA 1 and KA 7 are fitted with a 3 pin connector as per DIN 41 524 (e. g. Tuchel T 3260/1) and the corresponding coupling (e. g. Tuchel T 3261/1).

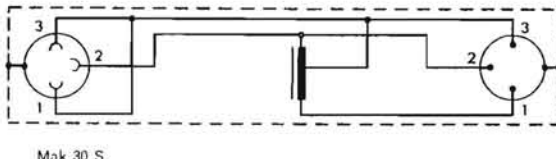

Mak 30 S

Coupling With Integrated Transformer TS 514 M

The Transformer-Adapter TS 514 M is to be used to connect LM-microphones to high impedance inputs. Transformation ratio is 1 : 6. The 5 m long cable is fitted with a 3 pin coupling as per DIN 41 524 (e. g. Mak 30 S). Connections: 1 and 2 \rightarrow microphone coil = medium impedance, unbalanced; 3 and 2 \rightarrow microphone coil = low impedance, unbalanced; 3 and 1 connected. Male plug connections: 1 \rightarrow input, high impedance, 2 \rightarrow ground, 3 \rightarrow input, low impedance.

Product Group 3 Magnetic Microphones

In many cases the use of light weight miniature microphones is essential, e. g. pocket hearing aids. Sub-miniature magnetic microphones are used in hearing aids which are worn in or behind the ear.

Magnetic Button Microphone MM 23

For many years now Sennheiser electronic has been manufacturing the magnetic button microphone MM 23. This microphone with its characteristic "receiving button" is supplied with a connector widely used for electronic flashlights. It is especially designed for voice transmission and has an impedance of 2,000 Ω which allows transformerless input matching for transistor circuits.

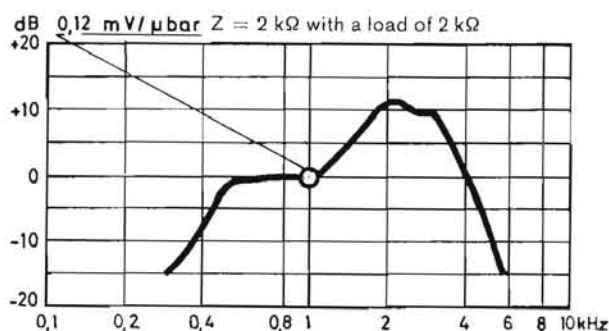

Technical Data

Frequency range	400 ... 4,000 Hz
Tolerances in dB from standard performance curve	
from 400 ... 4,000 Hz	± 3 dB
from 1,000 ... 4,000 Hz	± 4 dB
Impedance	2,000 Ω
Sensitivity at 1,000 Hz with a load of 2,000 Ω	0.12 mV/ μ bar
Weight	approx. 6 grams
Dimensions	18.9 x 15.5 x 12.6 mm
Connecting cable:	
Microphone connector	standard electronic flash plug
Equipment connector	not provided

We reserve the right to alter the specifications especially with regards to technical improvements.

Magnetic Button Microphone MM 28

The button microphone MM 28 has a high sensitivity of 0.2 mV/ μ bar with a load of 2,000 Ω . The MM 28 which is extremely robust can be used with our "Mikroport" transmitter. The usual impedance of the MM 28 is 2,000 Ω therefore it can be matched without input transformers directly into transistor circuits.

The body of the MM 28 is extremely slim and flat behind the "button hole" receiver. The connecting cable has a miniature plug and is very flexible. This microphone may be used with all low and medium high impedance taperecorder inputs and is capable of good voice reproduction.

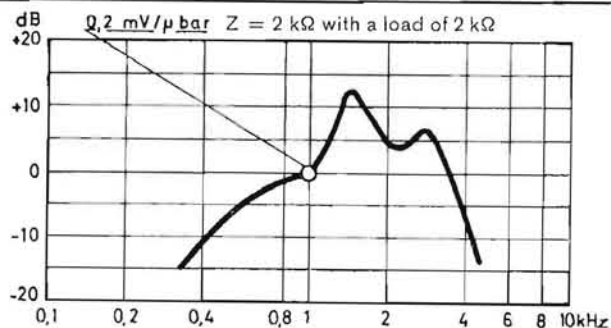

Technical Data

Frequency range	500 ... 4,500 Hz
Tolerances in dB from standard performance curve	
between 500 and 1,000 Hz	± 4 dB
between 1,000 and 4,000 Hz	± 5 dB
Impedance	2,000 Ω
Sensitivity at 1,000 Hz with a load of 2,000 Ω	0.2 mV/ μ bar
Weight	approx. 6 grams
Dimensions	26 x 22 x 14.5 mm
Connecting cable:	
Microphone connector	miniature plug
Equipment connector	not provided

We reserve the right to alter the specifications especially with regards to technical improvements.

Magnetic Microphone Capsules MM 21 and MM 26

These miniature microphone capsules are designed for use where mounting space is limited. Intended mainly for voice reproduction a good legibility is achieved.

The standard impedance is 2,000 Ω which allows transformerless matching into transistor circuits. The capsule is constructed from high quality materials and is insensitive to changes in temperature and humidity.

Technical Data

MM 21	
Frequency range	400 ... 4,000 Hz
Tolerances in dB from standard performance curve	
between 400 and 1,000 Hz	± 3 dB
between 1,000 and 4,000 Hz	± 4 dB
Impedance	2,000 Ω
Sensitivity at 1,000 Hz with 2,000 Ω load	0.14 mV/ μ bar
Weight	approx. 5.4 grams

We reserve the right to alter the specifications especially with regards to technical improvements.

Technical Data

MM 26	
Frequency range	200 ... 7,000 Hz
Tolerances in dB from standard performance curve	
up to 1,000 Hz	± 3 dB
up to 5,000 Hz	± 5 dB
Impedance	2,000 Ω
Sensitivity at 1,000 Hz with 2,000 Ω load	0.11 mV/ μ bar
Weight	approx. 6 grams

We reserve the right to alter the specifications especially with regards to technical improvements.

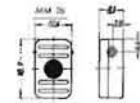
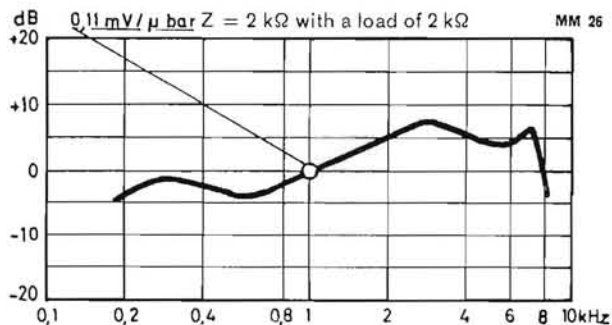
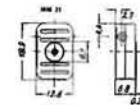
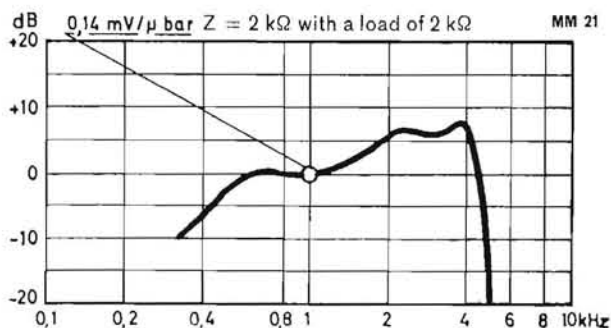

Magnetic Sub Miniature Microphone MM 301

The magnetic microphone capsule MM 301 is the smallest in the Sennheiser program. The tiny capsule needs only 1/7 the space of the previously described microphones and is therefore extremely suitable for use in hearing aids which are worn behind the ear. The body of the capsule is made of high quality material which in most cases needs no additional shielding against stray magnetic fields. The capsule is designed to operate over a large range of temperatures and humidity and this allows it to be used in tropical climates. Standard impedance for the MM 301 is 4,500 Ω and therefore it is easily matched to transistor circuits.

Technical Data

MM 301	
Frequency range	500 ... 6,000 Hz
Tolerance in dB from standard performance curve	
between 500 and 1,000 Hz	± 3 dB
between 1,000 and 5,000 Hz	± 4 dB
Impedance at 1,000 Hz	4,500 Ω
Sensitivity at 1,000 Hz with a load of 5 k Ω	approx. 0.12 mV/ μ bar
Weight	approx. 0.8 gram

We reserve the right to alter the specifications especially with regards to technical improvements.

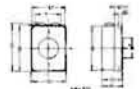
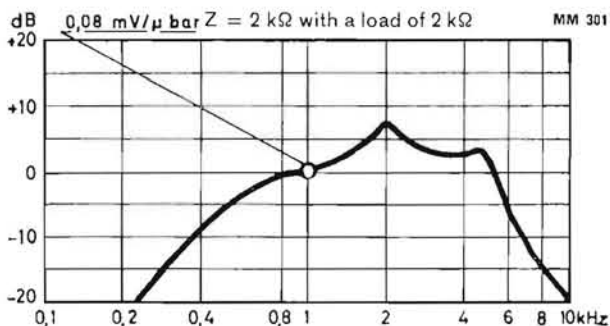

Product Group 4 Dynamic Stereo Headphones

Stereo Headphone HD 110 Microphone/Headphone Combination HMD 110

The HD 110 headphones are designed to the same standards as the Sennheiser range of professional microphones. They are therefore equally suitable for the professional sound recordist and the serious amateur. The very high quality of reproduction matches the Philharmonic and enables the listener to enjoy high fidelity reproduction in the home without inconvenience to the remainder of the family.

The professional user will appreciate the fidelity of reproduction for the monitoring of recordings. The ear-pieces are particularly rugged and can be disconnected if required. The ear cushions can be removed and washed, and the cable can be disconnected for quick replacement in case of damage. The snug and comfortable fit of the ear-pieces to the head excludes extraneous sound to a high degree.

The domestic user will appreciate that the frequency response has been tailored to equal that of a high quality monitor loudspeaker — even to the extreme bass. The soft ear cushions give maximum comfort for extended periods of listening.

The headphones are also available fitted with a microphone on an adjustable boom arm and this combination is the HMD 110. The close talking microphone is highly directional and makes the HMD 110 suitable for language laboratories, studio talk-back and production control purposes.



Technical Data

HD 110 and HMD 110

Frequency range	20 to 20,000 Hz linear, in comparison with free field response
Impedance	200 Ω ± 15 % (each capsule)
Power consumption	1 mW per capsule (450 mV into 200 Ω) for an acoustic output of 98 dB (16 μbar) at 1,000 Hz
Maximum audio output	120 dB (200 μbar) for 1 % distortion (corresponding to an input of 170 mW; 5,8 V per capsule)
Sensitivity	500 $\frac{\mu\text{bar}}{\sqrt{\text{V} \cdot \text{A}}}$ at 1,000 Hz i. e. 35 $\frac{\mu\text{bar}}{\text{V}}$ at 200 Ω and 1,000 Hz approx. 10 oz.
Weight	
Microphone	
Mode of operation	dynamic, pressure gradient transducer for close range talking
Frequency range	50 to 14,000 Hz
Sensitivity	0.07 mV/μbar ± 3 dB
Impedance	200 Ω approx.
Directional characteristic	super-cardioid
Discrimination at 120°	18 dB - 3 dB
Dimensions	capsule 32 Φ, with boom arm 140 mm long
Weight	1.3 oz.

We reserve the right to alter the specifications especially with regards to technical improvements.

Dynamic Stereo Headphone HD 414

The HD 414 represents a complete revolution in design of headphones. The new electro-acoustic system does not require that the headphones should be sealed to the ear. In conventional headphones this ear-seal has always been necessary for obtaining an extended bass response. For long listening periods the air-tight seal can be uncomfortable and tiresome to the wearer.

The HD 414 uses a totally new principle. The light-weight porous foam ear cushions fit comfortably against the ears and allow the ear to "breathe". In this way a sound impression is received which resembles normal hearing. This combined with the wide, smooth frequency response makes reproduction even more realistic. A new measurement system has been developed for the measurement of sensitivity and frequency response which is related to normal hearing. To add to the outstanding frequency response the HD 414 headphones have the further features; extreme light weight, rugged removable sponge ear-pads, detachable ear-pieces, detachable cables.

The headset is supplied at a remarkably low price, complete with a set of multi adaptors to enable them to be connected to almost every amplifier and

tape recorder on the market without further conversion (US version supplied with standard stereo phone plug). Unlike other moving coil headphones, the HD 414 capsules have a usefully high impedance of 2 kΩ per capsule.

The HD 414 De Luxe is supplied with four pairs of individually coloured ear-pads so that each member of the family can readily identify his own pair of ear-pads.

Technical Data

Frequency range	20 to 20,000 Hz linear, in comparison with free field response
Impedance	2 kΩ approx. (each capsule)
Power consumption	1 mW per capsule (1.41 V into 2 kΩ) for an acoustic output of 102 dB (25 μbar) at 1,000 Hz
Maximum audio output	122 dB (250 μbar) for 1% distortion (corresponding to an input of 240 mW; 22 V per capsule)
Sensitivity	790 $\frac{\mu\text{bar}}{\sqrt{\text{V} \cdot \text{A}}}$ at 1,000 Hz i. e. 17.7 $\frac{\mu\text{bar}}{\text{V}}$ at 2 kΩ
Weight	approx. 5 oz.

We reserve the right to alter the specifications especially with regards to technical improvements.

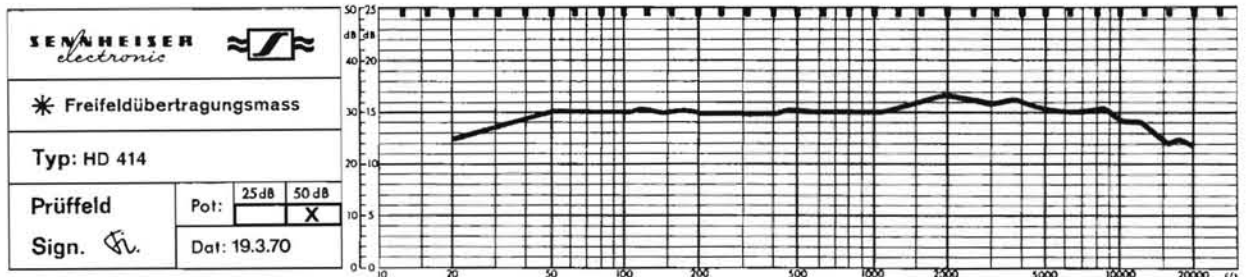

3-Channel Junction Box HZA 414

With an increasing number of HiFi enthusiasts using high quality dynamic stereo headphones for the monitoring of tape recordings and HiFi listening to a disc or radio, it has become essential to have a unit into which the headphones can be connected, without having to disconnect the speaker terminals from the amplifier. As many stereo amplifiers do not have any stereo headphone socket fitted this often means the continuous disconnection of the loudspeaker output in order to connect the headphones to the amplifier. This is often a great inconvenience as the loudspeaker sockets on the amplifier are sometimes placed in an inaccessible position. It was with these points in mind that Sennheiser Electronic designed the 3-channel junction box HZA 414 which provides the easiest method of connecting the headphones and the loudspeakers to one unit. A surface switch offers quick selection between loudspeaker output and headphone output.

The leads from the two loudspeaker enclosures do not have to be connected into the HZA 414 junction box but are connected into the back of the plugs attached to the HZA 414 cable. The connectors on the HZA 414 cable are then connected directly into the amplifier. The switching from headphones to speakers is carried out by the surface mounted switch. The HZA 414 cable is of necessity large in diameter as the high currents needed to drive the speakers must go via the switch.

When using three HD 414 headphones simultaneously the removal of one pair will not cause an increase in volume on the remaining pairs. As illustrated in the circuit diagram a series resistor of 620Ω is fitted to each headphone output. This ensures that headphones varying in impedance between 100Ω and $4,000 \Omega$ will have less than $\pm 2 \text{ dB}$ difference between each of the three outputs. At the same time these series resistors cause an improvement in the signal to noise ratio usually inadequate when low impedance headphones are con-

nected. The improvement in signal to noise when a 100Ω pair of headphones are connected to the HZA 414 is greater than 17 dB and in the case of a 200Ω pair of headphones, greater than 12 dB.

Low value "dummy load" resistors are not fitted to this unit as modern transistorized power amplifiers are not harmed by having a high impedance across their output terminals. When used with valve amplifiers these resistors should be fitted, inside the HZA 414 by the dealer.

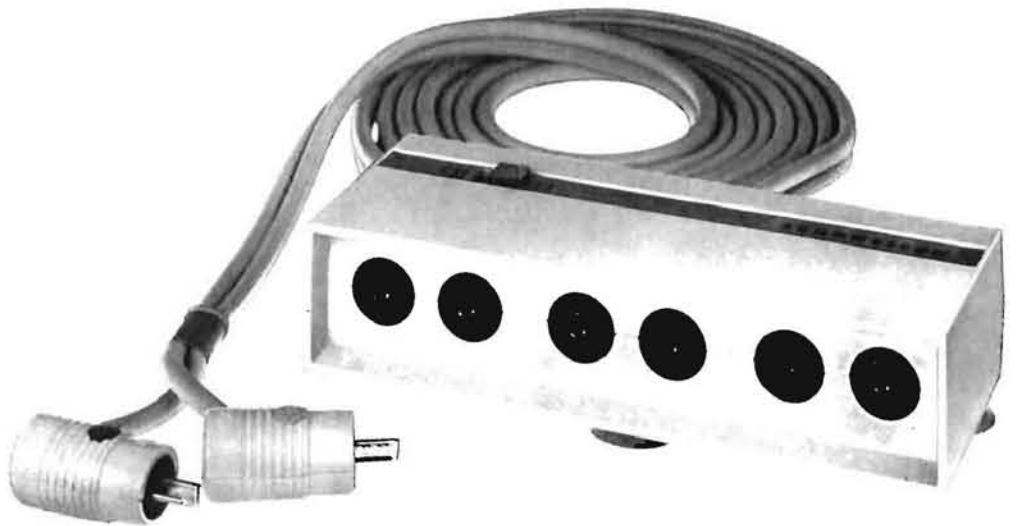
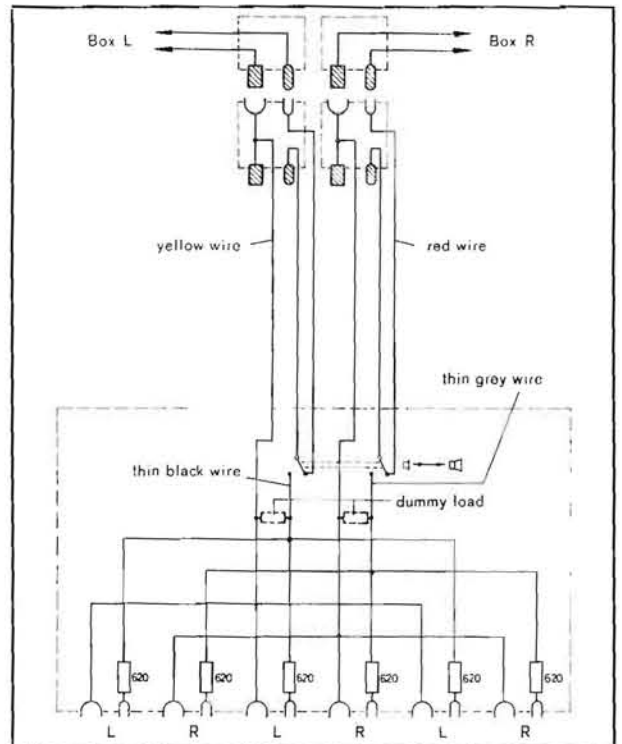

Stick Headphone HD 412

Throughout Europe record shops have the basic appearance they did ten years ago, particularly with regard to the design of the stick headphones which were designed originally on the same principle as the telephone earpiece. Many dealers have been requesting an improvement in design and a more modern type of stick headphone. Our designers were conscious of these facts and consequently the HD 412 was designed to meet the demand.

The capsule of the HD 412 is that of the widely distributed HD 414 stereo headphone. The capsule has been fitted with a rugged well-designed handle

manufactured in hard-wearing material. The connecting cable is also very robust.

It is now possible when purchasing a record to hear the complete dynamic range as heard by the recording engineer on the original recording. Four different colours of foam rubber ear-pads are supplied with the HD 412. The colours are red, blue, green and grey.

As with the HD 414 the capsules and ear-pads are all replaceable. The connecting cable supplied has no plug attached.



Technical Data

HD 412

Frequency range	20 to 20,000 Hz linear in comparison with free field response
Impedance	approx. 2 k Ω
Power consumption	1 mW per capsule (1.41 V into 2 k Ω) for an acoustic output of 102 dB (25 μ bar) at 1 kHz
Maximum audio output	122 dB (250 μ bar) for 1% distortion (corresponding to an input of 240 mW; 22 V per capsule)
Sensitivity	790 $\frac{\mu\text{bar}}{\text{V} \cdot \text{A}}$ at 1,000 Hz i. e. 17.7 $\frac{\mu\text{bar}}{\text{V}}$ at 2,000 Ω

We reserve the right to alter the specifications especially with regards to technical improvements.

Product Group 5 Magnetic Earphone Capsules

Earphone Capsule HM 35

This capsule was designed particularly for use with steto-clips or ear-clips used with dictating machines. It is necessary to have a slim lightweight capsule which is rugged enough to withstand rough treatment. All these requirements are designed in the inexpensive earphone capsule type HM 35. The capsule is so designed to incorporate a considerable distance between the membrane and the magnetic system. Even in case the unit suffers a severe knock the membrane cannot touch the magnetic system.

The capsule can be connected directly with a DC current if so desired. When a capsule manufactured at 500 Ω is connected into a DC supply of 3 mA the change in sensitivity will only be ± 1 dB.

The capsule is constructed from high quality materials insensitive to changes in temperature and humidity.

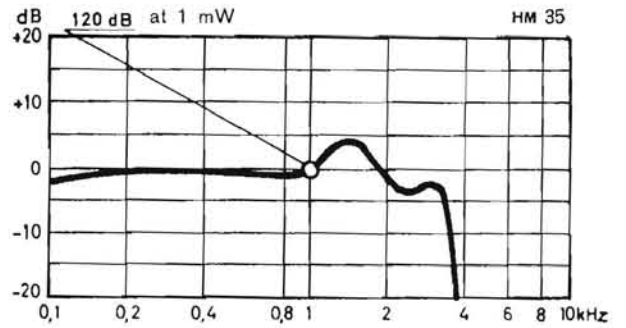

Technical Data

Frequency range with 2 ccm coupler	see curve (the frequency range extends to 5 kHz when used with the stetoclip or earpiece)
Sensitivity at 1 kHz and a power of 1 mW	approx. 120 dB ref. 2×10^{-4} dyne/cm ²
Distortion at 10 mW (at 1,000 Hz)	approx. 2 %
Maximum input power	25 mW
Distortion at 25 mW (at 1,000 Hz)	approx. 3.5 %
Impedance (at 800 Hz)	500 and 5,000 Ω (other values to order)
Weight	approx. 8 g
Colour	grey

We reserve the right to alter the specifications especially with regards to technical improvements.

Sub-Miniatur Capsule HM 401

The HM 401 sub-miniature capsule is the equivalent to the well-known sub-miniature microphone MM 301 in weight and dimensions. It can, therefore, be built in to equipment in a similar manner to the microphone where there is only a very small space e. g. in spectacle hearing aids and small hearing aids which are worn behind the ear. The acoustic output of the earpiece is a small tube which is built in to the narrow side of the earpiece. The earpiece is designed to operate in wide changes of temperature and humidity, and this allows it to be used in the tropics.

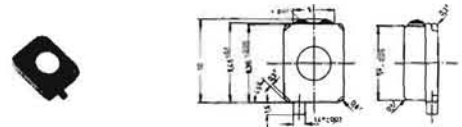
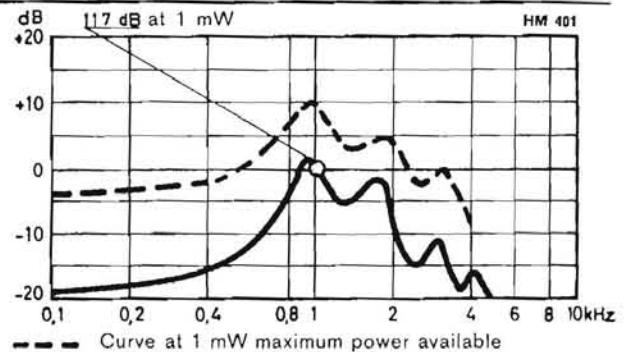

Technical Data

Frequency range with 2 ccm coupler	200 to 3,000 Hz (at the ear a frequency range up to approx. 5 kHz)
Sensitivity at 1,000 Hz and a power of 0.3 mW	approx. 120 dB ref. 2×10^{-4} dyne/cm ²
Maximum input power	approx. 1 mW
Distortion at 1 mW at 400 Hz	≤ 10 %
Impedance (at 1,000 Hz)	choice between 300 and 2 k Ω
D C	approx. 1.1 mA at Z = 300 Ω approx. 0.4 mA at Z = 2,000 Ω
Dimensions	7.2 x 11.5 x 4.4 mm
Weight	approx. 0.8 g

We reserve the right to alter the specifications especially with regards to technical improvements.

Stetoset HZS 21

The HZS 21 stetoset is designed for mono operation only and the small earpiece is permanently built in to the unit. A particular advantage with this unit is the flexible joint by the capsule, this allows the ear-phones to be fitted individually to any shape of head. Therefore, there is no undue pressure on the ears after wearing the unit for a long period of time. The total weight is so light that the user can operate for many hours without undue discomfort.

The HZS 21 has a frequency response from 60 Hz to 6,000 Hz and gives a very natural reproduction of speech.



Stetoset HZS 22

The HZS 22 stetoset is designed on exactly the same principles as the HZS 21 described above. This unit has been fitted with a volume control which is operated by turning the knob as illustrated opposite. The volume control enables the smooth adjustment of sound which is considered pleasant for the user.

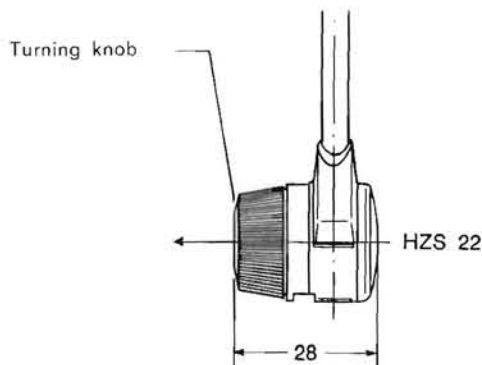

Technical Data

HZS 21 and HZS 22

Frequency range	60 Hz to 6,000 Hz
Sensitivity at 1 kHz	approx. 113 dB ref. 2×10^{-4} dyne/cm ² and 1 mW
Maximum input	25 mW
Impedance at 800 Hz	2,000 Ω (other values to order)
Capsule	magnetic type HM 33
Weight HZS 21 (without cable)	approx. 18 g
Weight HZS 22 (without cable)	approx. 25 g

We reserve the right to alter the specifications especially with regards to technical improvements.

Dynamic Earphone For Use With Dictating Machines HD 404

The quality of the modern dictating machine has improved so much that there is a demand for a transducer with wider and more linear frequency response than the magnetic capsule can provide.

The dynamic earphone HD 404 has been designed to provide maximal tonal quality within the recorded frequency range, without annoying resonance peaks. Due to its "open air" capsule it is possible to use the HD 404 as a single earphone with an earclip or as a twin system with a stetoclip. A variable control on the rear of each capsule allows convenient attenuation of the low frequencies, for instance when using the stetoclip with the resulting bass boost.

The dynamic earphone MD 404 has an impedance of 70 Ω and can be used for most dictating machines.

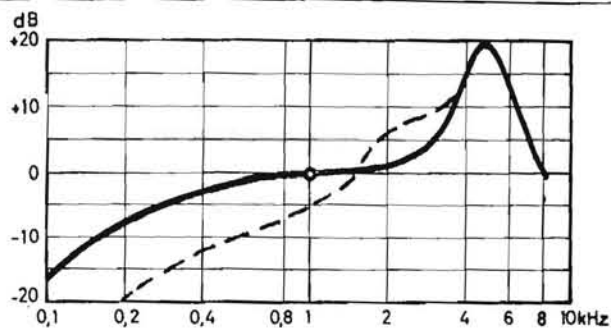

Solid line shows close field response at a distance of 1 cm.
Dotted line = response with maximum bass attenuation.



HD 404

Technical Data

Sensitivity at 1 kHz and power of 1 mW	104 dB in reference to 2×10^{-4} dyne/cm ²
Maximum input power	150 mW
Distortion at 10 mW and 1,000 Hz	$\leq 1\%$
at 25 mW and 1,000 Hz	$\leq 1\%$
Impedance at 1,000 Hz	70 Ω
Body	heavy duty grey plastic material

We reserve the right to alter the specifications especially with regards to technical improvements.

Earphone Accessories

Stetoclip HZS 1

The HZS 1 is a stetoclip with a flexible joint. In the centre of the joint there is an opening into which a small earpiece can be fitted. The fitting will take any type of Sennheiser ear capsule.

Ear Piece HZB 11

Sennheiser ear pieces can be used on either the left or the right ear. The HZB 11 when used the small capsule HM 35 offers a particularly lightweight unit which can be used when it is essential for the operator to hear a second sound source.

Cable HZL 18

Very flexible balanced cable 150 cm long fitted with a sub-miniature connector at one end and no connector at the other.

Cable HZL 19

Very flexible miniature coaxial cable 150 cm long fitted with a sub-miniature connector at one end and no connector at the other.



Ear piece HZB 11
with earphone capsule HM 35



Stetoclip HZS 1
with earphone capsule HM 35

Product Group 6



HiFi Stereo Reproducer System HS 303 "Philharmonic"

The "Philharmonic" is a high quality stereo system designed for domestic use. For many years it has been acclaimed by professional users as one of the foremost systems in studios and was developed in principle from the professional reproduction system designed by Sennheiser for studio replay. Details of the professional system can be seen on page 70.

Those who have seen the "Philharmonic" demonstrated at Audio Fairs and lectures, have commented on the simplicity of the system. The basic system incorporates two loudspeaker units with transistorised amplifiers concealed in the back a mixer and a remote control unit. As the total system has been designed by one group of engineers a consistency of quality has been made possible throughout the "Philharmonic". In order to suit the requirements of various people the mixer has been designed to accept all types of tape recorders turntables, etc. produced by various manufactures. An important feature is the design of the amplifier and loudspeaker; most conventional systems use the amplifier and the loudspeaker in separate housings which can lead in some cases to unsatisfactory

results, therefore, Sennheiser has adopted the studio technique of incorporating the amplifier with the loudspeaker and equalising the frequency response in the one unit.

As mentioned above the housing of the amplifier and the loudspeaker in one unit offers many advantages to the designer; enabling him to tailor the overall frequency response giving the necessary equalisation in bass and treble frequencies. The bass frequencies in particular can be compensated for and any resonance of the speaker or enclosure can be smoothed out in the amplifier. Evidence of the overall frequency response is supplied with every loudspeaker/amplifier in the form of an individual response curve traced in an anechoic chamber.

With the Philharmonic system consisting of only two loudspeaker units, a mixer and remote control unit, the system can be easily installed in an average size room. The remote control unit can be used at any distance from the mixer and in a domestic situation usually from a comfortable arm chair as demonstrated in the illustration below.



Reproducer VKL 303



The stereo remote control unit regulates the signal from the mixer to the two loudspeaker enclosures type VKL 303. In each loudspeaker enclosure there is a built-in main amplifier with the loudspeaker (as illustrated below). This method of construction offers the optimum of electro-acoustical quality. The power amplifier and loudspeaker are electronically equalised one with the other. In this manner the outstanding over-all frequency response is obtained for the complete system.

A further advantage derived from this method is the low harmonic distortion of the power amplifier of less than 0.1 % with an output of 20 W.

The above mentioned mode of construction is the most important feature of the Philharmonic system. The loudspeaker being the weakest link in the chain cannot distort the quality of the signal from the amplifier. Despite the advantages of this system a good frequency response could not have been reached solely through coupling of the amplifier with the loudspeaker. After many years of research on loudspeaker systems carried out by a Sennheiser research team many new techniques of loudspeaker design were discovered, and a lot of superstition removed. It was discovered that the position of an individual loudspeaker in a room could have the bass response electronically tailored by means of a "room corrector" device built into the amplifier, thus enabling the bass frequencies of one loudspeaker to be identically matched to that of another loudspeaker in a different position in the same room. The VKL 303 amplifier has a "room corrector" switch supplied, this enables the user to balance the bass response of a loudspeaker positioned in the corner of a room and, therefore, giving the impression of more bass, with that of another speaker positioned against a flat wall which would tend to be lighter in bass. The four positioned room corrector switch would allow the user to compensate the bass response of each enclosure individually.

As the amplifiers are completely transistorized the enclosures are not subjected to any undue heat therefore it is possible to mount the loudspeaker enclosure into a cupboard or built into the wall. The loudspeaker enclosure can also be mounted horizontally as well as vertically if desired.

Tubular steel feet are available as accessories if required (see illustration).

The loudspeaker enclosures can be used singly for mono operation or in pairs for stereo operation and will accept the following sound sources:

1. The Philharmonic,
2. Tape recorders,
3. Record players having built-in preamplifiers,
4. Tuners,
5. Sennheiser Mikroport system,
6. Electronic musical instruments,
7. Sound reinforcement systems,
8. Sennheiser microphone preamplifier VV 303.

With each amplifier having a signal input and output socket as well as a mains input and output socket, many VKL 303 enclosures may be connected together for reinforcement purposes in large auditoriums.

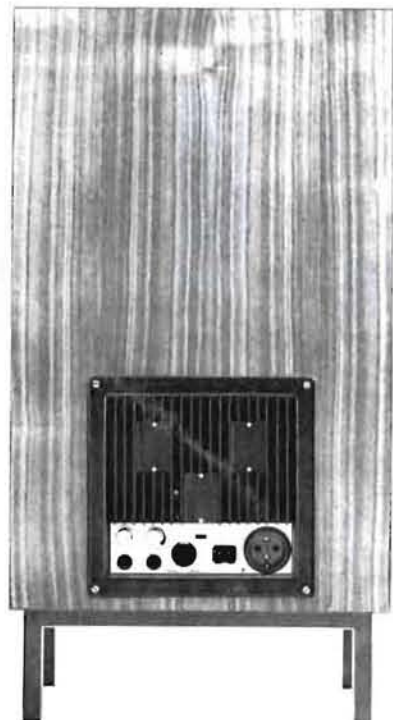
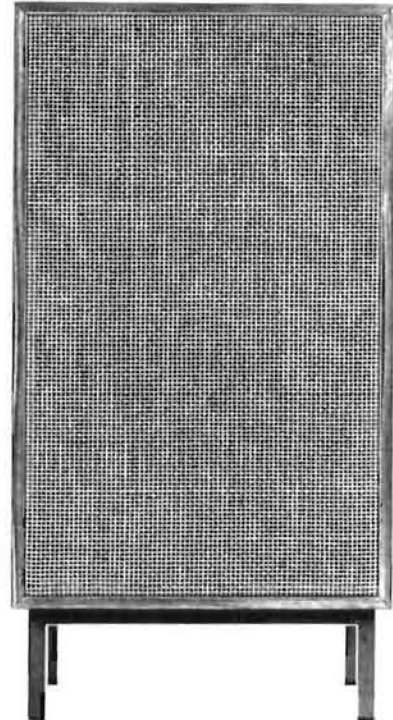

VKL 303

Height (without legs)	34 "
Width	16 "
Depth	10 "
Weight	21 kg
Accessories	mains cable VZN 303 audio cable VZL 303 (Floor stand VZG 303 on request)



Technical Data

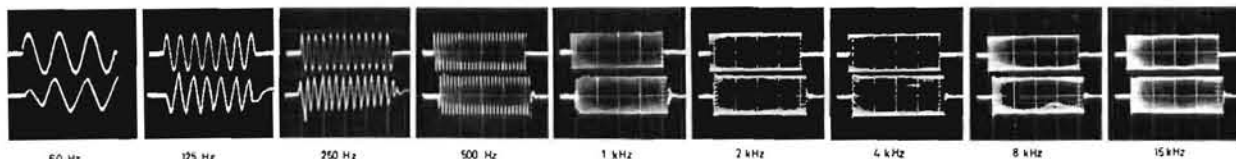
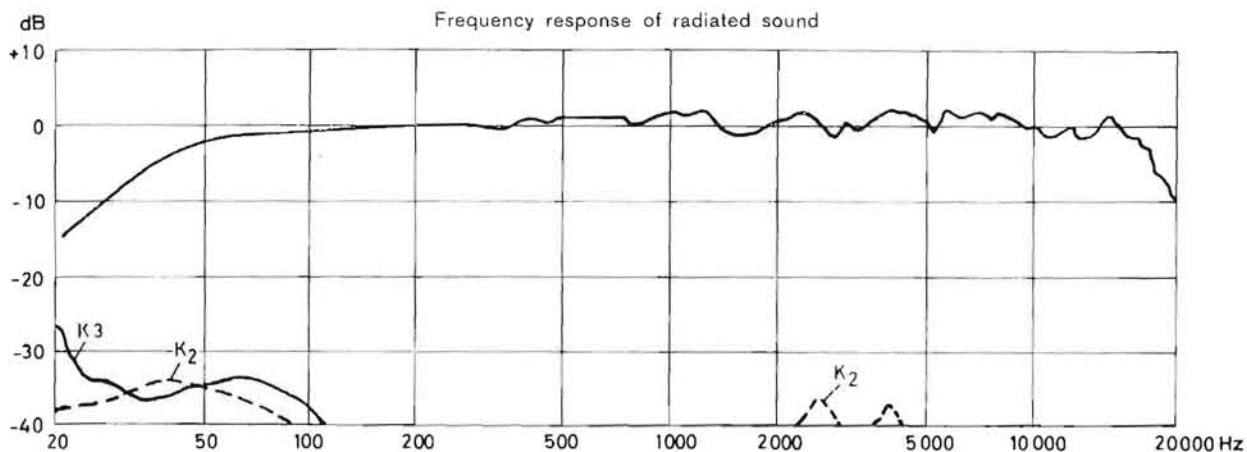

Transient response

HS 303

Output power continuous sine wave	approx. 2 x 30 W
Inputs	
Microphone I	2 mV at 50 kΩ
Microphone II	2 mV at 50 kΩ
Phono (magnetic)	2.5 mV at 50 kΩ
Radio	2 mV at 50 kΩ
Tuner	500 mV at 120 kΩ
Tape	220 mV at 100 kΩ
Output level	500 mV at 50 kΩ
Electrical frequency response ref. 1,000 Hz	20 Hz to 30 kHz ± 1.5 dB
Frequency response of radiated sound	see curve. Each unit is supplied with its own individually plotted frequency response curve
Tone control	
Bass	30 Hz ± 15 dB
Treble	20 kHz ± 15 dB
Rumble filter	60 Hz - 3 dB 15 dB/octave
Scratch filter	6 kHz - 3 dB 15 dB/octave
Outputs	
Tape Recorder I	2 x 15 mV at 1 MΩ (Ri = 15 kΩ)
Tape Recorder II	2 x 300 mV at 1 MΩ (Ri = 2.2 MΩ)
Headphones	2 x 1 V at 100 Ω
Harmonic distortion dependent upon frequency and output power	see curve
Intermodulation DIN 45 503 (at full output measured with 250/8,000 Hz, level ratio 4 : 1)	0.7 %
Signal to noise ratio for all inputs	65 dB
Signal to noise, power amplifier (ref. 30 W)	85 dB
Power consumption	
Control	3 W
Power amplifier	2 x 7 W quiescent 2 x 70 W full output

We reserve the right to alter the specifications especially with regards to technical improvements.

Stereo Mixer VMS 303



Three sound sources can be fed into the stereo mixer VMS 303 and the output of each channel is controlled by a slide-fader. The following inputs are built into the back panel of the mixer:

Two microphone inputs (2 mV at 50 k Ω) which operate into microphone input 1 and microphone input 2. Channels 1 and 2 control these inputs.

One input for radio with a sensitivity switch operating between RADIO (2 mV at 50 k Ω) and TUNER (500 mV at 120 k Ω). This input is controlled by channel 1, labelled "Radio".

One input for each type of gramophone cartridge. Magnetic pick-up (2.5 mV at 50 k Ω) and crystal pick-up (500 mV at M Ω). These inputs are controlled by channel 2 labelled "Phono".

The tape input (220 mV at 100 k Ω) is controlled by channel 3, labelled "Band".

A stereo headphone output is also supplied on the rear panel.

In order to be adaptable to the many sensitivities of tuners, radios, magnetic and crystal systems, the necessary switches have been built into the back of the mixer. The VMS 303 Mixer will record stereo as well as mono and naturally reproduce both modes of operation. At the top of each slide-fader is a channel sensitivity control. This control is supplied in order that the outputs of each channel may be the same when each individual slider is at its farthest limit.

The mixer is switched on by using the push-button switch marked "Ein". The second push-button labelled "Rauschfilter" operates a noise filter network tailoring the treble frequency response at 6 kHz and decreasing at 15 dB per octave. A third push-button labelled "Rumpelfilter" can be used to remove unwanted low frequencies dropping 3 dB at 60 Hz and decreasing at 15 dB per octave.



VMS 303

Height	3 inches
Width	9 inches
Depth	4 inches
Weight	2.1 kg

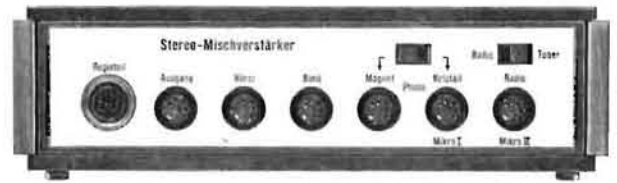

Stereo Remote Control Unit VRS 303

The Stereo Remote Control Unit is connected to the mixer by means of a cable 16 feet long which can be extended up to 200 feet if necessary. This facility enables the complete control of the system from an armchair. The versatility of this unit in spite of its small measurements can be seen from the following data. The remote control unit has five control knobs which operate as follows:

- 1. Treble Control (Diskant)**
This treble frequency control will allow a variation of ± 15 dB at 20 kHz.
- 2. Bass Control (Bass)**
This control gives a variation in the bass frequencies of ± 15 dB at 30 Hz.
- 3. Stereo Width Control (Basis)**
This control enables the stereo image to be increased according to taste. The control operates continually from mono through stereo to the extreme stereo position.
- 4. Balance Control (Balance)**
The balance control enables a correct image to be reproduced without the necessity of sitting in a central position between the two speakers.
- 5. Loudness Control (Lautstärke)**
The loudness control varies the output in sound and compensates in the bass frequencies when the setting is below 2.



VRS 303

Height	3 inches
Width	4 inches
Depth	9 inches
Weight	1.2 kg



HiFi Microphone Preamplifier VV 303

The power reproducer VKL 303 described in detail on page 64 shows the advantages of having the amplifier built into the loudspeaker enclosure. It was therefore natural for Sennheiser to design as an accessory the VV 303 high quality microphone pre-amplifier.

The preamplifier is designed to accept Sennheiser microphones and is connected to the VKL 303 by 16 feet of cable. The VKL 303 also supplies the required power to the VV 303 down the same cable. The VV 303 is so designed that any type of Sennheiser microphone whether dynamic, balanced or unbalanced, or condenser, balanced or unbalanced, can be connected.

The five position impedance and sensitivity selector allows quick adjustment to match the respective microphone which has been connected. The VV 303 has been fitted with a volume control which enables the user to control the desired level of volume at the source of the sound without having to adjust the volume control on the amplifier of the VKL 303. The volume control also acts as an on-off switch.

The small preamplifier is housed in a shockproof and scratchproof casing, and is designed to allow the unit to be mounted on a microphone stand below the microphone. If necessary it can be placed on a table but to do this the microphone stand adaptor should be detached.

The whole system has been designed so that microphone, preamplifier and power reproducer all allow a high quality performance. The VV 303 corresponds with the HiFi standard DIN 45 500. Its frequency response is smooth and extends from 10 Hz to 30,000 Hz. As two VV 303 preamplifiers can be connected to a VKL 303 power reproducer, many combinations and mixing possibilities arise.



Technical Data

VV 303

Input sensitivity	
Position N or L, HL or M	0.3 mV
Position TU or TS	2 mV
Input Impedance	
Position N or L, HL or M	approx. 2 kΩ
Position TU	approx. 1 kΩ
Position TS	approx. 400 Ω
Output voltage	500 mV
Output Impedance	approx. 5 kΩ
Overload capability	approx. 20 dB
Frequency response	10 Hz — 30 kHz ± 2 dB
Signal to noise ratio, DIN 45 405, when using a dynamic microphone 200 Ω ref. 0.3 mV input voltage	approx. 60 dB
Power supply	- 35 — - 40 V
Input connections	
Position N	1 → AF, 2 → ground, 3 → ground
Position L, HL	1 → not connected, 2 → ground, 3 → AF
Position M	1 → AF, 2 → ground, 3 → not connected
Position TU	1 → AF, 2 → ground, 3 → power supply
Position TS	1 → AF, power supply, 2 → ground, 3 → power supply
Output connections	1 → not connected, 2 → ground, 3 → AF, 4 → power supply, 5 → AF
Dimensions	100 x 60 x 35 mm

We reserve the right to alter the specifications especially with regards to technical improvements.

Product Group 7 Mikroport SM 1008

Radio microphones are now widely used in all branches of the television and film industry and Sennheiser are justly famed for their original Mikroport radio microphone which is well liked for its compact size and proven reliability.

The SM 1008 transmitter-microphone combination is so small that it can be held in the hand like an ordinary microphone. The complete unit is no larger than Sennheiser's MD 421 cardioid microphone and yet it incorporates microphone, transmitter and battery.

Transmitter SK 1008

The Mikroport transmitter and microphone have been designed as a single unit. However, the microphone can be detached instantly, as shown on the right, and reveals a six pin socket in the end of the transmitter. To this a cable can be attached to

connect any suitable dynamic microphone to hold in the hand such as MD 211 (the famous moving coil microphone with the "condenser quality") or MD 214 (the Lavalier microphone with the built-in equalizer). Power is also available at this socket so that a Sennheiser 04 condenser microphone, omni, cardioid, or ultradirectional, can be connected directly to the transmitter.

Detaching the microphone also reveals the battery compartment which houses an Eveready No. 216 or equivalent dry battery giving 7 hours use, or a nickel cadmium rechargeable battery.

Like its predecessor, the transmitter has a choice of 2 operating frequencies selected by a switch in the side of the case. The audio sensitivity is of course continuously adjustable to suit the user's voice but the audio amplifier includes a compressor circuit to control unexpected signal peaks.

Dieter-Thomas Heck during one of his TV shows.



Technical Data

to hold
ring coil
MD 214
ualizer).
a Senn-
lioid, or
to the

battery
. 216 or
a nickel

choice
witch in
y is of
user's
pressor



In those cases where the transmitter must be hidden under the clothing the dynamic microphones MD 214-1, MD 405 T and the condenser lapel microphone MKH 124 can be connected.



The on-off switch of the transmitter in conjunction with the squelch control of the receiver EM 1008 allows convenient remote control of tape recorders. The very flexible antenna is screwed onto the antenna connector and is therefore secured against accidental removal.



SK 1008

Carrier frequencies	36.7, 37.1 and 37.9 MHz (other frequencies optional)
Frequency drift	≤ 15 kHz (+ 20 ° + 45 ° C, battery voltage down 20 %)
Radiated power	approx. 1 mW
Mode of modulation	FM
Noise deviation	≤ 100 Hz
Audio input sensitivity	1 mW for 40 kHz modulation
Audio frequency response	35 Hz to 20 kHz
Preemphasis	50 μ sec
Harmonic distortion at 40 kHz modulation	≤ 2 %
Power consumption	10 mA
Type of battery	standard 9 volt transistor battery Eveready No. 216 or equivalent
Operating time for one battery	approx. 7 hours
Dimensions (without microphone)	6 x 1.7 x 1.35 in.
Weight (with battery, without microphone)	8 oz

We reserve the right to alter the specifications especially with regards to technical improvements.

Plug-in Microphone Module MD 1008

The dynamic microphone MD 1008 plugs in to the transmitter type SK 1008 making the complete unit appear as a stick microphone. The frequency response of 60 Hz to 14,000 Hz is designed to have a rise of 8 dB above 1,000 cycles. This rise in treble response compensates for the lack in treble when the microphone is used as a Lavalier microphone. The microphone has an omnidirectional characteristic and is impervious to wind noise in exterior locations.



Plug-in Cardioid Microphone MD 4008

The MD 4008 is designed to operate with the SK 1008 transmitter when used in acoustically unfavourable situations, and is designed as an alternative microphone to the MD 1008. The MD 4008 is always used for the stage and for other sound reinforcement systems where loudspeakers are in close proximity to the user. The accurate cardioid characteristic reduces the tendency to feedback. The front to back ratio is approximately 20 dB at 120° and the frequency response is so tailored between 80 Hz to 12,000 Hz that the microphone can be used with the SK 1008 as a Lavalier microphone.



Technical Data

	MD 1008
Transducer type	dynamic
Deviation from nominal curve	± 3 dB
Impedance	700 Ω
Output level	0.25 mV/ μ bar
Directional characteristic	omnidirectional
Dimensions	1.57 x 1.7 x 1.34 in.
Weight	3 oz.

	MD 4008
Frequency range	80 to 12,000 Hz
Tolerance on frequency curve (as a Lavalier microphone)	± 3 dB
Sensitivity at 1,000 Hz	0.2 mV/ μ bar
Electrical impedance	700 Ω
Directional characteristic	super-cardioid
Dimensions	1.57 x 1.7 x 1.34 in.
Weight	3 oz.

We reserve the right to alter the specifications especially with regards to technical improvements.

Receiver EM 1008

This new compact receiver contains virtually every refinement required for a radio microphone. It can be powered from an internal dry battery (Eveready No. 276 or equivalent), a nickel cadmium battery or from 220/117 volt AC line. The dual fitting telescopic aerial allows the receiver to be mounted on a table or on its back on the floor or, if a more elaborate aerial is required, a separate balanced input socket may be used.

The four push-buttons control ON/OFF; channel selection (for rapid switching between two transmitters) and battery test. Besides showing battery voltage the meter gives a continuous indication of signal strength which is particularly useful for the detection of possible "dead spots" in the acting area during rehearsal.

The control beside the meter is an adjustable noise suppressor or "squelch" control which can also be

used to set the "take over" level if two receivers are used for diversity reception. The volume control adjusts only the volume of the internal monitor loud-speaker, the line output being at a fixed level of 1.55 V for 40% modulation.

For difficult situations where the proximity of metal structures may cause dead spots, two separated receivers may be used so that when the signal fades in one receiver, the other is receiving strongly.

The two receivers are interconnected via their diversity sockets, and the squelch controls adjusted so that when the signal in either receiver falls to a preset level, that receiver is muted, and the output is fed automatically from the other receiver.

A third socket gives access to a pair of carrier-operated relay contacts. When the transmitter is switched on, the contacts close to remote control a tape recorder or cue light or other device.

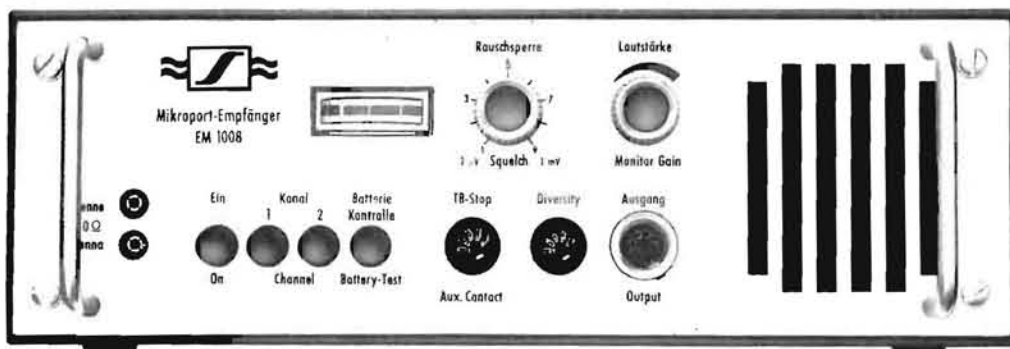

Technical Data

EM 1008

Antenna input 1	60 ohms unbalanced
Antenna input 2	240 ohms balanced
Output voltage at 40 kHz modulation and 5 μ V voltage	1.55 V \pm 2 dB
Output	balanced, ungrounded
Matching load	300 ohms or more
Audio frequency response	50 Hz to 15,000 Hz \pm 2 dB
Harmonic distortion at 40 kHz modulation and 200 μ V antenna voltage	\leq 2%
Signal-to-noise ratio at 40 kHz modulation and 2.5 μ V antenna voltage	\geq 26 dB
At 40 kHz modulation and 20 μ V antenna voltage	\geq 50 dB
At 40 kHz modulation and 50 μ V antenna voltage	\geq 65 dB
Receiving frequencies	36.7 and 37.1 MHz (other frequencies optional)
AFC range	\pm 100 kHz
Channel separation for 4 MHz	\geq 60 dB
Squelch, adjustable	2 μ V to 1 mV (display on field strength meter)
Diversity operation	2 or more receivers have to be connected at the sockets "Diversity"
Remote control	associated equipment can be activated with built in squelch relay contact
Power requirement	110 VAC line or 9 volt battery
Power consumption	2 watts when connected to 110 VAC
Dimensions	11 1/2 x 6 1/2 x 3 11/16 in.
Weight	8.8 lbs.

We reserve the right to alter the specifications especially with regards to technical improvements.

Accessories

Apart from the MD 1008 and MD 4008 already mentioned as microphones for the SK 1008 transmitter, there are two other microphones which may be used. Sennheiser have designed the MD 405 T as a microphone which can be clipped into a pocket of a jacket or the MD 214-1, a Lavalier microphone. A recent innovation is the design of the MK 12 transistorized condenser microphone which when used with the MH 124 unit can be connected directly into the SK 1008 transmitter. The MD 405 T super-cardioid microphone is often used by reporters in television

news work. The smooth frequency response from 100 Hz to 15,000 Hz has a slight rise above 1,000 Hz as is necessary for this type of work. The front to back ratio at 1,000 Hz is approximately 15 dB.

Telescopic Aerial TA 203

This aerial extends to 1.90 m and can be connected directly in either the horizontal or vertical position to the EM 1008 receiver.



Super-cardioid Microphone MD 405 T

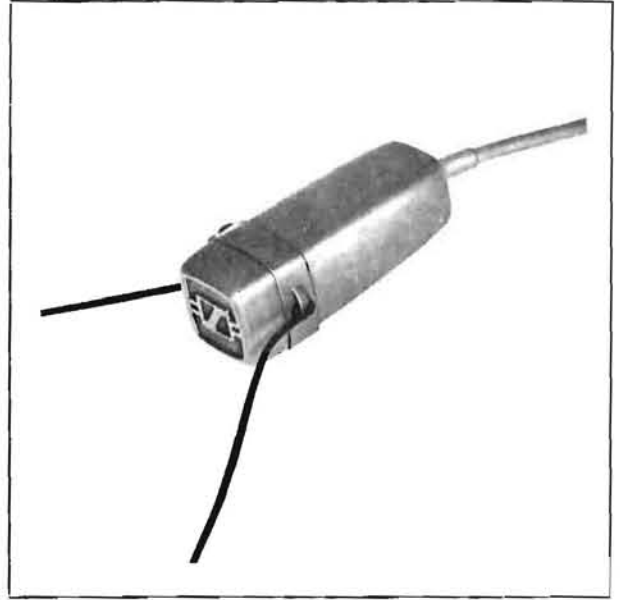

Lavalier Microphone MD 214-1

Technical Data

	MD 405 T
Transducer type	dynamic
Frequency response	100 to 14,000 Hz
Deviation from nominal curve	± 3 dB
Output level	0.15 mV/μbar ± 3 dB
Impedance	200 Ω
Directional characteristic	super-cardioid
Front to back ratio	> 12 db at 150 Hz
Dimensions	1.7 φ x 5.5 in.
Weight	7 oz.

	MD 214-1
Directional characteristic	omnidirectional
Acoustical mode of operation	pressure receiver
Maximum deviation from nominal frequency response	± 2.5 db
Output level	0.2 mV/μbar ± 2.5 dB
Impedance	700 Ω
Magnetic stray interference	8 μV/50 mGauss
Dimensions	3 x 1 1/8 x 1 1/8 in. cord length 33 feet
Weight	5 oz. (without cord)

We reserve the right to alter the specifications especially with regards to technical improvements.

Portable Receiver T 203

The radio microphone receiver T 203 is a lightweight unit and receives its power from a small battery (Eveready No. 226 or equivalent). This unit can be used for monitoring purposes. The audio output can be varied by a volume control built into the top of the T 203, and with only a maximum output of 2 V the stetoset earpiece can be connected via the miniature jack socket in the top panel. Amplifiers and tape recorders can also be connected to the T 203 by the same miniature jack socket.

According to the mode of operation you can use two types of aerial. A telescopic aerial normally supplied with this unit at extra charge or an aerial built into the shoulder carrying strap can be used. The volume control also serves as the on-off switch and next to the aerial input is the channel selector switch offering selection between channel 1 and channel 2 (receiver frequencies 36.7 MHz and 37.1 MHz). The batteries used for this unit are 9 V dry batteries or a 7.5 Deac rechargeable cell. The radio receiver T 203 is normally supplied at the frequencies mentioned but special frequencies are available on request.



Technical Data

T 203

Antenna input	60 ohms unbalanced
Output	unbalanced, nominal load 2000 ohms
Output voltage at 40 kHz modulation and antenna voltage exceeding 5 μ V	1 volt, adjustable
Frequency response	100 Hz to 15 kHz
Tolerance of nominal audio response curve	± 2 dB
Harmonic distortion at 40 kHz modulation and 200 antenna voltage for 1 V audio output	$\leq 3\%$
Signal-to-noise ratio at 40 kHz modulation and an antenna voltage of $> 20 \mu$ V	≥ 50 dB
Receiving frequencies	36.7 and 37.1 MHz (other frequencies optional)
Selectivity for a channel raster of 0.4 MHz	approx. 50 dB
Type of battery	9 volts Eveready No. 226 or equivalent
Operating time for 1 battery	approx. 20 hrs.
Dimensions	1.3 x 3.4 x 4.7 in.
Weight	12.5 oz. with battery

We reserve the right to alter the specifications especially with regards to technical improvements.

Product Group 8 Audio Transformers

A comprehensive program of transformers has been developed by Sennheiser electronic for all conceivable uses.

On the left of the table you will find the list showing the type and grouping, e. g. broad band or miniature transformers. You can find the desired type of construction horizontally at the top of the table. If you are looking for example, for a transformer for printed circuits, which must be shielded, you can find the TM 005 under the miniature transformers.

The main possibilities for using the various transformers are indicated by means of the letters **E, Z** and **A**.

E = Input, **Z** = Inter Stage and **A** = Output.

Those which are additionally marked "I" indicate that this type of construction is **for industrial use only** in very large quantities. There is no standard form of construction for these transformers.

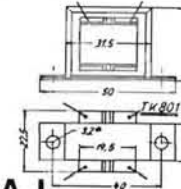
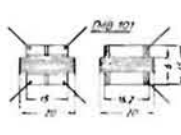
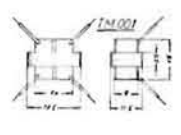
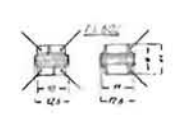
Type	Standard construction and remarks	Unencapsulated, unscreened
TK Small Transformer and TB Broad Band Transformer	These are small unshielded transformers for industrial use only. Broad Band Transformer Standard Construction: Input Transformer TB 432	 A, I
TMB Broad Band Miniature Transformer	Interstage and Output Transformer for industrial use only. Standard Construction: Input Transformer TMB 103	 E, Z, A
TM Miniature Transformer	Interstage and Output Transformer for industrial use only. Standard Construction: Input Transformer TM 003	 E, Z, A
TS Sub-Miniature Transformer	Production for use in industry only in accordance with special requirements.	 Z, A, I

Technical Data for the Standard Construction (Input Transformers)

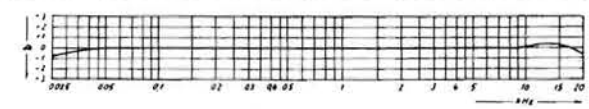
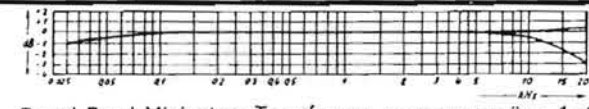
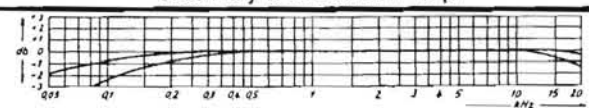
Type	Frequency Curves
TB 432	 Broad Band $\bar{u} = 1 : 30$, Source Impedance 200 Ω secondary load 500 k Ω // 10 pF
TMB 103	 Broad Band Miniature Transformer, upper curve $\bar{u} = 1 : 15$ lower curve $\bar{u} = 1 : 25$, Source Impedance in both cases 200 Ω secondary load 500 k Ω // 10 pF
TM 003	 Miniature Transformer, upper curve $\bar{u} = 1 : 15$ lower curve $\bar{u} = 1 : 30$, Source Impedance in both cases 200 Ω secondary load 500 k Ω // 10 pF
TB 501 TM 514 TM 513	20 . . . 20,000 Hz, secondary load 500 k Ω // 10 pF 45 . . . 20,000 Hz, secondary load 500 k Ω // 10 pF 50 . . . 20,000 Hz, secondary load 500 k Ω // 10 pF

Unencapsulated, unscreened	Unencapsulated, for printed circuits	Hermetically sealed for printed circuits	Magnetically screened for printed circuits	Magnetically screened for outer chassis mounting	Magnetically screened for inner chassis mounting	Cable Transformers
 A, I	 A		 TK TB	 E		 E TB 501
 E, Z, A	 Z, A, I	 Z, A, I		 E	 E, I	 E TM 514 N TM 514 HL E TM 513
 E, Z, A	 Z, A, I	 Z, A, I	 E, I	 E	 E, I	
 Z, A, I	 Z, A, I	 Z, A, I	Special Types. Transformers with other adaptations and adjustments can be developed and manufactured on request but only in suitable quantities. We would ask you for the sake of speed in dealing with your request to use our Transformer Questionnaire Form, or if not to hand, to ask for some of these.			

rmers)

	Ratio	Source Impedance	Primary Inductance	Coil Resistance	Connections
 Source 200 Ω F	1 : 15 1 : 30	200 Ω 200 Ω	1,7 H 1,7 H	16 Ω 16 Ω	
 Curve $\bar{u} = 1 : 15$ both cases 200 Ω	1 : 15 1 : 25	200 Ω 200 Ω	2,1 H 1,8 H	60 Ω 45 Ω	Primary: grey and green lead Secondary: blue lead (ground) red lead (input)
 $\bar{u} = 1 : 15$ both cases 200 Ω	1 : 15 1 : 30	200 Ω 200 Ω	1,5 H 0,4 H	180 Ω 90 Ω	Primary: grey and green lead Secondary: blue lead (ground) red lead (input)
2 // 10 pF 2 // 10 pF 2 // 10 pF	1 : 20 1 : 16 1 : 20	200 Ω 200 Ω 200 Ω	≈ 1,7 H ≈ 0,8 H ≈ 0,9 H	16 Ω 45 Ω 140 Ω	

Product Group 9 Studio Equipment

Transmitter SER 1 and Receiver ER 2

The SER 1 transmitter and ER 2 receiver are widely used in television and broadcasting stations throughout the world. Both transmitter and receiver are supplied in a practical rugged leather carrying case. The shoulder strap aerial can be used efficiently for television and film news work. The performance of both units meet the highest broadcast standards.

Several transmitters and receivers may be linked together and provided that adequate aerials are used, transmission can be obtained over considerable distances.

The transmitter SER 1/1 is manufactured with a smaller frequency swing which allows 50 kHz channel raster.



Technical Data

SER 1

Transmitting frequency	2 frequencies in the range 25 to 110 MHz, maximum spacing 0.5 MHz
Transmitting power	1 W with 15 V battery voltage (7.75 V at 60 Ω)
Frequency stability (temperature - 10 °C to + 40 °C and ± 10 % battery variation)	3×10^{-3}
Aerial socket	60 Ω co-axial (Amphenol)
Modulation	FM, maximum ± 75 kHz deviation (150 F 3) or ± 15 kHz (50 F 3)
Noise frequency deviation, measured to DIN 45 405, and with 50 μsec de-emphasis	≤ 100 Hz
Inputs for microphone and line	for 200 Ω impedance
Microphone input	max. 0.8 mV for 40 kHz deviation (8 kHz deviation)
Sensitivity, variable	for 200 Ω impedance
Line input	≥ 3 kΩ
Input impedance	1.55 V for 40 kHz deviation (8 kHz deviation)
Sensitivity	operates on both inputs
Limiting range	≥ 30 dB
Normal frequency deviation	± 40 kHz (± 8 kHz)
Maximum frequency deviation	± 70 kHz (± 13.5 kHz)
Audio frequency range	80 Hz to 18 kHz $\begin{matrix} +1 \\ -2 \end{matrix}$ dB
Distortion	
at 40 kHz deviation (8 kHz)	≤ 1 %
at 20 dB overload	≤ 2 %
Supply voltage	12 - 16 V
Power consumption	approx. 250 mA
Accumulator	15 V, 1 Ah
Operating life	3 to 4 hrs (down to - 10 °C)
Meter functions	for battery voltage, carrier frequency, RF output voltage, frequency deviation
Dimensions with battery case	170 x 135 x 65 mm
Aerial	steel tape aerial 80 cm long or 3/4 aerial in strap of leather carrying case
Weight without battery	1.2 kg
Weight of the battery case	0.9 kg

We reserve the right to alter the specifications especially with regards to technical improvements.

ER 2

Receiving frequency	2 frequencies in the range 25 to 110 MHz, max spacing 0.5 MHz
RF input	60 Ω co-axial (Amphenol)
Frequency stability	3×10^{-3} , crystal controlled
Receiver system	double superhet
1. intermediate frequency	10.7 MHz
2. intermediate frequency	470 kHz
Demodulator	counting circuit
Modulation	± 75 kHz deviation (150 F 3)
Sensitivity at 40 kHz deviation	better than 2 μV for 26 dB S/N
Adjacent channel rejection at 0.3 MHz spacing at 40 kHz deviation	≥ 55 dB
Image rejection of 2. IF	≥ 60 dB
Image rejection of 1. IF	≥ 70 dB
Squelch	switched audio output
Squelch level	adjustable 0 . . . 5 μV
Audio frequency range	30 Hz to 20 kHz ± 2 dB
Distortion at 40 kHz deviation	≤ 1 %
Audio frequency output	matching impedance 300 Ω, balanced and ground free, Tuchel T 3082
Output impedance	approx. 50 Ω
Output voltage	1.55 V for 40 kHz deviation
Headphone output	R _i = 1 kΩ
Meter functions	battery voltage, RF input voltage, squelch level, audio output combined with on-off switch
Function switch	
Supply voltage	12 - 16 V
Power consumption	50 mA
Operating life	approx. 20 hours
Accumulator	15 V, 1 Ah
Dimensions with battery case	170 x 136 x 65 mm
Weight of the receiver	1.1 kg
Weight of the battery case	0.9 kg

We reserve the right to alter the specifications especially with regards to technical improvements.

Receiver ER 3

The ER 3 is a transistorized receiver with narrow frequency deviation. The unit which in appearance and dimensions is similar to the well known ER 2 can be successfully used for 50 kHz channel raster. The receiver is normally laid out for the two frequencies of 77,53 and 77,59 MHz.

The ER 3 differs from the ER 2 in that it employs a 46 kHz band pass mechanical filter in the second I. F. amplifier.

The ER 3 which similarly to the SER 1 and ER 2 is delivered with leather carrying case, can be fitted with a shoulder strap antenna for portable use.



Technical Data

ER 3

Receiving frequency	2 frequencies in the range of 25 to 110 MHz max. distance between channels 0.5 MHz, preferably 77.53 and 77.59 MHz
RF input	60 Ω coaxial (Amphenol)
Frequency stability	3×10^{-4} , crystal controlled
Type of receiver	double superhet
1. I. F.	10.8 MHz
2. I. F.	455 kHz
Demodulator	counting circuit
Modulation	± 15 kHz deviation
Sensitivity at 8 kHz deviation	better than 2.5 μ V for 26 dB S/N
Selectivity at 8 kHz deviation and 40 kHz channel raster	80 dB
Image rejection of 2 I. F.	70 dB
Image rejection of 1 I. F.	80 dB
Squelch	switches audio output relay
Squelch level	adjustable 0 5 μ V
Audio frequency range	30 Hz 12 kHz ± 3 dB
THD at 8 kHz frequency deviation	$\leq 3\%$
Audio frequency output	matching impedance 300 Ω, balanced, groundfree; Tüchel T 3082 approx. 50 Ω
Source impedance	1.55 V for 8 kHz frequency deviation
Audio output level	$R_i = 1$ kΩ
Headphone impedance	battery voltage, R. F. input voltage, squelch level, audio output, combined with on-off switch
Meter functions	12 - 16 V
Supply voltage	50 mA
Power consumption	operating time, fully charged
Operating time, fully charged	approx. 20 hours
Accumulator	15 V, 1 Ah
Dimensions with battery case	170 x 136 x 65 mm
Weight of the receiver	1.1 kg
Weight of the battery case	0.9 kg

We reserve the right to alter the specifications especially with regards to technical improvements

Studio Pocket Transmitter SK 1007

Sennheiser has been manufacturing radio microphones designed particularly for studio applications over the past ten years. The experience gained over this period of time has been combined with new design techniques to develop the studio pocket transmitter SK 1007.

The SK 1007 transmitter has a high output and weighs only 14 oz. Because of its extremely slim shape it can be easily concealed in the pocket of a suit. Sennheiser dynamic microphones and RF transistorized condenser microphones can be connected to the SK 1007 by means of a 6 pin Tuchel connector. The MK 12 condenser capsule can be connected to the SK 1007 transmitter via a sub-miniature coaxial connector built into the top panel. The transmitter contains the

necessary crystal controlled oscillator which is part of the circuitry of the MK 12 microphone.

The circuit of the SK 1007 is comprised of a four-stage RF section, an eight-stage audio frequency section and a voltage stabilizer. The circuitry is constructed from silicon planar transistors. The unit allows low noise broad band frequency modulation. The audio frequency amplifier is a limiter amplifier, that is the limiter becomes operative when the audio level produces a deviation of 40 kHz. An increase in level of 15 dB produces a frequency change of only 3 dB. This means in effect that it is practically impossible to overload either the transmitter or the receiver. The quality and technical data of the SK 1007 meets the most stringent studio requirements. The power supply for the transmitter is obtained from three Eveready No. 216 9 V batteries.



Technical Data

SK 1007

Carrier frequency (as ordered)	specify 36.7 or 37.1 MHz (other frequencies between 30 and 45 MHz optional)
Carrier stability	$\leq \pm 15$ kHz, at temperatures 50 °F ... 102 °F
RF output power	100 mW
Effective radiated power, ERP	approx. 10 mW
Type of modulation	FM
Noise modulation	≤ 100 Hz
AF-input - minimum (modulation control open)	0.5 mV for full modulation
Pre-emphasis	50 microseconds
Distortion	$\leq 1\%$
Power supply	3 batteries 9 V (Eveready No. 226 or equivalent)
Power consumption	AF-section approx. 10 mA, RF-section approx. 20 mA
Operating time	approx. 3 hours for one set of carbon-zinc batteries
Usable distance	1000 feet average, depending on local conditions
Dimensions	1.3 x 3.4 x 4.7 inches
Weight	approx. 14 ounces

We reserve the right to alter the specifications especially with regards to technical improvements.

Portable Mixer M 101

The portable mixer M 101 is designed for use with the Nagra and other professional-type tape recorders. The total unit is only 347 x 233 x 126 mm and weighs only 6 kg and, therefore, when used with a portable tape recorder offers the sound recordist a very lightweight versatile system.

The power supply is from two built-in 9 V batteries which with intermittent working will allow for more than 30 hours battery life. Alternatively, the power may be supplied to the mixer from the Nagra tape recorder. The M 101 has four balanced microphone inputs each having a sensitivity of 0.1 mV. The inputs will accept dynamic microphones, conventional condenser microphones and Sennheiser "05" series RF transistorised microphones in which the power to the microphone is fed through the microphone cable. The M 101 is most versatile when Sennheiser RF condenser microphones powered directly from the mixer are used.

The input sensitivity of each microphone channel can be switched in three steps of 20 dB and the input impedance will remain almost unchanged. A further attenuator in the amplifier is operated by a smooth control allowing a further attenuation of 20 dB, therefore, the total attenuation possible on each channel is a maximum of 80 dB. The maximum input is + 6 dB. Immediately after the attenuator the input is balanced by a transformer connected to the first low noise transistor. Each channel has a bass cut filter fitted which operates from 100 Hz at approximately 10 db per octave.

In order that the M 101 can operate over a wide

temperature range and to ensure a low consumption of power, the input stages of each panel are fitted with low noise silicon planar transistors. The overload capability of the input stage is approximately 26 dB and the summing amplifier has an adequate overload reserve. The final stage of each channel has an overload factor of approximately 6 dB.

The outputs of the four microphone channels are fed to one master slide-fader. The junction is fed via a buffer amplifier and a coupling resistor. The junction is brought out to a socket to allow the possibility of connecting a second mixer in parallel to give eight channels. The junction signal is fed through the main fader to the summing amplifier. The tone controls in the summing amplifier can, if required, also be switched into the fourth microphone channel.

The output comes from the push-pull amplifier with a very low output impedance. The output level is + 6 dB at an output impedance of 200 Ω . For coupling to installations the control instrument ML 101 has been provided with a symmetrical transformer which can also give an output of + 15 dB at 600 Ω . The output voltage is measured by a peak reading meter which is capable of being switched to read battery volts.

The built-in 1 kHz oscillator provides line-up tone controlled by the master slide-fader and its level is shown directly on the meter. A switch situated on every microphone channel makes it possible to pre-fade listen, if the mixer is used in conjunction with the ML 101.

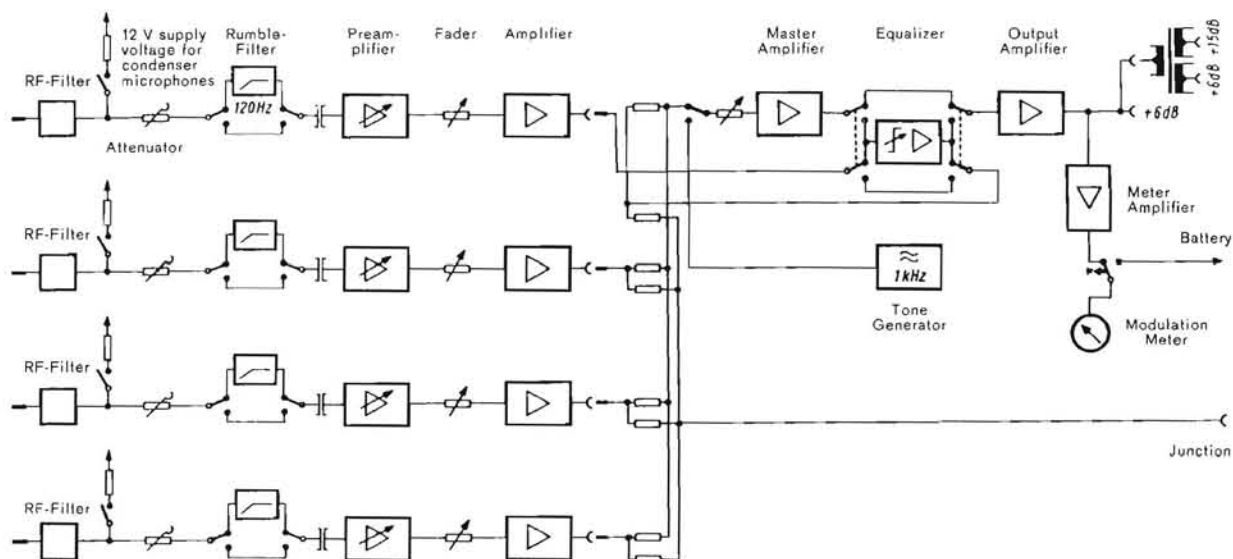

Technical Data

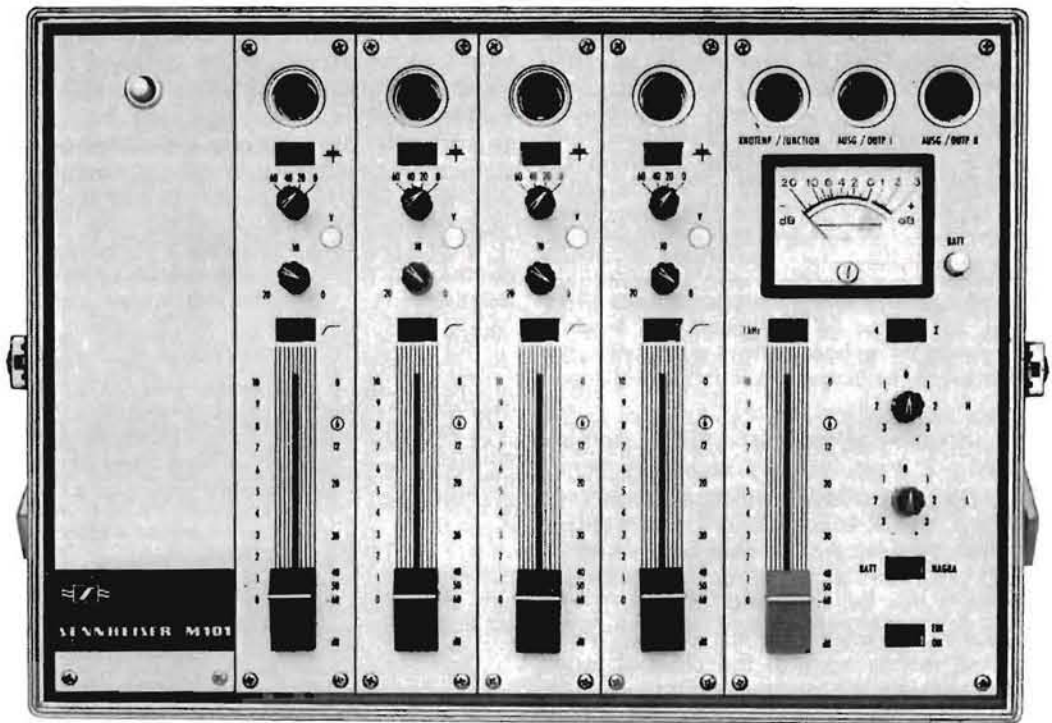

M 101

Inputs	4, balanced
Input sensitivity	0.1 mV
Input attenuator	4 position, switched in 20 dB steps and variable 20 dB, gliding control in feedback circuit of first amp. stage
Input impedance	120 Hz ... 12 kHz ≥ 1 k Ω 40 Hz ... 15 kHz ≥ 400 Ω with attenuator = 1.8 k Ω 40 Hz ... 15 kHz ≥ 60 dB - 3 dB at 120 Hz - 10 dB/octave below 100 Hz in each input switchable unbalanced + 6 dB at 60 Ω
Input symmetry	≤ 4 Ω
High-pass filter switchable in each input	40 ... 15,000 Hz ± 1.5 dB 0.5% 60 Hz ... 15 kHz (+ 6 dB at output into 200 Ω) 1% 60 Hz ... 15 kHz (+ 12 dB at output into 200 Ω)
Power for condenser microphones	approx. 3 dB
Output	rise time 90% of full scale 30 ms, decay time 1.4 sec.
Output impedance	frequency 1 kHz ± 10 %, distortion ≤ 1 %, level adjustable by main fader
Frequency response	treble ± 12 dB at 15 kHz bass + 10 dB - 14 dB at 40 Hz
Distortion	- 20 $^{\circ}$ C to + 50 $^{\circ}$ C
Noise figure	347 x 233 x 126 mm
Peak level meter	Batteries 2 x 9 V Eveready No. 276 or equivalent
Line up oscillator	Current drain 40 mA for full output
Tone controls switchable, summing amplifier or channel 4	Battery life with intermittent use ≥ 30 hours with 4 condenser microphones approx. 15 hours
Operating temperature range	6 kg
Dimensions	
Batteries	
Current drain	
Battery life with intermittent use	
Weight with batteries	

We reserve the right to alter the specifications especially with regards to technical improvements.

Mixer Monitoring Unit ML 101

In order to extend the versatility of the 4 channel mixer M 101, the control accessory ML 101 was designed. The combination of instruments M 101/ML 101 offers extensive operating and controlling facilities, which previously were only available in large fixed installations. It permits direct and off-tape monitoring as well as pre-fade listening by means of headphones or the built in loudspeaker. Cues can be added to the material to be recorded or instructions can be given separately to the headphones of the cameraman etc.

The control unit contains two 4-watt amplifiers. With one of these, according to requirements, a wide range loudspeaker or a headphone outlet can be operated. This amplifier serves various control functions:

1. The output signal of the mixer M 101 can be monitored.
2. Through simple switching off-tape monitoring is possible. For this functions 2 symmetrical ground-free tape recorder inputs are available. With a preset control, the direct and off-tape signal levels can be balanced.
3. The signal at the input of a microphone channel can be monitored with the channel fader down by pushing the corresponding pre-fade button.

The second amplifier feeds 2 parallel switched headphone outputs. Through these it is possible to listen to the output of the mixer, or for example to give directions to a cameraman or interviewer. When used in this way, the built in loud speaker acts as a microphone. There is a button to carry out this operation. All this results in a simple talk-back installation.

Connecting between the output of the ML 101 and the junction point of the M 101, comments from the sound recordist can be recorded directly on tape using the internal loudspeaker switched to act as a microphone.

The ML 101 also contains a transformer which provides a balanced output from the output amplifier of the mixer. This transformer has two secondary windings giving levels of + 15 dB and + 6 dB. The + 6 dB winding is fed to be 3 pin large Tuchel connector and the + 15 dB output to two screw terminals.

When using two mixers connected in parallel via the junction points, the links from the two mixers are fed to the two junction sockets on the ML 101. The ML 101 has the same dimensions as the mixer. It can be powered either by built-in batteries (2 x 9 V PP 9) or from the Nagra tape recorder. The supply voltage can be adjusted by means of a small control.



Technical Data

ML 101

Inputs

1. Two inputs for connection to M 101	unbalanced
Sensitivity	1.55 V
Input impedance	5 kΩ
2. Two inputs for pre-fade listen	unbalanced
Sensitivity	80 mV
Input impedance	120 kΩ
3. Two inputs for off-tape monitoring	balanced, ground free
Sensitivity	300 mV adjustable
Maximum allowable input level	2 V
Impedance	20 kΩ

Outputs

1. Record outputs	balanced, ground free
Output level 1	+ 6 dB at 200 Ω
Output level 2	+ 15 dB at 600 Ω
2. Headphone outputs	unbalanced
Output level	4 V variable
Minimum load impedance	4 Ω
Operating temperature range	- 20 ° C to + 50 ° C
Current drain	35 mA
Dimensions	347 x 233 x 126 mm
Batteries	2 x 9 V Eveready No. 276 or equivalent
Weight with batteries	6 kg

We reserve the right to alter the specifications especially with regards to technical improvements.

Studio Monitors VKL 303-1 and VKL 303-4



The VKL 303 combined amplifier loudspeaker units are useful for studio monitoring and high quality sound reproduction in control rooms. Their high power combined with high sound quality make them ideal for playback purposes and high fidelity sound reinforcement systems.

To overcome the difficulties usually associated with the bass response of compact loudspeakers an integrated design of amplifier and loudspeaker has been used.

At frequencies below the natural resonance of a loudspeaker system there is a fall in response of 12 dB per octave. In a compact loudspeaker the resonance frequency tends to be inconveniently high and occurs well within the audio band (the frequency of resonance is determined by the mass of the loudspeaker diaphragm and the volume of the enclosed air). In the diagram below curve 1 indicates the fall-off for a large enclosure volume and curve 2 that for a smaller volume.

Various means may be used to modify the frequency response in the region of the natural response frequency. The output impedance may be lowered or

raised to give more or less electro magnetic damping of the voice coil. For a good transient response a relatively low output impedance of the amplifier is required.

A technique which has frequently been used is to increase the mass of the loudspeaker diaphragm to give extended bass response. The extension of response is only gained at the expense of sensitivity. Curves 3 and 4 in the diagram illustrate this effect. Curve 3 represents a loudspeaker with a heavy diaphragm. Curve 4 shows a comparable response for a lighter weight diaphragm. As one can see the penalty for increased bass response is loss of sensitivity throughout the whole of the rest of the frequency range.

Since the VKL 303 is an integrated unit of amplifier and loudspeaker an alternate method of frequency range extension can be used. The low frequency resonance is not artificially lowered but is allowed to lie within the audio spectrum. The transient response is controlled by a suitable choice of output impedance of the amplifier and the frequency response is controlled by electrical equalization of the amplitude and phase response of the amplifier.



To what extent this method has been successful can be seen from the frequency response curve and the oscillograms below. For the tone burst tests the loudspeaker was sunk into the ground in the open air with its diaphragm flush with the earth, radiating in an upwards direction. The measuring microphone was placed approximately two meters above the loudspeaker. The upper oscillograms show the bursts of tone applied to the input of the amplifier, the lower oscillograms show the amplified output of the microphone. The frequency response diagram shows also the harmonic distortion of the loudspeaker. The measurements were made using $\frac{1}{3}$ octave band filters. The sound pressure was $12 \mu\text{bar}$ at a distance of 1 meter from the loudspeaker.

The acoustical properties of the listening room and the sitting of the loudspeaker within the room affect

the reproduction of the low frequencies to a large degree. The output amplifier has, therefore, variable equalization which can be switched to suit the situation.

The built-in 30 W amplifier has a transformerless output stage with heavy negative feedback so that the distortion, even at 25 W, amounts to less than 0.2%. All parts requiring to be cooled are mounted on a heavy, cast aluminium plate with cooling fins. By this means cooling slots are rendered totally unnecessary and the amplifier remains completely free of dust.

The power reproducer is offered in two different finishes. The VKL 303-1 has a walnut housing. The exterior of VKL 303-4 is covered in light grey Hornitex and is additionally provided with carrying handles and easy-run casters.

Dimensions 10 x 16 x 26 inches
without casters
Weight approx. 48 lbs.

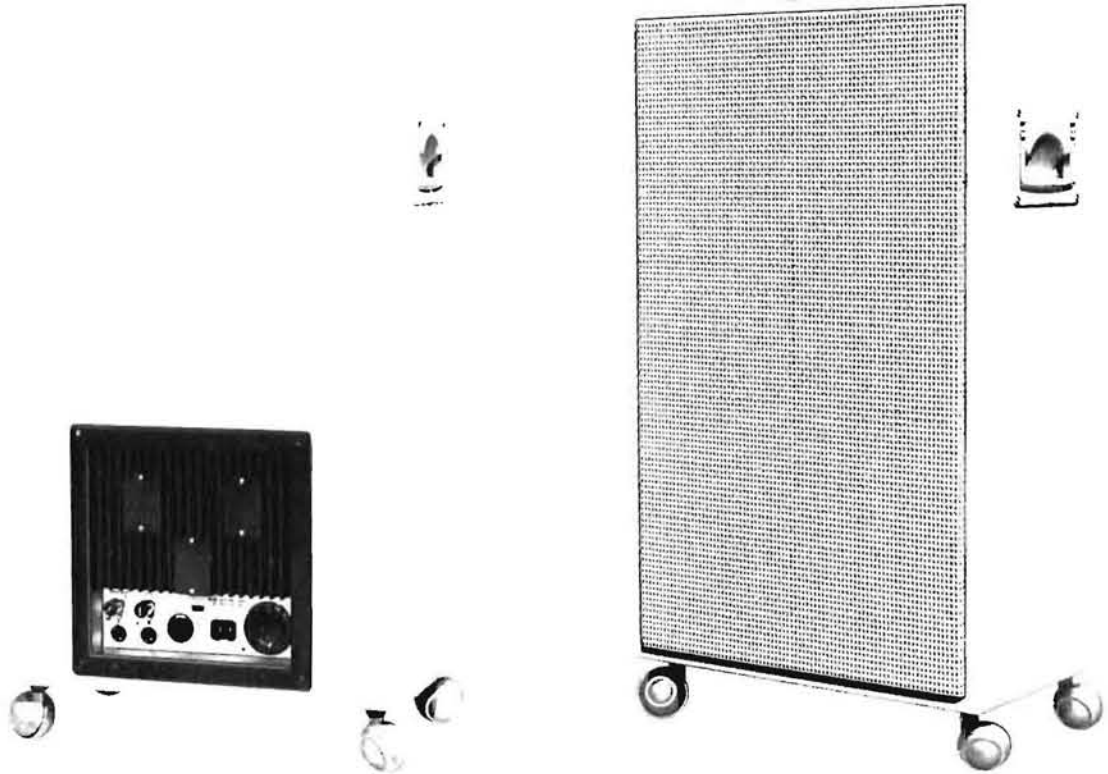

Technical Data

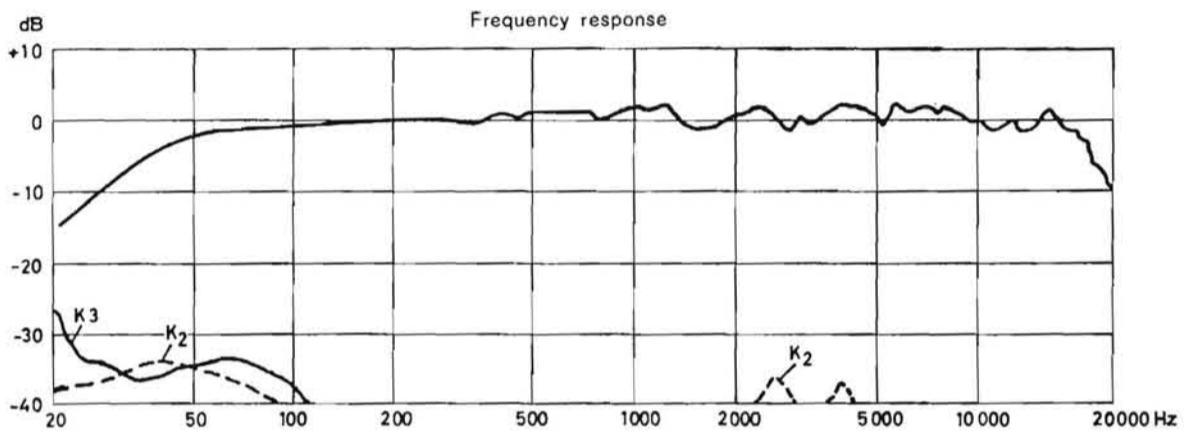
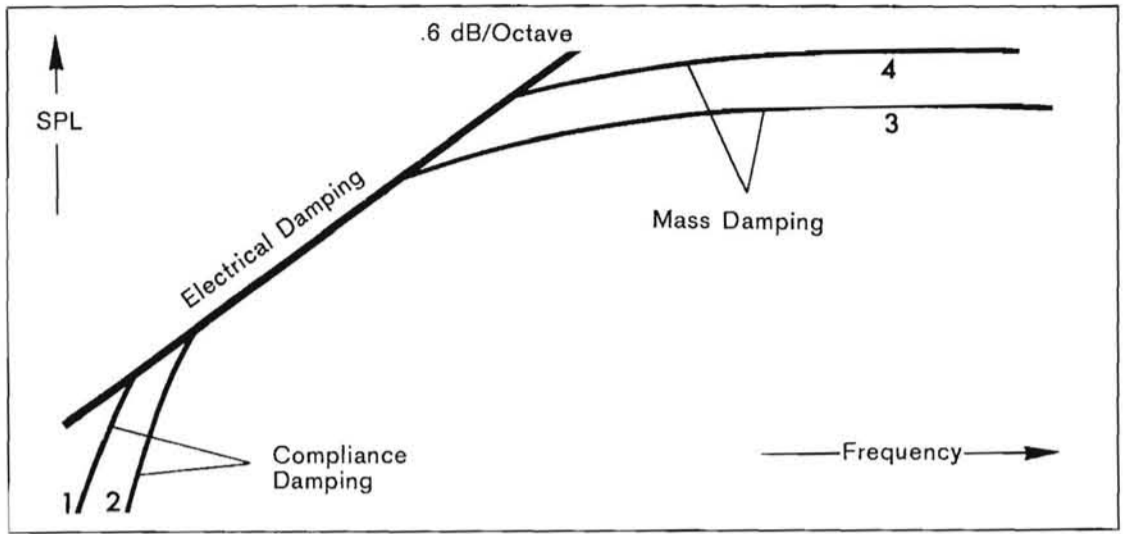

60 Hz

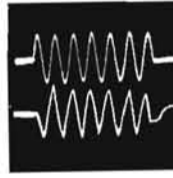

125 Hz

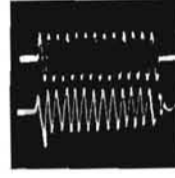

250 Hz

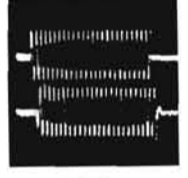

500 Hz

Transient response

VKL 303-1 and VKL 303-4

Input impedance	$\geq 20 \text{ k}\Omega$
Input sensitivity	+ 6 dB for full output variable
Output power continuous sine wave of the amplifier	approx. 30 W
Maximum pressure at 1,000 Hz at a distance of 1 m	approx. 100 μbar
Power consumption quiescent	7 W
Power consumption full output	70 W
Dimensions	24 x 40 x 65 cm without wheels
Weight	approx. 48 lbs.

We reserve the right to alter the specifications especially with regards to technical improvements.

Product Group 10 Audio Test Equipment

Sennheiser Audio Test Equipment is widely used throughout all the major acoustic laboratories in Europe. In some gramophone and tape recorder companies the Sennheiser range of test equipment has become a standard. Many service departments in radio and television stations also use this equipment for testing and alignment purposes.

The first reason for the standardisation on this test equipment is mainly economical. It is essential that the design engineer, service technician and inspection departments all operate with the same make and type of equipment in order to guarantee a constant quality throughout the whole production.

Sennheiser test equipment is manufactured to very fine tolerances, which is essential when two or three units of the same type are used in one laboratory. A piece of equipment manufactured and tested at

the factory on one set of test apparatus must meet the same stringent tolerances when tested by the user on his own audio test equipment.

The test equipment is neat in appearance and all controls and push buttons are fitted on the front panel. Each unit is so designed to enable vertical stacking of a few units. This gives the operator the total range of test equipment within easy reach, as illustrated below.

In this illustration the RV 55 Voltmeter, FO 55 Weighting Network and Filter unit, and KB 55 Harmonic Distortion Bridge are being used to check the quality of a tape recorder.

The following pages give detailed descriptions and technical data of all the Sennheiser Audio Test Equipment.



Vacuum Tube Voltmeter RV 56

The RV 56 has emerged out of the successful predecessor the model RV 54. The band width of amplifier and meter is now 10 Hz to 1 MHz with a maximum sensitivity of 1 mV for full scale deflection. The twelve overlapping ranges selected by push-buttons combined with a large meter ensure ease of operation and error-free readings.

The meter has two voltage scales 0 to 10 and 0 to 30 so that whichever sensitivity setting is in use, the meter reading need only be multiplied by a power of ten. Similarly the range selection switches are in steps of 10 dB so that measurement on the decibel scales is equally simple. For extra simplicity of observation, two dB scales are fitted. The dbm scale is related to a zero at 0.775 V (voltage equivalent of 1 mW in 600 Ω). The dbv scale relates to zero at 1 Volt.

The input signal passes first through a high impedance voltage divider, a cathode follower amplifier and second voltage divider. In the succeeding 4 stage high stability amplifier the signal is amplified

to approximately 5 V. for full scale deflection of the meter. The rectifying system responds to the average value of the input signal. The meter is calibrated in RMS values for a sine-wave input.

The instrument is exceptionally stable due to the use of heavy negative feedback and an electronically stabilized power supply.

For recalibration purposes a zener-stabilized alternating voltage is applied to the amplifier input by a push-button.

The RV 56 meter may be used simultaneously as a measuring instrument and wide band amplifier. The output socket has a source impedance of 600 Ω, for connection to an oscilloscope or headphones.

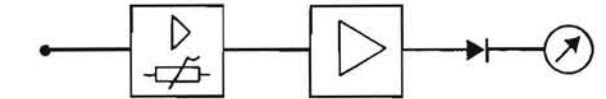

Block Diagram

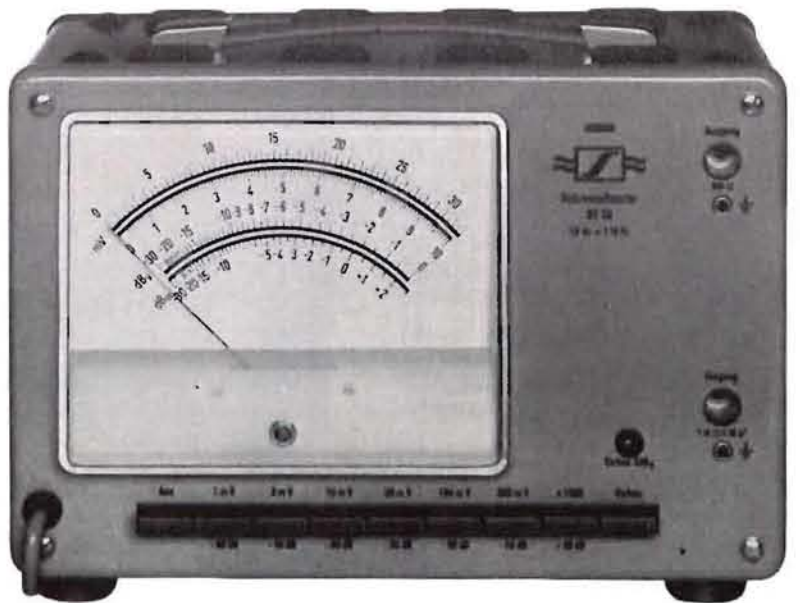

GZL 55



An interconnecting cable for all Sennheiser measuring equipment. The shielded cable is fitted with two 13 mm coaxial connectors.

Technical Data

RV 56

Measuring range	0 . . . 1/3/10/30/100/300 mV 1/3/10/30/100/300 V - 90 . . . + 50 dBv - 90 . . . + 52,5 dBm
Frequency range	10 Hz . . . 1 MHz
Measurement error	20 Hz . . . 200 kHz ≤ 3 % f. s. d. 10 Hz . . . 1 MHz ≤ 5 % f. s. d.
Input impedance	1 MΩ 30 pF
Max. superimposed DC at the input	400 V
Output impedance	600 Ω nominal
Output EMF	0.3 V nominal
Power supply	50 . . . 60 Hz 115, 220 V ± 10 % 40 VA nominal
Valves	4 x EF 80, 2 x EF 184, EL 86, 85 A 2
Dimensions	296 x 197 x 165 mm
Weight	approx. 14 lbs.

We reserve the right to alter the specifications especially with regards to technical improvements.

Vacuum Tube Voltmeter RV 55

By virtue of its wide frequency range (10 Hz – 1 MHz), high sensitivity, choice of rectifying system and filter insertion facilities, the RV 55 is a uniquely versatile laboratory instrument.

By push-button selection the instrument will measure true RMS values, (for accurate indication of noise voltage, distortion factor or impulsive signals) or alternately the peak value of the applied signal to DIN standard 45 505.

The two coaxial jack sockets enable any required filters to be inserted in the measuring chain at a constant high voltage level and between fixed impedances.

The integration time of the meter circuit may be altered by push-button selection in both RMS and peak indicating mode.

As with the RV 56 the selection of the twelve sensitivity ranges by push-button together with the large easily read meter scales allow comfortable operation and error free readings.

There are two voltage scales 0 to 30 and 0 to 10 and two dB scales. The dBm scale is related to a zero at 0.775 V (voltage equivalent of 1 mW in 600 Ω). The dBv scale relates to zero at 1 V.

The test signal is available at the output socket at 600 Ω impedance for connecting to an oscilloscope or our headphone HD 414.

For recalibration purposes a zener stabilised alternating voltage is applied to the amplifier input by a push-button (Eichen).

Block Diagram

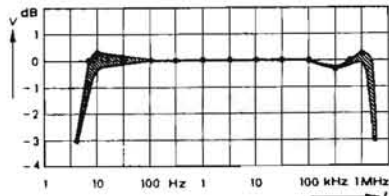
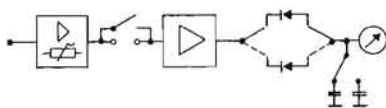

Frequency response RV 55 and RV 56

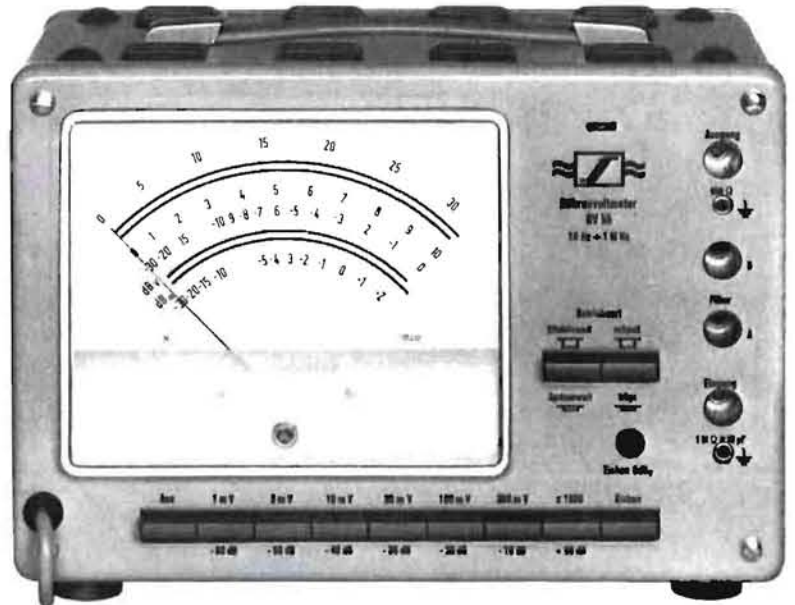

Technical Data

RV 55

Measuring range	0 ... 1/3/10/30/100/300 mV, 1/3/10/30/100/300 V -90 ... +50 dBv, -90 ... +52,5 dBm
Frequency range	10 Hz ... 1 MHz
Measurement error for sine waves peak or RMS measurement	20 Hz ... 200 kHz ≤ 3 % f. s. d. 10 Hz ... 1 MHz ≤ 5 % f. s. d. 20 Hz ... 100 kHz ≤ 5 % f. s. d.
Measurement error for impulsive signals with peak to mean ratio up to 10 : 1, for both measuring methods	fast "Schnell": 500 msec approx. slow "Träge": 1.5 sec approx.
Integration time for RMS measurement	fast "Schnell": DIN 45 405 slow "Träge": Electrical time constant increased by a factor of 5
Integration time for peak measurements	1 MΩ 30 pF
Input impedance	400 V
Maximum superimposed DC at the input	600 Ω approx.
Output impedance	0.3 V approx.
Output EMF	600 Ω approx.
Output impedance at the filter socket	80 mV approx. for f. s. d.
Output EMF at the filter socket	1 MΩ approx.
Input impedance of the filter socket	50 ... 60 Hz, 115, 220 V ± 10 %
Power supply	40 VA approx.
Valves	2 x PCC 88, 2 x EF 80, 2 x EF 184, EL 86, 85 A 2
Dimensions	296 x 197 x 165 mm
Weight	approx. 14 lbs.

We reserve the right to alter the specifications especially with regards to technical improvements.

Harmonic Distortion Bridge KB 55

The Harmonic Distortion Bridge is a passive unit designed as an accessory for the sensitive vacuum tube voltmeter RV 55. The KB 55 can also be used with other true RMS reading vacuum tube millivoltmeters having an input impedance greater than 1 MΩ and a sufficiently wide bandwidth.

The KB 55 is designed for fundamental frequencies of 40, 100, 1,000, 6,300 and 12,500 Hz to DIN standard.

The combination of RV 55 and KB 55 permits the measurement of distortion factors from 0.05 % to 30 %. The bridge may be tuned over a range of ± 10 % for frequencies which differ from the nominal values. Measurement error using a true RMS reading meter is better than 0.5 %.

The KB 55 Bridge uses a double T filter for the suppression of the fundamental frequency, followed by an equalizer. By this means the transfer coefficient is maintained correctly from the second to the tenth harmonic. For fundamental frequencies of 400 Hz and above a high-pass filter is incorporated to attenuate hum voltages.

Measurement of the Distortion of a Generator

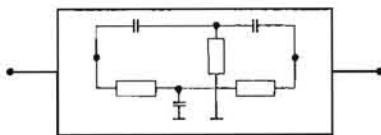
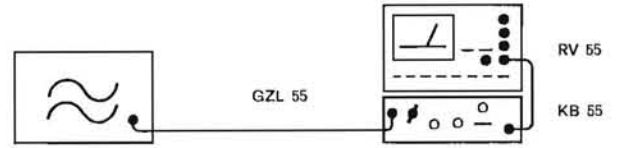

Block Diagram



Technical Data

KB 55

Measurement principle	Double T filter with harmonic equalization
Distortion factor measurement range	0.05 to 30 %
Ranges (using RV 55)	0 to 1, 0 to 3, 0 to 10, 0 to 30 %
Measurement accuracy	± 0.5 dB
Measuring frequencies (fundamental)	40/100/400/1000/6300/12500 Hz
Tolerance for each fundamental frequency	± 10 %
Suppression of the fundamental frequency	≥ 80 dB
Attenuation in the measuring range (second to tenth harmonic, 75 kHz max.)	20 dB ± 0.5 dB
Input	unbalanced
Impedance	≥ 10 kΩ
Minimum input voltage	1 V
Maximum input voltage	100 V
Output (to voltmeter)	voltage (mV) equals distortion (%)
Suitable voltmeter	RV 55
Case dimensions	296 x 94 x 165 mm
Weight	approx. 7 lbs.

We reserve the right to alter the specifications especially with regards to technical improvements.

Weighting Filter FO 55

There is a frequent requirement for the standardized measurement of noise voltages and loudness levels in the broadcast, television and recording industries, and by manufacturers of tape recorders, record players, amplifiers and microphones. Special filters are necessary for these measurements in order to weight each frequency component according to its nuisance value or effective loudness.

Standardized weighting curves have been produced by international agreement for the measurement of the nuisance value of noise voltages and the subjective loudness of sounds.

The weighting filter FO 55 is designed as an accessory for the vacuum tube voltmeter RV 55. It can however be used in conjunction with other vacuum tube voltmeters of the true RMS or peak reading type as appropriate, providing that their input impedance is sufficiently high.

The FO 55 contains a band pass filter (31.5 Hz to 20 kHz), a weighting filter for noise voltage measurements in broadband transmission systems (as specified by the CCITT) as well as a weighting filter for sound level measurements according to IEC 123 curve A. The band pass filter consists of a high-pass basic section with a cut off frequency of 31.5 Hz together with a steep cut high pass filter with a cut off frequency of 20 kHz.

The weighting filter is most conveniently used with the voltmeter RV 55 which is fitted with sockets for the purpose. The filter is then connected between circuits of the correct impedance and at a suitable voltage level. To avoid high frequency measurement errors, it is not permissible to extend the leads of the FO 55. The cases of the instruments are designed for the stacking of one instrument on top of the other with complete stability, and with such an arrangement a neat and convenient set-up results. By inserting the plugs of the FO 55 into the appropriate sockets on the RV 55, the filter is automatically connected into the amplifier circuit of the voltmeter. By depressing key 1 of the FO 55, all filters are disconnected and the RV 55 has full bandwidth. Key 2 inserts the band pass filter.

Key 3 of the FO 55 is required for measurements of noise voltage to CCITT - C standard and also for measurements to DIN 45405. For CCITT standard measurements the voltmeter should be set for RMS measurement, whereas DIN 45405 requires peak readings.

Key 4 is required for sound level measurements to IEC 123-A standard, the voltmeter being set to RMS reading.

In all filter positions the measurements can be read directly without conversion.



Technical Data

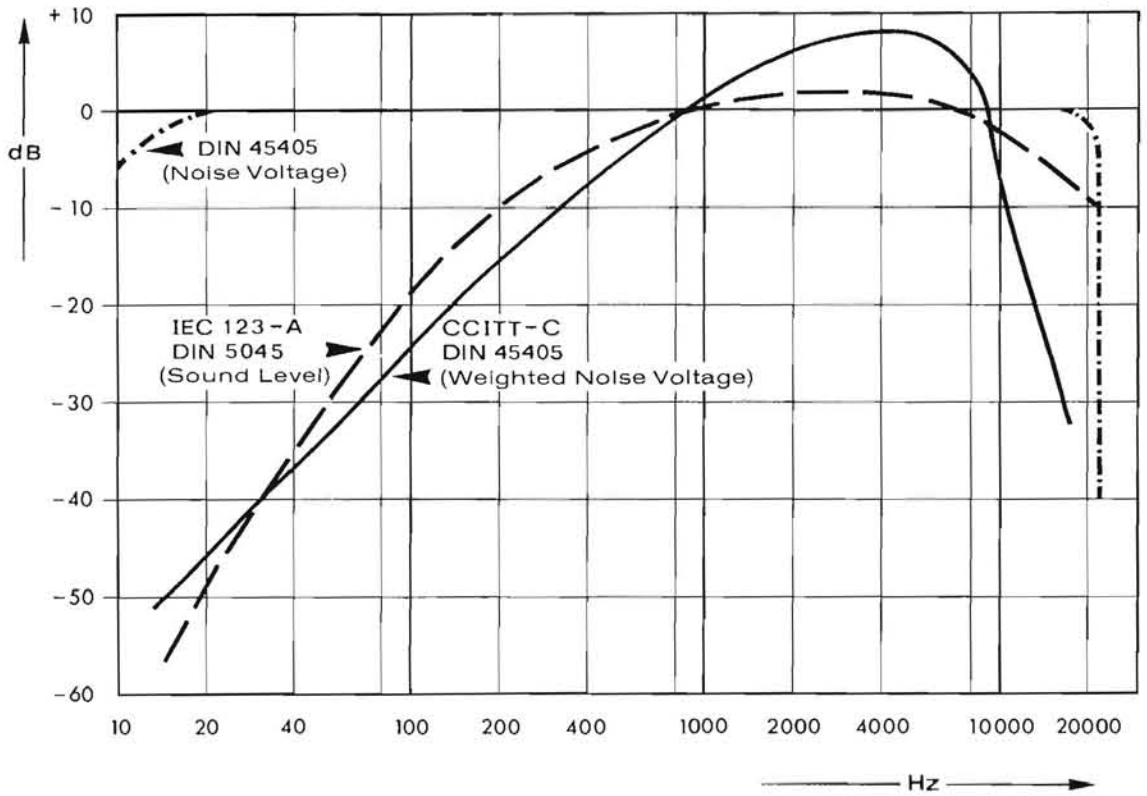
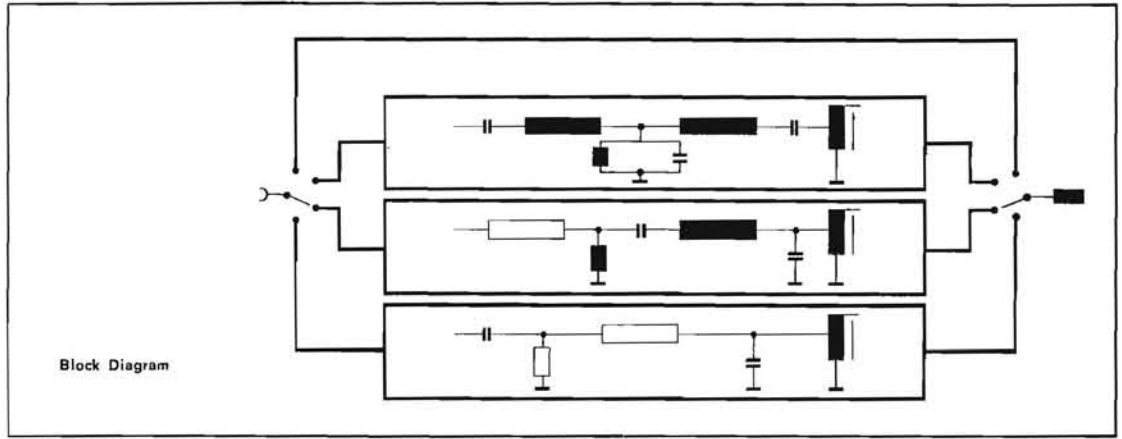

FO 55

Frequency response	see curve
Input	unbalanced
Input impedance	800 Ω
Maximum input voltage	1 V RMS
Voltage loss at 1 kHz	0 dB
Dimensions	296 x 94 x 165 mm
Weight	approx. 7 lbs.

We reserve the right to alter the specifications especially with regards to technical improvements.

Weighting Filter FO 2

An aural sensitivity network or weighting filter is a necessary accessory in the measurement of noise voltages in tape recorders, amplifiers, microphones and other electroacoustic equipment.

The weighting filter FO 2 is designed for use with the vacuum tube voltmeter RV 55. Its transmission curve corresponds to DIN standard 45 405 and the CCITT curve for noise voltages in wideband transmission equipment.

The use of the filter is extremely simple since it merely requires to be plugged into the sockets on

the front panel of the RV 55. The filter is then automatically connected into the voltmeter circuit. The voltage loss in the filter network is arranged to be zero at 1 kHz so that noise levels can be read directly from the voltmeter without any conversion factor.

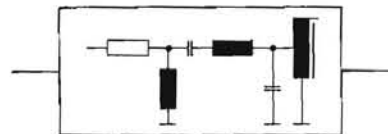

Block Diagram



Technical Data

FO 2

Input impedance	600 Ω
Insertion loss at 1 kHz	0 dB
Maximum input voltage	1.5 V RMS
Dimensions	190 x 130 x 90 mm
Weight	0.9 kg approx.

Balance to Unbalance Transformer RVZ 11

This transformer is designed to enable audio measurements to be made on circuits that are balanced to ground. It is designed in particular for use with the Sennheiser vacuum tube voltmeters into which it will connect directly.

The transformer input is via two 4 mm signal sockets and a 4 mm ground socket to accept "banana" plugs to DIN 41 628.



Technical Data

RVZ 11

Frequency range	30 Hz ... 15,000 Hz
Measurement error	50 Hz ... 10 kHz \pm 0.1 dB 30 Hz ... 15 kHz \pm 0.5 dB
Input voltage	up to 10 V RMS
Input impedance	\geq 15,000 Ω
Rejection of unbalanced signal components	\geq 60 dB

We reserve the right to alter the specifications especially with regards to technical improvements.

Impedance Tester ZP 2

The ZP 2 is designed for the quick and easy measurement of impedance. It has proven to be an invaluable aid in the design and construction of audio circuits.

Because of the minuteness of the signal that it applies to the object under test, the ZP 2 may be used for impedance measurements on microphones, magnetic recording heads, microphone transformers and any other object that would be damaged by the application of a large test signal. It can of course be used for the rapid measurement of all other components of resistance, capacitance and inductance. The ZP 2 operates with one of three audio test frequencies, selected by push-button and gives a direct reading of impedance in ohms on the clear-view meter. A change of frequency will show instantly whether the impedance is inductive or capacitive, and reference to the nomogram supplied with the instrument will give the actual value of the component under test.

The test frequencies of the ZP 2 are 250 Hz, 1 kHz and 4 kHz. The range of measurement is 1 Ω to 1 MΩ, divided into twelve push-button selected ranges. The large number of ranges available means that each range has a clear, open and easy-to-read scale.

The internal transistorized oscillator applies to a small signal to the test object. The alternating current passing through the test object is amplified by the internal transistorized amplifier and applied to the meter. Range selection is achieved by the alteration of the turns ratio of two transformers and is therefore stable and not prone to ageing errors. Changes of sensitivity of the instrument with time can be checked by reference to one standard component and the sensitivity corrected if necessary by a front panel control. The single recalibration will hold good for all twelve ranges. Power is supplied from an internal 9 V dry battery, Eveready No. 276 or equivalent.

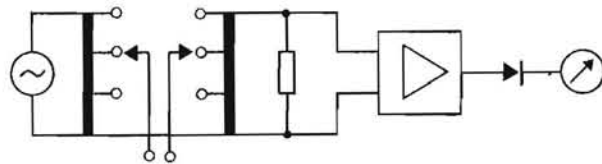

Block Diagram



The Nomogram shown below is printed in 3 colors and is included with each unit. Further copies are available on request.

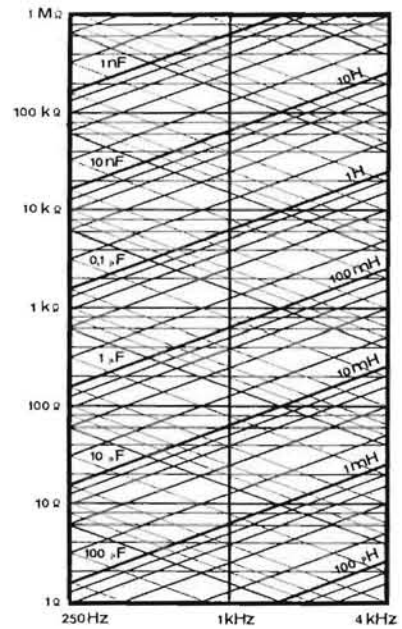

Technical Data

ZP 2

Test frequencies	250 Hz ($\omega = 1,570$) 1 kHz ($\omega = 6,280$) 4 kHz ($\omega = 25,000$)
Range of measurement:	
Resistance and impedance	1 Ω to 1 MΩ
Capacitance	40 pF to 650 µF
Inductance	40 µH to 650 H
Measurement accuracy	± 5 % at 1 kHz ± 10 % at 250 Hz and 4 kHz
Power dissipated in test object	maximum 90 µVA
Power supply required	7 - 9 V
Transistors used	5 x AC 161, 1 x AC 117
Dimensions	220 x 155 x 115 mm
Weight	approx. 5.5 lbs.

We reserve the right to alter the specifications especially with regards to technical improvements.

Resistance Decades RD 1 and RD 2

Decade resistance boxes are one of the most frequently used auxiliary instruments in any laboratory. The Sennheiser resistance decades are in use all over the world, under their own and other brand names, in laboratories, technical colleges and development departments.

Capacitance Decade CD 1

The Sennheiser capacitance decade is as well known in the test laboratories of the world as their resistance decades. A capacitance decade is useful not only for bridge measurements and other laboratory measurements, but also as an accurate component substitution box for the development engineer. The effects of variation of component tolerances can be quickly determined by the substitution of a calibrated variable capacitance.

The usefulness of this decade capacitance is increased by the clear labelling and compact size of the box.

Inductance Decades LD 1, LD 2 and LD 3

The three Sennheiser inductance decades cover a range of values from 1 mH to 1 H and offer obvious uses to the development laboratory for the empirical design and testing of filters, equalizers, etc.

The inductors are wound on large ferrite pot-cores with the resultant advantage of high Q values.

The Q value $\frac{\omega L}{R_v}$ varies with frequency and is illustrated on the front panel of each decade. Also illustrated in table form is the value of alternating current in mA that will cause a 2% increase of inductance value for each step of the decade. For a further increase of current the inductance value rises a little further then falls. The cases of the three different decades are finished in different colours for quick identification.



Technical Data

	RD 1	RD 2	CD 1	LD 1	LD 2	LD 3
Range	0 to 11.1 kΩ	0 to 11.1 MΩ	0 . . . 1.11 μF	0 - 11 mH	0 - 110 mH	0 - 1.1 H
Steps	10 Ω	10 kΩ	1 nF	1 mH	10 mH	100 mH
Accuracy	± 1 %	± 1 %	2 %	± 2 %	± 2 %	± 2 %
Temperature coefficient	- 2 %/100 °C	≤ - 5 %/100 °C	≤ 10 ⁻³	200 pF max.	200 pF max.	200 pF max.
Maximum dissipation	1 Watt	1 Watt	400 V DC max.	1.25 kg approx.	1.25 kg approx.	1.25 kg approx.
Dimensions	190 x 130 x 60 mm	190 x 130 x 60 mm	190 x 130 x 90 mm	190x130x90 mm	190x130x90 mm	190x130x90 mm
Weight	1.8 lbs.	1.8 lbs.	1.9 lbs.	grey	red	green

We reserve the right to alter the specifications especially with regards to technical improvements.

West Germany

- ① **1 Berlin W 15**
Lissner-Electronic,
Fasanenstraße 26,
☎ (0311) 8 81 91 16
- ② **43 Essen**
Rundfunk-,
Fernseh- u. Elektrovertrieb KG,
Holzstraße 11,
☎ (02141) 22 50 51 - 53
- ③ **6 Bergen-Enkheim**
Jean H. Nies,
Max-Planck-Straße 7,
☎ (06194) 27 84
- ④ **2 Hamburg 1**
Walter Kluxen,
Rundfunk-Großhandlung,
Nordkanalstraße 52,
☎ (0411) 2 48 91
- ⑤ **3 Hannover**
August Märtens,
Pelikanstraße 61,
☎ (0511) 69 09 02
- ⑥ **5 Köln**
Leo Melters KG,
Große Witschgasse 9 - 11
☎ (0211) 23 50 98 - 99
- ⑦ **45 Osnabrück**
Walter Diekhöner,
Werksvertretungen,
Martinstraße 63,
☎ (0541) 4 50 71/72
- 48 Bielefeld**
Walter Diekhöner,
Werksvertretungen,
Hauptstraße 247,
☎ (0521) 2 30 71
- ⑧ **8 München 15**
Hermann Adam & Co.,
Landwehrstraße 39,
☎ (0811) 55 45 34

- ⑨ **85 Nürnberg 2**
Dipl.-Ing. Alfred Austerlitz,
Adamstraße 20, Postfach 606,
☎ (0911) 53 33 33
- ⑩ **66 Saarbrücken**
Bruno Mohr,
Vertretungen der Elektro-,
Radio- und Fernseh-Industrie,
Mainzer Straße 139,
☎ (0681) 6 61 71
- ⑪ **7 Stuttgart-Vaihingen**
Laauser & Vohl,
Industriestraße 72,
☎ (0711) 73 50 30 - 39

Europe

**Belgium
Luxemburg**

Televic s. a.,
271, avenue Louise,
Bruxelles 5,
☎ 02-49 90 26 (41)

Denmark

Ingenieur- und Handelsfirma
Kinovox,
Industrivej 9,
3540 Lyngø
☎ (03) 277 Lyngø 893

Finland

Radiotukku Oy,
Höyläämötie 11,
Helsinki 37,
☎ 45 84 84

France

Simplex-Electronique,
48, Boulevard Sébastopol,
Paris 3 e,
☎ 8 87 15-50

Greece

Leonidas A. Apostolopoulos,
13, Rue Klissovis,
Athènes (141) Grece,
☎ 621.344 & 623.836

Great Britain

Hayden Laboratories Ltd.,
12 - 13 Poland Street,
London W. 1 V,
☎ 01 734 3748-9

East House,
Chiltern Avenue,
Amersham/Bucks,
☎ Amersham (0240-3) 5511
telex: 83251

Iceland

Magnus Thorgeirsson,
Skólavörðustígur 1 A,
Box 714, Reykjavik

Italy

Exhibo Italiana S. R. L.,
Via S. Andrea, 6,
20052 Monza
☎ 360.021/2/3

Netherlands

N. V. Kinotechniek,
Domineeslaan 81,
Zwanenburg/Halfweg
☎ 020 - 23 83 68
02907 - 4841

Norway

Norsk Musikk Instrument Co.
A/S,
Bestumveien 42,
Oslo 2,
☎ (02) 55 38 51

Austria

Grothusen, Elektroakustik,
Kinotechnische Geräte,
Handelsgesellschaft mbH,
A 1130 Wien,
Erzbischofsgasse 53,
☎ (0222) 82 41 99

Portugal

Valentim de Carvalho,
Rua Nova do Almada 95 - 99,
Lisboa 2,
☎ 36 70 51/4 32 11 18/9 32 20 68

10
00 ° C
60 mm

3
1.1 H
1 mH
2 %
1 pF max.
5 kg approx.
x130x90 mm
10n

R
R
De
qu
Th
ov
na
of
C
Th
kr
re
no
to
ne
Ti
ca
ca
Ti
cr
th
L
T
ra
u:
d
T
w
T
il
il
c
ir
a
ri
d
f
T
R
S
A
T
M
E
V
-
F
S
/
L
/

Sweden

Martin Persson AB,
Sveavägen 117,
10432 Stockholm 19,
☎ 08-23 30 45

Switzerland

Tonstudio „R“ AG,
Thunstr. 20,
CH 3000 Bern,
☎ 031/43 14 44

Switzerland

Eduard Bleuel,
Agnesstr. 2,
CH 8040 Zürich,
☎ 051/54 18 64

Spain

Electro Acoustic,
Calle Marco Aurelio, 4,
Barcelona 6,
☎ 2 27 65 96

Overseas

Australia

R. H. Cunningham Pty. Ltd.,
608, Collins Street,
Melbourne 3000,
☎ 61-2464

Chile

Tevelectric, Ltda.,
Casilla (P. O. Box) 10493,
Santiago de Chile,
☎ 39 27 32

Hongkong

Messrs.
Jebsen & Co.,
P. O. Box 97,
Hongkong,
☎ H-225111 (30 Lines)

India

Messrs.
Cosmic Corporation,
17, Ganga Griha,
Sir Vithaldas Nagar,
North Avenue,
Santacruz/Bombay 54

Israel

Messrs.
Rondo,
10, Malchei Israel Squ.,
Tel-Aviv,
☎ 23 27 10

Japan

General Traders, Ltd.,
Shirane Building,
1 - 14, Kanda Nishiki-cho,
Chiyoda-ku,
Tokyo,
☎ 291 - 27 61

Canada

West Canada
Continental Importers and
Globe Radio Co. Ltd.,
Edmonton/Alberta,
☎ 433 - 5243
439 - 8379

East Canada

Perception Industries Inc.,
274, Church Street,
Toronto,
☎ (416) 363 - 9141

Libanon

Messrs.
Eltek,
C. R. 308 Metn,
Beirut-Dora,
☎ 26 50 48

Marocco

ElectRa,
4 - 6, Rue Canizarés,
Boite Postale 990,
Casablanca,
☎ 628 - 61

Mexico

Messrs.
Industrias Nader,
Apdo. Post. 27-219,
Mexico 11, D. F.,
☎ 74-32-53

New Zealand

Messrs.
Audio Engineering Co. Ltd.,
2 Hawthorn Crescent,
Stokes Valley,
Wellington

Rhodesia

Impectron (Pty.) Ltd.,
P. O. Box 1502,
Bulawayo

Singapore

Messrs.
Jebsen & Jessen (s) Pte. Ltd.,
P. O. Box 2444,
Singapore 1/Malaysia,
☎ 7 95 87 (4 Lines)

South Africa

Impectron (Pty.) Ltd.,
P. O. Box 10262,
Johannesburg,
☎ 22 - 13 86 / 22 - 13 16

Syria

Messrs.
Hamdi Tarabeine,
Hamidieh Street,
Koudsi House,
Damascus,
☎ 142 23 - 142 25

Thailand

Charray International Inc., Ltd.,
155, New Road (SAM YOD),
Bangkok,
☎ 2 07 48

USA

Sennheiser electronic Corp.,
(N. Y.),
500, Fifth Avenue - Suite 5422,
New York, N. Y. - 10036,
☎ (212) 564-0433

Venezuela

Luis T. Laffer,
Apartado 60949,
Caracas,
☎ 33 40 23

D Ä N E M A R K

micro-revue 70/71



SENNHEISER 25 JAHRE

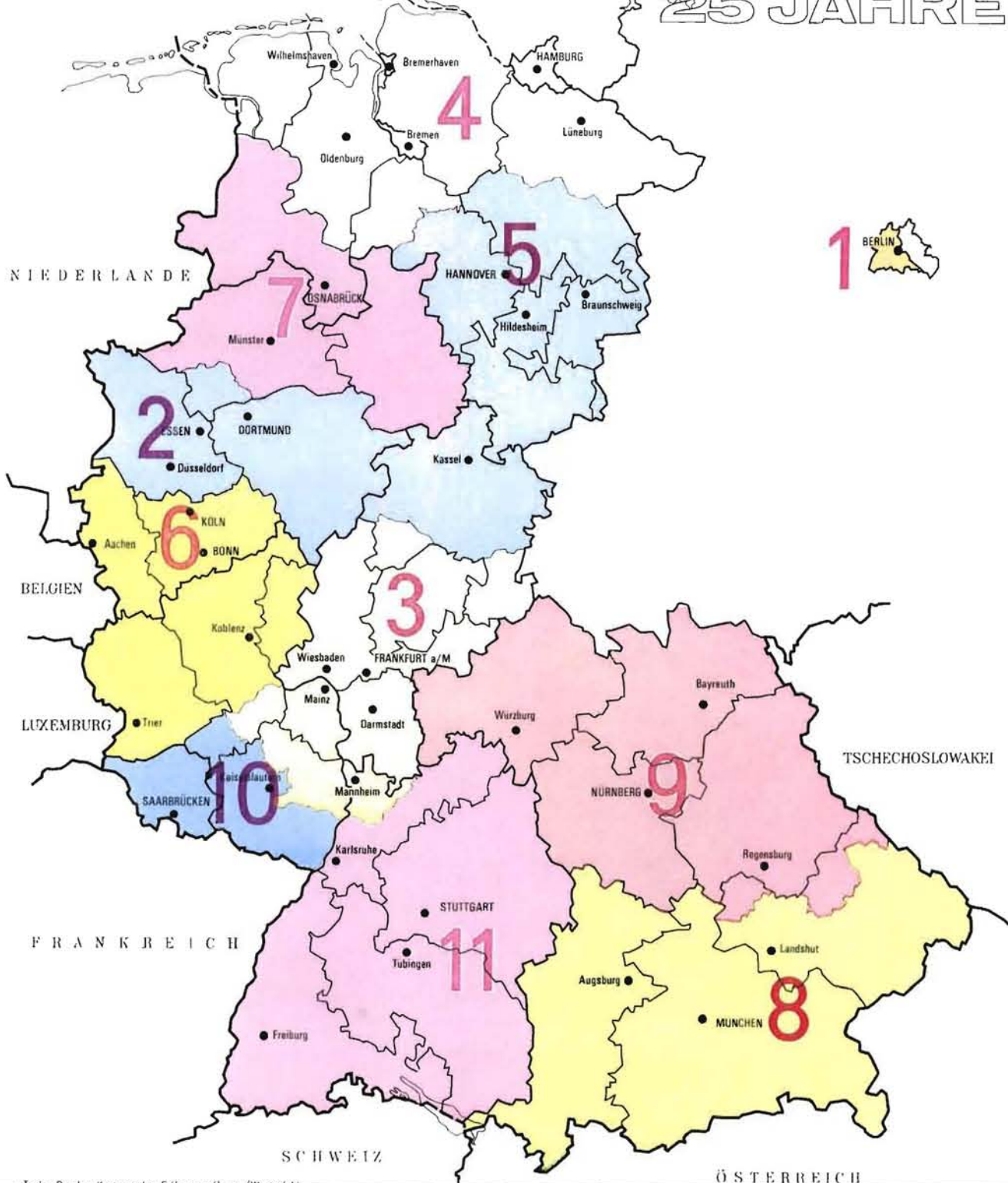

Techn. Bearb. u. Kartographie E. Hornung Hamm./Wosterfeld

SENNHEISER ELECTRONIC · 3002 BISSENDORF/HANN. · TELEFON 0 51 30 80 11 · TELEX 09 24623