

DATASHEET

Features

- Cmos Sensor 4x 16384 Pixels, 5 x 5µm
- Multi-Line structure (1, 2 or 4)
- Interface :
 - Full CameraLink® (4, 8 or 10 Channels), 85MHz each
 - CoaXPress® (4x Links)
- Line Rate :
 - Up to 50000 l/s In CameraLink®
 - Up to 100000 l/s in CoaXPress®
- Data Rate :
 - Up to 850 MB/s In CameraLink®
 - Up to 1,6GB/s in CoaXPress®
- Bit Depth : 8, 10 or 12bits
- Flat Field Correction
- Look Up Table
- New „Bhx“ Models with New Sensor and HDR feature
- Low Power Consumption : <16W
- Compliant with Standard Lenses of the Market



Description

e2v's next generation of line scan cameras are setting new, high standards for line rate and image quality. Thanks to e2v's recently developed multi line CMOS technology, the camera provides an unmatched 100 000 lines/s in a 16k pixel format and combines high response with an extremely low noise level; this delivers high signal to noise ratio even when short integration times are required or when illumination is limited. The 5µm pixel size is arranged in four active lines, ensuring optimal spatial resolution in both scanning and sensor directions with off-the-shelf lenses. An outstanding data rate in excess of 1.6 Gpixels per second, delivered via a new CoaXPress interface, allows for extremely high throughput and opens up an array of new possibilities for the next generation of inspection systems for demanding applications such as flat panel display, PCB and solar cell inspection.

Application

- Flat Panel Display Inspection
- PCB Inspection
- Solar Cell Inspection
- Glass Inspection
- Print Inspection



Standard Conformity

The ELIIXA+ cameras have been tested using the following equipment:

- For the CXP Version :
 - A shielded Trigger cable
 - A 10m CoaXPress Cable for the data transfer, certified at 6Gb/s
- For the CameraLink version :
 - A shielded power supply cable
 - A Camera Link data transfer cable ref. 14B26-SZLB-500-OLC (3M)
 - A linear AC-DC power supply

e2v recommends using the same configuration to ensure the compliance with the following standards.

CE Conformity

The ELIIXA+ cameras comply with the requirements of the EMC (European) directive 89/336/CEE (EN50081-2, EN 61000-6-2).

FCC Conformity

The ELIIXA+ cameras further comply with Part 15 of the FCC rules, which states that: Operation is subject to the following two conditions:

- This device may not cause harmful interference, and
- This device must accept any interference received, including interference that may cause undesired operation

This equipment has been tested and found to comply with the limits for Class A digital device, pursuant to part 15 of the FCC rules. These limits are designed to provide reasonable protection against harmful interference when the equipment is operated in a commercial environment. This equipment generates, uses and can radiate radio frequency energy and, if not installed and used in accordance with the instruction manual, may cause harmful interference to radio communications. Operation of this equipment in a residential area is likely to cause harmful interference in which case the user will be required to correct the interference at his own expense.

Warning: Changes or modifications to this unit not expressly approved by the party responsible for compliance could void the user's authority to operate this equipment.

Key Specifications

Characteristics	Value	Unit
Sensor Characteristics		
Resolution	4 x 16384	Pixels
Pixel Size (square)	5	µm
Max Line Rate		
CoaXPress® 4x Links (8 or 10bits)	100	kHz
CoaXPress® 4x Links (12 bits)	100	kHz
CameraLink® 10xTaps Deca mode (8 bits)	50	kHz
CameraLink® 8xTaps Full mode (8 bits)	40	kHz
CameraLink® 4xTaps Medium mode (8 or 12 bits)	20	kHz
Radiometric Performances (at Maximum Pixel rate and Minimum Camera Gain)		
Bit Depth	8 10 (CoaXPress® only) 12	Bits Bits Bits
Responsivity	450	LSB 12bits/(nJ/cm ²)
Response non linearity (between 5 – 95% saturation)	<1	%
Maximum PRNU	3	%
Dynamic Range	73	dB
Functionalities (Programmable via Control Interface)		
Sensor Modes	Multi-lines 1 , 2 and 4 (16k pixels) Binning 1 or 2 lines (8k pixels)	-
Gain (Analog : In the ADC converter)	Up to 12	dB
Offset	-4096 to +4095	LSB
Trigger Mode	Timed (Free run) and triggered (Ext Trig, Ext ITC) modes	
Mechanical and Electrical Interface		
Power Supply	Single 12 to 24	V _{DC}
Power Consumption		
CameraLink®	<13	W
CoaXPress®	<16	W
Lens Mount	M95	-
Sensor Alignment	±100	µm
Sensor Flatness	±35	µm
General Features		
Operating Temperature	0 to 55 Front Face	°C
Storage Temperature	-40 to 70	°C
Regulatory	CE, FCC and RoHs Compliant	-

Camera Description

Image Sensor

The Eliixa+ 16k sensor is composed of two pairs of sensitive lines. Each pair of lines use the same Analog to Digital Column converter (ADC Column). An appropriate (embedded) Time delay in the exposure between each line this allows to combine two successive exposures in order to double the sensitivity of a single line.

This Time Delay Exposure is used only in the 4S multi-line modes (4 Lines) and also in the two binning modes, as described below.

The 16384 Pixels of the whole sensor are divided in 4 blocks of 4096 pixels.

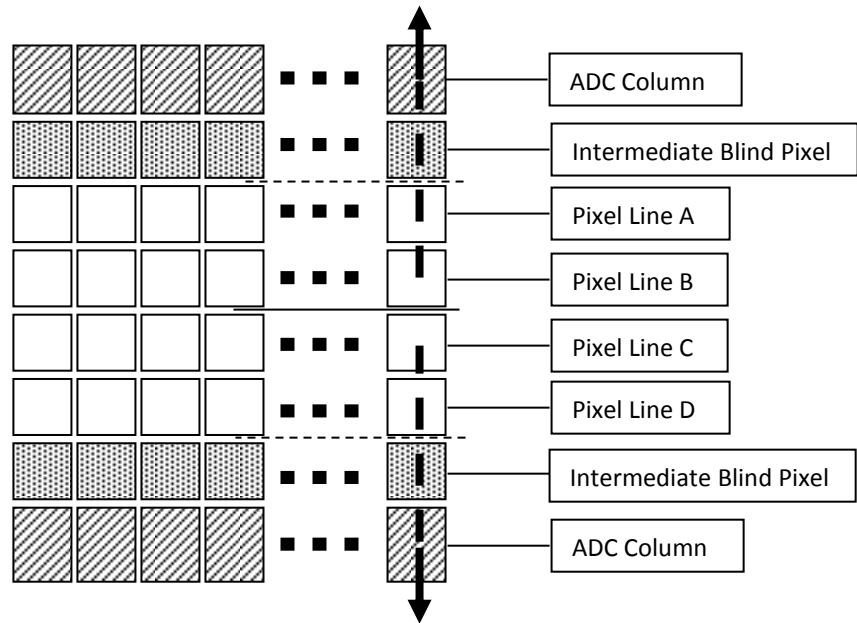

Multi-Lines modes

Multi-Lines Modes (16k Pixels Output)

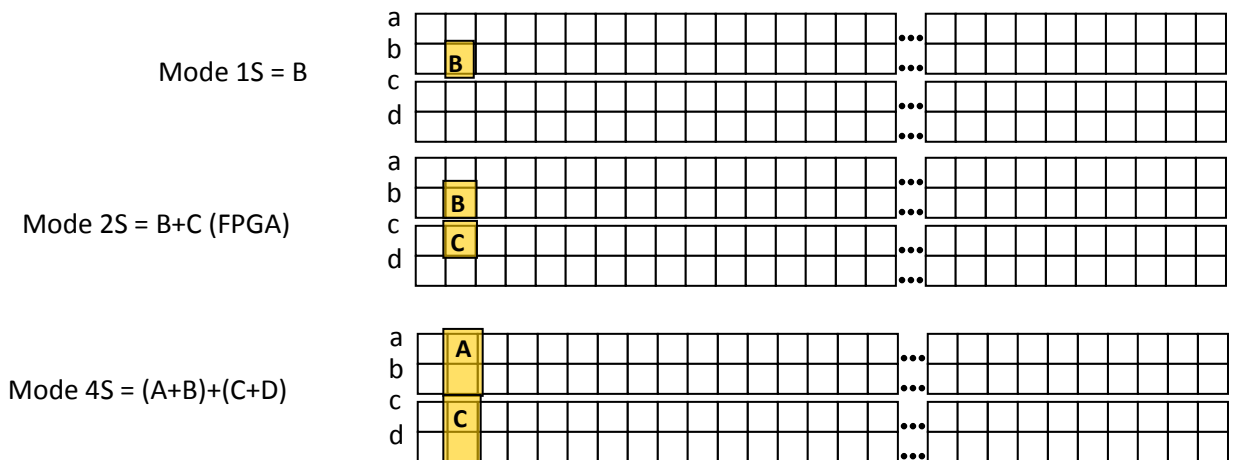

Binning Modes (8k Pixels Output) :

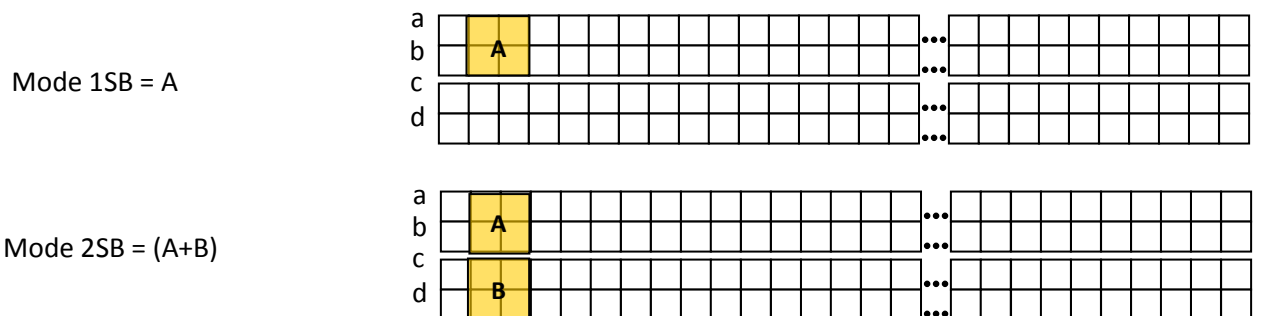

Camera Interface

Mechanical Drawings

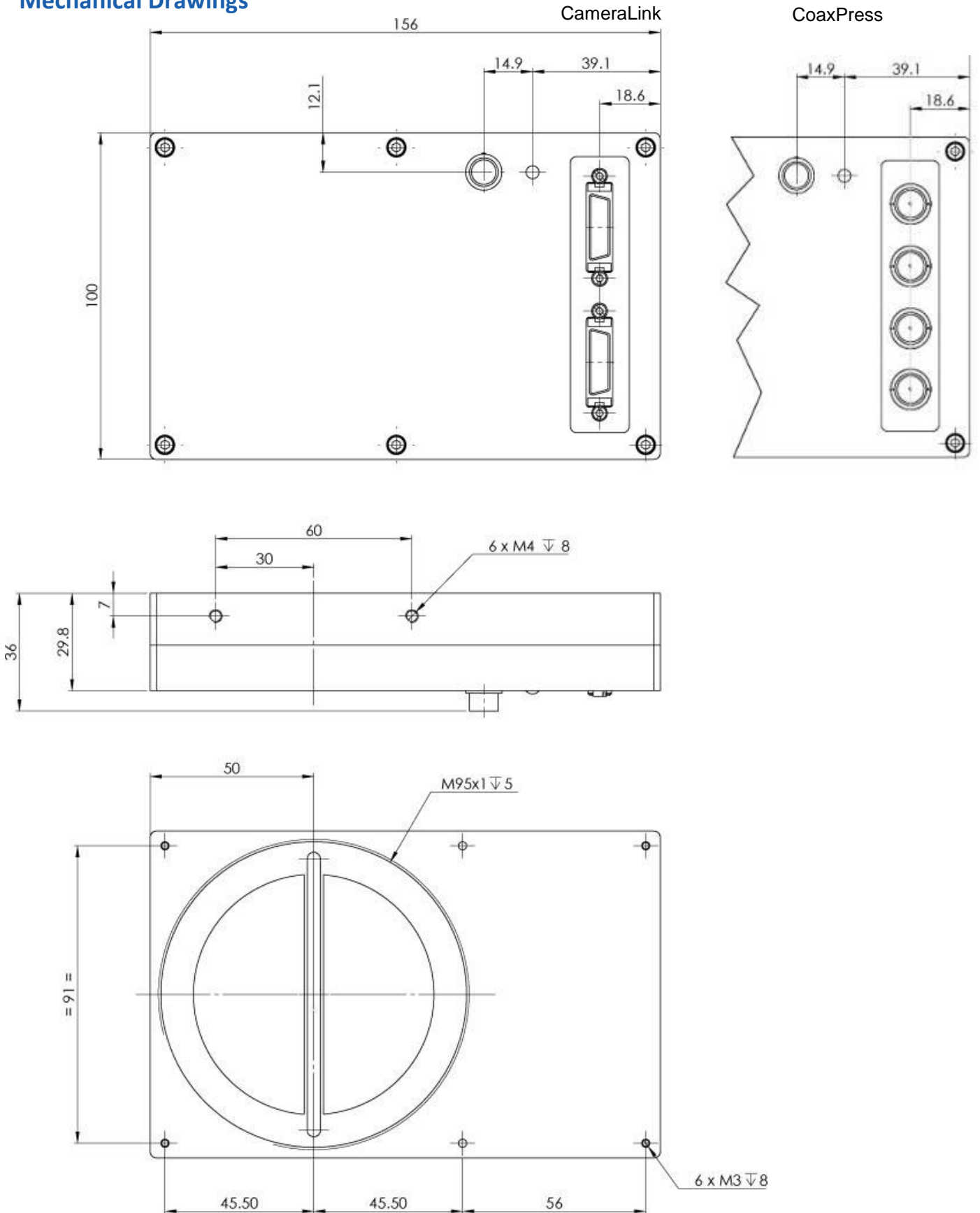

Sensor Positioning

Sensor alignment		
X	9 ±0,1	mm
Y	50 ±0,1	mm
Z	-9,4 ±0,15	mm
Planarity	±35	µm
Rotation (X,Y plan)	±0,2	°
Tilt (versus lens mounting plane)	±35	µm

Input/Output Connectors and LED (CameraLink)

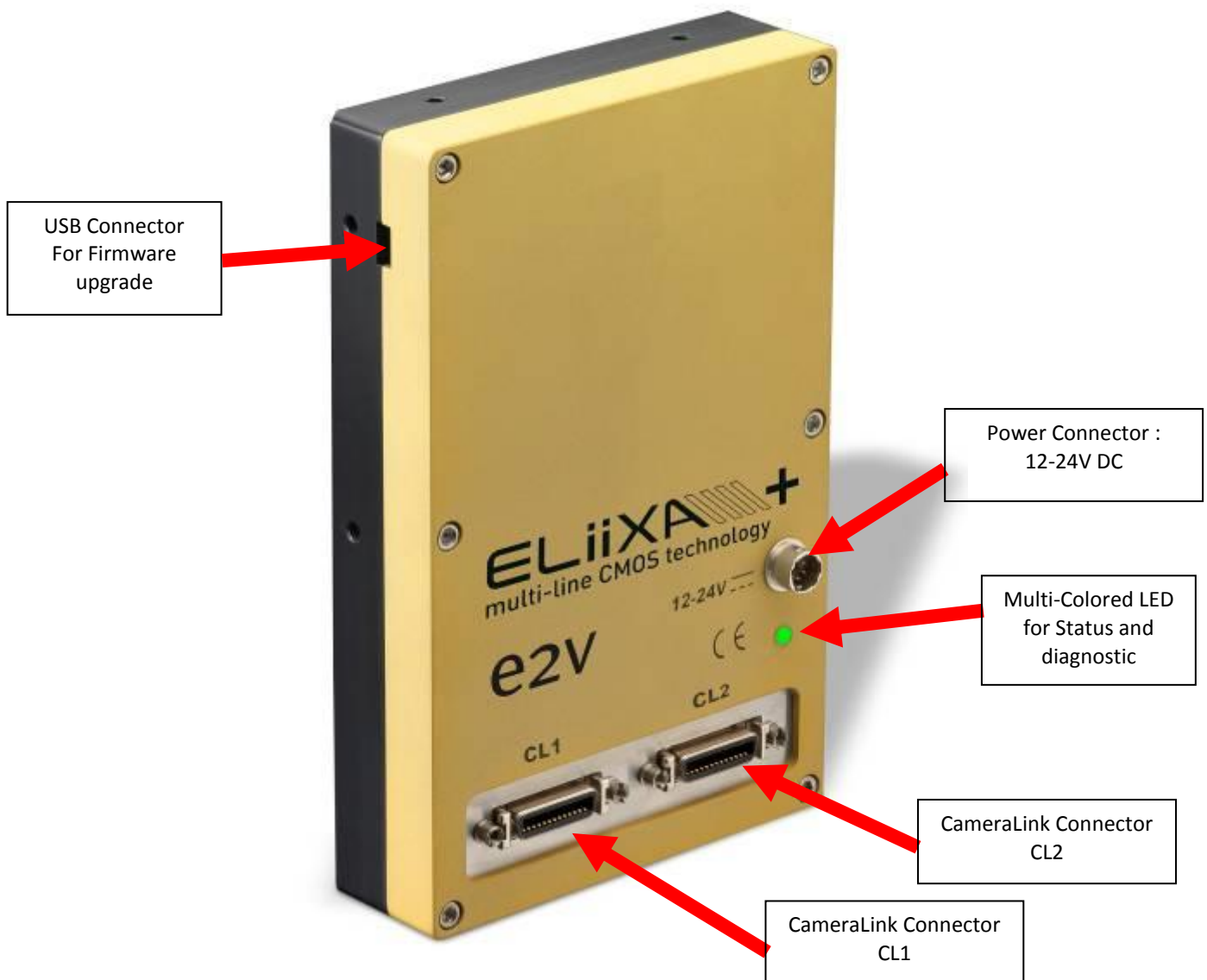

Status LED Behaviour

After less than 2 seconds of power establishment, the LED first lights up in ORANGE. Then after a Maximum of 30 seconds, the LED must turn in a following colour :

Colour and state	Meaning
Green and continuous	OK
Green and blinking slowly	Waiting for Ext Trig (Trig1 and/or Trig2)
Red and continuous	Camera out of order : Internal firmware error

Power Connector

Camera connector type: Hirose HR10A-7R-6PB (male)

Cable connector type: Hirose HR10A-7P-6S (female)

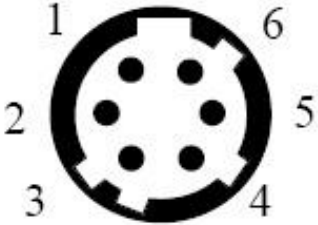
 Camera side description	Signal	Pin	Signal	Pin
	PWR	1	GND	4
	PWR	2	GND	5
	PWR	3	GND	6
Power supply from 12 to 24v Power 13W max with an typical inrush current peak of 1,8A during power up				

Typical values	Current consumption	
	12V	24V
ELIIXA+ CL (normal)	1,06A	0,54A
ELIIXA+ CL (Standby)	0,47A	0,25A

Power up Time : Around 43s (Green Light)

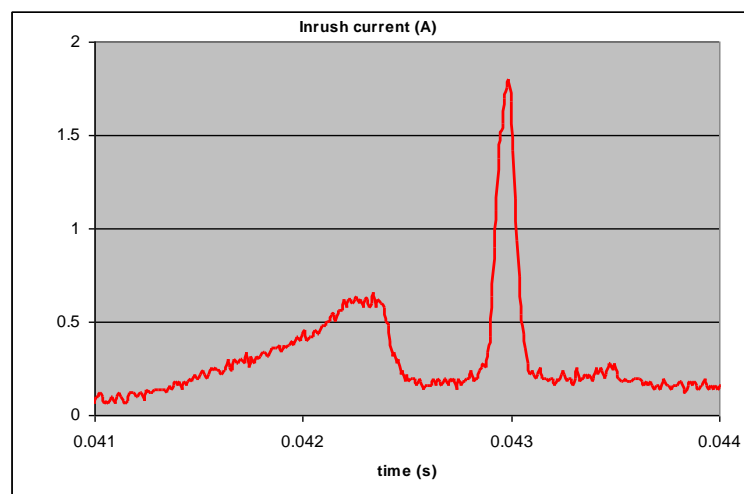

Output Configuration (CameraLink)

	Connector CL1 + CL2	Pixels per Channel
Medium CameraLink Mode		
4 Channels 8bits	4 x 85MHz	4 x 4096
4 Channels 12bits	4 x 85MHz	4 x 4096
Full CameraLink Mode		
8 Channels 8bits	8 x 85MHz	8 x 2048
Deca Mode		
10 Channels 8bits	10 x 85MHz	10 x 1638

- Medium Mode 4x4096 Pixels at 85MHz each Channel (4x2048 pixels in Binning Mode 1SB or 2SB)
4 Taps Separate, from Left to Right :

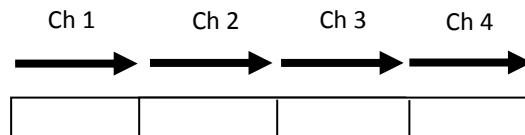

- FULL Mode 8x2048 Pixels at 85MHz each Channel (8x1024 pixels in Binning Mode 1SB or 2SB)
8 Taps Separate, from Left to Right :

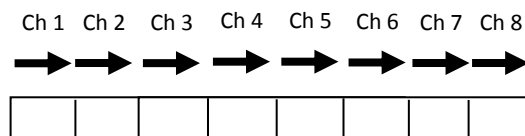

- FULL+ Mode 10x1638 Pixels at 85MHz each Channel (10x819 pixels in Binning Mode 1SB or 2SB)
10 Taps Separate, from Left to Right :

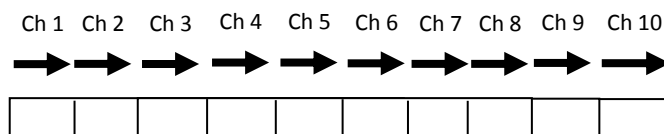



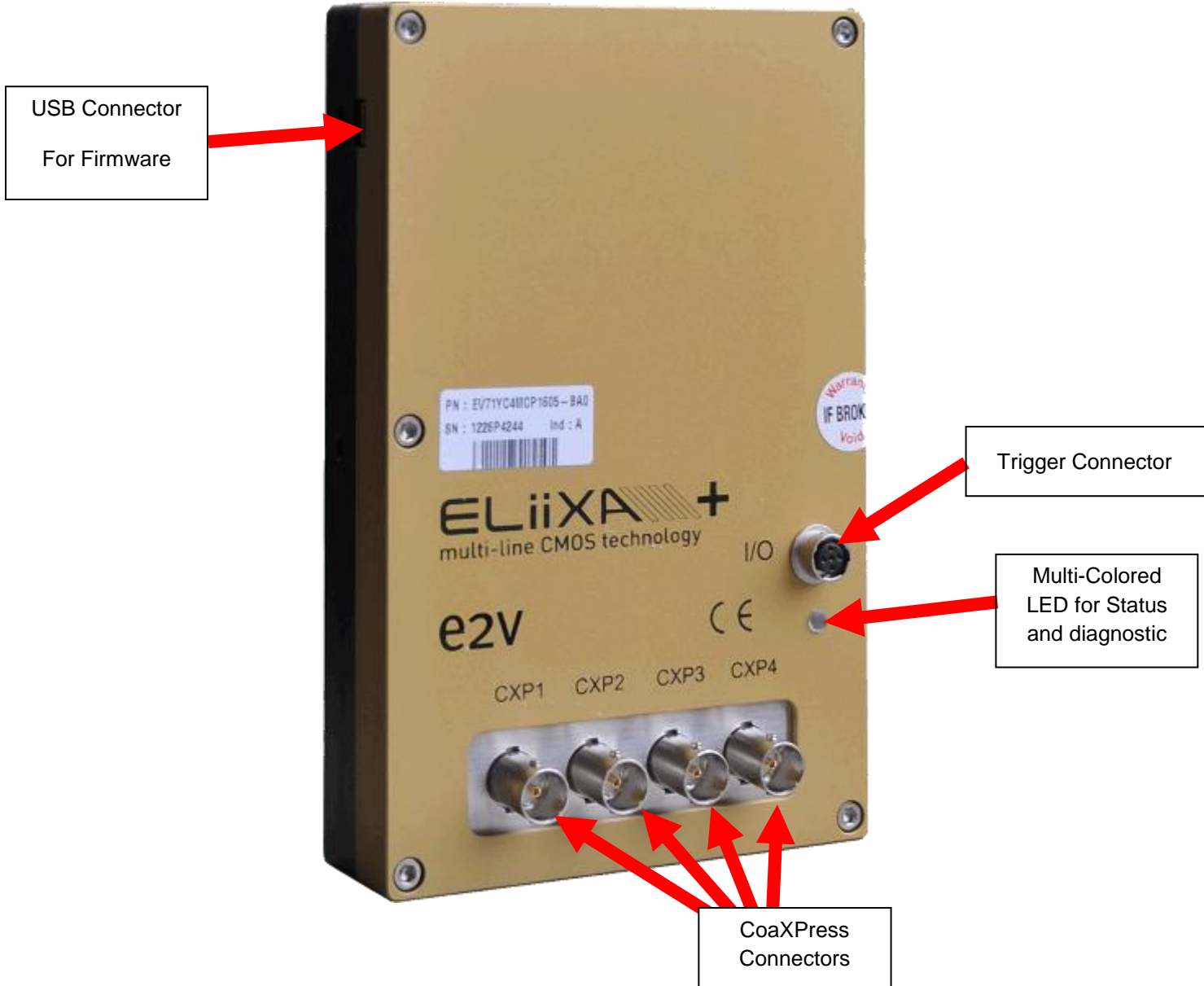





Input/Output Connectors and LED (CoaXPress)



Status LED Behaviour

The Power LED behavior detail is the following :

Colour and State		Meaning
Off		No power
Solid orange		System booting
Fast flash green Shown for a minimum of 1s even if the link detection is faster		Link detection in progress
Slow flash alternate red / green		Device / Host incompatible
Slow pulse green		Device / Host connected, but no data being transferred
Slow pulse orange		Device / Host connected, waiting for event (e.g. trigger, exposure pulse)
Solid green whenever data transferred (i.e. blinks synchronously with data)		Device / Host connected, data being transferred
500ms red pulse In case of multiple errors, there shall be at least 200ms green before the next error is indicated		Error during data transfer (e.g. CRC error, single bit error detected)
Fast flash red		System error (e.g. internal error)

Power Over CoaXPress

The ELIIXA+ CXP is compliant with the Power Over CoaXPress : There is no Power connector as the power is delivered through the Coaxial Connectors 1 and 2.

In the Standard, the Power Over CoaXPress allows to deliver 13W (under 24V) per Channel.

The ELIIXA+ CXP requires 18W then two connectors are required for the power : The two first are used for this purpose.

If you want to Power ON the Camera you have to connect the Coaxial connector output 1 of the camera to the coaxial connector 1 of the Frame Grabber.

Note 1 : Only the connector 1 position is mandatory. They other 3 connectors can be inverted but the camera still needs the 2 first connectors to get it power and be able to start up.

Note 2 : Removing the 2 first connectors will shut down the Camera : You can reset the Camera by quickly (**less than 1s**) connect/disconnect the Connector CXP1 but after a longer shut down, you'll have to reboot the PC with the Camera full connected to the frame grabber in order to synchronize the discovery of each power line.

Note 3 : With some frame grabber you have access to a specific command (from the Frame Grabber interface) for shutting down/up the power of the CoaxPress : This solution, with the complete reboot, is the better solution to ensure a complete power On of the Camera.

Trigger Connector

Camera connector type: Hirose HR10A-7R-5SB or compliant
 Cable connector type: Hirose HR10A-7P-5P (male) or compliant,
 Provided with the Camera

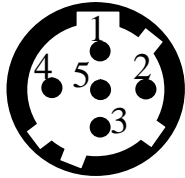

Receptacle viewed from camera back

Signal	Pin
LVDS IN1+ / TTL IN1	1
LVDS IN1-	2
LVDS IN2+ / TTL IN2	3
LVDS IN2-	4
GND	5

IN1/IN2 are connected respectively to Line0/Line1 and allow to get external line triggers or the forward/Reverse “Live” indication.

On the Connector side, the 120Ω termination is validated only if the input is switched in LVDS or RS422. The electrical schematic is detailed below :

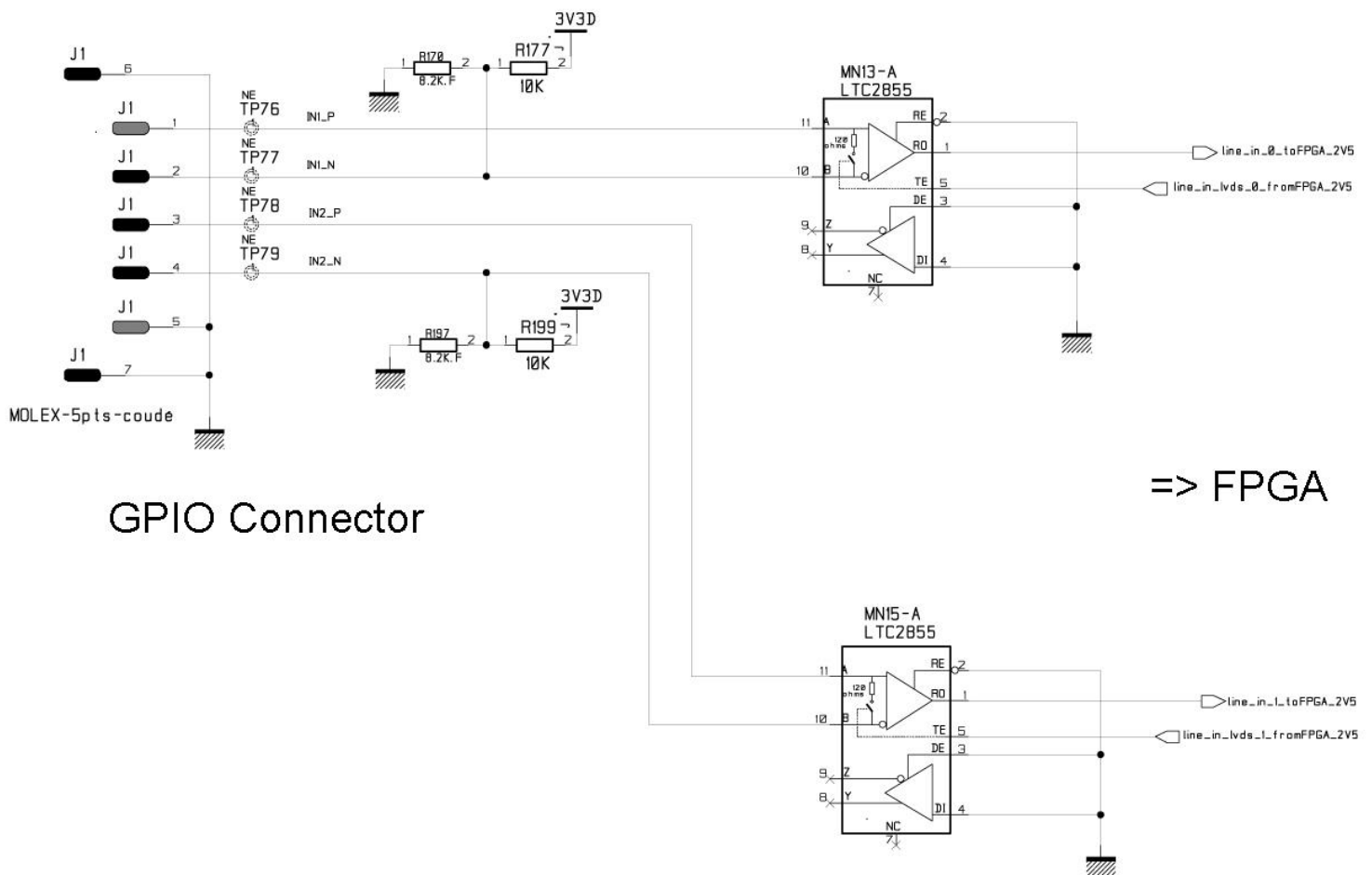

GPIO Connector

Optical Interface : Lens Compliance

QIOPTICS (LINOS)				
	Nominal Magnification	Magnification Range	M95 Focus tube Reference	Lens Reference Part number
Inspec.x. L 5.6/105	0,33 X	0,25 – 0,45 X	2408-012-000-41	0703-085-000-20
Inspec.x. L 5.6/105	0,5 X	0,4 – 0,65 X	2408-012-000-41	0703-084-000-20
Inspec.x. L 5.6/105	0,87 X	0,6 – 0,9 X	2408-012-000-43	0703-083-000-20
Inspec.x. L 5.6/105	1 X	0,85 – 1,2 X	2408-012-000-43	0703-082-000-20
Inspec.x. L 4/105	3 X	2,8 – 3,3 X	2408-012-000-46	0703-104-000-20
Inspec.x. L 4/105	3,5 X	3,3 – 3,7 X	2408-012-000-44	0703-095-000-21
Inspec.x. L 3.5/105	5 X	4,8 – 5,2 X	2408-012-000-45	0703-102-000-20
SCHNEIDER KREUZNACH				
	Nominal Magnification	Magnification Range	Working Distance (at nom. Mag.)	Reference Part number
SR 5.6/120-0058	1 X	0,88 – 1,13 X	212 mm	1002647
SR 5.6/120-0059	0,75 X	0,63 – 0,88 X	252 mm	1002648
SR 5.6/120-0060	0,5 X	0,38 – 0,63 X	333 mm	1002650
SR 5.6/120-0061	0,33 X	0,26 – 0,38 X	453 mm	1004611
Accessories	V mount 25mm macro-extension tube		Necessary to combine the whole lens system	20179
	V mount to Leica adapter			20054
	Unifoc 76			13048
	Adapter M58x0.75 – M95x1			1062891
	Extension tube M95x1, 25mm		To be combined to reach the appropriate magnification	1062892
	Extension tube M95x1, 50mm			1062893
	Extension tube M95x1, 100mm			1062894
MYUTRON				
	Nominal Magnification	Working Distance	M95 Custom Mount available Aperture (∞) : 4.7	
XLS03-E	x0,3	477mm		
XLS53-E	x0,5	324mm		
XLS75-E	x0,75	246mm		
XLS010-E	x1	197mm		
XLS014-E	x1,4	170mm		
XLS203-E	x2	146mm		

EDMUND OPTICS			
	Nominal Magnification	Working Distance (at nom. Mag.)	Reference Part number
TechSpec F4	1 X	151 mm	NT68-222
TechSpec F4	1,33 X	158,5 mm	NT68-223
TechSpec F4	2,0 X	129 mm	NT68-224
TechSpec F4	3,0 X	110 mm	NT68-225
Accessories	Large Format Tip/Tilt Bolt Pattern Adapter, 2X		NT69-235
	Large Format Focusing Module		NT69-240
	Large Format Adapter Set		NT69-241
NAVITAR			
Raptar Pro 4/86	1 X	Extension Tubes on request	1 - 17494
NIKON			
Rayfact F4	0,05 X – 0,5 X	1820,4mm – 230,3mm	Rayfact ML90mm F4
NAVITAR			
Raptar Pro 4/86	Magnification : 1 X	Extension Tubes on request	1 - 17494

Camera Models

Camera Part Number	Max Speed	Interface	Features
EV71YC4MCL1605-BA1	16k : 50kHz 8k : 100kHz	CameraLink® 4, 8 or 10 Taps at 85MHz	-
EV71YC4MCP1605-BA0	16k /8k 100kHz	CoaXPress® 4 x 6Gb/s	-
EV71YC4MCL1605-BH1	16k : 50kHz 8k : 100kHz	CameraLink® 4, 8 or 10 Taps at 85MHz	New Sensor HDR Function
EV71YC4MCP1605-BH0	16k /8k 100kHz	CoaXPress® 4 x 6Gb/s	New Sensor HDR Function