

SafeTANK

GR3630-SB3 / WSB3

User Manual



v.1.0 (January, 2012)

Index

Chapter 1	An introduction to RAID	4
1.1	What is RAID?.....	4
1.2	Comparison of RAID 0 and RAID 1.....	4
Chapter 2	Characteristics and specifications	5
2.1	Product appearance and accessories guide.....	5
2.2	Product detailed specifications.....	7
2.3	Precautions before application.....	8
2.4	Message Indication of LED and Buzzer.....	9
Chapter 3	Installation of GR3630	9
3.1	Installation of hard disk.....	9
3.2	Product connection and booting.....	10
3.3	Hard disk formatting and disk drive establishing.....	10
3.3.1	Windows operating system.....	10
3.3.2	MAC operating system.....	13
3.4	An introduction to other functions.....	16
3.4.1	LCD monitor operation guide.....	16
3.4.2	LCD monitor message guide.....	18
Appendix A	Frequently asked questions	20
	RAID GUI Instruction	23
	Energy saving	25

Chapter 1 An introduction to RAID

1.1 What is RAID?

The idea of RAID (Redundant Array of Inexpensive Disks) was first proposed by David A. Patterson, Garth Gibson and Randy H. Katz at University of California, Berkeley in 1988. The purpose of RAID is to store the same data in multiple hard disks at different places, and to improve the performance of storage system. The advantages of RAID are to provide better productivity effectiveness and data error tolerance, and these can be done by distributing workload parallelly to a number of disk drive entities to achieve better performance. And through multi-operation of data, whenever one (or several) hard disk or magnetic area has a problem, we can still find the mirror copy of data in another hard disk, and so to achieve error tolerance.

Not only does RAID controller be able to assist users in ensuring that they can see their operating system in logical disk drive, they can also feel at ease without having to worry on how to manage this complicated construction. Generally, in order to get better result, we suggest users to choose a hard disk in same brand and same model while installing them in RAID, as a matching performance of these hard disks would allow the array to operate better than a single hard disk.

1.2 Comparison of RAID 0 and RAID 1

RAID 0: Striping (fast speed but has no error tolerance; two hard disks are required)

RAID 0 is currently the fastest RAID. It is a type of performance-oriented disk mirroring method. The function of RAID 0 is that it is able to combine two or more hard disks to work as a large hard disk. While all the hard disks are reading or writing under Stripe mode, they will be started up simultaneously. Assuming that you are writing a 10MB file and you have two hard disks to work under Strip. At this instant, every disk will start up simultaneously to write this file and sub-divide it into two equal parts, and simultaneously write it in two hard disks (each in writing 5MB). Therefore, the writing time is only half the original time. When you want to retrieve this file, you only need to retrieve 5MB each from two hard disks vice versa, and so, the time needed is only half. As reading and writing of file by each hard disk is only half the original time, therefore, the reading and writing performances are the fastest among all RAIDs. However, as RAID 0 array does not backup data, whenever one of the disks is damaged, the entire array will be malfunctioned to result with all data lost in the array. Thus, we can say that RAID 0 does not have any error tolerance capability at all.

The computing method of RAID 0 hard disk capacity:

[total capacity] = [hard disk number] x [minimum capacity of hard disk]

Ex: $2 \times 500\text{GB HDD} = 2 \times 500\text{GB} = 1000\text{GB}$

$1 \times 500\text{GB HDD} + 1 \times 200\text{GB HDD} = 2 \times 200\text{GB} = 400\text{GB}$

RAID 1: Mirroring (possesses error tolerance capability; two hard disks are required)

As RAID 1 is composed of two hard disks, it can be referred to as disk mirroring. Each data will simultaneously be written in two disks and that the data in two disks are exactly the same. Whenever one of the disks fails, the system is still able to operate normally. RAID 1 features excellent data security, and is most commonly and widely used among all the RAID levels, and most compliance to the original design concept.

The computing method of RAID 1 hard disk capacity: [total capacity] = [minimum capacity of hard disk]

Ex: 2 × 500GB HDD=500GB

1 × 500GB HDD+1× 200GB HDD=200GB

The following is a comparison of two RAID levels:

RAID Level	Basic operation principle	Disk applicable space	Data reliability	Data transmit rate	Minimum hard disk requirement
0	Partition storage	Total hard disk capacity	Low	Fast	2
1	Mirroring	Minimum hard disk capacity	High	Slow	2

Chapter 2 Characteristics and specifications

2.1 Product appearance and accessories guide

Front view

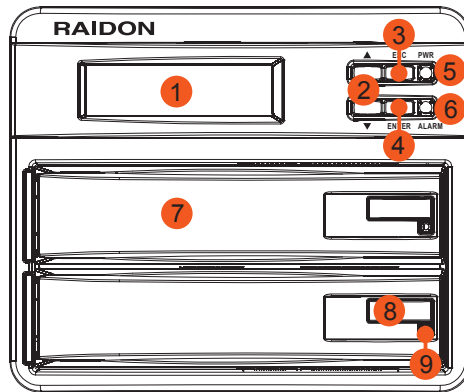

1. LCD panel

Display different product messages including RAID mode, fan speed, product interior temperature, and hard disk status.

2. UP/DOWN selection key

The operation key for function setting (options: cycle function).

3. Cancel key (ESC)

The operation key for function setting (options: abandon function).

4. Confirm key (ENTER)

The operation key for function setting (options: confirm function).

5. Power lamp (blue)

It will light up continuously after power ON.

6. Failure warning light(red)

It will light up when there is an interior fault, including three status of hard disk failure, fan failure, and when temperature is too high.

7. Hard disk tray handle

8. Hard disk tray button

The operation key for removing the hard disk tray

9. Hard disk reading/writing light (blue)

Display different product messages including RAID mode, fan speed, product interior temperature, and hard disk status.

Rear view (GR3630-SB3)

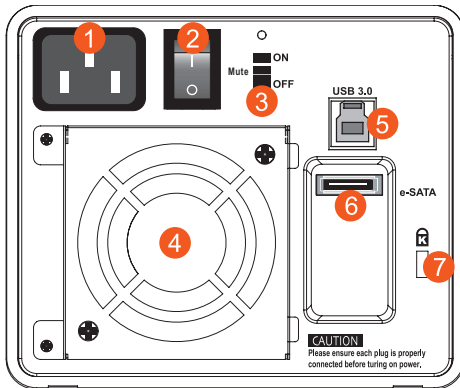

Rear view (GR3630-WSB3)

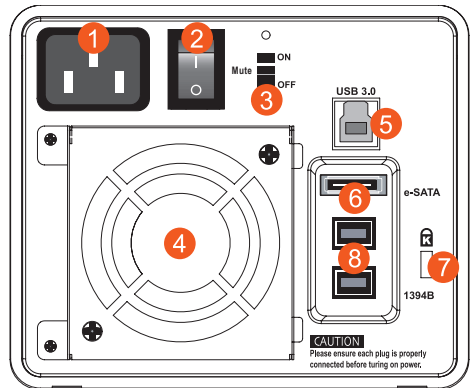

1. AC power socket

2. Power switch

3. Warning sound effect switch (Mute)

The product is built in with a buzzer. Whenever there is an error during the application process, apart from lighting up the warning light at the front, the product will also emit a warning sound. If users do not want the warning sound, they can switch this off.

4. 6cm fan

5. USB port

6. eSATA port

7. Security lock hole

If users want to secure the product in a specific place permanently, they can buy themselves a lock to secure the lock at this position.

8. 1394b port

Parts list

Item	GR3630-SB3	GR3630-WSB3
GR3630 main unit	✓	✓
AC power cord	✓	✓
USB 3.0 connecting cable	✓	✓
eSATA connecting cable	✓	✓
1394b connecting cable		✓
Quick installation guide	✓	✓
CD	✓	✓
Screw pack	✓	✓

※ After opening the package of this product, please ensure that the related accessories of the model you purchased are complete with nothing missing, and the appearance and functions are all intact. Should you discover any problem with the product, please contact the store or agent where you bought the product as soon as possible.

2.2 Product detailed specifications

Model	GR3630-SB3	GR3630-WSB3
ASIC	SR2045	SR2045
Host Chip	ASM1051 + SR2045	ASM1051 + OXFW934DSB
Host Interface	USB3.0 & eSATA	USB 3.0 & eSATA & 1394b
Supporting Hard Disk	SATA 3.0 Gb/s	SATA 3.0 Gb/s
Hard Disk Supporting Number	2 pieces	2 pieces
Hard Disk Size	3.5 inches	3.5 inches
Hard Disk Maximum Supporting Capacity	3TB	3TB
Product Maximum Storage Capacity	Under 6TB / RAID 0 status	Under 6TB / RAID 0 status
RAID Level	RAID 0 & RAID 1	RAID 0 & RAID 1
Hot Swap Hard Disk	yes	yes

Auto-rebuilding	yes	yes
LCD Display	yes	yes
Status Indicator Light	yes	yes
Error Status Warning Sound	yes	yes
Environmental Detection	yes /abnormal temperature and fan operation	yes /abnormal temperature and fan operation
Cooling Fan	DC-12V / 6cm / 3500 rpm	DC-12V / 6cm / 3500 rpm
Power Input	AC 100~240V	AC 100~240V
Built-in Power Supply	DC 12V & 5V / 70W	DC 12V & 5V / 70W
GUI	Windows	Windows
Operating System	Windows & Mac & Linux	Windows & Mac & Linux
Quality Certification	CE & FCC	CE & FCC

2.3 Precautions before application

1. Although GR3630 allows users to use hard disks of different capacities, but if you want to get best application performance and best product compatibility, we suggest you to use brand new hard disks of same specifications, model number and brand.
2. If you want to install GR3630 in two used hard disks, before installation, please first backup data in these hard disks to other hard disk to avoid data loss in the setting process later on.
3. Please ensure that the two hard disks do not contain bad track as a precaution if one of them fails, it may cause a system crash or a risk to lose all data.
4. The factory default value of GR3630 is RAID 1, we suggest users to first consider the application before using it. If your requirement is data security, please set it as RAID 1 mode; and if your consideration is to expand storage capacity, please set it as RAID 0 mode. Should you need resetting later on, it would destroy the data in the disks.
5. RAID 0 has no data backup function, but it is capable of combining all the hard disks to form a large-capacity hard disk with faster transmission performance. But whenever one of the hard disks fails, it would destroy the data in all the hard disks.
6. Users are able to set RAID level and GR3630 basic functions through the LCD monitor and the right keys at the front of the product.

2.4 Message Indication of LED and Buzzer

Status	LED Indicators			Buzzer
	Power LED	Alarm LED	HDD LED	
Power on	Blue / Light On	-----	-----	-----
No disk	Blue / Light On	Red / Light On	-----	Yes
Disk Failure	Blue / Light On	Red / Light On	-----	Yes
Access	Blue / Light On	-----	Blue / Blink	-----
Fan Failure	Blue / Light On	Red / Light On	-----	Yes
Overheat (Over 55°C)	Blue / Light On	Red / Light On	-----	Yes
Rebuilding	Blue / Light On	-----	Blue / Blink	-----

Chapter 3 Installation of GR3630

3.1 Installation of hard disk

1. Press the hard disk tray button

※ Press the hard disk tray button and pull out the hard disk tray

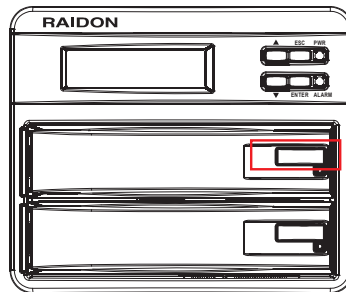

2. Install two brand new SATA hard disks in the hard disk trays and secure each of them with screws at four positions as indicated in the diagram using the screw pack provided. Finally, insert the hard disk trays into GR3630.

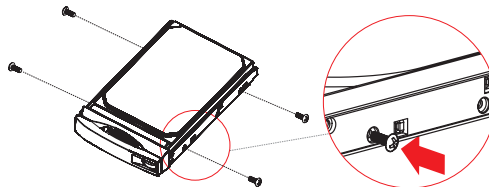

3.2 Product connection and booting

1. Connect AC power cord to your power outlet and GR3630.
2. Choose the interface (USB & eSATA & 1394b) that you want, and hook up your computer with the connecting cable.
 ※ Choose only one type of interface to hook up with your computer.
3. Switch on the power of GR3630, when the LCD displays Pri HDD: OK and Sec HDD: OK after about 20~30 seconds, it indicates that GR3630 has been booted.
 ※ The factory default value of GR3630 is RAID 1 mode.

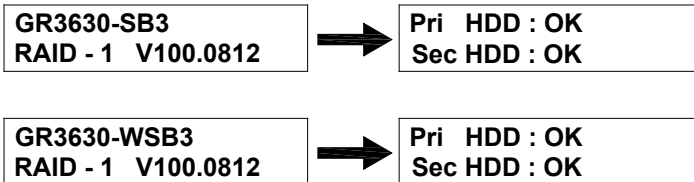

3.3 Hard disk formatting and disk drive establishing

3.3.1 Windows operating system

1. Enter into device manager of your computer.
 ※ Use the mouse to click on My Computer and then click the right mouse button to select Management option.

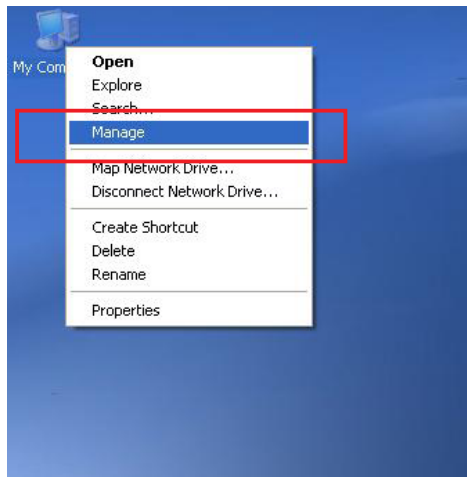

※ Click on Disk Management

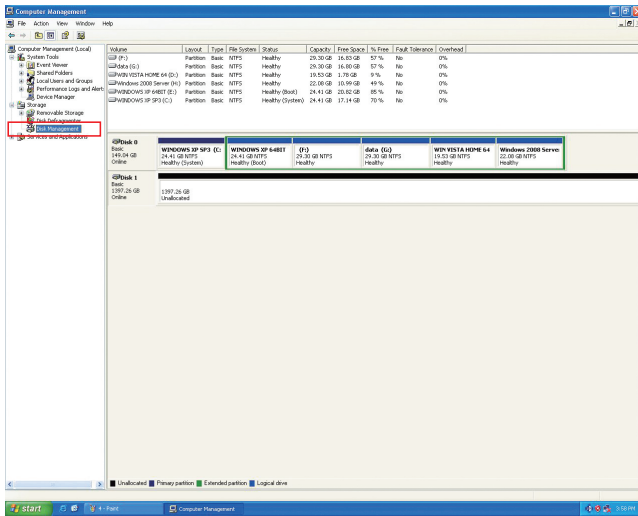

2. Add in GR3630 hard disk and format it.

※ During the setting process, we suggest you to choose NTFS format.

※ Move the mouse to the upper region of Non-configured area and click the right button; it will display the list of New Disk Partition

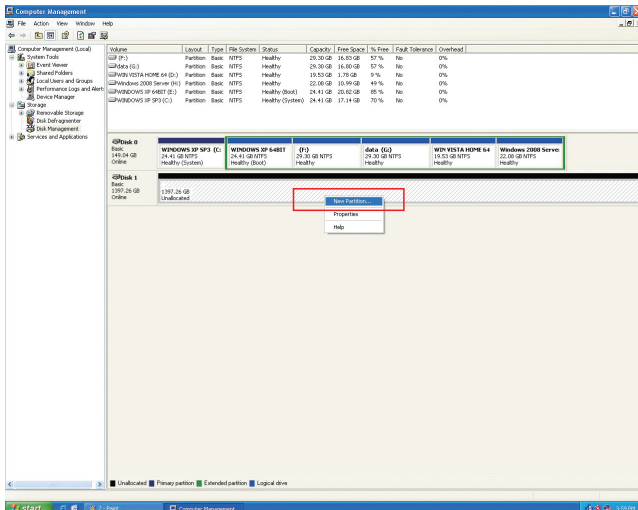

※ According to Disk Management Wizard instructions, click Next to proceed the process until finish.

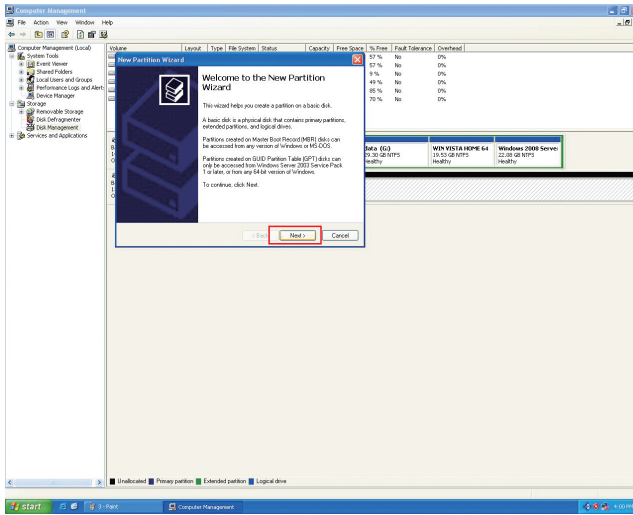

3. Setting is finished, you can start using this product.

※ After finish setting and formatting the hard disk, it will display a disk drive code (I:) as shown in the diagram.

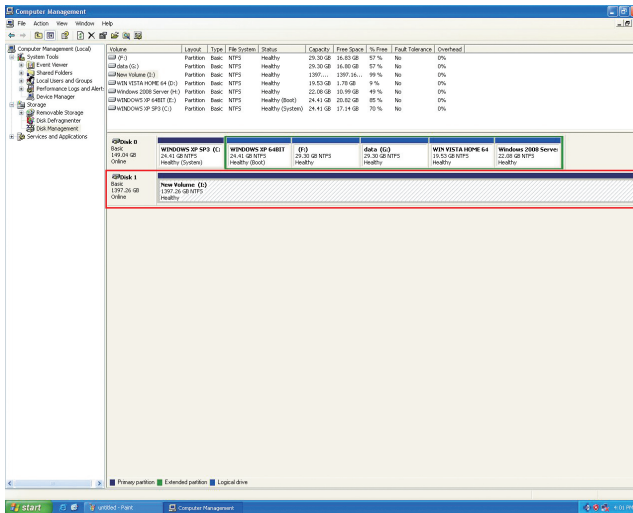

※ After finish setting, your computer will display a disk code (I:) to note that you can now use GR3630 normally.

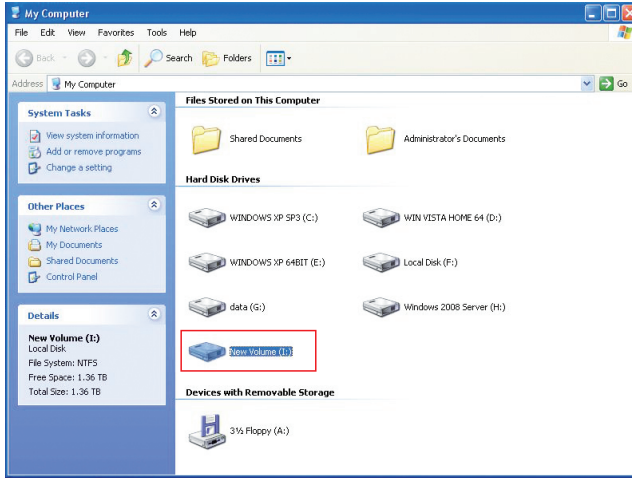

3.3.2 MAC operating system

1. Enter into Disk Utility of your computer.

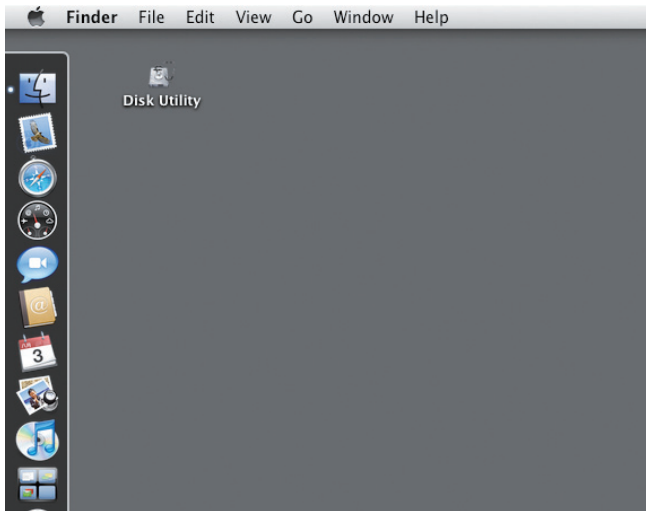

※ Click on this hard disk device

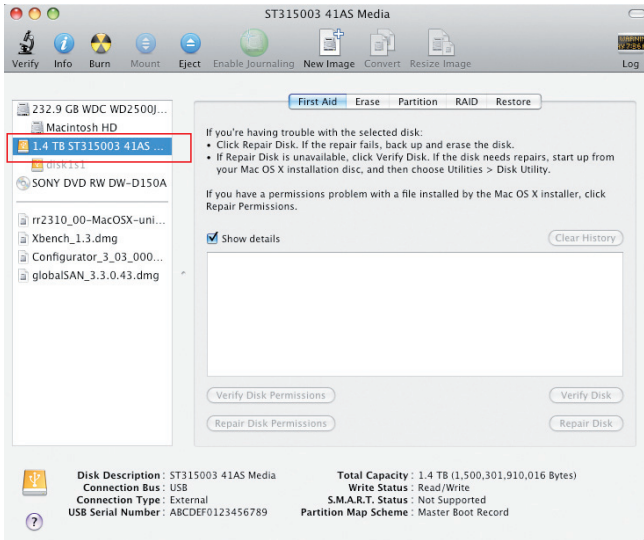

2. Add in GR3630 hard disk name and do formatting operation.

※ Choose hard disk formatting and disk drive name setting (can be set as GR3630)

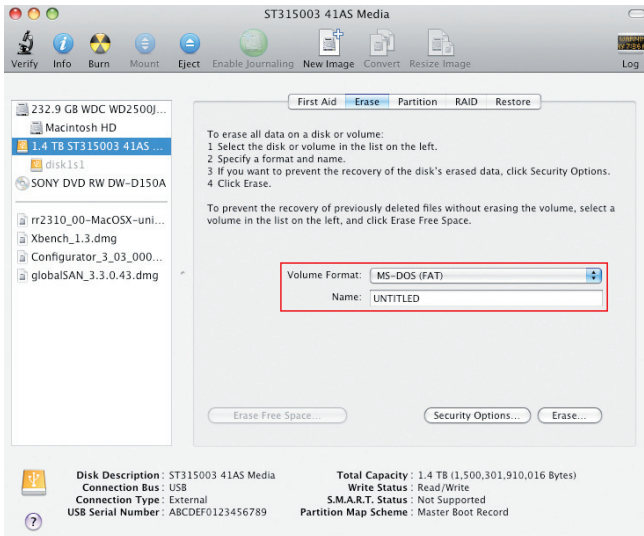

※ After finish setting the disk drive, please click Erase buttons ❶ & ❷, then start formatting the hard drive.

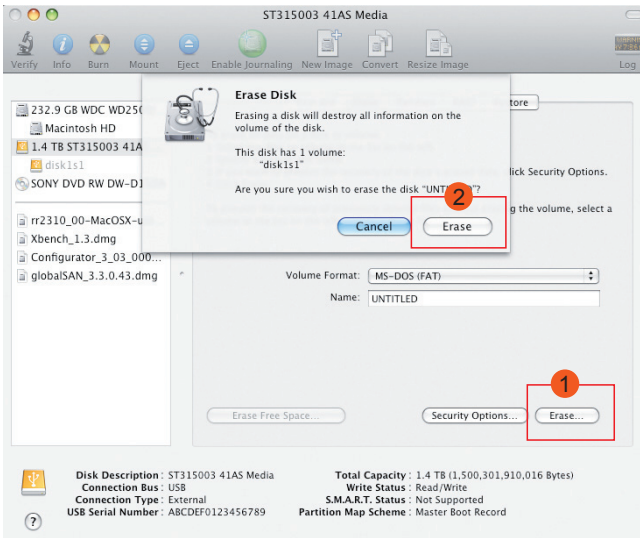

3. Setting is finished, you can start using this product.

※ After finish formatting the hard disk, it will display the disk drive name GR3630.

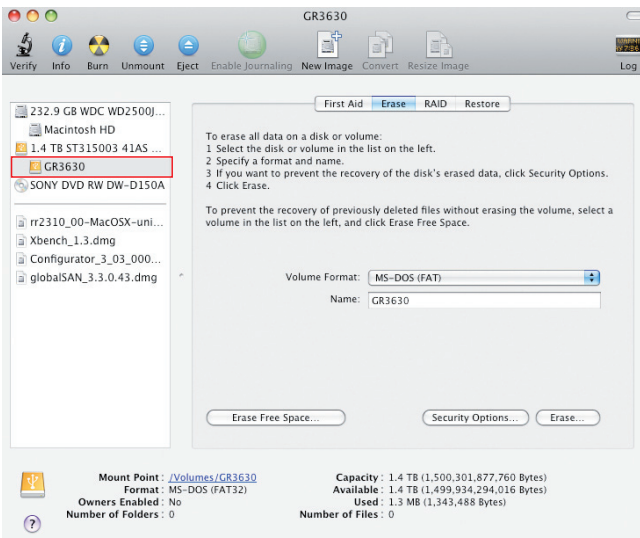

※ The desktop will automatically create a disk drive name GR3630, you can start using this product.

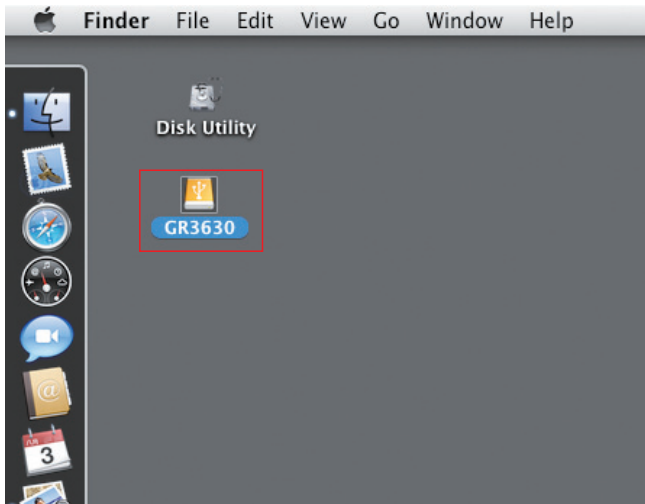

3.4 An introduction to other functions

3.4.1 LCD monitor operation guide

※ GR3630-SB3

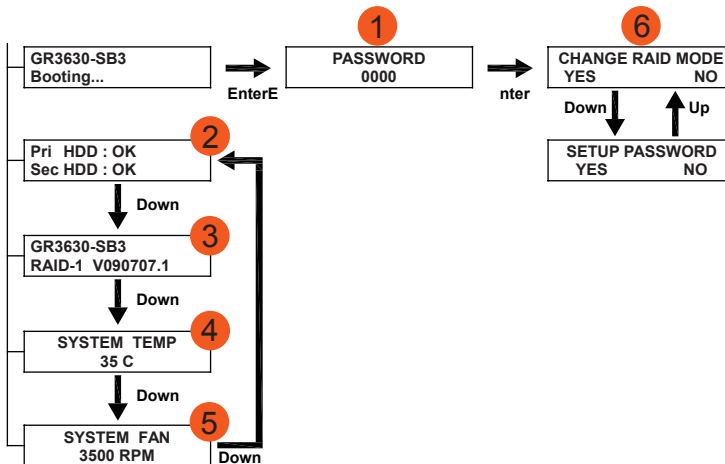

1. After power ON and before entering standby screen, click on ENTER key, you will enter into product function setup options (product default password is: 0000)
2. Upon booting, the standard standby screen will display the hard disk operation status.
3. It will display product model/RAID level/firmware edition.
4. It will display system temperature.
5. It will display fan rotation.

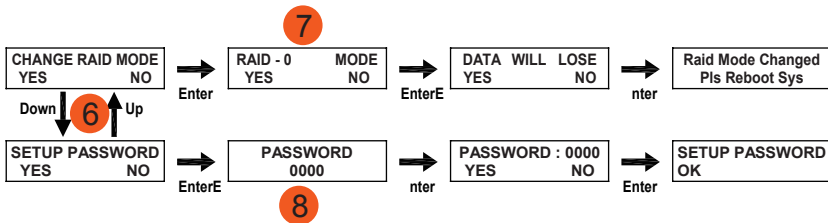

6. There are two functional setup options, one of them is RAID level setting, and the other is login password setting.
7. The factory default setting of RAID level is RAID-1, therefore, upon entering, you will be asked whether or not to change RAID-0. A change of RAID level would cause the original hard disk data to get lost, please pay special attention to it.
8. Use UP/DOWN key to input custom password. Password changing is to allow users to customize their personal preferences. After it has been changed, please record the password personally. Should you forget about it, it would cause disturbances to application.

※ GR3630-WSB3

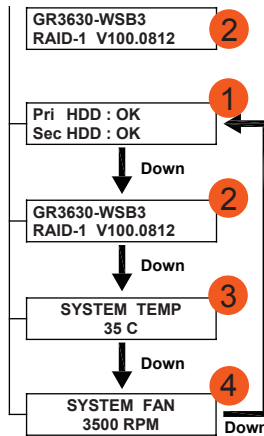

1. Upon booting, the standard standby screen will display the hard disk operation status.
2. It will display product model/RAID level/firmware edition.
3. It will display system temperature.
4. It will display fan rotation.

3.4.2 LCD monitor message guide

①	Pri HDD : OK Sec HDD : OK
②	Pri HDD : OK Sec HDD : MISSING
③	Pri HDD : OK Sec HDD : FAILED
④	Pri HDD : OK Sec HDD : OK
⑤	Pri HDD : OK Sec HDD : OK

Common messages

1. OK: hard disk status is normal.
2. Missing: You have not installed hard disk

3. Failed: You have installed hard disk, but it has failed to operate.
4. F: When F appears on the top right corner of monitor, it represents that the fan has already malfunctioned and is not working.
Please visual inspect whether or not the fan has stopped working. If the malfunction is confirmed, please return it to original factory to repair.
5. T: When T appears on the right bottom corner of monitor, it represents that the interior temperature of product is too high (exceeding 60°C). If it is being used for a long period of time under an overheated condition, it would damage the hard disks. We suggest you to switch off the power to allow the temperature to drop before rebooting.

Appendix A Frequently asked questions

Q: Is it alright to use RAID 1 to do hard disk backup function?

A: Yes. RAID 1 is a mirror function itself. If your hard disk requires RAID 1 to do backup function, please place your hard disk containing data in Pri HDD (Source) position to set as RAID 1, and after booting, place the new hard disk in Sec HDD (Target) position. The system will do data backup function automatically. After GR3630 has finished rebuilding, the data in two hard disks would be exactly the same.

Q: Is it alright to use a single hard disk under RAID 1?

A: Yes, but it would completely lose its originally RAID 1 data security function. We suggest you to use two hard disks under RAID 1 mode to ensure data security. Under a single hard disk, RAID 1 is unable to perform mirroring function. If one hard disk is damaged, the interior data would be destroyed completely. Whenever one hard disk is damaged, we suggest you to replace it with a new one as soon as possible.

Q: If GR3630 LCD monitor displays an error in hard disk, what should I do?

A: If you are using RAID 0 mode, please ensure which hard disk has caused the error and switch off the power of GR3630, remove the damaged hard disk and replace it with a new one. After rebooting, the system will rebuild RAID 0 system, but the original data would all be lost. If you are using RAID 1 mode, you can remove the damaged hard disk and replace it with a new one directly without having to switch off power. After the new hard disk has been inserted, the system will start to “rebuild” program automatically. After finish rebuilding, you can then use it normally. Please note that during the process of system data rebuilding, do not remove any hard disk to ensure an integrity of data.

※ Under RAID 1 status, the data “rebuild” process.
Under the circumstance that Sec HD is damaged ...

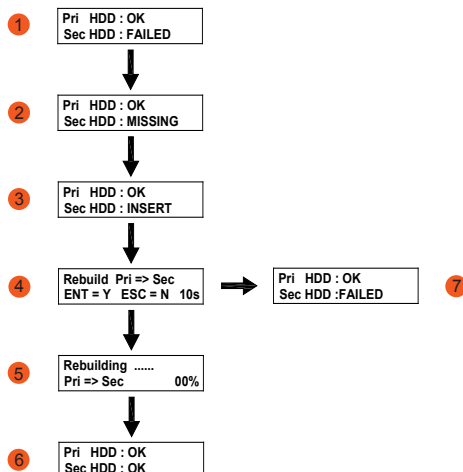

1. Sec HDD has found to be damaged
2. Remove the damaged Sec HDD
3. Insert a new hard disk into Sec HDD position
4. After about 5 seconds, the system will ask you whether or not to rebuild? If you do, please click on ENTER key; if not, please click on ESC key.
5. After confirming to rebuild data, GR3630 will start to copy hard disk data and display the working progress.
6. After finish copying the data, it will return to standby screen.
7. If you choose to abandon data rebuilding, the screen will return to a screen that reminds user that Sec HDD has been destroyed (same as screen 1).

Under the circumstance that Pri HDD is damaged ...

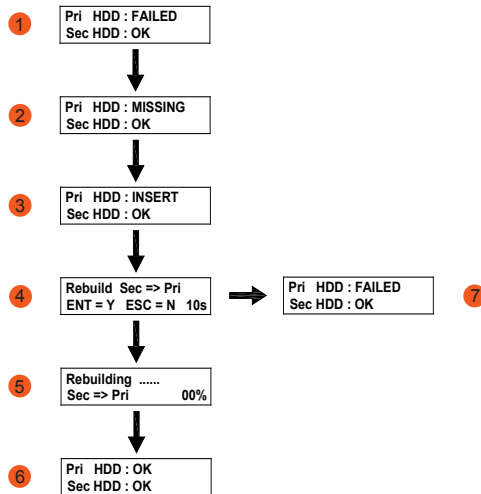

1. Pri HDD has found to be damaged
2. Remove the damaged Pri HDD
3. Insert a new hard disk into Pri HDD position
4. After about 5 seconds, the system will ask you whether or not to rebuild? If you do, please click on ENTER key; if not, please click on ESC key.

5. After confirming to rebuild data, GR3630 will start to copy hard disk data and display the working progress.
6. After finish copying the data, it will return to standby screen.
7. If you choose to abandon data rebuilding, the screen will return to a screen that reminds user that Primary HDD has been destroyed (same as screen 1).

Q: Do GR3630 Series have volume limitation?

A: If you want to use GR3630 with the volume over 2TB (RAID 0 mode), please make sure that your computer and the operating system are both 64-bit or above. Or the computer may not work well with GR3630. (Due to the hardware limitation, the 32 bit PC and OS can only support storage volume under 2TB.)

RAID GUI Instruction

RAID GUI is the software for device status monitoring and firmware upgrades self-developed by RAIDON for RAIDON 2045 RAID chip. RAID GUI can be executed directly without installation and only under Windows operating system.

Please refer to the definitions of each function below:

1. System Status

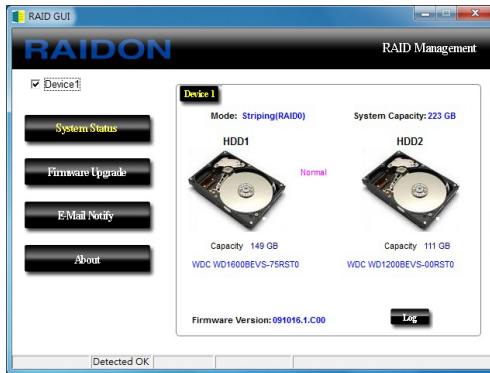

“System Status” indicates the instant status and information of installed storage drives, also by click on “Log” button from the lower right corner will give the records of event log. (Concurrent events will also be recorded to the log which automatically saved in the same folder of RAID GUI software.)

When two of the same storage devices are installed, you may switch the corresponding storage device by selecting device number as “Device 1” from the upper left corner. RAID GUI management only supports maximum of 2 storage devices.

2. Firmware Upgrade

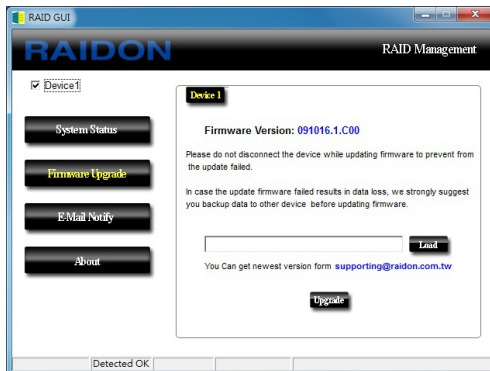

“Firmware Upgrade” allows for the upgrades to the firmware of corresponding device, also indicates the existing version of firmware to the corresponding device.

! Note : If installed storage device operates normally, we strongly recommend not upgrading the existing firmware.

3. E-Mail Notify

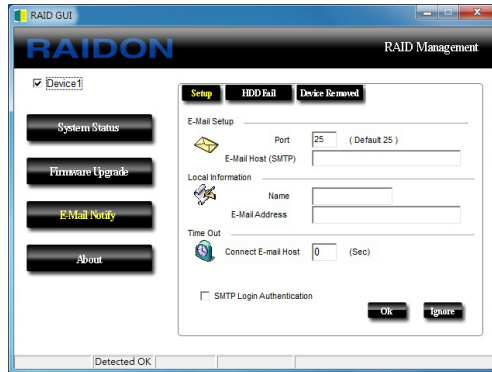

“E-Mail Notify” provides auto E-Mail notifications of HDD removal or failures to the designated E-Mail addressee. (“E-Mail notify” can be disabled temporarily or permanently after configuration by selecting “Don’t send Email for this event” from each error options.)

! Note : This function activates only under operating states of RAID GUI.

4. About



“About” indicates the version of RAID Management, the RAID GUI software.

Energy saving

1. GR3630 and the OS are synchronized to standby/sleep/shut down mode for green and cost saving. Also, GR3630 is recovered for normal usage while operating/powering on the PC.
2. GR3630 will change to energy saving mode after switching on the power, also the fan, LCD and HDD will stop its operation, which is a normal condition. After connecting to the PC, GR3630 will operate normally.
3. Please always connect the USB cable to the computer for ensuring the energy saving function operating normally.
4. If the temperature of GR3630 is over 55° under energy saving mode, the fan will rotate automatically until the temperature cool down. Besides, after the temperature is cooling down, the fan will turn to standby mode and stop working.
5. During data auto-rebuilding, GR3630 will complete the process once it on synchronization. And, after the rebuilding progress is finished, GR3630 will be synchronized for energy saving as well.
6. Required version: GR3630-SB3 PCB Version V1.1 above; GR3630-WSB3 PCB V2.0 above

If you want to check the PCBA version, please take out the HDD tray to examine it.

