

IGBT FOUR PAK MODULE

Features

- Square RBSOA
- HEXFRED low Q_{rr} , low Switching Energy
- Positive $V_{CE(on)}$ Temperature Coefficient
- Copper Baseplate
- Low Stray Inductance Design



ECONO2 4PAK

$$V_{CES} = 1200V$$

$$I_C = 75A @ T_C = 67^\circ C$$

$$V_{CE(on) \text{ typ.}} = 3.4V$$

Benefits

- Benchmark Efficiency for SMPS appreciation in particular HF welding
- Rugged Transient Performance
- Low EMI, Requires Less Snubbing
- Direct Mounting to Heatsink space saving
- PCB Solderable Terminals
- Low Junction to Case Thermal Resistance

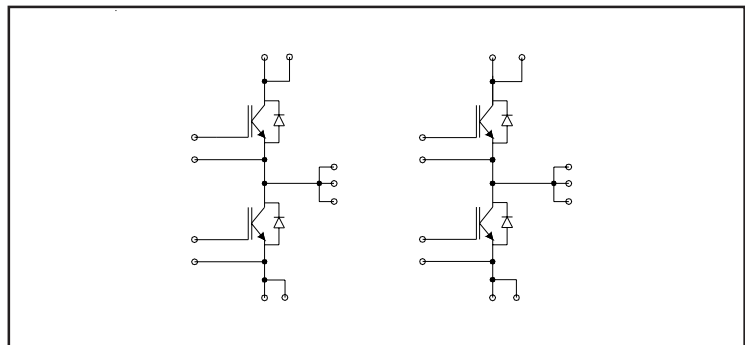

Absolute Maximum Ratings

	Parameter	Max.	Units
V_{CES}	Collector-to-Emitter Voltage	1200	V
$I_C @ T_C=25^\circ C$	Continuous Collector Current	100	A
$I_C @ T_C=80^\circ C$	Continuous Collector Current	67	
I_{CM}	Pulsed Collector Current (Ref. Fig. C.T.5)	200	
I_{LM}	Clamped Inductive Load Current	200	
$I_F @ T_C=25^\circ C$	Diode Continuous Forward Current	40	
$I_F @ T_C=80^\circ C$	Diode Continuous Forward Current	25	
I_{FM}	Diode Maximum Forward Current	150	
V_{GE}	Gate-to-Emitter Voltage	± 20	V
$P_D @ T_C=25^\circ C$	Maximum Power Dissipation (IGBT)	480	W
$P_D @ T_C=80^\circ C$	Maximum Power Dissipation (IGBT)	270	
T_J	Maximum Operating Junction Temperature	150	$^\circ C$
T_{STG}	Storage Temperature Range	-40 to +125	
V_{ISOL}	Isolation Voltage	AC 2500 (MIN)	V

Thermal and Mechanical Characteristics

	Parameter	Min	Typical	Maximum	Units
$R_{\theta JC}$ (IGBT)	Junction-to-Case IGBT	-	-	0.26	$^\circ C/W$
$R_{\theta JC}$ (Diode)	Junction-to-Case Diode	-	-	1.00	
$R_{\theta CS}$ (Module)	Case-to-Sink, flat, greased surface	-	0.05	-	
	Mounting Torque (M5)	2.7	-	3.3	N*m
	Weight	-	170	-	g

Electrical Characteristics @ T_J = 25°C (unless otherwise specified)

	Parameter	Min.	Typ.	Max.	Units	Conditions
BV _(CES)	Collector-to-Emitter Breakdown Voltage	1200	-	-	V	V _{GE} = 0 IC = 500μA
V _{CE(ON)}	Collector-to-Emitter Voltage	-	3.4	4.0	V	I _C = 75A V _{GE} = 15V
		-	3.8	4.5		I _C = 100A V _{GE} = 15V
		-	4.0	4.5		I _C = 75A V _{GE} = 15V T _J = 125°C
		-	4.53	5.1		I _C = 100A V _{GE} = 15V T _J = 125°C
V _{GE(th)}	Gate Threshold Voltage	4.0	5.0	6.0		V _{CE} = V _{GE} IC = 250μA
ΔV _{GE(th)} /ΔT _J	Threshold Voltage temp. coefficient	-	-11	-	mV/°C	V _{CE} = V _{GE} IC = 1mA (25°C-125°C)
I _{CES}	Zero Gate Voltage Collector Current	-	7	250	μA	V _{GE} = 0 V _{CE} = 1200V
		-	580	2000		V _{GE} = 0 V _{CE} = 1200V T _J = 125°C
V _{FM}	Diode Forward Voltage Drop	-	3.9	5.0	V	I _F = 75A
		-	4.43	5.8		I _F = 100A
		-	4.37	5.4		I _F = 75A T _J = 125°C
		-	5.02	6.4		I _F = 100A T _J = 125°C
I _{GES}	Gate-to-Emitter Leakage Current	-	-	± 200	nA	V _{GE} = ±20V

Switching Characteristics @ T_J = 25°C (unless otherwise specified)

	Parameter	Min.	Typ.	Max.	Units	Conditions
Q _G	Total Gate Charge (turn-on)	-	630	-	nC	I _C = 50A
Q _{GE}	Gate-to-Emitter Charge (turn-on)	-	65	-		V _{CC} = 600A
Q _{GC}	Gate-to-Collector Charge (turn-on)	-	250	-		V _{GE} = 15V
E _{ON}	Turn-On Switching Loss	-	1505	-	μJ	I _C = 50A V _{CC} = 600V
E _{OFF}	Turn-Off Switching Loss	-	2411	-		V _{GE} = 15V R _G = 4.7Ω L = 500μH
E _{TOT}	Total Switching Loss	-	3916	-		T _J = 25°C ①
E _{ON}	Turn-On Switching Loss	-	2248	-	μJ	I _C = 50A V _{CC} = 600V
E _{OFF}	Turn-Off Switching Loss	-	3351	-		V _{GE} = 15V R _G = 4.7Ω L = 500μH
E _{TOT}	Total Switching Loss	-	7599	-		T _J = 125°C ①
t _{d(on)}	Turn-On delay time	-	169	-	ns	I _C = 50A V _{CC} = 600V
t _r	Rise time	-	71	-		V _{GE} = 15V R _G = 4.7Ω L = 500μH
t _{d(off)}	Turn-Off delay time	-	393	-		T _J = 125°C
t _f	Fall time	-	136	-		
RBSOA	Reverse Bias Safe Operating Area	FULL SQUARE				T _J = 150°C I _C = 150A R _G = 10Ω V _{GE} = 15V to 0
SCSOA	Short Circuit Safe Operating Area	10	-	-	μs	T _J = 150°C V _{CC} = 900V V _P = 1200V R _G = 10Ω V _{GE} = 15V to 0
I _{rr}	Diode Peak Rev. Recovery Current	-	1.45	2.5	A	T _J = 25°C
		-	2.35	4.0		T _J = 125°C
t _{rr}	Diode Rev. Recovery Time	-	0.401	0.5	μs	T _J = 25°C V _{CC} = 600V I _F = 75A
		-	0.655	0.8		T _J = 125°C dl/dt = 10A/μs
Q _{rr}	Total Rev. Recovery Charge	-	0.181	0.4	μC	T _J = 25°C
		-	0.54	1.5		T _J = 125°C

① Energy losses include "tail" and diode reverse recovery.

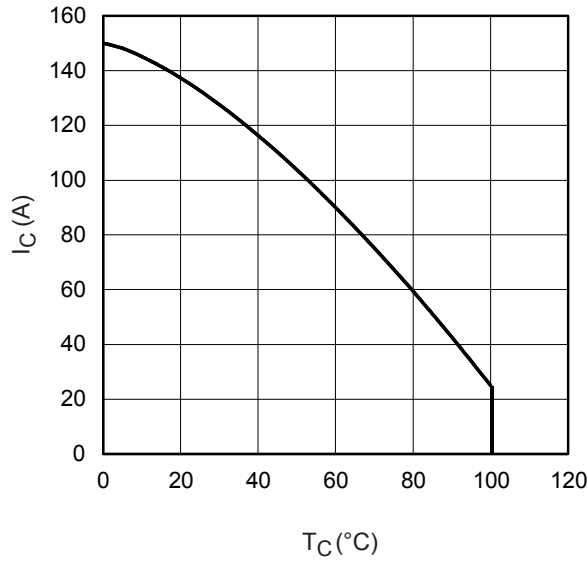

Fig. 1 - Maximum DC Collector Current vs. Case Temperature

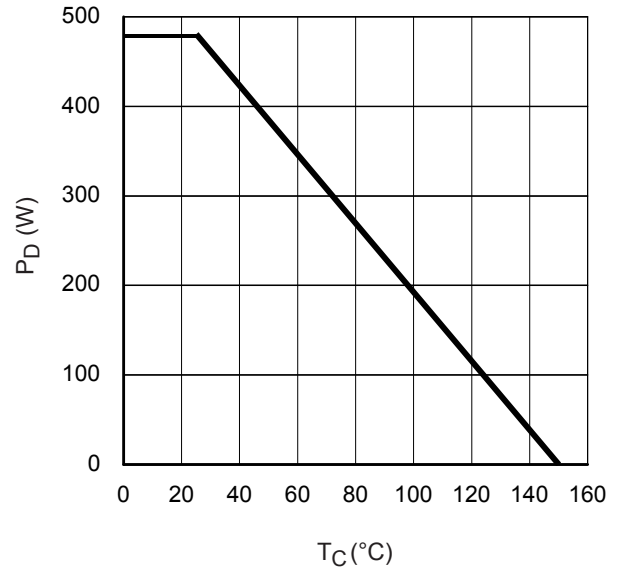

Fig. 2 - Power Dissipation vs. Case Temperature

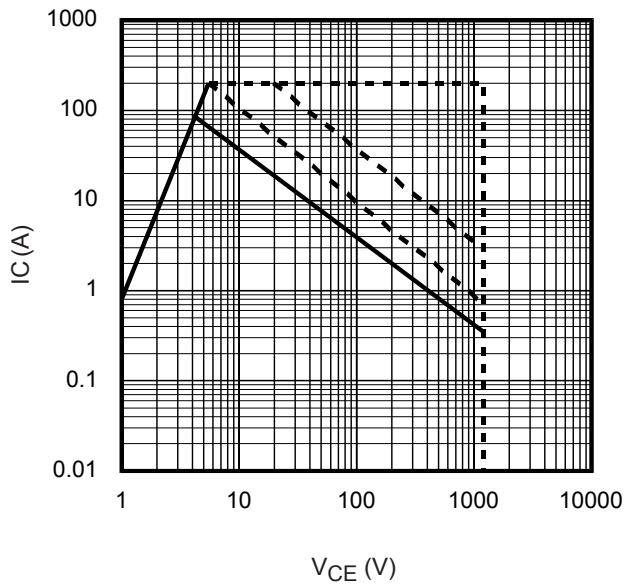

Fig. 3 - Forward SOA
 $T_C = 25^{\circ}C$; $T_J \leq 150^{\circ}C$

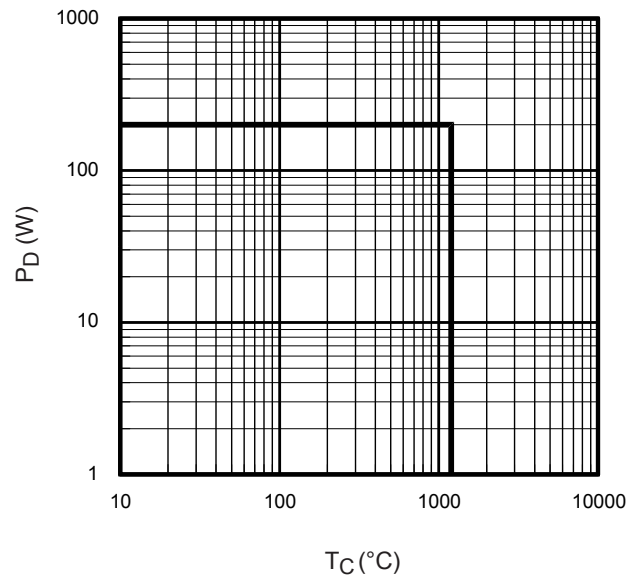

Fig. 4 - Reverse Bias SOA
 $T_J = 150^{\circ}C$; $V_{GE} = 15V$

GB75YF120N

Bulletin I27209 01/06

International
IGOR Rectifier

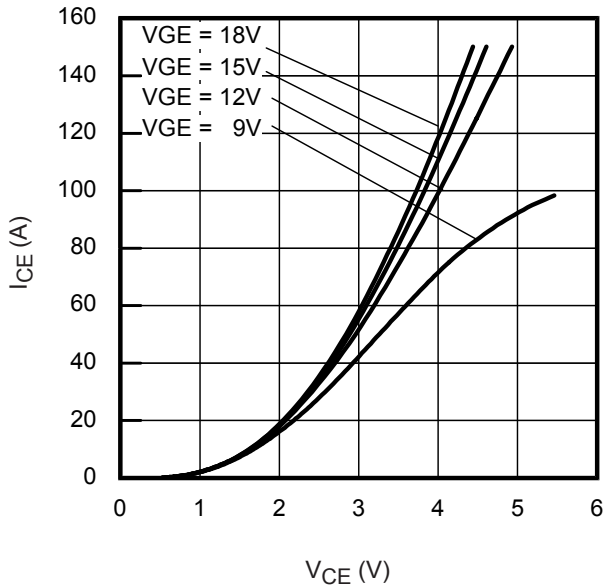

Fig. 5 - Typ. IGBT Output Characteristics
 $T_J = 25^\circ\text{C}$; $t_p = 500\mu\text{s}$

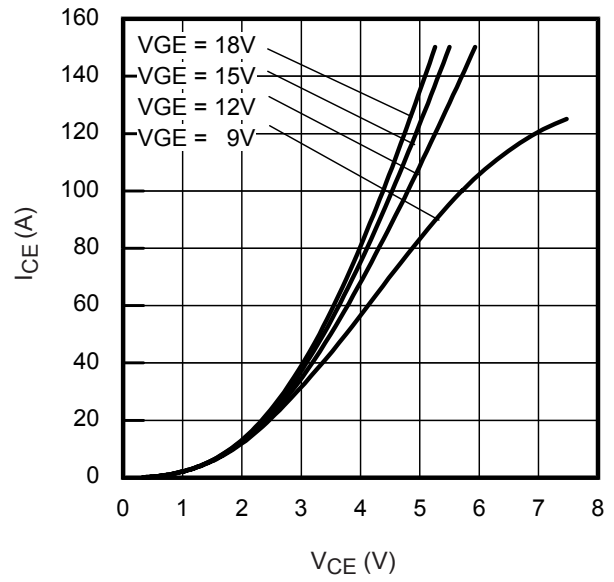

Fig. 6 - Typ. IGBT Output Characteristics
 $T_J = 125^\circ\text{C}$; $t_p = 500\mu\text{s}$

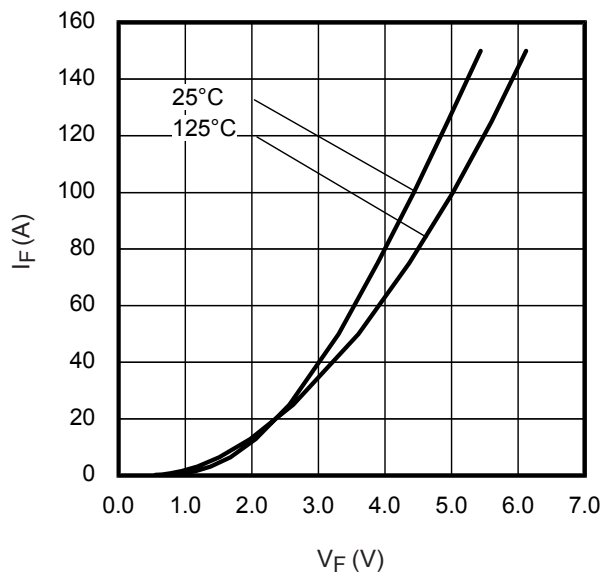

Fig. 7 - Typ. Diode Forward Characteristics
 $t_p = 500\mu\text{s}$

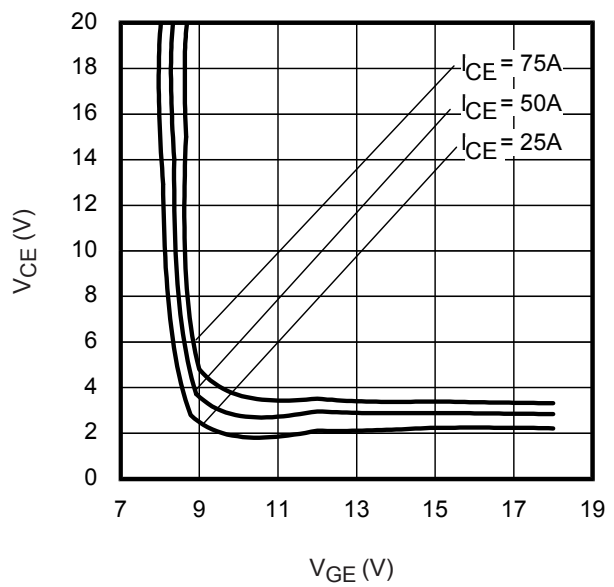

Fig. 8 - Typical V_{CE} vs. V_{GE}
 $T_J = 25^\circ\text{C}$

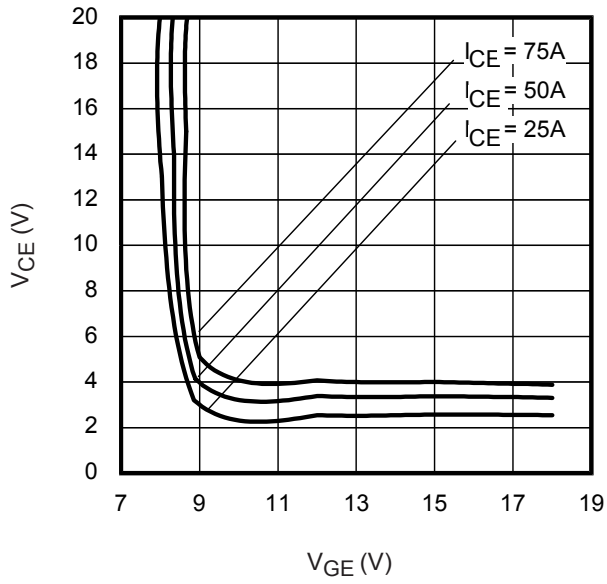

Fig. 9 - Typical V_{CE} vs. V_{GE}
 $T_J = 125^\circ C$

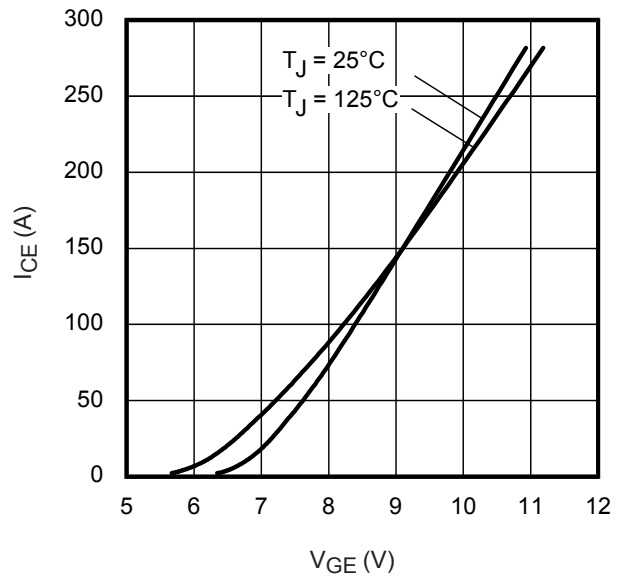

Fig. 10 - Typ. Transfer Characteristics
 $V_{CE} = 20V$; $t_p = 500\mu s$

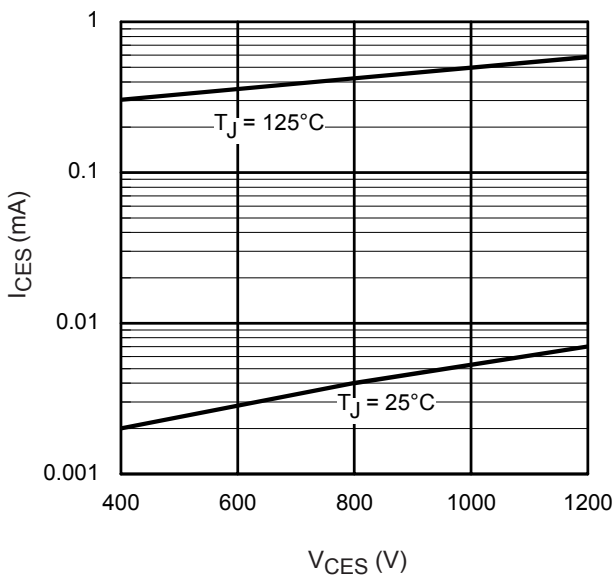

Fig. 11 - Typ Zero Gate Voltage Collector Current

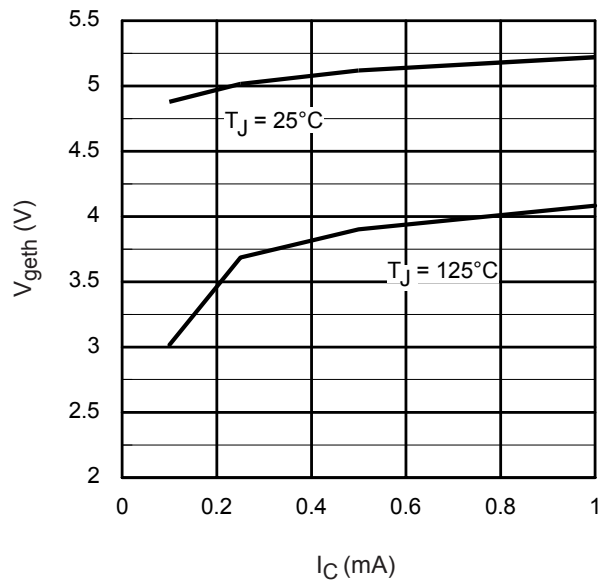

Fig. 12 - Typ Threshold Voltage

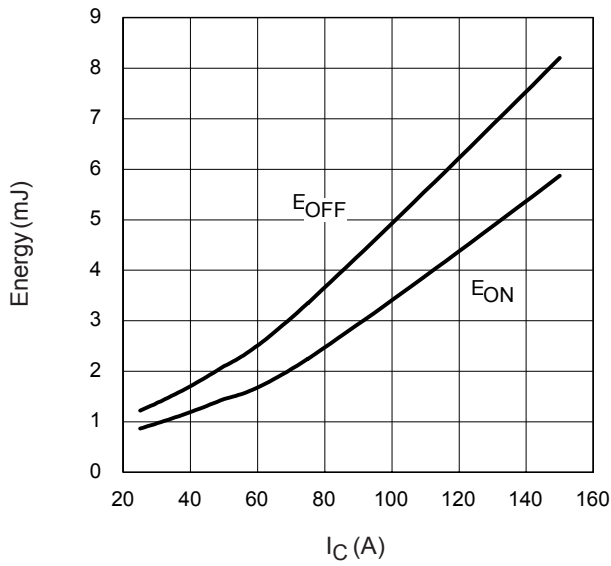

Fig. 13 - Typ. Energy Loss vs. I_C
 $T_J = 125^\circ\text{C}$; $L = 200\mu\text{H}$; $V_{CE} = 600\text{V}$
 $R_G = 5\Omega$; $V_{GE} = 15\text{V}$

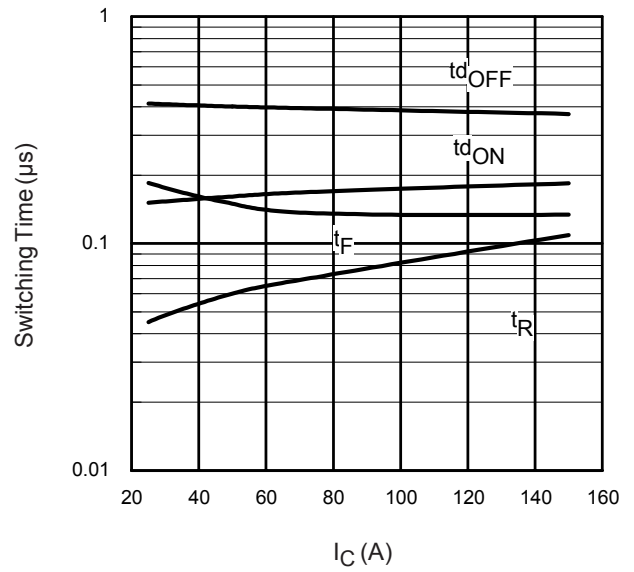

Fig. 14 - Typ. Switching Time vs. I_C
 $T_J = 125^\circ\text{C}$; $L = 200\mu\text{H}$; $V_{CE} = 600\text{V}$
 $R_G = 5\Omega$; $V_{GE} = 15\text{V}$

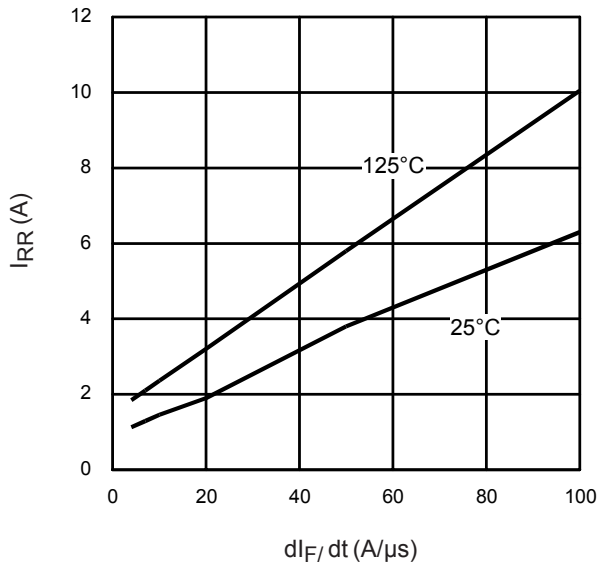

Fig. 15- Typical Diode I_{REC} vs. di_F/dt
 $V_{CC} = 600\text{V}$; $I_F = 50\text{A}$

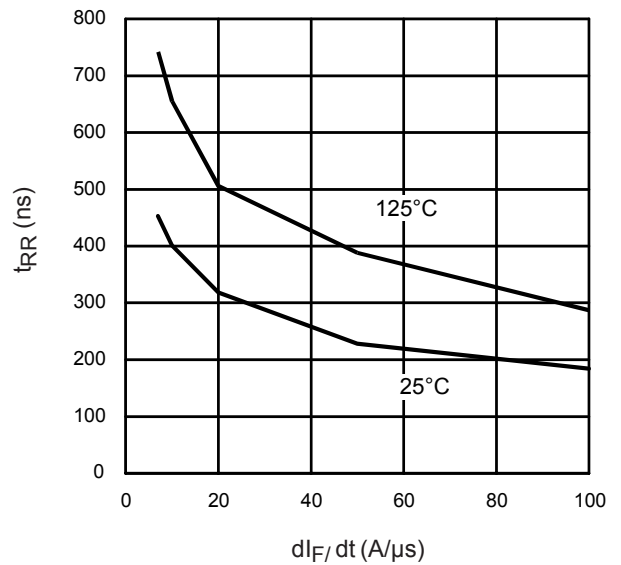

Fig. 16- Typical Diode t_{RR} vs. di_F/dt
 $V_{CC} = 600\text{V}$; $I_F = 50\text{A}$

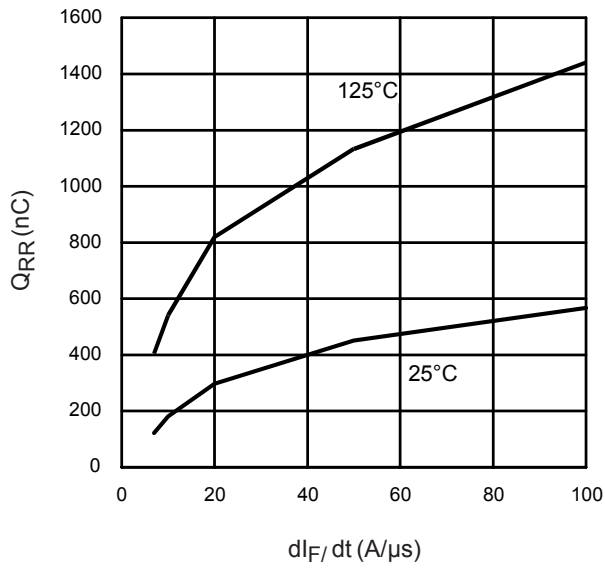

Fig. 17 - Typical Diode Q_{RR} vs. di_F/dt
 V_{CC} = 600V; I_F = 50A

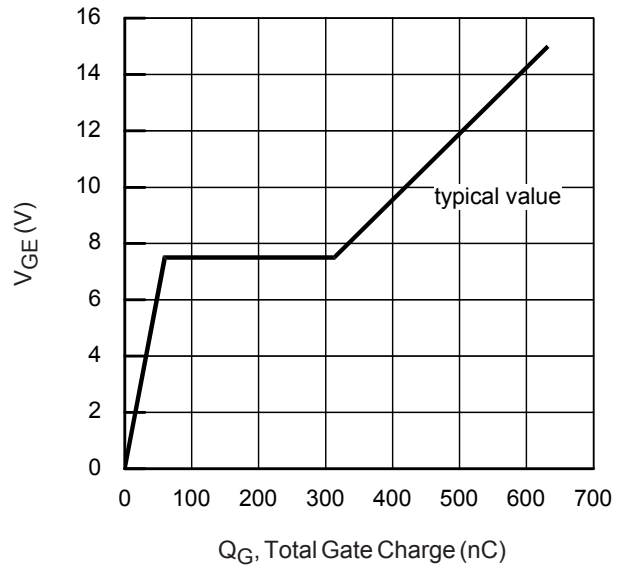

Fig. 18 - Typical Gate Charge vs. V_{GE}
 I_{CE} = 5.0A; L = 600μH

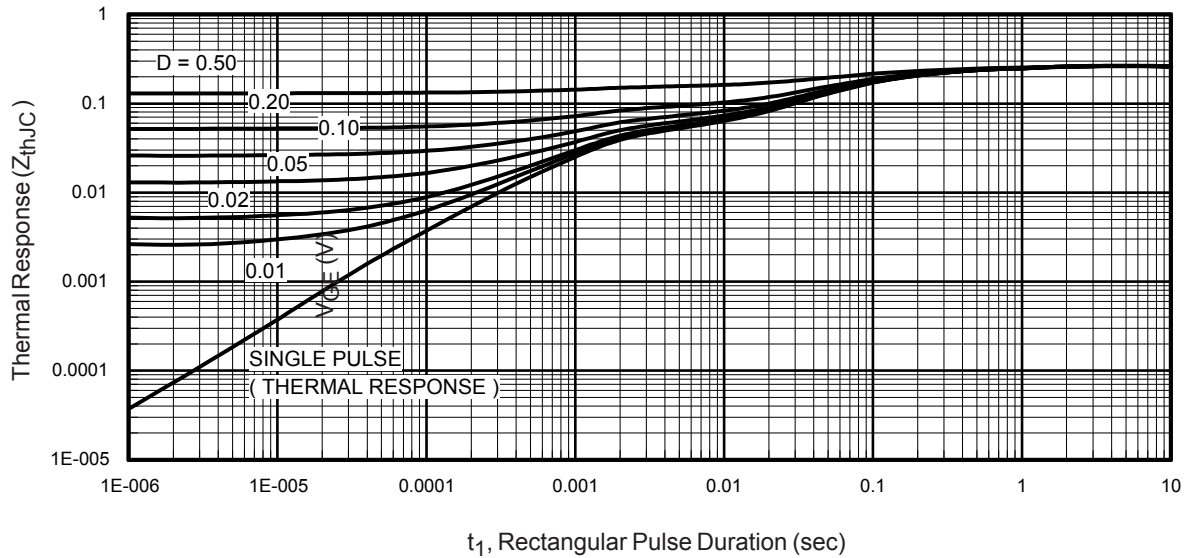

Fig 19 - Maximum Transient Thermal Impedance, Junction-to-Case (IGBT)

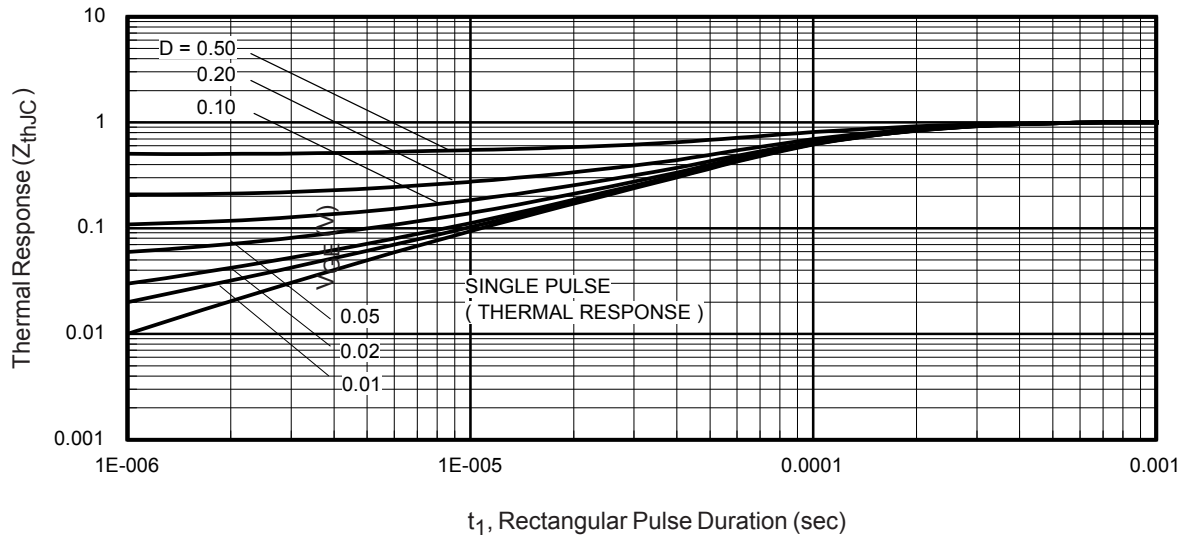

Fig 20 - Maximum Transient Thermal Impedance, Junction-to-Case (DIODE)

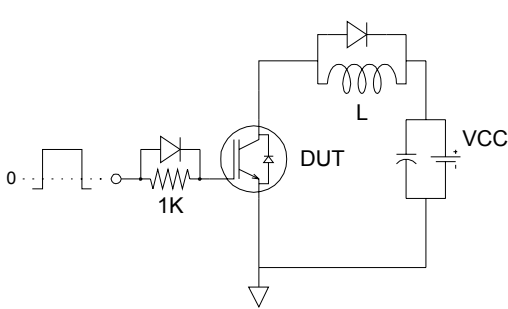

Fig.C.T.1 - Gate Charge Circuit (turn-off)

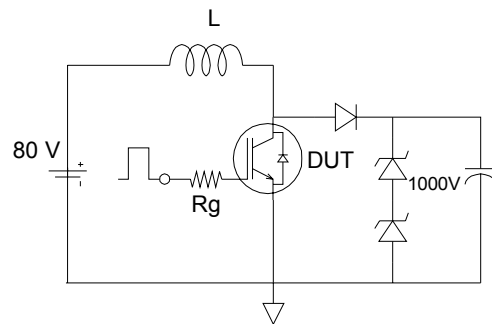

Fig.C.T.2 - RBSOA Circuit

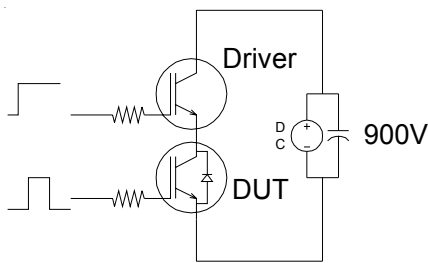

Fig.C.T.3 - S.C. SOA Circuit

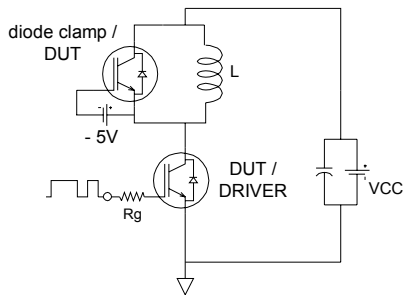

Fig.C.T.4 - Switching Loss Circuit

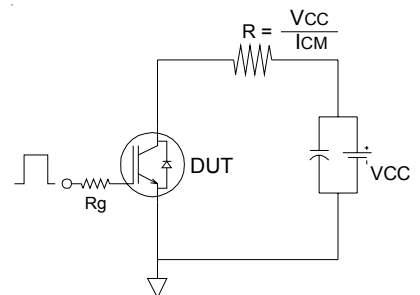
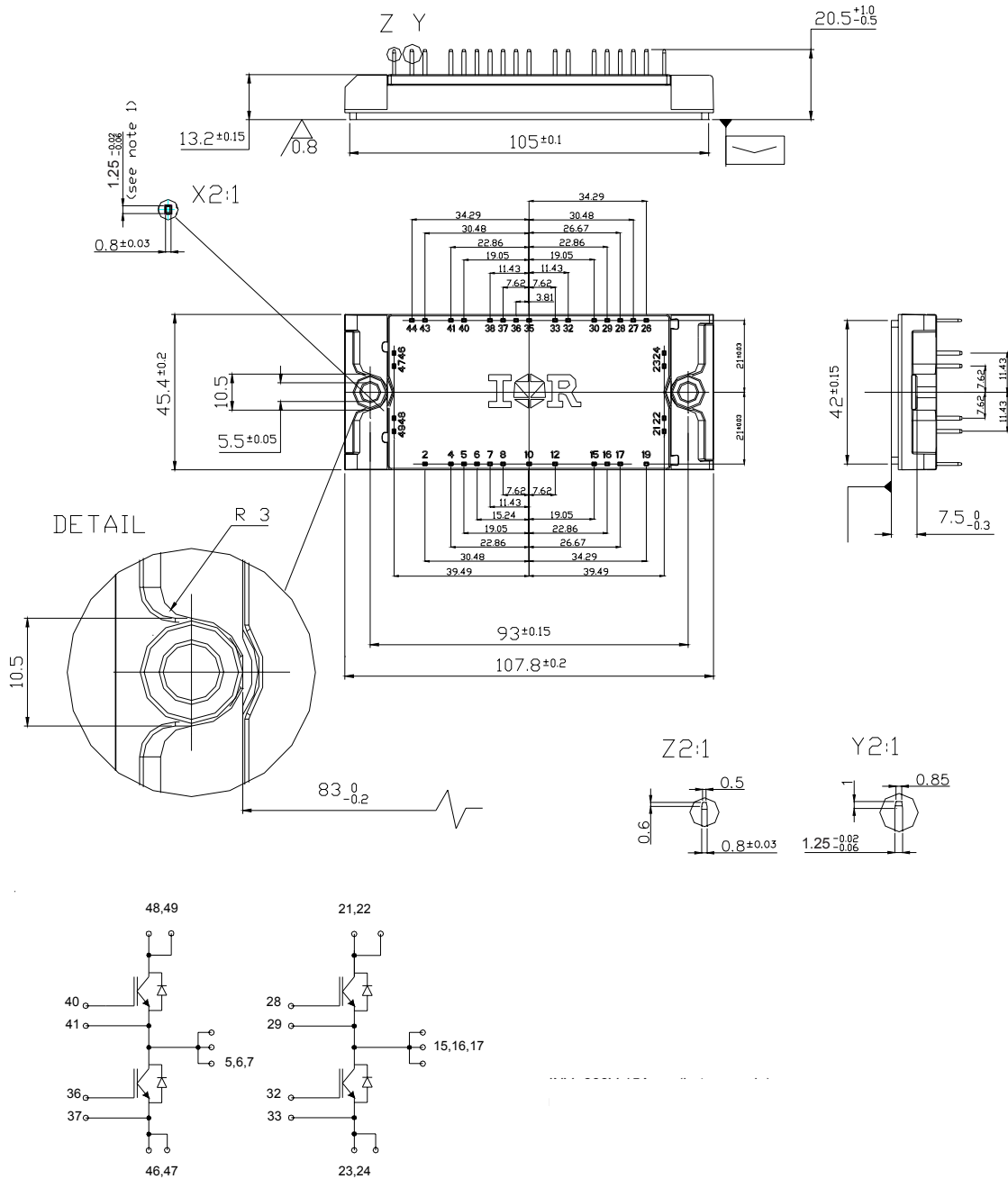

Fig.C.T.5 - Resistive Load Circuit

Econo2 4Pak Package Outline

Dimensions are shown in millimeters (inches)



Data and specifications subject to change without notice.
 This product has been designed and qualified for Industrial market.
 Qualification Standards can be found on IR's Web site.