

IRCZ34PbF

HEXFET® Power MOSFET

- Dynamic dv/dt Rating
- Current Sense
- 175°C Operating Temperature
- Fast Switching
- Ease of Paralleling
- Simple Drive Requirements
- Lead-Free

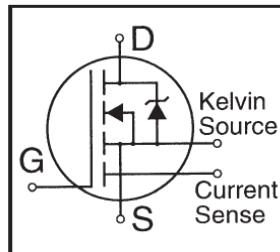

$V_{DSS} = 60V$
$R_{DS(on)} = 0.050\Omega$
$I_D = 30A$

Description

Third Generation HEXFETs from International Rectifier provide the designer with the best combination of fast switching, ruggedized device, low on-resistance and cost-effectiveness.

The HEXSense device provides an accurate fraction of the drain current through the additional two leads to be used for control or protection of the device. These devices exhibit similar electrical and thermal characteristics as their IRF-series equivalent part numbers. The provision of a kelvin source connection effectively eliminates problems of common source inductance when the HEXSense is used as a fast, high-current switch in non current-sensing applications.

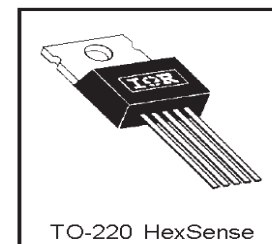

Absolute Maximum Ratings

Parameter		Max.	Units
$I_D @ T_C = 25^\circ C$	Continuous Drain Current, $V_{GS} @ 10V$	30	A
$I_D @ T_C = 100^\circ C$	Continuous Drain Current, $V_{GS} @ 10V$	21	
I_{DM}	Pulsed Drain Current ①	120	
$P_D @ T_C = 25^\circ C$	Power Dissipation	88	W
	Linear Derating Factor	0.59	W/C
V_{GS}	Gate-to-Source Voltage	± 20	V
E_{AS}	Single Pulse Avalanche Energy ②	15	mJ
dv/dt	Peak Diode Recovery dv/dt ③	4.5	A
T_J	Operating Junction and	-55 to + 175	°C
T_{STG}	Storage Temperature Range		
	Soldering Temperature, for 10 seconds	300 (1.6mm from case)	
	Mounting Torque, 6-32 or screw	10 lbf•in (1.1 N•m)	

Thermal Resistance

	Parameter	Min.	Max.	Units	
$R_{\theta JC}$	Junction-to-Case	—	—	1.7	°C/W
$R_{\theta CS}$	Case-to-Sink, Flat, Greased Surface	—	0.50	—	
$R_{\theta JA}$	Junction-to-Ambient	—	—	62	

** When mounted on FR-4 board using minimum recommended footprint. For recommended footprint and soldering techniques refer to application note #AN-994.

Electrical Characteristics @ T_J = 25°C (unless otherwise specified)

Parameter	Min.	Typ.	Max.	Units	Conditions
V _{(BR)DSS}	60	—	—	V	V _{GS} = 0V, I _D = 250μA
ΔV _{(BR)DSS/ΔT_J}	—	0.065	—	V/°C	Reference to 25°C, I _D = 1mA
R _{DS(ON)}	—	—	0.050	Ω	V _{GS} = 10V, I _D = 18A④
V _{GS(th)}	2.0	—	4.0	V	V _{DS} = V _{GS} , I _D = 250μA
g _{fs}	9.4	—	—	S	V _{DS} = 25V, I _D = 18A
I _{DSS}	—	—	25		V _{DS} = 60V, V _{GS} = 0V
	—	—	250		V _{DS} = 48V, V _{GS} = 0V, T _J = 150°C
I _{GSS}	—	—	100		V _{GS} = 20V
	—	—	-100		V _{GS} = -20V
Q _g	—	—	46		I _D = 30A
Q _{gs}	—	—	11	nC	V _{DS} = 48V
Q _{gd}	—	—	22		V _{GS} = 10V, See Fig. 6 and 13 ④
t _{d(on)}	—	13	—		V _{DD} = 30V
t _r	—	100	—		I _D = 30A
t _{d(off)}	—	29	—		R _G = 12Ω
t _f	—	52	—		R _D = 1.0Ω, See Fig. 10 ④
L _D	—	4.5	—	nH	Between lead, 6 mm (0.25 in.) from package and center of die contact
L _C	—	7.5	—		
C _{iss}	—	1300	—		V _{GS} = 0V
C _{oss}	—	640	—	pF	V _{DS} = 25V
C _{rss}	—	96	—		f = 1.0MHz, See Fig. 5
r	1340	—	1480	—	I _D = 30A, V _{GS} = 10V
C _{oss}	—	9.0	—	pF	V _{GS} = 0V, V _{DS} = 25V, f = 1.0MHz

Source-Drain Ratings and Characteristics

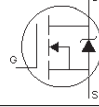
Parameter	Min.	Typ.	Max.	Units	Conditions
I _S	—	—	30	A	MOSFET symbol showing the integral reverse p-n junction diode. 
I _{SM}	—	—	120		
V _{SD}	—	—	1.6	V	T _J = 25°C, I _S = 30A, V _{GS} = 0V ④
t _{rr}	—	120	230	ns	T _J = 25°C, I _F = 30A
Q _{rr}	—	0.70	1.4	nC	di/dt = 100A/μs ④
t _{on}	Intrinsic turn-on time is negligible (turn-on is dominated by L _S +L _D)				

Notes:

① Repetitive rating; pulse width limited by max. junction temperature. (See fig. 11)

③ I_{SD} ≤ 30A, di/dt ≤ 200A/μs, V_{DD} ≤ V_{(BR)DSS}, T_J ≤ 175°C

② V_{DD} = 25V, starting T_J = 25°C, L = 0.019mH
R_G = 25Ω, I_{AS} = 30A. (See Figure 12)

④ Pulse width ≤ 300μs; duty cycle ≤ 2%.

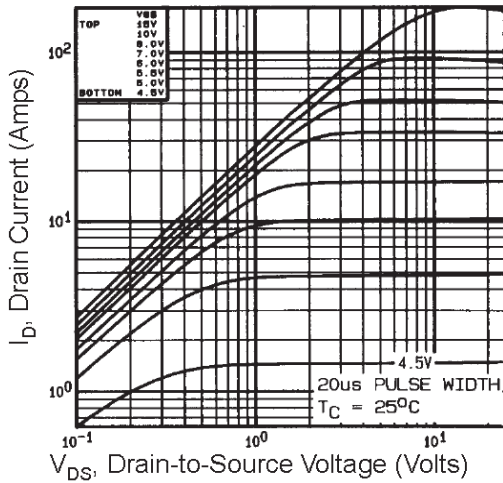

Fig. 1 Typical Output Characteristics,
 $T_c=25^\circ\text{C}$

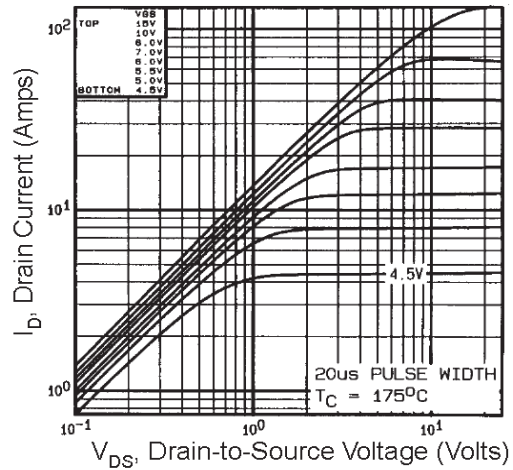

Fig. 2 Typical Output Characteristics,
 $T_c=175^\circ\text{C}$

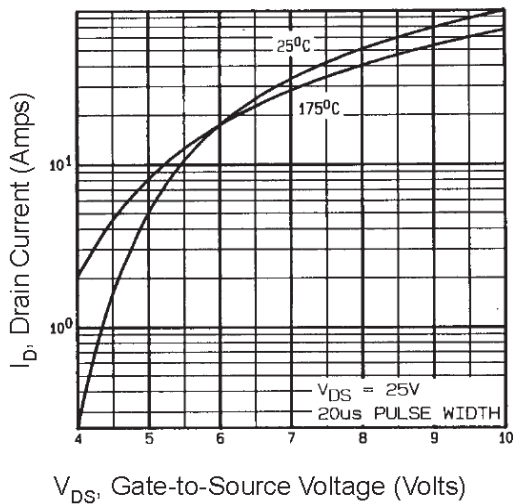

Fig. 3 Typical Transfer Characteristics

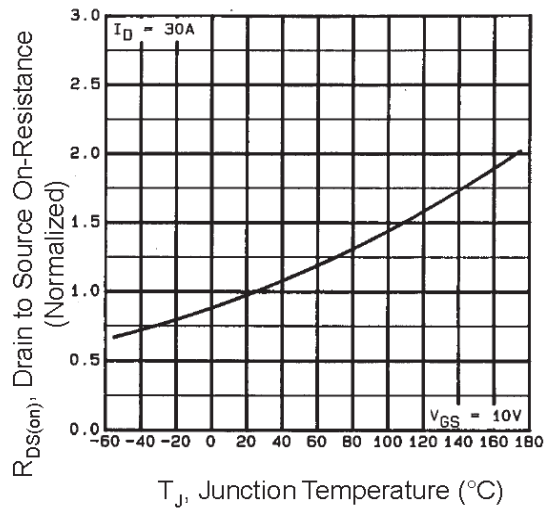

Fig. 4 Normalized On-Resistance vs.
Temperature

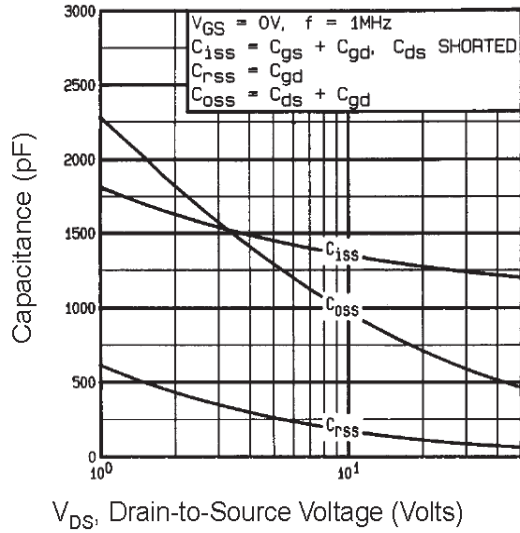

Fig. 5 Typical Capacitance vs. Drain-to-Source Voltage

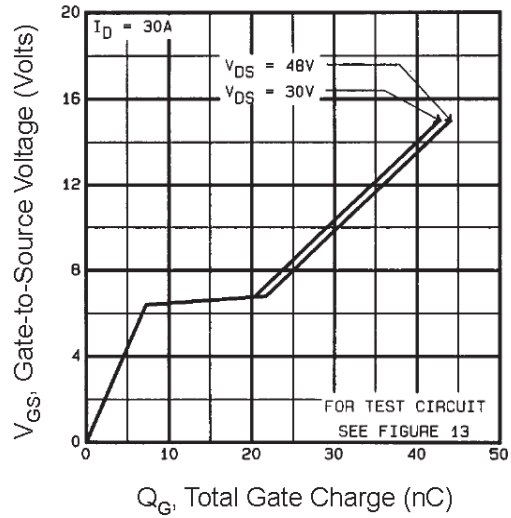

Fig. 6 Typical Gate Charge vs. Gate-to-Source Voltage

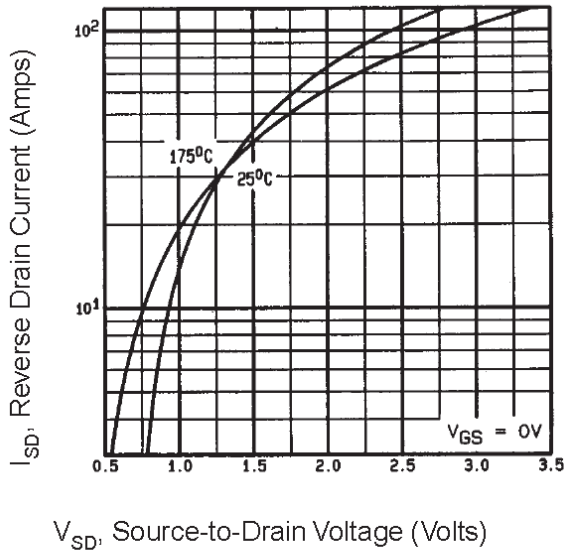

Fig. 7 Typical Source-Drain Diode Forward Voltage

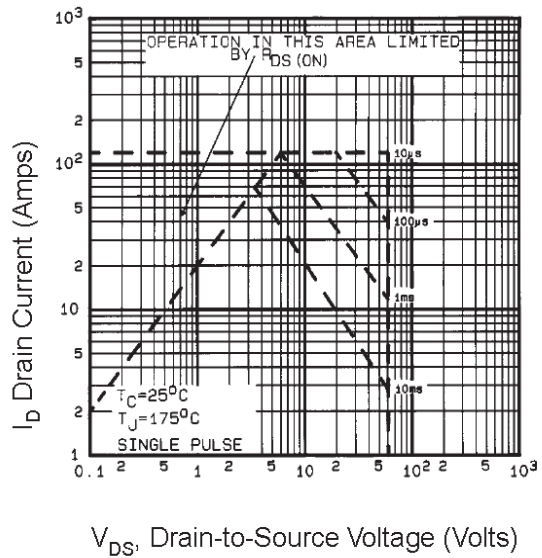

Fig. 8 Maximum Safe Operating Area

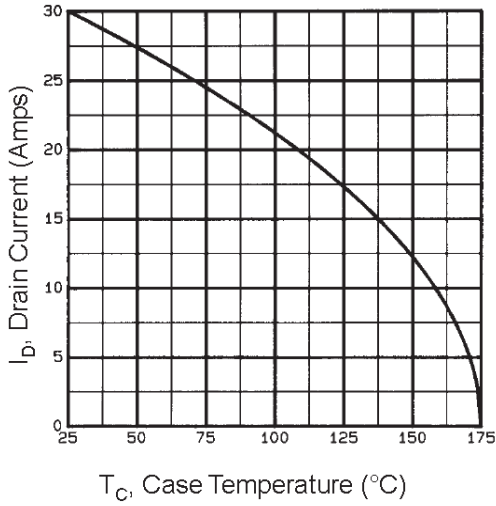

Fig. 9 Maximum Drain Current vs. Case Temperature

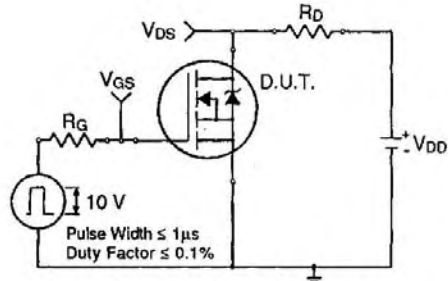

Fig 10a. Switching Time Test Circuit

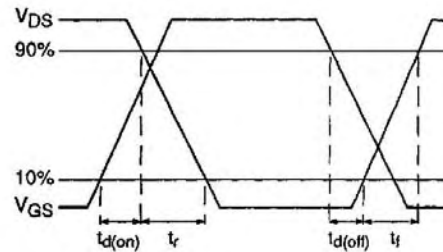

Fig 10b. Switching Time Waveforms

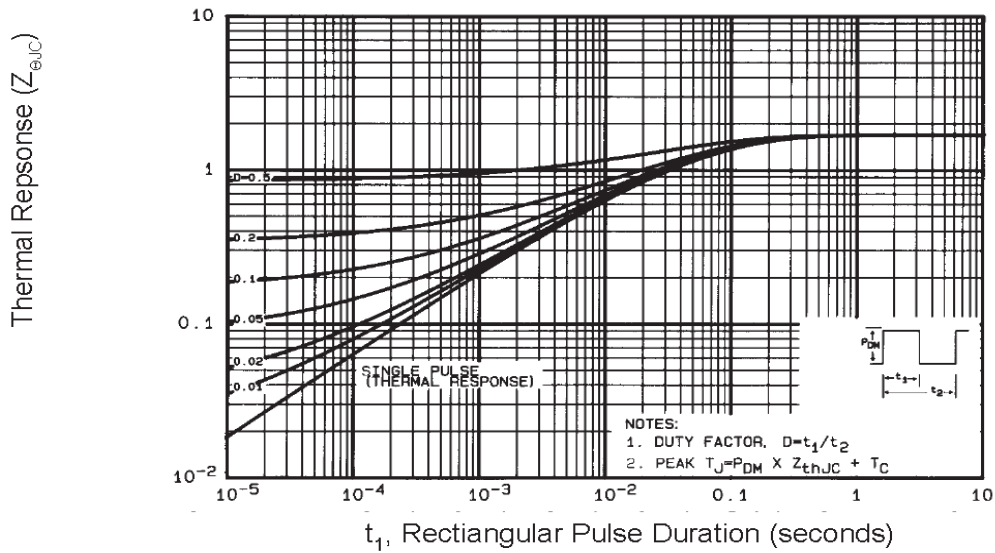

Fig. 11 Maximum Effective Transient Thermal Impedance, Junction-to-Case

IRCZ34PbF

International
IR Rectifier

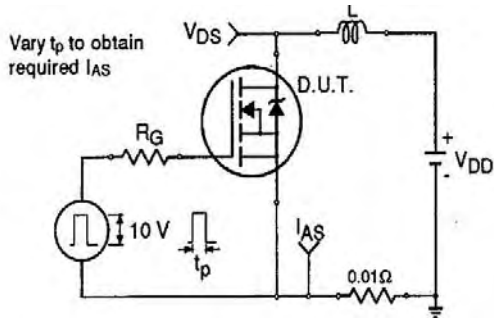

Fig 12a. Unclamped Inductive Test Circuit

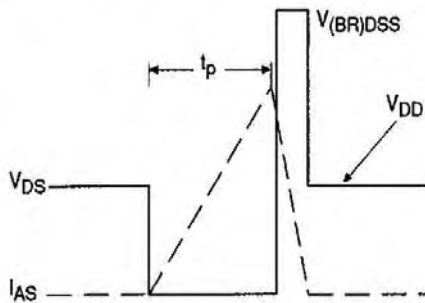

Fig 12b. Unclamped Inductive Waveforms

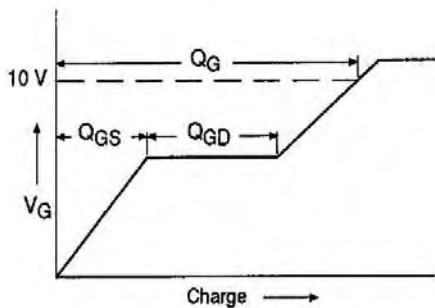

Fig 13a. Basic Gate Charge Waveform

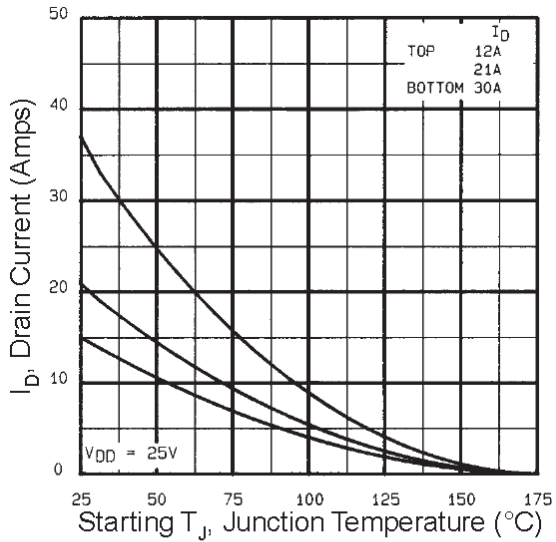

Fig. 12c Maximum Avalanche Energy vs. Drain Current

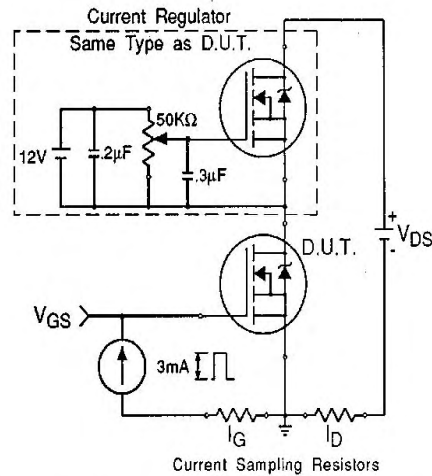

Fig 13b. Gate Charge Test Circuit

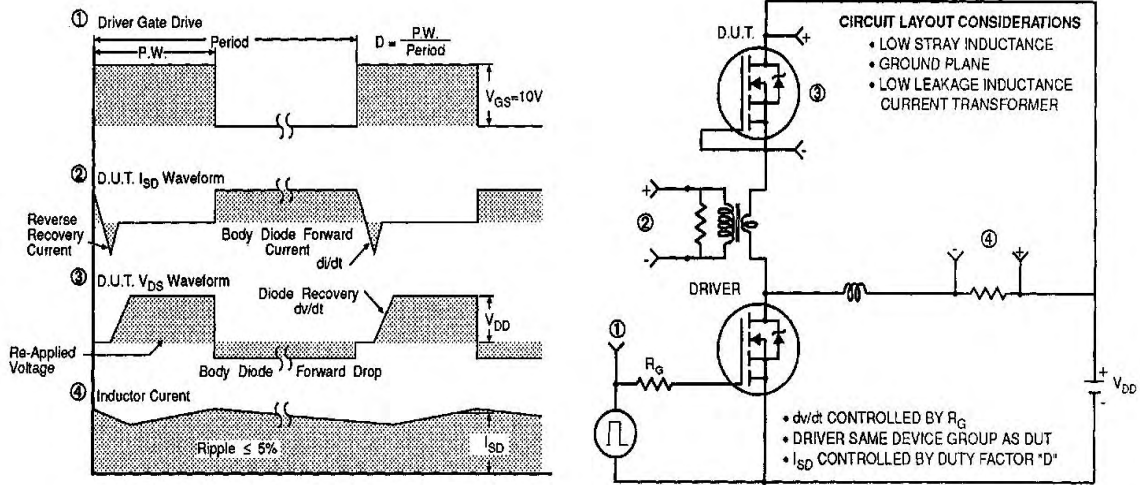

Fig 14. Peak Diode Recovery dv/dt Test Circuit

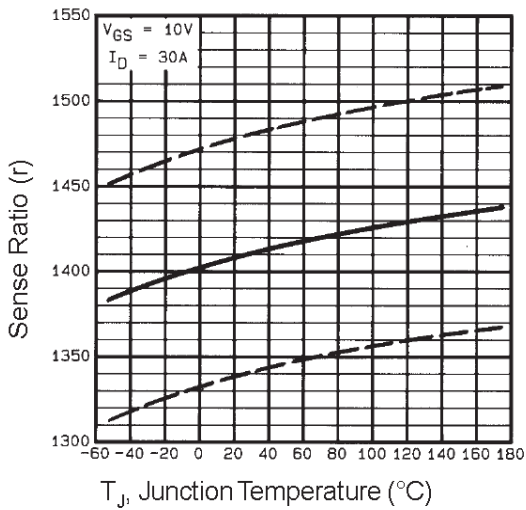

Fig. 15 Typical HEXSense Ratio vs. Junction Temperature

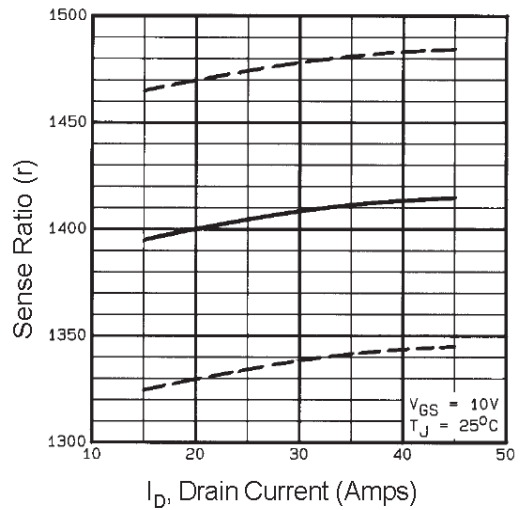

Fig. 16 Typical HEXSense Ratio vs. Drain Current

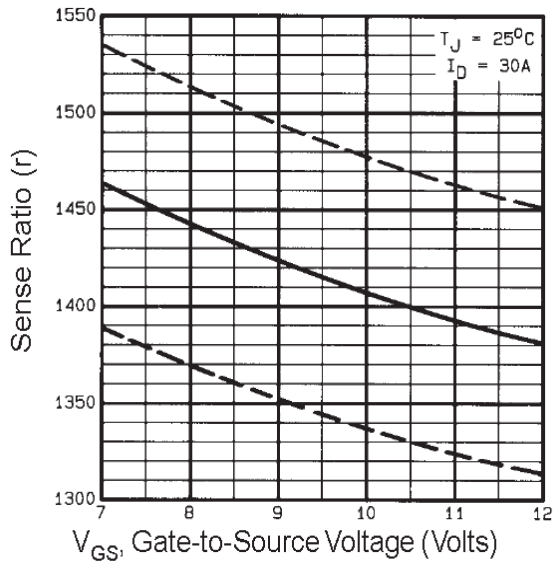

Fig. 17 Typical HEXSense Ratio vs. Gate Voltage

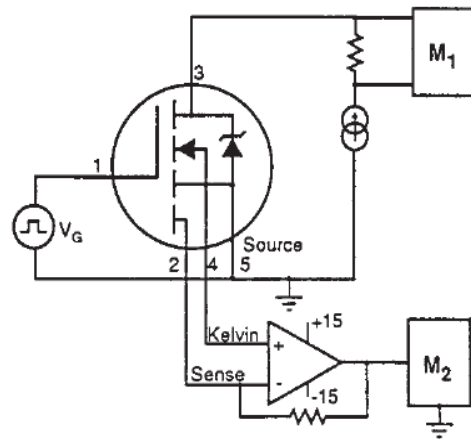

Fig. 18 HEXSense Ratio Test Circuit

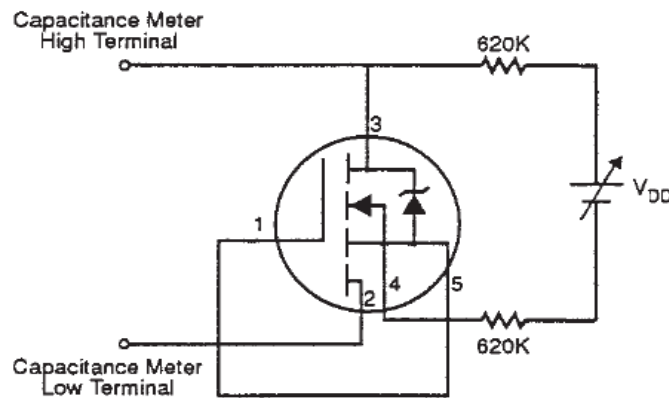
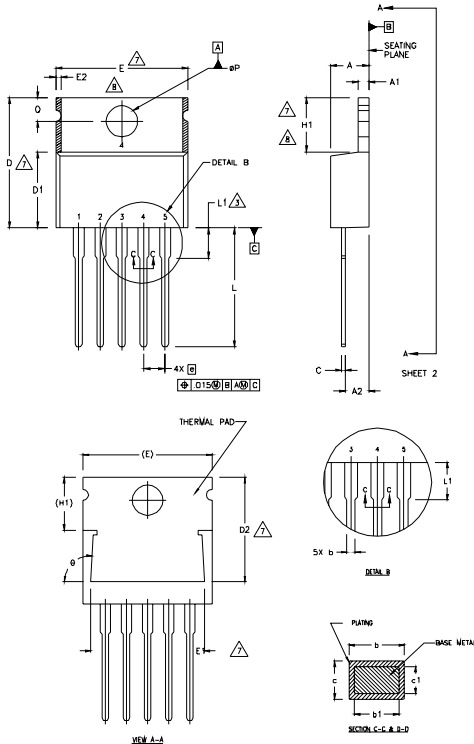

Fig. 19 HEXSense Sensing Cell Output Capacitance Test Circuit

HexsenseTO-220 5L Package Outline

(Dimensions are shown in millimeters (inches))



NOTES:

- 1 DIMENSIONING AND TOLERANCING PER ASME Y14.5 M- 1994.
- 2 DIMENSIONS ARE SHOWN IN INCHES [MILLIMETERS].
- 3 LEAD DIMENSION AND FINISH UNCONTROLLED IN L1.
- 4 DIMENSION D & E DO NOT INCLUDE MOLD FLASH. MOLD FLASH SHALL NOT EXCEED .005" (0.127) PER SIDE. THESE DIMENSIONS ARE MEASURED AT THE OUTERMOST EXTREMES OF THE PLASTIC BODY.
- 5 DIMENSION b1 & c1 APPLY TO BASE METAL ONLY.
- 6 CONTROLLING DIMENSION : INCHES.
- 7 THERMAL PAD CONTOUR OPTIONAL WITHIN DIMENSIONS E,H1,D2 & E1
- 8 DIMENSION E2 X H1 DEFINE A ZONE WHERE STAMPING AND SINGULATION IRREGULARITIES ARE ALLOWED.

SYMBOL	DIMENSIONS				NOTES
	MILLIMETERS		INCHES		
	MIN.	MAX.	MIN.	MAX.	
A	3.56	4.82	.140	.190	
A1	0.51	1.40	.020	.055	
A2	2.04	2.92	.080	.115	
b	0.64	0.88	.025	.035	
b1	0.64	0.84	.025	.033	5
c	0.36	0.61	.014	.024	
c1	0.36	0.56	.014	.022	5
D	14.22	16.51	.560	.650	4
D1	8.38	9.02	.330	.355	
D2	12.19	12.88	.480	.507	7
E	9.66	10.66	.380	.420	4,7
E1	8.38	8.89	.330	.350	7
e	1.70 BSC		.067 BSC		
H1	5.85	6.55	.230	.270	7,8
L	13.47	14.09	.530	.555	
L1	-	6.35	-	.250	3
ØP	3.54	4.08	.139	.161	
Q	2.54	3.42	.100	.135	
Ø	90°-93°		90°-93°		

Hexsense TO-220 5L Part Marking Information

EXAMPLE: THIS IS AN IRC640
 WITH ASSEMBLY
 LOT CODE 1789
 ASSEMBLED ON WW 19, 1997
 IN THE ASSEMBLY LINE "C"

Note: "P" in assembly line position
 indicates "Lead-Free"

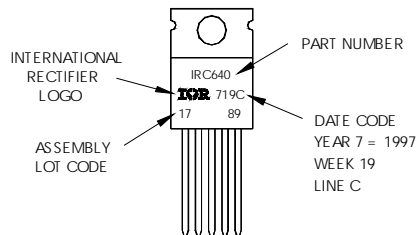

Data and specifications subject to change without notice.