

Nv-Series and P-Series

Pocket Reference Guide



TRANE[®]



**MITSUBISHI
ELECTRIC**

trane.com/residential
trane.mylinkdrive.com



Pre-visit Checklist

✓	Verify appointment
✓	Call 30 minutes before you arrive
✓	Verify equipment in stock at distributor
✓	Credit application/financing options
✓	Local rebate information
✓	Bring this booklet along so you have product and contact information handy

Customer Care: 800-433-4822
trane.mylinkdrive.com

Advanced technology. Superior comfort.

Split-zoning is the most popular type of air-conditioning technology in the world. We take split-zoning to a new level—our cooling and heating systems deliver year-round personal comfort even in the harshest of climates.

Trane®/Mitsubishi Electric single-zone and multi-split systems also feature:

- Exceptional cooling and heating performance
- Automatic cool/heat changeover
- Maximum energy efficiency with higher SEER and HSPF ratings
- Easy installation
- Industry standard R410A refrigerant
- Convenient temperature, fan, and airflow control
- Advanced filtration to help provide high air quality
- Whisper-quiet operation



Leading the way in sustainability
Nv-Series components are
up to 83% recyclable



Nv-Series Single-zone Systems

Cooling Only		
NTYWST09A112A* & NTYSST09A112A*	NTYWST18A112A* & NTYSST18A112A*	
NTYWST12A112A* & NTYSST12A112A*	NTYWST24A112A* & NTYSST24A112A*	
NTYWST15A112A* & NTYSST15A112A*		
Heat Pump		
NTXWST09A112A* & NTXSST09A112A*	TPEADA0151AA70* & NTXSKS15A112A*	
NTXWST12A112A* & NTXSST12A112A*	TPEADA0181AA70* & NTXSKS18A112A*	
NTXWST15A112A* & NTXSST15A112A*	TPEADA0241AA70* & NTXSKS24A112A*	
NTXWST18A112A* & NTXSST18A112A*	TPEADA0301AA70* & NTXSKS30A112A*	
NTXWST24A112A* & NTXSST24A112A*	NTXDKS09A112A* & NTXSKS09A112A*	
NTXUKS09A112A* & NTXSKS09A112A*	NTXDKS12A112A* & NTXSKS12A112A*	
NTXUKS12A112A* & NTXSKS12A112A*	NTXDKS15A112A* & NTXSKS15A112A*	
NTXUKS18A112A* & NTXSKS18A112A*	NTXDKS18A112A* & NTXSKS18A112A*	
NTXCKS09A112A* & NTXSKS09A112A*	NTXAMT12A112A* & NTXSKS12A112A*	
NTXCKS12A112A* & NTXSKS12A112A*	NTXAMT18A112A* & NTXSKS18A112A*	
NTXCKS18A112A* & NTXSKS18A112A*	NTXAMT24A112A* & NTXSKS24A112A*	
TPEADA0091AA70* & NTXSKS09A112A*	NTXAMT30A112A* & NTXSKS30A112A*	
TPEADA0121AA70* & NTXSKS12A112A*		
Hyper-heating INVERTER®		
NTXWPH06B112A* & NTXSP(H/B)06B112A*	NTXCKS18A112A* & NTXSKH18A112A*	
NTXWPH09B112A* & NTXSP(H/B)09B112A*	TPEADA0091AA70* & NTXSKH09A112A*	
NTXWPH12B112A* & NTXSP(H/B)12B112A*	TPEADA0121AA70* & NTXSKH12A112A*	
NTXWPH15B112A* & NTXSP(H/B)15B112A*	TPEADA0151AA70* & NTXSKH15A112A*	
NTXWPH18B112A* & NTXSP(H/B)18B112A*	TPEADA0181AA70* & NTXSKH18A112A*	
NTXFKS09A112A* & NTXSPF09A112A*	TPEADA0301AA70* & NTXSKH30A112A*	
NTXFKS12A112A* & NTXSPF12A112A*	TPEADA0361AA70* & NTXSKH36A112A*	
NTXFKS15A112A* & NTXSPF15A112A*	NTXDKS09A112A* & NTXSKH09A112A*	
NTXFKS18A112A* & NTXSPF18A112A*	NTXDKS12A112A* & NTXSKH12A112A*	
NTXUKS09A112A* & NTXSKH09A112A*	NTXDKS15A112A* & NTXSKH15A112A*	
NTXUKS12A112A* & NTXSKH12A112A*	NTXDKS18A112A* & NTXSKH18A112A*	
NTXUKS18A112A* & NTXSKH18A112A*	NTXAMT12A112A* & NTXSKH12A112A*	
NTXCKS09A112A* & NTXSKH09A112A*	NTXAMT18A112A* & NTXSKH18A112A*	
NTXCKS12A112A* & NTXSKH12A112A*	NTXAMT30A112A* & NTXSKH30A112A*	
NTXCKS15A112A* & NTXSKH15A112A*		

Nv-Series Multi-zone

NTXMMX20A122A* w/ Non-Ducted Indoor Units
NTXMMX24A132A* w/ Non-Ducted Indoor Units
NTXMMX24A132A* w/ Mixed Indoor Units
NTXMMX48A182B* w/ Non-Ducted Indoor Units
NTXMMX60A182B* w/ Non-Ducted Indoor Units
NTXMPH20A122A* w/ Non-Ducted Indoor Units
NTXMPH20A122A* w/ Mixed Indoor Units
NTXMPH24A132A* w/ Non-Ducted Indoor Units
NTXMPH30A132A* w/ Non-Ducted Indoor Units
NTXMPH36A142A* w/ Non-Ducted Indoor Units
NTXMPH36A142A* w/ Mixed Indoor Units
NTXMPH36A142B* w/ Non-Ducted Indoor Units
NTXMPH36A142B* w/ Ducted Indoor Units
NTXMPH36A142B* w/ Mixed Indoor Units
NTXMPH42A152B* w/ Non-Ducted Indoor Units
NTXMPH42A152B* w/ Mixed Indoor Units
NTXMPH48A182B* w/ Non-Ducted Indoor Units

Cooling Only		
TPLA0A0121EA70* & TRUYA0121KA70N*	TPEADA0121AA70* & TRUYA0121KA70N*	
TPLA0A0181EA70* & TRUYA0181KA70N*		
Heat Pump		
TPLA0A0121EA70* & TRUZA0121KA70N*	TPLA0A0241EA70* & TRUZA0241HA70N*	
TPLA0A0181EA70* & TRUZA0181KA70N*	TPEADA0121AA70* & TRUZA0124KA70N*	
Hyper-heating INVERTER®		
TPCA0A0241KA70* & TRUZH0241HA10N*	TPLA0A0241EA70* & TRUZH0241HA10N*	
TPCA0A0301KA70* & TRUZH0301KA00N*	TPLA0A0301EA70* & TRUZH0301KA00N*	
TPCA0A0361KA70* & TRUZH0361KA00N*	TPLA0A0361EA70* & TRUZH0361KA00N*	
TPKA0A0241KA70* & TRUZH0241HA10N*	TPEADA0301AA70* & TRUZH0301KA00N*	
TPKA0A0301KA70* & TRUZH0301KA00N*	TPEADA0361AA70* & TRUZH0361KA00NA*	

For details on state and utility rebates
visit www.dsireusa.org

ENERGY STAR® Most Efficient 2021



Many Trane®/Mitsubishi Electric systems have been awarded ENERGY STAR® Most Efficient 2021 mark. This is a new distinction that recognizes products that deliver cutting-edge energy efficiency along with the latest in technological innovation.

Nv-Series Certified Models*

Cooling Only	
NTYWST09A112AA & NTYSST09A112AB	NTYWST18A112AA & NTYSST18A112AA
NTYWST12A112AA & NTYSST12A112AB	NTYWST24A112AA & NTYSST24A112AA
NTYWST15A112AA & NTYSST15A112AB	
Heat Pump	
NTXWST09A112AA & NTXSST09A112AB	TPEADA0181AA70A & NTXSKS18A112AA
NTXWST12A112AA & NTXSST12A112AB	TPEADA0241AA70A & NTXSKS24A112AA
NTXWST15A112AA & NTXSST15A112AB	TPEADA0301AA70A & NTXSKS30A112AA
NTXWST18A112AA & NTXSST18A112AA	NTXDKS09A112AA & NTXSKS09A112AA
NTXWST24A112AA & NTXSST24A112AA	NTXDKS12A112AA & NTXSKS12A112AA
NTXUKS18A112AA & NTXSKS18A112AA	NTXDKS15A112AA & NTXSKS15A112AA
NTXCKS09A112AA & NTXSKS09A112AA	NTXDKS18A112AA & NTXSKS18A112AA
NTXCKS12A112AA & NTXSKS12A112AA	NTXAMT12A112AA & NTXSKS12A112AA
NTXCKS18A112AA & NTXSKS18A112AA	NTXAMT18A112AA & NTXSKS18A112AA
PEAD-A09AA7 & NTXSKS09A112AA	NTXAMT24A112AA & NTXSKS24A112AA
PEAD-A12AA7 & NTXSKS12A112AA	NTXAMT30A112AA & NTXSKS30A112AA
PEAD-A15AA7 & NTXSKS15A112AA	NTXMMX20A122AA w/Non-Ducted Indoor Units
Hyper-heating Heat Pump	
NTXWPH06B112AA & NTXSPH06(B/H)112AA	NTXCKS12A112AA & NTXSKH12A112AA
NTXWPH09B112AA & NTXSPH09(B/H)112AA	TPEADA0121AA70A & NTXSKH12A112AA
NTXWPH12B112AA & NTXSPH12(B/H)112AA	TPEADA0151AA70A & NTXSKH15A112AA
NTXWPH15B112AA & NTXSPH15(B/H)112AA	TPEADA0181AA70A & NTXSKH18A112AA
NTXWPH18B112AA & NTXSPH18(B/H)112AA	NTXCKS12A112AA & NTXSKH12A112AA
NTXFKS09A112AA & NTXSPF09A112AA	NTXCKS18A112AA & NTXSKH18A112AA
NTXFKS12A112AA & NTXSPF12A112AA	NTXAMT12A112AA & NTXSKH12A112AA
NTXFKS15A112AA & NTXSPF15A112AA	NTXAMT18A112AA & NTXSKH18A112AA
NTXFKS18A112AA & NTXSPF18A112AA	NTXMPH36A142BA w/Non-ducted Indoor Units
NTXCKS09A112AA & NTXSKH09A112AA	NTXMPH42A152BA w/Non-ducted Indoor Units

*ENERGY STAR® certified models as of print time

These systems qualify as Most Efficient when paired with kumo cloud® 2.2 or higher.
www.energystar.gov/products/most_efficient

P-Series Certified Models*

Cooling Only
TPEADA0121AA70A & TRUYA0121KA70NA
TPVA0A0121AA70A & TRUYA0121KA70NA
TPEADA0301AA70A & TRUYA0181KA70NA
TPLA0A0121EA70A & TRUYA0121KA70NA
TPLA0A0241EA70A & TRUYA0241HA70NA
TPLA0A0361EA70A & TRUYA0361KA70NA
Heat Pump
TPEADA0121AA70A & TRUZA0121KA70NA
TPLA0A0121EA70A & TRUZA0121KA70NA
TPEADA0301AA70A & TRUZA0181KA70NA
TPLA0A0241EA70A & TRUZA0241HA70NA
TPLA0A0361EA70A & TRUZA0361KA70NA
TPVA0A0121AA70A & TRUZA0121KA70NA
Hyper-heating Heat Pump
TPEADA0301AA70A & TRUZH0301KA00NA
TPLA0A0181EA70A & TRUZH0361KA00NA
TPLA0A0241EA70A & TRUZH0241HA10NA
TPLA0A0361EA70A & TRUZH0361KA00NA
TPVA0A0301AA70A & TRUZH0301KA00NA
TPVA0A0361AA70A & TRUZH0361KA00NA

*ENERGY STAR® certified models as of print time

For details on state and utility rebates
[visit www.dsireusa.org](http://www.dsireusa.org)

Features & Benefits

How to Read a Model Number

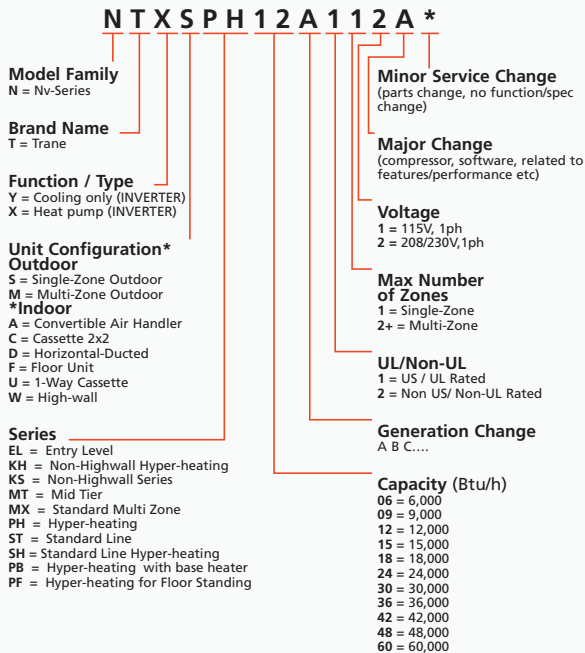

1. Designed for residential applications
2. User-friendly zoned cooling and heating solutions for single- or multi-room applications or the whole home
3. Hyper-heating INVERTER-driven outdoor units can provide high heating performance at lower ambient temperatures
4. Many ENERGY STAR® certified models

How to Read a Model Number

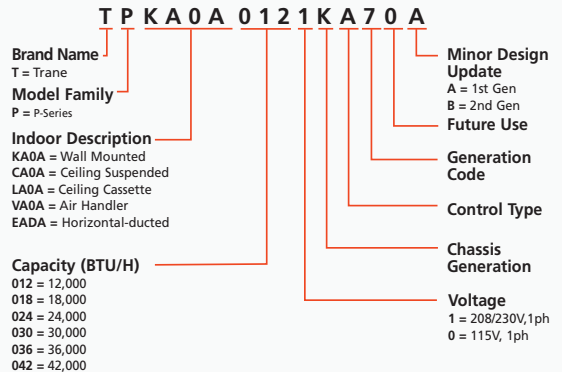

P-Series Model Reference Guide (Outdoor unit)

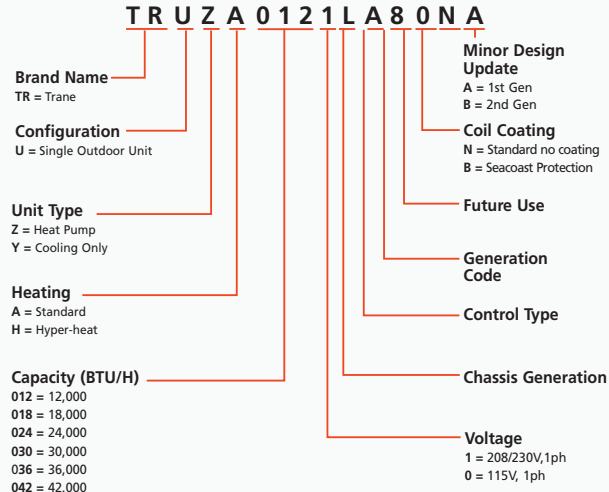

Nv-Series Models

Our standard line is now more efficient than ever!

WST Models

- All ENERGY STAR® certified models
- Smart Set programming button with SETBACK down to 50° F in heating (9,000–15,000 only)
- Washable nano-platinum filter and anti-allergy enzyme filter
- Cooling-only and heat pump models
- Five fan speeds plus AUTO (select models)
- As quiet as 19 dB(A)



(6,000–24,000 BTU/H)

WMT Models

- Econo Cool Energy-Saving feature
- Optional anti-allergy enzyme filter
- 12-hour timer



(9,000–24,000 BTU/H)

WEL Models

- 16 SEER/8.5 HSPF
- Econo Cool Energy-Saving feature
- 12-hour timer
- Optional anti-allergen enzyme filter



(9,000–24,000 BTU/H)

WMT 115V Models

- Econo Cool Energy-Saving feature
- Optional anti-allergy enzyme filter
- 12-hour timer
- Power Supply: 115V, 1 phase, 60Hz



(9,000–12,000 BTU/H)

EF Models

- Modern, sleek design
- Offered in: matte silver, glossy black, or glossy white
- For use with multi-zone units only



(9,000–18,000 BTU/H)

WST Models

- Wide Vane Mode for precise directional airflow (also available on WST18/24)
- Powerful Mode for quick 15-minute heating/cooling boost(also available on WST18/24)
- Cooling-only and heat pump models



(30,000–36,000 BTU/H)

Nv-Series Models

High-efficiency, Hyper-heating systems

WPH Models

- 33.1–21.0 SEER, 13.5–12.0 HSPF, INVERTER-driven compressor
- Dual Barrier Coating on coil, blower wheel, and shell interior
- Hyper-heating plus 100% heating capacity at -5°F outdoor ambient temperature
- Hyper-heating performance down to -13° F outdoor ambient temperature
- Backlit handheld controller with mode displayed as text: AUTO, COOL, DRY, HEAT, FAN
- Quiet operation as low as 20 dB(A)
- Triple-action filtration
 - Nano-platinum filter
 - Electrostatic anti-allergen enzyme filter
 - Deodorizing filter
- Energy Saving Mode
- Double-vane air delivery for enhanced circulation
 - Option to set each vane separately
 - Indirect or Direct setting option
 - Natural flow setting that creates air movement like a natural breeze
- 3D i-see Sensor®
 - Infrared human sensing technologies to measure location of human heat signatures
 - Analyzes room temperature in three dimensions to deliver conditioned air to those areas that need it using double-vane airflow and motorized vertical vanes
- Multi-function hand-held wireless controller or wall-mounted wireless controller available with smart phone control capabilities



High-efficiency, Hyper-heating systems

FKS Models

- Ideal for low-wall mounted applications
- Multi-flow vane technology
- Smart Set programming button with SETBACK down to 50° F in heating
- Washable, 10-year catechin filter and anti-allergy enzyme filter
- Hyper-heating performance down to -13° F outdoor ambient
- 100% heating capacity at 5° F outdoor ambient
- Recess mounting optional



Nv-Series Models

DKS Models

- Small compact design (7-7/8" height)
- Adjustable static pressure
- Built-in condensate lift mechanism (22-1/2" lift)
- Rear return or bottom return (with optional accessory)
- Low operating sound pressure levels; as low as 23 dB(A)
- Available as heat pump or Hyper-heating



(9,000 – 18,000 BTU/H)

EZ FIT® UKS Models

- Fits between 16" joist spacing
- Stylish, square design panel
- Built-in condensate lift mechanism (19.6" lift)
- Adjustable fan speeds and vane direction
- Serviceable from below
- Available as heat pump or Hyper-heating



(9,000 – 18,000 BTU/H)

CKS Models

- Fits in 2' x 2' suspended ceiling grid
- Four-way airflow
- Built-in condensate lift mechanism (33" lift)
- Catechin deodorizing filter
- Outside air intake
- Available as heat pump or Hyper-heating



(9,000 – 18,000 BTU/H)

AMT Models

- Upflow/horizontal configurations
- Condensate overflow switch connection
- Outside air intake
- Humidifier and ERV interface connection (12,000 – 36,000 BTU/H)
- Auxiliary heat control connections
- Optional heat kits are from 3kW to 10kW
- Optional down flow kit
- Available as heat pump or Hyper-heating



Multi-zone heat pump lineup Indoor Units:



WPH 06 to 18
WST 06 to 24
EF 09 to 18



FKS 09 to 18



TPCA 24

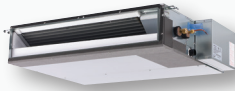

DKS 09 to 18



UKS 09 to 18

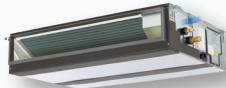

TPEAD 09 to 36



TPLA 12 to 36



CKS 09 to 15



AMT 12 to 36

Multi-zone Heat Pumps

2:1, 3:1, 4:1, 5:1, and 8:1 Zoned Solutions

(20,000 – 60,000 BTU/H)

- Many combinations have received the ENERGY STAR® certification
- Precise, individual room comfort control
- Multiple indoor air handler options (non-ducted and ducted)
- Minimum of two indoor units must be installed
- Standard heat pump or hyper-heating heat pump

STANDARD	
NTXMMX20A122AA	NTXMPH20A122AA
NTXMMX24A132AA	NTXMPH24A132AA
NTXMMX30A132AA	NTXMPH30A132AA
NTXMMX36A142AA	NTXMPH36A142BA
NTXMMX42A152AA	NTXMPH42A152BA
NTXMMX48A182BA	NTXMPH48A182BA
NTXMMX60A182BA	



DIAMOND COMFORT SYSTEM™

Multi-zone Systems*

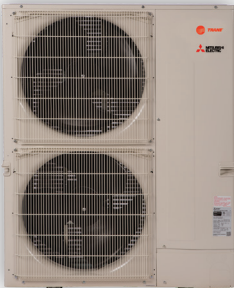

OUTDOOR UNIT

BRANCH BOX



HORIZONTAL-DUCTED
INDOOR UNITS



FLOOR-MOUNTED
INDOOR UNITS



WALL-MOUNTED
INDOOR UNITS



MULTI-POSITION
AIR HANDLER



CEILING-CASSETTE
INDOOR UNITS

*Illustration purposes only. Refer to compatibility chart for combination allowances.

Nv-Series Cooling-Only Systems

WST/SST

Wall-mounted Indoor Unit

Model Specifications

(air conditioners)



NTYSST15A112A*



NTYWST15A112A*

Indoor Model #	NTYWST 09A112A*	NTYWST 12A112A*	NTYWST 15A112A*		NTYWST18A112A*	NTYWST24A112A*	NTYWST30A112A*	NTYWST36A112A*
Outdoor Model #	NTYSST 09A112A*	NTYSST 12A112A*	NTYSST 15A112A*		NTYSST18A112A*	NTYSST24A112A*	NTYSST30A112A*	NTYSST36A112A*
Rated Cooling Capacity (BTU/H)	9,000	12,000	14,000		18,000	22,400	30,600	34,600
Cooling Capacity Range (BTU/H)	3,600–12,200	1,500–13,600	3,100–18,200		5,800–22,000	8,200–31,400	9,800–30,700	9,800–34,600
SEER	24.6	23.1	21.6		20.5	20.5	16.0	15.1
EER	15.4	13.0	13.0		13.4	12.5	9.1	8.2
Airflow at Cooling, Dry (CFM)	399-321-237-170-145		533-420-335-272-205		646-522-417-332-258	738-628-544-469-388		887-848-639-389
Airflow at Cooling, Wet (CFM)	364-286-201-134-109		498-385-300-237-170		581-470-375-299-232	661-562-487-420-347		798-763-576-350
Lineset Size (Liquid x Gas)	1/4" x 3/8"		1/4" x 1/2"		1/4" x 1/2"	3/8" x 5/8"		
Max. Piping Length/Height	65'/40'				100'/50'			
Breaker Size	15 AMP				15 AMP	20 AMP	25 AMP	
Cooling Operation Range*	14° to 115° F				14° to 115° F			
Multi-split Connection	No				No			

Test conditions are based on AHRI 210/240.

Nv-Series units are pre-charged for up to a 25' line set.

*Applications should be restricted to comfort cooling only; equipment cooling applications are not recommended for low ambient temperature conditions.

Nv-Series Heat Pump Systems

WPH/SP* Hyper-heating plus Deluxe Wall-mounted Indoor Unit

Model Specifications

(hyper-heating heat pumps)



NTXSP(H/B)09B112A*



NTXWPH09B112A*

						
Indoor Model #	NTXWPH06B112A*	NTXWPH09B112A*		NTXWPH12A112A*	NTXWPH15A112A*	NTXWPH18A112A*
Outdoor Model #	NTXSP(H/B)06B112A*	NTXSP(H/B)09B112A*		NTXSP(H/B)12A112A*	NTXSP(H/B)15A112A*	NTXSP(H/B)18A112A*
Rated Cooling Capacity (Btu/h)	6,000	9,000		12,000	15,000	17,200
Cooling Capacity Range (Btu/h)	1,700 - 9,000	1,700 - 12,000		2,500 - 13,600	6,450 - 19,000	6,450 - 21,000
Rated Heating Capacity (Btu/h)	8,700	9,600		13,600	18,000	20,300
Heating Capacity Range (Btu/h)	1,600 - 14,000	1,600 - 18,000		3,700 - 21,000	5,150 - 24,000	5,150 - 30,000
Max. Heating Capacity at 17°F (Btu/h)	12,840	14,170		13,600	18,000	20,300
Max. Heating Capacity at 5°F (Btu/h)	10,500	11,590		13,600	18,000	20,300
Max. Heating Capacity at -13°F (Btu/h)	7,250	8,000		9,920	14,580	14,210
SEER	33.1	30.5		26.1	22.0	21.0
HSPF	13.5(12.5)	13.5(12.5)		12.5(11.5)	12.0(11.0)	12.0(11.0)
EER	19.0	16.1		13.8	12.5	12.5
Airflow at Cooling (CFM)	137 - 167 - 221 - 304 - 381			398-304-221-167-137	411-355-304-262-225	459-355-304-262-225
Airflow at Heating (CFM)	140 - 167 - 225 - 325 - 437			454-325-225-167-140	497-394-317-254-201	514-394-317-254-201
Lineset Size (Liquid x Gas)	1/4" x 3/8"			1/4" x 3/8"	1/4" x 1/2"	
Max. Piping Length/Height	65'/40'			65'/40'	100'/50'	
Breaker Size	15 AMP			15 AMP	20 AMP	
Cooling Operation Range	14° to 115° F			14° to 115° F		
Heating Operation Range	-13° to 75° F			-13° to 75° F		
Multi-split Connection	Yes			Yes		

Test conditions are based on AHRI 210/240.

Nv-Series Heat Pump Systems

WST/SST Standard Wall-mounted Indoor Unit

Model Specifications

(heat pumps)



NTXSST09A112A*



NTXWST09A112A*

Indoor Model #	NTXWST09A112A*	NTXWST12A112A*	NTXWST15A112A*		NTXWST18A112A*	NTXWST24A112A*	NTXWST30A112A*	NTXWST36A112A*
Outdoor Model #	NTXSST09A112A*	NTXSST12A112A*	NTXSST15A112A*		NTXSST18A112A*	NTXSST24A112A*	NTXSST30A112A*	NTXSST36A112A*
Rated Cooling Capacity (BTU/H)	9,000	12,000	14,000		18,000	22,500	30,600	33,200
Cooling Capacity Range (BTU/H)	3,600–12,200	1,500–13,600	3,100–18,200		5,800–22,000	8,200–31,400	9,800–30,700	9,800–32,200
Rated Heating Capacity (BTU/H)	10,900	14,400	18,000		21,600	27,600	32,600	35,200
Heating Capacity Range (BTU/H)	4,500–15,900	2,000–18,100	4,800–20,900		5,400–25,000	7,500–36,900	8,700–34,000	8,700–36,000
Max. Heating Capacity at 17° F (BTU/H)	10,200	12,000	16,400		18,200	24,600	20,800	22,800
Max. Heating Capacity at 5° F (BTU/H)	8,170	9,790	13,680		14,900	19,320	NA	NA
SEER	24.6	23.1	21.6		20.5	20.5	14.5	14.5
HSPF	12.8	12.5	11.7		11.2	10.0	8.2	8.2
EER	15.4	13.0	13.0		13.4	12.5	8.0	7.6
Airflow at Cooling (CFM)	399-321-237-170-145		533-420-335-272-205		646-522-417-332-258	738-628-544-469-388	887-848-639-389	
Airflow at Heating (CFM)	406-321-237-170-145		463-367-304-247-205		646-565-469-385-297	738-628-544-469-388	889-848-639-455	
Lineset Size (Liquid x Gas)	1/4" x 3/8"		1/4" x 1/2"		1/4" x 1/2"	3/8" x 5/8"		
Max. Piping Length/ Height	65'/40'				100'/50'			
Breaker Size	15 AMP				15 AMP	20 AMP	25 AMP	
Cooling Operation Range	14° to 115° F				14° to 115° F			
Heating Operation Range	-4° to 75° F				-4° to 75° F		14° to 75° F	
Multi-split Connection	Yes				Yes		No	

Test conditions are based on AHRI 210/240.

NTXWST24A112A* precharged to 33' line set.

Nv-Series Heat Pump Systems

WMT/SMT 18 SEER Wall-mounted Indoor Unit

Model Specifications

(heat pumps)



NTXWMT09A112A*



NTXWMT09A112A*

Indoor Model #	NTXWMT09A112A*	NTXWMT12A112A*		NTXWMT15A112A*	NTXWMT18A112A*	NTXWMT24A112A*
Outdoor Unit	NTXSMT09A112A*	NTXSMT12A112A*		NTXSMT15A112A*	NTXSMT18A112A*	NTXSMT24A112A*
Rated Cooling Capacity (BTU/H)	9,000	12,000		14,000	17,200	22,400
Cooling Capacity Range (BTU/H)	3,800–10,000	3,800–12,200		3,100–16,000	5,800–18,000	5,800–22,500
Rated Heating Capacity (BTU/H)	10,900	12,200		18,000	18,000	26,000
Heating Capacity Range (BTU/H)	4,500–11,800	4,500–14,500		4,800–18,500	5,400–20,900	5,400–26,000
Max. Heating Capacity at 17° F (BTU/H)	7,200	9,000		14,000	15,000	18,500
Max. Heating Capacity at 5° F (BTU/H)	5,990	7,440		12,240	12,780	15,600
SEER	18.0	18.0		18.0	18.0	18.0
HSPF	10.0	10.0		10.0	10.0	10.0
EER	12.0	9.9		12.0	10.5	8.6
Airflow at Cooling (CFM)	399-321-237-170			533-420-335-272	625-530-431-328	702-530-431-353
Airflow at Heating (CFM)	406-321-237-170			463-367-304-247	625-530-431-307	702-579-448-346
Lineset Size (Liquid x Gas)	1/4" x 3/8"			1/4" x 1/2"		3/8" x 5/8"
Max. Piping Length/ Height	65'/40'			65'/40'		100'/50'
Breaker Size	15 AMP			15 AMP		
Cooling Operation Range	14° to 115° F			14° to 115° F		
Heating Operation Range	-4° to 75° F			-4° to 75° F		
Multi-split Connection	No			No		

Test conditions are based on AHRI 210/240.

Nv-Series Heat Pump Systems

WMT/SMT

115V Wall-mounted Indoor Unit

WEL/SEL

16 SEER Wall-mounted Indoor Unit

Model Specifications

(heat pumps)



NTXSMT09A111A*
NTXSEL09A112A*

NTXWMT09A111A*
NTXWEL09A112A*

Indoor Model #	NTXWMT09A111A* ¹	NTXWMT12A111A* ¹		NTXWEL09A112A*	NTXWEL12A112A*	NTXWEL18A112A*	NTXWEL24A112A*
Outdoor Unit	NTXSMT09A111A* ¹	NTXSMT12A111A* ¹		NTXSEL09A112A*	NTXSEL12A112A*	NTXSEL18A112A*	NTXSEL24A112A*
Rated Cooling Capacity (BTU/H)	9,000	12,000		9,000	12,000	17,200	22,400
Cooling Capacity Range (BTU/H)	3,800–10,000	3,800–12,200		3,800–10,000	3,800–12,200	5,800–18,000	5,800–22,500
Rated Heating Capacity (BTU/H)	10,900	12,200		10,900	12,200	18,000	26,000
Heating Capacity Range (BTU/H)	4,500–11,800	4,500–14,500		4,500–11,800	4,500–14,500	5,400–20,900	5,400–26,000
Max. Heating Capacity at 17° F (BTU/H)	7,200	9,000		7,200	9,000	14,000	15,000
Max. Heating Capacity at 5° F (BTU/H)	5,990	7,440		5,990	7,440	12,780	15,600
SEER	17.0	17.0		16.0	16.0	16.0	16.0
HSPF	9.0	9.0		8.5	8.5	8.5	8.5
EER	12.0	9.9		11.0	9.0	10.0	8.0
Airflow at Cooling (CFM)	170-237-321-399			170-237-321-399		328-431-530-625	353-43-530-702
Airflow at Heating (CFM)	170-237-321-406			170-237-321-406		307-431-530-625	346-448-579-702
Lineset Size (Liquid x Gas)	1/4" x 3/8"			1/4" x 3/8"		1/4" x 1/2"	3/8" x 5/8"
Max. Piping Length/ Height	65'/40'			65'/40'			100'/50'
Breaker Size	15 AMP			15 AMP			
Cooling Operation Range	14° to 115° F			32° to 115° F			
Heating Operation Range	-4° to 75° F			5° to 75° F			
Multi-split Connection	No			No			

¹Power Supply: 115V, 1 phase, 60Hz

Test conditions are based on AHRI 210/240.

Nv-Series Heat Pump Systems

FKS/SPF Floor-mounted Indoor Unit

Model Specifications

(hyper-heating heat pumps)



NTXSPF09A112A*



NTXFKS09A112A*



Indoor Model #	NTXFKS09A112A*	NTXFKS12A112A*	NTXFKS15A112A*	NTXFKS18A112A*
Outdoor Unit	NTXSPF09A112A*	NTXSPF12A112A*	NTXSPF15A112A*	NTXSPF18A112A*
Rated Cooling Capacity (BTU/H)	9,000	12,000	15,000	17,000
Cooling Capacity Range (BTU/H)	2,300 – 14,000	2,300 – 15,000	5,300 – 19,000	5,300 – 22,500
Rated Heating Capacity (BTU/H)	11,000	13,000	18,000	21,000
Heating Capacity Range (BTU/H)	2,900 – 19,000	2,900 – 22,800	5,700 – 25,000	5,700 – 29,000
Max. Heating Capacity at 17° F (BTU/H)	13,400	14,800	20,500	23,000
Max. Heating Capacity at 5° F (BTU/H)	11,000	13,000	18,000	21,000
Max. Heating Capacity at -13° F (BTU/H)	7,260	8,450	13,860	15,960
SEER	28.2	25.5	21.8	21.0
HSPF	13.0	12.0	11.6	11.3
EER	15.8	13.6	13.5	12.6
Airflow at Cooling (CFM)	417-360-272-198-138	417-360-272-198-138	431-392-311-354-198	491-420-328-254-198
Airflow at Heating (CFM)	417-328-254-191-138	417-328-254-191-138	470-399-328-268-212	
Lineset Size (Liquid x Gas)	1/4" x 3/8"	1/4" x 3/8"	1/4" x 1/2"	
Max. Piping Length/ Height	65'/40'	65'/40'	100'/50'	
Breaker Size	15 AMP	15 AMP	20 AMP	
Cooling Operation Range	14° to 115° F		14° to 115° F	
Heating Operation Range	-13° to 75° F		-13° to 75° F	
Multi-split Connection	Yes		Yes	

Test conditions are based on AHRI 210/240.

Nv-Series Heat Pump Systems

UKS/SK*
EZ FIT® Ceiling Cassette

Model Specifications

(heat pumps)

(hyper-heating heat pumps)



NTXSKH09A112A*



NTXSKS09A112A*



NTXUKS09A112A*



Indoor Model #	NTXUKS 09A112A*	NTXUKS 12A112A*	NTXUKS 18A112A*		NTXUKS09A112A*	NTXUKS12A112A*	NTXUKS18A112A*
Outdoor Model #	NTXSKS 09A112A*	NTXSKS 12A112A*	NTXSKS 18A112A*		NTXSKH09A112A*	NTXSKH12A112A*	NTXSKH18A112A*
Rated Cooling Capacity (BTU/H)	9,000	12,000	18,000		9,000	12,000	16,700
Cooling Capacity Range (BTU/H)	3,600 – 9,000	3,900 – 12,000	6,600 – 18,000		4,800–9,000	5,270–12,000	8,740–16,700
Rated Heating Capacity (BTU/H)	12,000	15,400	20,000		12,000	15,000	18,600
Heating Capacity Range (BTU/H)	4,500 – 15,900	2,000 – 18,100	4,800 – 20,900		8,300–14,000	7,800–18,000	8,500–22,000
Max. Heating Capacity at 17° F (BTU/H)	10,200	12,000	16,400		12,000	15,000	18,600
Max. Heating Capacity at 5° F (BTU/H)	6,100	7,900	10,700		12,000	15,000	18,600
Max. Heating Capacity at -13° F (BTU/H)	—	—	—		5,160	6,450	7,990
SEER	19.5	19.8	22.3		18.9	19.0	18.8
HSPF	13.3	12.1	12.4		11.0	10.2	10.0
EER	12.6	12.5	12.5		12.5	12.7	12.5
Airflow at Cooling (CFM)	212-254-283-311	212-258-297-332	212-293-346-403		212-254-282-311	212-258-297-332	212-293-346-403
Airflow at Heating (CFM)	212-247-290-325	212-272-311-350	212-311-364-417		212-247-290-325	212-272-311-350	212-311-364-417
ESP (in. WG)	—	—	—		—	—	—
Lineset Size (Liquid x Gas)	1/4" x 3/8"		1/4" x 1/2"		1/4" x 3/8"		1/4" x 1/2"
Max. Piping Length/ Height	65'/40'		100'/50'		65'/40'		100'/50'
Breaker Size	14 AMP				15 AMP		
Cooling Operation Range	14° to 115° F				14° to 115° F		
Heating Operation Range	-4° to 75° F				-13° to 75° F		
Multi-split Connection	Yes				Yes		

Nv-Series Heat Pump Systems

CKS/SK* Four-way Ceiling Cassette

Model Specifications

(heat pumps)

(hyper-heating heat pumps)



NTXSKH09A112A*



NTXSKS09A112A*



NTXCKS09A112A*



Indoor Model #	NTXCKS 09A112A*	NTXCKS 12A112A*	NTXCKS 15A112A*		NTXCKS 18A112A*	NTXCKS 09A112A*	NTXCKS 12A112A*	NTXCKS 15A112A*	NTXCKS 18A112A*
Outdoor Model #	NTXSKS 09A112A*	NTXSKS 12A112A*	NTXSKS 15A112A*		NTXSKS 18A112A*	NTXSKH 09A112A*	NTXSKH 12A112A*	NTXSKH 15A112A*	NTXSKH 18A112A*
Rated Cooling Capacity (BTU/H)	9,000	12,000	14,100		17,700	9,000	12,000	13,700	16,800
Cooling Capacity Range (BTU/H)	3,600 – 9,000	3,900 – 12,000	5,100 – 14,100		6,100 – 17,700	4,800–9,000	5,070–12,000	8,500–13,700	9,010–16,800
Rated Heating Capacity (BTU/H)	11,000	13,000	18,000		19,700	11,000	13,800	16,400	18,800
Heating Capacity Range (BTU/H)	11,000 – 12,000	13,000 – 13,000	18,000 – 18,000		19,700 – 20,900	7,400–13,200	7,800–14,500	8,300–19,000	8,300–20,000
Max. Heating Capacity at 17°F (BTU/H)	6,900	8,900	11,900		12,900	11,000	13,800	16,400	18,800
Max. Heating Capacity at 5° F (BTU/H)	5,600	6,100	8,900		9,800	11,000	13,800	16,400	18,800
Max. Heating Capacity at -13° F (BTU/H)	—	—	—		—	4,730	5,930	7,050	8,080
SEER	22.4	22.0	19.8		20.7	20.2	20.3	17.7	19.0
HSPF	12.2	11.4	11.2		11.6	10.0	10.0	9.0	9.4
EER	13.4	13.3	12.2		12.5	15.0	12.7	12.5	12.5
Airflow at Cooling (CFM)	230-265-300	230-265-335	245-315-405		300-420-475	230-265-300	335-280-230	405-315-245	475-420-300
Airflow at Heating (CFM)	230-265-335	230-265-335	245-315-405		300-420-475	230-265-300	230-280-335	245-315-405	300-420-475
ESP (in. WG)	—	—	—		—	—	—	—	—
Lineset Size (Liquid x Gas)	1/4" x 3/8"		1/4" x 1/2"		1/4" x 1/2"	1/4" x 3/8"	1/4" x 3/8"	1/4" x 1/2"	1/4" x 1/2"
Max. Piping Length/ Height	65'/40'				100'/50'	65'/40'	65'/40'	65'/40'	100'/50'
Breaker Size	14 AMP				14 AMP	15 AMP			
Cooling Operation Range	14° to 115° F				14° to 115° F				
Heating Operation Range	-4° to 75° F				-4° to 75° F	-13° to 75° F			
Multi-split Connection	Yes				Yes				

Nv-Series Heat Pump Systems

AMT/SKS Multi-position Air Handler

Model Specifications

(heat pumps)



NTXSKH12A112A*



NTXSKS12A112A*



NTXAMT12A112A*

Indoor Model #	NTXAMT12A112A*	NTXAMT18A112A*		NTXAMT24A112A*	NTXAMT30A112A*	NTXAMT36A112A*
Outdoor Model #	NTXSKS12A112A*	NTXSKS18A112A*		NTXSKS24A112A*	NTXSKS30A112A*	NTXSKS36A112A*
Rated Cooling Capacity (BTU/H)	12,000	18,000		24,000	27,000	33,000
Rated Cooling Capacity Range (BTU/H)	4,300–12,000	6,200–18,000		12,400–24,000	13,500–27,000	11,600–33,000
Rated Heating Capacity (BTU/H)	15,000	21,600		25,000	30,000	33,400
Heating Capacity Range (BTU/H)	5,000–13,500	7,700–22,800		5,000–13,500	7,700–22,800	7,700–22,800
Max. Heating Capacity at 17° F (BTU/H)	9,900	14,000		14,600	21,400	23,200
Max. Heating Capacity at 5° F (BTU/H)	7,800	12,200		—	—	—
Max. Heating Capacity at -13° F (BTU/H)	—	—		—	—	—
SEER	18				18	16.0
HSPF (IV)	12.1	12.6		10.4	13.6	11.7
EER ¹	12.7	13.2		12.5		8.8
Airflow at Cooling (CFM)	278-381-448	471-573-675		515-625-735	613-744-875	767-910-910
Airflow at Heating (CFM)	278-381-448	471-573-675		515-625-735	613-744-875	767-910-910
ESP (in. WG)	0.3-0.5-0.8			0.3-0.5-0.8		
Lineset Size (Liquid x Gas)	1/4" x 3/8"	1/4" x 1/2"		3/8" x 5/8"		
Max. Piping Length/Height	65'/40'	100'/50'		100'/50'		
Breaker Size	15 AMP			20 AMP		
Cooling Operation Range	14° to 115° F			14° to 115° F		
Heating Operation Range	-4° to 75° F			14° to 75° F		
Multi-split Connection	No			No		

Nv-Series Heat Pump Systems

AMT/SKH Multi-position Air Handler

Model Specifications

(hyper-heating heat pumps)



NTXSKH12A112A*



NTXAMT12A112A*



Indoor Model #	NTXAMT12A112A*	NTXAMT18A112A*		NTXAMT24A112A*	NTXAMT30A112A*	NTXAMT36A112A*
Outdoor Model #	NTXSKH12A112A*	NTXSKH18A112A*		NTXSKH24A112A*	NTXSKH30A112A*	NTXSKH36A112A*
Rated Cooling Capacity (BTU/H)	12,000	18,000		24,000	27,000	36,000
Rated Cooling Capacity Range (BTU/H)	5,600–12,000	9,360–18,000		8,800-24,000	13,400-27,000	14,200-36,000
Rated Heating Capacity (BTU/H)	15,000	21,600		23,000	32,000	37,000
Heating Capacity Range (BTU/H)	7,700–18,000	8,800–28,000		9,400-28,800	13,000-34,000	13,800-40,000
Max. Heating Capacity at 17° F (BTU/H)	15,000	21,600		23,000	32,000	37,000
Max. Heating Capacity at 5° F (BTU/H)	15,000	21,600		23,000	32,000	37,000
Max. Heating Capacity at -13° F (BTU/H)	6,450	9,280		-	-	-
SEER	19.0	18.4		16.0	15.0	16.0
HSPF (IV)	10.2	10.4		9.2	9.0	9.0
EER ¹	13.9	12.5		9.9	12.5	9.5
Airflow at Cooling (CFM)	448-381-278	675-573-471		515-625-735	613-744-875	767-910-910
Airflow at Heating (CFM)	278-381-448	471-573-675		515-625-735	613-744-875	767-910-910
ESP (in. WG)	0.3-0.5-0.8			0.3-0.5-0.8		
Lineset Size (Liquid x Gas)	1/4" x 3/8"	1/4" x 1/2"		3/8" x 5/8"		
Max. Piping Length/Height	65'/40'	100'/50'		165'/100'	245'/100'	
Breaker Size	15 AMP			25 AMP	35 AMP	
Cooling Operation Range	14° to 115° F			23° to 115° F		
Heating Operation Range	-13° to 75° F			-13° to 70° F		
Multi-split Connection	Yes			Yes		

Nv-Series Heat Pump Systems

TPEAD/SKS

Mid Static Horizontal-ducted Indoor Unit

Model Specifications

(heat pumps)



NTXSK509A112A*



TPEADA0121AA70*

Indoor Model #	TPEADA 0091AA70*	TPEADA 0121AA70*	TPEADA 0151AA70*		TPEADA0181AA70*	TPEADA0241AA70*	TPEADA0301AA70*	TPEADA0361AA70*
Outdoor Model #	NTXSK 09A112A*	NTXSKS 12A112A*	NTXSKS 15A112A*		NTXSKS18A112A*	NTXSKS24A112A*	NTXSKS30A112A*	NTXSKS36A112A*
Rated Cooling Capacity (BTU/H)	9,000	12,000	15,000		18,000	24,000	27,000	33,000
Rated Cooling Capacity Range (BTU/H)	4,300 – 9,000	4,400 – 12,000	5,500 – 15,000		6,200 – 18,000	12,000 – 24,000	13,200 – 27,000	14,000 – 33,000
Rated Heating Capacity (BTU/H)	12,000	15,000	18,000		21,600	25,000	30,000	33,400
Heating Capacity Range (BTU/H)	3,960 – 13,000	4,800 – 17,000	4,900 – 21,500		8,120 – 25,600	14,400 – 28,000	15,860 – 33,000	14,750 – 36,000
Max. Heating Capacity at 17° F (BTU/H)	10,200	12,000	16,400		16,400	14,600	21,400	23,200
Max. Heating Capacity at 5° F (BTU/H)	6,100	7,900	10,100		12,000	-	-	-
SEER	19.7	20.5	19.2		19.8	18.0	18.0	16.0
HSPF (IV)	12.6	13.0	11.6		12.9	11.2	12.6	11.6
EER ¹	12.5	12.9	13.0		14.1	12.5	12.5	9.4
Airflow at Cooling (CFM)	282-318-353	353-424-494	424-512-600		212-293-346-403	512-636-742	618-742-883	847-1,024-1,201
Airflow at Heating (CFM)	282-318-353	353-424-494	424-512-600		212-293-346-403	512-636-742	618-742-883	847-1,024-1,201
ESP (in. WG)	0.14-0.20-0.28-0.40-0.60				0.14-0.20-0.28-0.40-0.60			
Lineset Size (Liquid x Gas)	1/4" x 3/8"		1/4" x 1/2"		1/4" x 1/2"	3/8" x 5/8"		
Max. Piping Length/Height	65'/40'		100'/50'		100'/50'			
Breaker Size	15 AMP				15 AMP	20 AMP		
Cooling Operation Range	14° to 115° F				14° to 115° F			
Heating Operation Range	-4° to 75° F				-4° to 75° F	14° to 75° F		
Multi-split Connection	Yes				Yes			

¹Port adapter (MAC-A455JP-E) is needed for TPEAD-A12AA7 connection with NTXSKS12A112A*.

Nv-Series Heat Pump Systems

TPEAD/SKH

Mid Static Horizontal-ducted Indoor Unit

Model Specifications

(hyper-heating heat pumps)



NTXSKH12A112A*



TPEADA0121AA70*



Indoor Model #	TPEADA0091AA70*	TPEADA0121AA70*	TPEADA0151AA70*		TPEADA0181AA70*	TPEADA0241AA70*	TPEADA0301AA70*	TPEADA0361AA70*
Outdoor Unit	NTXSKH09A112A*	NTXSKH12A112A*	NTXSKH15A112A*		NTXSKH18A112A*	NTXSKH24A112A*	NTXSKH30A112A*	NTXSKH36A112A*
Rated Cooling Capacity (BTU/H)	9,000	12,000	15,000		18,000	24,000	30,000	33,000
Cooling Capacity Range (BTU/H)	5,000–9,000	5,770–12,000	9,600–15,000		9,320–18,000	10,000–24,000	14,600–30,000	15,600–33,000
Rated Heating Capacity (BTU/H)	12,000	15,000	18,000		21,600	25,000	32,000	37,000
Heating Capacity Range (BTU/H)	8,200–14,000	7,900–18,000	8,800–23,000		8,800–28,000	10,000–28,000	14,700–34,000	17,400–40,000
Max. Heating Capacity at 17° F (BTU/H)	12,000	15,000	18,000		21,600	25,000	32,000	37,000
Max. Heating Capacity at 5° F (BTU/H)	12,000	15,000	18,000		21,600	25,000	32,000	37,000
Max. Heating Capacity at -13° F (BTU/H)	5,160	6,450	7,740		9,280	-	-	-
SEER	17.8	19.3	18.3		18.9	15.0	15.0	15.0
HSPF	10.8	11.0	9.9		10.8	9.0	9.0	9.0
EER	13.8	14.1	12.6		12.8	10.3	12.5	12.5
Airflow at Cooling (CFM)	353-318-282	494-424-353	600-512-424		600-512-424	512-635-741	618-742-883	847-1024-1201
Airflow at Heating (CFM)	282-318-353	353-424-494	424-512-600		424-512-600	512-635-741	618-742-883	847-1024-1201
ESP (in. WG)	0.14-0.2-0.28-0.4-0.6				0.14-0.20-0.28-0.40-0.60			
Lineset Size (Liquid x Gas)	1/4" x 3/8"		1/4" x 1/2"		1/4" x 1/2"	3/8" x 5/8"		
Max. Piping Length/ Height	65'/40'				100'/50'	165'/100'	245'/100'	245'/100'
Breaker Size	15 AMP				15 AMP	25 AMP	35 AMP	35 AMP
Cooling Operation Range	14° to 115° F				14° to 115° F	23° to 115° F		
Heating Operation Range	-13° to 75° F				-13° to 70° F			
Multi-split Connection	Yes				Yes			

Port adapter (MAC-A455JP-E) is needed for TPEAD-A12AA7 connection with NTXSKS12A112A.

42 Test conditions are based on AHRI 210/240.

Nv-Series Heat Pump Systems

DKS/SK*

Low Static Horizontal-ducted Indoor Unit

Model Specifications

(heat pumps)

(hyper-heating heat pumps)



Indoor Model #	NTXDKS 09A112A*	NTXDKS 12A112A*	NTXDKS 15A112A*			NTXDKS 18A112A*	NTXDKS 09A112A*	NTXDKS 12A112A*	NTXDKS 15A112A*	NTXDKS 18A112A*
Outdoor Model #	NTXSKS 09A112A*	NTXSKS 12A112A*	NTXSKS 15A112A*			NTXSKS 18A112A*	NTXSKH 09A112A*	NTXSKH 12A112A*	NTXSKH 15A112A*	NTXSKH 18A112A*
Rated Cooling Capacity (BTU/H)	9,000	12,000	15,000			18,000	9,000	12,000	15,000	18,000
Cooling Capacity Range (BTU/H)	3,900 – 9,000	4,000 – 12,000	5,200 – 15,000			6,100 – 18,000	4,500–9,000	5,210–12,000	9,000–15,000	9,200–18,000
Rated Heating Capacity (BTU/H)	12,000	15,000	18,000			21,600	12,500	15,000	18,000	21,600
Heating Capacity Range (BTU/H)	4,200 – 12,800	4,800 – 16,800	5,000 – 21,600			8,100 – 25,600	8,100–13,300	7,700–18,000	8,600–22,400	8,800–28,000
Max. Heating Capacity at 17° F (BTU/H)	7,300	9,800	13,700			15,000	12,500	15,000	18,000	21,600
Max. Heating Capacity at 5° F (BTU/H)	6,000	7,900	10,000			12,000	12,500	15,000	18,000	21,600
Max. Heating Capacity at -13° F (BTU/H)							5,370	6,450	7,740	9,280
SEER	18.8	20.5	19.0			22.0	17.3	19.0	17.3	19.1
HSPF	11.0	12.4	11.4			13.1	9.8	10.2	9.5	10.9
EER	12.8	12.9	13.0			13.7	13.0	13.0	12.5	13.1
Airflow at Cooling (CFM)	194-247-317	247-317-388	353-441-529			423-529-635	317-247-194	388-317-247	529-441-353	635-529-423
Airflow at Heating (CFM)	194-247-317	247-317-388	353-441-529			423-529-635	194-247-317	247-317-388	353-441-529	423-529-635
ESP (in. WG)	0.20-0.14-0.06-0.02					0.20-0.14-0.06-0.02		0.02-0.06-0.14-0.2		
Lineset Size (Liquid x Gas)	1/4" x 3/8"		1/4" x 1/2"			1/4" x 1/2"	1/4" x 3/8"		1/4" x 1/2"	
Max. Piping Length/Height	60'/40'					100'/50'		65'/40'		100'/50'
Breaker Size	15 AMP					15 AMP				
Cooling Operation Range	14° to 115° F					14° to 115° F				
Heating Operation Range	-4° to 75° F					-4° to 75° F		-13° to 75° F		
Multi-split Connection	Yes					Yes				

Test conditions are based on AHRI 210/240.

Nv-Series Heat Pump Systems

MX Model

Model Specifications

(multi-zone heat pumps)



BRANCH BOX
FOR INDOOR UNIT
CONNECTIONS

- Two sizes are available:
- 3-branch TAC-MKA32BC
 - 5-branch TAC-MKA52BC (shown left)

NTXMMX48A182BA

Outdoor Model #	NTXMMX 20A112A*	NTXMMX 24A132AA		NTXMMX 30A132AA	NTXMMX 36A142AA	NTXMMX 42A152AA	NTXMMX 48A182BA	NTXMMX 60A182BA
Rated Cooling Capacity (BTU/H) Non-ducted/Ducted	18,000/20,000	22,000/23,600		28,400/27,400	35,400/34,400	40,500/37,400	48,000	60,000
Cooling Capacity Range (BTU/H)	5,700–20,000	6,000–24,000		6,000–30,000	6,000–36,000	6,000–41,600	15,500-48,000	30,000-60,000
Rated Heating Capacity (BTU/H) Non-ducted/Ducted	22,000	25,000/24,600		28,600/27,600	36,000/34,400	45,000/41,000	54,000	66,000
Heating Capacity Range (BTU/H)	7,400–25,000	7,400–25,000		7,400–30,000	7,400–36,000	7,400–46,400	22,500-54,000	31,000–66,000
Max. Heating Capacity at 17° F (BTU/H)	14,500/15,500	19,600		21,000	26,600	30,500	36,600	65,000
Max. Heating Capacity at 5° F (BTU/H)	11,100/10,900	18,200		18,200	24,000	26,000	32,400	57,000
SEER Non-ducted / Ducted / Mixed	20.0/16.0/18.0	20.0/16.0/18.0		19.0/16.2/17.6	19.2/16.0/17.6	19.7/15.2/ 17.45	20.0/16.0/18.0	19.5/17.0/ 18.2
HSPF Non-ducted / Ducted / Mixed	10.0/9.3/9.65	9.8/9.2/9.50		10.6/9.6/9.6	11.0/9.8/10.4	10.3/9.1/9.7	11.5/10.1/10.8	10.7/10.7/10.7
EER Non-ducted / Ducted / Mixed	12.7/10/11.35	13.6/11.2/12.4		10.6/9.6/10.1	9.4/8.7/9.05	9.2/9.0/9.1	12.2/10.0/11.1	12.5/10.0/ 11.2
Individual/Combined Max. Lineset Length	164'/82'	230'/82'		230'/82'		262'/82'	492'/262'	
Breaker Size	20 AMP	25 AMP		25 AMP		40 AMP		50 AMP
Branch Box Required	No			No			Yes	
Cooling Operation Range	14° to 115° F			14° to 115° F			5° to 115° F (When optional wind baffle is used)	
Heating Operation Range	5° to 75° F			5° to 75° F			-4° to 70° F	

Nv-Series Heat Pump Systems

MX Model

Model Specifications

(multi-zone hyper-heating heat pumps)



NTXMPH48A182BA



BRANCH BOX
FOR INDOOR UNIT
CONNECTIONS

Two sizes are available:

- 3-branch TAC-MKA32BC
- 5-branch TAC-MKA52BC (shown left)

Outdoor Model #	NTXMPH 20A112A*	NTXMPH 24A132AA	NTXMPH 30A132AA	NTXMPH 36A142BA	NTXMPH 42A182BA	NTXMPH 48A182BA
Rated Cooling Capacity (BTU/H) Non-ducted/Ducted	18,000/20,000	22,000/23,600	28,400/27,400	36,000	42,000	48,000
Cooling Capacity Range (BTU/H)	6,000–20,000	6,000–24,000	6,000–28,400	15,500–36,000	15,500–42,000	16,000–48,000
Rated Heating Capacity (BTU/H) Non-ducted/Ducted	22,000/22,000	25,000/24,600	28,600/27,600	45,000	48,000	54,000
Heated Capacity Range (BTU/H)	7,400–22,000	7,400–25,000	7,400–28,600	22,500–45,000	24,000–48,000	27,000–54,000
Max. Heating Capacity at 17° F (BTU/H)	22,000/22,000	25,000/24,600	28,600/27,600	45,000	48,000	54,000
Max. Heating Capacity at 5° F (BTU/H)	22,000	25,000	28,600	45,000	48,000	54,000
Max. Heating Capacity at -13° F (BTU/H)	20,460	22,500	25,168	34,200	36,480	37,800
SEER Non-ducted / Ducted / Mixed	17.0/15.0/16.0	19.0/15.5/17.25	18.0/16.0/17.0	20.0/17.5/18.7	20.0/17.0/18.5	20.0/16.0/18.0
HSPF Non-ducted / Ducted / Mixed	9.8/9.5/9.65	10.0/9.0/9.5	11.0/9.8/10.4	11.3/11.0/11.1	11.0/10.6/10.8	11.5/10.1/10.8
EER Non-ducted / Ducted / Mixed	13.5/11.0/12.25	13.5/10.0/11.75	12.5/10.3/11.4	14.0/12.5/13.2	13.4/10.8/12.1	12.2/10.0/11.1
Individual/Combined Max. Lineset Length	164'/82'	230'/82'	230'/82'	492'/262'		
Breaker Size	40 amp		40 amp		50 amp	
Branch Box Required	No		No		Yes	
Cooling Operation Range	14° to 115° F		14° to 115° F		5° to 115° F (When optional wind baffle is used)	
Heating Operation Range	-13° to 75° F		-13° to 75° F		-13° to 70° F	

Nv-Series Heat Pump Systems

MSZ-EF for MX Model Designer Wall-mounted Indoor Unit

Model Specifications

(heat pumps)



MSZ-EF09NA(W/B/S)

Indoor Model #	MSZ-EF09NA(W/B/S)	MSZ-EF12NA(W/B/S)		MSZ-EF15NA(W/B/S)	MSZ-EF18NA(W/B/S)
Outdoor Unit	NTXMMX/NTXMPH			NTXMMX/NTXMPH	
Rated Cooling Capacity (BTU/H)	9,000	12,000		15,000	18,000
Rated Heating Capacity (BTU/H)	10,900	14,400		18,000	21,600
Airflow at Cooling (CFM)	141-162-222-293-371			205-233-272-314-364	205-240-279-328-388
Airflow at Heating (CFM)	141-162-219-314-420	141-162-219-314-448		194-222-275-350-448	226-258-318-392-466
Lineset Size (Liquid x Gas)	1/4" x 3/8"			1/4" x 1/2"	

PORT ADAPTER GUIDE

Available Indoor Units	Line Set Size
NTXWPH/MSZ-EF/NTX(Y)WST/NTXWMT/NTXWEL Wall-mounted Indoor Unit	
NTXWPH06B112A*	Liquid: 1/4" Gas: 3/8"
NTXWPH09B112A*	Liquid: 1/4" Gas: 3/8"
NTXWPH12B112A*	Liquid: 1/4" Gas: 3/8"
NTXWPH15B112A*	Liquid: 1/4" Gas: 1/2"
NTXWPH18B112A*	Liquid: 1/4" Gas: 1/2"
MSZ-EF09NAW(B)(S)	Liquid: 1/4" Gas: 3/8"
MSZ-EF12NAW(B)(S)	Liquid: 1/4" Gas: 3/8"
MSZ-EF15NAW(B)(S)	Liquid: 1/4" Gas: 3/8"
MSZ-EF18NAW(B)(S)	Liquid: 1/4" Gas: 3/8"
NTX(Y)WST06A112A*	Liquid: 1/4" Gas: 3/8"
NTX(Y)WST09A112A*	Liquid: 1/4" Gas: 3/8"
NTX(Y)WST12A112A*	Liquid: 1/4" Gas: 3/8"
NTX(Y)WST15A112A*	Liquid: 1/4" Gas: 1/2"
NTX(Y)WST18A112A*	Liquid: 1/4" Gas: 1/2"
NTX(Y)WST24A112A*	Liquid: 3/8" Gas: 5/8"
NTX(Y)WST30A112A*	Liquid: 3/8" Gas: 5/8"
NTX(Y)WST36A112A*	Liquid: 3/8" Gas: 5/8"
NTXWMT09A112A*	Liquid: 1/4" Gas: 3/8"
NTXWMT12A112A*	Liquid: 1/4" Gas: 3/8"
NTXWMT15A112A*	Liquid: 1/4" Gas: 1/2"
NTXWMT18A112A*	Liquid: 1/4" Gas: 1/2"
NTXWMT24A112A*	Liquid: 3/8" Gas: 5/8"
NTXWMT09A111A*	Liquid: 1/4" Gas: 3/8"
NTXWMT12A111A*	Liquid: 1/4" Gas: 3/8"
NTXWEL09A112A*	Liquid: 1/4" Gas: 3/8"
NTXWEL12A112A*	Liquid: 1/4" Gas: 3/8"
NTXWEL18A112A*	Liquid: 1/4" Gas: 1/2"
NTXWEL24A112A*	Liquid: 3/8" Gas: 5/8"

Available Indoor Units	Line Set Size
NTXFKS Floor-mounted Indoor Unit	
NTXFKS09A112A*	Liquid: 1/4" Gas: 3/8"
NTXFKS12A112A*	Liquid: 1/4" Gas: 3/8"
NTXFKS15A112A*	Liquid: 1/4" Gas: 1/2"
NTXFKS18A112A*	Liquid: 1/4" Gas: 1/2"
NTXAMT Multi-position Air Handler	
NTXAMT12A112A*	Liquid: 1/4" Gas: 3/8"
NTXAMT18A112A*	Liquid: 1/4" Gas: 1/2"
NTXAMT24A112A*	Liquid: 3/8" Gas: 5/8"
NTXAMT30A112A*	Liquid: 3/8" Gas: 5/8"
NTXAMT36A112A*	Liquid: 3/8" Gas: 5/8"
TPLA Ceiling Cassette	
TPLA0A0121EA70*	Liquid: 1/4" Gas: 1/2"
TPLA0A0181EA70*	Liquid: 1/4" Gas: 1/2"
TPLA0A0241EA70*	Liquid: 3/8" Gas: 5/8"
TPLA0A0301EA70*	Liquid: 3/8" Gas: 5/8"
TPLA0A0361EA70*	Liquid: 3/8" Gas: 5/8"
TPCA Ceiling-suspended Indoor Unit	
TPCA0A0241KA70*	Liquid: 3/8" Gas: 5/8"
NTXCKS Ceiling Cassette	
NTXCKS09A112A*	Liquid: 1/4" Gas: 3/8"
NTXCKS12A112A*	Liquid: 1/4" Gas: 3/8"
NTXCKS15A112A*	Liquid: 1/4" Gas: 1/2"
NTXCKS18A112A*	Liquid: 1/4" Gas: 1/2"
NTXUKS EZ FIT® Ceiling Cassette	
NTXUKS09A112A*	Liquid: 1/4" Gas: 3/8"
NTXUKS12A112A*	Liquid: 1/4" Gas: 3/8"
NTXUKS18A112A*	Liquid: 1/4" Gas: 1/2"

Available Indoor Units	Line Set Size
NTXDKS/TPEAD Horizontal-ducted	
NTXDKS09A112A*	Liquid: 1/4" Gas: 3/8"
NTXDKS12A112A*	Liquid: 1/4" Gas: 3/8"
NTXDKS15A112A*	Liquid: 1/4" Gas: 1/2"
NTXDKS18A112A*	Liquid: 1/4" Gas: 1/2"
TPEADA0091AA70*	Liquid: 1/4" Gas: 1/2"
TPEADA0121AA70*	Liquid: 1/4" Gas: 1/2"
TPEADA0151AA70*	Liquid: 1/4" Gas: 1/2"
TPEADA0181AA70*	Liquid: 3/8" Gas: 5/8"
TPEADA0241AA70*	Liquid: 3/8" Gas: 5/8"
TPEADA0301AA70*	Liquid: 3/8" Gas: 5/8"
TPEADA0361AA70*	Liquid: 3/8" Gas: 5/8"

PORT ADAPTERS PART NUMBERS

MAC-A454JP-E	3/8" x 1/2"
MAC-A455JP-E	1/2" x 3/8"
MAC-A456JP-E	1/2" x 5/8"
PAC-SG76RJ-E	3/8" x 5/8"
PAC-493PI	1/4" x 3/8"
ADP-5834	5/8" x 3/4"

PORT ADAPTER GUIDE

Port	Gas	Liquid
NTXMMX20A122AA		
A; B	3/8"	1/4"
NTXMMX24A132AA		
A	1/2"	1/4"
B; C	3/8"	1/4"
NTXMMX30A132AA		
A	1/2"	1/4"
B; C	3/8"	1/4"
NTXMMX36A142A		
A	1/2"	1/4"
B; C; D	3/8"	1/4"
NTXMMX42A152A		
A	1/2"	1/4"
B; C; D; E	3/8"	1/4"
NTXMPH20A122A		
A; B	3/8"	1/4"
NTXMPH24A132A		
A	1/2"	1/4"
B; C	3/8"	1/4"
NTXMPH30A132A		
A	1/2"	1/4"
B; C	3/8"	1/4"

The following NTXMMX/NTXMPH units must utilize at least one branch box

NTXMMX48A182B*
 NTXMMX60A182B*
 NTXMPH36A142B*
 NTXMPH42A152B*
 NTXMPH48A182B*

Branch Boxes

Port	Gas	Liquid
TAC-MKA32BC [3-Port]		
A; B; C	3/8"	1/4"
TAC-MKA52BC [5-Port]		
A; B; C; D	3/8"	1/4"
E	1/2"	1/4"

Notes for application:

- Check the lineset sizes for your selected indoor models
- Select the branch box or boxes needed for your application
- Compare indoor unit lineset sizes to branch box or outdoor unit port sizes
- Connect 15K + indoor units to the larger 1/2" port on the TAC-MKA52BC branch box or outdoor unit
- Adapt lineset size with appropriate port adapter from above list

Model	Refrigerant piping length (one way)			
	25 Ft (Std)	40 Ft	65 Ft	100 Ft
NT(X/Y)SST09A112AA	Cap. x 1.0	Capacity x 0.988	Capacity x 0.968	-
NT(X/Y)SST12A112AA		Capacity x 0.988	Capacity x 0.968	-
NT(X/Y)SST15A112AA		Capacity x 0.988	Capacity x 0.968	-
NT(X/Y)SST18A112AA		Capacity x 0.985	Capacity x 0.963	Capacity x 0.933
NT(X/Y)SST24A112AA		Capacity x 0.983	Capacity x 0.956	Capacity x 0.921

Nv-Series Correction Factors

Model	Refrigerant piping length (one way)			
	25 Ft (Std)	40 Ft	65 Ft	100 Ft
NT(X/Y)SST30A112AA	Cap. x 1.0	Capacity x 0.976	Capacity x 0.937	Capacity x 0.887
NT(X/Y)SST36A112AA		Capacity x 0.974	Capacity x 0.932	Capacity x 0.878
NTXSMT09A112AB		Capacity x 0.988	Capacity x 0.967	-
NTXSMT12A112AB		Capacity x 0.988	Capacity x 0.967	-
NTXSMT15A112AB		Capacity x 0.988	Capacity x 0.967	-
NTXSMT18A112AB		Capacity x 0.985	Capacity x 0.963	Capacity x 0.933
NTXSMT24A112AA		Capacity x 0.983	Capacity x 0.956	Capacity x 0.921
NTXSMT09A111AA		Capacity x 0.988	Capacity x 0.967	-
NTXSMT12A111AA		Capacity x 0.988	Capacity x 0.967	-
NTXSEL09A112AB		Capacity x 0.988	Capacity x 0.967	-
NTXSEL12A112AB		Capacity x 0.988	Capacity x 0.967	-
NTXSEL18A112AB		Capacity x 0.985	Capacity x 0.963	Capacity x 0.933
NTXSEL24A112AA		Capacity x 0.983	Capacity x 0.956	Capacity x 0.921
NTXSPH06B112AA		Capacity x 0.988	Capacity x 0.967	-
NTXSPH09B112AA		Capacity x 0.988	Capacity x 0.967	-
NTXSPH12B112AA		Capacity x 0.988	Capacity x 0.967	-
NTXSPH15B112AA		Capacity x 0.985	Capacity x 0.963	Capacity x 0.933
NTXSPH18B112AA		Capacity x 0.985	Capacity x 0.963	Capacity x 0.933
NTXSKS09A112AA		Capacity x 0.988	Capacity x 0.967	-
NTXSKS12A112AA		Capacity x 0.988	Capacity x 0.967	-
NTXSKS15A112AA		Capacity x 0.988	Capacity x 0.967	-
NTXSKS18A112AA		Capacity x 0.985	Capacity x 0.963	Capacity x 0.933
NTXSKS24A112AA		Capacity x 0.985	Capacity x 0.963	Capacity x 0.933
NTXSKS30A112AA		Capacity x 0.983	Capacity x 0.956	Capacity x 0.921
NTXSKS36A112AA		Capacity x 0.983	Capacity x 0.956	Capacity x 0.921
NTXSKH09A112AA		Capacity x 0.963	Capacity x 0.904	-
NTXSKH12A112AA		Capacity x 0.963	Capacity x 0.904	-
NTXSKH15A112AA		Capacity x 0.981	Capacity x 0.944	-
NTXSKH18A112AA		Capacity x 0.981	Capacity x 0.944	Capacity x 0.892
NTXSKH24A112AA		Capacity x 0.988	Capacity x 0.960	Capacity x 0.933
NTXSKH30A112AA	Capacity x 0.988	Capacity x 0.960	Capacity x 0.933	
NTXSKH36A112AA	Capacity x 0.988	Capacity x 0.960	Capacity x 0.933	
NTXSPF09A112AA	Capacity x 0.988	Capacity x 0.967	-	
NTXSPF12A112AA	Capacity x 0.988	Capacity x 0.967	-	
NTXSPF15A112AA	Capacity x 0.985	Capacity x 0.963	Capacity x 0.933	
NTXSPF18A112AA	Capacity x 0.985	Capacity x 0.963	Capacity x 0.933	

Nv-Series Air Outlet Coverage Range*

Model Number	Mode	Function	Airflow (CFM)	Coverage (ft)
NTXWST06A112A*	HEAT	DRY	406	29.5
NTX(Y)WST09A112A*	COOL	DRY	286	21.0
NTX(Y)WST12A112A*		WET		
NTX(Y)WST15A112A*	HEAT	DRY	406	29.5
	COOL	WET	286	21.0
NTX(Y)WST18A112A*	HEAT	DRY	463	33.5
	COOL	WET	385	28.0
NTX(Y)WST24A112A*	HEAT	DRY	646	44.0
	COOL	WET	581	39.7
NTX(Y)WST30A112A*	HEAT	DRY	738	36.9
NTX(Y)WST36A112A*	COOL	WET	661	33.2
NTXWPH06B112A*	HEAT	DRY	437	29.8
NTXWPH09B112A*	COOL	WET	328	22.5
NTXWPH12B112A*	HEAT	DRY	454	31.0
	COOL	WET	364	24.8
NTXWPH15B112A*	HEAT	DRY	514	34.9
	COOL	WET	376	25.6
NTXWPH18B112A*	HEAT	DRY	514	34.9
	COOL	WET	376	25.6
NTXFKS09A112A*	HEAT	DRY	417	29.6
NTXFKS12A112A*	COOL	WET	354	25.3
	HEAT	DRY	470	33.3
NTXFKS15A112A*	COOL	WET	366	26.2
	HEAT	DRY	470	33.3
NTXFKS18A112A*	COOL	WET	417	29.7
	HEAT	DRY	300	15.1
NTXCKS09A112A*	COOL	WET	270	13.7
	HEAT	DRY	336	16.9
NTXCKS12A112A*	COOL	WET	302	15.2
	HEAT	DRY	405	20.3
NTXCKS15A112A*	COOL	WET	365	18.3
	HEAT	DRY	475	23.7
NTXCKS18A112A*	COOL	WET	429	21.4
	HEAT	DRY	420	29.2
MSZ-EF09NA(W/B/S)	COOL	WET	319	22.3
	HEAT	DRY	448	31.1
MSZ-EF12NA(W/B/S)	COOL	WET	319	22.3
	HEAT	DRY	448	31.1
MSZ-EF15NA(W/B/S)	COOL	WET	313	21.9
	HEAT	DRY	466	32.3
MSZ-EF18NA(W/B/S)	COOL	WET	334	23.4
	HEAT	DRY	406	29.5
NTXWMT09A112A*	HEAT	DRY	406	29.5
NTXWMT12A112A*	COOL	WET	286	21.0

Model Number	Mode	Function	Airflow (CFM)	Coverage (ft)
NTXWMT15A112A*	HEAT	DRY	463	33.5
	COOL	WET	385	28.0
NTXWMT18A112A*	HEAT	DRY	625	42.6
	COOL	WET	562	38.4
NTXWMT24A112A*	HEAT	DRY	702	47.7
	COOL	WET	632	43.1
NTXWMT09A111A*	HEAT	DRY	406	29.5
	COOL	WET	364	26.5
NTXWMT12A111A*	HEAT	DRY	406	29.5
	COOL	WET	364	26.5
NTXWEL09A112A*	HEAT	DRY	406	29.5
	COOL	WET	286	21.0
NTXWEL12A112A*	HEAT	DRY	406	29.5
	COOL	WET	286	21.0
NTXWEL18A112A*	HEAT	DRY	625	42.6
	COOL	WET	562	38.4
NTXWEL24A112A*	HEAT	DRY	702	47.7
	COOL	WET	632	43.1
NTXUKS09A112A*	DRY	DRY	311	20.7
	WET	WET	325	21.7
NTXUKS12A112A*	DRY	DRY	332	22.1
	COOL	WET	350	23.3
NTXUKS18A112A*	HEAT	DRY	403	26.7
	COOL	WET	417	27.6

*ir coverage represents the distance with one ft/sec air speed when blowing out horizontally from the unit operating at the High fan speed. This is only a general guideline; actual coverage depends on size and layout of the room.

Heating Capacity

Outdoor Temperature (° F)		50	41.0	32.0		23.0	14.0	5.0	-4	-13
NTXWPH06B112AA / NTXSPH06B112AA	Heating Capacity (BTU/H)	14,445	13,703	12,962		12,149	11,037	9,924	8,700	7,721
	Percentage of Rated Capacity	100%	100%	100%		100%	100%	100%	100%	89%
NTXWPH06B112AA / NTXSPB06B112AA	Heating Capacity (BTU/H)	14,445	13,703	12,962		12,149	11,037	9,924	8,700	7,721
	Percentage of Rated Capacity	100%	100%	100%		100%	100%	100%	100%	89%
NTXWPH09B112AA / NTXSPH09B112AA	Heating Capacity (BTU/H)	18,554	17,631	16,707		15,068	13,304	11,540	9,600	8,048
	Percentage of Rated Capacity	100%	100%	100%		100%	100%	100%	100%	84%
NTXWPH09B112AA / NTXSPB09B112AA	Heating Capacity (BTU/H)	18,554	17,631	16,707		15,068	13,304	11,540	9,600	8,048
	Percentage of Rated Capacity	100%	100%	100%		100%	100%	100%	100%	84%
NTXWPH12B112AA / NTXSPH12B112AA	Heating Capacity (BTU/H)	21,714	20,524	19,333		18,143	16,464	14,482	12,301	10,556
	Percentage of Rated Capacity	100%	100%	100%		100%	100%	100%	100%	86%
NTXWPH12B112AA / NTXSPB12B112AA	Heating Capacity (BTU/H)	21,714	20,524	19,333		18,143	16,464	14,482	12,301	10,556
	Percentage of Rated Capacity	100%	100%	100%		100%	100%	100%	100%	86%
NTXWPH15B112AA / NTXSPH15B112AA	Heating Capacity (BTU/H)	24,544	23,637	22,730		21,823	19,988	18,089	16,001	14,330
	Percentage of Rated Capacity	100%	100%	100%		100%	100%	100%	100%	90%
NTXWPH15B112AA / NTXSPB15B112AA	Heating Capacity (BTU/H)	24,544	23,637	22,730		21,823	19,988	18,089	16,001	14,330
	Percentage of Rated Capacity	100%	100%	100%		100%	100%	100%	100%	90%
NTXWPH18B112AA / NTXSPH18B112AA	Heating Capacity (BTU/H)	30,619	29,587	28,556		27,524	25,129	22,211	19,001	16,433
	Percentage of Rated Capacity	100%	100%	100%		100%	100%	100%	100%	86%
NTXWPH18B112AA / NTXSPB18B112AA	Heating Capacity (BTU/H)	30,619	29,587	28,556		27,524	25,129	22,211	19,001	16,433
	Percentage of Rated Capacity	100%	100%	100%		100%	100%	100%	100%	86%
NTXWST09A112AA / NTXSST09A112AB	Heating Capacity (BTU/H)	10,900	10,900	10,900		10,460	9,480	8,170	6,860	
	Percentage of Rated Capacity	100%	100%	100%		96%	87%	75%	63%	-
NTXWST12A112AA / NTXSST12A112AB	Heating Capacity (BTU/H)	14,400	14,400	14,110		12,960	11,660	9,790	7,920	
	Percentage of Rated Capacity	100%	100%	98%		90%	81%	68%	55%	-
NTXWST15A112AA / NTXSST15A112AB	Heating Capacity (BTU/H)	18,000	17,100	16,920		16,920	16,200	13,680	11,160	
	Percentage of Rated Capacity	100%	95%	94%		94%	90%	76%	62%	-
NTXWST18A112AA / NTXSST18A112AA	Heating Capacity (BTU/H)	21,600	21,600	21,600		19,440	17,060	14,900	12,520	
	Percentage of Rated Capacity	100%	100%	100%		90%	79%	69%	58%	-

Outdoor Temperature (° F)		50	41.0	32.0		23.0	14.0	5.0	-4	-13
NTXWST24A112AA / NTXSST24A112AA	Heating Capacity (BTU/H)	27,600	27,600	27,600		26,220	23,460	19,320	15,450	
	Percentage of Rated Capacity	100%	100%	100%		95%	85%	70%	56%	-
NTXWMT09A112AA / NTXSMT09A112AB	Heating Capacity (BTU/H)	10,900	10,570	9,480		8,500	7,300	5,990	4,680	
	Percentage of Rated Capacity	100%	97%	87%		78%	67%	55%	43%	-
NTXWMT12A112AA / NTXSMT12A112AB	Heating Capacity (BTU/H)	12,200	12,200	11,220		10,120	9,020	7,440	5,850	
	Percentage of Rated Capacity	100%	100%	92%		83%	74%	61%	48%	-
NTXWMT15A112AA / NTXSMT15A112AB	Heating Capacity (BTU/H)	18,000	15,300	14,940		14,400	13,680	12,240	10,620	
	Percentage of Rated Capacity	100%	85%	83%		80%	76%	68%	59%	-
NTXWMT18A112AA / NTXSMT18A112AB	Heating Capacity (BTU/H)	18,000	18,000	18,000		16,560	14,580	12,780	10,980	
	Percentage of Rated Capacity	100%	100%	100%		92%	81%	71%	61%	-
NTXWMT24A112AA / NTXSMT24A112AA	Heating Capacity (BTU/H)	26,000	24,440	22,360		20,020	17,680	15,600	13,260	
	Percentage of Rated Capacity	100%	94%	86%		77%	68%	60%	51%	-
NTXWST30A112AA / NTXSST30A112AA	Heating Capacity (BTU/H)	32,600	28,030	25,420		22,820	19,880			
	Percentage of Rated Capacity	100%	86%	78%		70%	61%	-	-	-
NTXWST36A112AA / NTXSST36A112AA	Heating Capacity (BTU/H)	35,200	29,560	27,450		25,340	22,880			
	Percentage of Rated Capacity	100%	84%	78%		72%	65%	-	-	-
NTXWMT09A111AA / NTXSMT09A111AA	Heating Capacity (BTU/H)	10,900	10,570	9,480		8,500	7,300	5,990	4,680	
	Percentage of Rated Capacity	100%	97%	87%		78%	67%	55%	43%	-
NTXWMT12A111AA / NTXSMT12A111AA	Heating Capacity (BTU/H)	12,200	12,200	11,220		10,120	9,020	7,440	5,850	
	Percentage of Rated Capacity	100%	100%	92%		83%	74%	61%	48%	-
NTXWEL09A112AA / NTXSEL09A112AB	Heating Capacity (BTU/H)	10,900	10,570	9,480		8,500	7,300	5,990		
	Percentage of Rated Capacity	100%	97%	87%		78%	67%	55%	-	-
NTXWEL12A112AA / NTXSEL12A112AB	Heating Capacity (BTU/H)	12,200	12,200	11,220		10,120	9,020	7,440		
	Percentage of Rated Capacity	100%	100%	92%		83%	74%	61%	-	-
NTXWEL18A112AA / NTXSEL18A112AB	Heating Capacity (BTU/H)	18,000	18,000	18,000		16,560	14,580	12,780		
	Percentage of Rated Capacity	100%	100%	100%		92%	81%	71%	-	-
NTXWEL24A112AA / NTXSEL24A112AA	Heating Capacity (BTU/H)	26,000	24,440	22,360		20,020	17,680	15,600		
	Percentage of Rated Capacity	100%	94%	86%		77%	68%	60%	-	-
NTXFKS09A112AA / NTXSPF09A112AA	Heating Capacity (BTU/H)	11,000	11,000	11,000		11,000	11,000	11,000	9,130	7,260
	Percentage of Rated Capacity	100%	100%	100%		100%	100%	100%	83%	66%
NTXFKS12A112AA / NTXSPF12A112AA	Heating Capacity (BTU/H)	13,000	13,000	13,000		13,000	13,000	13,000	10,790	8,450
	Percentage of Rated Capacity	100%	100%	100%		100%	100%	100%	83%	65%

Outdoor Temperature (° F)		50	41.0	32.0		23.0	14.0	5.0	-4	-13
NTXFKS15A112AA / NTXSPF15A112AA	Heating Capacity (BTU/H)	18,000	18,000	18,000		18,000	18,000	18,000	14,940	13,860
	Percentage of Rated Capacity	100%	100%	100%		100%	100%	100%	83%	77%
NTXFKS18A112AA / NTXSPF18A112AA	Heating Capacity (BTU/H)	21,000	21,000	21,000		21,000	21,000	21,000	18,480	15,960
	Percentage of Rated Capacity	100%	100%	100%		100%	100%	100%	88%	76%
NTXUKS09A112AA / NTXSKS09A112AA	Heating Capacity (BTU/H)	12,000	10,620	9,230		7,840	6,450	5,090	3,770	
	Percentage of Rated Capacity	100%	89%	77%		65%	54%	42%	31%	-
NTXUKS12A112AA / NTXSKS12A112AA	Heating Capacity (BTU/H)	15,400	13,630	11,850		10,060	8,280	6,540	4,840	
	Percentage of Rated Capacity	100%	89%	77%		65%	54%	42%	31%	-
NTXUKS18A112AA / NTXSKS18A112AA	Heating Capacity (BTU/H)	20,000	17,700	15,390		13,060	10,760	8,490	6,290	
	Percentage of Rated Capacity	100%	89%	77%		65%	54%	42%	31%	-
NTXCKS09A112AA / NTXSKS09A112AA	Heating Capacity (BTU/H)	11,000	9,730	8,460		7,180	5,920	4,670	3,460	
	Percentage of Rated Capacity	100%	89%	77%		65%	54%	42%	31%	-
NTXCKS12A112AA / NTXSKS12A112AA	Heating Capacity (BTU/H)	13,000	11,510	10,000		8,490	6,990	5,520	4,080	
	Percentage of Rated Capacity	100%	89%	77%		65%	54%	42%	31%	-
NTXCKS15A112AA / NTXSKS15A112AA	Heating Capacity (BTU/H)	18,000	15,930	13,850		11,760	9,680	7,640	5,660	
	Percentage of Rated Capacity	100%	89%	77%		65%	54%	42%	31%	-
NTXCKS18A112AA / NTXSKS18A112AA	Heating Capacity (BTU/H)	19,700	17,440	15,150		12,870	10,600	8,370	6,190	
	Percentage of Rated Capacity	100%	89%	77%		65%	54%	42%	31%	-
NTXDKS09A112AA / NTXSKS09A112AA	Heating Capacity (BTU/H)	12,000	10,620	9,230		7,840	6,450	5,090	3,770	
	Percentage of Rated Capacity	100%	89%	77%		65%	54%	42%	31%	-
NTXDKS12A112AA / NTXSKS12A112AA	Heating Capacity (BTU/H)	15,000	13,280	11,540		9,800	8,070	6,370	4,710	
	Percentage of Rated Capacity	100%	89%	77%		65%	54%	42%	31%	-
NTXDKS15A112AA / NTXSKS15A112AA	Heating Capacity (BTU/H)	18,000	15,930	13,850		11,760	9,680	7,640	5,660	
	Percentage of Rated Capacity	100%	89%	77%		65%	54%	42%	31%	-
NTXDKS18A112AA / NTXSKS18A112AA	Heating Capacity (BTU/H)	21,600	19,120	16,620		14,110	11,620	9,170	6,790	
	Percentage of Rated Capacity	100%	89%	77%		65%	54%	42%	31%	-
TPEADA0091AA70A / NTXSKS09A112AA	Heating Capacity (BTU/H)	12,000	10,620	9,230		7,840	6,450	5,090	3,770	
	Percentage of Rated Capacity	100%	89%	77%		65%	54%	42%	31%	-
TPEADA0121AA70A / NTXSKS12A112AA	Heating Capacity (BTU/H)	15,000	13,280	11,540		9,800	8,070	6,370	4,710	
	Percentage of Rated Capacity	100%	89%	77%		65%	54%	42%	31%	-
TPEADA0151AA70A / NTXSKS15A112AA	Heating Capacity (BTU/H)	18,000	15,930	13,850		11,760	9,680	7,640	5,660	
	Percentage of Rated Capacity	100%	89%	77%		65%	54%	42%	31%	-

Outdoor Temperature (° F)		50	41.0	32.0		23.0	14.0	5.0	-4	-13
TPEADA0181AA70A / NTXSKS18A112AA	Heating Capacity (BTU/H)	21,600	19,120	16,620		14,110	11,620	9,170	6,790	
	Percentage of Rated Capacity	100%	89%	77%		65%	54%	42%	31%	-
TPEADA0241AA70A / NTXSKS24A112AA	Heating Capacity (BTU/H)	25,000	22,130	19,230		16,330	13,450			
	Percentage of Rated Capacity	100%	89%	77%		65%	54%	-	-	-
TPEADA0301AA70A / NTXSKS30A112AA	Heating Capacity (BTU/H)	30,000	26,560	23,080		19,600	16,140			
	Percentage of Rated Capacity	100%	89%	77%		65%	54%	-	-	-
TPEADA0361AA70A / NTXSKS36A112AA	Heating Capacity (BTU/H)	33,500	29,660	25,770		21,890	18,030			
	Percentage of Rated Capacity	100%	89%	77%		65%	54%	-	-	-
NTXAMT12A112AA / NTXSKS12A112AA	Heating Capacity (BTU/H)	15,000	13,280	11,540		9,800	8,070	6,370	4,710	
	Percentage of Rated Capacity	100%	89%	77%		65%	54%	42%	31%	-
NTXAMT18A112AA / NTXSKS18A112AA	Heating Capacity (BTU/H)	21,600	19,120	16,620		14,110	11,620	9,170	6,790	
	Percentage of Rated Capacity	100%	89%	77%		65%	54%	42%	31%	-
NTXAMT24A112AA / NTXSKS24A112AA	Heating Capacity (BTU/H)	25,000	22,130	19,230		16,330	13,450			
	Percentage of Rated Capacity	100%	89%	77%		65%	54%	-	-	-
NTXAMT30A112AA / NTXSKS30A112AA	Heating Capacity (BTU/H)	30,000	26,560	23,080		19,600	16,140			
	Percentage of Rated Capacity	100%	89%	77%		65%	54%	-	-	-
NTXAMT36A112AA / NTXSKS36A112AA	Heating Capacity (BTU/H)	33,500	29,660	25,770		21,890	18,030			
	Percentage of Rated Capacity	100%	89%	77%		65%	54%	-	-	-
NTXUKS09A112AA / NTXSKH09A112AA	Heating Capacity (BTU/H)	12,000	12,000	12,000		12,000	12,000	12,000	8,640	5,160
	Percentage of Rated Capacity	100%	100%	100%		100%	100%	100%	72%	43%
NTXUKS12A112AA / NTXSKH12A112AA	Heating Capacity (BTU/H)	15,000	15,000	15,000		15,000	15,000	15,000	10,800	6,450
	Percentage of Rated Capacity	100%	100%	100%		100%	100%	100%	72%	43%
NTXUKS18A112AA / NTXSKH18A112AA	Heating Capacity (BTU/H)	18,600	18,600	18,600		18,600	18,600	18,600	13,392	7,998
	Percentage of Rated Capacity	100%	100%	100%		100%	100%	100%	72%	43%
NTXCKS09A112AA / NTXSKH09A112AA	Heating Capacity (BTU/H)	11,000	11,000	11,000		11,000	11,000	11,000	7,920	4,730
	Percentage of Rated Capacity	100%	100%	100%		100%	100%	100%	72%	43%
NTXCKS12A112AA / NTXSKH12A112AA	Heating Capacity (BTU/H)	13,800	13,800	13,800		13,800	13,800	13,800	9,936	5,934
	Percentage of Rated Capacity	100%	100%	100%		100%	100%	100%	72%	43%
NTXCKS15A112AA / NTXSKH15A112AA	Heating Capacity (BTU/H)	16,400	16,400	16,400		16,400	16,400	16,400	11,808	7,052
	Percentage of Rated Capacity	100%	100%	100%		100%	100%	100%	72%	43%
NTXCKS18A112AA / NTXSKH18A112AA	Heating Capacity (BTU/H)	18,800	18,800	18,800		18,800	18,800	18,800	13,536	8,084
	Percentage of Rated Capacity	100%	100%	100%		100%	100%	100%	72%	43%

Outdoor Temperature (° F)		50	41.0	32.0		23.0	14.0	5.0	-4	-13
NTXDKS09A112AA / NTXSKH09A112AA	Heating Capacity (BTU/H)	12,500	12,500	12,500		12,500	12,500	12,500	9,000	5,375
	Percentage of Rated Capacity	100%	100%	100%		100%	100%	100%	72%	43%
NTXDKS12A112AA / NTXSKH12A112AA	Heating Capacity (BTU/H)	15,000	15,000	15,000		15,000	15,000	15,000	10,800	6,450
	Percentage of Rated Capacity	100%	100%	100%		100%	100%	100%	72%	43%
NTXDKS15A112AA / NTXSKH15A112AA	Heating Capacity (BTU/H)	15,000	15,000	15,000		15,000	15,000	15,000	10,800	6,450
	Percentage of Rated Capacity	100%	100%	100%		100%	100%	100%	72%	43%
NTXDKS18A112AA / NTXSKH18A112AA	Heating Capacity (BTU/H)	21,600	21,600	21,600		21,600	21,600	21,600	15,552	9,288
	Percentage of Rated Capacity	100%	100%	100%		100%	100%	100%	72%	43%
TPEADA0091AA70A / NTXSKH09A112AA	Heating Capacity (BTU/H)	12,000	12,000	12,000		12,000	12,000	12,000	8,640	5,160
	Percentage of Rated Capacity	100%	100%	100%		100%	100%	100%	72%	43%
TPEADA0121AA70A / NTXSKH12A112AA	Heating Capacity (BTU/H)	15,000	15,000	15,000		15,000	15,000	15,000	10,800	6,450
	Percentage of Rated Capacity	100%	100%	100%		100%	100%	100%	72%	43%
TPEADA0151AA70A / NTXSKH15A112AA	Heating Capacity (BTU/H)	18,000	18,000	18,000		18,000	18,000	18,000	12,960	7,740
	Percentage of Rated Capacity	100%	100%	100%		100%	100%	100%	72%	43%
TPEADA0181AA70A / NTXSKH18A112AA	Heating Capacity (BTU/H)	21,600	21,600	21,600		21,600	21,600	21,600	15,552	9,288
	Percentage of Rated Capacity	100%	100%	100%		100%	100%	100%	72%	43%
TPEADA0241AA70A / NTXSKH24A112AA	Heating Capacity (BTU/H)	25,000	25,000	25,000		25,000	25,000	25,000	22,250	20,000
	Percentage of Rated Capacity	100%	100%	100%		100%	100%	100%	89%	80%
TPEADA0301AA70A / NTXSKH30A112AA	Heating Capacity (BTU/H)	32,000	32,000	32,000		32,000	32,000	32,000	28,480	25,600
	Percentage of Rated Capacity	100%	100%	100%		100%	100%	100%	89%	80%
TPEADA0361AA70A / NTXSKH36A112AA	Heating Capacity (BTU/H)	37,000	37,000	37,000		37,000	37,000	37,000	32,930	29,600
	Percentage of Rated Capacity	100%	100%	100%		100%	100%	100%	89%	80%
NTXAMT12A112AA / NTXSKH12A112AA	Heating Capacity (BTU/H)	15,000	15,000	15,000		15,000	15,000	15,000	10,800	6,450
	Percentage of Rated Capacity	100%	100%	100%		100%	100%	100%	72%	43%
NTXAMT18A112AA / NTXSKH18A112AA	Heating Capacity (BTU/H)	21,600	21,600	21,600		21,600	21,600	21,600	15,552	9,288
	Percentage of Rated Capacity	100%	100%	100%		100%	100%	100%	72%	43%
NTXAMT24A112AA / NTXSKH24A112AA	Heating Capacity (BTU/H)	23,000	23,000	23,000		23,000	23,000	23,000	20,470	18,400
	Percentage of Rated Capacity	100%	100%	100%		100%	100%	100%	89%	80%
NTXAMT30A112AA / NTXSKH30A112AA	Heating Capacity (BTU/H)	32,000	32,000	32,000		32,000	32,000	32,000	28,480	25,600
	Percentage of Rated Capacity	100%	100%	100%		100%	100%	100%	89%	80%
NTXAMT36A112AA / NTXSKH36A112AA	Heating Capacity (BTU/H)	37,000	37,000	37,000		37,000	37,000	37,000	32,930	29,600
	Percentage of Rated Capacity	100%	100%	100%		100%	100%	100%	89%	80%

Outdoor Temperature (° F)		50	41.0	32.0		23.0	14.0	5.0	-4	-13
NTXMMX20A122AA	Heating Capacity (BTU/H)	22,000	22,000	18,920		15,840	12,980	9,900	-	-
	Percentage of Rated Capacity	100%	100%	86%		72%	59%	45%	-	-
NTXMMX24A132AA	Heating Capacity (BTU/H)	25,000	25,000	24,000		20,750	17,250	13,250	-	-
	Percentage of Rated Capacity	100%	100%	96%		83%	69%	53%	-	-
NTXMMX30A132AA	Heating Capacity (BTU/H)	28,600	28,600	28,020		24,310	20,300	15,730	-	-
	Percentage of Rated Capacity	100%	100%	98%		85%	71%	55%	-	-
NTXMMX36A142AA	Heating Capacity (BTU/H)	36,000	36,000	33,480		29,160	24,120	18,720	-	-
	Percentage of Rated Capacity	100%	100%	93%		81%	67%	52%	-	-
NTXMMX42A152AA	Heating Capacity (BTU/H)	45,000	45,000	41,850		36,450	30,150	23,400	-	-
	Percentage of Rated Capacity	100%	100%	93%		81%	67%	52%	-	-
NTXMMX48A182BA	Heating Capacity (BTU/H)	48,000	48,000	48,000		39,840	32,160	28,800	25,440	-
	Percentage of Rated Capacity	100%	100%	100%		83%	67%	60%	53%	-
NTXMMX60A182BA	Heating Capacity (BTU/H)	60,000	60,000	60,000		51,000	40,800	36,000	31,200	-
	Percentage of Rated Capacity	100%	100%	100%		85%	68%	60%	52%	-
NTXMPH20A122AA	Heating Capacity (BTU/H)	22,000	22,000	22,000		22,000	22,000	22,000	21,120	20,460
	Percentage of Rated Capacity	100%	100%	100%		100%	100%	100%	96%	93%
NTXMPH24A132AA	Heating Capacity (BTU/H)	25,000	25,000	25,000		25,000	25,000	25,000	23,750	22,500
	Percentage of Rated Capacity	100%	100%	100%		100%	100%	100%	95%	90%
NTXMPH30A132AA	Heating Capacity (BTU/H)	28,600	28,600	28,600		28,600	28,600	28,600	26,880	25,160
	Percentage of Rated Capacity	100%	100%	100%		100%	100%	100%	94%	88%
NTXMPH36A142BA	Heating Capacity (BTU/H)	36,000	36,000	36,000		36,000	36,000	36,000	30,960	26,640
	Percentage of Rated Capacity	100%	100%	100%		100%	100%	100%	86%	74%
NTXMPH42A152BA	Heating Capacity (BTU/H)	42,000	42,000	42,000		42,000	42,000	42,000	36,120	31,080
	Percentage of Rated Capacity	100%	100%	100%		100%	100%	100%	86%	74%
NTXMPH48A182BA	Heating Capacity (BTU/H)	48,000	48,000	48,000		48,000	48,000	48,000	41,280	35,520
	Percentage of Rated Capacity	100%	100%	100%		100%	100%	100%	86%	74%

MX Model Accessories

BV-Series Ball Valves

- Engineered for Mini-split and Multi-split HVAC Units
- Full Port Design
- 700 PSIG Rated
- R-410A Compatible
- Flare Connections
- Forged and machined one-piece unibody construction
- Sizes available: 1/4"; 3/8"; 1/2"; 5/8"
- Fully factory assembled
- Furnace brazed and pressure tested
- Each ball valve is equipped with 4-1/4" Schrader® valve for refrigerant service
- Design working pressure: 700 PSIG
- Temperature range: -40° F to +325° F (-40° C to +149° C)
- Forged and machined brass unibody designed with forged brass seal cap
- Polytetrafluoroethylene (PTFE) seals and gaskets (no synthetic O-rings)
- Seal cap design permits valve operation without removal of seal cap
- Uses suitable for/with R-11, R-22, R-123, R-125, R-134A, R-236FA, R-4202A, R-402B, R-404A, R-407C, R-410A, R-500, R-502, and R-507
- One-year limited materials and workmanship warranty on ball valves



Model numbers:

BV14FFSI2

BV38FFSI2

BV12FFSI2

BV58FFSI2



Platform Stands

Lift the Trane®/Mitsubishi Electric outdoor unit to new heights with our Diamondback Platform Stands.

- Easy to install
- Available for all sizes of Nv- and P-Series outdoor units
- Color matched to the outdoor units
- One-year warranty

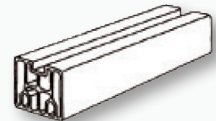

Model Number: DSD-400N
L: 15-3/4" x W: 3-1/4" x H: 3-1/4"

Part Number	SAE Flare	A	B	C	D	E	F
BV14FFSI2	1/4"	6.26	2.67	1.81	1.23	1.42	1.10
BV38FFSI2	3/8"	6.30	2.67	1.81	1.23	1.42	1.10
BV12FFSI2	1/2"	6.51	2.67	1.81	1.23	1.42	1.10
BV58FFSI2	5/8"	6.64	2.67	1.81	1.23	1.42	1.10

*Ball valves come with an insulation piece

Nv-Series Sizing

It is very important that all contractors follow proper procedure and size units based on a Manual J calculation. A load calculation takes into account all the factors that cause a building to lose heat in the winter and gain heat in the summer. Some of the factors taken into consideration are exposed walls, insulation, windows, doors, and even the direction the building faces.

Inverter technology has changed the way heat pumps are used. Because the INVERTER-driven compressor can vary the capacity of the system, we

can now size units based on the largest load, which in many cases may be the heat load. When single speed compressors are sized on heat load and changed over to cooling, the units can be grossly oversized. The result is very little dehumidification and comfort problems.

Using charts like the ones below from the technical service manual, you can check the equipment capacity at the design temperatures for heating and cooling. If these values fall within both the heating and cooling capacity ranges of the system, you can select that system with confidence.

NTXWPH/NTXSPH09

HEATING CAPACITY

	Outdoor Temperature					Outdoor Temperature			
	50° F	41° F	32° F	23° F		14° F	5° F	-4° F	-13° F
Heating Capacity (BTU/H)	18,554	17,631	16,707	15,068		13,304	11,540	9,600	8,048
Percentage of Rated Capacity	100%	100%	100%	100%		100%	100%	100%	84%

COOLING CAPACITY

Indoor Air	Outdoor intake air DB temperature (°F)							Outdoor intake air DB temperature (°F)								
	75			85				95			105			115		
IWB (°F)	TC	SHC	TPC	TC	SHC	TPC		TC	SHC	TPC	TC	SHC	TPC	TC	SHC	TPC
71	11.0	8.7	0.5	10.3	8.1	0.55		9.7	7.6	0.59	9.0	7.1	0.62	8.3	6.5	0.64
67	10.4	9.6	0.47	9.7	8.9	0.52		9.0	8.3	0.56	8.4	7.7	0.59	7.7	7.1	0.62
63	9.8	10.3	0.45	9.1	9.6	0.50		8.5	8.9	0.53	7.7	8.1	0.57	7.0	7.4	0.59

Notes: IWB: Intake air wet-bulb temperature

TC: Total capacity SHC: Sensible heat capacity TPC: Total power consumption (kW)



kumo cloud is a cloud service used to remotely or locally control your indoor units. This is achievable by installing the Wireless Interface (PAC-USWH5002-WF-2) in each indoor unit.

The kumo cloud app can monitor, control, and schedule multiple indoor units in multiple locations across Apple, Android, and Amazon Fire devices!

Specifications and Requirements

- Allows for a an indoor unit to be controlled remotely or locally with the kumo cloud® app and web service
- Available in:
 - Apple App Store iOS® 9.0 and newer
 - Google Play Android™ 4.1 and newer
 - Amazon Appstore 4.1 and newer
- Web access at kumocloud.com
- Availability to group units together
- Organize groups into sites
- Batch command units
- Program in events to schedule the units
- Available in Fahrenheit or Celsius
- Error and Filter notification
- Manual setup to add units
- Internet access is required for initial setup and scheduling
- A Wireless Interface (PAC-USWH5002-WF-2) installed by a professional contractor
- Smartphone with kumo cloud app required
- IFTTT Applet integration to control transfer fans, lighting and much more
- Integrate control of third party emergency hydronic heat in low ambient conditions

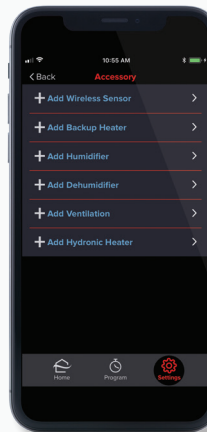

Apple and the App Store are registered trademarks of Apple, Inc. Amazon, Alexa, Fire and all related logos are trademarks of Amazon.com, Inc. or its affiliates. Google play is a registered trademark of Google, Inc.

Controllers

kumo station®

Specifications

- 4 outputs to control auxiliary heat, hydronic heat, humidifier, dehumidifier, ERV or HRV*
- Controls 1 or 2 stages of supplemental heat*
- Wireless Interface required to connect to kumo cloud®
- 24 VAC power supply required. Supplied by others
- Compatible with kumo cloud 2.6 or later



TAC-WHS01HC-E

Wireless Interface

Specifications

- Allows for indoor units to communicate with kumo cloud app and web service
- Wireless connection over local wifi network
- Connected to indoor unit via CN105
- One Wireless Interface required per connected indoor unit
- Dimensions: 1.82" H x 0.69" W x 2.92" D
- Radio protocol: IEEE 802.11 b/g/n - 2.4 GHz only
- Internet access required for initial setup and scheduling



PAC-USWHS002-WF-2

Ducted indoor unit fan interlock may be required. Check Install Manual for details.

*Requires wireless temperature and humidity sensor.

Wireless Temperature And Humidity Sensor For kumo cloud

Specifications

- One wireless remote sensor per Wireless Interface 2
- Connects via Bluetooth Low Energy with Wireless Interface 2
- Specified open range 33 feet (10 m)
- Battery powered (1 year battery life)
- Push notifications when battery is low through kumo cloud app



PAC-USWHS003-TH-1

Controllers

kumo touch™

MHK2 Wireless Remote Controller Kit

Exclusive for INVERTER-driven
Nv-Series and P-Series Systems

**RedLINK
Wireless Remote
Controller and Receiver
MHK2**



Function	Description
ON/OFF	On/Off operation for a single indoor unit
Operation Mode	Cool/Drying/Auto/Heat/Fan only Available operation modes dependent upon connected system
Temperature Setting	Set temperature from 61° F to 86° F for Nv-Series and 67° F to 89° F for P-Series
System Changeover Deadband Value	2° F to 8° F
Schedule Operation	7, 5-2, 5-1-1, 1-1-1-1-1-1-1
Fan Speed Setting	Quiet/Low/Medium/High/Super High/Auto. Available fan speed settings dependent upon connected system
Airflow Direction Setting	Airflow angles: 100° - 80° - 60° - 40° and oscillate. Available airflow direction settings dependent upon connected system
Permit/Prohibit Function	Individual prohibit operations for each remote controller function (ON/ OFF, Set Temperature, and Mode)
Space Temperature	Displays the measured space temperature
Error Indication	Displays error code
Dimensions – (W x D x H)	Remote Controller: 4-5/64" x 4-5/64" x 1-1/16" Receiver: 3-3/32" x 1-3/4" x 39/64"
Operating Ambient Tem- perature	Remote Controller: 32° F to 120° F Receiver: -40° F to 165° F
Operating Ambient Humidity	Remote Controller: 5% to 90% RH (non-condensing) Receiver: 5% to 95% RH (non-condensing)
Power Supply	2 AA batteries (included)

Controllers

kumo touch™

MHK2 Wireless Remote Controller Kit

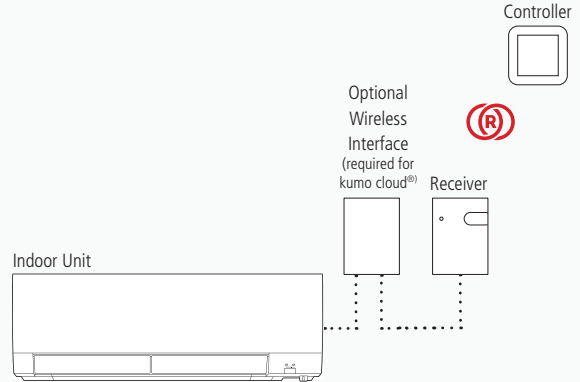

kumo touch™ Wireless Wall-mounted Remote Controller

- Backlit touchscreen
- Dual set point is only available when the MIFH2 is connected to a Wireless Interface 2 (PAC-USWHS002-WF-2) and has been set up with kumo cloud
- Enabled with RedLINK® reliability
- Installs anywhere with simple wall-mounted design
- Requires wireless receiver (included in kit)

MIFH2 Wireless Receiver

- Required for MRCH2 Wireless Remote Controller
- Enabled with RedLINK reliability

Controllers

Handheld | Wireless Controller

Wireless

Standard for Nv-Series wall-mounted and floor-mounted systems and optional for CKS, DKS and P-Series indoor units

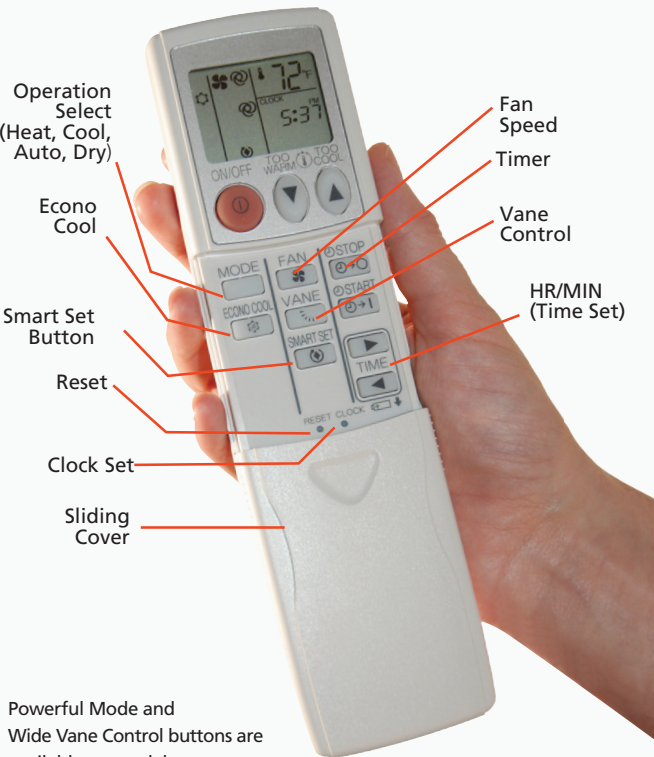

Operation Select (Heat, Cool, Auto, Dry)

Econo Cool

Smart Set Button

Reset

Clock Set

Sliding Cover

Fan Speed

Timer

Vane Control

HR/MIN (Time Set)

Powerful Mode and Wide Vane Control buttons are available on models WST24/30/36

WST model remote shown, models vary

Controllers

Wired Controllers | Touch MA Remote Controller

Specifications

- User-friendly, customizable full color touch panel display
- Ability to add a custom logo on the display
- Large icons with 180 color patterns
- Daily and weekly timers
- Password protected
- Requires MAC-334IF-E for use with Nv-Series products
- The MELRemo app and Bluetooth® Low Energy (BLE) technology supports communication with smartphones or tablets in multiple languages.



TAR-CT01MAU-SB

Controllers

Wired Controllers | Simple MA

Controls group operation for up to 16 indoor units in a single group

- Supports both Fahrenheit and Celsius
- User-defined functions:



TAC-YT53CRAU-J

- On/Off
- Operation mode: COOL, HEAT, FAN, DRYING, or SETBACK
- Set temperature
- Fan speed setting
- Airflow direction
- Set temperature range: 40° F to 95° F depending on operation mode and indoor unit connected

- Set temperature range limit can be reduced for cool and heat modes
- Room temperature can be sensed either at the indoor unit (default) or at the remote controller
- Diagnostics: Displays four-digit error code and error unit address
- Grouping: Same group use only with other TAC-YT53CRAU-J Simple MA Controllers, TAR-40MAAU Wired Deluxe MA Remote Controllers, and TAR-FL32MA-E Wireless MA Remote Controllers with up to two remote controllers per group
- Addressing: No addressing required
- Wiring: Connects using two-wire, stranded, non-polar control wire to indoor unit connection terminal or control adapter (MAC-334IF-E for Nv-Series) requires crossover wiring for indoor unit grouping
- Dimensions: 2-3/4" x 9/16" x 4-3/4" (70mm x 14.5mm x 120mm)

Controllers

Wired Controllers | Deluxe MA

Controls group operation for up to 16 indoor units in a single group

- Features selectable multilingual LCD (English, Spanish, and French)

User functions allow user to set:

- Timer Operation:

- Weekly Timer: On/Off/ Temperature setting up to 8 times per day of the week in 1-minute increments
- Simple Timer: On and Off time can be set once within 72-hour period in 1-hour increments
- Auto-off Timer: Turns indoor unit off based on countdown time up to 4-hours in 30-minute increments

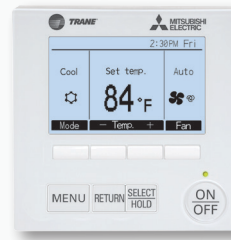

TAR-40MAAU

- 3D i-see Sensor® Functions:
 - No Occupancy Auto-Off
 - Indirect/Direct mode
- Room Temperature: Displays room temperature sensed either at the indoor unit (default) or at the remote controller
- Set Temperature Range Limit: From the backlit MA Controller, the allowable set temperature range can be reduced for cool and heat modes
- Special Function Rotation/Backup (Lead/Lag for P-Series)
- Static pressure setting (model dependent)
- Fan speed setting for use with supplemental heating function (model dependent)
- Function Lock Out: Prohibits all functions or all functions except On/Off from the backlit MA controller
- Wiring: Connects using two-wire, stranded, non-polar control wire to indoor unit connection terminal or control adapter (MAC-334IF-E for Nv-Series) requires crossover wiring for indoor unit grouping
- Dimensions: 4-3/4" x 3/4" x 4-3/4" (120mm x 19mm x 120 mm)

Controllers

Third Party Controls Interface

BACnet® & Modbus® Interface

Specifications

- Allows for third-party home automation/building management system to control indoor unit
- One interface required per indoor unit
- Powered from indoor unit CN105 connection
- Compatible with remote controllers
- Dimensions: 3.74" x 2" x 0.75"
- Cable length: 37"



PAC-UKPRC001-CN-1

Thermostat Interface Control Adapter

Specifications

- Allows an HVAC Thermostat or I/O Controller to control an Nv-Series or P-Series indoor unit
- One Thermostat Interface required per indoor unit
- Indoor unit modes available: Cool, Heat, Fan, and Off
- Provides three input terminals to control fan speed control: High, Medium, and Low
- No addressing required



PAC-US444CN-1

Controllers

Specifications continued...

- Thermostats tested:
 - Nest®
 - Honeywell® Lyric™
 - INNCOM® by Honeywell® with High and Low fan speed control
- Dimensions: (H x W x D) 3.96" x 3.17" x 0.93"
- Terminal Block: 20–30 VAC Rated
- Required: Active CN105 on Trane®/Mitsubishi Electric indoor unit control board
- Required: HVAC Thermostat or I/O Controller (field supplied)
- Required: 24VAC power supply for HVAC Thermostat (field supplied)

Advanced Features

- Delayed off adjustable setting
- Static pressure adjustable setting
- CN24 operation during defrost
- Fan speed during thermal off heating mode
- Two-stage heat and cool thermostat operation
- Conventional 2H/2C system operation (preferred)
- Conventional 1H/1C system operation
- Auto recovery after power failure
- Thermostat detects room temperature
- Optional accessory transformer (VPL24-210) to be used with multiposition indoor units

P-Series Indoor Units

Multiple controller options ▶



Connect to cooling-only TRUY, heat pump TRUZ, and Hyper-heating TRUZH INVERTER-driven compressor outdoor units.

TPKA Wall-mounted Indoor Unit

Cooling-only and Heat Pumps

- Provides cooling and heating in a wide range of capacities
- Auto flap shutter
- Auto fan control
- Easy-clean washable filters



(12,000 to 36,000 BTU/H)

TPCA Ceiling-suspended Indoor Unit

Cooling-only and Heat Pumps

- Optional i-see Sensor™
- Knockout for ventilation air
- Auto fan speed control
- Optional, high-efficiency filter



(24,000 to 42,000 BTU/H)

TPLA Ceiling Cassette Indoor Unit

Cooling-only and Heat Pumps

- Built-in condensate lift mechanism (33" lift)
- Branch duct outlet
- Standard with 3D i-see Sensor®
- Knockout for ventilation air



(12,000 to 42,000 BTU/H)

TPVA Multi-position Air Handler

Provides cooling and heating to larger zones

- Performance: One-inch foam R4.2, fiberglass-free insulation reduces condensation and boosts efficiency
- Quality: Durable, powder-coated cabinet
- Serviceability: Easily removable fan provides access for coil cleaning
- Flexibility: True multi-position, requiring no additional kits for downflow configuration
- Multi-position installation: horizontal (left or right), vertical (up or down). For downflow configurations, the CMA-1 is recommended for proper management of condensate to prevent water blow-off in certain conditions
- Installation: Quality construction with disassembly in mind to make fitting through tight access points simple
- Comfort: DC motor ensures quiet and efficient operation year round
- Low Impact: Fully RoHS compliant to reduce carbon footprint
- Air Quality: Positively pressurized cabinet and tested air leakage less than 1%



(12,000 to 42,000 BTU/H)

TPEAD Horizontal-ducted Indoor Unit

Cooling-only and Heat Pumps

- Automatic fan speed control
- Built-in condensate lift mechanism (27-9/16" lift)
- Adjustable static pressure



(9,000 to 42,000 BTU/H)

P-Series Systems

TPLA

Four-way Ceiling Cassette

(air conditioners)

(heat pumps)



TRU(Y/Z)A0181KA70N*



TPLA0A0181EA70*

Indoor Unit Model #	TPLA0A0121EA70*	TPLA0A0181EA70*	TPLA0A0241EA70*	TPLA0A0301EA70*	TPLA0A0361EA70*	TPLA0A0421EA70*
Outdoor Unit Model # (Cooling Only)	TRUYA0121KA70N*	TRUYA0181KA70N*	TRUYA0241HA70N*	TRUYA0301HA70N*	TRUYA0361KA70N*	TRUYA0421KA70N*
Outdoor Unit Model # (Heat Pump)	TRUZA0121KA70N*	TRUZA0181KA70N*	TRUZA0241HA70N*	TRUZA0301HA70N*	TRUZA0361KA70N*	TRUZA0421KA70N*
Rated Cooling Capacity (BTU/H)	12,000	18,000	24,000	30,000	36,000	42,000
Cooling Capacity Range (BTU/H)	5,800–12,000	8,000–18,000	10,000–24,000	9,000–30,000	16,000–36,000	16,000–42,000
Rated Heating Capacity (BTU/H)	14,000	19,000	26,000	32,000	38,000	45,000
Heating Capacity Range (BTU/H)	5,500–20,000	7,900–23,000	9,000–29,000	9,000–33,000	18,000–42,000	18,000–48,000
Max. Heating Capacity at 17° F (BTU/H)	12,940	14,881	18,763	21,351	27,174	31,056
Max. Heating Capacity at 5° F (BTU/H)	N/A	N/A	16,878	19,206	24,444	27,936
SEER	27.0	24.6	24.2	22.8	21.8	21.0
HSPF	12.8	11.0	11.2	11.6	10.4	10.0
EER	16.4	14.4	14.3	11.8	12.9	11.6
Airflow at Cooling (CFM)	530-490-460-420	600-570-490-460	810-710-640-530	880-780-670-570	1,200-1,020-850-670	1,200-1,060-920-740
Airflow at Heating (CFM)	530-490-460-420	600-570-490-460	810-710-640-530	880-780-670-570	1,200-1,020-850-670	1,200-1,060-920-740
Lineset Size (Liquid x Gas)	1/4" x 1/2"		3/8" x 5/8"			
Max. Piping Length/Height (TRUY)	165'/100'		225'/100'			
Max. Piping Length/Height (TRUZ)	100'/100'		165'/100'			
Breaker Size	15 AMP		25 AMP		30 AMP	
Cooling Operation Range—TRUY	-40° to 115° F**		-40° to 115° F**			
Cooling Operation Range—TRUZ	0° to 115° F**		0° to 115° F**			
Heating Operation Range*	12° to 70° F		-4° to 70° F			
Multi-split Connection	Yes		Yes			No

*Heat pump only; **When wind baffle is installed

P-Series models 12K–30K BTU/H are pre-charged for up to a 70' lineset.

TRUYA/TRUZA (36/42) and Hyper-heating models are pre-charged for up to a 100' lineset

Test conditions are based on AHRI 210/240.

P-Series Systems

TPVA

Horizontal-ducted Indoor Unit

(air conditioners)

(heat pumps)

TPVA0A0181AA70*



TRU(Y/Z)A0181KA70N*



Indoor Unit Model #	TPVA0A0121AA70*	TPVA0A0181AA70*		TPVA0A0241AA70*	TPVA0A0301AA70*	TPVA0A0361AA70*	TPVA0A0421AA70*
Outdoor Unit Model # (Cooling Only)	TRUYA0121KA70N*	TRUYA0181KA70N*		TRUYA0241HA70N*	TRUYA0301HA70N*	TRUYA0361KA70N*	TRUYA0421KA70N*
Outdoor Unit Model # (Heat Pump)	TRUZA0121KA70N*	TRUZA0181KA70N*		TRUZA0241HA70N*	TRUZA0301HA70N*	TRUZA0361KA70N*	TRUZA0421KA70N*
Rated Cooling Capacity (BTU/H)	12,000	18,000		24,000	30,000	36,000	42,000
Cooling Capacity Range (BTU/H)	4,800–12,000	7,000–18,000		10,000–24,000	10,000–30,000	14,600–36,000	15,000–42,000
Rated Heating Capacity (BTU/H)	14,000	19,000		26,000	32,000	38,000	46,000
Heating Capacity Range (BTU/H)	5,700–19,000	7,700–23,000		12,000–28,000	12,000–34,000	17,700–42,000	18,100–48,000
Max. Heating Capacity at 17° F (BTU/H)	12,293	14,881		18,116	21,998	27,174	31,056
Max. Heating Capacity at 5° F (BTU/H)	N/A	N/A		N/A	N/A	N/A	N/A
SEER	21.4	20.2		20.5	19.0	19.3	18.0
HSPF	10.3	10.4		9.3	10.0	9.5	9.3
EER	13.4	11.4		12.2	10.0	9.8	10.1
Airflow at Cooling (CFM)	400-340-380	735-625-515		875-744-613		1,125-956-788	1,485-1,262-1,040
Airflow at Heating (CFM)	400-340-380	735-625-515		875-744-613		1,125-956-788	1,485-1,262-1,040
Lineset Size (Liquid x Gas)	1/4" x 1/2"			3/8" x 5/8"			
ESP (in. WG)	0.80-0.50-0.30			0.80-0.50-0.30			
Max. Piping Length/Height (TRUY)	165'/100'			225'/100'			
Max. Piping Length/Height (TRUZ)	100'/100'			165'/100'			
Breaker Size	15 AMP			25 AMP		30 AMP	
Cooling Operation Range—TRUY	-40° to 115° F**			-40° to 115° F**			
Cooling Operation Range*—TRUZ	0° to 115° F**			0° to 115° F**			
Heating Operation Range*	12° to 70° F			-4° to 70° F			
Multi-split Connection	No			No			

*Heat pump only; **When wind baffle is installed

P-Series models 12K–30K BTU/H are pre-charged for up to a 70' lineset.

TRUYA/TRUZA (36/42) and Hyper-heating models are pre-charged for up to a 100' lineset

Test conditions are based on AHRI 210/240.

P-Series Systems

TPEAD

Mid Static Horizontal-ducted Indoor Unit

(air conditioners)

(heat pumps)

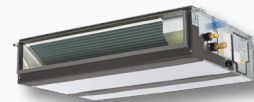

TPEADA0181AA70*

TRU(Y/Z)A0181KA70N*

Indoor Unit Model #	TPEADA0121AA70*	TPEADA0181AA70*		TPEADA0241AA70*	TPEADA0301AA70*	TPEADA0361AA70*	TPEADA0421AA70*
Outdoor Unit Model # (Cooling Only)	TRUYA0121KA70N*	TRUYA0181KA70N*		TRUYA0241HA70N*	TRUYA0301HA70N*	TRUYA0361KA70N*	TRUYA0421KA70N*
Outdoor Unit Model # (Heat Pump)	TRUZA0121KA70N*	TRUZA0181KA70N*		TRUZA0241HA70N*	TRUZA0301HA70N*	TRUZA0361KA70N*	TRUZA0421KA70N*
Rated Cooling Capacity (BTU/H)	12,000	18,000		24,000	30,000	36,000	42,000
Cooling Capacity Range (BTU/H)	5,000–12,000	8,000–18,000		10,000–24,000	9,000–30,000	16,000–36,000	16,000–42,000
Rated Heating Capacity (BTU/H)	14,000	19,000		26,000	32,000	38,000	45,000
Heating Capacity Range (BTU/H)	5,800–18,000	7,900–22,000		9,000–28,000	8,800–34,000	18,200–40,000	18,100–48,000
Max. Heating Capacity at 17° F (BTU/H)	11,646	14,234		18,116	21,998	25,880	31,056
Max. Heating Capacity at 5° F (BTU/H)	N/A	N/A		16,296	19,788	24,444	27,936
SEER	21.1	19.9		19.6	19.1	19.1	16.1
HSPF	10.2	10.2		10.8	10.8	9.9	10.0
EER	13.0	10.8		11.7	10.0	12.0	10.7
Airflow at Cooling (CFM)	494-424-353	600-512-424		741-635-512	883-742-618	1,201-1,024-847	1,483-1,254-1,042
Airflow at Heating (CFM)	494-424-353	600-512-424		741-635-512	883-742-618	1,201-1,024-847	1,483-1,254-1,042
ESP (IN. WG)	0.60-0.40-0.28-0.20-0.14			0.60-0.40-0.28-0.20-0.14			
Lineset Size (Liquid x Gas)	1/4" x 1/2"			3/8" x 5/8"			
Max. Piping Length/Height (TRUY)	165'/100'			225'/100'			
Max. Piping Length/Height (TRUZ)	100'/100'			165'/100'			
Breaker Size	15 AMP			25 AMP		30 AMP	
Cooling Operation Range—TRUY	-40° to 115° F**			-40° to 115° F**			
Cooling Operation Range*—TRUZ	0° to 115° F**			0° to 115° F**			
Heating Operation Range*	12° to 70° F			-4° to 70° F			
Multi-split Connection	Yes			Yes			No

*Heat pump only; **When wind baffle is installed

P-Series models 12K-30K BTU/H are pre-charged for up to a 70' lineset.

TRUYA/TRUZA (36/42) and Hyper-heating models are pre-charged for up to a 100' lineset

Test conditions are based on AHRI 210/240.

P-Series Systems

TPKA

Wall-mounted Indoor Unit

(air conditioners)

(heat pumps)



TRU(Y/Z)A0181KA70N*



TPKA0A0181HA70*

Indoor Unit Model #	TPKA0A0121HA70*	TPKA0A0181HA70*		TPKA0A0241KA70*	TPKA0A0301KA70*	TPKA0A0361KA70*
Outdoor Unit Model # (Cooling Only)	TRUYA0121KA70N*	TRUYA0181KA70N*		TRUYA0241HA70N*	TRUYA0301HA70N*	TRUYA0361KA70N*
Outdoor Unit Model # (Heat Pump)	TRUZA0121KA70N*	TRUZA0181KA70N*		TRUZA0241HA70N*	TRUZA0301HA70N*	TRUZA0361KA70N*
Rated Cooling Capacity (BTU/H)	12,000	18,000		24,000	30,000	36,000
Cooling Capacity Range (BTU/H)	5,800–12,000	8,000–18,000		10,000–24,000	9,000–30,000	16,000–36,000
Rated Heating Capacity (BTU/H)	14,000	19,000		26,000	32,000	38,000
Heating Capacity Range (BTU/H)	5,500–18,000	7,700–22,000		9,000–28,000	8,900–34,000	18,200–40,000
Max. Heating Capacity at 17° F (BTU/H)	11,646	14,234		18,116	21,998	25,880
Max. Heating Capacity at 5° F (BTU/H)	N/A	N/A		16,296	19,788	23,280
SEER	20.8	18.5		21.4	19.8	18.8
HSPF	10.2	10.2		11.0	9.9	9.2
EER	12.0	9.9		12.2	9.5	10.8
Airflow at Cooling (CFM)	425-370-320			775-705-635		920-810-705
Airflow at Heating (CFM)	425-370-320			775-705-635		920-810-705
Lineset Size (Liquid x Gas)	1/4" x 1/2"			3/8" x 5/8"		
Max. Piping Length/Height (TRUY)	165'/100'			225'/100'		
Max. Piping Length/Height (TRUZ)	100'/100'			165'/100'		
Breaker Size	15 AMP			30 AMP		
Cooling Operation Range—TRUY	-40° to 115° F**			-40° to 115° F**		
Cooling Operation Range*—TRUZ	0° to 115° F**			0° to 115° F**		
Heating Operation Range*	12° to 70° F			-4° to 70° F		
Multi-split Connection	No			No		

*Heat pump only; **When wind baffle is installed

P-Series models 12K–30K BTU/H are pre-charged for up to a 70' lineset.

TRUYA/TRUZA (36/42) and Hyper-heating models are pre-charged for up to a 100' lineset

Test conditions are based on AHRI 210/240.

P-Series Systems

TPCA

Ceiling-suspended Indoor Unit

(air conditioners)

(heat pumps)



TPCA0A0241KA70*



TPCA0A0241KA70*

Indoor Unit Model #	TPCA0A0241KA70*	TPCA0A0301KA70*		TPCA0A0361KA70*	TPCA0A0421KA70*
Outdoor Unit Model # (Cooling Only)	TRUYA0241HA70N*	TRUYA0301HA70N*		TRUYA0361KA70N*	TRUYA0421KA70N*
Outdoor Unit Model # (Heat Pump)	TRUZA0241HA70N*	TRUZA0301HA70N*		TRUZA0361KA70N*	TRUZA0421KA70N*
Rated Cooling Capacity (BTU/H)	24,000	30,000		36,000	42,000
Cooling Capacity Range (BTU/H)	10,000–24,000	9,000–30,000		16,000–36,000	16,000–42,000
Rated Heating Capacity (BTU/H)	26,000	32,000		38,000	45,000
Heating Capacity Range (BTU/H)	8,800–28,000	8,600–34,000		17,900–40,000	18,100–48,000
Max. Heating Capacity at 17° F (BTU/H)	18,116	21,998		25,880	31,056
Max. Heating Capacity at 5° F (BTU/H)	16,296	19,788		23,280	27,936
SEER	21.2	19.6		19.1	17.6
HSPF	10.8	10.0		10.2	10.2
EER	12.2	9.4		11.0	10.2
Airflow at Cooling (CFM)	670-600-565-530	705-635-600-565		990-920-850-775	1,025-955-885-810
Airflow at Heating (CFM)	670-600-565-530	705-635-600-565		990-920-850-775	1,025-955-885-810
Lineset Size (Liquid x Gas)	3/8" x 5/8"			3/8" x 5/8"	
Max. Piping Length/Height (TRUY)	225'/100'			225'/100'	
Max. Piping Length/Height (TRUZ)	165'/100'			165'/100'	
Breaker Size	25 AMP			30 AMP	
Cooling Operation Range—TRUY	-40° to 115° F**			-40° to 115° F**	
Cooling Operation Range*—TRUZ	0° to 115° F**			0° to 115° F**	
Heating Operation Range*	-4° to 70° F			-4° to 70° F	
Multi-split Connection	Yes	No		No	

*Heat pump only; **When wind baffle is installed

P-Series models 12K–30K BTU/H are pre-charged for up to a 70' lineset.

TRUYA/TRUZA (36/42) and Hyper-heating models are pre-charged for up to a 100' lineset

Test conditions are based on AHRI 210/240.

P-Series Systems

TPLA/TURYH Four-way Ceiling Cassette

TPCA/TURYH Ceiling-suspended Indoor Unit

(hyper-heating heat pumps)



TPLA0A0421EA70*



TPCA0A0421KA70*



TRUZH0241HA10N*



Indoor Model #	TPLA0A0241EA70*	TPLA0A0301EA70*	TPLA0A0361EA70*		TPLA0A0421EA70*	TPCA0A0241KA70*	TPCA0A0301KA70*	TPCA0A0361KA70*	TPCA0A0421KA70*
Outdoor Model #	TRUZH0241HA10N*	TRUZH0301KA00N*	TRUZH0361KA00N*		TRUZH0421KA10N*	TRUZH0241HA10N*	TRUZH0301KA00N*	TRUZH0361KA00N*	TRUZH0421KA10N*
Rated Cooling Capacity (BTU/H)	24,000	30,000	36,000		42,000	23,000	30,000	34,000	42,000
Cooling Capacity Range (BTU/H)	10,000-24,000	14,600-30,000	14,800-36,000		18,800-42,000	10,000-24,000	14,300-30,000	14,900-34,000	16,600-42,000
Rated Heating Capacity (BTU/H)	26,000	32,000	38,000		48,000	26,000	32,000	38,000	48,000
Heating Capacity Range (BTU/H)	10,000-28,000	14,200-34,000	16,700-40,000		17,000-54,000	10,000-28,000	14,400-35,000	17,400-40,000	24,000-54,000
Max. Heating Capacity at 17°F (BTU/H)	26,000	32,000	38,000		48,000	26,000	32,000	38,000	48,000
Max. Heating Capacity at 5°F (BTU/H)	26,000	32,000	38,000		48,000	26,000	32,000	38,000	48,000
Max. Heating Capacity at -13°F (BTU/H)	-	-	-		-	-	-	-	-
SEER	21.5	20.2	20.0		16.3	18.5	17.9	18.0	15.5
HSPF	11.3	9.8	10.4		9.8	10.3	9.4	10.3	10.0
EER	14.03	14.1	13		10.7	12.5	12.6	12.5	10.3
Airflow at Cooling (CFM)	530-640-710-810	570-670-780-880	670-850-1020-1200		740-920-1060-1200	530-565-600-670	565-600-635-705	775-850-920-990	810-885-955-1025
Airflow at Heating (CFM)	530-640-710-810	570-670-780-880	670-850-1020-1200		740-920-1060-1200	530-565-600-670	565-600-635-705	775-850-920-990	810-885-955-1025
ESP (In. WG)	-	-	-		-	-	-	-	-
Lineset Size (Liquid x Gas)	3/8" x 5/8"				3/8" x 5/8"				
Max. Piping Length/Height	165'/100'	245'/100'			245'/100'	165'/100'	245'/100'	245'/100'	245'/100'
Breaker Size	25 AMP	35 AMP			40 AMP	25 AMP	35 AMP		40 AMP
Cooling Operation Range	23° to 113°F				23° to 113°F				
Heating Operation Range	-13° to 70°F				-13° to 70°F				

**When wind baffle is installed

P-Series models 12K-30K BTU/H are pre-charged for up to a 70' lineset.

TRUYA/TRUZA (36/42) and Hyper-heating models are pre-charged for up to a 100' lineset

Test conditions are based on AHRI 210/240.

P-Series Systems

TPKA/TURYH Wall-mounted Indoor Unit

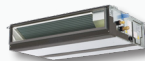

TPEADA0241AA70*



TPKA0A0241KA70*



TRUZH0241HA10N*



TPEAD/TURYH Mid Static Horizontal-ducted Indoor Unit

(hyper-heating pumps)

Indoor Model #	TPKA0A0241KA70*	TPKA0A0301KA70*	TPKA0A0361KA70*		TPEADA0241AA70*	TPEADA0301AA70*	TPEADA0361AA70*	TPEADA0421AA70*
Outdoor Model #	TRUZH0241HA10N*	TRUZH0301KA00N*	TRUZH0361KA00N*		TRUZH0241HA10N*	TRUZH0301KA00N*	TRUZH0361KA00N*	TRUZH0421KA10N*
Rated Cooling Capacity (BTU/H)	24,000	30,000	33,600		24,000	30,000	36,000	42,000
Cooling Capacity Range (BTU/H)	10,000-24,000	14,600-30,000	14,700-36,000		10,000-24,000	14,600-30,000	15,600-36,000	17,100-42,000
Rated Heating Capacity (BTU/H)	26,000	32,000	38,000		25,000	32,000	38,000	48,000
Heating Capacity Range (BTU/H)	10,000-28,000	14,600-34,000	14,900-40,000		10,000-28,000	14,800-34,000	17,400-40,000	21,200-54,000
Max. Heating Capacity at 17°F (BTU/H)	26,000	32,000	38,000		25,000	32,000	38,000	48,000
Max. Heating Capacity at 5°F (BTU/H)	26,000	32,000	38,000		25,000	32,000	38,000	48,000
Max. Heating Capacity at -13°F (BTU/H)	-	-	-		-	-	-	-
SEER	19.5	18.5	18.5		16.6	18.1	17.1	15.0
HSPF	10.6	9.6	10.0		10.4	9.6	10.4	9.8
EER	12.63	12.8	12.3		11.5	12.7	12.6	10.7
Airflow at Cooling (CFM)	635-705-775	635-705-775	705-810-920		512-635-741	618-742-883	847-1024-1201	1042-1254-1483
Airflow at Heating (CFM)	635-705-775	635-705-775	705-810-920		512-635-741	618-742-883	847-1024-1201	1042-1254-1483
ESP (In. WG)	-	-	-		0.6-0.4-0.28-0.2-0.14	0.6-0.4-0.28-0.2-0.14		
Lineset Size (Liquid x Gas)	3/8" x 5/8"					3/8" x 5/8"	3/8" x 5/8"	3/8" x 5/8"
Max. Piping Length/Height	165'/100'	245'/100'			165'/100'	245'/100'	245'/100'	245'/100'
Breaker Size	25 AMP	35 AMP			25 AMP	35 AMP		40 AMP
Cooling Operation Range	23° to 113°F				23° to 113°F			
Heating Operation Range	-13° to 70°F				-13° to 70°F			
Multi-split Connection	Yes				Yes			

**When wind baffle is installed

P-Series models 12K-30K BTU/H are pre-charged for up to a 70' lineset.

TRUYA/TRUZA (36/42) and Hyper-heating models are pre-charged for up to a 100' lineset
Test conditions are based on AHRI 210/240.

P-Series Systems

TPVA/TURYH Multi-position Air Handler

(hyper-heating pumps)



TPVA0A0241AA70*

TRUZH0241HA10N*

Indoor Model #	TPVA0A0241AA70*		TPVA0A0301AA70*	TPVA0A0361AA70*	TPVA0A0421AA70*
Outdoor Model #	TRUZH0241HA10N*		TRUZH0301KA00N*	TRUZH0361KA00N*	TRUZH0421KA10N*
Rated Cooling Capacity (BTU/H)	24,000		30,000	33,000	42,000
Cooling Capacity Range (BTU/H)	10,000-24,000		14,800-30,000	15,500-36,000	17,000-42,000
Rated Heating Capacity (BTU/H)	26,000		32,000	38,000	48,000
Heating Capacity Range (BTU/H)	10,000-28,000		14,800-34,000	18,600-40,000	23,900-54,000
Max. Heating Capacity at 17°F (BTU/H)	26,000		32,000	38,000	48,000
Max. Heating Capacity at 5°F (BTU/H)	26,000		32,000	38,000	48,000
Max. Heating Capacity at -13°F (BTU/H)	-		-	-	-
SEER	19.0		18.0	18.2	15.4
HSPF	10.4		9.8	11.2	10.0
EER	11.4		13.0	13.0	10.6
Airflow at Cooling (CFM)	613-744-875		613-744-875	788-956-1125	1040-1262-1485
Airflow at Heating (CFM)	613-744-875		613-744-875	788-956-1125	1040-1262-1485
ESP (in. WG)	0.8-0.5-0.3				
Lineset Size (Liquid x Gas)					
Max. Piping Length/Height	165'/100'		245'/100'		
Breaker Size	25 AMP		35 AMP		40 AMP
Cooling Operation Range	23° to 113°F		23° to 113°F		
Heating Operation Range	-13° to 70°F		-13° to 70°F		
Multi-split Connection	Yes		Yes		

**When wind baffle is installed

P-Series models 12K-30K BTU/H are pre-charged for up to a 70' lineset.

TRUYA/TRUZA (36/42) and Hyper-heating models are pre-charged for up to a 100' lineset
Test conditions are based on AHRI 210/240.

P-Series Systems

Correction Factors

Cooling Capacity Correction Factor (x capacity)

Outdoor Unit	Refrigerant piping length (one way)							
	16 ft	33 ft	70 ft	100 ft	130 ft	165 ft	195 ft	225 ft
TRUY (12/18)	1.00	0.985	0.948	0.916	0.886	0.859	—	—
TRUY (24/30)	1.00	0.988	0.964	0.938	0.915	0.893	0.872	0.855
TRUY (36/42)	1.00	0.985	0.948	0.916	0.886	0.859	0.838	0.818
TRUZ (12/18)	1.00	0.985	0.948	0.916	—	—	—	—
TRUZ (24/30)	1.00	0.988	0.964	0.938	0.915	0.893	—	—
TRUZ (36/42)	1.00	0.985	0.948	0.916	0.886	0.859	—	—

Heating Capacity Correction Factors (x capacity)

Outdoor Unit	Refrigerant piping length (one way)					
	16 ft	33 ft	70 ft	100 ft	130 ft	165 ft
TRUZ (12/18)	1.00	0.997	0.991	0.985	—	—
TRUZ (24/30)	1.00	0.997	0.991	0.985	0.979	0.973
TRUZ (36/42)	1.00	0.997	0.991	0.985	0.979	0.973

Hyper-heating

Cooling Capacity Correction Factors (x capacity)

Outdoor Unit	Refrigerant piping length (one way)						Refrigerant piping length (one way)				
	16 ft	33 ft	70 ft	100 ft	130 ft		165 ft	180 ft	195 ft	230 ft	245 ft
TRUZH	1.00	0.985	0.957	0.931	0.908		0.886	0.876	0.865	0.846	0.838

Heating Capacity Correction Factors (x capacity)

Outdoor Unit	Refrigerant piping length (one way)						Refrigerant piping length (one way)				
	16 ft	33 ft	70 ft	100 ft	130 ft		165 ft	180 ft	195 ft	230 ft	245 ft
TRUZH	1.00	0.997	0.991	0.985	0.979		0.973	0.970	0.967	0.961	0.958

P-Series Air Coverage Range

Outlet Air Speed and Coverage Range*

Model	Airflow (CFM)	Air Speed (ft/sec)	Coverage Range (ft)
TPLA0A0121EA70*	530	7.8	13
TPLA0A0181EA70*	600	8.8	14
TPLA0A0241EA70*	810	11.9	19
TPLA0A0301EA70*	880	12.9	21
TPLA0A0361EA70*	1,200	17.6	28
TPLA0A0421EA70*	1,200	17.6	28
TPKA0A0121HA70*	425	20.0	35
TPKA0A0181HA70*	425	20.0	35
TPKA0A0241KA70*	775	19.7	47
TPKA0A0301KA70*	775	19.7	47
TPKA0A0361KA70*	920	22.3	53
TPCA0A0241KA70*	670	10.2	32
TPCA0A0301KA70*	705	10.5	33
TPCA0A0361KA70*	990	11.8	41
TPCA0A0421KA70*	1,025	12.1	42

*Air coverage represents the distance with 0.8 ft/sec air speed when blowing out horizontally from the unit operating at the high fan speed. This is a general guideline; actual coverage depends on size and layout of the room.

Installation

Required Tools for Installation

- Phillips screwdriver
- Pipe cutter with reamer
- Level
- Flaring tool
- Scale
- Nitrogen
- Utility knife or scissors
- Vacuum pump
- Micron gauge
- 3" (75mm) hole saw
- Charge hose for R410A
- 1/4" – 5/8" torque wrench
- Gauge manifold for R410A
- 5/32" (4mm) hexagonal wrench
- Adjustable wrenches

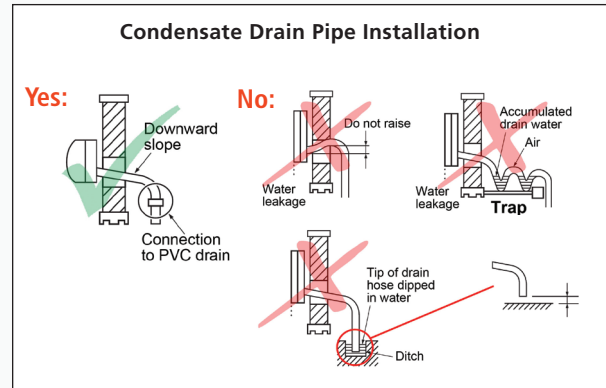

Nv-Series Wall-Mounted System Clearances

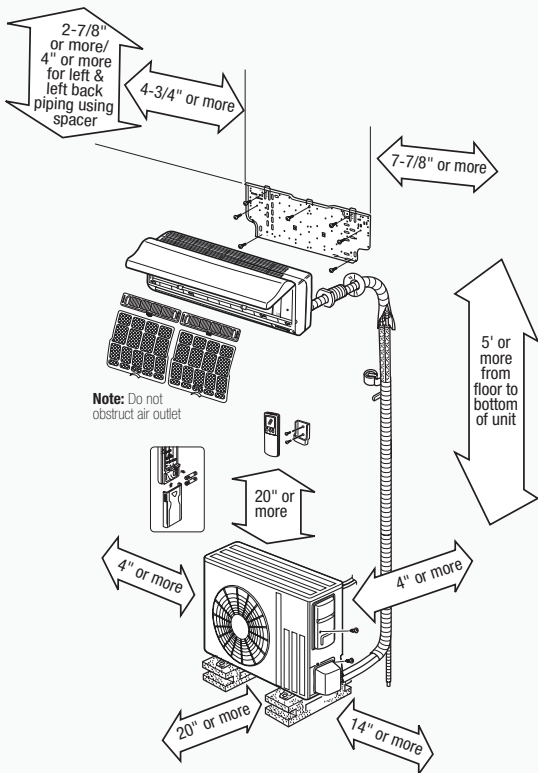

Applies to all Nv-Series models except NTXMMX48A182AA/60A182A and NTXMPH36A142A/42A152A/48A182A.

Check installation instructions for your exact model.

P-Series Outdoor System Clearances

To illustrate the minimum space required around the outdoor unit, the clearances for all P-Series models are shown below. See installation manual for the minimum clearances by model.

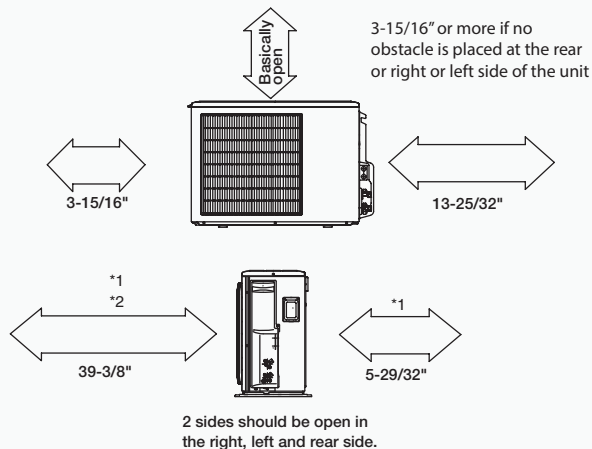

Minimum installation space for outdoor unit

*1. In a place where short cycling can occur, cooling and heating capacity will decrease and power consumption will increase by 10 percent. Air outlet guide (PAC-SJ075G-E for TRUY/TRUZ (12/18), PAC-SG595G-E for TRUY/TRUZ (24/30), or PAC-SH965G-E for TRUZ (36/42) and TRUZH (42) will help improve capacity.

*2. If air is discharged onto a wall, the surface may discolor.

Installation

Installing Refrigerant Piping

For "Twinning" indoor units for better airflow coverage in a large or L-shaped room (For A24/A36, and HA36 outdoor units only).

Refrigerant piping limitations of length and height difference are shown in the figure below.

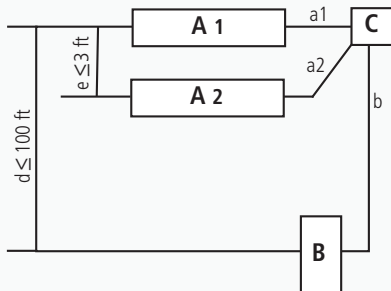

Max. length, TRUY/TRUZ (24/36) systems:

$$a1 + a2 + b \leq 165 \text{ ft}^*$$

Max. length, TRUZH (36) hyper-heating systems:

$$a1 + a2 + b \leq 245 \text{ ft}$$

*With TPLA 12 < 59 ft; TPLA 18 < 98 ft

Key:

A = Indoor unit

B = Outdoor unit

C = Multi distribution pipe (option)

d = Height difference (Indoor unit—Outdoor unit) Max. 100 ft.

e = Height difference (Indoor unit—Indoor unit) Max. 3 ft.

How to Check for Refrigerant Restriction:

1. Verify the refrigerant charge.

- Remove the charge and weigh it back in
- Make sure the system has the refrigerant amount specified for the line length (see Service Manual)

2. Measure for temperature differences across evaporator.

- Set unit operation to cooling and change temperature set point to lowest degree available, or switch system to emergency COOL mode
- Change fan operation to high speed
- Run system for five minutes, and then measure both the entering and leaving air temperatures with a thermometer
- The temperature differential should be around 20° F to 23° F (see Service Manual)
- Remove the charge and weigh it back in
- Make sure the system has the refrigerant amount specified for the line length (see Service Manual)
- Assuming you have verified the charge, a difference of less than 20° F means the system is restricted

A difference of 23° F or more usually means low airflow, often because dirt has built up on the fan blades. Clean the fan and coil and check temperatures again.

Note: When testing the system, remember to change the fan operation to high speed and verify that the unit is charged with the proper amount of refrigerant.

Installation

Wiring: Nv-Series and P-Series

- Indoor unit power is supplied from the outdoor unit
- On Nv-Series and P-Series models, use AWG-14-3 600 VAC-rated or AWG-16-3 600 VAC-rated copper wiring between outdoor unit and indoor unit for high voltage and controls circuits. Refer to Installation Manual as wire size can vary based on model
- Two types of connection patterns, for 1:1 system and for P-Series "twin" operation ("twinning") are shown in the diagrams at right

Key:

- A = Outdoor unit power supply
- B = Wiring circuit breaker or isolating switch
- C = Outdoor unit
- D = Indoor unit/Outdoor unit connecting wiring
- E = Remote control
- F = Indoor unit

Note: All wiring shall comply with NEC and local electrical codes. See unit installation manual for details.

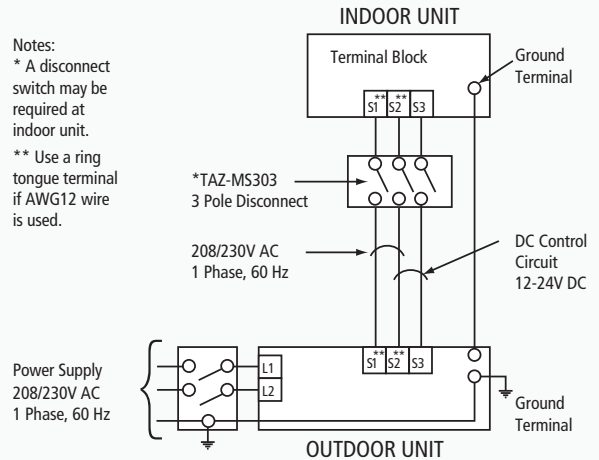

"Twinning" Operation

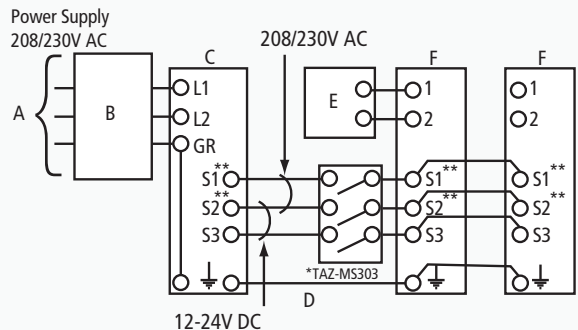

Installation

Test Run

1. Turn power on to outdoor unit.
2. Press the emergency operation button once. The test will run for 30 minutes. If the LED light blinks every 0.5 seconds, verify the indoor/outdoor connecting wire is installed properly. After the test run, the emergency COOL mode (75° F) will operate.
3. To stop operation, press the emergency operation button several times until all LED lights turn off. See operation manual for details.

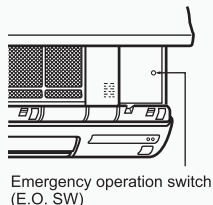

Checking the Remote (Infrared) Signal Reception

1. Press the On/Off button on the remote controller and listen for a beep from the indoor unit.
2. Press the On/Off button again to turn the air conditioner off.
3. After the compressor stops in the outdoor unit, the restart prevention device will activate. This causes the compressor to stop operation for three minutes, which protects the air conditioner.

Caution:

After finishing the test run or checking the remote (infrared) signal reception, use emergency operation button or remote controller to turn unit off before turning power supply off. If this sequence is not followed properly, the unit will start operating automatically when the power supply resumes.

Need Help When You Are On The Job site?

Check out www.mylinkdrive.com
Here you can find: Service Bulletins, FAQs, Guide Specs, Install

Manuals, MSDS Sheets, Operation Manuals, Parts Lists, Service Manuals, Submittals, Accessories and the M&P Troubleshooter.

Auto Restart Function:

Our systems are equipped with an Auto Restart function. If the power shuts off while the system is operating (blackouts, etc.), the system will automatically resume operation at the previous setting after the power resumes. If the end user prefers not to use this function, a service representative can deactivate it. See Operation Manual for details.

Necessary End User Information:

After installation, show the end user how to operate the system remote controller and remote controller holder, remove the air filter, cleaning methods, operating precautions, etc. Recommend that the end user read the Operation Manual.

Continuous Fan Operation:

Explain to the end user that the indoor unit fan is designed to continuously run air across the filters. A sensor also constantly measures room temperature to maintain set point. These functions help improve air quality and reduce wear and tear on the fan motor.

Ducting Considerations for the TPEAD/NTXDKS Horizontal-ducted Indoor Unit

Considering the performance and design of these indoor units, selection and proper duct sizing and installation are necessary for satisfactory operation.

The maximum available static pressure from the NTXDKS indoor units is 0.2 in. W.G. and for the TPEAD indoor units 0.6 in. W.G. Most of the static pressure duct loss comes from allowing the ductwork to sag. Allowing even a 30% sag in the ductwork can increase the static pressure loss up to eight times. Flexible ductwork runs should be kept to less than 15 ft.

Airflow (CFM)	50	100	150	200	250
Grille Size (In. x In.)	6x6	6x6	8x6	10x6, 8x8	12x6, 10x8

Inches of Static Pressure Loss per 100 ft. of hard duct				
	4"ø	6"ø	8"ø	10"ø
50 CFM	0.15	0.02	—	—
100 CFM	0.6	0.08	0.02	—
150 CFM	—	0.2	0.04	—
200 CFM	—	0.3	0.08	0.02
250 CFM	—	0.45	0.11	0.04
500 CFM	—	—	0.4	0.15

Appropriate sizing methods should be followed, these considerations are only guidelines



Effective APRIL, 2015

Nv-Series Warranty:

- 12-year parts and 12-year compressor warranty is available to the original owner provided the system is:
 - Installed by a Diamond Contractor in a residential single-family owner-occupied home
 - Registered by the installing contractor through www.RegisterMEHVAC.com website within 90 days of installation
- 10-year parts and 10-year compressor warranty is available to the original owner provided the system is:
 - Installed by a licensed contractor in a residential single-family owner-occupied home
 - Registered through the www.RegisterMEHVAC.com website, within 90 days of installation
- 5-year parts and 7-year compressor warranty standard to original owner*

* NTXWMTNTXSMT09/12/15/18/24A112A* Product Warranty: Five-year parts and seven-year compressor warranty comes standard to the original owner. 10-year parts and compressor warranty is available to the original owner if the system is installed in a residential single-family home and registered within 90 days from installation.

*NTXWEL/NTXSEL Product Warranty: Five-year parts and five-year compressor warranty. There will be no extension on the warranty if a Diamond Contractor installs the product.

Limited Warranty Information

P-Series Warranty:

- 12-year parts and 12-year compressor warranty is available to the original owner provided the system is:
 - Installed by a Ductless Pro in a residential single-family owner-occupied home
 - Registered through the Extranet within 90 days of installation
- 10-year parts and 10-year compressor warranty is available to the original owner provided the system is:
 - Installed by a licensed contractor in a residential single-family or commercial application
 - Registered through the metahvac.com site within 90 days of installation
- 5-year parts and 7-year compressor warranty standard to original owner

The full text of this Limited Warranty is available on www.metahvac.com. The Limited Warranty gives the owner specific legal rights and the owner may also have other rights that vary from state to state. Some states do not allow limitations on warranties or exclusions or limitation of damages, so the specified limitations or exclusions may not apply. This Limited Warranty is valid only in the continental United States, Alaska and Hawaii and is not transferable. For more information, contact:
Customer Care: 800-433-4822
www.registtermehvac.com

Synchrony Financing

Getting Started is as Easy as 1,2,3!

Go to toolbox and take selling strategies:

- www.toolbox.mysynchrony.com/diamond
- Download the rate menu for available plans
- Follow the Commitments Guide to gain a clear focus on developing a well-trained team
- Download Synchrony Contacts flyer for training and more information

Think Outside the Toolbox!

Announcing the ***Selling In The Home*** Webinar Training Series

What if you worked as hard on your business as you work in your business? You use your knowledge and skill to choose the right tool for the job. So why not put that same sharp focus to work growing your business? Synchrony Financial invites you to Think Outside the Toolbox—a website dedicated to helping you grow your business by closing more projects.

As part of our commitment to bringing you useful tools and fresh ideas, we've leveraged insights from our largest partners in the Home Improvement, HVAC, Spa and Landscape industries, and combined them with Synchrony Financial's expertise. In addition, Synchrony Financial teamed up with Dave Yoho Associates to develop the materials in the Selling In The Home webinar Series. We invite you to take advantage of all this knowledge and experience today.



For more information visit
Trane.com/residential

800-433-4822
Fax: 800-658-1458

© 2021 Mitsubishi Electric Trane HVAC US LLC. All rights reserved.

Mitsubishi Electric, Lossnay, and the three-diamond logo are trademarks of Mitsubishi Electric Corporation. CITY MULTI, kumo cloud, kumo station and H2i are registered trademarks of Mitsubishi Electric US, Inc. Trane and American Standard are registered trademarks of Trane Technologies plc. All other product names mentioned herein are trademarks or registered trademarks of their respective owners. ENERGY STAR and the ENERGY STAR mark are registered trademarks owned by the United States Environmental Protection Agency.

Use of the AHRI Certified® mark indicates a manufacturer's participation in the certification program. For verification of certification for individual products, go to www.ahrirectory.org.

Specifications shown in this brochure are subject to change without notice. See complete warranty for terms, conditions and limitations. A copy is available from Mitsubishi Electric Trane HVAC US LLC.

Printed in the USA

TR_RS_1065_02-21

