

1509876HC1501



LOSSNAY HEAT RECOVERY VENTILATOR (RESIDENTIAL USE)

MODEL:

VL-220CZGV-E

Installation Manual

LOSSNAY HEAT RECOVERY VENTILATOR (RESIDENTIAL USE)

Model

VL-220CZGV-E

Installation Manual

For dealer/contractor

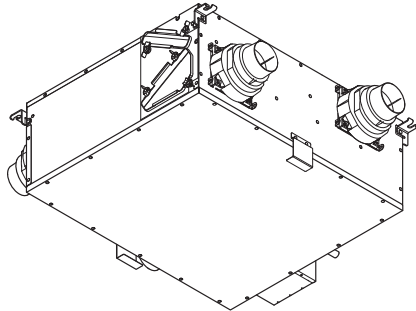

Contents

1. Safety Precautions	1 - 2
2. Outside Dimensions	3
3. Standard Installation Examples	4
4. Installation Procedure	5 - 7
5. Electrical Work	8 - 10
6. Initial Settings	11 - 20
7. Post-installation Checks	21
8. Trial Operation	22 - 23

- This product is for residential use.
- This product must be correctly installed to ensure that its performance and functions are properly demonstrated and to ensure its safe use and operation. Before installation, read this installation manual thoroughly. Before using exclusive system components, read the installation manual for the system components thoroughly.
- For installation parts, be sure to use accessories and designated parts. Use of non-designated parts may be a cause of malfunction.
- Installation must be performed by dealers and electrical contractors. Incorrect installation or installation by the customer may be a cause of equipment malfunction or an accident.
- Electrical work must be performed by a properly qualified electrician of the dealer or electrical contractor.
- Please note a clear working space is required around the installed product to allow the cover to be removed and provide sufficient access for maintenance such as filter change.
- The product must be installed indoors.





The separate "Instruction Manual" is for the customer. When you have finished installation, be sure to hand over the CD-ROM containing this Installation Manual and the Instruction Manual to the customer.

1. Safety Precautions

The following symbols denote the type and degree of danger resulting from incorrect handling.

WARNING		Incorrect handling of the product may result in serious injury or death.	
 Prohibited	Do not install the product in hot places, in the direct sunlight and in smoky places. Failure to heed this warning may result in fire.	 Follow instructions	Use 220 to 240 V AC power. Do not apply a different voltage to this product. Failure to heed this warning may result in fire, electric shock or damage to the circuit boards. For the outside air intake vent, choose a position where combustion gas or other similar exhaust air is not sucked in and the vent is not buried by snow. Inability to bring in fresh air may result in lack of oxygen in the room. Select a place which is strong enough to support the product, and install the product securely. Injury could result if parts fall. Electrical work must be carried out safely and reliably by a professional electrical contractor (properly qualified electrician) in accordance with internal wiring provisions and electrical-equipment technical standards. Poor connection and faulty electrical work could result in electric shock or fire. Use the designated electric wires, and connect them securely so that they do not come loose. Defective connections may result in fire. When metal ducts penetrate through metal-sheeted wooden buildings or structures, install the product so that there is no electrical contact between the metal ducts and the metal sheeting. Electric leakage may cause ignition. Be sure to cover with the terminal block cover after electrical work. Failure to heed this warning may cause dust, humidity, etc. to enter, resulting in electric leakage or fire. Secure duct piping with commercially available fixing bands, aluminum tape, etc. to prevent piping from coming loose. Install outdoor piping from the product so that it is tilted at a downward pitch of at least 1/30 towards the outside. Failure to heed this warning may cause rain penetration, resulting in electric shock/fire or water damage to household property. If the product will not be operated for a long period of time after installation, be sure to turn off the circuit breaker. It could cause electrical shock by deteriorated insulation or fire by the electric leakage. For installation work parts, be sure to use only accessories and designated parts. Use of non-designated parts may result in equipment damage or accidents.
 No water exposure	Refrain from immersing in water or splashing the product with water. Failure to heed this warning could result in short circuit or electric shock.		
 No disassembly	Do not modify or disassemble the product beyond that is necessary. Failure to heed this warning may result in fire, electric shock or injury.		
 Cannot be installed in a bathroom	Do not install the Lossnay unit or the remote controller in a bathroom or other humid location. Failure to heed this warning may result in electric shock or electric leakage.		
 Check grounding	Be sure to install the ground wire. Device failure and electric leakage may cause electric shock.		

1. Safety Precautions (continued)

	<h2 style="margin: 0;">CAUTION</h2>	<p>Incorrect handling of the product may result in injury or damage to property or household effects.</p>	
 <p style="text-align: center;">Prohibited</p>	<p>The product is exclusively for horizontal installation. Do not install the product on walls. Injury could result if parts fall.</p> <p>Do not install the product at regions or locations that exceed the following operating conditions. If these operating conditions are exceeded, dew condensation water might drip.</p> <p>Outdoor air temperature: -15 to 40°C Area around the product and ambient temperature and humidity: 0 to 40°C 80%RH or less and at absolute humidity or less where the dew point temperature of 12°C (20°C 60%RH or equivalent) is reached under the above minimum outdoor air temperature conditions</p> <p>When installing the product, do not drop or throw the product, or subject the product to impact. Damage to structures inside the product may result in air or water leakage.</p>	<p><Duct piping></p> <p>Be sure to insulate ducts down to the base of the duct connecting flanges. Exposed parts get cold in winter, which may result in dew condensation forming due to moisture in the room.</p> <p>Do not allow duct piping to contact the inspection opening, ceiling hanging bolts, beams, pillars, and other duct piping. Failure to heed this warning may result in abnormal noise and vibration.</p> <p>Use an outdoor hood, that makes it less likely for rain water, snow or small animals (e.g. bats) from entering the ends of the supply air and exhaust air ducts. To prevent the entry of small animals, install an outdoor hood having louvers 2 cm or less wide.</p>	<p><Drain piping></p> <p>Be sure to connect drain piping by the following procedure to prevent freezing and dew condensation forming on the surface of the piping</p> <ul style="list-style-type: none"> - Connect the drain piping on the indoor side of the insulation layer - Insulate the drain piping up to the end of the piping - Do not let the end of drain piping be immersed in the rain gutter, etc. <p>(At times of heavy snow, the rain gutter freezes and drain water is not discharged, which results in water leaking from the Lossnay unit.)</p>
 <p style="text-align: center;">Follow instructions</p>	<p><Lossnay unit></p> <p>Install the product and the duct piping on the indoor side of the insulation layer/airtight layer. The temperature of the air after heat is collected on the indoor side of the insulation layer may drop, or drain or dew condensation might result in the ceiling getting wet.</p> <p>Install the product (on the ceiling) in the direction of the duct connecting flange so that it is horizontal (within ± 1°). Water leakage may result in water damage to the ceiling.</p> <p>Be sure to install the product (on the ceiling) tilted at a downward pitch of 0 to 1° towards the side where the drain hose is installed. Water leakage from reverse pitch may result in water damage to the ceiling.</p> <p>Wear gloves when installing. Failure to heed this warning may result in injury.</p> <p>Securely install parts so that they are not twisted or deformed. Injury could result if parts fall.</p>	 <p style="text-align: center;">Follow instructions</p>	<p>This appliance is not intended for use by persons (including children) with reduced physical sensory or mental capabilities, or lack of experience and knowledge, unless they have been given supervision or instruction concerning use of the appliance by a person responsible for their safety. Children should be supervised to ensure that they do not play with the appliance. (This appliance can be used by children aged from 8 years and above and persons with reduced physical, sensory or mental capabilities or lack of experience and knowledge if they have been given supervision or instruction concerning use of the appliance in a safe way and understand the hazards involved. Children shall not play with the appliance. Cleaning and user maintenance shall not be made by children without supervision.)</p>

Note

- Do not install the product at locations where toxic gas or gas containing corrosive components such as acids, alkaline, organic solvents, or paints is generated. (Failure to heed this warning may result in malfunction.)
- For ceiling material, use material that is less likely to resonate.
- Do not install the product near bedrooms. (Failure to heed this warning may cause complaints about noise.)
- For living rooms (e.g. bed rooms) where it is anticipated that building ambient noise will be below 30 dB(A), use commercially available ducts that have sound deadening qualities on the supply air side. (Sound from the product resonates inside the ducts and may result in abnormal noise being emitted from the air vent.)
- Install supply air and exhaust air grills at locations where they are less likely to reverberate. (Failure to heed this warning may cause complaints about noise.)
- In cold regions or regions with strong winds, wind outside sometimes gets inside when operation of the product is stopped. So, we recommend providing a motorized shutter midway along the supply air and exhaust air ducts.
- Install the product so that discharged gas or exhaust air from burning appliances and equipment does not flow back inside the product.
- At regions where salt damage is a concern, use an exclusive outdoor hood.
- At regions where salt damage is a concern, parts may have to be replaced sooner because of the deterioration of materials that are used.
- At the outdoor hood installation position, allow at least 3x the diameter of the duct through holes between the outdoor hood and the ducts so that exhaust air is not mixed in with supply air. (Preferably a distance of 450 mm or more should be ensured between the outdoor hood and the ducts.)
- Do not connect duct pipes in the ways shown below. (Failure to heed this warning may cause the air flow to decrease or result in abnormal noise.)

- Extremely sharp bends



- Many bends



- Bending right next to the duct connection flange



- Extreme narrowing of the duct diameter

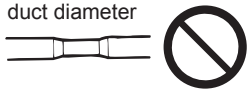

- Provide an inspection opening at least 745 x 530 mm in size at the designated position.
- Use an exhaust air filter that has a net or a non-woven fabric type filter.
- Be sure to connect the drain piping by the following procedure to prevent the noise of the drain discharge water from occurring
 - Make the opening at the end of the drain piping face down so that water drains well
 - Ensure that the drain piping is at least 5 m long
 - Ensure that the number of bends in the drain piping and drain piping downward pitch are as indicated in the following table

Piping length	Number of bends in pipe	Piping downward pitch
5 m or more, less than 6 m	2 locations or more	3° or more
6 m or more	1 location or more	1° or more

Drain water that occurs inside the ventilation unit builds up due to the intake air pressure of the exhaust fan. This sometimes causes a knocking noise and the sound of water discharge.

2. Outside Dimensions





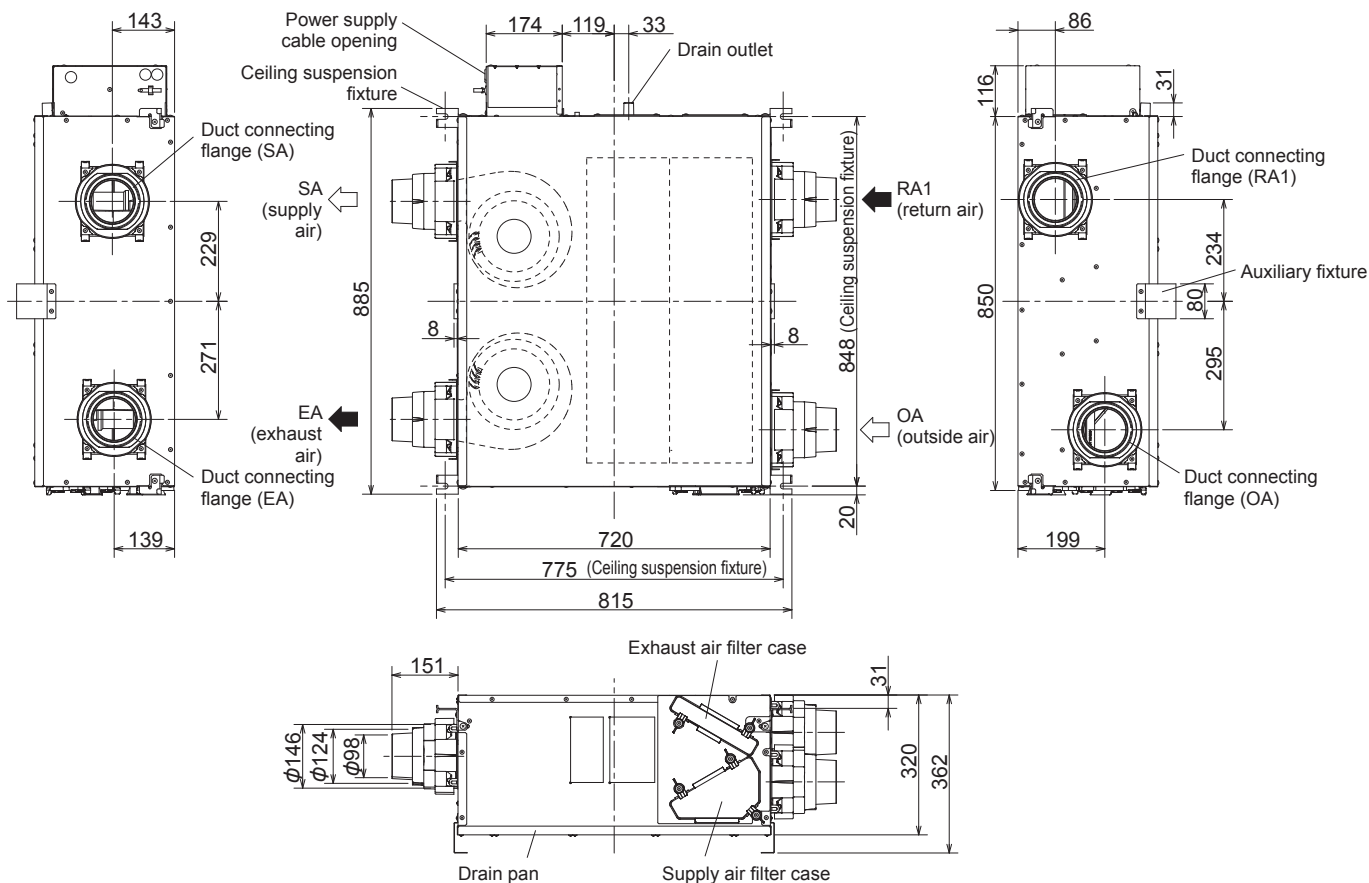



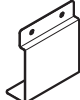

Lossnay unit

Top view



Unit (mm)

Accessories

Duct connecting flange: 4 pcs 	Hose band: 2 pcs 	Drain hose: 1 pcs 	Auxiliary fixture: 2 pcs 	Ceiling suspension fixture L: 2 pcs R: 2 pcs  
Duct connecting flange mounting screw (4-25 mm): 16 pcs (4 pcs x 4 locations) 	Ceiling suspension fixture mounting screw (thin) (5-10 mm) : 4 pcs 	Ceiling suspension fixture mounting screw (fat) (6-12 mm) : 4 pcs 	Auxiliary fixture mounting screw (4-8 mm) : 4 pcs 	Washer: 8 pcs  Rubber cushions: 8 pcs 

3. Standard Installation Examples

Piping example

- When connecting the RA (return air) to a bathroom, be sure to branch into two lines and return air from two locations, the bathroom and living room.

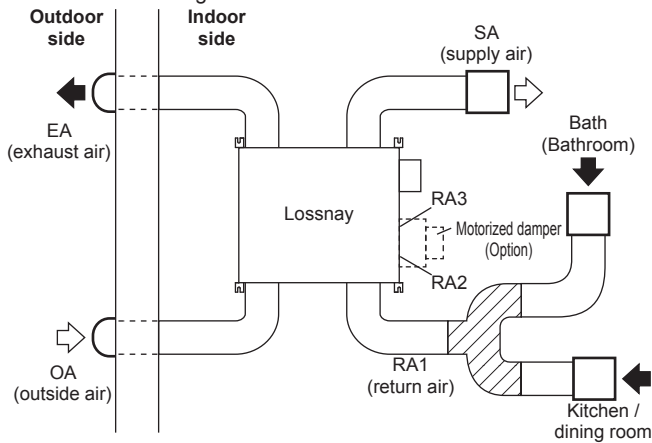

Name of Connection Point		Connection Location
RA (return air)	RA1	For intake from living room, toilet, wash basin, bathroom, etc.
	RA2*	For optional motorized damper (P-133DUE-E)
	RA3*	Exclusive for intake from living room, toilet, wash basin, bathroom, etc.
EA (exhaust air)		For exhaust air of inside air
OA (outside air)		For intake of outside air
SA (supply air)		For air supply opening to living room

* When RA2 and RA3 are used, use grills equipped with filter.

Working space (required space around Lossnay unit)

OA-RA side

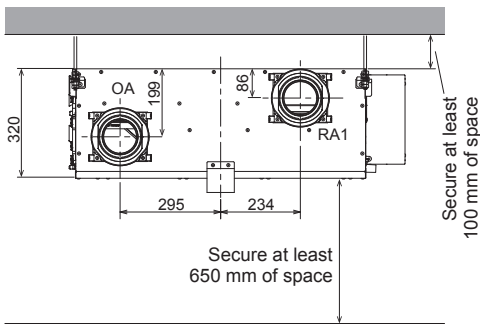

Top side

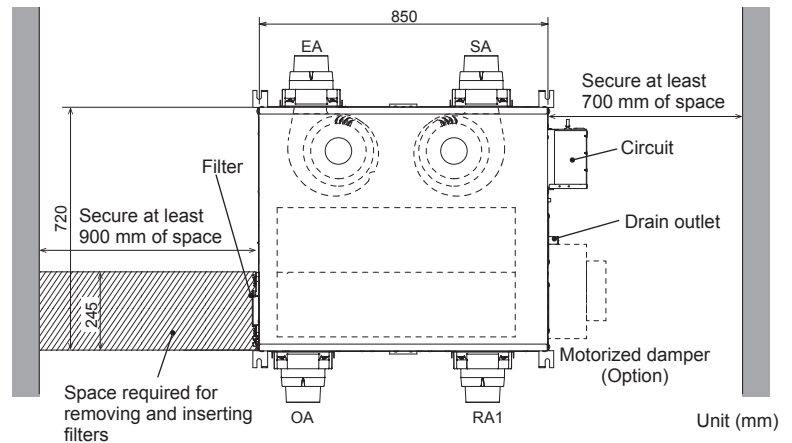

Connecting drain piping to the drain outlet

If drain piping is not connected, drain water that builds up inside the Lossnay unit cannot be discharged, which may result in water leakage. Please understand that expenses incurred in recovery work shall be borne by the contractor.

Provide an inspection opening at least 745 x 530 mm in size

Locate the inspection opening at a position that allows the Lossnay unit to be carried to its installation site to perform installation work and that allows the worker to go to the installation site to perform maintenance.

If the inspection opening is too small, additional work may unavoidably arise, such as widening of the inspection opening because Electrical work or other work cannot be carried out. Please understand that expenses incurred in additional work shall be borne by the contractor.

Do not install as follows:

Do not install Lossnay unit vertically or on an incline.

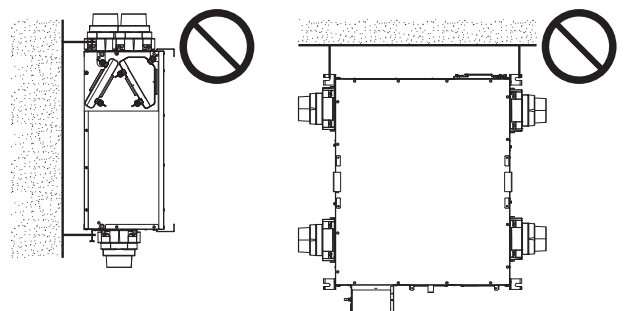

Do not install the Lossnay unit upside down

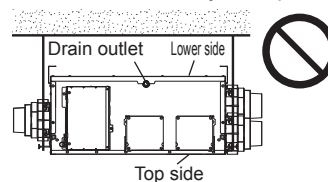

4. Installation Procedure

Installing the Lossnay unit

1. Installing the duct connecting flange

Install the four duct connecting flanges (supplied) to the Lossnay unit using the duct connecting flange mounting screws (4-25 mm) (supplied). (4 pcs x 4 locations)

When installing the duct connecting flange (RA1, EA), fill in any gaps between the duct connecting flange openings and the openings (RA1, EA) of the duct connecting flange with caulking compound. (entire circumference of opening) (commercially available)

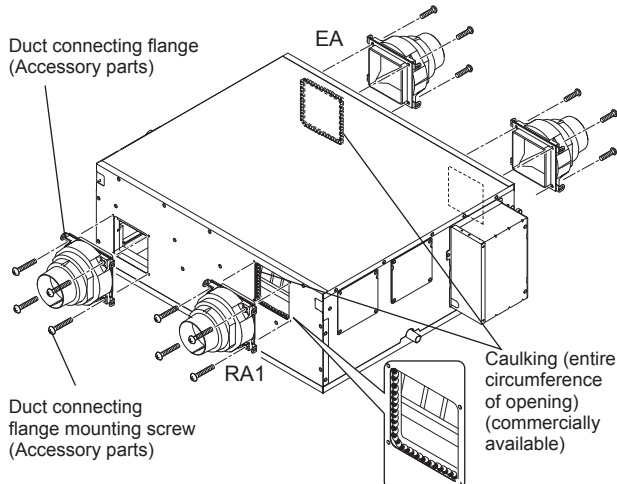

Note:

- Mounting screws must be tightened at a torque of 1.0 to 1.5 N·m.
- Install the product on packaging material or the like to prevent the floor from being scratched or damaged.

2. Installing the ceiling suspension fixture

Install the ceiling suspension fixtures L and R (2 of each) (supplied) at the positions shown in the figure below with the Ceiling suspension fixture mounting screw (thin) (5-10 mm) and Ceiling suspension fixture mounting screw (fat) (6-12 mm) (both supplied).

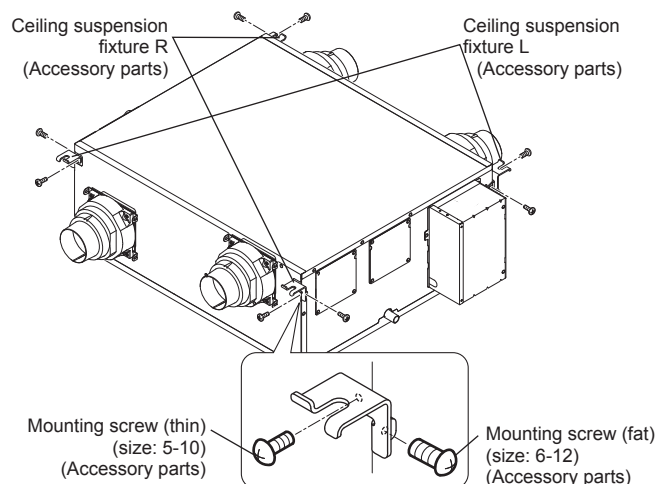

3. Installing the Lossnay unit

- (1) Install commercially available hanging bolts (M8) while referring to the ceiling suspension fixture mounting positions in the outside dimension drawings.
- (2) Hook the ceiling suspension fixtures onto the commercially available hanging bolts, and secure the brackets in place using rubber cushions and washers (supplied) and commercially available nuts. When securing the ceiling suspension fixtures in place, install the Lossnay unit tilted as shown in <Tilt of Lossnay unit at installation> below.

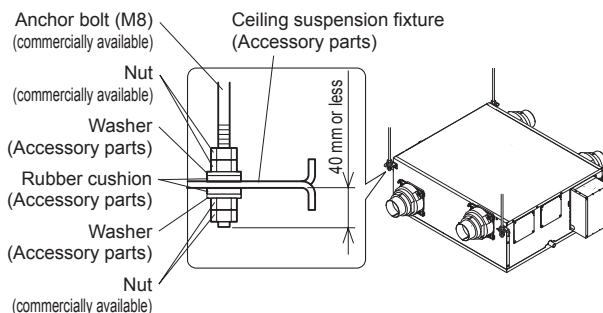

<Tilt of Lossnay unit at installation>

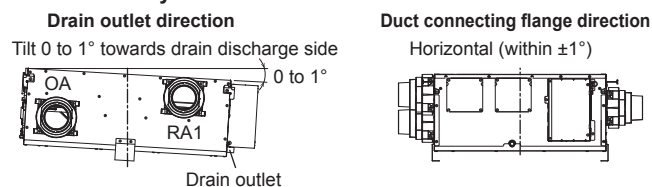

⚠ CAUTION

Install the product and the duct piping on the indoor side of the insulation layer/airtight layer.

The temperature of the air after heat is collected on the indoor side of the insulation layer may drop and cause dew condensation, which, in turn, might result in household property getting wet.

Install the Lossnay unit so that it is horizontal with respect to the direction of the Duct connecting flange (within ± 1°).

Be sure to install the Lossnay unit tilted at a downward pitch of 0 to 1° towards the side where the drain hose is installed. (Reverse pitch results in water leakage.)

4. Installing the auxiliary fixture

Install the two auxiliary fixtures (supplied) with the auxiliary fixture mounting screws (4-8 mm). (2 pcs x 2 locations)
(Screw tightening torque: 1.0 to 1.5 N·m)

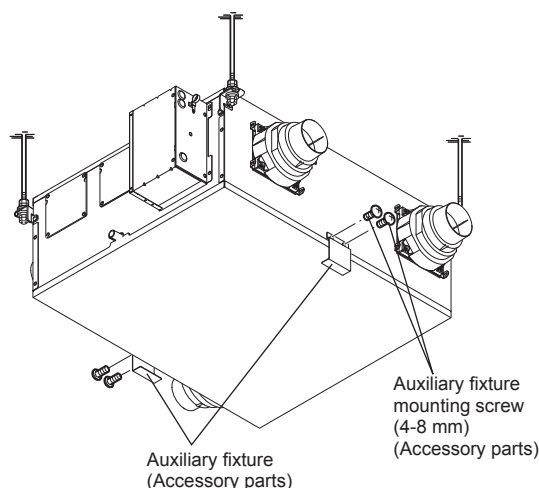

4. Installation Procedure (continued)

Duct piping

1. Duct piping

(1) Choose the connection duct

Use the ducts shown in the table below.

	Piping duct locations			
	OA (outside air)	EA (exhaust air)	SA (supply air)	RA1 (return air)
Nominal dia.	φ 100	φ 100	φ 100	φ 100
	φ 125	φ 125	φ 125	φ 125
	φ 150	φ 150	φ 150	φ 150

Note:

- When discharging air from a bathroom, use ducts made of a material that does not allow water to pass to RA (return air).
- When using PCV piping or metal ducts for SA side ducts, be sure to connect ducts having sound deadening qualities before the air diffusion grill.
- Although the duct connecting flange of the Lossnay unit can accommodate 100, 125 and 150 mm dia. ducts, the connection position differs. Refer to the figure below and work.

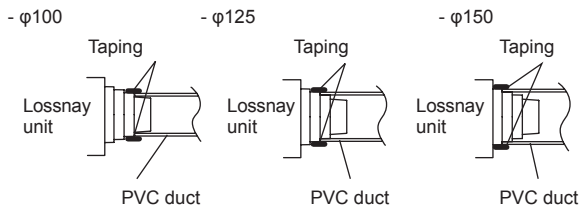

(2) Install the ducts to the Lossnay unit

1) Securely insert ducts into duct connecting flanges, wrap the ports with commercially available aluminum tape to prevent air leakage, and then securely fasten the ducts with commercially available bands.

* Aluminum tape and duct supporting members are prepared by the contractor.

2) Hang the ducts from the ceiling in such a way that force is not applied to the Lossnay unit.

3) Calk the duct connecting flanges that discharge air from the bathroom with calking compound. When using calking compound, take care to prevent it from oozing from the ducts. (Otherwise, it could cause aluminum tape to peel off.)

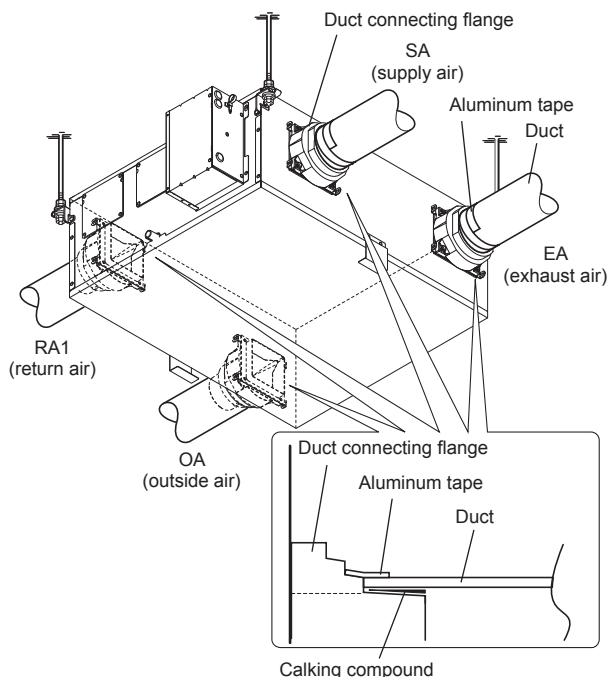

Note:

- Make sure that there are no metal chips or other foreign matter (e.g. paper or vinyl) inside the ducts or the Lossnay unit before connecting the ducts.

2. Insulating

Insulate the ducts and duct connecting flanges with (glass wool 25 mm or equivalent) to prevent dew condensation.

RA ducts also must be insulated when the Lossnay unit is anticipated to be stopped for a long time (i.e. not operated for 24 hours).

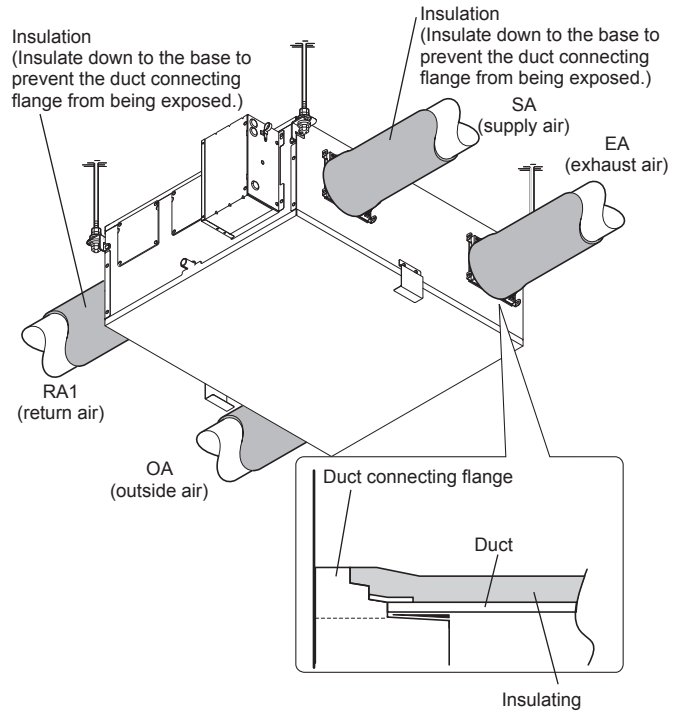

CAUTION

Install the outdoor side duct with a downside pitch of 1/30 or more towards the outside to prevent rain water from entering.

Be sure to insulate the supply air and exhaust air ducts facing the Lossnay unit from the outside and the supply air duct facing the room down to their bases.

Install the Lossnay unit and the duct piping on the indoor side of the insulation layer/airtight layer. (Otherwise, dew condensation could result.)

4. Installation Procedure (continued)

Connecting drain pipe

Connecting the drain hose

- (1) Firmly insert the drain hose (supplied) down to the base of the drain outlet. Securely tighten the hose band (supplied) using a flathead screwdriver to secure in place. (Poor tightening may result in water leakage.)
- (2) Connect the other end of the drain hose to a commercially available drain pipe (building side drain pipe: VP16 (outside diameter: $\phi 22$ mm) hard PVC pipe). Securely tighten the hose band (supplied) using a screwdriver to secure in place.

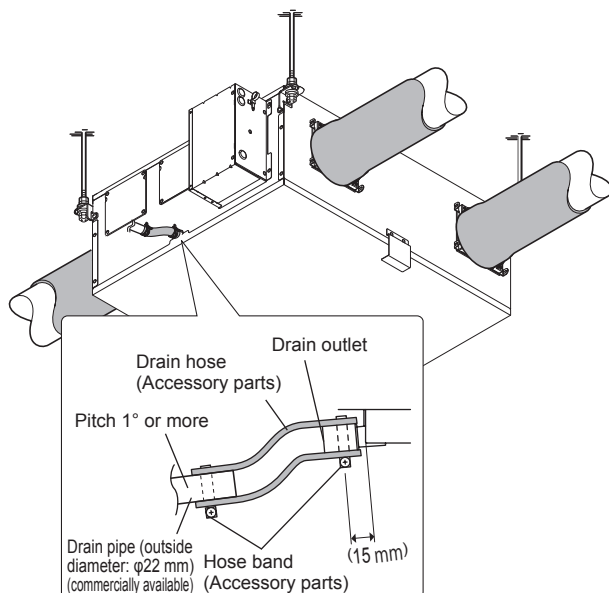

Note:

- Connect the drain hose so that it is lower than the Lossnay unit. (If the drain hose is higher than the Lossnay unit, water leakage will occur.)
- Do not apply adhesive to the drain hose and drain outlet. (Otherwise, maintenance can no longer be performed.)
- Be sure to connect the drain piping by the following procedure to prevent the noise of the drain discharge water from occurring.
 - Make the opening at the end of the drain piping face down so that water drains well.
 - Ensure that the drain piping is at least 5 m long.
 - Ensure that the number of bends in the drain piping and drain piping downward pitch are as indicated in the following table.

Piping length	Number of bends in pipe	Piping downward pitch
5 m or more, less than 6 m	2 locations or more	3° or more
6 m or more	1 location or more	1° or more

In winter, drain water that occurs inside the ventilation unit builds up due to the intake air pressure of the exhaust fan. This sometimes causes a knocking noise and the sound of water discharge.

⚠ CAUTION

Be sure to connect drain piping by the following procedure to prevent freezing and dew condensation forming on the surface of the piping.

- Connect the drain piping on the indoor side of the insulation layer
- Insulate the drain piping up to the end of the piping
- Do not let the end of drain piping be immersed in the rain gutter, etc. (At times of heavy snow, the rain gutter freezes and drain water is not discharged, which results in water leaking from the Lossnay unit.)

5. Electrical Work

⚠ WARNING

Electrical work must be carried out safely and reliably by a professional electrical contractor (properly qualified electrician) in accordance with internal wiring provisions and electrical-equipment technical standards.

Poor connection and faulty electrical work could result in electric shock or fire.

Use 220 to 240 V AC power.

Failure to heed this warning may result in fire, electric shock or damage to the circuit boards.

Use the designated electric wires, and connect them securely so that they do not come loose.

Defective connections may result in fire.

Be sure to install the ground wire.

Device failure and electric leakage may cause electric shock.

Note:

- Limit the total wiring length between the Lossnay unit and the remote controller to 50 m.
Micro current flowing between wirings may result in malfunction.
- Always use double insulated PVC cable for the transmission cables.
- All supply circuits must be disconnected before obtaining access to the terminal devices.

Please understand that expenses incurred in recovery work to deal with the above malfunction shall be borne by the contractor.

Names of components in control box

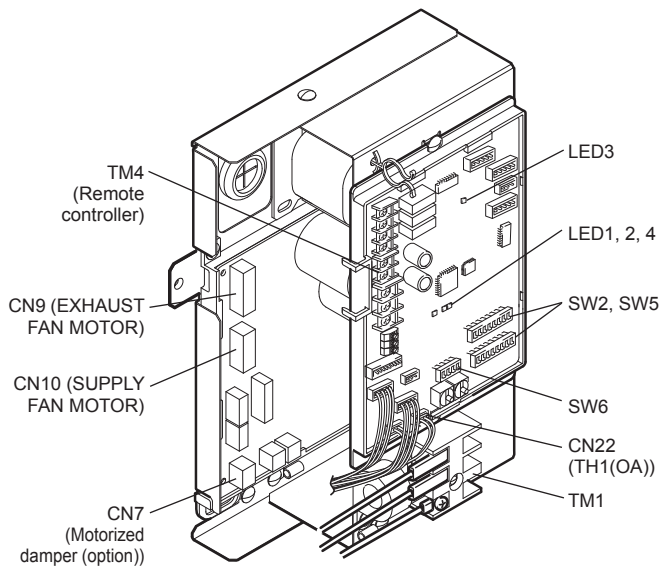

5. Electrical Work (continued)

Wire connection diagram

- * TM1, TM4 shown in dotted lines are field work.
- * CN7 (DAMPER) is optional.
- * Be sure to connect the ground wire.
- * A power supply isolator must be installed.
- * Always use an isolator for the main switch power connection.
- * Select proper circuit breaker according to the electrical current information in the chart below.

Inrush current after power supply ON [A]	10 ms	6.1
	100 ms	3.6

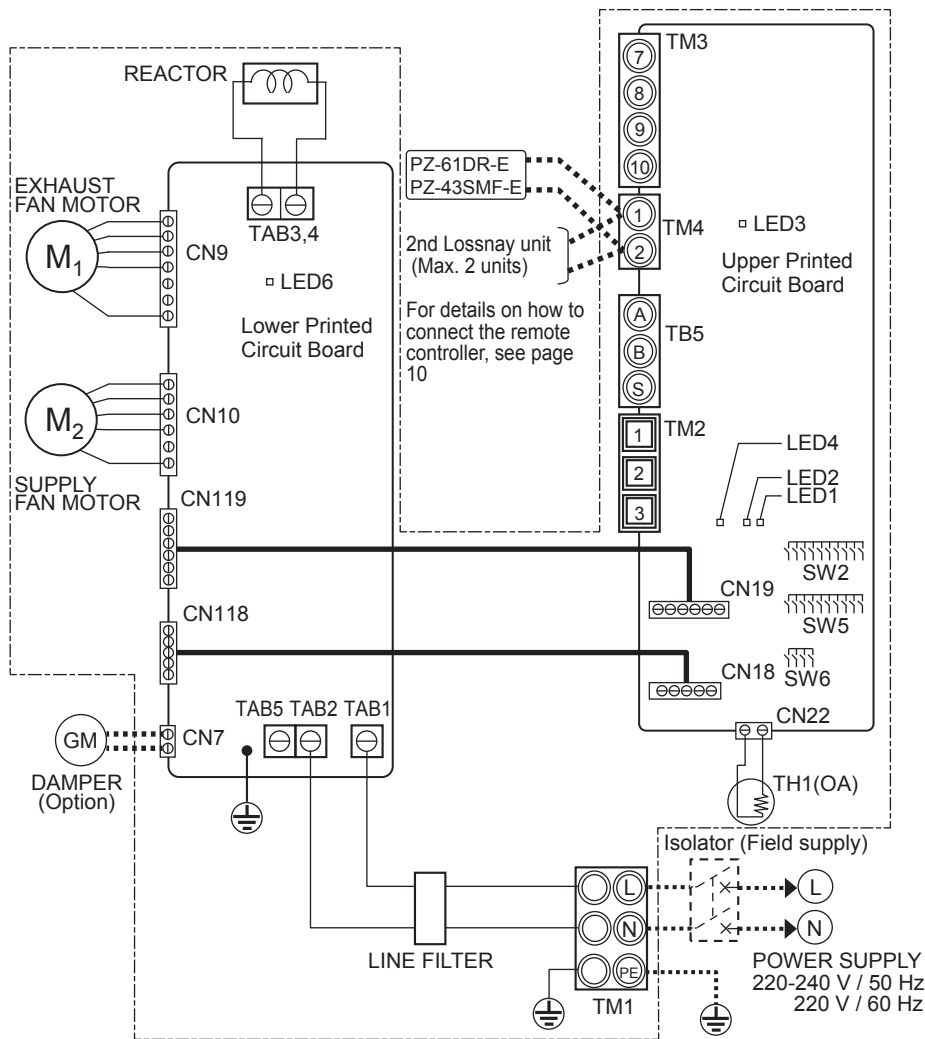

Definition of symbols		
M1: Motor for exhaust fan	TB5: Not in use	CN19: Connector
M2: Motor for supply fan	TAB1, TAB2, (TAB5): Connector (Power supply)	CN119: Connector
GM: Motor for By-pass damper	TAB3, TAB4: Connector (Reactor)	CN22: Connector (Thermistor OA)
TH1: Thermistor for outside air	CN7: Connector (Motor for By-pass damper)(Option)	LED1 to LED3: Inspection indicator lamp
SW2,5: Switch (Function selection)	CN9: Connector (Fan motor)	LED4, LED6: Power supply indicator lamp
SW6: Switch (Motorized damper (option) selector)	CN10: Connector (Fan motor)	SYMBOL \odot \square : Terminal block
TM1: Terminal block (Power supply)	CN18: Connector	\oplus : Connector on PCB
TM2: Not in use	CN118: Connector	
TM3: Not in use		
TM4: Terminal block (Transmission cable)		

5. Electrical Work (continued)

Connecting the wires

(1) Remove the terminal block cover. (3 screws)

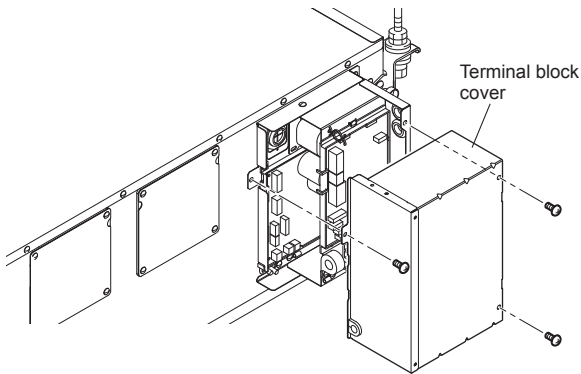

(2) Connecting the power supply cable and transmission cable. Pass the Power supply cable through the bush* and connect to the TM1 terminal block using the round terminals. Connect the ground wire to the ground terminal and secure tightening the bush. (* Use an item that can firmly secure the cable such as a PG connector.)

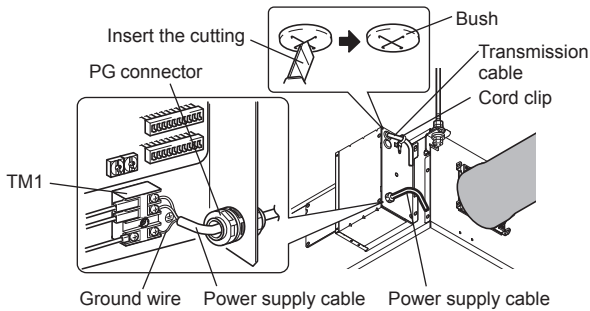

Note:

- Always separate the power supply cable and transmission cable by 5 cm or more to prevent malfunctioning of the unit.
- If the length of the stripped Power supply cable is too long, the conductors may touch and short out.

Power supply cable size : 1.5 mm² (ø9) or more.

- 1) Tighten the ground wire and transmission cables to the terminal block.
- 2) Secure the transmission cables using the cord clips.

Upon completion of the wiring connections, replace the control box cover.

(3) Connect the remote controller. (PZ-61DR-E, PZ-43SMF-E) Securely connect the transmission cable from the remote controller to 1 and 2 of the input terminal block (TM4). (No polarity)

Wire type: two-core sheathed cable
Wire diameter: 0.3 mm²

- Keep the overall length of the transmission cable between Lossnay and the remote controller within 50 m.

Note:

- Do not tighten screws of terminal block with a torque larger than 0.5 N · m. It could damage the PCB.
- Take care not to connect the power supply cable.
- Single wires such as PVC wires cannot be connected.
- Only one remote controller can be connected to the Lossnay unit. Two or more remote controllers cannot be connected.
- PZ-61DR-E and PZ-43SMF-E cannot be used together.

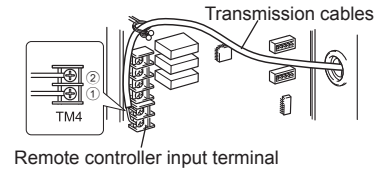
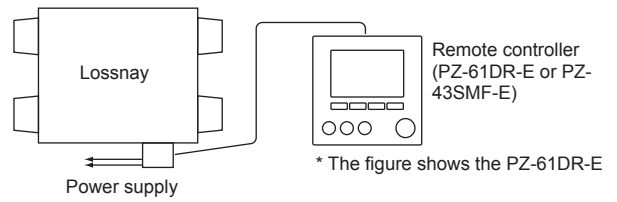

(4) When operating two Lossnay units by one remote controller Connect from Lossnay Unit 1 to Lossnay Unit 2 using a transmission cable.

Wire type: two-core sheathed cable
Wire diameter: 0.3 mm²

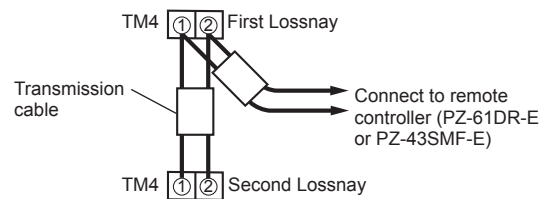
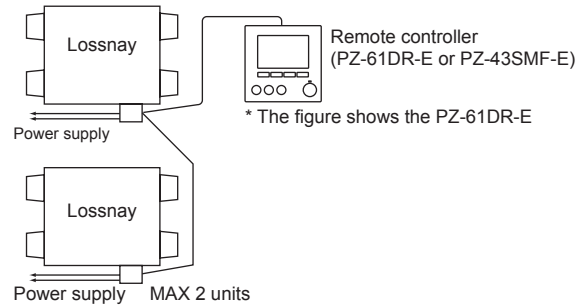

Note:

- Do not tighten screws of terminal block with a torque larger than 0.5 N · m. It could damage the PCB.
- Single wires such as PVC wires cannot be connected.
- Connect the power supply cable to each Lossnay unit.
- Up to two Lossnay units can be connected.
- When using optional dampers (P-133DUE-E) and operating two Lossnay units with a remote controller, be sure to mount the damper on each Lossnay unit. Otherwise, the Lossnay units cannot operate properly.
- PZ-61DR-E and PZ-43SMF-E cannot be used together.

6. Initial Settings

Settings when the motorized damper (option) is installed

When the optional motorized damper (P-133DUE-E) is installed, change the SW6-1 setting to OFF.

Motorized damper selection	SW6-1	SW6-2	SW6-3	SW6-4	Remarks
Without the damper	ON	ON	ON	ON	Factory default
With the damper	OFF	ON	ON	ON	

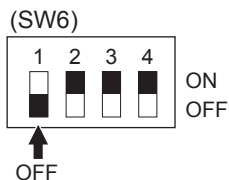

Changing the function selection switches (SW-2 and 5)

Set the selection switches (SW-2 and 5) to perform the appropriate function.

* All function except "Trial operation" and "Main unit setting" can be set also from the remote controller (PZ-61DR-E). If the function is switched later using the remote controller, it operates according to the setting on the remote controller.

(SW2)

	OFF	ON	
1	<input type="checkbox"/>	<input checked="" type="checkbox"/>	Trial operation
2	<input type="checkbox"/>	<input type="checkbox"/>	Not in use
3	<input type="checkbox"/>	<input type="checkbox"/>	Not in use
4	<input type="checkbox"/>	<input checked="" type="checkbox"/>	No. 6 Indoor negative pressure setting
5	<input type="checkbox"/>	<input checked="" type="checkbox"/>	No. 7 Indoor positive pressure setting
6	<input type="checkbox"/>	<input type="checkbox"/>	Not in use
7	<input type="checkbox"/>	<input checked="" type="checkbox"/>	No. 51 Automatic ventilation mode setting
8	<input type="checkbox"/>	<input type="checkbox"/>	Not in use
9	<input type="checkbox"/>	<input checked="" type="checkbox"/>	No. 61 Fan speed for air volume "High" input (when using PZ-43SMF-E)
10	<input type="checkbox"/>	<input checked="" type="checkbox"/>	No. 62 Fan speed for air volume "Low" input (when using PZ-43SMF-E)

(SW5)

	OFF	ON	
1	<input type="checkbox"/>	<input type="checkbox"/>	Not in use
2	<input type="checkbox"/>	<input type="checkbox"/>	Not in use
3	<input type="checkbox"/>	<input checked="" type="checkbox"/>	No. 14 Exhaust fan setting
4	<input type="checkbox"/>	<input checked="" type="checkbox"/>	No. 5 Automatic recovery setting after power interruption
5	<input type="checkbox"/>	<input checked="" type="checkbox"/>	No. 1 Filter maintenance and fan power up setting against filter choking
6	<input type="checkbox"/>	<input type="checkbox"/>	Not in use
7	<input type="checkbox"/>	<input type="checkbox"/>	Not in use
8	<input type="checkbox"/>	<input type="checkbox"/>	Not in use
9	<input type="checkbox"/>	<input checked="" type="checkbox"/>	No. 14 Exhaust fan setting at OA temperature lower than -5°C
10	<input type="checkbox"/>	<input type="checkbox"/>	Not in use

6. Initial Settings (continued)

Language selection

Function description

The desired language can be set. The language options are English, French, German, Spanish, Italian, Portuguese, Swedish, and Russian.

Button operation

1

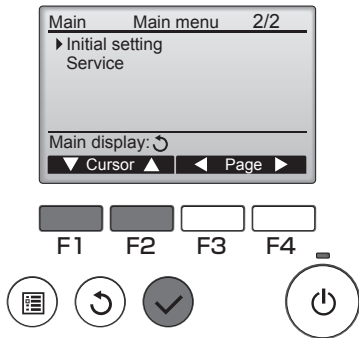

Select "Initial setting" from the Main menu, and press the **SELECT** button.

Enter maintenance password "0000" is displayed. Enter the initial password "9999" and press the **SELECT** button.

* For details on how to change the password, refer to the PZ-61DR-E Instruction Manual.

2

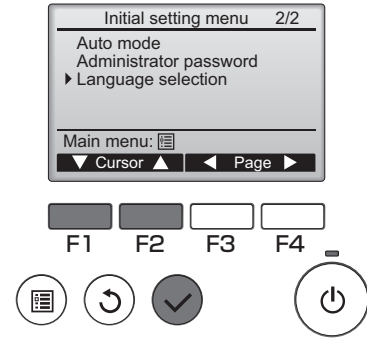

Move the cursor to the "Language selection" with the **F1** or **F2** button, and press the **SELECT** button.

3

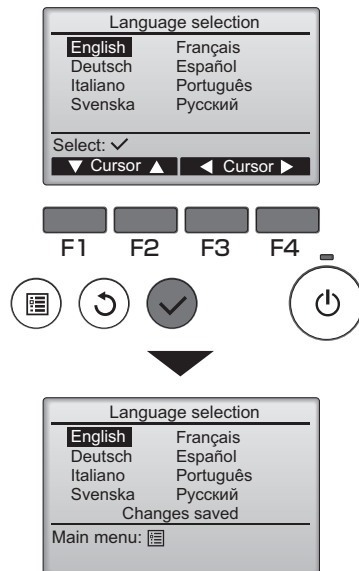

Move the cursor to the language you desire with the **F1** through **F4** buttons, and press the **SELECT** button to save the setting.

When the power is on for the first time, the Language selection screen will be displayed. Select a desired language. The system will not start-up without language selection.

A screen will appear that indicates the setting has been saved.

Navigating through the screens

- To go back to the Main menu **MENU** button
- To return to the previous screen **RETURN** button

6. Initial Settings (continued)

Entering the maintenance information

Button operation

1 Accessing the Main menu

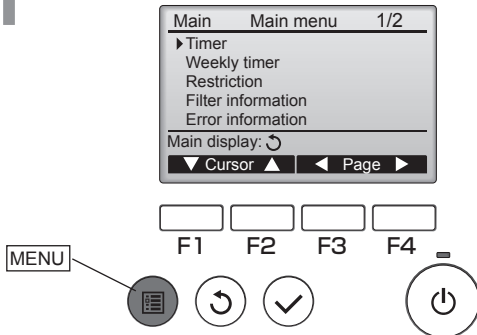

Press the **MENU** button.

The Main menu will appear.

2 Item selection

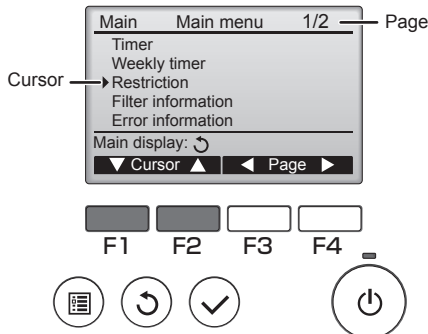

Press **F1** to move the cursor down.

Press **F2** to move the cursor up.

Press **F3** to go to the previous page.

Press **F4** to go to the next page.

3

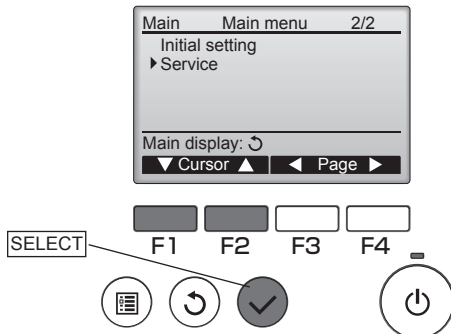

Press **F1**, **F2**, **F3**, **F4** to move the cursor to Service on the second page, and press the **SELECT** button.

4

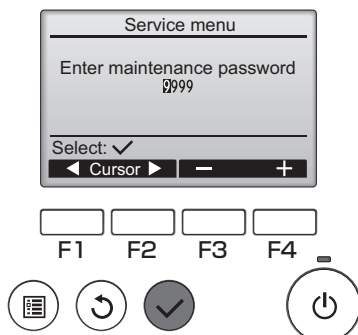

Enter maintenance password "0000" is displayed. Enter the initial password "9999" and press the **SELECT** button.

* For details on how to change the password, refer to the PZ-61DR-E Instruction Manual.

6. Initial Settings (continued)

5

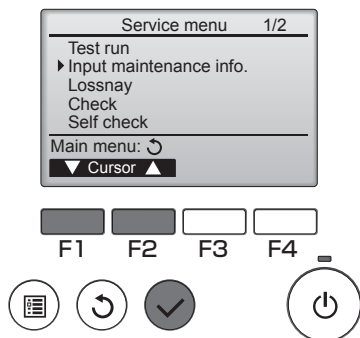

Select Input maintenance info. on the Service Menu screen, and press the **SELECT** button.

6

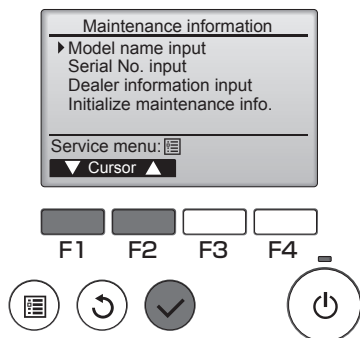

Select Model name input, and press the **SELECT** button.

7

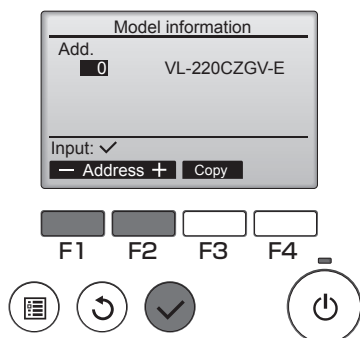

Select Add. 0.
Enter the model name: VL-220CZGV-E.
Press the **SELECT** button.
Maintenance information screen will appear.

8



Select Serial No. input.
Select Add 0.
Enter the Serial No. described on the name plate of the Lossnay unit.
Press the **SELECT** button.
Maintenance information screen will appear.

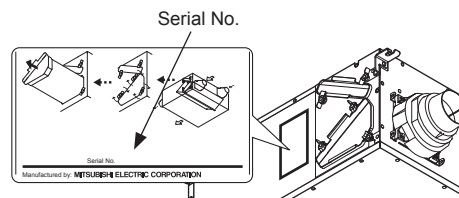

9



Select Dealer information input.
Enter the phone number of the dealer.
Press the **SELECT** button.
Maintenance information screen will appear.

6. Initial Settings (continued)

Change the function settings from the remote controller PZ-61DR-E.

Function description

Make the Lossnay units' function settings from the remote controller as necessary.

- Please refer to the Instruction book of PZ-61DR-E for how to set the function settings.
- When changing the Lossnay units' function settings, record all the changes made to keep track of the settings.

Button operation

1 Accessing the Main menu

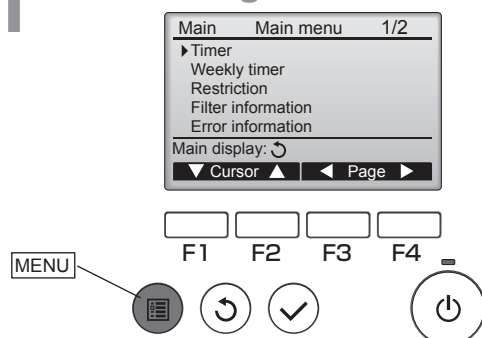

Press the **MENU** button.

The Main menu will appear.

2 Item selection

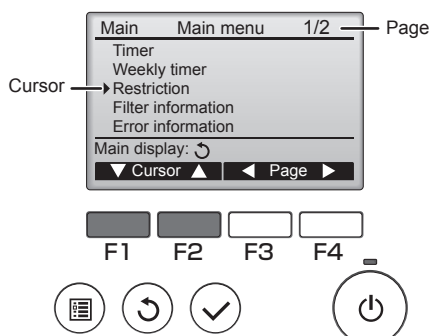

Press **F1** to move the cursor down.

Press **F2** to move the cursor up.

Press **F3** to go to the previous page.

Press **F4** to go to the next page.

3

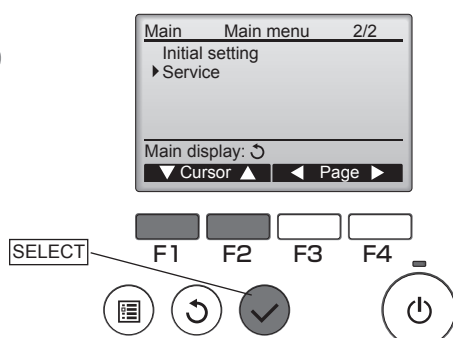

Press **F1**, **F2**, **F3**, **F4** to move the cursor to Service on the second page, and press the **SELECT** button.

4

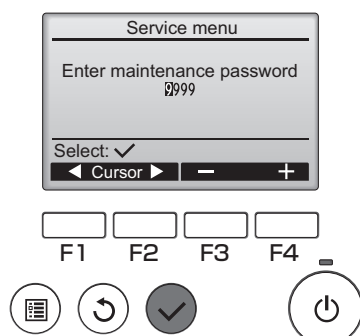

Enter maintenance password "0000" is displayed. Enter the initial password "9999" and press the **SELECT** button.

* For details on how to change the password, refer to the PZ-61DR-E Instruction Manual.

6. Initial Settings (continued)

5

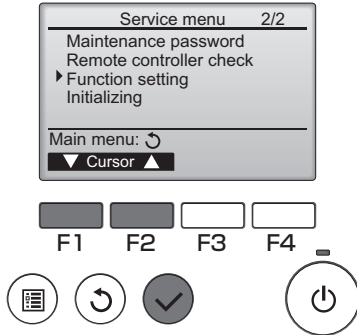

Select Function Setting on the Service Menu screen, and press the **SELECT** button.

6

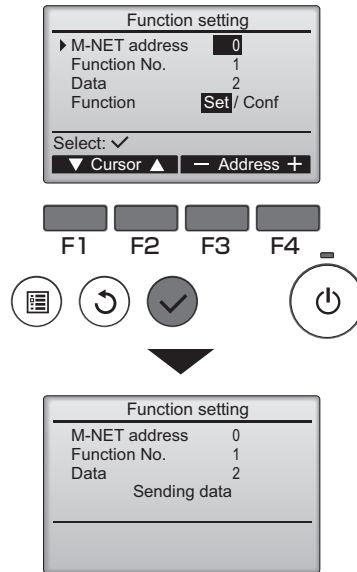

The Function Setting screen will appear.

Press the **F1** or **F2** button to move the cursor to one of the following: M-NET address, function setting number, or setting value. Then, press the **F3** or **F4** button to change the settings to the desired settings.

- Set the M-NET address to either "ALL" or "0".

Once the settings have been completed, press the **SELECT** button.

A screen will appear that indicates that the settings information is being sent.

To check the current settings of a given unit, enter the setting for its M-NET address and function setting number, select Conf for the Function, and press the **SELECT** button.

A screen will appear that indicates that the settings are being searched for. When the search is done, the current settings will appear.

7

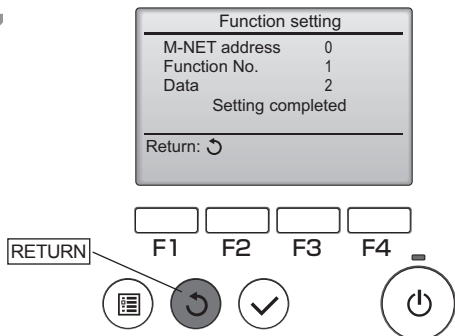

When the settings information has been sent, a screen will appear that indicates its completion.

To make additional settings, press the **RETURN** button to return to the screen shown in Step 3 above. Set the function numbers for other Lossnay units by following the same steps.

Navigating through the screens

- To return to the Service Menu screen **MENU** button
- To return to the previous screen **RETURN** button

6. Initial Settings (continued)

Function No	Function	Setting Data (PZ-61DR-E)								Factory setting	DIP-SW No.
		0	1	2	3	4	5	6	7		
1	Filter maintenance and fan power up setting against filter choking	Dip-SW priority	Indicator available Fan power up N/A	Indicator N/A Fan power up N/A	Indicator available Fan power up available	-	-	-	-	0	5-5
5	Automatic recovery setting after power interruption	Dip-SW priority	Stop when the power is On	Start when the power is On	Return to the state before interruption	-	-	-	-	0	5-4
6	Indoor negative pressure setting	Dip-SW priority	N/A	Supply 1 down	Supply 2 down	-	-	-	-	0	2-4
7	Indoor positive pressure setting	Dip-SW priority	N/A	Exhaust 1 down	Exhaust 2 down	-	-	-	-	0	2-5
14	Exhaust fan setting at OA temperature lower than -5 °C	Dip-SW priority	Stop	Fan speed 1 or 2	No change	-	-	-	-	0	5-3 5-9
51	Automatic ventilation mode setting	Dip-SW priority	Pattern A	Pattern B	Free setting	-	-	-	-	0	2-7
52	Automatic ventilation mode setting 1) Outdoor and indoor temperature gap	Setting Data 0 to 7 --> Temperature gap 23 °C to 30 °C								5	N/A
53	Automatic ventilation mode setting 2) The lowest outdoor temperature setting	Setting Data 0 to 15 --> Lowest outdoor temperature 10 °C to 25 °C								12	N/A
55	Supply fan power up setting	2 level down	1 level down	N/A	1 level up	2 level up	-	-	-	2	N/A
56	Exhaust fan power up setting	2 level down	1 level down	N/A	1 level up	2 level up	-	-	-	2	N/A
61	Fan speed for air volume "High" input	When PZ-61DR-E is used, the setting does not need to be changed								0	2-9
62	Fan speed for air volume "Low" input	When PZ-61DR-E is used, the setting does not need to be changed								0	2-10
100	Initialization	-	Initialize	-	-	-	-	-	-	0	N/A

This table shows the summary of function settings. Please refer to the following pages for more details.

The functions indicated with "N/A" in the "DIP-SW No." column are available only when using with remote controller PZ-61DR-E.

6. Initial Settings (continued)

No. 1 Filter maintenance and fan power up setting against filter choking

Set the schedule for filter cleaning based on the estimated concentration of dust in the air.

When fan power up is available, exhaust and supply fans power up at 2,200 hrs and 4,400 hrs gradually.

If function **No. 55** or **No. 56** is already worked, fan power up function may not be available.

Estimated hour differs by actual operated fan speed.

DIP-SW		Setting check	PZ-61DR-E		Setting check	Filter maintenance indicator	Fan power UP
SW No.	Setting		Function No.	Setting Data			
SW5-5	-	-	1	0 (Factory setting)		DIP-SW priority	
	-	-		1		Indicate at estimated 4,400 hrs	N/A
	OFF (Factory setting)			2		N/A	N/A
	ON			3		Indicate at estimated 4,400 hrs	Available

Note:

When the setting for the cumulative operation time of the Lossnay is exceeded, the filter cleaning icon will appear on the indoor unit remote controller or the Lossnay remote controller. After cleaning the filter, the filter cleaning icon can be reset. Refer to the Instruction book for the remote controller.

No. 5 Automatic recovery setting after power interruption

Sets for automatic recovery following power interruption.

DIP-SW		Setting check	PZ-61DR-E		Setting check	Automatic recovery
SW No.	Setting		Function No.	Setting Data		
SW5-4	-	-	5	0 (Factory setting)		DIP-SW priority
	OFF (Factory setting)			1		Stop when the power is on
	-	-		2		Start when the power is on
	ON			3		Lossnay returns to the state before interruption

No. 6 Indoor negative pressure setting

Exhaust fan speed becomes bigger than supply fan speed.

Remote controller indicates fan speed of exhaust fan.

Fan speed Display	Exhaust fan	Supply fan	
		1 down	2 down
4	4	3	2
3	3	2	1
2	2	1	1
1	1	1	1

DIP-SW		Setting check	PZ-61DR-E		Setting check	Down level of supply fan speed
SW No.	Setting		Function No.	Setting Data		
SW2-4	-	-	6	0 (Factory setting)		DIP-SW priority
	OFF (Factory setting)			1		N/A
	ON			2		Supply fan speed is 1 down to exhaust fan speed Supply fan speed is 2 down to exhaust fan speed
	-	-		3		Supply fan speed is 1 down to exhaust fan speed Supply fan speed is 2 down to exhaust fan speed

No. 7 Indoor positive pressure setting

Supply fan speed becomes bigger than exhaust fan speed.

Remote controller indicates fan speed of supply fan.

Fan speed Display	Supply fan	Exhaust fan	
		1 down	2 down
4	4	3	2
3	3	2	1
2	2	1	1
1	1	1	1

DIP-SW		Setting check	PZ-61DR-E		Setting check	Down level of exhaust fan speed
SW No.	Setting		Function No.	Setting Data		
SW2-5	-	-	7	0 (Factory setting)		DIP-SW priority
	OFF (Factory setting)			1		N/A
	ON			2		Exhaust fan speed is 1 down to supply fan speed
	-	-		3		Exhaust fan speed is 2 down to supply fan speed

No. 14 Exhaust fan setting at OA temperature lower than -5 °C

Sets the operation of the exhaust fan when the outdoor air is lower than -5 °C (when supply fan stop).

DIP-SW		Setting check	PZ-61DR-E		Setting check	Exhaust fan operation at outdoor temp. -5 °C or less
SW No.	Setting		Function No.	Setting Data		
SW5-3 SW5-9	-	-	14	0 (Factory setting)		DIP-SW priority
	5-3 OFF 5-9 ON			1		Stop
	5-3 ON 5-9 OFF			2		Forced to fan speed 2 or less*
	5-3 OFF 5-9 OFF (Factory setting)			3		No change

* When Lossnay is operating fan speed 1, exhaust fan keeps fan speed 1. Function **No. 14** is included in DIP-SW 5-3, then it is impossible to set independently without PZ-61DR-E.

No. 51 Automatic ventilation mode setting

Set the pattern of conditions to go into By-pass mode in automatic ventilation operation.

When setting Data is set "3" by PZ-61DR-E, function **No. 52** and **No. 53** are available.

DIP-SW		Setting check	PZ-61DR-E		Setting check	Conditions to go into By-pass mode
SW No.	Setting		Function No.	Setting Data		
SW2-7	-	-	51	0 (Factory setting)		DIP-SW priority
	OFF (Factory setting)			1		Pattern A Outdoor air temperature 22 °C to 28 °C
	ON			2		Pattern B Outdoor air temperature 16 °C to 28 °C
	-	-		3		Free setting

* Pattern A is more likely to become By-pass mode than pattern B.

6. Initial Settings (continued)

No.52 Automatic ventilation mode setting 1) Outdoor air temperature upper limit

Set one of conditions for By-pass mode in auto ventilation operation, outdoor air temperature upper limit.

This function is N/A from Lossnay unit DIP-SW.

This function is available when setting Data 3 is selected at function No. 51.

DIP-SW		Setting check	PZ-61DR-E		Setting check	Indoor temperature - outdoor temperature
SW No.	Setting		Function No.	Setting Data		
N/A	-	-	52	0		23 °C or more
	-	-		1		24 °C or more
	-	-		2		25 °C or more
	-	-		3		26 °C or more
	-	-		4		27 °C or more
	-	-		5	(Factory setting)	28 °C or more
	-	-		6		29 °C or more
-	-	7		30 °C or more		

No.53 Automatic ventilation mode setting 2) The lowest outdoor temperature

Set one of conditions for By-pass mode in auto ventilation operation, minimum outdoor temperature.

This function is N/A from Lossnay unit DIP-SW.

This function is available when setting Data 3 is selected at function No. 51.

DIP-SW		Setting check	PZ-61DR-E		Setting check	Outdoor temperature
SW No.	Setting		Function No.	Setting Data		
N/A	-	-	53	0		10 °C or more
	-	-		1		11 °C or more
	-	-		2		12 °C or more
	-	-		3		13 °C or more
	-	-		4		14 °C or more
	-	-		5		15 °C or more
	-	-		6		16 °C or more
	-	-		7		17 °C or more
	-	-		8		18 °C or more
	-	-		9		19 °C or more
	-	-		10		20 °C or more
	-	-		11		21 °C or more
	-	-		12	(Factory setting)	22 °C or more
	-	-		13		23 °C or more
	-	-		14		24 °C or more
-	-	15		25 °C or more		

Free By-pass setting

User can set conditions to go into By-pass mode in automatic ventilation mode by function No. 52 and No. 53.

Setting examples are shown below.

Example*

By-pass/Heat recovery ventilation map in automatic ventilation mode

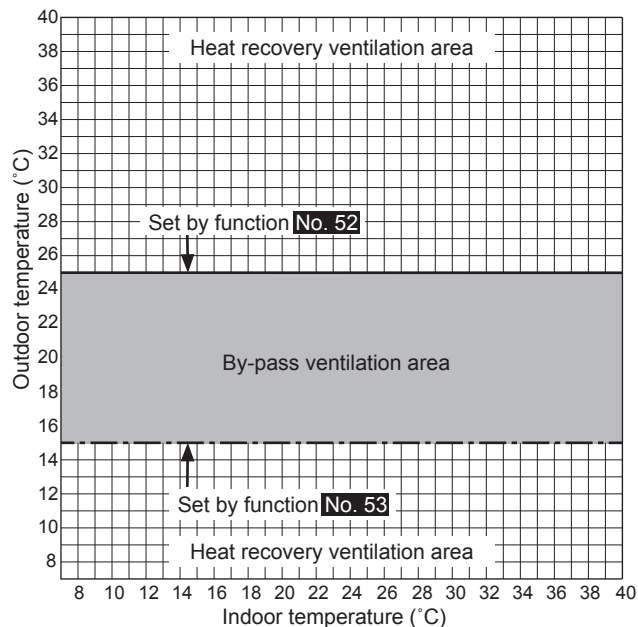

Function No.	Setting Data
52	2 (25 °C)
53	5 (15 °C)

No.55, 56 Supply fan power up setting Exhaust fan power up setting

Use these functions when the air volume is needed to be up after installation.

Function No. 55 is for supply fan power up and function No. 56 is for exhaust fan power up.

When function No. 1 is on and fan speed already reached the maximum power, this function is N/A.

These functions are N/A from Lossnay unit DIP-SW.

DIP-SW		Setting check	PZ-61DR-E		Setting check	Supply fan power up
SW No.	Setting		Function No.	Setting Data		
N/A	-	-	55	0		2 level down
	-	-		1		1 level down
	-	-		2	(Factory setting)	N/A
	-	-		3		1 level up
	-	-		4		2 level up

DIP-SW		Setting check	PZ-61DR-E		Setting check	Exhaust fan power up
SW No.	Setting		Function No.	Setting Data		
N/A	-	-	56	0		2 level down
	-	-		1		1 level down
	-	-		2	(Factory setting)	N/A
	-	-		3		1 level up
	-	-		4		2 level up

6. Initial Settings (continued)

No.61 Fan speed for air volume “High” input

Set the fan speed setting when receiving “High” signal from remote controllers(e.g. PZ-43SMF-E) which have High/Low air volume.
When PZ-61DR-E is used, this setting does not need to be changed.

DIP-SW		Setting check	Operating fan speed
SW No.	Setting		
	-	-	DIP-SW priority
SW2-9	OFF (Factory setting)		Fan speed 4
	ON		Fan speed 3

No.62 Fan speed for air volume “Low” input

Set the fan speed setting when receiving “Low” signal from remote controllers(e.g. PZ-43SMF-E) which have High/Low.
When PZ-61DR-E is used, this setting does not need to be changed.

DIP-SW		Setting check	Operating fan speed
SW No.	Setting		
	-	-	DIP-SW priority
SW2-10	OFF (Factory setting)		Fan speed 2
	ON		Fan speed 1

No.100 Initialization

Set to initialize the remote PZ-61DR-E setting.
All settings which are changed by users are cancelled.

DIP-SW		Setting check	PZ-61DR-E		Setting check	Initialization
SW No.	Setting		Function No.	Setting Data		
N/A	-	-	100	0		N/A
	-	-		1		Available

7. Post-installation Checks

When you have finished installation work, inspect the following items according to the following check list before turning the power on.

Be sure to correct any malfunctions that are found. (The functions is not being demonstrated or safety can not be ensured)

	Check Item	Remedy for Malfunction	Check
Installation of Lossnay unit	Are the Lossnay unit and the duct piping installed on the indoor side of the insulation layer/airtight layer?	Install them on the indoor side of the insulation layer/airtight layer.	
	Is the Lossnay unit installed within $\pm 1^\circ$ of the horizontal?	Install within $\pm 1^\circ$ of the horizontal	
	Is the Lossnay unit installed at a downward pitch of 0 to 1° in the direction where drain piping is installed?	Install at a pitch of 0 to 1°	
	Provide an inspection opening of the designated size installed at the designated position?	Provide an inspection opening at least 745 x 530 mm in size at the designated position	
	Is sufficient work space ensured? *See "Working space (required space around Lossnay unit)" at "3. Standard Installation Examples."	Ensure the required work space	
Duct connections	Is the outdoor side duct installed tilted 1/30 or more towards the outside to prevent rain water from entering?	Install the duct tilted	
	Are there metal chips or other foreign matter (e.g. paper or vinyl) inside the Lossnay unit or the ducts?	Remove any foreign matter.	
	Are ducts insulated down to their base? *See "Duct piping/ 2. Insulating" at "4. Installation Procedure".	Insulate	
	Are ducts connected to the Lossnay unit? (Air leakage causes dew condensation.)	Securely connect the ducts	
Drain piping	Is the drain piping connected on the indoor side of the insulation layer?	Connect the drain piping on the indoor side of the insulation layer	
	Is the drain piping insulated up to its end?	Insulate up to the end of the drain piping	
	Is the end of the drain piping inside the rain gutter?	It is not inside the rain gutter	
	Is the end opening facing down vertically in a condition to drain water well?	Make the opening face down so that water drains well	
	Is the piping 5 meters or longer?	Ensure that the piping is at least 5 m	
Wiring	Is the drain piping connected with the correct number of pipe bends and downward pitch?	Connect the drain piping so that the number of pipe bends and downward pitch are as indicated in the table on page 7	
	Is the power supply voltage correct?	Use 220 to 240 V power supply.	
	Is the wiring work the same as wiring diagram?	Wire as shown in the wiring diagram	
	Is the power supply cable connected to the terminal (TM1) certainly?	Connect to TM1 on the terminal block	
	Is the ground wire connected to the screw certainly?	Securely connect the ground wire	
	Are the cables properly secured using the cord clip and the PG connector?	Use a cord clip and PG connector	

8. Trial operation

After the system has been installed, make sure that wires are properly connected, then test the system's operation, referring to the operation manual for the remote controller.

■ **Perform trial operation with the user in attendance.**

- Noise sometimes increases for several minutes after the power to the Lossnay unit is turned off. This is operation to maintain the ventilation air volume at the appropriate volume, and is not a malfunction.
- It is difficult to tell the ventilation state when there is wind outside or during operation of a range hood fan, etc. When turning on the power, stop operation of the range hood fan or other noise sources.

1. When performing trial operation without using the remote controller

This function can be used following situations.

- When there is no remote controller installed for operating the Lossnay.
- When the outdoor temperature is 8 °C or lower. (To check By-pass damper operation)

(1) Supply power to the Lossnay unit.

(2) Turn the trial operation switch (DIP-SW SW2-1) "On."

Cancel trial operation at this point here ↓

Terminal	DIP-SW	Setting	Minutes	0	1	2	3	4	5	
			Seconds	0 10 20 30 40 50	0 10 20 30 40 50	0 10 20 30 40 50	0 10 20 30 40 50	0 10 20 30 40 50	0 10 20 30 40 50 10...	
-	-	-	Fan Speed	4						
-	SW6-1	OFF	Ventilation mode	Bypass	Lossnay					

- The ventilation mode operates only when the optional motorized damper is installed.

(3) Check each function operating normally.

(4) Turn the trial operation switch (DIP-SW SW2-1) "Off."







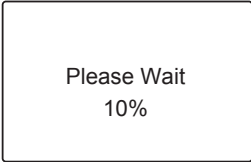

- When operation is started by the remote controller with DIP-SW SW2-1 still "On", error code "0900" is displayed on the remote controller.

2. Trial operation using the remote controllers (PZ-61DR-E or PZ-43SMF-E)

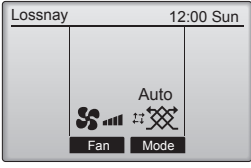
(1) When using the PZ-61DR-E

Press each of the buttons by following the procedure below to check that operation is normal.

"4. Selecting the ventilation mode" is displayed on the remote controller only when the optional motorized damper is installed to indicate that the mode can be switched.

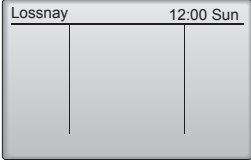
Operation Item	Operation Pad	Display	Step
1. Powering on			Turn the power on
2. Starting operation	ON/OFF lamp 		Press the "ON/OFF" button (operation LED lights)
3. Selecting air volume			Press the F2 button The fan speed is switched
4. Selecting the ventilation mode			Press the F3 button The ventilation mode switches in order "Automatic" → "Heat exchanger" → "By-pass"
5. Stopping operation	ON/OFF lamp 		Press the "ON/OFF" button (operation LED goes out)









* When the backlight is off, pressing any button turns the backlight on and does not perform its function. (Except "ON/OFF" button)

8. Trial operation (continued)

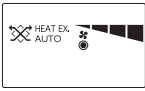
(2) When using the PZ-43SMF-E

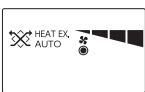
Press each of the buttons by following the procedure below to check that operation is normal.

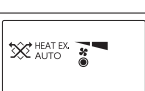
"3. Selecting the ventilation mode" is displayed on the remote controller only when the optional motorized damper is installed to indicate that the mode can be switched.

	Relevant button	Relevant display items	Sequence
1			Initiate the supply of power to the Lossnay unit. (The [HO] display will blink for approximately 45 seconds)
2			Press the "ON/OFF" button and check that the operation lamp turns on.
3			Press the "Ventilation mode" button: Each time it is pressed, the corresponding display will change in accordance with the sequence [HEAT EX.] (non-automatic) --> [BY-PASS] (non-automatic) --> [AUTO]. If [AUTO] is selected, the display will change to indicate the current mode after three seconds have passed.
4			Press the "Fan Speed" button to select either Low or High fan speed.
5	 Operation lamp		Press the "ON/OFF" button. (and check the operation lamp turns off.)

* Note that when the "Ventilation mode" button is pressed, it will take up to 40 seconds before the operation of the damper changes accordingly.

* When a button that is not preset with a function is pressed, "Invalid button" is displayed.

* When the backlight is off, pressing any button turns the backlight on and does not perform its function. (Except "ON/OFF" button)

3. If trouble occurs during trial operation

Symptom	Remedy	Check																					
Will not operate even when the operation switch for the remote controller (PZ-61DR-E, PZ-43SMF-E) is pressed.	<ul style="list-style-type: none"> Check the power supply. (The specified power supply is single-phase 220-240 V / 50 Hz, 220 V / 60 Hz) Check for a short circuit or disconnection in the transmission cable. (Check that the voltage between terminals in the transmission cables is 10 to 13 V DC for the controller.) Check that there is 5 cm or more separating the transmission cable from the power supply cable and any other transmission cables. Run the Lossnay independently using the trial operation switch (SW2-1) and check if it runs. <table border="1" data-bbox="496 1249 1029 1317"> <tr> <td>Lossnay runs</td> <td>--></td> <td>Check the signal lines</td> </tr> <tr> <td>Lossnay doesn't run</td> <td>--></td> <td>Check the power supply</td> </tr> </table> Check if there are two or more remote controllers connected. (The maximum is one.) Check that the wiring between the Lossnay unit and the remote controller is within 50 m 	Lossnay runs	-->	Check the signal lines	Lossnay doesn't run	-->	Check the power supply																
Lossnay runs	-->	Check the signal lines																					
Lossnay doesn't run	-->	Check the power supply																					
Lossnay does not stop.	<ul style="list-style-type: none"> Check that the trial operation switch (SW2-1) is set to off. 																						
The inspection indicator lamp (LED 1 Green) in the control box flashes.	<table border="1" data-bbox="475 1435 1396 1742"> <tr> <td>1 flash</td> <td>Fault on supply fan motor</td> <td rowspan="11">Turn the power off and consult your dealer.</td> </tr> <tr> <td>2 flashes</td> <td>Fault on exhaust fan motor</td> </tr> <tr> <td>4 flashes</td> <td>Fault on OA thermistor</td> </tr> <tr> <td>5 flashes</td> <td>Not used on this model</td> </tr> <tr> <td>6 flashes</td> <td>Not used on this model</td> </tr> <tr> <td>7 flashes</td> <td>Not used on this model</td> </tr> <tr> <td>8 flashes</td> <td>Not used on this model</td> </tr> <tr> <td>9 flashes</td> <td>Fault on remote controller communication</td> </tr> <tr> <td>10 flashes</td> <td>Fault on function setting</td> </tr> <tr> <td>11 flashes</td> <td>Fault on power supply to remote controller</td> </tr> </table>	1 flash	Fault on supply fan motor	Turn the power off and consult your dealer.	2 flashes	Fault on exhaust fan motor	4 flashes	Fault on OA thermistor	5 flashes	Not used on this model	6 flashes	Not used on this model	7 flashes	Not used on this model	8 flashes	Not used on this model	9 flashes	Fault on remote controller communication	10 flashes	Fault on function setting	11 flashes	Fault on power supply to remote controller	
1 flash	Fault on supply fan motor	Turn the power off and consult your dealer.																					
2 flashes	Fault on exhaust fan motor																						
4 flashes	Fault on OA thermistor																						
5 flashes	Not used on this model																						
6 flashes	Not used on this model																						
7 flashes	Not used on this model																						
8 flashes	Not used on this model																						
9 flashes	Fault on remote controller communication																						
10 flashes	Fault on function setting																						
11 flashes	Fault on power supply to remote controller																						
Abnormal vibration or abnormal noise	<ul style="list-style-type: none"> Check for loose Ceiling suspension fixture or ceiling hanging bolts. Check for ducts out of position. Check for loose or damaged parts. Check for vane contact. (sound of foreign matter getting inside) 																						
Air is not supplied or discharged from grills	<ul style="list-style-type: none"> Check for foreign matter inside piping. Check for ducts out of position. Check piping to see if it is connected in such a way that it might cause air volume to drop or cause abnormal noise. Check the ducts to see if they are bent excessively. 																						

■ When an inspection number blinks on the remote controller, follow the procedures shown in the installation and operating manuals provided with the remote controller.

Explaining to the User

- Explain to the user where the circuit breaker and remote controller are located and how to clean the filters.
- Tell the user the results of checks performed using the check list.
- Hand over the CD-ROM containing this Installation Manual to the user.
- Explain correct use by following the descriptions in the "Instruction Manual." In particular, "Safety Precautions" describe important notices and warnings relating to safety. Explain to users that they should observe these.

Manufactured by: **MITSUBISHI ELECTRIC CORPORATION**

TOKYO BLDG. 2-7-3, MARUNOUCHI, CHIYODA-KU, TOKYO, 100-8310 JAPAN

Importer in EU: MITSUBISHI ELECTRIC EUROPE B.V.

HARMAN HOUSE, 1 GEORGE STREET, UXBRIDGE, MIDDLESEX, UB8 1QQ, U.K.

Information on Disposal



Note: This symbol mark is for EU countries only.

This symbol mark is according to the directive 2012/19/EU Article 14 Information for users and Annex IX, and/or to the directive 2006/66/EC Article 20 Information for end-users and Annex II.

English

Your MITSUBISHI ELECTRIC product is designed and manufactured with high quality materials and components which can be recycled and/or reused.

This symbol means that electrical and electronic equipment, batteries and accumulators, at their end-of-life, should be disposed of separately from your household waste.

If a chemical symbol is printed beneath the symbol shown above, this chemical symbol means that the battery or accumulator contains a heavy metal at a certain concentration. This will be indicated as follows:

Hg: mercury (0,0005%), Cd: cadmium (0,002%),

Pb: lead (0,004%)

In the European Union there are separate collection systems for used electrical and electronic products, batteries and accumulators.

Please, dispose of this equipment, batteries and accumulators correctly at your local community waste collection/recycling centre.

Please, help us to conserve the environment we live in!

Deutsch

Ihr MITSUBISHI ELECTRIC-Produkt wurde unter Einsatz von qualitativ hochwertigen Materialien und Komponenten konstruiert und gefertigt, die für Recycling und/oder Wiederverwendung geeignet sind.

Dieses Symbol bedeutet, dass elektrische und elektronische Geräte sowie Batterien und Akkus am Ende ihrer Nutzungsdauer von Hausmüll getrennt zu entsorgen sind.

Wenn ein chemisches Symbol unterhalb des oben abgebildeten Symbols erscheint, bedeutet dies, dass die Batterie bzw. der Akku ein Schwermetall in einer bestimmten Konzentration enthält. Dies wird wie folgt angegeben:

Hg: Quecksilber (0,0005 %), Cd: Cadmium (0,002 %),

Pb: Blei (0,004 %)

In der Europäischen Union gibt es unterschiedliche Sammelsysteme für gebrauchte Elektrik- und Elektronikgeräte einerseits sowie Batterien und Akkus andererseits.

Bitte entsorgen Sie dieses Gerät, Batterien und Akkus vorschriftsmäßig bei Ihrer kommunalen Sammelstelle oder im örtlichen Recycling-Zentrum.

Bitte helfen Sie uns, die Umwelt zu erhalten, in der wir leben!

Italiano

Questo prodotto MITSUBISHI ELECTRIC è stato progettato e fabbricato con materiali e componenti di alta qualità, che possono essere riciclati e/o riutilizzati.

Questo simbolo significa che i prodotti elettrici ed elettronici, le batterie e gli accumulatori, devono essere smaltiti separatamente dai rifiuti casalinghi alla fine della loro vita di servizio.

Se sotto il simbolo mostrato sopra è stampato un simbolo chimico, il simbolo chimico significa che la batteria o l'accumulatore contiene un metallo pesante con una certa concentrazione. Ciò viene indicato come segue:

Hg: mercurio (0,0005%), Cd: cadmio (0,002%),

Pb: piombo (0,004%)

Nell'Unione Europea ci sono sistemi di raccolta differenziata per i prodotti elettrici ed elettronici, le batterie e gli accumulatori usati.

Per disfarsi di questo prodotto, delle batterie e degli accumulatori, portarli al centro locale di raccolta/riciclaggio dei rifiuti.

Aiutateci a conservare l'ambiente in cui viviamo!

Français

Votre produit Mitsubishi Electric est conçu et fabriqué avec des matériels et des composants de qualité supérieure qui peuvent être recyclés et/ou réutilisés.

Ce symbole signifie que les équipements électriques et électroniques, les batteries et les accumulateurs, à la fin de leur durée de service, doivent être éliminés séparément des ordures ménagères.

Si un symbole chimique est imprimé sous le symbole illustré ci-dessus, il signifie que la batterie ou l'accumulateur contient une certaine concentration de métal lourd. Elle sera indiquée comme suit :

Hg : mercure (0,0005%), Cd : cadmium (0,002%),

Pb : plomb (0,004%)

Dans l'Union Européenne, il existe des systèmes sélectifs de collecte pour les produits électriques et électroniques, les batteries et les accumulateurs usagés.

Nous vous prions donc de confier cet équipement, ces batteries et ces accumulateurs à votre centre local de collecte/recyclage.

Aidez-nous à conserver l'environnement dans lequel nous vivons !

Les machines ou appareils électriques et électroniques contiennent souvent des matières qui, si elles sont traitées ou éliminées de manière inappropriée, peuvent s'avérer potentiellement dangereuses pour la santé humaine et pour l'environnement.

Cependant, ces matières sont nécessaires au bon fonctionnement de votre appareil ou de votre machine.

Pour cette raison, il vous est demandé de ne pas vous débarrasser de votre appareil ou machine usagé avec vos ordures ménagères.

Español

Su producto MITSUBISHI ELECTRIC está diseñado y fabricado con materiales y componentes de alta calidad que pueden ser reciclados y/o reutilizados.

Este símbolo significa que el aparato eléctrico y electrónico, las pilas, baterías y los acumuladores, al final de su ciclo de vida, se deben tirar separadamente del resto de sus residuos domésticos.

Si hay un símbolo químico impreso debajo del símbolo mostrado arriba, este símbolo químico significa que la pila, batería o el acumulador contienen un metal pesado con cierta concentración. Esto se indicará de la forma siguiente:

Hg: mercurio (0,0005%), Cd: cadmio (0,002%),

Pb: plomo (0,004%)

En la Unión Europea existen sistemas de recogida específicos para productos eléctricos y electrónicos, pilas, baterías y acumuladores usados.

Por favor, deposite los aparatos mencionados, las pilas, baterías y acumuladores en el centro de recogida/reciclado de residuos de su lugar de residencia local cuando quiera tirarlos.

¡Ayúdenos a conservar el medio ambiente!

Português

O seu produto MITSUBISHI ELECTRIC foi concebido e produzido com materiais e componentes de alta qualidade que podem ser reciclados e/ou reutilizados.

Este símbolo significa que o equipamento eléctrico e electrónico, as baterias e os acumuladores, no final da sua vida útil, devem ser deitados fora separadamente do lixo doméstico.

Se houver um símbolo químico impresso por baixo do símbolo mostrado acima, o símbolo químico indica que a bateria ou acumulador contém metais pesados numa determinada concentração. Isto aparecerá indicado da maneira seguinte:

Hg: mercúrio (0,0005%), Cd: cádmio (0,002%),

Pb: chumbo (0,004%)

Na União Europeia existem sistemas de recolha separados para produtos eléctricos e electrónicos, baterias e acumuladores usados.

Por favor, entregue este equipamento, as baterias e os acumuladores correctamente, no seu ponto local de recolha/reciclagem.

Por favor, ajude-nos a conservar o ambiente em que vivemos!



Svenska

Denna produkt från MITSUBISHI ELECTRIC är designad och tillverkad av material och komponenter med hög kvalitet som kan återvinnas och/eller återanvändas.

Denna symbol betyder att förbrukade elektriska och elektroniska produkter, batterier och ackumulatörer skall sorteras och hanteras separat från hushållsavfall.

Om det finns en kemisk beteckning tryckt under ovanstående symbol betyder det att batteriet eller ackumulatören innehåller en tungmetall med en viss koncentration. Detta anges på följande sätt:

Hg: kvicksilver (0,0005%), Cd: kadmium (0,002%),
Pb: bly (0,004%)

Inom den Europeiska Unionen finns det separata insamlingsystem för begagnade elektriska och elektroniska produkter, batterier och ackumulatörer.

Var vänlig lämna denna produkt, batterier och ackumulatörer hos din lokala mottagningsstation för avfall och återvinning.

Var snäll och hjälp oss att bevara miljön vi lever i!

Dansk

Dit produkt fra MITSUBISHI ELECTRIC er designet og fremstillet med kvalitetsmaterialer og komponenter, der kan genindvindes og/eller genbruges.

Dette symbol viser, at elektrisk eller elektronisk udstyr, batterier og akkumulatører ikke må bortskaffes sammen med almindeligt husholdningsaffald efter endt levetid.

Hvis der er trykt et kemisk symbol under symbolet ovenfor, betyder det, at batteriet eller akkumulatøren indeholder en bestemt koncentration af et tungmetall. Dette angives som følger:

Hg: kviksølv (0,0005 %), Cd: cadmium (0,002 %),
Pb: bly (0,004 %)

I EU er der særlige indsamlingsordninger for brugte elektriske og elektroniske produkter, batterier og akkumulatører.

Bortskaf udstyret, batterier og akkumulatører korrekt på en lokal affalds-/genbrugsplads.

Hjælp os med at bevare det miljø, vi lever i!

Norsk

For norske brukere:

Dette produktet fra MITSUBISHI ELECTRIC er konstruert og produsert med materialer og komponenter av høy kvalitet, som kan resirkuleres og/eller brukes om igjen.

Dette symbolet betyr at elektrisk og elektronisk utstyr, batterier og akkumulatører, ikke bør kasseres sammen med husholdningsavfallet når de har nådd slutten av sin levetid.

Hvis det er trykt et kjemisk symbol under det symbolet som er vist over, betyr det kjemiske symbolet at batteriet eller akkumulatøren inneholder et tungmetall i en viss konsentrasjon. Dette vil vises som følger:

Hg: kvikksølv (0,0005 %), Cd: kadmium (0,002 %),
Pb: bly (0,004 %)

I Norge finnes det egne innsamlingsystemer for brukte elektriske og elektroniske produkter, batterier og akkumulatører. Kasser dette utstyret, batteriene og akkumulatørene ved den lokale gjenbruks- eller resirkuleringsstasjonen.

Hjelp oss å bevare det miljøet vi lever i!

Suomi

Tämä MITSUBISHI ELECTRIC -tuote on suunniteltu ja valmistettu korkealuokkaisista materiaaleista ja/tai osista, jotka voidaan kierrättää ja käyttää uudelleen.

Tämä symboli tarkoittaa, että sähkö- ja elektroniikkalaitteet, paristot ja akut täytyy niiden käyttöänsä jälkeen hävittää erillään talousjätteistä.

Jos yllä olevan symbolin alapuolelle on painettu kemiallinen symboli, se tarkoittaa, että paristolla tai akulla on tietty raskasmetallipitoisuus. Se ilmoitetaan seuraavasti:

Hg: elohopea (0,0005 %), Cd: kadmium (0,002 %),
Pb: lyijy (0,004 %)

Käytetyillä sähkö- ja elektroniikkalaitteilla, paristoilla ja akuilla on Euroopan Yhteisössä omat keräysjärjestelmänsä.

Toimita tämä laite, paristot ja akut paikalliseen jätehuolto-/kierrätyskeskukseen.

Auta meitä suojelemaan ympäristöä, jossa elämme!

Nederlands

Mitsubishi Electric producten zijn ontwikkeld en gefabriceerd uit eerste kwaliteit materialen. De onderdelen kunnen worden gerecycled en/of worden hergebruikt.

Het symbool betekent dat de elektrische en elektronische onderdelen, batterijen en accu's op het einde van de gebruiksduur gescheiden van het huishoudelijk afval moeten worden ingezameld. Wanneer er onder het bovenstaande symbool een chemisch symbool staat gedrukt, betekent dit dat de batterij of accu zware metalen in een bepaalde concentratie bevat. Dit wordt als volgt aangeduid:

Hg: kwik (0,0005%), Cd: cadmium (0,002%),
Pb: lood (0,004%)

In de Europese Unie worden elektrische en elektronische producten, batterijen en accu's afzonderlijk ingezameld.

Breng deze apparatuur, batterijen en accu's dan naar het gemeentelijke afvalinzamelingspunt.

Help ons mee het milieu te beschermen!

Ελληνικά

Το προϊόν MITSUBISHI ELECTRIC που διαθέτετε είναι σχεδιασμένο και κατασκευασμένο από υλικά και εξαρτήματα υψηλής ποιότητας, τα οποία μπορούν να ανακυκλωθούν ή/και να χρησιμοποιηθούν ξανά.

Το σύμβολο αυτό σημαίνει ότι ο ηλεκτρικός και ηλεκτρονικός εξοπλισμός, οι μπαταρίες και οι συσσωρευτές, στο τέλος της διάρκειας ζωής τους, θα πρέπει να απορριφτούν ξεχωριστά από τα υπόλοιπα οικιακά απορρίμμάτα σας.

Αν έχει εκτυπωθεί ένα χημικό σύμβολο κάτω από το σύμβολο που απεικονίζεται ανωτέρω, αυτό το χημικό σύμβολο σημαίνει ότι η μπαταρία ή ο συσσωρευτής περιέχει ένα βαρύ μέταλλο σε ορισμένη συγκέντρωση. Αυτό θα υποδεικνύεται ως ακολούθως:

Hg: υδράργυρος (0,0005%), Cd: κάδμιο (0,002%),
Pb: μόλυβδος (0,004%)

Στην Ευρωπαϊκή Ένωση υπάρχουν ξεχωριστά συστήματα συλλογής για τα χρησιμοποιημένα ηλεκτρικά και ηλεκτρονικά προϊόντα, τις μπαταρίες και τους συσσωρευτές.

Παρακαλούμε διαθέστε αυτόν τον εξοπλισμό, τις μπαταρίες και τους συσσωρευτές στο τοπικό σας κοινοτικό κέντρο συλλογής/ανακύκλωσης απορριμμάτων.

Βοηθήστε μας να προστατεύσουμε το περιβάλλον στο οποίο ζούμε!