

Fritzmann

COLLECTION 2019/2020



Over **100** years

www.fritzmann.org

Fritzmann



Over **100** years



Contents

01 | Optics *Pages 5 – 38*

02 | Gun Accessories *Pages 39 – 94*

03 | Sport Shooting Supplies *Pages 95 – 108*

04 | Knives *Pages 109 – 118*

05 | Gear *Pages 119 – 142*

06 | Hunting Ground Equipment *Pages 143 – 168*

07 | Game Recovery and Game Dressing *Pages 169 – 176*

08 | Trophy Processing *Pages 177 – 188*

09 | Dog Accessories *Pages 189 – 200*

10 | Apparel *Pages 201 – 216*

11 | Gift Articles / Home Accessories *Pages 217 – 234*



Fritzmann



Dear business partners,

for 115 years the name Fritzmann stands for customer proximity, reliability and service. We offer you and your customers products in the field of hunting, outdoor and shooting sports that meet the highest quality standards. It was, it is and will always be our philosophy in the future: We do our utmost to fulfill your wishes in the short and long term and to cultivate a strong, successful and future-oriented business partnership with you. So, we want to share our tradition and long experience with you while driving innovation in the hunting branch. This is also reflected in our collection. With our new catalog 2019/2020, we would like to introduce you to our high-selling assortment, where proven products, developments and novelties come together to form a complete program in the areas of optics, hunting accessories, gear, hunting ground equipment and sport shooting supplies. In particular, we introduce you to the novelties in the field of night vision, thermal imaging and optics. This growing market represents a decisive change for the hunt. Through our products and our know-how, we want to support you in the best possible way.

With this catalog, we offer you a variety of ways to respond to individual wishes and needs of your customers. We would also like to thank you for your loyalty and wish you much success with this catalogue.

Sincerely
Georg Fritzmann & Söhne GmbH

Management and Team



more than **100** years

01 | OPTICS



Rifle Scopes	<i>Pages 6 – 12</i>
Dot Sights	<i>Pages 13 – 18</i>
Scope Mounts	<i>Pages 19 – 25</i>
Tripods	<i>Page 26</i>
Range Finders	<i>Page 26</i>
Spotting Scopes	<i>Pages 26 – 27</i>
Thermal Vision	<i>Pages 28 – 29</i>
Night-Vision	<i>Pages 29 – 30</i>
Binoculars	<i>Page 31</i>
Optical Accessories	<i>Page 32</i>
Truglo Fiber-Optics	<i>Pages 33 – 36</i>
Truglo Laser	<i>Page 37</i>

Man hunter with shotgun looking through binoculars in forest © zprandim75



Olivon PREMIUM SERIES Rifle Scope with switchable red dot in 11 brightness levels

recoil-proof up to 800 G, very precise reticles, fully multi-coated optics, wide angle, 5 years warranty
37032-21

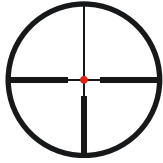

Magnification	Field of View / 100 m	Twilight Factor	Reticle	Tube Diameter	Length	Weight
2,5 - 10 x 50	16,6 - 4,0	11,2 - 22,4	4	30 mm	345 mm	670 g



Olivon PREMIUM SERIES Rifle Scope with switchable red dot in 11 brightness levels

recoil-proof up to 800 G, very precise reticles, fully multi-coated optics, wide angle, 5 years warranty
37032-22

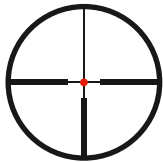

Magnification	Field of View / 100 m	Twilight Factor	Reticle	Tube Diameter	Length	Weight
3 - 12 x 56	14,0 - 3,4	12,9 - 25,9	4	30 mm	364 mm	640 g



**Olivon - Rifle Scope
with illuminated red dot in 7 levels**

Rugged recoil-proof construction, waterproof,
multi-coated optics

37032-12

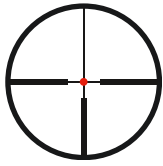

Magnification	Field of View / 100 m	Twilight Factor	Reticle	Tube Diameter	Length	Weight
3-12 x 56	10,8 - 2,8	12,9 - 26,0	4	30 mm	350 mm	650 g

**Olivon - Rifle Scope
with illuminated red dot in 7 levels**

Rugged recoil-proof construction, waterproof,
multi-coated optics

37032-13

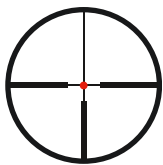

Magnification	Field of View / 100 m	Twilight Factor	Reticle	Tube Diameter	Length	Weight
1,5-6 x 42	21 - 5,4	5,6 - 15,6	4	30 mm	300 mm	550 g

**Olivon - Rifle Scope
with illuminated red dot in 7 levels**

Rugged recoil-proof construction, waterproof,
multi-coated optics

37032-16



Magnification	Field of View / 100 m	Twilight Factor	Reticle	Tube Diameter	Length	Weight
1-4 x 24	31,5 - 7,7	4,9 - 9,8	4A	30 mm	273 mm	450 g

Olivon - Rifle Scope

Rugged recoil-proof construction, waterproof, Premium series for Long-Range shooting, fully multi-coated optics, side focus, with illuminated reticle in red and green, brightness adjustable in 5 levels, with precision turrets

37033-03

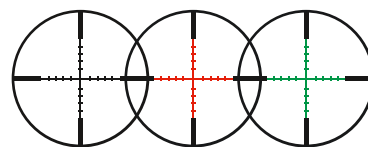

Magnification	Field of View / 100 m	Twilight Factor	Reticle	Tube Diameter	Length	Weight
8-32 x 56	4,3 - 1,1	21,1 - 42,3	Mil-Dot	30 mm	420 mm	830 g

Olivon - Rifle Scope

Rugged recoil-proof construction, waterproof, Premium series for Long-Range shooting, fully multi-coated optics, side focus, with illuminated dot in red and blue, dot brightness adjustable in 5 levels. **Special reticle in first focal plane.**

37033-13



Magnification	Field of View / 100 m	Twilight Factor	Reticle	Tube Diameter	Length	Weight
8-32 x 56	3,7 - 1	21,1 - 42,3	special	30 mm	444 mm	890 g

Olivon - Rifle Scope with illuminated reticle in red and blue, steplessly variable

Rugged recoil-proof construction, waterproof, multi-coated optics

37032-17

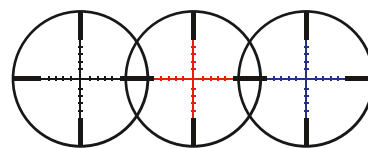

Magnification	Field of View / 100 m	Twilight Factor	Reticle	Tube Diameter	Length	Weight
1-6 x 24	33,2 - 5,1	4,9 - 12	Mil-Dot	30 mm	248 mm	460 g

Rifle Scope

with shiftable red or green dot, light intensity in 5 levels

37020-05

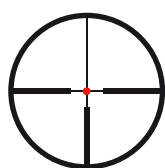

Magnification	Field of View / 100 m	Twilight Factor	Reticle	Tube Diameter	Length	Weight
1-8 x 24	39 - 5,5 m	4,9 - 13,8	4	30 mm	258 mm	460 g



Olivon - Rifle Scope

Rugged recoil-proof construction, waterproof, multi-coated optics
37032-01



Magnification	Field of View / 100 m	Twilight Factor	Reticle	Tube Diameter	Length	Weight
4 x 32	9,8	11,3	Duplex Crosshair with Parallax Compensation	1 "	308 mm	425 g

Olivon - Rifle Scope

Rugged recoil-proof construction, waterproof, multi-coated optics
37032-02

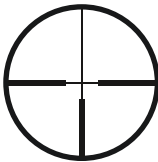

Magnification	Field of View / 100 m	Twilight Factor	Reticle	Tube Diameter	Length	Weight
3-9 x 40	12,7 - 4,2	10,9 - 18,9	4	1 "	321 mm	434 g

Rifle Scopes



Art. No.	Magnification	Reticle	Tube Diameter	Length
37030-01	4 x 32	Duplex Crosshair	1"	285 mm
37030-02	3 - 9 x 40	Duplex Crosshair	1"	315 mm
37030-21	4 x 32 incl. mount	Duplex Crosshair	1"	285 mm

Compact Rifle Scope



Art. No.	Magnification	Reticle	Tube Diameter	Length
37030-07	4 x 32	Duplex Crosshair	1"	185 mm

Sightmark - Rifle Scope

Recoil-proof for all current hunting calibers, fully multi-coated optics, high marginal sharpness, dot brightness adjustable in 5 levels, waterproof
37025-05

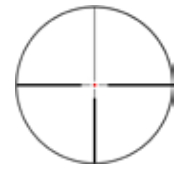

Magnification	Field of View / 100 m	Twilight Factor	Reticle	Tube Diameter	Length	Weight	parallax setting
3-12 x 56	11,8 - 2,93	13 - 27	4 with red dot sight	30 mm	322 mm	710 g	18,3 m up to infinite

Sightmark - Rifle Scope

Recoil-proof for all current hunting calibers, fully multi-coated optics, very precise outlines, red dot intensity adjustable in 11 levels, waterproof, best fitting for the driven hunt
37025-07



Magnification	Field of View / 100 m	Twilight Factor	Reticle	Tube Diameter	Length	Weight
1-6 x 24	38 - 6	4,9 - 12	4	30 mm	272 mm	459 g

Sightmark – Dot Sight Wolfhound HS-223 6 x 44

with special reticle **.223 BDC**, illumination in red and green in different brightness levels, fully multi-coated optics, rubber-coated aluminium housing, recoil-proof up to cal. .308, battery: CR 2023, integrated Weaver/Picatinny mount, field of view at 100 m: 5,25 dimensions: 170 x 76 mm weight: 666 g
37011-22



Sightmark – Dot Sight Wolfhound LR-308 6 x 44

with special reticle **.308 BDC**, illumination in red and green in different brightness levels, fully multi-coated optics, rubber-coated aluminium housing, recoil-proof up to cal. .308, battery: CR 2023, integrated Weaver/Picatinny mount, field of view at 100 m: 5,25 dimensions: 170 x 76 mm weight: 666 g
37011-23



Sightmark - Rifle Scope

Recoil-proof for all current hunting calibers, fully multi-coated optics, high marginal sharpness, reticle in red and green can be illuminated, dot brightness adjustable in 5 levels, waterproof
37025-01

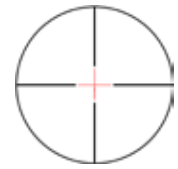

SIGHT  MARK®

Magnification	Field of View / 100 m	Twilight Factor	Reticle	Tube Diameter	Length	Weight	parallax setting
1-4 x 24	32 - 8	4,9 - 9,8	Dual Caliber	30 mm	245 mm	482 g	-

Sightmark - Rifle Scope

Recoil-proof for all current hunting calibers, fully multi-coated optics, high marginal sharpness, reticle in red and green can be illuminated, dot brightness adjustable in 5 levels, waterproof
37025-02



SIGHT  MARK®

Magnification	Field of View / 100 m	Twilight Factor	Reticle	Tube Diameter	Length	Weight	parallax setting
2,5-10 x 32	14,7 - 3,7	8,9 - 17,9	Dual Caliber	30 mm	310 mm	567 g	-

Sightmark - Rifle Scope

Recoil-proof for all current hunting calibers, fully multi-coated optics, high marginal sharpness, reticle in red and green can be illuminated, dot brightness adjustable in 5 levels, waterproof
37025-03



SIGHT  MARK®

Magnification	Field of View / 100 m	Twilight Factor	Reticle	Tube Diameter	Length	Weight	parallax setting
4-16 x 44	8,2 - 2,1	13,3 - 26,5	Marksman	30 mm	417 mm	680 g	18,3 m up to infinite

Sightmark - Rifle Scope

Recoil-proof for all current hunting calibers, fully multi-coated optics, high marginal sharpness, reticle in red and green can be illuminated, dot brightness adjustable in 5 levels, waterproof
37025-04



SIGHT  MARK®

Magnification	Field of View / 100 m	Twilight Factor	Reticle	Tube Diameter	Length	Weight	parallax setting
8,5-25 x 50	4,2 - 1,4	20,6 - 35,4	Marksman	30 mm	358 mm	822 g	9,14 m up to infinite

Sightmark - Rifle Scope

with illuminated reticles in green and red colors, brightness adjustable in 5 levels, high marginal sharpness, recoil-proof up to cal. .50, fully multi-coated optics, 10 years warranty
37025-08



Magnification	Field of View / 100 m	Twilight Factor	Reticle	Tube Diameter	Length	Weight
3-18 x 50	12,2 - 2,02	12,3 - 30	MR2	30 mm	330 mm	730 g

Sightmark - Rifle Scope

with illuminated reticles in green and red colors, brightness adjustable in 5 levels, high marginal sharpness, recoil-proof up to cal. .50, fully multi-coated optics, 10 years warranty



Art. No.	Magnification	Field of View / 100 m	Twilight Factor	Reticle	Tube Diameter	Length	Weight
37026-01	6,25-25 x 56	5,4 - 1,3	18,7 - 37,4	4	34 mm	349 mm	940 g
37026-02	8-32 x 60	5,4 - 1,3	21,9 - 43,8	4	34 mm	356 mm	1026 g
37026-03	10-40 x 60	3,3 - 0,8	24,5 - 49	4	34 mm	356 mm	1026 g

Sightmark – Rifle Scope

Recoil-proof for all current hunting calibers, fully multi-coated optics, high marginal sharpness, dot brightness adjustable in 11 levels, waterproof,
best suited for driven hunt
37025-06



Magnification	Field of View / 100 m	Twilight Factor	Reticle	Tube Diameter	Length	Weight
1-6 x 24	38 - 6	4,9 - 12	Special reticle	30 mm	272 mm	459 g



SIGHT MARK®



Red Dot Sight Wolverine CSR 1 x 23

with 4 MOA dot, digital brightness control, fully multi-coated optics, parallax-free, rubber-coated aluminium housing, recoil-proof up to cal. .308, battery: AA (Mignon), extremely low power consumption, Weaver/Picatinny mount integrated, size: 86 x 71 mm, weight: 292 g

37011-07 black

37011-09 dark earth



Laser Boresight Shot Checker

in cartridge form to put into the cartridge chamber, calibrated for highest precision

- 37090-31** Cal. .223
- 37090-32** Cal. .30-06
- 37090-33** Cal. .308
- 37090-36** Cal. 12
- 37090-42** Cal. 9 Para

Laser Boresight Shot Checker

in cartridge form to put into the cartridge chamber, calibrated for highest precision

SIGHT MARK®

- 37090-11** .223 Rem
- 37090-12** .30-06, .270 Win
- 37090-13** .308 Win, 243 Win
- 37090-14** .300 Win Mag
- 37090-15** 8x57 IS
- 37090-16** 12
- 37090-17** 7x64
- 37090-18** 6,5x55
- 37090-19** 8x57IRS
- 37090-20** 7x65R
- 37090-21** 9,3x62
- 37090-22** 9 mm Para
- 37090-23** .303



Laser Bore Sighter for zeroing Rifle Scopes

for all guns, incl. caliber adapters from .22 to .50 and 20/12 gauge, 15 cm long

37090-02



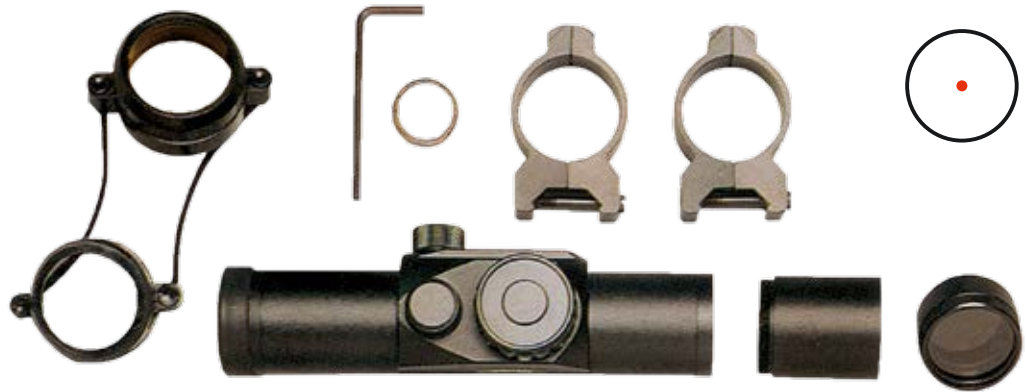

Red Dot Sight

dot brightness adjustable in 7 levels, field of view 13,3 m / 100 m, incl. ring mounts for Weaver / Picatinny rail, protective caps, Lithium battery, polarizing filter, extension tube, length 140 mm

37011-01 Tube diameter 30 mm

37011-04 Tube diameter 1"



Red Dot Sight

30 mm Tube diameter, dot brightness adjustable in 7 levels, field of view 13,3 m / 100 m, incl. ring mounts for Weaver / Picatinny rail, protective caps, Lithium battery, polarizing filter, extension tube, length 140 mm, Vario-Dot, 4 sizes of dot adjustable

37011-02

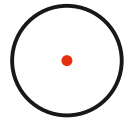

Multi-Reticle Dot Sight

with 4 different reticles, brightness adjustable in 11 levels, field of view 13,3 m / 100 m, recoil-proof, waterproof, 30 mm tube, length 140 mm, incl. Weaver-mount, high quality japanese product

37011-06

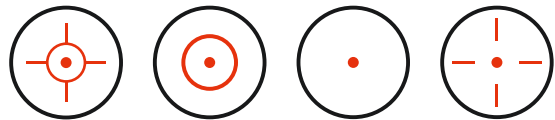

Dot Sight

1 x 30, brightness adjustable in 11 levels, 30 mm objective lens, length 10 cm, with mount for Weaver / Picatinny rail

37011-11





„Slide to Side“ Magnification Top

Ideal addition to dot sight, integrated Weaver/Picatinny mount with quick lock – Top can be folded to the side, field of view/100 m: 14,45 m, tube Ø: 30 mm, weight: 300 g, dimensions: 10,2x 4,25cm

37019-01 magnification 5-fold
37019-02 magnification 3-fold



„Slide to Side“ Magnification Top

Robust construction for tactical shooting, ideal addition to dot sight, integrated Weaver/Picatinny mount with quick lock – Top can be folded to the side, magnification 3-fold, field of view/100 m: 13,2 m, tube Ø: 30 mm, weight: 360 g, dimensions: 10,4x 5,33 cm

37019-03



Dot Sight

Brightness adjustable in 11 levels, field of view 13,7 m / 100 m, length 70 mm, weight 155 g, with Weaver mount

37011-19



Truglo® Dot Sight IGNITE™ MINI

with 2 MOA dot, 10 brightness levels, objective lens Ø 22 mm, with 2 mounts of different height, after 4 hours automatic switch-off, battery: 1 x AAA, length: 73 mm, weight: 160 g

37011-40



Dot Sight SURE HIT ROVER

Brightness adjustable in 11 levels, dot size 3 MOA, shotproof up to 800G, parallax-free, Ø of objective lense 30 mm, battery: 1 x AA, weight: 347 g, length: 125 mm

37011-08



Dot Sight SURE HIT MRS

Brightness adjustable in 11 levels, dot size: 3 MOA, recoil-proof up to 600G, made of aluminium, with mount for Weaver / Picatinny rail, bottom side waterproof
 Battery: CR2032, lifetime 2-3 years
 Size: 48x35,9x26 mm, Weight: 60 g
37015-23



Panorama Mini Dot Sight

automatic brightness control, parallax-free, size: 50 x 28 x 33 mm, field of view 13,4 m / 100 m, weight 37 g, with Weaver mount
37015-04
37015-98 protective cap



Mini Dot Sight

with detachable Weaver mount, dot size 6 MOA, size 40 x 35 x 25 mm
37015-10
37015-96 protective cap



TRUGLO

Dot Sight

4 different reticles in red and green, brightness adjustable in 5 levels, parallax-free beyond 30 m, field of view 22,5 m / 100 m, length 76 mm, weight 125 g, with Weaver mount
37015-01



Riflescope Protection

made of 2 mm thick Neoprene
37091-02 30 x 4 cm
37091-03 36 x 6 cm



Protector Cap for DOCTER sight

allows hunting at rain and snow, free sight and targeted shots, easy mounting and handling
37015-95



Battery CR 2354
37099-11 5 pcs.



Battery CR 2032
37099-12 5 pcs.



SIGHT MARK®



Dot Sight Mini Shot M-Spec LQD

10 brightness levels, point size: 3 MOA, recoil-proof up to cal. .308, of aluminium, with high and low mount plate for Weaver / Picatinny rail with quick lock, waterproof, simpler vertical and lateral adjustment by click screws, battery compartment at the top, battery: CR1632, dimensions: 44x29x56 mm, weight: 96 g
37015-29

SIGHT MARK®



Dot Sight Mini Shot M-Spec FMS

10 brightness levels, point size: 3 MOA, recoil-proof up to cal. .308, of aluminium, with high and low mount plate for Picatinny rail, waterproof, simpler vertical and lateral adjustment by click screws, battery compartment at the top, battery: CR1632, dimensions: 44x29x56 mm, weight: 85 g
37015-28

SIGHT MARK®



Mount plate for Glock

Especially for Mini Shot M-Spec and Docter sight etc.
37315-04

SIGHT MARK®

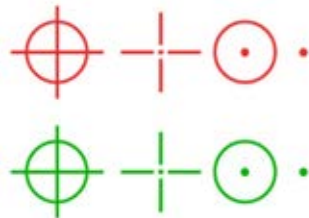

Red Dot Sight Ultra Shot R-SPEC

4 different reticles in red and green, digital brightness adjustment, fully multi-coated optics, parallax-free, stable aluminium housing, recoil-proof up to cal. .50, battery: CR123A, up to 2000 hours permanent use, integrated mount with quick-lock for Weaver/Picatinny, dimensions: 110 x 58 mm, weight: 304 g
37015-30

SIGHT MARK®

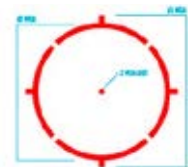

Dot Sight Ultra Shot M-Spec LQD

10 brightness levels, reticle Circle Dot 2MOA, recoil-proof up to cal. .50, rugged magnesium body, integrated mount with quick lock for Picatinny rail, extractible sunshade, waterproof, simpler vertical and lateral adjustment by click screws, lateral battery compartment, battery: CR123A, dimensions: 104x59 mm, weight: 290 g
37015-31

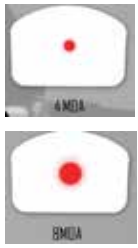

Shield Mini Sight

lightweight polymer body, polymer lens, 10 times more shock-resistant than glass, parallax-free, automatic brightness control, weight incl. battery 14 g, size 25,4 x 42 x 23 mm, battery: CR2032 (lifetime 2-3 years)

37016-02 4MOA **37016-03** 8MOA

Transparent Rain Cap

37016-90 Fitting for **37016-02** to **-05**

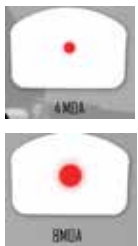

Reflex-Minisight Sight

rugged aluminium body, parallax-free automatic brightness control of red dot, weight including battery: 17,5 g, size: 25 x 42 x 23 mm battery: CR2032 (lifetime 2-3 years)

37016-04 4MOA **37016-05** 8MOA

Reflex Mini Sight waterproof

sealed housing prevents damage from water and moisture, waterproof up to 20 meters, extremely robust aluminium body, polymer lens, Anti-reflection coating, parallax-free, automatic brightness control, night vision compatible, weight incl. battery: 20 g, size: 25 x 42 x 23 mm Battery: CR2032 (lifetime: 2-3 years)

37016-06 4MOA



Mount adapters

- 1 37316-11** universal adapter (without picture)
- 1 37316-12** for Picatinny rail, spacer blocks for sight line elevation included
- 2 37316-14** universal shotgun mount for all gun rails
- 3 37316-17** for HK USP
- 4 37316-15** for Glock/Prisma
- 4 37316-16** for SIG
- 4 37316-18** for 1911
- 5 37316-19** for Glock MOS
- 6 37316-20** for SIG PC-X5





Mount adapter for Docter®Sight
 Universal mount,
 5 mm thick
37315-01



Mount adapter for Docter®Sight
 Mount for
 Weaver / Picatinny rail
37315-02



Mount adapter for Docter®Sight
 Universal mount with
 5 mm milling-groove
37315-03



Mount adapter for Docter®Sight
 Mount for Glock 17/18-23
37315-05



Mount adapter for Docter®Sight
 Adapter for
 EAW-Pivot-mount
37315-07



Mount adapter for Docter®Sight
 Adapter for claw mount
37315-08



Mount adapter for Docter®Sight
 Mount for
 11 - 12 mm dovetail
37315-10



Mount adapter for Docter®Sight
 Mount for
 14 - 15 mm dovetail
37315-11



Mount adapter for Docter®Sight
 Adapter for
 EAW-Pivot-mount
37315-12



Mount adapter for Docter®Sight
 Adapter for claw mount
37315-13



Mount adapter for Docter®Sight
 Mount for ventilated
 shotgun rails
37315-15



Mount adapter for Mini Dot Sight
 for 11 mm / 3/8" dovetail
37316-01



WYSS Docter® Sight mount for R 93

- Features:
- low height 7 mm
 - mountable/detachable without any tool
 - adjustable clamping force
 - weight only 38 g
 - recoil-proof
 - space for replacement battery
 - special tool for battery change and zeroing adjustment built-in
 - directions of zeroing marked on mount
- 37315-14**



Mount adapter for Dot sights with Weaver mounts
 e. g. 37015-02, -04, -09, -10
 Adapter for EAW-Pivot-mount
37317-01



Special mount set
37318-02 Ø 30 mm



Mount ring Picatinny rail
37318-03 Ø 30 mm

Negele 1-Part Precision Exchange Mounts made of surface-hardened steel for **Blaser systems**, 100% repetition precision, adaptation to the barrel by torx screw, rings produced from a solid piece, double-screwed on both sides



with 1" rings

37320-05 height 5,3 mm

with 30 mm rings

37320-01 height 4 mm

37320-02 height 7 mm

37320-04 height 9,7 mm

with 34 mm rings

37320-07 height 5,5 mm

with 36 mm rings

37320-08 height 5,5 mm

with 40 mm rings

37320-03 height 5,5 mm



Negele 1-Part Precision Exchange Mounts

made of surface-hardened steel
for Mount Rails

for Zeiss VM/ZM rail:

Fitting for rails by
Zeiss, Meopta, Docter,
Leica and Schmidt & Bender

37320-11 standard height 10 mm

37320-12 height 15 mm

for Swarovski rail

37320-13 standard height 10 mm

37320-14 height 15 mm



Set Mount Rings

37320-95 Ø 1", height 5,3 mm

37320-91 Ø 30 mm, height 4 mm

37320-92 Ø 30 mm, height 7 mm

37320-94 Ø 30 mm, height 10 mm

37320-97 Ø 34 mm, height 5,5 mm

37320-98 Ø 36 mm, height 5,5 mm

37320-93 Ø 40 mm, height 5,5 mm



Negele 1-Part Precision Exchange Mounts

made of surface-hardened steel **for Blaser systems**, 100% repetition precision, adaptation to the barrel by Torx screw, rings produced from solid piece, double-screwed on both sides



with 30 mm-Rings

37320-22 height 7 mm

**Negele 1-Part Precision Exchange Mounts**

made of surface-hardened steel **for Blaser systems**, 100% repetition precision, adaptation to the barrel by Torx screw, rings produced from one piece, double-screwed on both sides
Generation 2 – with newly designed enlarged closing flaps

with 1"- rings

37320-35 height 5,3 mm

with 30 mm - rings

37320-32 height 7 mm

37320-34 height 9,7 mm

with 34 mm - rings

37320-37 height 5,5 mm

with 36 mm - rings

37320-38 height 5,5 mm

with 40 mm - rings

37320-33 height 5,5 mm

**Negele 1-Part Precision Exchange Mounts**

made of surface-hardened steel **for Mount Rails**
Generation 2 – with newly designed enlarged closing flaps

for Zeiss VM/ZM rail

Fitting for rails by Zeiss, Meopta,
Docter, Leica und Schmidt & Bender

37320-41 standard height 10 mm

37320-42 height 15 mm

for Swarovski rail

37320-43 standard height 10 mm

37320-44 height 15 mm



2-Part Steel Mount for Picatinny/Weaver Rail

with double ring screw connection, bar stop and lever for quick mount

- 37312-01** 1" Ø, height 5 mm
- 37312-02** 1" Ø, height 9 mm
- 37312-03** 1" Ø, height 15 mm
- 37312-11** 30 mm Ø, height 5 mm
- 37312-12** 30 mm Ø, height 7 mm
- 37312-13** 30 mm Ø, height 12,5 mm
- 37312-14** 30 mm Ø, height 15 mm



2-Part Steel mount for Picatinny/Weaver Rail,

with double ring screw connection and bar stop

- 37313-01** 1" Ø, height 5 mm
- 37313-02** 1" Ø, height 9 mm
- 37313-03** 1" Ø, height 15 mm
- 37313-11** 30 mm Ø, height 5 mm
- 37313-12** 30 mm Ø, height 7 mm
- 37313-13** 30 mm Ø, height 15 mm
- 37313-22** 34 mm Ø, height 10 mm
- 37313-23** 34 mm Ø, height 16 mm



2-Part Steel Mount for 11 mm Rail

with double screw ring connection

- 37314-01** 1", height 7 mm
- 37314-02** 1", height 9,5 mm
- 37314-03** 1", height 13 mm
- 37314-11** 30 mm Ø, height 7 mm
- 37314-12** 30 mm Ø, height 10 mm
- 37314-13** 30 mm Ø, height 13 mm



1-Part Mount of T6 Aluminium for Picatinny/Weaver Rail

with 3-fold screw ring connection, 30 mm Ø, height 27 mm

- 37330-01** 0 MOA
- 37330-02** 20 MOA
- 37330-03** 30 MOA
- 37330-04** 45 MOA



1-Part Mount of T6

Aluminium for Picatinny/Weaver Rail

with 3-fold ring screw connection and level, 30 mm Ø, height 25,5 mm

- 37331-01**





Elevated – The Slide

freely adjustable precision mount for dot sights as e.g. Aimpoint, Holosun, Trijicon MRO etc., fits on all standard Weaver / Picatinny rails

Weight: 45 g

Dimensions: 30 x 52 x 17 – 24 mm

37350-01

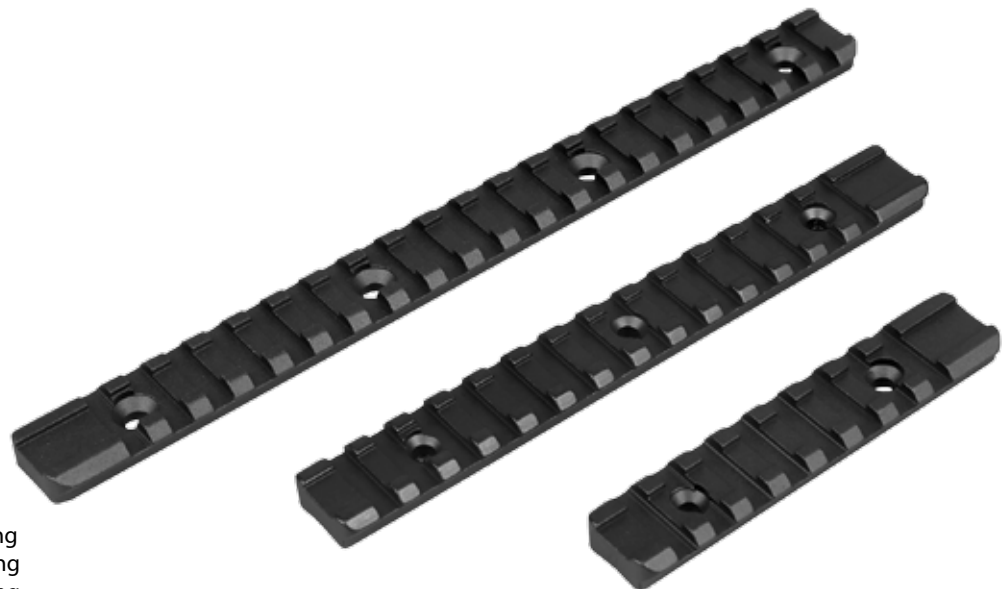

Picatinny rail

aluminium

37341-01 80 mm long

37341-02 100 mm long

37341-03 160 mm long



Picatinny Rail

made of steel, for Mauser 98

37340-01



Scope Mount
2-part light metal slide-on mount with double screwing for 11 mm dovetail, 1" Ø, height 15 mm
37308-01



Scope Mount
2-part light metal slide-on mount with double screwing for 11 mm dovetail, 1" Ø, height 23 mm
37308-02



Scope Mount
2-part light metal slide-on mount with double screwing for Weaver / Picatinny rail, 1" Ø, height 12 mm
37308-03



Scope Mount
2-part light metal slide-on mount with double screwing for Weaver / Picatinny rail, 1" Ø, height 19 mm
37308-04



Scope Mount
2-part light metal slide-on mount with double screwing for 11 mm dovetail, 30 mm Ø, height 15 mm
37308-05



Scope Mount
2-part light metal slide-on mount with double screwing for 11 mm dovetail, 30 mm Ø, height 25 mm
37308-06



Scope Mount
2-part light metal slide-on mount with double screwing for Weaver rail, 30 mm Ø, height 15 mm
37308-07



Scope Mount
2-part light metal slide-on mount with double screwing for Weaver rail, 30 mm Ø, height 22 mm
37308-08



Brno Scope mounts
Steel, 2-part slide-on mount for rifles with 16 mm dovetail (Brno Mod. Fox 527, KK-Mod. 50)
37307-21 1" Ø, height 17 mm
37307-23 30 mm Ø, height 17 mm
37307-22 1" Ø, height 21 mm
37307-24 30 mm Ø, height 21 mm



Brno Scope mounts
Steel, 2-part slide-on mount for rifles with 11 mm dovetail
37307-31 1" Ø, height 17 mm
37307-33 30 mm Ø, height 17 mm



Brno Scope mounts
Steel, 1-part slide-on mount for guns with 14,5 mm dovetail (Brno Mod. ZH, 500, Super)
37311-01 1" Ø, height 17 mm
37311-03 30 mm Ø, height 17 mm
37311-02 1" Ø, height 21 mm
37311-04 30 mm Ø, height 21 mm



Brno Scope mounts
Steel, 2-part slide-on mount for rifles with 19,5 mm dovetail (Brno Mod. ZKK 600, 601, 602, 537)
37307-01 1" Ø, height 17 mm
37307-03 30 mm Ø, height 17 mm
37307-02 1" Ø, height 22 mm
37307-04 30 mm Ø, height 22 mm





Scope mount
2-part light metal
slide-on mount for
Weaver / Picatinny rail,
1" Ø, height 9 mm
37301-02



Scope mount
2-part light metal
slide-on mount for
Weaver / Picatinny rail,
30 mm Ø, height 6 mm
37303-03



Scope mount
2-part light metal
slide-on mount for
11 mm dovetail, 1" Ø,
height 15 mm
37306-02



Scope mount
2-part light metal
slide-on mount for
11 mm dovetail, 1" Ø,
height 27 mm
37306-04



Scope mount
2-part light metal slide-on mount
with fixing screw in base for 11 mm
dovetail, 1"Ø, height 12 mm
37308-11



**Scope
mount**
1-part light metal
universal slide-on mount for guns
with 11 mm dovetail or Weaver rail
37306-11 1" Ø, height 14 mm
37306-12 30 mm Ø,
height 20 mm



Scope mount
Adapter for left-eye-shooting
37309-01



Mount fixing block
for 11 mm dovetail,
especially for air rifles
37309-02



Universal mount
37309-03



Magnetic mount
37309-04 1"Ø
37309-05 30 mm Ø



Mount adapter
from 11 mm dovetail
to Weaver rail
37309-06



Truglo adapter rail
from 11 mm dovetail to Weaver rail,
length 90 mm
37309-11



Truglo Mount Adapter 45°
for Picatinny rail
37309-12



Olivon Stativ

- Aluminum legs
 - with rubber feet
 - 60 -160 cm, 3-way Panorama head with quick-detach system, with pouch, weight: 2,6 kg
- 37100-05**



Olivon Mini Spotting Scope 8-24x40

Roof prism, multi-coated optics, field of view / 1000 m: 77 – 37 m, dimensions: 155x50x50 mm, weight: 200 g

37120-06

37120-07 as set – spotting scope with smartphone support



Shooting Gallery Set

Consists of spotting scope T 60, 15-45x60, tripod 500 - 1500 mm and smartphone support

37120-10



Smartphone-Adapter for Scope Eyepieces

- Eye-piece-Ø
- 37120-92** 38 – 44 mm
 - 37120-93** 40 – 46 mm
 - 37120-90** 47 – 53 mm
 - 37120-91** 55 – 61 mm

Exchangeable Eyepiece-Rings

- Eye-piece-Ø
- 37120-97** 38 – 44 mm
 - 37120-98** 40 – 46 mm
 - 37120-95** 47 – 53 mm
 - 37120-96** 55 – 61 mm



Clamp Monopod Eagle-Grip

The head is detachable and can stay at the scope

37100-25



Laser Range Finder

waterproof, magnification 6x, range: 6 – 600 m, accuracy +/- 1 m, size: 99 x 69 x 40 mm, weight: 232 g, incl. Battery CR2

37160-01



Laser Range Finder

magnification 6x, range: 6 – 600 m, accuracy +/- 1 m, size: 99 x 69 x 40 mm, weight: 208 g, incl. Battery CR2

37160-02



Olivon Compact Spotting Scope

12 - 30 x 50, 45° degree eyepiece, weight 470 g, length 24 cm

37120-08 without tripod

37120-28 with tripod



Olivon Spotting Scope T-60 15 – 45 x 60
 extreme light performance, sharp imaging through improved optics, suitable for target watching up to 300 m, 45° degree eyepiece, multi-coated lenses, waterproof, weight 700 g, size 330 x 90 mm, without tripod
37120-09



Olivon Spotting Scope 16 – 48 x 65
 extreme light performance, sharp imaging through improved optics, suitable for target watching up to 300 m, 45° degree eyepiece, multi-coated lenses, waterproof, weight 1750 g, size 420 x 90 mm, without tripod
37120-27



Rifle Scope Quiver

Nylon, green, Ø 8 cm, length 37 cm

32372-02



Spotting Scope Quiver

Nylon, green, Ø 11 cm

32372-03 length 40 cm

32372-07 length 45 cm



Rifle Scope Quiver

genuine leather, brown

32372-05 inside dimension 32 x 7 cm

Thermal imager IR510 Nano N2

Lightweight, handy thermal imaging device for detecting or searching game. The integrated VOx sensor offers an overwhelming picture quality. Realistic picture due to high frame rate. Due to selectable color modes (Black Hot, White Hot, Red Hot) and an advanced algorithm it is easier and faster to recognize objects.

- detector: 400 x 300 / 17 µm
- frame rate: 50 Hz
- temperature sensitivity: ≤50mK @ 30 °C
- objective lens: 25 mm
- object recognition: 500 m
- digital magnification: 1x, 2x and 4x
- waterproof: IP67
- battery: fully charged Li-Ion battery, 3,200 mAh to charge via USB
- battery life in continuous operation: approx. 5 hours
- size: 168 x 67 x 62 mm
- weight: 375 g

37151-02



Thermal imaging attachment TA435

This handy and lightweight device allows you to detect animals with high contrast and realistic images even in adverse conditions, such as fog, due to its high frame rate and extremely good temperature sensitivity. The high-end OLED color display is currently the highest quality screen available on the market. As a result, it is possible to use it on optics with up to 6x magnification. With five scene modes (standard, city, forest, snow and desert) the device can be adapted to the ambient conditions with just one touch of a button so the targeted objects can be optimally highlighted. The device can be used at temperatures between -30°C to 50 °C and in adverse conditions such as heavy rain.

- for mounting on spotting scopes or binoculars
- detector: 400 x 300 / 17 µm
- frame rate: 50 Hz
- temperature sensitivity: ≤50mK @ 30 °C
- objective lens: 35 mm
- screen: 1024 x 768 pixels
- object recognition: 620 m
- digital magnification: 1x, 2x and 4x
- waterproof: IP67
- battery: 2x CR123A / ICR1640
- size: 152 x 54 x 53 mm
- weight: 380 g

37151-11



Mounting Adaptor for 37151-11

- 37151-30** Ø 30 mm
- 37151-48** Ø 48 mm
- 37151-50** Ø 50 mm
- 37151-56** Ø 56 mm
- 37151-57** Ø 57 mm
- 37151-58** Ø 58 mm
- 37151-62** Ø 62 mm
- 37151-63** Ø 63,5 mm
- 37151-64** Ø 64 mm
- 37151-65** Ø 65 mm

Further dimensions upon request



2 rechargeable batteries CR123A
3,7 V / 650 mAh
33322-53



Thermal imager TrackIR-35

Portable thermal imaging device of the latest generation. The lightweight, handy thermal imager is ideal for tracking and hunting game. The integrated VOx sensor and the HD color display provide an overwhelming picture quality. The selectable color modes (Black Hot, White Hot, Red Hot), the high-resolution sensor and an advanced algorithm make it easier and faster to spot objects. Additionally, the memory function allows the recording of photos and videos.

- detector: 400 x 300 / 17 μ m
- frame rate: 50 Hz
- temperature sensitivity: ≤ 50 mK @ 30 °C
- objective lens: 35 mm
- screen: 1280 x 960 pixels, colored LCOS display
- object recognition: 1000 m
- digital magnification: 1x, 2x and 4x
- possibility to record photos and videos
- build-in memory 16 GB
- waterproof: IP67
- battery: fully charged Li-Ion battery, 6,000 mAh to charge via USB-C
- battery life in continuous operation: approx. 5 hours
- size: 192 x 65 x 71 mm
- weight: 485 g

37151-03**SiOnyx Aurora Digital Night Vision - Camera**

- picture tube insensitive to bright light incidence
- can also be used as daylight camera
- pictures in color or black/white
- photos or video recording possible
- waterproof: IP67
- possible connections: WiFi, USB 2.0
- storage via Micro SD 4 – 32 GB (not included)
- rechargeable lithium-ion battery for 2 hours of continuous service
- dimensions: 12 x 5 x 6 cm

37150-01**Night-Vision Binocular, 4 x 50**

1st generation, with adjustable IR-illuminator

- max. range 300 m
- range of IR-illuminator 100 m
- angle of view 15°
- battery 1 x CR123A 3V
- weight: 800 g
- size: 228 x 120 x 64 mm
- with tripod socket

37150-03



Clip-On Night-Vision Monocular

Generation 2+, mountable on spotting scopes and binoculars

- high resolution
- focus 8 m - ∞
- magnification 1 x
- angle of view 12,6°
- auto-Switch-Off
- resolution 51 – 57 LP

37150-15 with cathode ray tube, black/white image

37150-17 with photonis tube, black/white image

- rainproof
- battery 1 x CR123A 3V
- battery lifetime up to 60 hours
- operating temperature -50°C to +50°C
- size: 180 x 80 x 80 mm
- weight: 690 g



Lens mounts

- | | |
|-------------------------|---------------------------|
| 37150-38 Ø 30 mm | 37150-43 Ø 62 mm |
| 37150-39 Ø 38 mm | 37150-44 Ø 62,5 mm |
| 37150-40 Ø 48 mm | 37150-45 Ø 64 mm |
| 37150-41 Ø 56 mm | 37150-46 Ø 67 mm |
| 37150-42 Ø 57 mm | |



IR-Laser Illuminator IR 915nm

focusable and dimmable, with mount for Weaver / Picatinny rail, Recoil-proof, gamesafe
37150-50



Lens mounts

- | |
|------------------------------|
| 37150-35 46,7 – 50 mm |
| 37150-36 56 – 61 mm |
| 37150-37 62 – 67 mm |





Olivon Binoculars

dielectric phase-coated prisms, fully multi-coated lenses, nitrogen-filled, water- and fogproof, with pocket and carrying-belt



Picture-No.	Article Number	Magnification	Objective-Ø	Field of View at 1000m	Size	Weight
1	37200-19	8 x 56	56 mm	109 m	163 x 143 mm	1053 g
2	37200-21	8 x 26	26 mm	122 m	117 x 115 mm	282 g
3	37200-22	8 x 34	34 mm	124 m	130 x 126 mm	426 g
4	37200-23	8 x 42	42 mm	122 m	146 x 135 mm	550 g
4	37200-20	10 x 42	42 mm	100 m	140 x 130 mm	685 g



Binocular 8 x 21

coated optics,
rubber armed,
with pouch
• magnification 8 x
• objective-Ø 21 mm
37200-01

• field of view 126 m / 1000 m



Eyecups for Binoculars

37210-01 standard size 37 – 44 mm
37210-02 compact size 28 – 37 mm

Lens Covers

for scopes, binoculars, torches, Night-Vision devices etc. consisting of elastic rubber rings and scratch-free color filters; filters can be easily exchanged. The filters are not spring-loaded, so the filter stays in any position as perfect sun shade.



2-Color-Set

1 ring, 1 lid each
black and transparent
33334-40 Ø 30 mm
33334-43 Ø 49 mm
33334-46 Ø 57 mm
33334-49 Ø 62 mm



5-Color-Set

1 ring, 1 lid each
black, red, yellow, green, transparent
33334-41 Ø 30 mm
33334-44 Ø 49 mm
33334-47 Ø 57 mm
33334-50 Ø 62 mm



Binocular Case

of neoprene, green, for 8x56
32226-10



Scope-Eyecup

cylindric 90 mm,
Ø 36,5 mm
33334-01



Scope-Eyecup

cylindric 60 mm,
Ø 36,5 mm
33334-02



Lens cleaner

37095-01



Scope-Eyecup

conical 60 mm, Ø 36,5 mm
33334-03



**Telescopic
Scope-Eyecup**

33334-04 Ø 38 mm
33334-05 Ø 41 mm
33334-06 Ø 43 mm



Binocular Carrying Belt

32226-02 Neoprene
32226-03 Loden with embroidery deer head
32226-04 Loden with embroidery hunting horn





Fiber-optics for pistols

- 37500-01** for Glock 17/17L, 19, 22, 23, 24, 26, 27, 33, 34, 35, 38, 39
- 37500-02** for Glock 20, 21, 29, 30, 31, 32, 37



Gobble Dot Fiber-optics

Universal for all rib widths,
for glue-on, Ø 3 mm front dual color,
Ø 1 mm rear
37501-06



Truglo® FIBER-OPTIC PRO
Fiber glass sight for Glock 17/17L, 19,
22, 23, 24, 26, 27, 33, 34, 35, 38, 39,
glows especially bright due to
integrated reflector, with 3 replace-
ment rods in red/green/yellow and 3
replacement reflectors
37500-11



TRU BEAD™ Fiber-optics
for screw-on, Ø 1,5 mm front, Ø 0,9 mm rear, with exchangeable rear sight
37501-02 red



**Truglo Universal
Shotgun Shield**, 2-parts,
for faster catching of the sight line,
for all current rails cal. 12 + 16,
Ø 1,2 mm front
37501-08

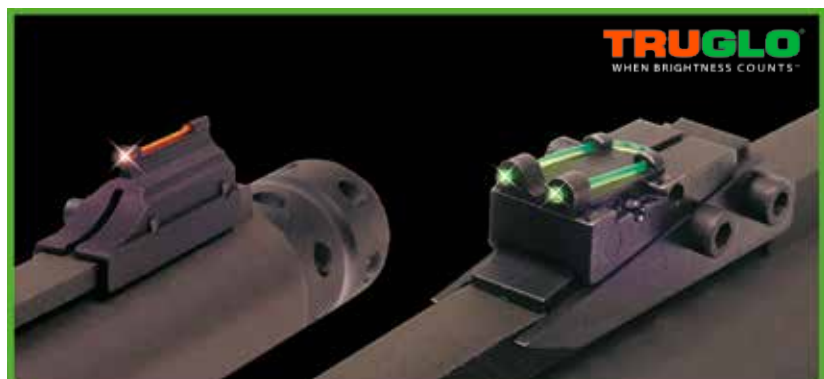

PRO SERIES MAGNUM GOBBLE DOT™
Fiber optics to screw-on, Bead in metal frame, to screw-on,
Ø 0,75 mm front, Ø 0,9 mm rear
37511-01 for Beretta, Franchi, Browning Gold/A-5, Winchester SX3 models,
6 mm rib
37511-02 for Benelli Super Black Eagle/M1/Nova, Browning BPS / Ruger Red
Label, Stoeger model 2000, Savage models, 8 mm rib
37511-03 for Remington models, 1/4" rib

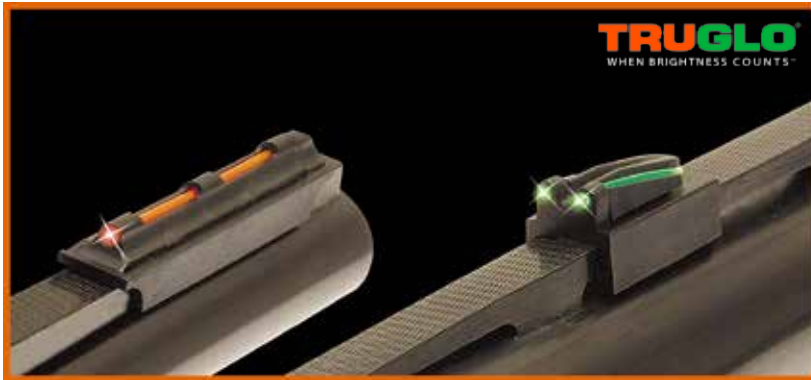

MAGNUM GOBBLE DOT™

Fiber-optics to snap-on, Ø 1,5 mm front, Ø 0,9 mm rear

- 37512-01** for 6 mm rib, Beretta Field Grade, Benelli 20 ga., Browning Gold/A-5, Franchi, Winchester SX3 models
- 37512-02** for 5/16" rib, Benelli, Browning BPS, Ithaca, Ruger Red Label, Savage und 8 mm ribs
- 37512-03** for 1/4" rib, Remington, Browning Gold, Charles Daly
- 37512-04** for 3/8" rib, Moosberg, Weatherby, Winchester (without SX3)



GLO DOT™ XTREME UNIVERSAL

Set of 4 sights, fit all rib widths, with 4 exchangeable fibers (red, green, yellow, orange), including 2 sets of magnets

37505-01



GLO DOT™

Universal for all ventilated rib shotguns, fits all rib widths, for glue-on or screw-on

- 37502-01** red **37502-02** green



GLO DOT™ fiber-optics

Universal for all rib widths, for glue-on, dual color, Ø 3mm

37502-06



GLO DOT™ II

Especially for plain barrel shotguns in 12, 16, 20 gauge, easy installation

- 37502-03** red **37502-04** green



GLO DOT™ Universal Pro Series

Universal for all rib widths, for glue-on, Ø 2mm. Color Dot is only visible in correct sight line.

- 37502-07** green **37502-08** red



TRU BEAD™ fiber-optics

Universal for all rib widths, for screw-on, dual color, Ø 3mm

37502-05





MAGNUM GLO DOT™, Ø 1,5 mm, for clip-on, available for different rib widths

- 37503-01** 1/4" red
- 37503-02** 1/4" green
- 37503-03** 5/16" red
- 37503-04** 5/16" green
- 37503-05** 3/8" red
- 37503-06** 3/8" green



MAGNUM GLO DOT™

Ø 1,5 mm, magnetic model, for different rib widths

- 37503-11** 1/4" red
- 37503-12** 1/4" green
- 37503-15** 3/8" red
- 37503-16** 3/8" green



FAT BEAD™

Bead in metal frame, to screw-on, different threads available, 13 mm long, Ø 2,5 mm

- 37506-01** red, thread M 2,6 mm
- 37506-02** green, thread M 2,6 mm
- 37506-03** red, thread M 3 mm
- 37506-04** green, thread M 3 mm
- 37506-06** red, thread M 2,6 mm 3 mm, 5-40, 6-48



FAT BEAD™ dual color

Universal with 5 different size mounting screws, 13 mm long, Ø 3mm

37506-05



LONG BEAD™, Bead in metal frame, to screw-on, different threads available, 13 mm long, Ø 2mm

- 37507-01** red, thread M 2,6 mm
- 37507-02** green, thread M 2,6 mm
- 37507-03** red, thread M 3 mm
- 37507-04** green, thread M 3 mm
- 37507-05** red, thread M 2,6 mm 3 mm, 5-40, 6-48



STARBRITE DELUXE™

Bead with metal frame, different threads available, 6,4 mm long, Ø 1,5 mm

- 37508-01** red, thread M 2,6 mm
- 37508-02** green, thread M 2,6 mm
- 37508-03** red, thread M 3 mm
- 37508-04** green, thread M 3 mm
- 37508-05** red, thread 6-48



TRU BEAD™

26 mm long, thread M 3 mm, with interchangeable fibers (red, green, yellow, orange)

- 37509-01** Ø 1,5 mm
- 37509-02** Ø 2 mm



3/8" Metal Dovetail Sights

Fiber-optics Ø 1,5 mm, fit any 3/8" standard dovetail

- 37515-01** red, height 11,5 mm
- 37515-03** red, height 12,7 mm
- 37515-05** red, height 13,5 mm
- 37515-02** green, height 11,5 mm
- 37515-04** green, height 12,7 mm
- 37515-06** green, height 13,5 mm



Airgun Dot Sight

- 37510-01** to screw in on thread M18
- 37510-02** to screw in on thread M22



Truglo Fiber-optic for Lever Action Rifles

- Ø 1,5 mm front, Ø 0,9 mm rear, for Winchester 94, Henry Golden Boy .22LR, Marlin Lever Action Guide Rifles
- 37514-02**



PAINT-KITS

- 37520-01** 5 high-visible gun sight coatings – red, white, green, orange, yellow
- 37520-02** 3 high visible and 3 luminescent gun sight coatings – green, orange, yellow



Replacement fibers

- 37513-01** 0,8 mm Ø, 13,5 cm long, 1 pc. each red, green, yellow, ruby, orange
- 37513-02** 1 mm Ø, 13,5 cm long, 1 pc. each red, green, yellow, ruby, orange
- 37513-03** 1,5 mm Ø, 13,5 cm long, 1 pc. each red, green, yellow, ruby, orange
- 37513-05** 2 mm Ø, 13,5 cm long, 1 pc. each red, green, yellow, ruby, orange
- 37513-06** 2,5 mm Ø, 13,5 cm long, 2 pcs. green, 3 pcs. ruby
- 37513-08** 2 mm Ø, 13,5 cm long, 5 pcs. dual color red/green

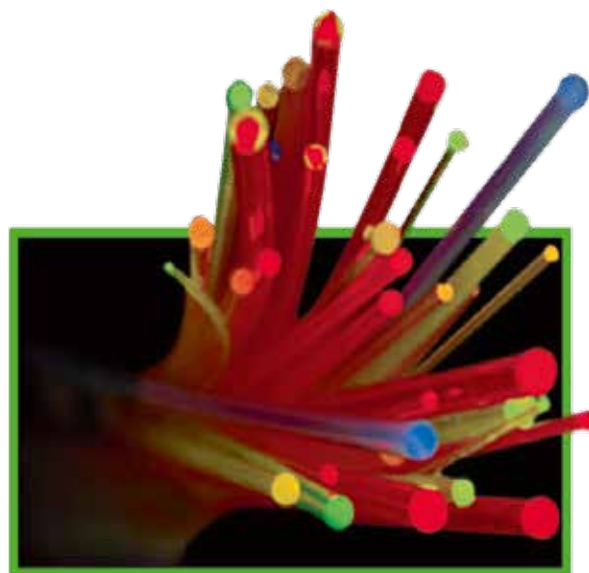

TRUGLO
WHEN BRIGHTNESS COUNTS™

MICRO-TAC™ Tactical Micro-Laser

- Next generation, high-efficiency superconductor laser diode
- Pulse and constant laser modus
- Easy ambidextrous push-button activation for left and right-handed users
- Recessed On/Off buttons eliminate accidental activation
- Automatically shuts down after 5 minutes
- Mounts to standard Weaver / Picatinny rails
- Operating temperature: -10°C to 50°C
- Weight approx. 30 g

37900-01 powerful 650 nm red laser



37900-02 powerful 520 nm green laser

TRU-POINT™ Laser-/Light Combo

- Laser located in flashlight housing
- Interchangeable back plates allow left and right-hand use
- Mounts for Weaver / Picatinny rails
- Quick-detach lever for fast and easy, tool-less removal
- Ultra-bright flashlight with 200 lumens top performance
- Operating temperature: -10°C to 50°C
- Remote control On/Off
- dimensions: 100 x 35 x 40 mm



37901-01 powerful 650 nm red laser

37901-02 powerful 520 nm green laser

TRUGLO
WHEN BRIGHTNESS COUNTS™

TRU-TEC™-Red dot sight with integrated laser

- Reticle 2MOA
- 30 mm objective lens
- High-efficiency semiconductor laser diode, latest generation
- Laser adjustable for windage and elevation
- Multiple clarity levels
- Programmable auto-off feature
- Click windage and elevation
- Wide field of view
- Fits for each eye distance
- Quick-detach lever
- Flip-up lens caps
- Shock resistant to 1000 g
- Mounts for Weaver / Picatinny rails
- Operating temperature: -10°C to 50°C
- Battery included (CR123A)

37902-01 powerful 650 nm red laser

37902-02 powerful 520 nm green laser



TRUGLO
WHEN BRIGHTNESS COUNTS™

The articles 37900-01 to 37902-02 are only made for export and can only be delivered into countries where the ownership of these devices is permitted.

Lined area for notes, consisting of 25 horizontal grey bars.



02 | GUN ACCESSORIES



Recoil Pads and Equipment	<i>Pages 40 – 45</i>
Pistol Grip Caps	<i>Page 45</i>
Carbon Stocks	<i>Page 46</i>
Receivers	<i>Page 47</i>
Bipods / Sling Swivels	<i>Page 48</i>
Gun Rests / Aiming accessories	<i>Page 49</i>
Muzzle Guards	<i>Page 50</i>
Gun Oil, Maintenance Products	<i>Pages 51 – 57</i>
Gun Cleaning	<i>Pages 58 – 65</i>
Snap Caps	<i>Page 63</i>
Gun Bags	<i>Pages 66 – 80</i>
Pistol Bags / Range-Bags	<i>Page 81</i>
Gun Cases	<i>Pages 82 – 92</i>
Cartridge Cases	<i>Page 93</i>
Ammunition Boxes	<i>Page 93</i>

hunter with dog at sunset © adrenalina.pura



Elastic Recoil Pads

Ozone- and oil-resistant rubber quality, with 2 vulcanized-in metal discs, 2 fixing screws, available in color brown and black, with vulcanized-on hard rubber base, for light guns,

130 x 43 mm, thickness 10 mm

33320-01 brown

33320-02 black

33320-33 super elastic brown

33320-34 super elastic black



Elastic Recoil Pads

Ozone- and oil-resistant rubber quality, with 2 vulcanized-in metal discs, 2 fixing screws, available in color brown and black, with vulcanized-on hard rubber base, for shotguns and close season rifles,

130 x 43 mm, thickness 15 mm

33320-03 brown

33320-04 black

33320-35 super elastic brown

33320-36 super elastic black



Elastic Recoil Pad "Trap"

brown, with vulcanized-on hard rubber base, ventilated, for shotguns and rifles, **135 x 50 mm**

33320-13 thickness 20 mm

33320-15 thickness 25 mm



Elastic Recoil Pads

Ozone- and oil-resistant rubber quality, with 2 vulcanized-in metal discs, 2 fixing screws, available in color brown and black, with vulcanized-on hard rubber base, for shotguns and rifles with medium calibers,

133 x 43 mm, thickness 20 mm

33320-05 brown

33320-06 black

33320-37 super elastic brown

33320-38 super elastic black



Elastic Recoil Pads

Ozone- and oil-resistant rubber quality, with 2 vulcanized-in metal discs, 2 fixing screws, available in color brown and black, with vulcanized-on hard rubber base, for big caliber rifles,

133 x 43 mm, thickness 25 mm

33320-07 brown

33320-08 black



Elastic Recoil Pad "Trap"

black, with vulcanized-on hard rubber base, ventilated, for shotguns and rifles, **135 x 50 mm**

33320-14 thickness 20 mm

33320-16 thickness 25 mm



Elastic Recoil Pads

"Old English" with leathery surface texture, ozone- and oil-resistant rubber quality, inner honeycombs with vulcanized-in metal sheet, 2 fixing screws, for shotguns and rifles,

136 x 44 mm, brown

33320-21 17 mm

33320-39 17 mm, super elastic

139 x 47 mm, brown

33320-23 17 mm

33320-41 17 mm, super elastic



Elastic Recoil Pads

"Old English" with leathery surface texture, ozone- and oil-resistant rubber quality, inner honeycombs with vulcanized-in metal sheet, 2 fixing screws, for shotguns and rifles,

136 x 44 mm, black

33320-22 17 mm

33320-40 17 mm, super elastic

139 x 47 mm, black

33320-24 17 mm

33320-42 17 mm, super elastic



Elastic Recoil Pads

"Old English" with leathery surface texture, ozone- and oil-resistant rubber quality, inner honeycombs with vulcanized-in metal sheet, 2 fixing screws, for shotguns and rifles,

139 x 47 mm

33320-31 27 mm, brown

33320-32 27 mm, black

139 x 47 mm, super elastic

33320-43 27 mm, brown

33320-44 27 mm, black





Elastic Recoil Pads "adjustable"

black, with vulcanized-on hard rubber base, complete with base plate and mounted rail, for Steyr and Diana models, **125 x 38 mm**

- 33320-48** 27 mm, incl. 10 mm base plate
- 33320-49** 32 mm, incl. 15 mm base plate



Full Recoil Pads

Ozone- and oil-resistant, with vulcanized-in metal sheet, 2 fixing screws, with black base plate, inner honeycombs, **150 x 52 mm**

- 33320-09** 15 mm, brown
- 33320-10** 15 mm, black
- 33320-11** 30 mm, brown
- 33320-12** 30 mm, black



Slip Recoil Pads

for fast aiming, ozone- and oil-resistant, with vulcanized-in metal sheet, 2 fixing screws, with at upper side raised base plate, inner honeycombs, **150 x 52 mm**

- 33320-17** 15 mm, brown
- 33320-18** 15 mm, black
- 33320-19** 30 mm, brown
- 33320-20** 30 mm, black



Recoil Pads

with vulcanized hard rubber base, **140 x 46 mm**

- 33320-60** 10 mm, brown
- 33320-61** 10 mm, black



Recoil Pads

with vulcanized hard rubber base, **140 x 46 mm**

- 33320-62** 15 mm, brown
- 33320-63** 15 mm, black



Recoil Pads

with vulcanized hard rubber base, **140 x 46 mm**

- 33320-64** 20 mm, brown
- 33320-65** 20 mm, black



Recoil Pads

with vulcanized hard rubber base, **140 x 46 mm**

- 33320-66** 25 mm, brown
- 33320-67** 25 mm, black



Recoil Pads

with vulcanized hard rubber base, **140 x 46 mm**

- 33320-68** 15 mm, brown
- 33320-69** 15 mm, black



Recoil Pads

with vulcanized hard rubber base, **140 x 46 mm**

- 33320-70** 25 mm, brown
- 33320-71** 25 mm, black



Recoil Pads
with vulcanized hard rubber base,
140 x 46 mm
33320-72 17 mm, brown
33320-73 17 mm, black



Recoil Pads
with vulcanized hard rubber base,
140 x 46 mm
33320-74 20 mm, brown
33320-75 20 mm, black



Recoil Pads
with vulcanized hard rubber base,
140 x 46 mm
33320-76 25 mm, brown
33320-77 25 mm, black
33320-78 30 mm, brown
33320-79 30 mm, black



Recoil Pads
with vulcanized hard rubber base,
140 x 46 mm
33320-80 15 mm, brown
33320*80 15 mm, red
33320-81 15 mm, black
33320-82 20 mm, brown
33320*82 20 mm, red
33320-83 20 mm, black

MicroCell Recoil Pads, Expansion Hi-Tech Polymer

- 50 – 60% lighter
- high absorbing ability
- extreme low deformation during shot
- elastic recovery
- grindable



**Soft (Density 45 – 50 %),
45 x 146 mm**
33319-70 15 mm, brown
33319-71 15 mm, black
33319-72 23 mm, brown
33319-73 23 mm, black

The expansion Hi-Tech Polymer consists of a micro air bubbles structure, which keeps its form during compression without getting wider or deforming.



**Extra Soft (Density 30 – 35 %),
45 x 146 mm**
33319-74 15 mm, brown
33319-75 15 mm, black
33319-76 23 mm, brown
33319-77 23 mm, black



Exchangeable Slip Recoil Pads
Super Elastic (Shore A-hardness 35°),
with raised base, soft rubber, black
139 x 47 mm **150 x 50 mm**
33319-50 **33319-60** 19 mm
33319-51 **33319-61** 25 mm
33319-52 **33319-62** 32 mm
33319-53 **33319-63** 38 mm



Exchangeable Universal Recoil Pads
The recoil pad is slit and can be mounted with 2 screws or with the Quick-Loc-System, which provides fast exchange of all exchangeable recoil pad models. Soft rubber, black
139 x 47 mm **150 x 50 mm**
33319-30 **33319-40** 19 mm
33319-31 **33319-41** 25 mm
33319-32 **33319-42** 32 mm
33319-33 **33319-43** 38 mm

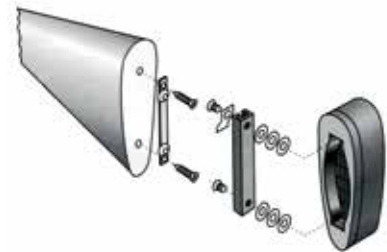

Quick-Loc™-Installation
• only for Universal WEGU-GFT recoil pads
• easy and fast mounting; guaranteed firm fit, fast exchange between all sizes
33319-34 complete Set
33319-35 without stock rail for follow-up mount





Intermediate Layer
white
33318-11 1 mm



Intermediate Layer for Stock Extension
hard rubber, easy grindable and polishable, black
33319-04 4 mm
33319-06 6 mm
33319-08 8 mm
33319-12 12 mm
33319-24 24 mm



Stock Extension
with end profile, hard rubber, grindable and polishable, black
33320-25 10 mm
33320-26 20 mm
33320-27 30 mm



Stock End Profile
hard rubber, with 2 holes for fixing screws, grindable and polishable, black
33320-28 8 mm



Through the special design Limbsaver Recoil Pads reach a maximum of recoil reduction. Especially recommended for guns with extreme recoil power. Available in screw-mountable version or as Slip-On-Pad.

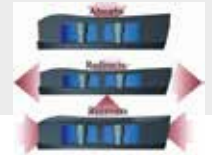

Limbsaver Recoil Pads
recoil will be reduced to the half
33320-84 125 x 49 x 25 mm
33320-85 130 x 49 x 25 mm
33320-86 143 x 54 x 25 mm
33320-88 138 x 49 x 15 mm

33320-89 130 x 40 x 15 mm, for Blaser® R8
33320-90 125 x 40 x 15 mm, for Blaser® R93
33320-91 123 x 40 x 30 mm, for Sako® and Tikka®



Limbsaver Recoil Pads
Trap and Skeet
33319-81 125 x 49 x 25 mm
33319-82 130 x 49 x 25 mm
33319-83 143 x 54 x 25 mm



Limbsaver Slip-On Recoil Pads
thickness 25 mm
33320-96 130 x 45 mm
33320-97 135 x 50 mm
33320-98 145 x 50 mm



Slip-On Recoil pads
rubber, thickness 10 mm
brown black
33320-92 33321-92 128 x 39 mm
33320-93 33321-93 130 x 42 mm
33320-94 33321-94 135 x 49 mm
33320-95 33321-95 134 x 42 mm



Slip-On Recoil Pad
leather, elasticated, thickness 20 mm
33320-99 140 x 45 mm



Stock Riser

rubber

brown

black

33317-01

33317-04

5 mm

33317-02

33317-05

10 mm

33317-03

33317-06

15 mm



KalixTeknik CR2 – Stock Riser for Backfitting

for wooden stocks, low weight – 80 g, easy mounting

38401-01



KalixTeknik CR1 – Stock Riser for Backfitting

for synthetic stocks, low weight – 100 g, easy mounting

- 38400-01 Tikka** T1x, T3x Battue Lite, T3x Camo Stainless, T3x Compact, T3x Lite, T3x Lite Stainless, T3x Varmint, T3x Varmint Stainless, T3 Battue Lite, T3 Camo Stainless, T3 Lite, T3 Lite Stainless, T3 Varmint
- 38400-02 Blaser** R93 Professional Right
- 38400-04 Blaser** R8 Professional
- 38400-05 Sauer** 100 Classic XT, 101 Classic XT, 101 Forest XT, 202 Classic XTR, 202 Classic XTL, 303 Classic XT Green, 303 Classic XT Brown, 303 Hardwood, 303 Black Velvet, 404 Classic XT
- 38400-06 Steyr** Mannlicher SM 12 SX, Mannlicher CL II SX
- 38400-07 CZ** 455 Synthetic, 527 Synthetic
- 38400-08 Merkel** Helix Rx, Helix Rx Tracker, Helix Explorer, Helix Tracker OR Camo
- 38400-09 Ruger** American Standard, American Compact, American All-Weather, American All-weather compact, American Ranch, American Predator
- 38400-10 Haenel** Jaeger 10 Stainless AW, Jaeger 10 Varmint, Jaeger 10 Tracker, Jaeger 10 Mountain LT, Jaeger 10 Camouflage OR, Jaeger 10 Camouflage TR, Jaeger 10 Standard Synthetic
- 38400-11 Mauser** Mauser I2 Extreme, Trail, Mauser I8 Impact, S, Mauser O3 Extreme Trail, Africa ph





Reusable Dehumidifiers
for gun safes and equipment,
with humidity indicator, can be
regenerated in the microwave,
2 x 200 g, approx. 12x10 cm, PU 12
33329-30



Finger Protection
for trigger guard
33317-11 clamp-fixing



Finger Protection
for trigger guard
33317-12 screw-fixing



Pistol Grip Cap
black, with hole for fixing screw
33320-29 46 x 32,5 mm
33320-30 50 x 38 mm



Pistol Grip Base Buffalo Horn
for metal ornaments
33320-59 52 x 38 mm



**Ornaments
for Pistol Grip**
Real Silver, patinated
40 x 26,5 mm
33320-50 plain



**Ornaments
for Pistol Grip**
Real Silver, patinated
40 x 26,5 mm
33320-51 oak leaves



**Ornaments
for Pistol Grip**
Real Silver, patinated
40 x 26,5 mm
33320-53 red deer



**Ornaments
for Pistol Grip**
Real Silver, patinated
40 x 26,5 mm
33320-54 roebuck



**Ornaments
for Pistol Grip**
Real Silver, patinated
40 x 26,5 mm
33320-55 wild boar



**Ornaments
for Pistol Grip**
Real Silver, patinated
40 x 26,5 mm
33320-56 chamois

Rubber Ball for Bolt
33320-57 „Tactical“ for rifles with
round or cylindric bolt
33320-58 „Speed“ for Blaser
R93 and R8

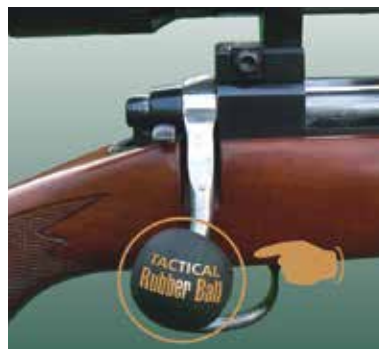



Carbon thumbhole stock for R8, Standard barrel, 17 mm barrel Ø

Bipod and receivers not included, weight: from 900 g

38410-01 with sling swivel screw

38410-02 with sling swivel screw and adapter for Harris bipod and Picatinny rail

38410-03 with socket for push-button sling swivel and mounting for Spartan bipod

Carbon thumbhole stock for R8, Semi-Weight-Barrel, 19 mm barrel Ø

38410-11 with sling swivel screw

38410-12 with sling swivel screw and adapter for Harris bipod and Picatinny rail



Carbon thumbhole stock for R93, Standard barrel, 17 mm barrel Ø

Bipod and receivers not included, weight: from 900 g

38411-01 with sling swivel screw

38411-02 with sling swivel screw and adapter for Harris bipod and Picatinny rail

38411-03 with socket for push-button sling swivel and mounting for Spartan bipod

Carbon thumbhole stock for R93, Semi-Weight-Barrel, 19 mm barrel Ø

38411-11 with sling swivel screw

38411-12 with sling swivel screw and adapter for Harris bipod and Picatinny rail



Carbon standard stock for R8, Standard barrel, 17 mm barrel Ø

Bipod and receivers not included, weight: from 600 g

38412-01 with sling swivel screw

38412-02 with sling swivel screw and adapter for Harris bipod and Picatinny rail

38412-03 with socket for push-button sling swivel and mounting for Spartan bipod

Carbon standard stock for R8, Semi-Weight-Barrel, 19 mm barrel Ø

38412-11 with sling swivel screw

38412-12 with sling swivel screw and adapter for Harris bipod and Picatinny rail



Negele Receivers compatible with R93



Inline receiver for 1-part stocks
38501-01



Finline receiver without side plates, for 2-part stocks*
38501-02



Art Cover receiver prepared for side plates, for 2-part stocks*
38501-03

* Only available with
38501-13 Black Edition!



Stocks, fitting for Negele Receivers

- 38500-01** Standard full stock 1-part with „Inline“ receiver
- 38500-02** Thumbhole 1-part with „Inline“ receiver
- 38500-03** Standard stock 2-part with „Finline“ receiver*
- 38500-04** Thumbhole 2-part with „Finline“ receiver*
- 38500-05** Standard stock 2-part with „Art Cover“ receiver with side plates*
- 38500-06** Thumbhole stock 2-part with „Art Cover“ receiver with side plates*

- 38500-12** Surcharge for stock wood class 2
- 38500-13** Surcharge for stock wood class 3
- 38500-14** Surcharge for stock wood class 4
- 38500-15** Surcharge for stock wood class 5

Surcharges for Special Equipment

- 38501-10** Set fixing screws for 2-part stocks
- 38501-11** Side plates flat, Alu blank or standard color
- 38501-12** Side plates flat, Alu „Black Edition“
- 38501-13** „Black Edition“/ black receiver
- 38501-14** Lock protection titan-nitrified
- 38501-15** Steering plate titan-nitrified
- 38501-21** Trigger, gold-colored satin-gloss
- 38501-22** Trigger, gold-colored mat
- 38501-23** Trigger, Hunt-Match with reduced trigger weight
- 38501-24** Trigger, pure titan titan-nitrified mat
- 38501-25** Trigger, pure titan titan-nitrified glossy
- 38501-26** Trigger, pure titan DLC Coat glossy
- 38501-27** Trigger, Hunt-Match low trigger weight



Gun-Bipod

with retaining clip for sling swivel stud, with telescopic legs, adjustable in several levels

- 34322-24** 150 – 230 mm, 290 g
- 34322-25** 230 – 330 mm, 351 g



Gun-Bipod

with support for Picatinny/Weaver rail, additional support for sling swivel stud, with telescopic legs

- 34322-26** 150 – 200 mm, 320 g
- 34322-27** 200 – 330 mm, 390 g



Gun-Bipod

with swivel head, telescopic legs, easy height adjustment, legs foldable

- 34322-22** 15 - 23 cm, weight 350 g
- 34322-23** 23 - 33 cm, weight 400 g



Gun Bipod

Telescopic legs of carbon fiber, extra light, stiff, with retaining clip for sling swivel stud

- 34322-28** 150 – 230 mm, weight 256 g
- 34322-29** 230 – 330 mm, weight 303 g



Gun Bipod

with double swivel head, 60° swiveling + lateral overturning, retaining clip for sling swivel stud and telescopic legs adjustable in several levels

- 34322-30** 150 – 230 mm, weight 409 g
- 34322-31** 230 – 330 mm, weight 463 g



Sling Swivel Screw

- 38605-01** Set of 12 pcs, Thread Length 1/2" (12,7 mm)
- 38605-02** Set of 12 pcs, Thread Length 3/4" (19,05 mm)
- 38605-03** Set of 48 pcs, Thread Length 3/4" (19,05 mm)



Sling Swivel

for European sling swivel base

- 38600-01** Set in blister
- 38600-11** single, PU 10

for US sling swivel base

- 38600-02** Set in Blister
- 38600-12** single, PU 10



Push-Button Sling Swivel

- Set with socket, in blister
- 38600-03**





Gun Barrel Rest

genuine leather, brown, fillable with sand, delivered empty
33303-13 13 x 13 x 13 cm



Gun Stock Rest

genuine leather, brown, fillable with sand, delivered empty
33303-14 16 x 12 x 13 cm



Hunting Gun Rest

genuine leather, brown, fillable with sand, delivered empty
33303-12 15 x 15 cm



Gun Rest Set

Barrel and stock rest delivered empty, upper side suede leather, bottom part Nylon
 Size barrel rest: 23 x 10 x 19 cm
 Size stock rest: 15 x 12 x 11 cm
33303-15



Hunting Gun Rest

Nubuk leather, filled
33303-16 15 x 15 cm



Gun Rest

3-legged, with padded bag rest, height adjustable from 16 to 34 cm, weight 940 g, can also be used as table tripod
33303-04



Gun support X-Block

Fitting for 4 different stock forms, 20 x 15 cm
33303-02 160 g



Gun support

3-part, 19 x 19,5 cm
33303-03 278 g



Shooting Range Gun Rest

3-leg with leather bag rest, filled, height adjustable
33303-01 32 x 32 x 15 cm

Gun and shooting rest

Device for focusing of guns, of powder coated steel, foldable, length 45 - 80 cm
33303-11



Gun and shooting rest

Device for focusing of guns
33303-08 60 cm long





Gun Plugs

for closing the muzzle, will be blown out at the shot through air pressure, suit for calibers 7 mm – 9,3 mm

33693-01 10 pcs., red/yellow assorted

33693-02 10 pcs., bio-degradable



Muzzle Guard, genuine Leather
32399-01 for repeating rifle



Muzzle Guard, genuine Leather
32399-03 for over and under shotgun



Muzzle Guard, genuine Leather
32399-05 for side by side shotgun



Muzzle Guard, genuine Leather
32399-09 for over and under rifle



Muzzle Guard, genuine Leather
32399-11 for Drilling 12 gauge



Muzzle Guard, genuine Leather
32399-12 for Drilling 16 gauge



Muzzle Guard, genuine Leather
32399-21 for repeating rifle
with high front sight



Muzzle Guard, genuine Leather
32399-22 for Blaser Drilling



Muzzle Guard
Leather with Loden
32399-51 for repeating rifle



Muzzle Guard
Leather with Loden
32399-52 for over and under rifle



Muzzle Guard
Leather with Loden
32399-53 for side by side shotgun



Muzzle Guard
Leather with Loden
32399-54 for Drilling



Muzzle Guard
Leather with Loden
32399-55 for over and under shot-
gun rifle 12 and 16 gauge
32399-58 for over and under shot-
gun rifle 20 gauge



Muzzle Guard
Leather with Loden
32399-56 for repeating rifle
with high front sight



Muzzle Guard
Leather with Loden
32399-57 for Blaser Semi Weight
Barrel Ø 19 mm



Brunox Turbo-Spray®

Swiss quality gun cleaning product for sporting, hunting, muzzleloader, military, and collector guns

- solves powder / lead / copper / tombac and nickel residues
- protects against corrosion
- displaces moisture
- absorbs hand sweat
- lubricates all parts
- free of Silicone, PTFE and Graphite

33514-01 100 ml Pump Spray PU 20

33514-02 300 ml Spray PU 12

33514-03 100 ml Liquid PU 12

33514-04 5 Liter Can

33514-22 5 pcs. Brunox maintenance cloths PU 12



1 + 2 + 3

Brunox LUB&COR®

High-Tech lubrication and corrosion protection especially for longtime conservation

- high-value, very resilient lubricant
- no rinsing, all-weatherproof
- lubrication down to -41°C
- adhering corrosion protection
- corrosion protection up to 3 years (indoor storage)

33514-11 100 ml Liquid PU 12

33514-12 400 ml Spray PU 6



1

Brunox Hunter-Set

Content: 120 ml Pump Spray, 100 ml Lub&Cor, 120 ml Lubri-Food Spray

33514-21



Brunox Lubri-Food

High-Tech-Multi-Spray for food industrie, especially for knives and machines for meat processing

- food-safe
- lubrication between -20°C and +125°C
- free of Silicone, PTFE, Graphite and Acids
- homogenous lubrication film supersedes any moisture
- neutral against lacquer, rubber, plastics
- no spots or residue on materials
- maintains stainless steel and avoids fingerprints
- odorless and neutral in taste

33514-13 120 ml Pump Spray PU 12

33514-14 400 ml Spray PU 6



ADDINOL Gun Oil W 18

Liquid based on hydrocarbons and carboxylic acid esters, which contents additives for improving corrosion and wear protection features.

Operating range: -55°C - +150°C.

Outstandingly suitable for lubrication, conservation and cleaning of various gun systems.

- high corrosion protection
- good miscibility with mineral oils and most common solvents
- no components with intensive odor
- no formation of residue

33511-01 150 ml Spray PU 12



Ballistol Universal oil

- | | | |
|-----------------|---------------------------|-------|
| 33500-01 | 100 ml Spray | PU 20 |
| 33500-02 | 200 ml Spray | PU 20 |
| 33500-03 | 50 ml, Liquid | PU 20 |
| 33500-04 | 500 ml, Liquid | PU 12 |
| 33500-05 | 50 ml Spray | PU 20 |
| 33500-07 | 15 ml Oil-Pen, refillable | PU 20 |
| 33500-17 | 10 Oil-cloths | PU 20 |
| 33500-18 | 400 ml Spray | PU 12 |
| 33500-26 | 5 Liter, Liquid | |



Ballistol-Display

33500-10 9 units Ballistol 200ml, 9 units Ballistol 50ml



Ballistol Universal Oil with Vario-Flex, 350 ml

- Flexible tube, length 12,5 cm
- Reaches easily inaccessible corners
- Can be dosed very finely to the point

33500-13 VE12



Ballistol Can Safe

Tendency of burglary is increasing. A reason, to hide personal belongings. A whizzy secret hiding-place is the disguised Can Safe. It cannot be distinguished from the original can, but contents a secret compartment.

33500-40 PU 12



Ballistol Universalschnaps

as a spitting image of the original Ballistol Oil, this fire-apple liquor (25% vol.) is a funny promotional item.

33500-50





2+3+4

2+3+4+5

Ballistol Gun Blueing
33502-02 50 ml PU 20

Ballistol Nerofor

Antique dyer for non-ferrous metals
33502-03 50 ml PU 20



Ballistol Gun Blueing Set

Content:

- Ballistol Spray 50 ml
 - Robla Degreaser Spray 50 ml
 - KLEVER Gun Blueing 50 ml
 - 2 pairs safety gloves
 - 2 brushes
 - 2 cloths
- 33502-04

1+2+3



Ballistol Vaseline Gun-Grease

Resin- and acid-free gun grease for lubricating and greasing all movable parts. Perfect also for the compression piston of air rifles.
33503-04 70 g PU 6



2+4

Ballistol Robla Barrel Cleaner
33503-09 65 ml PU 12
33503-10 1 Liter

1+4



Ballistol Robla Blackpowder Solvent
33503-06 200 ml Spray PU 12



1+2+3

Ballistol Robla Degreaser
33503-07 200 ml Spray PU 12
33503-08 50 ml PU 20

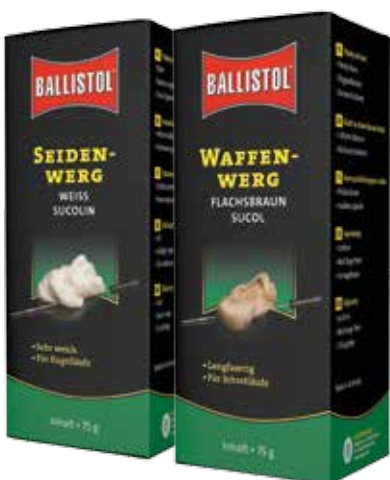

Ballistol Sucol und Sucolin Oakum, 75 g
for cleaning and polishing of barrels
33698-05 for shotguns, brown
33698-06 for rifles, white

1



Ballistol Balsin Stock Oil

- 33504-04 50 ml, dark PU 20
- 33504-05 50 ml, red brown PU 20
- 33504-06 50 ml, light PU 20
- 33504-14 500 ml, dark PU 20
- 33504-15 500 ml, red brown PU 20
- 33504-16 500 ml, light PU 20

1 + 2 + 3 + 4



Ballistol Gun-Care Set, with 12 important components for gun maintenance, size: 33 x 27 x 7 cm
Content:

- 1 x BALLISTOL Spry 200 ml, 1 x KLEVER Gun Blueing 50 ml,
- 1 x Robla Degreaser 50ml, 1 x GUNEX Spray 50 ml,
- 1 x Balsin Stock Oil light 50 ml, 1 x Robla Solo Mil 65 ml,
- 1 x Sucolin oakum, 3 x brush, 2x cloth

33500-16

1 + 2 + 3



Gun Care Set

- Content: Ballistol Universal Oil spray 100 ml, Robla Solo MIL barrel cleaner 65 ml, GunCer ceramic gun grease 10 g, Oil-Pen 15 ml, 5 Oil Cloths, Cleaning instruments, Cleaning brush, Cloth, Gun care manual, Ballistol story

33500-15

1 + 2



Weapon parts cleaner spray 250 ml

Cleans and degreases reliably all weapon parts. with clip-on brush of stable nylon bristles. Aceton-free
33503-12 PU 6

4



Plastics Cleaner Set

150 ml Pump spray with microfibre cloth
33503-13 PU 6

4



Plastics Cleaner

150 ml Pump spray
33503-14 PU 12

2



Silencer Cleaner

33503-15 500 ml, PU 6
33503-16 5 Liters



Set of 3 Rubber Plugs

5 x 9 x 20 mm,
8 x 12 x 20 mm,
10,5 x 14,5 x 20 mm
33503-17





Gun Oil m4

longtime corrosion protection, excellent cleaning features, no resinifying, removing surface rust easily
33513-02 200 ml Spray PU 12

1 + 2



Motorex Gun Oil GUN CARE

Swiss Top Product, cleans, lubricates and conserves all metal parts for long time. Dissolves powder residue and protects against rust. Supersedes moisture and prevents corrosion through hand sweat.
33515-04 300 ml Spray PU 12

4



GunTec Gun Oil

removes powder and gunshot residues, high corrosion protection, supersedes moisture, reduces friction, odorless, free of aromatic compounds
33508-01 50 ml Oil PU 15
33508-02 50 ml Spray PU 20
33508-03 200 ml Spray PU 20



GunTec Gun Grease

synthetic grease with white solid lubricant, reduces friction and attrition
33508-04 20 g, Tube PU 20
33508-05 70 g, Can PU 4

1 + 2



GunCer Gun Oil

Gun tuning with ceramic additives, reduces attrition, perfect corrosion protection
33507-05 50 ml, Spray PU 12
33507-06 200 ml, Spray PU 12
33507-07 65 ml, Liquid PU 12
33507-08 10 g, Gun Gease PU 10

1 + 5



Gunex Gun Oil

with extraordinary rust protection
33507-01 50 ml, Liquid PU 20
33507-02 200 ml, Spray PU 12
33507-03 400 ml, Spray PU 12
33507-04 500 ml, Liquid PU 12
33507-10 50 ml, Spray PU 20



GunTec Plastic Cleaner

active cleaner for all plastic surfaces and parts in the gun area
 250 ml Spray, PU 12
33508-07

1



PTFE (Teflon®)-Spray

Dry lubrication for all movable parts. Perfect for the bolt assembly. No smear through oil residue. Teflon® is a registered trademark by DuPont.
 200 ml Spray, PU 12
33503-02

1 + 2 + 3



Silicone Spray

Lubricates and protects rubber, polymer, plastic and metal parts. Ideal for plastic hinges, zippers, rubber seals and rubber boots.
 200 ml Spray, PU 12
33503-03

1



Compressed Gas Cleaner

Special gas, very yielding, removes dirt and dust at spots difficult to reach
 300 ml Spray, PU 6
33503-11



Schaftol-Stock Oil, PU 12
33509-01 50 ml bottle, dark



Schaftol-Stock Oil, PU 12
33509-02 50 ml bottle, extra dark



Schaftol-Stock Oil, PU 12
33509-03 50 ml bottle, red brown



Schaftol-Stock Oil, PU 12
33509-04 50 ml bottle, light



Schaftol-Stock Oil, PU 12
33509-05 50 ml bottle,
Universal Premium Gold



GunCer Gun Grease, PU 10
33507-08 10 g

Schaftol Stock Oil

- 500 ml Can
- 33509-11 dark
- 33509-12 extra dark
- 33509-13 red brown
- 33509-14 light
- 33509-15 Universal Premium Gold



Ballistol-Animal
33500-06 100 ml PU 20
33500-08 500 ml PU 12
33500-09 5 Liter

Neo-Ballistol Skin- and Wound-Care

- Regenerates skin and makes it soft and smooth. Small wounds get disinfected and assists cure.
- 33500-11 100 ml PU 20
 - 33500-12 250 ml PU 9





2

Ballistol KAMOFIX – powerful cleaner

- for fireplace, stove, pots, baking plates, grills
- for surface and grillage
- foams, no drops
- operates immediately – no reaction time
- cleans intensively without scrubbing
- bio-degradable
- perfect for stable plastics for removing rain slides

600 ml Pumpspray
33500-30 PU 6



1 + 2 + 4

Ballistol Test Winner Set

Content: GUNEX Gun Oil Spray 200 ml, Robla Solo Mil 65 ml, BALLISTOL Oil 50 ml, Ballistol Story, Cloth, Gun cleaning-Flyer, Test report
 size: 16,5 x 26 x 6,5 cm
33500-27



5



FLITZ metal polish and care products

FLITZ cleans, polishes and protects: brass, copper, bronze, silver, gold, pewter, chrome, stainless steel, aluminum, magnesium, nickel, platinum, anodized aluminum, factory-blued gun parts, fiber glass, plexiglass, acryl and varnished surfaces, removes rust, corrosion, lime scale, water spots, oxidation, lead- and powder residue, fingerprints

- 33516-03** 50 g-Tube/Blister, PU 20
- 33516-07** 150 g-Tube/Blister, PU 10
- 33516-04** liquid polish 100 ml, can be used as tumbler media additive, PU 12

5



Ballistol Trap Oil
 65 ml, PU 10
33500-34



Ballistol Pluvonin- Impregnation Spray
 500 ml, PU 12
33505-01 1 + 2 + 3

5



FLITZ Bore Cleaner
 33516-05 225 ml, PU 6

5



FLITZ Tumbler/Media Additive
 33516-06 225 ml, PU 6



Cleaning Set, for Shotguns/Rifles, in plastic box

33602-01 12 gauge	33602-06 7 mm	33602-15 6 mm	Combined Shotgun/Rifle
33602-02 16 gauge	33602-07 8 mm	33602-16 8,5 mm	
33602-03 20 gauge	33602-08 9,3 mm	33602-24 4,5 mm,	
33602-04 4,5 mm	33602-13 7,62 mm	with 4-part cleaning rod 1 m	
33602-05 .22	33602-14 6,5 mm	33602-25 .22, with 4-part cleaning rod 1 m	
		33602-09 12GA/7 mm	
		33602-10 12GA/8 mm	
		33602-12 16GA/8 mm	



Cleaning Set, for shotguns,
with wooden cleaning rod without handle

- 33605-01** 12 gauge
- 33605-02** 16 gauge
- 33605-03** 20 gauge



Cleaning Set
11-part, in plastic case
33603-01 12 gauge



Universal Cleaning Set
for shotguns, rifles and pistols, in wooden box
33603-05 12 gauge, 7 mm and 9 mm





Special Tool
for disassembling Glock pistols
33351-01



Special Tool
for opening the clip of Glock magazines
33351-02



Cleaning Rope

- for Shotguns/Rifles
- | | |
|--------------------------|-------------------------|
| 33608-01 12 gauge | 33608-07 7 mm |
| 33608-02 16 gauge | 33608-08 8 mm |
| 33608-03 20 gauge | 33608-09 9,3 mm |
| 33608-04 4,5 mm | 33608-10 6,5 mm |
| 33608-05 .22 | 33608-11 7,5 mm |
| 33608-06 6 mm | 33608-12 10,3 mm |

- for Pistols
- | | |
|----------------------|---------------------|
| 33628-02 9 mm | 33628-03 .45 |
|----------------------|---------------------|



- Cleaning Set**
for Pistols, 4-part
- | | |
|------------------------|--------------------------|
| 33621-00 4,5 mm | 33621-03 7,65 |
| 33621-01 .22 | 33621-04 9 mm/.38 |
| 33621-02 6,35 | 33621-06 .45 |



- Cleaning Set compact**
for Pistols
- | | |
|----------------------|--------------------------|
| 33624-01 .22 | 33624-04 9 mm/.38 |
| 33624-02 6,35 | 33624-06 .45 |
| 33624-03 7,65 | |



- Cleaning Set**
for Pistols, in plastic box
- | | |
|------------------------|--------------------------|
| 33623-00 4,5 mm | 33623-03 7,65 |
| 33623-01 .22 | 33623-04 9 mm/.38 |
| 33623-02 6,35 | 33623-06 .45 |



Ballistol Weapon Cleaning Instruments
33697-01



Gun cleaning rack
Dismountable, size 44 x 16 x 22 cm
33303-09



Cleaning Rod, steel with plastic coating, plastic handle, for rifles
33650-01 4 mm, 85 cm long PU 5



Cleaning Rod, steel with plastic coating, plastic handle, for rifles
33650-21 4 mm, 100 cm long PU 5 **33650-22** 5 mm, 100 cm long PU 5



Cleaning Rod, steel with plastic coating, plastic handle, for rifles
33650-02 5 mm, 80 cm long PU 5



Cleaning Rod, steel with plastic coating, plastic handle, for shotguns
33650-03 7 mm, 90 cm long PU 5



Cleaning Rod, wood with handle, for shotguns
33650-04 90 cm long PU 5



Cleaning Rod, wood without handle, for shotguns
33650-05 85 cm long PU 5



Steel Cleaning Rod, for rifles
33650-06 74 cm long PU 5



Cleaning Rod, steel with plastic coating, with ball bearing mounted aluminum handle
33650-10 5 mm, 100 cm long PU 5 **33650-11** 6 mm, 100 cm long PU 5



Cleaning Rod, steel with plastic coating, for Pistols
33650-07 5 mm, 45 cm long PU 5 **33650-08** 5 mm, 28 cm long PU 5 **33650-09** 7 mm, 28 cm long PU 5





Cleaning Brush
12 gauge
 especially for cartridge chamber, 18 cm long
33652-03

Brush Set, 3-part

- | | |
|------------------------|------------------------|
| 33670-01 7 mm | 33670-06 6 mm |
| 33670-02 8 mm | 33670-07 6,5 mm |
| 33670-03 9 mm | 33670-08 .45 |
| 33670-04 4,5 mm | 33670-09 7,5 mm |
| 33670-05 .22 | |



Brush Set,
 3-part, with brass brush
33671-01 12 gauge
33671-02 16 gauge
33671-03 20 gauge



Brush Set,
 3-part, with steel brush
33671-11 12 gauge
33671-12 16 gauge
33671-13 20 gauge



Brush Set,
 3-part, with bronze brush
33671-21 12 gauge
33671-22 16 gauge
33671-23 20 gauge

10 Wool Brushes

- 33675-01** 12 gauge
- 33675-02** 16 gauge
- 33675-03** 20 gauge
- 33675-04** 4,5 mm
- 33675-05** .22
- 33675-06** 6 mm
- 33675-07** 7 mm
- 33675-08** 8 mm
- 33675-09** 9 mm
- 33675-10** .45
- 33675-12** 6,5 mm
- 33675-13** 7,5 mm



10 Steel Brushes

- 33676-01** 12 gauge
- 33676-02** 16 gauge
- 33676-03** 20 gauge



10 Nylon Brushes

- 33677-01** 12 gauge
- 33677-02** 16 gauge
- 33677-03** 20 gauge
- 33677-04** 4,5 mm
- 33677-05** .22
- 33677-06** 6 mm
- 33677-07** 7 mm
- 33677-08** 8 mm
- 33677-09** 9 mm
- 33677-10** .45
- 33677-12** 6,5 mm
- 33677-13** 7,5 mm



10 Brass Brushes

- 33678-01** 12 gauge
- 33678-02** 16 gauge
- 33678-03** 20 gauge
- 33678-04** 4,5 mm
- 33678-05** .22
- 33678-06** 6 mm
- 33678-07** 7 mm
- 33678-08** 8 mm
- 33678-09** 9 mm
- 33678-10** .45
- 33678-12** 6,5 mm
- 33678-13** 7,5 mm



10 Bronze Brushes

- 33679-01** 12 gauge
- 33679-02** 16 gauge
- 33679-03** 20 gauge
- 33679-04** 4,5 mm
- 33679-05** .22
- 33679-06** 6 mm
- 33679-07** 7 mm
- 33679-08** 8 mm
- 33679-09** 9 mm
- 33679-10** .45
- 33679-11** .50
- 33679-12** 6,5 mm
- 33679-13** 7,5 mm
- 33679-14** 9,5 mm



Cleaning Rod Guide

- 33651-01** .17 - .270
- 33651-02** .270 - .416





3 Bore-tips Sponge Brushes
 lint-free, washable and reusable,
 with 5/16" thread
33680-01 12 gauge
33680-03 20 gauge

6 Bore-tips Sponge Brushes
 lint-free, washable and reusable,
 with 8-32 thread
33680-05 5,56 mm/.22
33680-06 6 mm/.243
33680-07 7,5 mm/.30
33680-09 9 mm/.357



5 Bore-tips Sponge Brushes
 lint-free, washable and reusable,
 with 8-32 thread
33680-10 .45

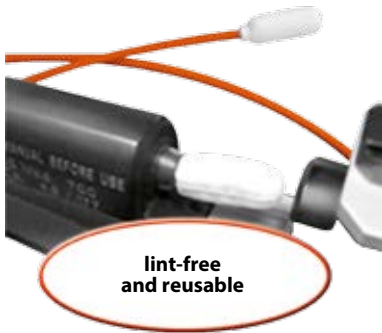

3 Bore-whips Cleaning and Safety Rope
33680-21 4,5 mm / .177
33680-22 5,56mm / .22



**24 Gun-tips
 Sponge Cleaning Sticks**
 for cleaning and lubricating hard to
 reach places
33680-31 7,5 cm pointed
33680-32 7,5 cm cylindric
33680-33 12,5 cm flat
33680-34 15 cm cylindric



**Assortment
 of 9 Gun-tips
 33680-35**



10 Patch Holder
33698-01 male thread
 for shotgun rods
33698-02 female thread
 for rifle rods



100 Cleaning Patches
33698-03 65 x 65 mm
33698-04 85 x 85 mm



10 Aluminum Jags
33698-11 4 mm
33698-12 7 mm
33698-13 9 mm



Adapters, PU 5
33699-01 1/8"/M5 male thread
33699-02 1/8"/M5 female thread
33699-03 M5/M5 male thread
33699-04 M5/M5 female thread

33699-05 M5/M4 female thread
33699-06 8 - 32/ 1/8" male thread
33699-07 8 - 32/ 1/8" female thread
 (for 33680-05 to -10)

33699-08 M5 male/ 5/16" female
 thread (for 33680-01 to 03)
33699-09 8 - 32/ M5 male thread
33699-10 8 - 32 female/ M5 male



Snap Caps

- 33690-01** 2 pcs. 12 gauge
- 33690-02** 2 pcs. 16 gauge
- 33690-03** 2 pcs. 20 gauge



Snap Caps

- 33690-04** 6 pcs. .38
- 33690-05** 6 pcs. 9 mm
- 33690-06** 6 pcs. .45
- 33690-07** 10 pcs. .22
- 33690-08** 6 pcs. 9 mm short



Aluminum Snap Caps

- 33690-20** 2 pcs. 12/70 gauge
- 33690-21** 2 pcs. 12 gauge
- 33690-22** 2 pcs. 16 gauge
- 33690-23** 2 pcs. 20 gauge



Aluminum Snap Caps

- 33690-24** 6 pcs. .38
- 33690-25** 5 pcs. 9 mm
- 33690-26** 5 pcs. .45
- 33690-27** 6 pcs. .44



Aluminum Snap Caps

- 33690-28** 3 pcs. .223 Rem.
- 33690-29** 3 pcs. .280 Rem.
- 33690-30** 3 pcs. .243 Win.
- 33690-31** 3 pcs. .270 Win.
- 33690-32** 3 pcs. .308 Win.
- 33690-33** 3 pcs. .30-06
- 33690-34** 3 pcs. .300 Win. Mag.
- 33690-35** 3 pcs. 6,5 x 55
- 33690-36** 3 pcs. 7mm Rem. Mag.
- 33690-37** 3 pcs. 8 x 68
- 33690-38** 3 pcs. 7 x 64
- 33690-39** 3 pcs. 9,3 x 62
- 33690-40** 3 pcs. 7 x 57
- 33690-41** 3 pcs. 6,5 x 68
- 33690-42** 3 pcs. 7 x 65R
- 33690-43** 3 pcs. 9,3 x 74R
- 33690-44** 3 pcs. 8 x 57IRS
- 33690-45** 3 pcs. 7 x 57R
- 33690-46** 3 pcs. .30R Blaser
- 33690-47** 3 pcs. 8 x 57 IS
- 33690-48** 3 pcs. .222 Rem.
- 33690-49** 3 pcs. 7,5 x 55
- 33690-50** 3 pcs. 6,5x57
- 33690-51** 3 pcs. 5,6x52R
- 33690-52** 3 pcs. 5,6x50R
- 33690-53** 3 pcs. 6,5x57R
- 33690-54** 3 pcs. .375H&H
- 33690-55** 2 pcs. .410
- 33690-56** 3 pcs. .30-30
- 33690-57** 3 pcs. 300 WSM
- 33690-58** 3 pcs. 270 WSM
- 33690-59** 6 pcs. 9 mm short
- 33690-60** 3 pcs. 6BR Norma
- 33690-61** 3 pcs. .28
- 33690-62** 3 pcs. .338 LM
- 33690-63** 20 pcs. .22 LR

Premium Snap Caps

- chrome-plated
- 33695-02** 2 pcs., 12 gauge



Safety-Flags

- 33691-01** 4,5 mm
- 33691-02** .22
- 33691-03** .32
- 33691-04** .38
- 33691-05** .44
- 33691-06** .45
- 33691-07** 6,5 x 55
- 33691-08** .30-06
- 33691-09** 9 mm
- 33691-10** 8 x 57
- 33691-11** 12 gauge



Safety-Flags

- 33692-01** 10 pcs. 4,5 mm
- 33692-02** .22
- 33692-03** 5 pcs. .32
- 33692-04** 5 pcs. .38
- 33692-05** 5 pcs. .44
- 33692-06** 5 pcs. .45
- 33692-07** 5 pcs. 6,5 x 55
- 33692-08** 5 pcs. .30-06
- 33692-09** 5 pcs. 9 mm
- 33692-10** 5 pcs. 8 x 57
- 33692-11** 5 pcs. .308
- 33692-12** 2 pcs. 12 gauge
- 33692-13** 5 pcs. .223 Rem.
- 33692-14** 5 pcs. 7,5x55 Swiss
- 33692-20** 5 pcs. for revolver





Shotgun Cleaning Rod

Aluminum

33700-01 2-part, female thread, wipe length 90 cm

Rifle Cleaning Rod

Stainless steel, with plastic handle, ball bearing mounted

- 33700-02** 1-part, 4 - 4,5 mm, wipe length 74 cm
- 33700-03** 1-part, .22/6,5, male thread 1/8", wipe length 90 cm
- 33700-04** 1-part, 7 mm, female thread M 5, wipe length 91 cm
- 33700-05** 3-part, .22/6,5, male thread 1/8", wipe length 88 cm
- 33700-06** 3-part, 7 mm, female thread M 5, wipe length 88 cm
- 33700-07** 1-part, 4 - 4,5 mm, wipe length 28 cm
- 33700-08** 1-part, .22/6,5, for Pistols, wipe length 23 cm
- 33700-09** 1-part, 7 mm, for Pistols, wipe length 23 cm



Adapters

- 33701-01** 4 - 4,5 mm, female thread M 2,5
- 33701-02** all calibers, M 5 male thread/ 1/8" female thread
- 33701-04** 7,5 mm or more, female thread M5
- 33701-05** for English cleaning rods, 7 mm or more
- 33701-06** for English cleaning rods, up to 6,5 mm
- 33701-08** for US cleaning rods (8-32 UNC thread) 7 mm or more

Reducer

- 33701-03** 9/32" to M5 female thread



Firearm Pocket Set

33702-01 .22-.45/12+16+20

Match-Set Pocket

33702-02 4 - 4,5 mm



VFG Shotgun Cleaner

- 33703-01** 12 gauge, 25 pcs.
- 33703-02** 16 gauge, 25 pcs.
- 33703-03** 20 gauge, 25 pcs.

VFG Barrel Cleaner

33703-04 4-4,5 mm, 100 pcs.



VFG

Barrel Cleaner

- 33703-05** .22, 80 pcs.
- 33703-06** 6 mm, 50 pcs.
- 33703-07** 6,5 mm, 50 pcs.
- 33703-08** 7 mm, 50 pcs.
- 33703-09** 7,5 mm, 50 pcs.
- 33703-10** 8 mm, 50 pcs.
- 33703-11** 9 mm, 40 pcs.
- 33703-12** 9,3 mm, 40 pcs.
- 33703-13** .375, 40 pcs.
- 33703-14** 10,3 mm, 30 pcs.
- 33703-15** .44, 30 pcs.
- 33703-16** .45, 30 pcs.



VFG Shotgun Cleaner

- 33704-01** 12 gauge, 100 pcs.
- 33704-02** 16 gauge, 100 pcs.
- 33704-03** 20 gauge, 100 pcs.



VFG

Barrel Cleaner

- 33704-05** .22, 500 pcs.
- 33704-06** 6 mm, 500 pcs.
- 33704-07** 6,5 mm, 500 pcs.
- 33704-08** 7 mm, 500 pcs.
- 33704-09** 7,5 mm, 500 pcs.
- 33704-10** 8 mm, 500 pcs.
- 33704-11** 9 mm, 500 pcs.
- 33704-12** 9,3 mm, 500 pcs.
- 33704-13** .375, 500 pcs.
- 33704-14** 10,3 mm, 500 pcs.
- 33704-15** .44, 250 pcs.
- 33704-16** .45, 250 pcs.
- 33704-17** .50, 250 pcs.



VFG Super Intense Cleaner

- 33705-01** 12 gauge, 25 pcs.
- 33705-02** 16 gauge, 25 pcs.
- 33705-03** 20 gauge, 25 pcs.
- 33705-04** 4-4,5 mm, 100 pcs.





VFG Super Intense Cleaner

- 33705-05** .22, 80 pcs.
- 33705-06** 6 mm, 50 pcs.
- 33705-07** 6,5 mm, 50 pcs.
- 33705-08** 7 mm, 50 pcs.
- 33705-09** 7,5 mm, 50 pcs.
- 33705-10** 8 mm, 40 pcs.
- 33705-11** 9 mm, 40 pcs.
- 33705-12** 9,3 mm, 40 pcs.
- 33705-13** .375, 40 pcs.
- 33705-15** .44, 30 pcs.
- 33705-16** .45 mm, 30 pcs.



VFG Super Intense Cleaner

- 33706-05** .22, 500 pcs.
- 33706-06** 6 mm, 500 pcs.
- 33706-07** 6,5 mm, 500 pcs.
- 33706-09** 7,5 mm, 500 pcs.
- 33706-12** 9,3 mm, 500 pcs.



VFG Quick Cleaning Pellets

- 33708-01** 4,5/.177, 100 pcs.
- 33708-02** 4,5/.177, 500 pcs.
- 33708-03** 5,5/.22, 80 pcs.
- 33708-05** .25, 80 pcs.



VFG Chamber Cleaner

- 33709-11** .357/.38/9 mm, 40 pcs.
- 33709-16** .45, 30 pcs.



VFG Intense Chamber Cleaner

- 33710-11** .357/.38/9 mm, 40 St.
- 33710-16** .45, 30 pcs.



VFG Barrel Cleaning Paste

- 33711-02** 60 g



Magnetic Felt Jaws

for bench vises

Width x Height x Thickness

- 33712-01** 60 x 12 x 8 mm
- 33712-02** 80 x 18 x 8 mm
- 33712-03** 100 x 20 x 10 mm
- 33712-04** 125 x 25 x 12 mm
- 33712-05** 135 x 25 x 12 mm
- 33712-06** 150 x 30 x 12 mm



20 pcs. Oiled Felts

- 33713-01** 95 x 50 mm



Gun Mat

- 33714-02** 45 x 30 cm



Gun Mat

- 33714-01** 100 x 30 cm

Deluxe Shotgun Bag
Premium vegetable tanned leather

faux fur lining, with flap for stock, carrying handle and sling
32256-01 dark brown, size: 128 x 19 cm



Deluxe Shotgun Bag
Premium vegetable tanned leather

faux fur lining, with flap for stock, carrying handle and sling
32256-02 light brown, size: 128 x 19 cm



Deluxe Rifle Bag
Premium vegetable tanned leather

faux fur lining, with flap for stock, carrying handle and sling
32256-06 dark brown, size: 127 x 24 cm, 1 zipper pocket





Deluxe Shotgun Bag
Premium vegetable tanned leather
tobacco brown, soft lining
32256-04 size: 125 x 18 cm



Deluxe Rifle Bag
Premium vegetable tanned leather
tobacco brown, soft lining
32256-03 size: 125 x 22 cm



Deluxe Rifle Bag
Premium vegetable tanned leather
tobacco brown, soft lining
32256-05 size: 115 x 22 cm



Carrying Sling
for Deluxe Leather Gun Bags 32256-03 to -05
plain, with shoulder pad
32256-90



Combination Padlock
for locking gun bags and
gun cases
32259-03 PU 5



Gun Bags, Nylon
 inside convoluted
 foam, size: 121 x 28 cm
32252-13 olive
32252-14 green
32252-16 brown
32252-17 black
32252-18 blue
32252-00 6 pcs. assorted



Gun Bag, Loden
 with embroidered deer scene,
 inside convoluted foam
32252-37 size: 125 x 30 cm



Gun Bag, green denim
 with embroidered duck motive,
 inside convoluted foam
32252-08 size: 125 x 28 cm



Gun Bag, Nylon
 brown, printed with deer scene , fleece-padding,
 buttstock protection flap, carrying handle and sling
32253-50 size: 125 x 26 cm



Gun Bag, Nylon, inside convoluted foam, carrying handle,
size: 124 x 28 cm, **embroidered with your company name/logo** (Minimum Quantity: 20 pcs.)

- 32252+13 green
- 32252+16 brown
- 32252+17 black



Gun Bags made of nylon, with padded textile lining and carrying handle,
1 outside pocket, size: 120 x 27 cm, **embroidered with your company name/logo** (minimum quantity 20 pieces)

- 32253+90 green
- 32253+91 brown
- 32253+92 black



Gun Bag of nylon, green, padded, with carrying handle and sling, **with your company name/logo**,
minimum quantity 30 pcs.
32253+29 size: 127 x 25 cm



Gun Bag of nylon, green, faux fur lining, 1 outer pocket,
with carrying handle and sling, **with your company name/logo**, minimum quantity 30 pcs.
32253+30 size: 125 x 25 cm



Gun Bag of nylon, faux fur lining, 1 outer pocket,
with carrying handle and sling, size: 125 x 25 cm
32253-30 green 32253-60 brown

Gun Bag, Nylon

green with artificial leather trimming, impact-resistant shell, inside convoluted foam, carrying handle and sling

32252-20 size: 127 x 25 cm

32252-30 size: 127 x 30 cm



Gun Bags, Nylon

camouflage with artificial leather trimming, impact-resistant shell, 2-way zipper, inside convoluted foam, carrying handle and sling

32252-21 size: 127 x 25 cm

32252-31 size: 127 x 30 cm



Gun Bag, Nylon

camouflage with black artificial leather trimming, impact-resistant shell, 2-way zipper, inside faux fur lining, carrying handle and sling

32253-09 size: 120 x 26 cm



Gun Bag of polyester

stitched, green, 1 outer pocket with zipper, padded, with carrying handle and sling

32252-40 size: 122 x 25 cm



Gun Bag of 70% wool and 30% nylon

green, 1 outer pocket with zipper, padded, with carrying handle and sling,

32252-38 size: 120 x 26 cm





Gun Bag of nylon

green, padded, 1 outside pocket, with carrying handle and sling
32253-29 size: 127 x 25 cm



Gun Bag, Nylon

green, with artificial leather trimming, padded, 1 outside pocket, carrying handle and sling
32253-32 size: 120 x 25 cm



Gun Bag, Nylon

black/brown, padded, 1 outside pocket, carrying handle and sling
32253-33 size: 120 x 25 cm



Gun Bag, Nylon

green/black, with black artificial leather trimming, padded, 2 outside pockets, carrying handle and sling
32253-34 size: 120 x 25 cm



Gun Bag, Nylon

green, with artificial leather trimming, plastic muzzle guard, padded, 1 outside pocket, carrying handle and sling
32253-36 size: 127 x 29 cm

Gun Bag, Nylon

green, inside convoluted foam, 2 outside pockets for accessories and compressed air cartridge
32252-27 size: 125 x 28 cm



Gun Bag, Nylon

olive, inside convoluted foam, 1 outside pocket
32252-26 size: 121 x 27 cm



Gun Bag, Nylon

green, 1 outside pocket, padded, carrying handle and sling
32253-27 size: 125 x 28 cm



Gun Bag, Nylon

green/black, padded, 1 outside pocket, carrying handle and sling
32253-11 size: 125 x 24 cm



Gun Bag, Nylon

green, 2 cm foam padding, carrying handle and sling
32253-12 size: 112 x 25 cm,





Gun Bag, Nylon
black, 2 cm foam padding,
carrying handle and sling
32253-13 size: 110 x 22 cm



Gun Bag, Nylon
2 cm foam padding, carrying handle and sling,
size: 127 x 27 cm
32253-14 green
32253-08 black



Gun Bag, Nylon
black, padded, 1 outside pocket,
carrying handle and sling
32253-31 size: 127 x 26 cm



Gun Bag, Nylon
green, 2 cm foam padding,
carrying handle and sling
32253-15 size: 135 x 30 cm
32253-16 size: 140 x 30 cm



Gun Bag, Nylon
black, 2 cm foam padding,
carrying handle and sling
32253-17 size: 135 x 30 cm



Gun Bag, Synthetic leather „Antique“
with thick wave foam padding, with handle,
rear side with loops for carrying handle
32252-23 size: 128 x 28 cm



Gun Bag, Nylon
green, for 2 guns, strong nylon-padding, 1 outside pocket, carrying handle and sling
32253-20 size: 128 x 28 cm



Gun Bag, Nylon
green, for 2 guns, 2cm foam-padding, 1 outside pocket, carrying handle and sling
32253-22 size: 128 x 28 cm **32253-25** size: 112 x 28 cm



Gun Bag, Nylon
green, with artificial leather trimming and
bottom flap, 2cm foam-padding, 2 outside
pockets, carrying handle and backpack slings
32253-23 size: 122 x 33 cm



Gun Bag made of EVA (EVAC)

green, shock-proof outer shell, 2-way zipper,
inside convoluted foam, with carrying handle and sling
32253-51 inside dimensions: 125 x 30 x 8 cm



Gun Bag made of EVA (EVAC)

black, shock-proof outer shell, 2-way zipper,
inside convoluted foam, with carrying handle and sling
32253-52 inside dimensions: 125 x 30 x 8 cm



Canvas Gun Bags for Shotguns

with carrying sling
32255-14 size: 120 x 16 cm
32255-16 size: 130 x 16 cm



**Canvas Gun Bags
for Rifles with Scope**

with carrying sling, extra wide for rifle scope
32255-34 size: 120 x 25 cm
32255-35 size: 125 x 25 cm
32255-36 size: 130 x 25 cm





Gun Bag, Nylon

blue/grey, inside 3 cm Nylon lining, 2 big outside pockets, **backpack carrying slings**, **extra high** for diopter and front sight elevation
32252-09 size: 127 x 33 cm



Gun Bag, Nylon

red/grey, inside 3 cm Nylon lining, 2 big outside pockets, **backpack carrying slings**, **extra high** for diopter and front sight elevation
32252-10 size: 127 x 33 cm



Gun Bag with integrated Shooting Mat, Nylon

black, 2 big outer pockets, 4 inner accessory bags, size shooting mat: 180 x 68 cm, with backpack straps
32253-49 dimensions: 123 x 30 cm





Gun Bag of nylon with padded nylon lining

2 big outer pockets, 128 x 33 cm, with **backpack slings**, half-circumferential zipper, closed at the recoil pad side and with **non-slip rubber plating** outside, **extra high** for diopter and front sight elevation

32252-01 black/blue

32252-02 black/red

32252-03 black/orange

32252-04 black



Gun Bag, Nylon

black/blue, inside well-padded Nylon lining, 2 big outside pockets, **backpack carrying slings**, **protection flap** for buttstock, **extra high** for diopter and front sight elevation

32252-11 size: 128 x 33 cm



Gun Bag, Nylon

black/red, inside well-padded Nylon lining, 2 big outside pockets, **backpack carrying slings**, **protection flap** for buttstock, **extra high** for diopter and front sight elevation

32252-12 size: 128 x 33 cm

Gun Bags for Assault Gun, Nylon

2 cm Nylon/foam padding, inside with fixing straps, 3 outside pockets, carrying handle and sling
size: 87 x 30 cm

- 32253-07** black
- 32253-21** black/red
- 32253-24** black/blue



Gun Bags, Nylon

for Swiss assault gun 57, black, 2 cm Nylon/foam padding, inside with fixing straps, 3 outside pockets, carrying handle and sling

32253-48 size: 120 x 33 cm



Gun Bag, Nylon

for semi-automatic rifles, black, 2 cm Nylon/foam padding, inside with fixing straps, 3 outside pockets, carrying handle and sling

32253-05 size: 105 x 30 cm



Gun Bag, Nylon, black, padded, 1 outside pocket, carrying handle and backpack slings

32253-18 size: 90 x 35 cm





Loden Gun Covers, 100% Wool

soft Loden shell, the gun will be carried by the gun sling, easy to remove, optimal protection
32254-02 inside length: 113 cm
32254-03 inside length: 120 cm
32254-04 inside length: 128 cm for guns with silencer

Gun Bag

padded cotton with leather coins, green, the weapon is well protected and can be carried by the gun sling
32254-05 inside length: 120 cm



Gun Bag

wool felt with leather coins, grey, the weapon is well protected and can be carried by the gun sling
32254-06 internal length: 120 cm



Gun Socks

protects against corrosion, especially in environments with high humidity
32250-01 pistol sock
32250-02 gun sock

Shotgun Bag of nylon

padded, with carrying handle and sling, length 128 x 18 cm

32253-39 green

32253-40 blue

32253-41 black



Shotgun Bag, Nylon

green, padded, 1 outside pocket, buttock flap, with carrying handle and sling

32253-26 size: 130 x 20 cm



Shotgun Bag, Nylon

black/brown, padded, 1 outside pocket, with carrying handle

32253-38 size: 130 x 20 cm



Shotgun Bags, Nylon

green, padded, 1 outside pocket, with carrying handle

32253-44 size: 120 x 23 cm





Pistol Bag

black, inside padded
32268-02 32 x 16 cm
32268-03 25 x 16 cm



Pistol Bag

black, inside padded
32268-04 37 x 20 cm
32268-05 40 x 25 cm



Pistol Bag made of EVA (EVAC)

Shock-proof outer shell, 2-way zipper, inside convoluted foam

inside dimensions:

32268-08 23 x 14 x 5 cm
32268-09 28 x 17 x 5 cm
32268-10 33 x 18,5 x 5 cm



Pistol Bag

green with art leather trimming, inside padded
32268-07 35 x 18 cm



Pistol Bag

black, inside padded, for 2 Pistols
32268-06 35 x 23 cm

Range Bag – Accessories Bag for Sport Shooters

water-repellent Nylon, the main compartment can be divided individually, with handles and carrying belt



- 1** **32268-11** 50 x 33 x 25 cm, with 4 outer pockets (2 of these with removable pistol bags)
- 2** **32268-12** 45 x 38 x 30 cm, with 2 outer pockets with removable pistol bags
- 3** **32268-13** 45 x 28 x 35 cm, with 1 outer pocket with removable pistol bag and 1 outer pocket for targets



PP-Pistol Case

black, inside convoluted foam, with Clip-locks, PU 5
32292-01 inside dimension: 27 x 17 x 6 cm
32292-05 inside dimension: 36 x 27 x 9 cm



PP-Pistol Case

black, inside convoluted foam, with Clip-locks, PU 5
32292-03 inside dimension: 30 x 15 x 6 cm



PP-Pistol Case

black, inside convoluted foam, with Clip-locks, PU 5
32292-04 inside dimension: 23,5 x 16 x 4,6 cm



PP-Pistol Case

black, inside convoluted foam, with sturdy Clip-locks, PU 5
32295-15 inside dimension: 30 x 18 x 6 cm



PP-Pistol Case

black, inside convoluted foam, with Side-locks, PU 5
32295-04 inside dimension: 28 x 18 x 6 cm



ABS-Pistol Case

black, inside convoluted foam, with combination lock
32293-01 inside dimension: 30 x 17 x 6 cm





PP-Pistol Case

black, inside convoluted foam,
with 2 sturdy Clip-locks
32295-11 inside dimension: 48 x 27 x 8 cm
32295-31 same, but lockable



PP-Pistol Case

black, inside convoluted foam,
inside dimension: 49 x 27 x 7 cm
32295-13 with 2 sturdy Clip-locks
32295-14 with 2 combination locks



PP-Pistol Case

black, inside convoluted foam,
with slide-locks, PU 5
32295-01 inside dimension: 28 x 19 x 6 cm
32295-02 inside dimension: 44 x 19 x 8 cm



PP-Pistol Case

black, inside convoluted foam,
with combination slide-lock, PU 5
32295-21 inside dimension: 28 x 19 x 6 cm
32295-22 inside dimension: 44 x 19 x 8 cm



Combination Slide-Lock

following cases can be equipped with this lock:
Gun Cases: 32271-10, 32271-11, 32271-12,
32271-13, 32271-14, 32271-15,
32271-16, 32271-17, 32271-19
Pistol Cases: 32295-1, 32295-2, 32295-4
32271-91

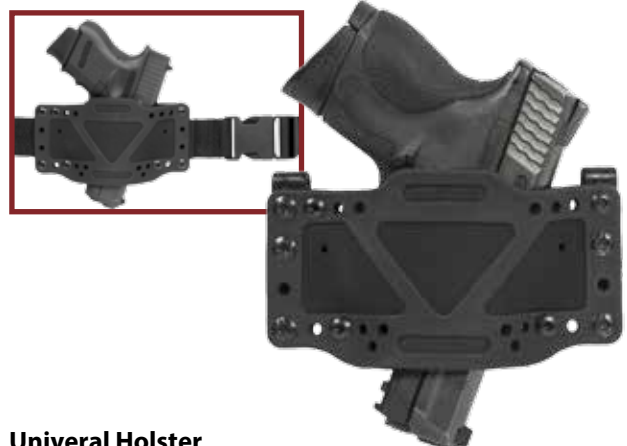

Universal Holster

fits for all handguns, rubber, can be adapted to the weapon
by heating
32230-01 with clip
32230-02 with clip and safety strap
32230-03 with belt
32230-04 with belt and safety strap



Pistol Case
Aluminum-Frame Case with reinforced corners
 inside convoluted foam, 2 combination locks,
 outside scratch-proof ABS
32285-01 inside dimensions: 30 x 21 x 10 cm
32285-06 inside dimensions: 44 x 34 x 10 cm
32285-08 inside dimensions: 34 x 22 x 8 cm



Pistol Case
Aluminum Frame Case with reinforced Corners
 with 2 separate Compartments
32261-01 inner dimensions: 36 x 24 x 18 cm



ABS Pistol Case
 root wood design, inside velvet padding, 2 clip-locks,
 1 combination lock
32296-09 inside dimensions: 36 x 23 x 6,5 cm



ABS Pistol Case
 Stainless Steel design, inside velvet padding, 2 clip-locks,
 1 combination lock
32296-10 inside dimensions: 36 x 23 x 6,5 cm



ABS Pistol Case
 Alu-silver, inside velvet padding, 2 combination locks
32296-13 inside dimensions: 32 x 16 x 7 cm



ABS Pistol Case
 green, inside velvet padding, 2 combination locks
32296-06 inside dimensions: 32 x 19 x 7cm





PP – Gun Case

inside convoluted foam, with slide-locks

32271-10 inside dimensions: 121 x 23 x 10 cm, green

32271-11 inside dimensions: 121 x 23 x 10 cm, black

32271-12 inside dimensions: 95 x 23 x 10 cm, black

32271-13 inside dimensions: 81 x 23 x 10 cm, black



PP – Gun Case

inside convoluted foam,
with slide-locks

32271-14 inside dimensions: 95 x 24 x 8 cm, olive green

32271-15 inside dimensions: 103 x 24 x 10 cm, black

32271-16 inside dimensions: 121 x 24 x 10 cm, black

32271-19 inside dimensions: 82 x 30 x 8,5 cm, black



PP – Gun Case

black, inside convoluted foam, with slide-locks

32271-17 inside dimensions: 130 x 32 x 13 cm



PP – Gun Case

sturdy construction, black,
inside convoluted foam, with sturdy
clip-locks

32271-18 inside dimensions:
117 x 29 x 12 cm

32271-21 inside dimensions:
90 x 30 x 10 cm



PP – Gun Case
 inside convoluted foam,
 with sturdy clip-locks
32271-01 inside dimensions: 80 x 24 x 7,5 cm



PP – Gun Case
 Inside velvet padding,
 with sturdy clip-locks
32271-03 inside dimensions: 80 x 24 x 7,5 cm



ABS Gun Case
 black, inside convoluted foam,
 with sturdy clip-locks, for 2 guns
32270-01 inside dimensions: 120 x 29,5 x 9 cm
32270-02 inside dimensions: 132 x 31 x 9 cm



ABS Gun Case
 black, inside convoluted foam,
 with sturdy clip-locks
32270-03 inside dimensions: 120 x 25 x 6,5 cm
32270-04 inside dimensions: 133 x 25 x 6,5 cm



ABS Gun Case
 black, inside convoluted foam,
 with sturdy clip-locks, for 2 guns
32270-05 inside dimensions: 125 x 30 x 8,5 cm





PP Gun Case

black, inside convoluted foam,
with 2 combination locks and 2 clip-locks

32272-02 inside dimensions: 96 x 25 x 9 cm

32272-04 inside dimensions: 109 x 25 x 10 cm

32272-06 inside dimensions: 124 x 25 x 10 cm

32272-08 inside dimensions: 82 x 25 x 7 cm

32272-10 inside dimensions: 117 x 30 x 10 cm

32272-12 inside dimensions: 139 x 30 x 10 cm

32272-14 inside dimensions: 98 x 35 x 12 cm

32272-16 inside dimensions: 130 x 35 x 12 cm



PP Gun Case

black, inside convoluted foam,
with 4 clip-locks

32272-01 inside dimensions: 96 x 25 x 9 cm

32272-03 inside dimensions: 109 x 25 x 10 cm

32272-05 inside dimensions: 124 x 25 x 10 cm

32272-07 inside dimensions: 82 x 25 x 7 cm

32272-09 inside dimensions: 117 x 30 x 10 cm

32272-11 inside dimensions: 139 x 30 x 10 cm

32272-13 inside dimensions: 98 x 35 x 12 cm

32272-15 inside dimensions: 130 x 35 x 12 cm



PP Gun Case

black, inside convoluted foam,
with 4 sturdy clip-locks

32271-20 inside dimensions: 116 x 27 x 9 cm



PP – Case for 1 Barrel

with slide-locks

32280-01 inside dimensions:
83 x 10 x 7 cm



Aluminum-Frame Gun Case with enhanced corners
 silver color, inside convoluted foam, with 2 D-locks and 2 combination locks, outside scratch-free ABS
32261-09 inside dimensions: 123 x 33 x 9 cm



Aluminum-Frame Gun Case with enhanced corners
 bronze/black color, inside convoluted foam, with 2 D-locks and 2 combination locks, outside scratch-free ABS
32285-02 inside dimensions: 82 x 33 x 10 cm
32285-05 inside dimensions: 123 x 21 x 10 cm

32285-07 inside dimensions: 132 x 33 x 11,5 cm
32285-09 inside dimensions: 123 x 33 x 10



Compact Gun Case
 Outside material scratch-free ABS, inside velvet padding, for 1 O/U shotgun, barrel length up to 76 cm or 86 cm
 Inside dimensions: 78 x 15 x 10 cm
32269-05 with leather trimming
32269-15 without leather

Inside dimensions: 86 x 15 x 10 cm
32269-06 with leather trimming
32269-16 without leather





ABS Deluxe Gun Case
with leather trimming,
inside velvet padding,
with 3 combination locks, for 1 shotgun
32269-01 inside dimensions: 79,5 x 22 x 6 cm



ABS Deluxe Gun Case
with leather trimming, inside velvet padding,
with 3 combination locks, for 2 shotguns
32269-02 inside dimensions: 78 x 22,5 x 10 cm



ABS Deluxe Gun Case
with leather trimming, inside velvet padding,
with 3 combination locks, for 1 shotgun with 2 barrels
32269-03 inside dimensions: 78 x 17,5 x 10,5 cm



Gun Case
inside velvet padding, with 2 combination locks,
for 1 shotgun, inside dimensions: 80 x 20 x 8,5 cm,
32269-11 PP-shell

32269-12 Deluxe-version with leather trimming,
ABS-shell



ABS Gun Case
black, inside velvet padding,
with 3 combination locks, for 1 shotgun
32276-01 inside dimensions: 79,5 x 22 x 6 cm



ABS Gun Case
black, inside velvet padding,
with 3 combination locks, for 1 shotgun
32276-02 inside dimensions: 80 x 23 x 7 cm



ABS Gun Case
Black, inside velvet padding,
with 3 combination locks, for 2 shotguns
32278-01 inside dimensions: 78 x 22,5 x 10 cm
32278-02 inside dimensions: 93,5 x 22 x 10 cm



ABS Gun Case
black, inside velvet padding,
with 3 combination locks, for 1 shotgun rifle
or break-down rifle with 3 barrel-systems
with mounted rifle scopes
32281-18 inside dimensions: 88 x 19 x 9,5 cm





ABS Gun Case

black, inside velvet padding,
with 3 combination locks, for 1 rifle with 1 scope
32281-01 inside dimensions: 70 x 26 x 7 cm



ABS Deluxe Gun Case

with leather trimming, inside velvet padding,
with 3 combination locks, for 1 rifle with 1 scope
32281-04 inside dimensions: 67 x 26 x 7 cm



ABS Deluxe Gun Case

with leather trimming, inside velvet padding,
with 3 combination locks,
for 1 rifle with 2 barrels and 1 scope
32281-08 inside dimensions: 65 x 36,5 x 7,5 cm



ABS Deluxe Gun Case

with leather trimming, inside velvet padding,
with 3 combination locks, for 1 rifle with 1 scope
32281-05 inside dimensions: 76,5 x 25 x 6,5 cm



ABS Deluxe Gun Case

with leather trimming, inside velvet padding,
with 3 combination locks,
for 1 rifle with 2 barrels up to 66 cm length and 2 scopes
32281-09 inside dimensions: 84 x 34,5 x 8,5 cm



ABS Deluxe Gun Case

brown, with leather trimming, inside velvet padding,
with 3 combination locks,
for 1 rifle with 2 barrels up to 76 cm length, and 2 scopes
32281-19 inside dimensions: 77 x 32 x 6 cm



ABS Deluxe Gun Case
with leather trimming,
inside velvet padding, with 3 combination locks,
for 1 repeating rifle with long front shaft and 1 scope
32281-10 inside dimensions: 80 x 29 x 7 cm



ABS Deluxe Gun Case
green, with leather trimming, inside velvet padding,
with 3 combination locks, for 2 rifles and 2 scopes
32269-04 inside dimensions: 86 x 22 x 13 cm



ABS Gun Case
inside velvet padding, with 3 combination locks,
for 1 rifle with detachable buttstock and 1 scope
32269-13 inside dimensions: 95 x 22 x 7 cm



PP - Bow Case
black
32279-04 inside dimension: 95 x 23 x 10 cm





Cartridge Case
thermo-formed ABS,
with 2 D-locks and
1 combination lock
32267-03 for 150 shotshells



Cartridge Case
thermo-formed ABS,
with 2 D-locks and
1 combination lock
32267-04 for 200 shotshells



Cartridge Case
PP, for 200 shotshells

32267-06
with bar-locks

32267-16
with combination bar-lock



Cartridge Case
thermo-formed ABS,
with 2 D-locks and
1 combination lock
32267-05 for 350 shotshells, thermo-insulated



Cartridge Case
thermo-formed ABS,
with 2 D-locks and
1 combination lock
32267-09 for 125 shotshells
32267-10 for 150 shotshells



Cartridge Case
thermo-formed ABS,
with 1 combination locks
32267-07 for 100 shotshells



Cartridge Bag
Nylon
30 x 12 x 9 cm
32301-01 for 100 shotshells



Cartridge Bag
Nylon
30 x 22 x 10 cm,
with 1 outside pocket
32301-02 for 225 shotshells



Cartridge Box, PP
32377-01 for 5 cartridges

Plastic Ammunition Boxes

All ammunition boxes are delivered with transparent cover.

- 32377-11** 50-Round 9 mm
- 32377-12** 50-Round .357
- 32377-13** 50-Round .45ACP
- 32377-14** 50-Round .44 Magnum
- 32377-15** 50-Round .30-06
- 32377-16** 50-Round .223
- 32377-17** 50-Round .243 - .308
- 32377-18** 50-Round .338L - .300 WM



Lined area for notes, consisting of 20 horizontal grey bars.



03 | SPORT SHOOTING SUPPLIES



Airgun Ammunition	<i>Pages 96 – 99</i>
Hearing Protection	<i>Pages 100 – 101</i>
Bullet Traps / Shooting Ranges	<i>Page 102</i>
Targets	<i>Page 102</i>
Shooting Apparel	<i>Pages 103 – 104</i>
Slingshots	<i>Page 104</i>
Eyeshades	<i>Page 105</i>
Trigger Locks	<i>Page 105</i>
Pistol Rests	<i>Page 105</i>
Wooden Plaques	<i>Pages 106 – 107</i>
Berloque Pistols	<i>Page 107</i>

Ort und Datum

Zielscheibe © thombach



**Airgun Ammunition
Diabolo Standard**

Flathead			Tin	PU
24001-01	4.5 mm		500	10



**Airgun Ammunition
Diabolo Boxer**

			Tin	PU
24006-01	4.5 mm		500	10
24006-11	5.5 mm		300	10



**Airgun Ammunition
Round Pellets**

			Tin	PU
24007-01	4.4 mm		600	10



**Airgun Ammunition
H&N Finale Match Heavy**

			Tin	PU
24020-02	4.49 mm	.177"	500	50
24020-03	4.5 mm	.177"	500	50



**Airgun Ammunition
H&N Finale Match Light**

			Tin	PU
24021-01	4.48 mm	.177"	500	50
24021-02	4.49 mm	.177"	500	50
24021-03	4.5 mm	.177"	500	50



**Airgun Ammunition
H&N Match Heavy**

			Tin	PU
24022-02	4.49 mm	.177"	500	50
24022-03	4.5 mm	.177"	500	50



**Airgun Ammunition
H&N Match Light**

			Tin	PU
24023-02	4.49 mm	.177"	500	50
24023-03	4.5 mm	.177"	500	50



**Airgun Ammunition
H&N Match Green**

			Tin	PU
24023-30	4.5 mm	.177"	500	50



**Airgun Ammunition
H&N Sport**

			Tin	PU
24024-01	4.5 mm	.177"	500	50
24024-11	5.5 mm	.22"	250	50



**Airgun Ammunition
H&N Baracuda**

			Tin	PU
24026-01	4.5 mm	.177"	400	50
24026-03	5.5 mm	.22"	200	50
24026-04	6.35 mm	.25"	150	50

**Airgun Ammunition
H&N Baracuda Match**



				Tin	PU
24026-21	4.5 mm	.177"	Head Size 4.50 mm	400	50
24026-22	4.5 mm	.177"	4.51 mm	400	50
24026-23	4.5 mm	.177"	4.52 mm	400	50
24026-25	5.5 mm	.22"	5.51 mm	200	50
24026-26	5.5 mm	.22"	5.52 mm	200	50



**Airgun Ammunition
H&N Baracuda Green**

				Tin	PU
Lead-free					
24038-01	4.5 mm	.177"		300	50
24038-02	5.5 mm	.22"		200	50





**Airgun Ammunition
H&N Baracuda Power**

Copper-coated			Tin	PU
24026-10	4.5 mm	.177"	300	50
24026-11	5.5 mm	.22"	200	50



**Airgun Ammunition
H&N Baracuda Hunter**

Lead-free			Tin	PU
24039-01	4.5 mm	.177"	400	50
24039-02	5.5 mm	.22"	200	50
24039-03	6.35 mm	.25"	150	50



**Airgun Ammunition
H&N Baracuda
Hunter Extreme**

Lead-free			Tin	PU
24037-02	4.5 mm	.177"	400	50
24037-03	5.5 mm	.22"	200	50
24037-01	6.35 mm	.25"	150	50



**Airgun Ammunition
H&N Field Target Trophy Green**

Lead-free			Tin	PU
24029-10	4.5 mm	.177"	300	50
24029-11	5.5 mm	.22"	200	50



**Airgun Ammunition
H&N Field Target Trophy**

Head Size			Tin	PU
24029-01	4.5 mm	.177"	500	50
24029-02	4.5 mm	.177"	500	50
24029-03	4.5 mm	.177"	500	50
24029-05	5.5 mm	.22"	500	30
24029-06	5.5 mm	.22"	500	30



**Airgun Ammunition
H&N Field Target Trophy Power**

Lead-free			Tin	PU
24029-21	4.5 mm	.177"	300	50
24029-22	5.5 mm	.22"	200	50



**Airgun Ammunition
H&N excite Hollow Point**

Lead-free			Tin	PU
24025-01	4.5 mm	.177"	500	50
24025-03	5.5 mm	.22"	200	50



**Airgun Ammunition
H&N Crow Magnum**

Lead-free			Tin	PU
24034-01	4.5 mm	.177"	500	30
24034-03	5.5 mm	.22"	200	50
24034-04	6.35 mm	.25"	150	50



**Airgun Ammunition
H&N Spitzkugel**

Lead-free			Tin	PU
24028-01	4.5 mm	.177"	500	50
24028-03	5.5 mm	.22"	200	50



**Airgun Ammunition
H&N excite Coppa-Spitzkugeln**

Lead-free			Tin	PU
24036-02	4.5 mm	.177"	500	50
24036*01	6.35 mm	.25"	200	



**Airgun Ammunition
H&N Hornet**

Lead-free			Tin	PU
24041-01	4.5 mm	.177"	225	50
24041-02	5.5 mm	.22"	200	50



**Airgun Ammunition
H&N Silver Point**

Lead-free			Tin	PU
24027-01	4.5 mm	.177"	500	30
24027-03	5.5 mm	.22"	200	50



**Airgun Ammunition
H&N Terminator**

				Tin	PU
24042-01	4.5 mm	.177"		400	50
24042-02	5.5 mm	.22"		200	50



**Airgun Ammunition
H&N Red Scorpion**

				Tin	PU
24043-01	4.5 mm	.177"		225	50



**Airgun Ammunition
H&N Rabbit Magnum**

				Tin	PU
24031-01	4.5 mm	.177"	II	200	50
24031-02	5.5 mm	.22"	II	200	50
24031-11	4.5 mm	.177"	Power	200	50
24031-12	5.5 mm	.22"	Power	200	50



**Airgun Ammunition
H&N Grizzly**

				Tin	PU
24044-01	6.35 mm	.25"		150	50
24044-02	9 mm	.35"		85	30



**Airgun Ammunition
H&N Sniper Magnum**

				Tin	PU
24046-01	4.5 mm	.177"		300	50
24046-02	5.5 mm	.22"		250	50



**Airgun Ammunition
H&N Sniper Medium**

				Tin	PU
24047-01	4,5 mm	.177"		500	50



**Airgun Ammunition
H&N Rund**

				Tin	PU
24030-03	4.4 mm		Copper-coated	750	50

Shot

5kg, PU 5

24050-03	Ø 2.41 mm
24050-04	Ø 2.5 mm
24050-05	Ø 3 mm



**H&N excite
Prometheus**

				Tin	PU
24053-01	4,5 mm	.177"		250	50



**H&N Finale
Maxx Heavy**

				Box	PU
24054-01	4,49 mm	.177"		200	18
24054-02	4,5 mm	.177"		200	18

H&N Finale Maxx Light

				Box	PU
24054-03	4,49 mm	.177"		200	18
24054-04	4,5 mm	.177"		200	18



**Airgun Ammunition
H&N Piledriver**

				Tin	PU
24051-01	4,46 mm	.177"		250	50
24051-02	5,5 mm	.22"		150	50



H&N Dust Devil BBs

				PU
24052-01	4,5 mm	.177"	Tin 750	50
24052-02	4,5 mm	.177"	Box 1500	12





**H&N
6 Tube Pellet
Sampler Pack 4.5 mm**
35 pcs. Crow Magnum
30 pcs. Hornet
35 pcs. Baracuda Power
35 pcs. Baracuda Hunter extrem
40 pcs. Field Target Trophy
40 pcs. Field Target Trophy Green
24060-01



**H&N
5 Tube Pellet
Sampler Pack 5.5 mm**
30 pcs. Baracuda Hunter
30 pcs. Crow Magnum
30 pcs. Baracuda Power
35 pcs. Hornet
30 pcs. Baracuda Green
24060-04



**H&N
6 Tube Pellet
Sampler Pack 4.5 mm,
4.51 mm, 4.52 mm**
3 x 40 pcs. Field Target Trophy
3 x 40 pcs. Baracuda Match
24060-02



H&N Safety Case
24060-08 Color: petrol
24060-09 Color: magenta



Final Match Box
Plastic
24060-03 Color: petrol
24060-05 Color: magenta



H&N Counter Display
for 30 tins, 2 samplers and 12 catalogs (without content)
24060-99



Bilsom Hearing Protection L1
Noise reduction 30 dB, ultraslim earcups,
padded headband
33342-01



Bilsom Hearing Protection LOF
Noise reduction 25 dB, folding, ultraslim earcups, padded
headband
33342-03



Bilsom Hearing Protection T3
Maximum noise reduction 36 dB, ideal for shooting large
caliber pistols, folding
33342-04



Electronic Hearing Protection
Amplifies weak noises, reduces or suppresses excessively
loud noises, includes 2 AA 1.5 V batteries
33342-06



**Bilsom Impact Sport
Electronic Hearing Protection**
Amplifies ambient sound, reverts to passive hearing
protector when noise reaches 82 dB, folding, slim design,
includes 2 AAA batteries
33342-07
33342-57 1 pair of replacement ear cushions



**Electronic
Hearing Protection**
Noise reduction 21 dB,
with 2 microphones,
individually adjustable earcups
with ultraslim design, 4 AAA batteries (not included)
33342-08





Hearing Protection and Hearing Amplifier

Shot/loud noises are suppressed.
Range 30 meters, batteries included
33342-17 1 pair



Electronic Ear Protection

Noise reduction 28 dB, weak noises are amplified while loud noises are reduced or suppressed, rechargeable, weight: 20 g
33342-19



Banded Hearing Protector

noise reduction 24 dB
33342-15
33342-16 Spare plugs, 1 pair



Hearing Protection and Hearing Amplifier

Shot/loud noises are suppressed.
Range 30 meters, batteries included
33342-18



Disposable Earplugs

10 pairs, noise reduction 29 dB
33342-12



Earplugs with Cord

1 pair, noise reduction 28 dB
33342-13



Earplugs with Cord

1 pair, noise reduction 30 dB
33342-14



Earplugs with Cord

1 pair, noise reduction 21 dB, blocks low and medium frequencies while allowing natural, undistorted perception of speech and sound, PU 10
33342-10

Bullet Trap made of Thick Sheet Steel

- for targets
33341-05 10 x 10 cm
33341-01 14 x 14 cm
33341-02 17 x 17 cm

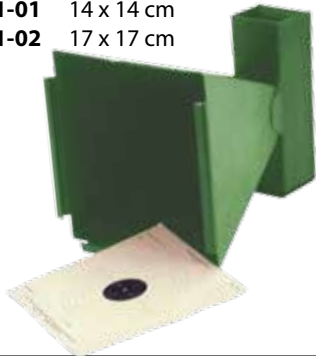

Clay Pipe Bullet Trap made of Sheet Steel

- Suitable for targets 14 x 14 cm or 7 clay pipes
33341-03



- Clay Pipes, 4 cm,**
 approx. 1,000 pcs.
33341-91



Bullet Trap with Shooting Pyramid

- Adjustable for targets 10 x 10 cm to 14 x 14 cm
33341-04



Silhouette Shooting Range

- After you hit the four silhouette targets to the right and left you can reset the range by shooting the center target
33341-09 Boars



Silhouette Shooting Range

- After you hit the four silhouette targets to the right and left you can reset the range by shooting the center target
33341-10 Ducks



Shooting Range Biathlon

- for airgun
33341-12

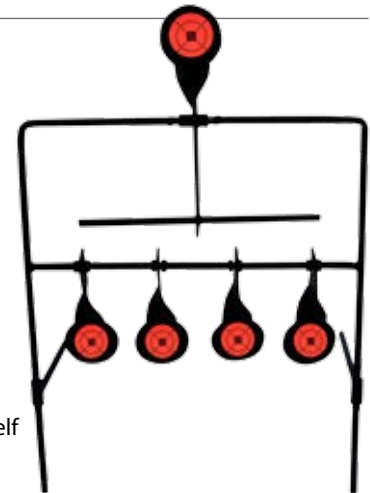

Shooting Range

- Steel target placing itself back automatically
33341-11



- 20 targets with hit indication, Ø 17 cm**
33341-23



Truglo Targets

- with point-of-impact "halo" – immediately see where you hit the target
33341-20 6 count, 4 x Ø 10 cm, 1 x Ø 13 cm
33341-21 12 count, 4 x Ø 10 cm, 1 x Ø 13 cm
33341-22 12 count, Ø 26 cm





Shooting Vest

green, with leather trim on front, 2 large cartridge pockets, mesh back with elastic band, for right or left-handed shooters, 80% cotton, 20% leather
28367-46 - 62 Size 46 - 62



Shooting Vest

green, with leather trim on front, 2 large cartridge pockets, back with elastic band, for right or left-handed shooters, 80% cotton, 20% leather
28371-46 - 62 Size 46 - 62



Shooting Vest

blue, with leather trim on front, 2 large cartridge pockets, mesh back with elastic band, for right or left-handed shooters, 80% cotton, 20% leather
28365-46 - 62 Size 46 - 62



Shooting Vest

green, front part with 2 large cartridge pockets and 4 accessory pockets, back part with Mesh insert, elastic band and cartridge pouch, 100% cotton, mesh insert polyester
28364-01 Size M **28364-03** Size XL
28364-02 Size L **28364-04** Size XXL



Shooting Pad

with removable recoil-absorbing cushion made of NAVICOM™III featuring different sized knobs. This displaces recoil forces more effectively than any other material on the market
28350-01



Shooting Vest

blue / red, front part with 2 large cartridge pockets and 1 accessory pocket, back part made of mesh fabric, 65% cotton, 35% polyester
28366-01 Size M **28366-03** Size XL
28366-02 Size L **28366-04** Size XXL

Shooting glove sizes: 7 = XS, 8 = S, 9 = M, 10 = L, 11 = XL, 12 = XXL, 13 = XXXL



Shooting Gloves

Wool/viscose lining, padded, with non-slip rubber coating, breathable mesh upper, complete finger, size 7 - 13
32102-7 - 13 for right-handed shooters
32112-7 - 13 for left-handed shooters



Shooting Gloves

Wool/viscose lining, padded, with non-slip rubber coating, half finger, size 7 - 13
32105-7 - 13 for right-handed shooters
32115-7 - 13 for left-handed shooters



Leather Knee Roll

32150-01 Without filling
32150-02 with cork filling



Shooting Sling

Synthetic material, with double prong buckles, black
32140-01



Plastic Slingshot Ammo

17 mm, 40 pcs.
38200-11

Steel Slingshot Ammo

38200-13 6,3 mm, 100 pcs.
38200-14 7,9 mm, 100 pcs.
38200-15 10,3 mm, 45 pcs.



Slingshot

38200-01
38200-31 Spare rubber band



Slingshot

38200-02
38200-31 Spare rubber band



Slingshot

with aluminum handle
38200-03
38200-31 Spare rubber band



Shooting Mat for Shooting in Kneeling and Prone Position

with non-slip rubber coating, thickness 15 mm
32151-01 80 x 200 cm





Eyeshade
made of rubber, black
32321-11



Eyeshade
made of rubber, transparent
32321-13



Eyeshade
made of rubber, black, complies with
new ISSF guidelines
32321-14



Eyeshade
made of rubber, beige, complies with
new ISSF guidelines
32321-15



Eyeshade
made of rubber, transparent, complies with
new ISSF guidelines
32321-16



Eyeshade
made of plastic, black
32321-17



Eyeshade
made of plastic, transparent
32321-18



Trigger Lock
for guns, pistols and revolvers
33336-02 with key



Trigger Lock
for guns, pistols and revolvers
33336-03 combination lock



Pistol Rack
1 Pair
33301-11 „Deer Heads“



Pistol Rack
1 Pair
33301-12 „Fleur-de-lis“



Trigger Lock
for guns, pistols and revolvers
33336-01 with special key



Wooden Plaques made of light solid wood, deer
 34363-01 30 cm Ø 34364-01 40 cm Ø 34365-01 50 cm Ø



Wooden Plaques made of light solid wood, roe deer
 34363-02 30 cm Ø 34364-02 40 cm Ø 34365-02 50 cm Ø



Wooden Plaques made of light solid wood, chamois
 34363-03 30 cm Ø 34364-03 40 cm Ø 34365-03 50 cm Ø



Wooden Plaques made of light solid wood, grouse
 34363-04 30 cm Ø 34364-04 40 cm Ø 34365-04 50 cm Ø



Wooden Plaques made of light solid wood, wild boar
 34363-05 30 cm Ø 34364-05 40 cm Ø 34365-05 50 cm Ø



Wooden Plaques made of light solid wood, duck
 34363-06 30 cm Ø 34364-06 40 cm Ø



Wooden Plaques made of light solid wood, pheasant
 34363-07 30 cm Ø 34364-07 40 cm Ø



Wooden Plaques made of light solid wood, fox
 34363-09 30 cm Ø 34364-09 40 cm Ø





Wooden Plaque
made of light solid wood,
rifles
34364-13 40 cm Ø



Wooden Plaque
made of light solid wood,
pistols
34364-14 40 cm Ø



Wooden Plaque
made of light solid wood,
"Schützenti"oni"
34364-15 40 cm Ø



Wooden Plaque
made of light solid wood,
"Schützenliesl"
34364-16 40 cm Ø



Wooden Plaque
made of light plywood,
roe deer
34362-02 35 cm Ø



Wooden Plaque
made of light plywood,
wild boar
34362-05 35 cm Ø



Wooden Plaque
made of light plywood,
duck
34362-06 35 cm Ø



Wooden Plaque
made of light plywood,
fox
34362-09 35 cm Ø

Berloque Precision Pistol in Gift Box

World's smallest pistol
Flare set with 1 Berloque Pistol
with screw-on extension,
25 percussion caps and 10 flares

- 38300-02** Silver plated
- 38300-03** Gold plated



**1 tube with
25 percussion caps**

38300-21

Berloque Precision Pistol in Wooden Box

World's smallest pistol
Flare set with 1 Berloque Pistol with screw-on
extension, 25 percussion caps and 10 flares

- 38300-04** Silver plated



**1 pack
with 10 flares**

38300-22

A large rectangular area consisting of 25 horizontal grey bars, intended for writing notes.



04 | KNIVES



Jagdnicker Knives	<i>Page 110</i>
Hunting Knives	<i>Pages 110 – 112</i>
Pocket Cutlery Sets / Multitools	<i>Page 111</i>
Pocketknives	<i>Pages 111 - 112</i>
Outdoor Edge	<i>Pages 113 – 115</i>
Knife Sharpeners	<i>Pages 116 – 117</i>
Knife Care/Accessories	<i>Page 116</i>
Outdoor Edge Knife Sets	<i>Page 118</i>
Knife Pouches	<i>Page 118</i>



Hunting knife stuck into stump © natusenphik



Jagdnicker, 11 cm blade made of 440C steel, with Pakkawood handle and leather sheath
23255-01



Outdoor Knife, 11 cm blade made of 440C steel, with rubber handle and leather sheath
23255-02



Jagdnicker, 10 cm blade made of 440C steel, with staghorn scales and leather sheath
23255-03



Jagdnicker, 10,5 cm blade made of 440C steel, with staghorn handle and leather sheath, total length 21.5 cm
23255-15



Jagdnicker, blade made of 440C steel, with staghorn scales and leather sheath
23200-10 10 cm blade
23200-11 11 cm blade



Bavarian Nicker Knife
 10 cm blade made of 330 Damascus steel, stainless steel ferrule with stag motif, with staghorn handle and leather sheath
23201-01



Hunting Knife, premium stainless steel, with genuine staghorn scales, 7 cm blade
23251-01 1-pc



Hunting Knife, premium stainless steel, with genuine staghorn scales, 7 cm blade
23251-02 2-pc, with gutting blade



Hunting Knife, premium stainless steel, with genuine staghorn scales, 7 cm blade
23251-03 3-pc, with gutting blade and corkscrew



Hunting Knife, premium stainless steel, with genuine staghorn scales, 7 cm blade
23251-04 4-pc, with gutting blade, saw and corkscrew



Hunting Knife, premium stainless steel, with genuine staghorn scales, 7 cm blade
23251-05 2-pc, with saw



Hunting Knife, premium stainless steel, genuine staghorn scales, 7 cm blade
23251-06 3-pc, with gutting blade and saw





Hunting Knife, premium stainless steel, with genuine staghorn scales, 7 cm blade
23251-12 2-pc, with saw



Hunting Knife, premium stainless steel, with genuine staghorn scales, 7 cm blade
23251-13 3-pc, with saw and corkscrew



Hunting Knife, premium stainless steel, with genuine staghorn scales, 7 cm blade
23251-23 3-pc, with gutting blade and awl



Pocket and Hunting Knife, with locking blade, premium stainless steel and Pakkawood scales
23253-01 1-pc, 7 cm blade

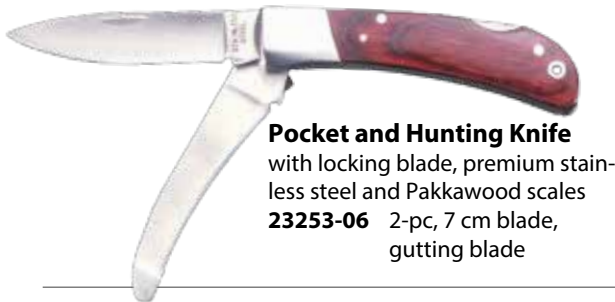

Pocket and Hunting Knife with locking blade, premium stainless steel and Pakkawood scales
23253-06 2-pc, 7 cm blade, gutting blade



Pocket and Hunting Knife 9 cm blade, with integrated clip
23253-10



Pocket Cutlery Set, 5-pc, with fork, knife, spoon, can opener and corkscrew, in nylon case. made of plastic and stainless steel. Dimensions: 14 x 3,2 x 2,7 cm
23121-02



Outdoor Edge Chowpal Multitool Multi-purpose cutlery of stainless steel 420J2, blade length 6,4 cm, overall length 16,5 cm, weight 68 g
23325-01

Display with 10 Lansky Mini Multitools

Needle-nosed pliers, cable cutter, knife, saw, small Philips screwdriver, small, medium and big flat-headed screwdriver, file, awl, bottle opener, can opener
23122-08



Display with 18 Lansky Pocket Knives

Blade of steel 420, length 5,7 cm, rubberized handle 8 cm long, with integrated trousers clip
23253-05





VICTORINOX

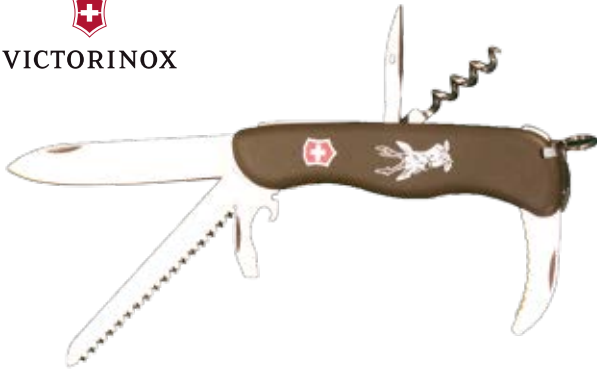

Hunting Knife, 8-pc
23240-01 Green



VICTORINOX



Hunting Knife, 8-pc
23240-02 Red



VICTORINOX



Hunting Knife
23240-04 Hunter XS, 3-pc, Orange/black with large gutting blade and corkscrew



VICTORINOX



Hunting Knife
23240-05 Hunter XT, 4-pc, Orange/black with large gutting blade, saw and corkscrew



Set JaegerPair™
1 x caper knife, blade length 10 cm,
1 x gutting knife, blade length 9,2 cm
weight: 233 g, with nylon sheath
23310-04



Set JaegerGuide™
1 x caper knife, blade length 10 cm,
1 x gutting knife, blade length 9,2 cm,
1 x saw, saw blade length 12,4 cm,
weight: 354 g, with nylon sheath
23310-05



Pocketknife
with 8 functions
silver plated, engraving plate
on back of knife
23204-01 Hunter with deer
23204-02 Group of deer
23204-03 Group of wild boars



**Filleting knife RAZORMAX™**

with 6 replacement blades (3x 8,9 cm and 3x 12,7 cm),
rubbered handle, weight 74 g, with nylon sheath
23301-02 Orange

**Razor-Lite EDC™ Pocketknife**

with 6 replacement blades, blade length 8,9 cm, weight 80 g
23301-01 Orange

**Razor-Blaze™ Pocketknife**

with 6 replacement blades, blade length 8,9 cm,
weight 180 g, with nylon sheath
23302-02 Orange

**Razor-Pro™ Pocketknife with Gutting Blade**

with 6 replacement blades, blade length 8,9 cm,
gutting blade 7,9 cm, weight 235 g, with nylon sheath
23303-01 Orange

**Razor-Pro/Saw Combo™ Set**

Pocketknife with gutting blade, with 6 replacement blades,
blade length 8,9 cm, gutting blade 7,9 cm, saw with blade
length 11,1 cm, weight 315 g, with nylon sheath
23304-01 Orange

**Zip-Pro™ Pocket Gutting Knife**

Blade length 9 cm, weight 90 g
23316-01 Orange

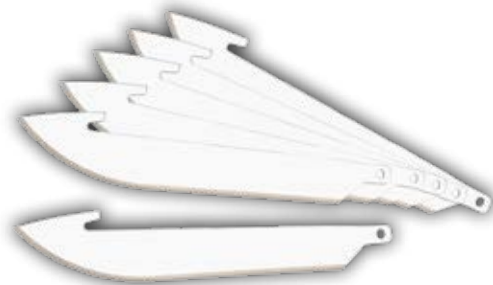
**6 replacement blades for all Razor-Lite™ knives**

23305-01 8,9 cm
23305-02 12,7 cm



Swing Blaze™/Swing Blade™ Knife
with gutting blade, blade length 9 cm,
gutting blade 8,1 cm, weight 205 g, with nylon sheath
23306-01 Orange



Swing Blaze™/Swing Blade™ Knife
with gutting blade, blade length 9 cm,
gutting blade 8,1 cm, weight 205 g, with nylon sheath
23306-02 Black



SwingBlaze™/Swing Blade™ Set
Swing Blaze/Swing Blade knife and saw,
blade length 15,2 cm, weight 335 g, with leather sheath
23307-01 Orange



Set WILDGUIDE™
1 x caper knife, blade length 6,4 cm,
1 x knife with gut hook, blade length 10,2 cm,
1 x saw, blade length 12,4 cm,
weight: 323 g, with nylon sheath
23310-03 Orange



**Flip n' Blaze™/Flip n' Zip™
Pocketknife with Gutting Blade**
Blade length 8,8 cm, weight 205 g, with nylon sheath
23308-01 Orange



Flip n' Blaze Saw Combo™ Set
Pocketknife with gutting blade,
blade length 8,8 cm, with saw, blade length 11,2 cm,
weight 315 g, with nylon sheath
23309-01 Orange





Grip™ Pocketknife

Blade length 8,1 cm, weight 113 g, with nylon sheath
23315-01 Orange **23315-02** Black



Mini Grip™ Pocketknife

For right and left-handers,
 blade length 5,6 cm, weight 40 g
23314-01 Orange **23314-02** Black



Pocket knife TRAILBLAZE™

Blade length 8,4 cm, weight 74 g, with trousers clip
23315-03 Orange



Survival knife IGNITRO™

Blade length 5,7 cm, with
 signal whistle, flintstone and
 tinder, weight: 42,5 g
23318-01 Orange



Grip Hook Blaze™ Pocketknife, with gut hook, blade
 length 8,1 cm, weight 113 g, with nylon sheath
23313-01 Orange



Wild-Skin™ Knife

with gut hook, blade length 9,5 cm,
 weight 125 g, with nylon sheath
23310-01 Orange



Wild-Pair™ Knife, with nylon sheath
 1 x with gut hook, blade length 9,5,
 1 x caper knife, blade length 6,4 cm
23310-02 Orange



Flip n' Zip Saw

Thin and compact, foldable,
 blade length 11,2 cm, weight: 70 g,
 with nylon sheath
23350-04 Orange



Flip n' Saw™

Ultra thin, blade length 18,8 cm,
 weight 150 g, with nylon sheath
23350-02 Black



Stable Game Shears

made of stainless steel 420J2,
 with rubberized handles, blade length 8,9 cm,
 overall length 25,4 cm, weight: 300 g, with nylon sheath
23334-01



Lansky Standard Sharpening Kit
with sharpening angle setting of 30°, 25°, 20° and 17°, with 3 hones, coarse, medium and fine, 1 knife clamp with angle selection and 3 guide rods, specially formulated honing oil
23191-01



Lansky Deluxe Sharpening Kit
with sharpening angle setting of 30°, 25°, 20° and 17°, with 5 hones, extra coarse, coarse, medium, fine and ultra-fine, 1 knife clamp with angle selection and 5 guide rods, specially formulated honing oil
23191-02



Lansky Diamond Sharpening Kit
with sharpening angle setting of 30°, 25°, 20° and 17°, with 3 diamond hones, coarse, medium and fine, 1 knife clamp with angle selection and 3 guide rods, specially formulated honing oil
23191-05



Lansky Diamond Sharpening Kit
with sharpening angle setting of 30°, 25°, 20° and 17°, with 4 hones, extra coarse, coarse, medium and fine, 1 knife clamp with angle selection and 4 guide rods, specially formulated honing oil
23191-06

Lansky Accessories

Universal Mount
23191-11



Lansky Accessories
Super "C" Clamp
23191-12



Lansky Accessories
Honing oil 120 ml
23191-20



Diamond Hones

- 23191-21** Silver – extra coarse
- 23191-22** Violet – coarse
- 23191-23** Orange – medium
- 23191-24** Gold – fine

Hones

- 23191-25** Black – extra coarse
- 23191-26** Red – coarse
- 23191-27** Green – medium-fine
- 23191-28** Blue – fine
- 23191-29** Yellow – ultra-fine
- 23191-30** V-shaped hone for serrated knives





Lansky Sharpener
23191-07



Lansky Quick Fix Pocket Sharpener
for sharpening and polishing
23191-08



Lansky Universal Pocket Sharpener
For sharpening and polishing all blades with straight and serrated edge
23191-14



ROADIE™ - Sharpener tool as keyring pendant made of light metal
Tungsten carbide sharpener, cable cutter, bottle opener, screw driver pan head (can opener), screw driver cross slot, variable hexagon wrench, nail puller
23191-15



Sharp-X™ Knife Sharpener
23360-01 in blister package PU 12
23360-02 18 pieces in display



SHARP'N CUT™ - Knife sharpener
with integrated small ceramic blade and built-in magnet
23191-16



Outdoor Edge Knife Sharpener Sharp-Edge-X Pro™
23360-03 in blister



Wild-Lite™ 6-pc Knife Set

2 knives: blade length 12,7 and 6,4 cm,
 1 gutting knife: blade length 10,2 cm,
 1 knife sharpener, gloves and case
23330-01



Wild-Pak™ 8-pc Knife Set

2 knives: blade length 12,7 and 6,4 cm,
 1 gutting knife: blade length 10,2 cm,
 1 saw: blade length 15,2 cm,
 1 ribcage spreader, knife sharpener, gloves and case
23331-01



Butcher-Lite™ 8-pc Knife Set

2 knives: blade length 15 and 10,8 cm,
 1 gutting knife: blade length 11,5 cm,
 1 saw: blade length 15,2 cm,
 1 ribcage spreader, knife sharpener and gloves, in belt scabbard
23332-01



Game Processor™ 12-pc Knife Set

3 knives: blade length 21, 15 and 10,8 cm,
 1 gutting knife: blade length 11,5 cm,
 1 saw: blade length 25,8 cm,
 1 carving fork, 1 game shears, 1 ribcage spreader,
 1 knife sharpener, 1 cutting board, gloves and 1 case
23333-01



Knife or Magazine Pouch

made of nylon, with belt loops
32376-01 12 x 5 cm



05 | GEAR



Rucksacks	<i>Pages 120 – 123</i>
Hunting Pouches	<i>Pages 123 – 124</i>
Hunting Horns	<i>Page 125</i>
Seat Cushions	<i>Page 126</i>
Rifle Slings	<i>Pages 127 – 133</i>
Cartridge Belts	<i>Pages 134 – 135</i>
Cartridge Bags	<i>Page 135</i>
Cartridge Pouches	<i>Pages 135 – 137</i>
Game Bird Carrier	<i>Page 137</i>
Lamps and Accessories	<i>Pages 138 – 139</i>
Self-protection	<i>Page 139</i>
Heating	<i>Pages 140 – 141</i>
Mosquito Repellent	<i>Page 142</i>



Bag Liners:

32213-02 60 x 65 cm

32213-03 55 x 60 cm

32213-04 50 x 55 cm



Hunting Rucksack

made of durable linen, with liner

32210-02 2 patch pockets, 55 x 60 cm

32210-19 2 patch pockets, 50 x 55 cm



Hunting Rucksack

made of durable linen, with liner, with padded straps with buckle guard, high-quality cowhide trim

32210-04 3 patch pockets, 60 x 65 cm



Silent

Rucksack, linen

Absolutely noiseless, without any metal, with liner

32210-10 4 patch pockets, gun holder, 60 x 60 cm, with leather bottom



Silent Rucksack, linen

Absolutely noiseless, without any metal, with liner

32210-06 3 patch pockets, 55 x 60 cm



Hunting Backpack

Camouflage, made of nylon, padded back and straps, breathable mesh back, kidney protection, removable top

32210-34 5 outer pockets and 2 bottle holders, 50 x 30 x 20 cm



Hunting Rucksack

made of loden-like material, green, with liner and padded straps

32210-12 2 outer pockets, 55 x 60 cm



Bag Liners:

32213-02 60 x 65 cm

32213-03 55 x 60 cm

32213-04 50 x 55 cm



Silent Rucksack, loden
 Absolutely noiseless, without any metal, with liner
32210-05 2 patch pockets, 50 x 55 cm



Silent Rucksack, loden
 Absolutely noiseless, without any metal, with liner
32210-08 3 patch pockets, 55 x 60 cm



Silent Rucksack, loden
 with wooden toggles and liner, leather straps
32210-09 2 outer pockets, 55 x 50 cm



Silent Rucksack
 made of loden-like material (82% wool, 18% nylon),
 liner and padded leather straps with buckle guard
32210-18 1 outer pocket, 55 x 50 cm



Silent Hunting Rucksack
 made of loden-like material (82% wool, 18% nylon),
 with liner and padded leather straps
32210-17 3 outer pockets, 55 x 60 cm



Silent Rucksack, loden
 with seat cushion 34 x 35 cm in back,
 with padded leather straps and liner
32210-11 2 outer pockets, 64 x 54 cm

Bag Liners:

32213-02 60 x 65 cm

32213-03 55 x 60 cm

32213-04 50 x 55 cm



Small Hunting Rucksack
made of loden-like material, with nylon lining, with padded back and padded leather straps
32210-32 3 outer pockets, 26 x 40 x 13 cm



Silent Rucksack, loden
Basic design without flap and outer pockets, with liner and 5 inner pockets, leather straps
32210-13 70 x 55 cm



Silent Rucksack
made of velveteen
32210-07 2 outer pockets and liner, 50 x 50 cm



Hunting Rucksack
made of nylon
32210-23 2 outer pockets, 2 side zippers, 28 x 20 x 50 cm



Hunting Rucksack, made of nylon
32210-37 2 patch pockets, sweepable, padded straps, with embroidery deer head, 40 x 45 cm



Hunting Rucksack, made of nylon
32210-38 2 patch pockets, sweepable, padded straps, with embroidery wild boar, 40 x 45 cm



Bag Liners:

32213-02 60 x 65 cm

32213-03 55 x 60 cm

32213-04 50 x 55 cm



Exclusive Outdoor Rucksack

made of mud-colored canvas with removable liner, with leather details

32210-25 2 outer pockets, 40 x 29 x 13 cm



Exclusive Outdoor Rucksack

made of mud-colored canvas with removable liner, with artificial leather details

32210-26 2 outer pockets, 35 x 34 x 17 cm



Exclusive Fashion Hunting Pouch, in taupe colored canvas, with faux leather edging, 4 game straps

32302-22 24 x 24 x 10 cm



Rucksack with Stool

made of durable linen, with straps, strong and sturdy aluminum frame, seat height 50 cm, seat 34 x 26 cm

34320-17 3 outer pockets



Hunting Pouch

brown, made of loden-like material (100% wool) combined with leather, with nylon lining, main compartment with 2-way zipper, 2 outer pockets, 1 big rear compartment

32302-19 33 x 23 x 10 cm



Hunting Pouch

brown, of cow leather, cover combined with wool

32302-05 26 x 22 cm



Hunting Pouch
made of cowhide, brown, without front pocket,
with game bird carrier
32302-01 23 x 20 cm



Hunting Pouch
made of cowhide, brown, with front pocket
32302-03 24 x 22 cm



Hunting Pouch
made of cowhide,
brown, with front pocket
32302-08 26 x 22 cm



Hunting Pouch
Leather/loden,
deer embroidery, with
front pocket and 7 cartridge slots
32302-10 27 x 22 cm



High-quality Hunting Pouch
made of Italian saddle leather, cognac color, with front
pocket and 7 cartridge pockets
32302-12 27 x 22 cm



High-quality Hunting Pouch
made of Italian saddle leather, cognac color, with front pocket
32302-13 24 x 22 cm



Hunting Pouch
Leather/canvas, with front pocket
32302-09 24 x 22 cm



Hunting Pouch
Leather combined with canvas, green
32302-26 27 x 20 cm



Original Pless Hunting Horns

2-coil with leather straps and mouthpiece

with artificial leather wrapping

33450-01 Pless hunting horn

33450-02 Pless hunting horn with tuning slide

33450-03 Pocket hunting horn in B, 6-coil

with genuine leather wrapping

33450-11 Pless hunting horn

33450-12 Pless hunting horn with tuning slide

33450-13 Pocket hunting horn in B, 6-coil



Die deutschen Jagdsignale

48200-07 CD – "German Hunting Calls"



Pless Hunting Horn

with tuning slide, genuine leather wrapping, leather straps and mouthpiece

33454-01 with silver-colored fittings and silver-colored mouthpiece

33454-02 Polished brass



Pocket Hunting Horn 6-coil

with genuine leather wrapping and mouthpiece

33454-03



Horn made of Genuine Buffalo Horn

33453-02 approx. 20 cm



Pless Hunting Horn Bag

made of nylon, with front pocket and strap

32372-04



Bugles with Leather, Green

33452-01 **33452-02** **33452-03**

15 cm 21 cm 25 cm



Bugles Polished Brass

33452-04 **33452-05** **33452-06**

15 cm 21 cm 25 cm



Bugles Polished Brass

33452-10 26 cm **33452-11** 31 cm



Seat Cushion
olive green, inflatable, PU 5
33333-01 30 x 40 cm



Seat Cushion
Super lightweight, made of water-repellent nylon, 1 cm-thick insulation, with elastic band and loop to hang up
33333-02 40 x 28 cm



Thermal Seat Cushion
green, self-inflating
33333-05 44 x 33 x 3.8 cm



Felt Cushion
Naturally-mottled wool felt
33333-08 45 x 31 cm, 15 mm thick
33333-09 50 x 40 cm, 20 mm thick, with strap



Seat Cushion with Belt
Quicksnap THERM-A-SEAT® made of closed-cell foam, lightweight, warm, coated seat – silent
33333-14 33 x 35 x 2 cm



Folding Seat Cushion
with backrest and belt, THERM-A-SEAT® made of closed-cell foam, lightweight, warm, water-repellent, noiseless
33333-17 Seat: 33 x 35.5 x 4 cm
Back: 46 x 35.5 x 2 cm



Seat Cushion
THERM-A-SEAT®, made of closed-cell foam, lightweight, warm, water-repellent, with carrying strap, 33 x 35 cm
33333-11 2 cm thick, brown
33333-12 4 cm thick, brown



Rifle Sling made of Durable Leather

10-strand braid,
brown, 40 mm wide
32225-01

**Rifle Sling made of Durable Leather**

8-strand braid with non-slip
suede back, brown,
30 mm wide
32225-02

**Rifle Sling made of Durable Leather**

8-strand braid,
green/brown, 30 mm wide
32225-03

**Rifle Sling made of Durable Leather**

8-strand braid,
brown, 30 mm wide
32225-07

**Rifle Sling made of Durable Leather**

with braided design,
dark brown, with rubber
back, 30 mm wide
32225-43

**Rifle Sling made of Durable Leather**

for shotguns without sling
swivels, dark brown, with
rubber back, 30 mm wide
32225-08

**Rifle Sling made of Durable Leather**

Wooden toggle strap,
dark brown,
20 mm wide
32225-10

**Rifle Sling made of Durable Leather**

Silent toggle strap, dark
brown, with rubber back,
30 mm wide
32225-11



Rifle Sling made of Durable Leather

Dark brown, anti-slip back, 28 mm wide
32225-05



Rifle Sling made of Durable Leather

Dark brown, smooth, with rubber back, 31 mm wide
32225-06



Rifle Sling made of Durable Leather

Dark brown, smooth, with suede padding, 30 mm wide
32225-09



Loden Rifle Sling with leather trim

with rubber back, 32 mm wide
32225-19



Rifle Sling made of Durable Leather

Dark brown, with grooved rubber back, 30 mm wide
32225-24



Rifle Sling made of Durable Leather

Dark brown, with anti-slip back, 30 mm wide
32225-25



Rifle Sling made of Durable Leather

Dark brown, smooth, with rubber back, 30 mm wide
32225-26



Rifle Sling made of Durable Leather

Dark brown, with rubber back, 30 mm wide, with loops for 3 cartridges
32225-56



Rifle Sling made of Durable Leather

Embossed, dark brown, with rubber back, 30 mm wide
32225-46

**Rifle Sling made of Durable Leather**

Embossed, dark brown, with rubber back, 40 mm wide
32225-49

**Rifle Sling made of Durable Leather**

Embossed, dark brown, with rubber back, 40 mm wide
32225-50

**Rifle Sling made of Durable Leather**

Embossed, dark brown, with rubber back, 30 mm wide
32225-52

**Rifle Sling made of Durable Leather**

Black, with rubber back, 30 mm wide, hemmed edges with leather
32225-31

**Rifle Sling made of Durable Leather**

Dark brown, suede back, 45 mm wide
32225-39

**Rifle Sling made of Durable Leather**

Dark brown, suede back, 28 mm wide
32225-40

**Rifle Sling made of Durable Leather**

Dark brown, embroidered with deer head, 30 mm wide
32225-14 with rubber back



Rifle Holder Strap

Support rest made of galvanized steel with calfskin cover. Place your rifle or shotgun into the holder with the trigger guard against the support rest. Hold the stock under your arm. **32225-95**



Rifle Sling made of Durable Leather

Dark brown, embroidered with deer head, 30 mm wide **32225-15** Padded



Rifle Sling made of Durable Leather

Loden, 70 mm wide, with rubber back, 30 mm wide

32225-75 Embroidered with wild boar

32225-76 Embroidered with roe deer head/horn

32225-78 Embroidered with deer head

Rifle Sling made of Durable Leather

Embossed with rubber back, 5 cm wide

32225-84 Roe deer
32225-85 Deer
32225-86 Wild boar



Rifle Sling made of Loden

with rubber back, 30 mm wide, embroidered with oak leaf border **32225-18**



Rifle Sling made of Loden
with rubber back,
30 mm wide, green,
embroidered with deer head
32225-20



Rifle Sling made of Loden
with rubber back, 30 mm wide,
green, embroidered with
roe buck/hunting horn
32225-23



Rifle Sling made of Durable Leather
with rubber back, 30 mm wide,
dark brown, embroidered with
roe deer head/horn
32225-35



Rifle Sling of leather
with neoprene back, width 50 mm
32225-72



The Following Rifle Slings Are Available with Company Imprint or Embroidery
Minimum order quantity 20 units per model

with Imprint *: 32225*05, *06, *09, *10, *19, *24,
*25, *26, *39, *40, *56
with Embroidery +: 32225+05, +06, +09, +10,
+19, +24, +26



Rifle Sling with Custom Printed Insert
Minimum order quantity
20 units per model

32225.09 Leather





Rifle Sling made of high-quality Cowhide with Ball Head quick-release Fasteners

brown, handmade, non-slip, damping rubber back, 117 cm long

32225-42 Adjustable length, 40/18 mm wide



Rifle Sling made of high-quality Cowhide

with Ball Head quick-release Fasteners, brown, handmade,

non-slip, damping rubber back, 117 cm long

32225-54 Smooth, with hand strap, 45 mm wide



Rifle Sling made of high-quality Cowhide

with Ball Head quick-release Fasteners, brown,

handmade, non-slip, damping rubber back, 117 cm long

32225-55 Smooth, with thumb loop, 45 mm wide



Rifle Sling made of high-quality Cowhide

with Ball Head quick-release Fasteners, brown, handmade,

non-slip, damping rubber back, 117 cm long

32225-59 with braided design, 35 mm wide



Rifle Sling made of Neoprene

with quick-release for sling swivel base, adjustable length 90 - 125 cm

32225-89 Neoprene rifle sling, brown/green, 50 mm wide



Rifle Sling made of Neoprene

with quick-release for sling swivel base, adjustable length 90 - 125 cm

32225-90 Neoprene rifle sling, black/orange, 50 mm wide



Rifle Sling made of Neoprene

with rubber back, 60 mm wide

32225-61



Rifle Sling made of Neoprene
with rubber back,
60 mm wide,
very comfortable to wear
32225-62



Rifle Sling made of Neoprene
with quick-release for sling swivel base
32225-63 75 mm wide

32225-65 65 mm wide

Backpack Rifle Sling made of Neoprene
50 mm wide
32225-70



Rifle Sling made of Nylon
Padded, 70 mm wide, camouflage
32225-69



Rubber Rifle Sling
with quick-release for sling swivel base, adjustable length 85 – 115 cm, camouflage
32224-06



Rubber Rifle Sling, with quick-release
for sling swivel base, height-adjustable grip, comfortable to wear, adjustable length 90 – 120 cm, 60 mm wide
32224-07 Black **32224-08** Green



VFG Felt Shoulder Piece for Rifle Sling
can also be used as a gun rest for shooting
32225-99





High-quality Cartridge Belt made of Italian Saddle Leather for 12 Gauge
for 25 shells, closed, suede back, cognac color
32350-10



Cartridge Belt made of full-grain Leather for 12 + 16 Gauge
for 24 shells, closed
32350-04



Cartridge Belt made of full-grain Leather for 12 + 16 Gauge
for 20 shells, closed, with belt extension up to 170 cm
32350-13



Cartridge Belt made of full-grain Leather
for 20 shells, closed
32350-08 for 12 + 16 gauge **32350-18** for 20 gauge



Cartridge Belt made of full-grain Leather for 12 + 16 Gauge
for 24 shells, open
32350-05



Cartridge Belt made of Nylon, Green, for 12 + 16 Gauge
25 shells, closed
32350-02



Cartridge Belt made of Nylon, Green, for 12 + 16 Gauge
for 20 shells, open
32350-15





Cartridge Belt made of Nylon,
Green, with Leather, for 12 + 16 Gauge, for 20 shells, with
leather, closed, 120 cm long
32350-20



Cartridge Bag made of Cowhide
with belt loop
32351-01



**Cartridge Pouch made
of full-grain Leather**
for 11 rifle cartridges
32375-02



**Cartridge Pouch made
of full-grain Leather**
for 5 rifle cartridges
32375-12



**Cartridge Pouch made
of full-grain Leather**
for 6 rifle cartridges
32375-13



**Cartridge Pouch made
of full-grain Leather**
for 10 rifle cartridges
32375-11



**Cartridge Pouch made
of full-grain Leather**
for 5 rifle cartridges,
loden inside
32375-15 Standard
32375-20 Cal. 10.3 x 60
32375-21 Cal. 5.6 x 52/
.222 Rem.



**Cartridge Pouch made
of full-grain Leather**
for 2 shotshells, 3 rifle
cartridges and 5 magnum
cartridges, loden inside
32375-14



**Cartridge Pouch
made of Loden**
for 7 rifle cartridges, with
leather trim
32375-22



**Cartridge Pouch
made of Loden**
Universal pouch, stock
individually from 5
shotshells to 2 shotshells
and 6 rifle cartridges, with
leather trim
32375-23



Cartridge Pouch with Embroidery
Loden with leather trim, for 7 rifle cartridges, embroidered with
32375-28 wild boar head



Cartridge Pouch with Embroidery
Loden with leather trim, for 7 rifle cartridges, embroidered with
32375-29 hunting horn



Cartridge Pouch with Embroidery
Loden with leather trim, universal pouch, stock individually from 5 shotshells to 2 shotshells and 6 rifle cartridges, embroidered with
32375-30 deer head



Cartridge Pouch with Embroidery
Felt, for 5 rifle cartridges, embroidered with
32375-34 wild boar head



Cartridge Pouch with Embroidery
Felt, for 5 rifle cartridges
32375-35 Embroidered with deer head



Cartridge Pouch with Embroidery
Felt, for 5 rifle cartridges, embroidered with
32375-36 hunting horn



Cartridge Pouch made of Felt
for 5 rifle cartridges
32375-04



Cartridge Pouch made of Felt
for 3 rifle cartridges and 2 shotshells
32375-03



Rifle Cartridge Pouch
made of nylon, green, with belt loops, for 10 rifle cartridges
32375-52



Rifle Cartridge Pouch
made of nylon, green, with belt loops, for 7 rifle cartridges
32375-51



Rifle Cartridge Pouch
made of nylon, green, with belt loops, for 5 rifle cartridges
32375-56



Rifle Cartridge and Shotshell Pouch
made of nylon, green, with belt loops, for 4 shotshells and 3 rifle cartridges
32375-57





Gun Stock Cartridge Pouch
for 6 shotshells, with rubber loops
32375-18



Gun Stock Cartridge Pouch
for 6 rifle cartridges, with rubber loops
32375-24



Gun Stock Cartridge Pouch
for 4 shotshells and 3 rifle cartridges, with rubber loops
32375-19



Cartridge Pouch for Forearm
32375-32 for 1 rifle cartridge and 1 shotshell
32375-31 for 2 rifle cartridges



Stock Rest made of Felt
1,5 cm thick, with cartridge loops
and velcro straps
32375-60 10 x 10 cm
32375-61 15 x 10 cm
32375-62 30 x 13 cm



Game Bird Carrier
made of Leather
Brown
32200-04 Pheasant



Game Bird Carrier
made of Leather
Dark
32201-01



Portable LED lamp

9 CREE LEDs. 3 Watt each, 2000 lumens, light emission Ø 120 mm, splashproof, with thread for tripod
33322-03 with cable for 12 Volts, approx. 4 meters long
33322-24 with a rechargeable battery for approx. 50 minutes lighting time

Portable Halogen lamp

100 watts, 1800 lumens, light emission Ø 150 mm, cable length approx. 4 with 12-volt plug
33322-04



Laser Flashlight

Class 2M, - 5° to + 45°C, focusable beam, provides light for 6 hours, power 18 mW, wavelength 532 nm, with additional cable switch
33322-05



Sub Zero Laser Flashlight

Class 2 M, operating range: - 20°C to + 50°C, focusable beam from 7 cm to 7.8 m to 100 m, provides light for 5 hours, power 50 mW, wavelength 532 nm, weight: 258 g, length: 198 mm, head Ø 34 mm, Ø shaft 30 mm, rechargeable 18650 battery included, accessories: cable switch, 2 charger for 220 V and car charger
33322-07



Flashlight, luminosity 500 lumens, focusable, 3 different levels of brightness + strobe + SOS flashing light, provides light for: 3 hours, can also be used with rechargeable 18650 lithium battery, length 14 - 16 cm, weight 185 g, head Ø 35 mm, Ø shaft 27 mm, requires 3 AAA batteries (not included)
33322-21



Headlamp with touch-switch

High performance LED Cree XPG 250 Lumen (adjustable high and low), lateral lighting with green COB LED (Chip-on-Board), no accidental switch-on when it is stored in the rucksack etc., 3 AAA batteries included
33322-22





Ranger Headlamp

1 high-power LED 150 lumens + 3 green and 4 red LEDs,
3 AAA batteries included
33322-20



Headlamp Force XP

High performance LED Cree XT-E S3,
Provides light for 3 to 64 hours,
waterproof IPX6, 3 AAA batteries included
different light modes:
• 350 Lumen • Green – 5,5 Lumen
• 15 Lumen • Flashlight
• Red – 3,2 Lumen
33322-23

SELF-PROTECTION



1 + 2

Animal defence spray PU 20

- 33501-01** Pfeffer-KO (pepper), 15 ml
- 33501-02** Pfeffer-KO FOG (pepper), 50 ml
- 33501-03** Pfeffer-KO FOG (pepper), 40 ml
- 33501-04** Pfeffer-KO Jet (pepper), 50 ml
- 33501-05** Pfeffer-KO Jet (pepper), 40 ml
- 33501-07** Defence spray KO-CS Gas, 40 ml



Electronic Dog Deterrent

Original DAZER – electronic ultrasonic dog deterrent
(25,000 Hz), Batteries included
35305-04



Portable Heater

Butane heater with automatic oxygen-deficiency switch, heating power 1.2 KW, burning time at full power 2.5 hours, weight 1.5 kg, dimensions: 30 x 26 x 13 cm

33329-10

33329-11 Gas cartridge



33329-04



33329-06



33329-03

Hand Warmer

Ideal for hunting, fishing and sports,

33329-03 Pocket heater/hand warmer in green fabric sheath, PU 10

33329-04 Fuel sticks for hand warmer, PU 10, 12-ct packs

33329-06 Gas pocket heater, PU 6

33329-07 Replacement mantle



33329-08



33329-09



Disposable Heat Packs

Non-toxic, 1 pair (1 box = 30 pairs)

33329-08 Toe warmer

33329-09 Hand warmer



33329-12

33329-13

33329-17



33329-14



Disposable Heat Packs

Non-toxic, 30 count in display

33329-12 Foot warmer, 1 pair, size S = 36 – 40

33329-13 Foot warmer, 1 pair, size L = 41 – 43

33329-17 Foot warmer, 1 pair, size XL = from 44

33329-14 Body warmer, self-adhesive





Thermal shoe insoles

- Anti-slip layer
- Perfect for winter wear
- Memory foam for optimal comfort
- Core foam for fitting and support
- Insulating aluminium layer
- Extra bottom layer for additional stability and shock absorption

28234-39 – 46 Size 39 - 46



Comfort shoe insoles

- Breathable micro-perforations for air and moisture
- Skin compatible microfibre velours surface material
- Memory foam for optimal comfort
- Core foam for fitting and support
- Extra bottom layer for additional stability and shock absorption

28233-39 – 46 Size 39 - 46



Power Bank Electronic Hand Warmer

- with integrated LED light
- heating power up to max. 5 hours
- 2 heating levels: low 40 – 45°C, high 50 – 55°C
- Power Bank for charging mobile phones, etc.
- charging capacity 6800 mAh
- various charging adapters and fabric case included
- charge via USB cable
- dimensions: 10x7x2,9 cm
- weight: 145 g

33329-15

Tealight Heating

Dimensions
31 x 23 x 5 cm
33329-16



Reusable Dehumidifiers

for weapon safes and equipment, with humidity indicator, can be regenerated in the microwave oven, 2 x 200 g

33329-30



Stichfrei Mosquito Spray

Mosquito repellent – sunscreen – skin care – sport oil
Stichfrei provides up to 8 hours of reliable protection against pesky mosquitoes, horseflies and ticks. It leaves skin hydrated and contains active UV-B filters (SPF 6) as a sunscreen. It also helps prevent muscles from cooling down during sports activities. Ballistol-Stichfrei dermatologically tested for skin friendliness. It is toxicologically safe and environmentally friendly.

- 33506-01** 10 ml – pump spray
- 33506-02** 125 ml – spray
- 33506-04** 100 ml – pump spray
- 33506-05** Package with 10 wipes, PU 20 packs in display



**Please use Stichfrei carefully!
Always read label and
product information!**



Stichfrei Kids

Provides reliable protection for up to 4 hours, contains safe mosquito repellent and is therefore suitable for babies 2 months of age or older and for pregnant women.

- 33506-06** 125 ml lotion tube, PU 12
- 33506-07** 30 ml lotion tube, PU 12



Stichfrei Counter Display

- 3 x Stichfrei spray,
- 12 x Stichfrei pump-spray 100 ml,
- 12 x Stichfrei pump-spray 10 ml
- 33506-10**



Stichfrei Counter Display

- 30 x Stichfrei pump spray 10 ml
- 33506-13**



Stichfrei Animal Protection against mosquitoes, gadflies and ticks

BALLISTOL Stichfrei offers up to 8 hours reliable protection against annoying mosquitoes (blackflies among others), horse flies, ticks and harvest mites.

- Please use Stichfrei Animal carefully!
Always read label and product information before use!**
- 33506-12** 600 ml pump sprayer

Mosquito Head Net

Strong nylon net with elastic band
32120-02



06 | HUNTING GROUND EQUIPMENT



- Stands** Pages 144 – 145
- Accessories** Page 145
- Hunting Stools**..... Pages 145, 147 – 149
- Hunting Tents, Camouflage Netting**...Page 146
- Seat Sticks** Pages 147, 149
- Shooting Sticks**.....Pages 150 – 151
- Beater / Walking Sticks**.....Pages 152 – 154
- Game Feeding / Baiting**.....Pages 155 – 156
- Game Calls**.....Pages 156 – 160
- Attractants**.....Pages 160 – 163
- Traps**.....Page 164
- Motion Detectors**Page 165
- Warning Systems**Page 165
- Game Camera, Game Clocks** Pages 166 - 167
- Decoys**.....Page 168



jägerstand herbst © Christine



Tree Stand

Easy to transport, sturdy tree stand, foldable, 130 x 60 x 20 cm

33315-11 Height approx. 2,5 m, weight 13 kg

33315-14 Height approx. 3,5 m, weight approx. 18,5 kg

33315-13 Ladder extension 1 m

33315-12 High seat supports for free standing



Telescopic Stand made of Aluminum

with 8 telescopic steps, 2,6 m high, easy to transport, up to 150 kg load, weight: 16 kg

33315-23



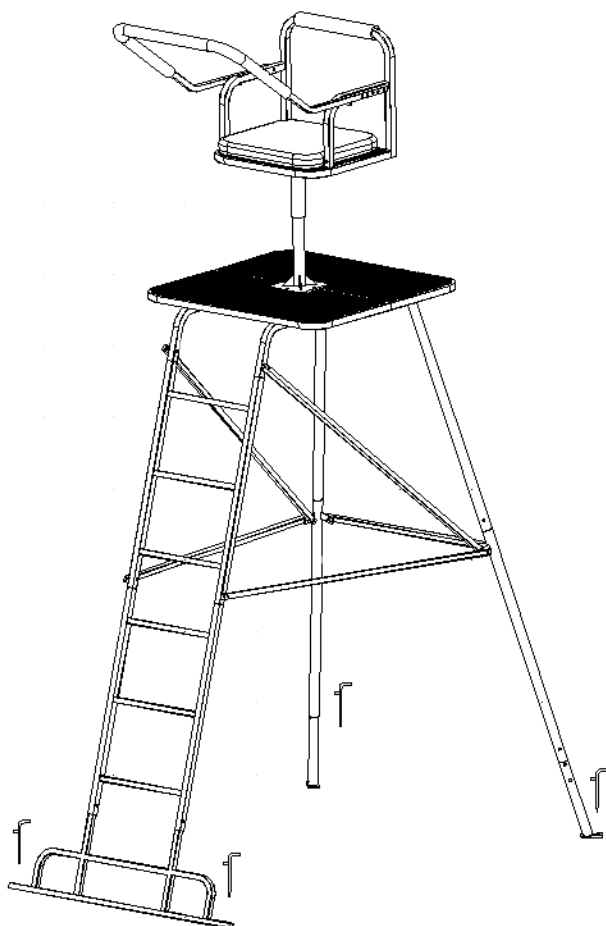

Hunting Stand

freestanding, seat height approx. 2.50 m, with chair swiveling through 360°, padded shooting bar, easy to carry with a net weight of 34 kg, max. payload 135 kg, powder-coated steel
33315-32



Pruning Saw

foldable with lock, saw blade 17 cm
33328-03



Flip n' Saw™

Ultra thin, blade length 18.8 cm, weight 150 g, with nylon sheath
23350-02



Signs

for the car, with 2 suction cups, 215 x 32 mm
33100-02 Print "Jagdschutz"
33100-07 Print "Revieraufsicht"
33100-08 Print "Jagdaufsicht"



Hunting Chair made of Aluminum

with adjustable gun rest, foldable, easy to transport, up to 150 kg load, weight: 8,4 kg
33315-21



Hunting Chair made of Aluminium

with adjustable gun rest, foldable, 4 steps, height 1,5 m, platform 70 x 70 cm, up to 150 kg load, weight: 16,8 kg
33315-22



Camouflage Tent

Folded tent pops up in seconds and can be anchored in the ground using pegs. Large window for good visibility, even from seat sticks, Dimensions: 145 x 145 x 162 cm
34325-02



Tent Chair

Covered foldable chair with armrests, waterproof, sets up in seconds, with carrying case. Dimensions: 90 x 150 cm, 135 cm high
34325-03



Camouflage Tent

with removable roof, ideal for crow and pigeon hunting, Dimensions: 142 x 142 x 165 cm
34325-04



Camouflage Head Net

with Eye Slit, one size
32120-08



Camouflage Gloves

Mesh, one size, extra-long cuffs, REALTREE®XTRA GREEN™
32122-01



Camouflage gun sock REALTREE®XTRA GREEN™

This fray-proof, form-fitting, flexible gun sock camouflages and protects your weapon. It fits on most rifles and shotguns.
32250-03



Camouflage Netting

Spun-bonded fabric, 1,40 x 3,66 m

- 34325-11** REALTREE®XTRA GREEN™
- 34325-12** REALTREE®XTRA™



Camouflage Mesh Netting, very fine and robust netting, 100% nylon, 100% silent, 1,40 x 3,66 m

- 34325-21** REALTREE®XTRA GREEN™
- 34325-22** REALTREE®XTRA™
- 34325-23** ADVANTAGE MAX-5®



Walkstool®

for hunters and fishers, for hikers and mushroom pickers, for camping and soccer fans, for tradesmen, etc....



Walkstool Basic

- 34320-24 **Basic 50**, 50 cm, up to 150 kg load, 650 g
- 34320-25 **Basic 60**, 60 cm, up to 175 kg load, 725 g



Walkstool Comfort

The three-legged stool for any occasion, not larger than a thermos when folded

- 34320-18 **Comfort 45**, 45 cm, up to 200 kg load, 725 g
- 34320-19 **Comfort 55**, 55 cm, up to 225 kg load, 800 g
- 34320-31 **Comfort 65**, 65 cm, up to 250 kg load, 850 g
- 34320-32 **Comfort 75**, 75 cm, up to 250 kg load, 900 g



Walkstool Steady

Prevents the feet from sinking into the ground or slipping on smooth surfaces

34320-99



Seat Stick, with foldable seat made of leather, height adjustable 55 – 75 cm, leather-covered handles

34320-04 Leather-covered frame, foldable bottom disk



Seat Stick, with foldable seat made of leather, height adjustable 60 – 80 cm, leather-covered handles

34320-06 with interchangeable tip



Three-legged Hunting Stool, sturdy design, with durable leather seat
34320-11 Seat height approx. 80 cm



Three-legged Hunting Stool Lighter version
34320-26 Seat height approx. 55 cm



Three-legged Hunting Stool Lighter version
34320-27 Seat height approx. 65 cm



Three-legged Hunting Stool Lighter version
34320-28 Seat height approx. 80 cm



Three-legged Hunting Stool with metal plates and tips, lighter version
34320-29 Seat height approx. 55 cm



Three-legged Hunting Stool with metal plates and tips, lighter version
34320-30 Seat height approx. 75 cm



Three-legged Hunting Stool Canvas with leather corners
34320-14 Seat height approx. 55 cm



Three-legged Hunting Stool Nylon with leather corners, camouflage
34320-15 Seat height approx. 55 cm



Hunting Chair with leather seat, totally secure design, the lower part is made of ash wood and turned so that slipping through is impossible.
34320-01 Seat height approx. 50 cm
34320-02 Seat height approx. 60 cm





Backpack with Stool

made of durable hunting canvas, 3 outer pockets and straps, strong, sturdy aluminum frame, seat height 50 cm, seat 34 x 26 cm

34320-17



Hunting Chair

made of aluminum with green canvas seat and backrest, seat height approx. 40 cm, seat 30 x 33 cm

34320-16



Hunting Seat Stick with Leather Seat

34321-01 Chestnut



Hunting Seat Stick with Leather Seat

Height adjustable, with rotating tip
34321-04 Metal



Three-legged Hunting Stool

Aluminum frame, seat height approx. 50 cm, plastic seat Ø 21 cm, up to 100 kg load

34320-05



Shooting Stick / Alpenstock
with genuine staghorn rest and leather strap, length approx. 170 cm, 2-pc
34322-05 Chestnut



Shooting Stick / Alpenstock
with genuine staghorn rest and leather strap, length approx. 170 cm, 3-pc, length of each approx. 60 cm
34322-06 Hazel



Shooting Stick / Alpenstock
with genuine staghorn rest and leather strap, length approx. 170 cm, 1-pc
34322-16 Chestnut



Root Alpenstock
Length approx. 170 cm, 1-pc, flamed
34322-18 Chestnut



Telescopic Hunting and Shooting Stick
made of sturdy, anodized aluminum shaft, compression fitting for silent, variable height adjustment, with gun rest, 70 – 180 cm
34322-07 Green



Truglo Shooting Stick HIP-SHOT™
adjustable from 55 to 80 cm, for support on the hip
34322-10



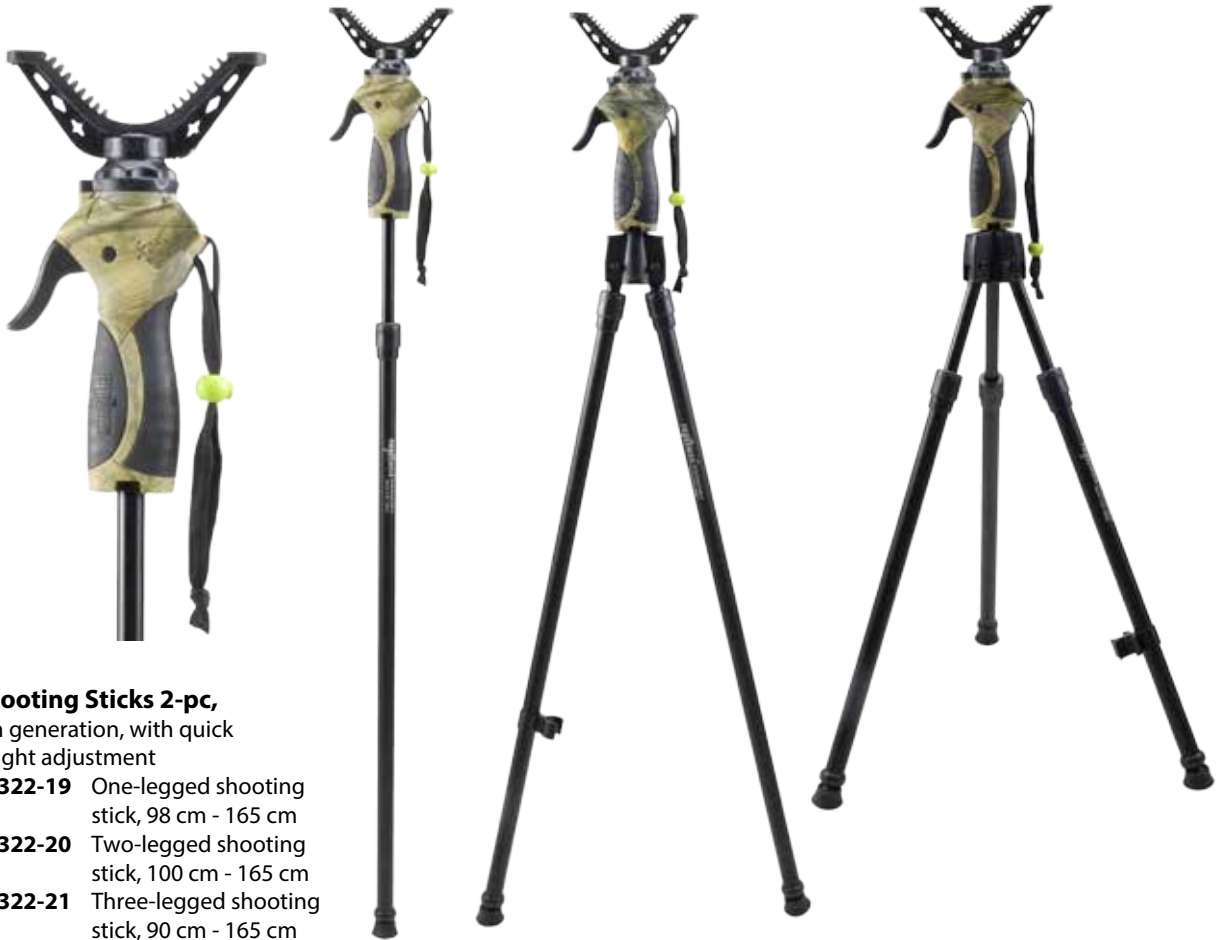

Shooting Sticks 2-pc,
4th generation, with quick
height adjustment

- 34322-19** One-legged shooting
stick, 98 cm - 165 cm
- 34322-20** Two-legged shooting
stick, 100 cm - 165 cm
- 34322-21** Three-legged shooting
stick, 90 cm - 165 cm

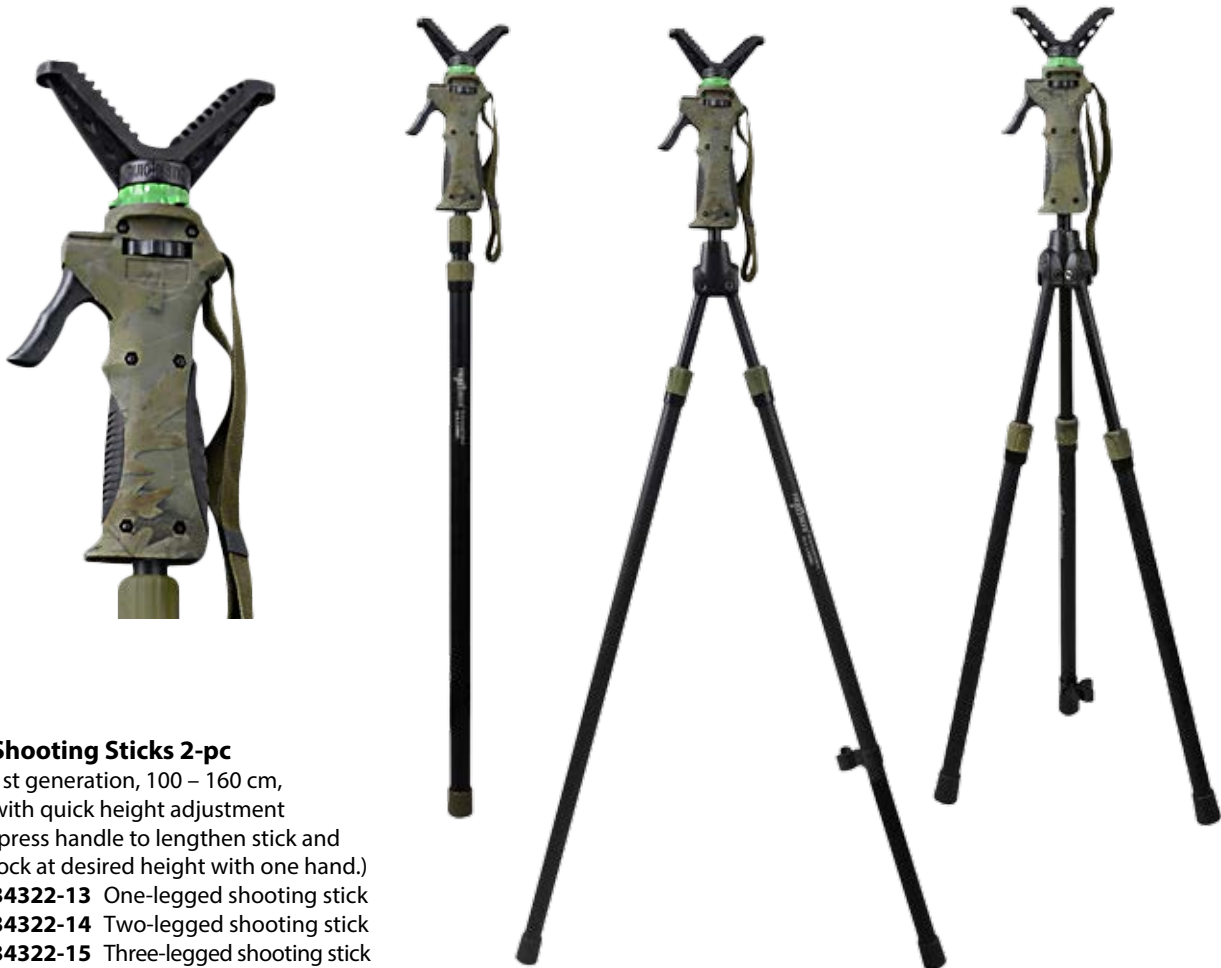

Shooting Sticks 2-pc

1st generation, 100 – 160 cm,
with quick height adjustment
(press handle to lengthen stick and
lock at desired height with one hand.)

- 34322-13** One-legged shooting stick
- 34322-14** Two-legged shooting stick
- 34322-15** Three-legged shooting stick



Walking Stick
34301-11 Chestnut turned



Walking Stick
34301-12 Chestnut turned



Walking Stick
34301-13 Chestnut flamed



Walking Stick
34301-14 Root Stick



Walking Stick
34301-15 Root stick flamed



Walking Stick
34301-16 Imitation oak



Walking Stick
34301-17 Chestnut



Women's Walking Stick
34301-18 Chestnut





Walking Stick
with staghorn handle
34301-01 Chestnut



Walking Stick
with staghorn handle
34301-02 Chestnut turned



Walking Stick
with staghorn handle
34301-03 Blackthorn



Root stick
34301-31 Chestnut turned



Root stick
34301-32 Chestnut turned



Root stick
34301-33 Chestnut



Walking and Beater Stick
34301-34 Imitation bamboo flamed



Walking and Beater Stick
34301-35 with polished handle



Walking and Beater Stick
34301-36 Inca flamed



Beater Stick
34301-37 Chestnut



Walking and Beater Stick
34301-38 Flamed



Walking and Beater Stick
with staghorn handle approx. 138 cm
34301-39 Chestnut



Walking and Beater Stick
with staghorn handle approx. 138 cm
34301-40 Chestnut turned



Root Stick
130 - 140 cm, demountable, 2-pc
34301-41 Chestnut



Root Stick
130 - 140 cm, demountable, 3-pc
34301-42 Chestnut



Rubber Buffer
34318-01 2 pcs each
14/16/18/20/22 mm PU 10
34318-08 8 mm PU 5
34318-10 10 mm PU 5
34318-12 12 mm PU 5
34318-14 14 mm PU 5
34318-16 16 mm PU 5
34318-18 18 mm PU 5
34318-20 20 mm PU 5
34318-22 22 mm PU 5
34318-25 25 mm PU 5



Alpenstock Tips
34319-01 2 pcs each
18/20/22/24/26 mm PU 10
34319-18 18 mm PU 5
34319-20 20 mm PU 5
34319-22 22 mm PU 5
34319-24 24 mm PU 5
34319-26 26 mm PU 5
34319-28 28 mm PU 5



Seat Stick Tip
with plate
34319-03 for wooden stick
34319-13 for metal stick



Rotating Seat Stick Tip
with plate
34319-14 for metal stick



Alpenstock Set, with forged tip
34319-04





Feed Spreader
Electric clock with mechanical timer. Dispenses feed up to 24 times per day, feed output adjustable
33328-21



Feed Spreader
Electric clock with digital timer. Dispenses feed up to 16 times per day, adjustable
33328-22



Feed Spreader with Container
Spreader with analog clock, dispenses feed up to 24 times per day, with metal container in camouflage for approx. 25 kg of feed, (batteries not included)
33328-38



Accessories for Feed Dispenser
33328-23 Battery
33328-39 Solar charger
33328-40 Rechargeable battery



Feed Spreader with Folding Feed Container
30 liter filling capacity, electric clock with digital timer, dispenses feed up to 4 times per day, feed output adjustable
33328-42



LED Wild boar light for feed spreader
with infrared motion detector, green light, brightness adjustable in 3 levels, 180 seconds of light per triggering, weatherproof ABS housing, extremely temperature-resistant from -20°C to 60°C, allround mounting plate, runs with 8 AA batteries (not included)
33328-43

Feed Dispenser for Game Bird Enclosure

for feeding pheasants, ducks and other fowl. made of weather resistant, transparent plastic to create a DIY feeding place using plastic buckets with lids, packaging or canisters, height 13 cm, Ø 6 cm
33324-27



Feed Drum for Wild Boar

for approx. 20 kg of feed, Dimensions: 58 cm, Ø 42 cm
33328-15 Green



Buffalo Horn Deer Call
 Approx. 35/40 cm
33332-01

Deer Call with CD

for successfully hunting rutting deer – developed based on “deer master” Tschernig. The WEGU deer call guarantees excellent tonal resonance thanks to its special design. Does not scare game with unintended, foreign sounds! In sand matt, green rubber quality, comes with CD guide
33332-02



Hubertus Deer Call

Mouthpiece made of wood, sliding tubes to change sound

33332-16 2-pc
33332-17 3-pc



Fox Call

Lightweight and easy to use fox call. Only 89 mm x 15 mm in size and compact so that it can be stowed nearly anywhere and is always within reach. Has an eyelet for attaching to a lanyard. Simply put the call between your teeth and hold it tight using the tiny grooves.

The call is controlled only with the mouth, keeping your hands free so that you can concentrate on holding your gun.

Unlike other fox calls, this one has variable pitches. Bite down harder to produce a higher pitch or loosen your bite to produce deeper pitches.

33332-15



Scotch Duck Call

Simply shake to make the perfect call – works in all weather conditions
33332-05



Fox Call

Creates variable pitches. Imitates hare distress calls
33332-06



Wild Boar Call

Imitates the grunt of wild boar
33332-07



Scotch Goose Call

33332-10



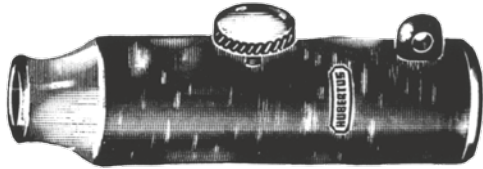

Roe Deer Call

made of cherry or hazel wood with screw to change the pitch, soft and natural tone, with instructions
33332-21

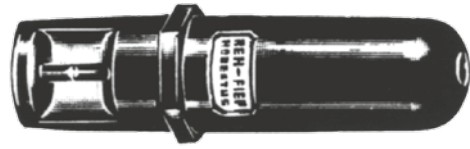

Roe Deer Call

made of artificial horn, adjustable from fawn call to grunt, with case and instructions
33332-22

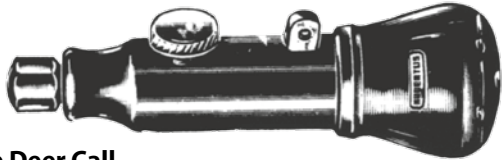

Roe Deer Call

Screw for changing from fawn call to grunt with silencer ball and mouthpiece screw connection to prevent foreign objects from entering, with instructions
33332-23

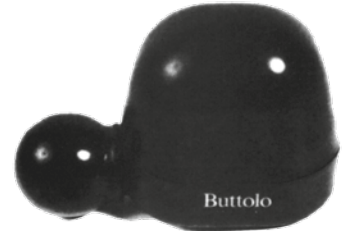

Buttolo Call

Deer and distress call, pneumatic, with instructions, 10-ct box
33332-39



Buttolo Universal Mouth Call

made of artificial horn, with instructions in case
33332-40

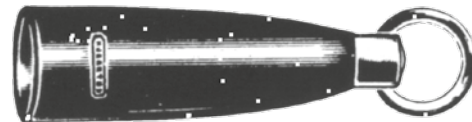

Mouse Whistle (for Fox)

Plug-in
33332-24

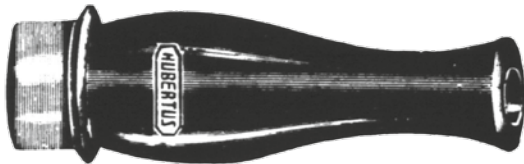

Hare and Rabbit Call

Varnished wood, with nickel cap
33332-25

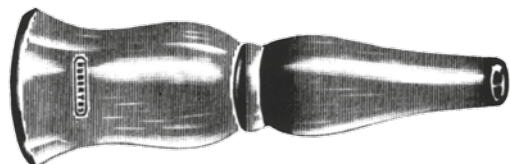

Hare Distress Call (for Fox)

Varnished wood
33332-26



Hare Distress Call (for Fox)

Varnished wood, can also be used as a universal call thanks to easily changeable pitch
33332-27

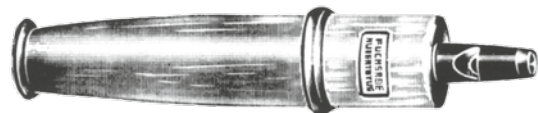

Hare Distress Call (for Fox)

Varnished wood, easily changeable pitch, with mouse whistle
33332-28

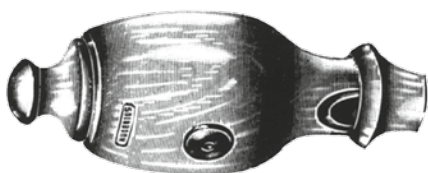

Wood Pigeon and Cuckoo Call

Varnished wood, 12 cm
33332-29



Pigeon Call

Varnished wood, 12 cm
33332-30

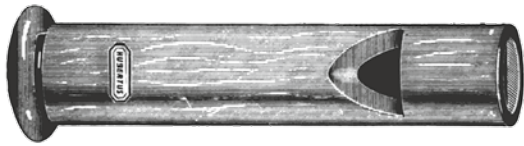

"Hubertus" Universal Game Call
for cuckoo, turtle dove, wood dove, stock dove and owl,
adjustable, with instructions
33332-31

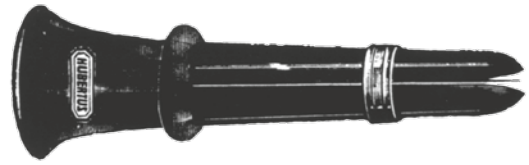

Duck and Crow Call
Varnished wood, with bell
33332-32

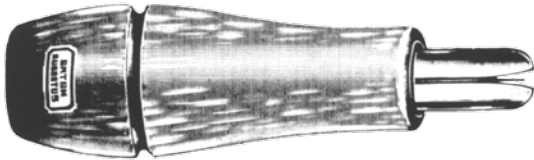

Duck Call
Also for crows, good model, strong, natural sound
33332-33

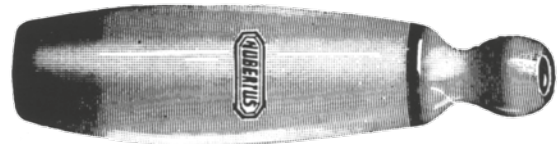

Duck Call
33332-42



Snipe Call
Varnished wood
33332-34

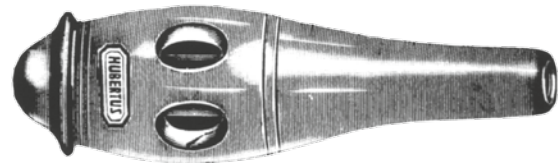

Wood Grouse Call
Varnished wood
33332-35

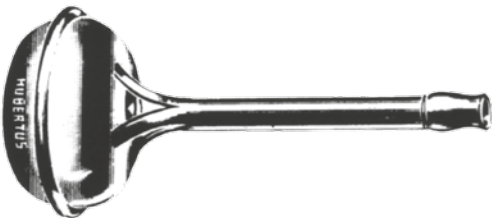

Blackcock Call, nickel-plated metal
33332-36



Jay Call
Natural sound, with instructions
33332-37

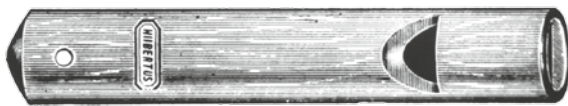

Pheasant Call
Varnished wood
33332-38

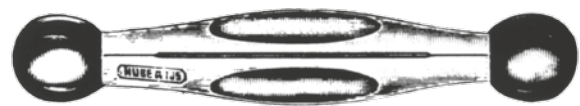

Owl and Raptor Call
Artificial horn balls on the sides
33332-41

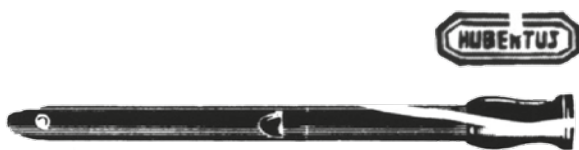

Hazel Grouse Call
33332-43



**Duck Call
made of Wood**
33332-11



**Crow Call
made of Wood**
33332-12



Electronic Game Calls

Electronic game call with integrated speaker. Produces detailed, realistic calls. Choose between 5 different calls.

- 33332-52** Duck: Highball Greeting, Lonesome Hen, Laydown Call, Feeding Call, Comeback Call
- 33332-53** Wild Boar: Feeding Frenzy, Contended Feeding, Social Grunts, Fighting Boar, Feeding Piglets
- 33332-54** Crow: MacDaddy, Crow Distress, Crow/Owl Fight, Crow Frenzy, Hawk Attack
- 33332-55** Moose: Estrus Cow, Mating Moose, Calf, Lonesome Cow, Sparring Bulls
- 33332-56** Goose: Hail Call, Greeting Call, Laydown Call, Feeding Call, Comeback Call
- 33332-57** Roe Deer: Fawn Calling, Doe Calling, Doe in Distress, Doe Screaming, Barking
- 33332-58** Fox: Fawn Distress, Rodent Distress, Rabbit Distress, Woodpecker, Feline Distress



External Speaker
33332-60



External Speaker with Amplifier
33332-61

Electronic Game Call

Install the app and download over 600 calls to your mobile phone. Play back calls on speaker via Bluetooth connection (up to 115 dB).

Range approx. 45 meters

33332-62



Electronic Game Call

Install the app and download over 600 calls to your mobile phone. Play back calls on speaker via Bluetooth connection (up to 100 dB).

Range approx. 36 meters

33332-63



Roe Deer Call

made of deer antler, with leather case

33332-19





Fox Call Set
Includes barking call, fox call and DVD
33332-44



Fox Call
with DVD
33332-48



Bird Distress Call
Three calls made of cherry wood with DVD
33332-45



Crow Death Call
with DVD
33332-46



Roe Deer Call
with adjusting screw and DVD
33332-47



Stag Call
with DVD, imitate all the sounds of the stag with this stag call. Can also be used as a wild boar call. Makes a loud, very realistic sound.
33332-49



33323-05 2

33323-06 2
33323-08 2

33323-07
1 + 2

Beech Tar Wild Boar Attractant
33323-05 310 ml cartridge, PU 6 box
33323-06 5 l jug, PU 4 box
33323-07 500 ml spray, PU 12 box
33323-08 2.5 l jug, PU 8 box

Urine
From wild hog sow in heat, 100% pure urine, 100 ml irresistible for adult wild boar, use: spray onto cloth to mark the desired area. It is also recommend to make a trail with urine soaked cotton plugs.
33323-62



Scent Concentrate
100 ml, to lure hoofed game, Use: Spray 4-5 times on feed, salt block or into undergrowth
33323-60 Truffle
33323-61 Anise



AttraTec No 2 Anis Ultra

50 ml

- Intense attractant based on anise oil with long-lasting effect
- Broad use spectrum (for predators, wild boar, roe deer, pigeons)
- Free of harmful secondary components of anise oil
- High degree of user safety & long shelf life
- Can be used to below -10°C

Use: Treat target area with 1-2 short sprays.

33323-43

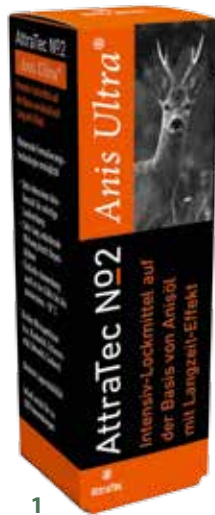

1

AttraTec No 3 Anis Pur

100 ml

- Safety attractant with pure anise oil as the natural active ingredient
- Broad use spectrum (for predators, wild boar, roe deer, pigeons)
- Free of harmful secondary components of anise oil
- Lasts longer than anise oil
- Can be used to below 0°C

33323-44



AttraTec No 4 BHT Fluid, 1kg

- Quality beech tar for year-round use on wallows and rubbing trees
- Simple to use without any aids
 - Remains liquid even at low temperatures
 - Clean transport and storage
 - Complete removal from package (> 99%)

33323-45



2

AttraTec No 5 BHT Pur, 1kg

- Quality beech tar for use on wallows and rubbing trees
- Simple to use without any aids
 - Clean transport and storage
 - Good removal from package

33323-46



2



Attractant, 500 g

Extremely effective even when used sparingly.

33323-41 Wild boar/fox

33323-42 Roe and red deer

AttraTec No 1 Suhlengold

1kg

Bioactive attractant for wild boar and red deer on the basis of beech tar and plant-based attractant substances for use on wallows and rubbing trees

- Works immediately, maximum lure effect
- Simple to use year-round without any aids
- Enough for up to 20 applications
- Clean and odor-free transport and storage
- Complete product removal (> 99%)

1 33323-63 intense fragrant

2 33323-47 Version 2017, mild fragrant

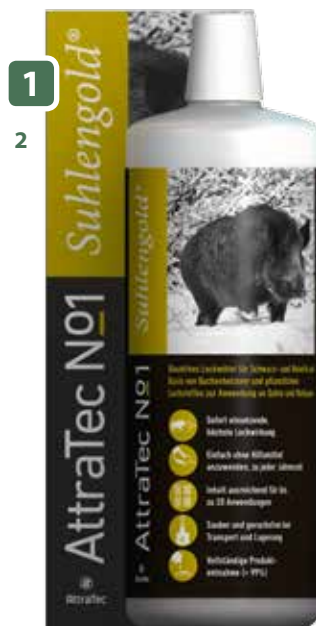

1

2



2

2



1



2



3



4



5



AttraTec No 9, 1 liter

Natural attractant with bioactive flavors for all domestic game

- Use purely at salt licks or mixed with feed
- Appeals strongly to the senses of smell and taste of the game
- Strong luring effect, saves feed considerably
- Highly efficient, 1 l is enough for 250 to 500 kg feed

33800-90 Test Set

50 ml each of anise, peach, cherry, caramel, vanilla, hazelnut, walnut

33800-91 Anise

33800-93 Peach

33800-95 Caramel

33800-97 Hazelnut

33800-92 Apple

33800-94 Cherry

33800-96 Vanilla

33800-98 Walnut

Detergent for hunting clothes

- Intense washing efficiency for effectively removing odors and dirt
- Produced of odorless components and without perfume
- Without optical brighteners – keeps the camouflage effect of hunting clothes



4



4

AttraTec No 7 Hunter's Full Wash

odorless heavy-duty laundry detergent for cotton and mixed fabrics

33800-07 1 liter

AttraTec No 8 Hunter's Care Wash

odorless gentle laundry detergent for wool and function textiles

33800-08 1 liter

AttraTec No 6 Shower

- Unscented shower gel for huntresses and hunters
- High-quality natural cosmetics, its single components are odorless and do not contain perfume or perfume oil

33800-06 250 ml



AttraTec No 11 „Salzblitz“ Salt Attractant

- for activating salt places and refining feed material
- to be used especially in dry weather
- spray sites form a visible, firmly adhesive salt film after a few minutes

33800-11 1 liter



Mineral Salt, 2 kg

Mineral salt designed specifically for hoofed game with maximum yield. Add water to make a spreadable paste.

33323-16 Anise aroma

33323-18 Wild berry aroma

33323-17 Apple aroma

33323-19 approx 2,5 kg, PU 2

Salt Rock

Salt rock made of pink Himalayan salt, especially for hoofed game. Contains a variety of minerals. Suitable for roe deer, red deer, fallow deer, chamois and mouflon.

33323-19 approx 2,5 kg, PU 2





2

Aroma Attractant, 1 liter

Aromatic liquid attractant for hoofed game. Use as feed additive or as a flavoring additive for salt blocks.

Use: Add approx. 0,15 l of the product to 10 kg of feed

- 33323-50 Apple
- 33323-51 Truffle
- 33323-52 Chestnut
- 33323-53 Corn
- 33323-54 Forest fruit



Mineral Salt Paste, 2 kg Bucket

- 33323-11 Neutral
- 33323-12 Anis
- 33323-13 Truffles
- 33323-14 Apple
- 33323-15 Smokey

Irresistible and intensely Fragrant Bait Mixture for Game

Suitable for wild boar, red deer, fallow deer, mouflon, fox, mink or badger.

The scent attracts animals at a great distance.

Lurixol is so irresistible for wild boar that it will return to the bait site several times per day.



Lurixol Nectar, 1 kg

Lurixol Nectar is an intensely fragrant bait mixture for luring game. Apply near feed on tree stumps or the ground.

- 33323-73 Plum
- 33323-74 Pear
- 33323-75 Corn

Lurixol Ultra, 300 ml spray

Lurixol Ultra is a highly concentrated, intensely fragrant bait spray to lure game. Spray near feed at a height of 1 – 2 meters on trees or cloth.

- 33323-76 Plum
- 33323-77 Pear
- 33323-78 Corn

Biological

Game Repellent, 1 kg

for outdoor use to repel game

- Scares off all types of game by creating an invisible, biological scent barrier
- Ideal game crossing barrier – road and fields
- Good protection for newly planted trees in silviculture
- Prevention for all types of maturing grain, especially corn

Wildschreck game repellent has been used effectively for years to scare and keep away crows, roe deer, wild boar, beaver, mink, fox, moles and voles.

- 33323-81 1 liter liquid
- 33323-82 5 liters liquid
- 33323-84 1 kg granulate



Wildschreck II Game Repellent Liquid Extra Concentrate

- Improved recipe
- Longer-lasting effect
- Super high yield concentrate
- Intense smell and therefore much more effective
- Long-lasting effect
- Effective and stronger scent barrier than conventional products





Wire Frame Traps

- Sturdy design
2 entryways
- 33406-02** 60 x 15 x 15 cm
 - 33406-04** 100 x 25 x 23 cm
 - 33406-05** 120 x 30 x 32 cm
 - 33406-06** 140 x 30 x 33 cm
 - 33406-07** 80 x 25 x 22 cm

- 1 entryway
- 33406-01** 60 x 15 x 15 cm
 - 33406-03** 80 x 25 x 22 cm



Crow Trap
33406-12 55 x 40 cm



Synthetic Scents for Trapping

- 33323-30** Mink, 35 ml
- 33323-31** Fox, 35 ml

5



Ballistol Trap Oil

- for lubricating and maintaining traps
 - Odorless and tasteless
 - for all kinds of traps and self-firing traps
- 33500-34** 65 ml, PU 12



Wind Direction Indicator

- Indicator powder for determination of light wind and airflows which are difficult to feel.
- 33323-79** 12 g / 15 ml



Synthetic Scent for Dummies
33323-20 Rabbit, 35 ml



Synthetic Scent for Dummies
33323-21 Duck, 35 ml



Synthetic Scent for Dummies
33323-22 Pheasant, 35 ml



Synthetic Scent for Dummies
33323-23 Fox, 35 ml



Game Motion Detector



Game Motion Detector

silent alarm via earphones or acoustic signal via receiver

Ranges: Motion detector – game approx. 10 m,
Radius: 90° motion detector – receiver up to 100 m

Batteries: Sensor 9 volt block, receiver 3 x 1.5 V AA/AAA

Comes with: Infrared sensor with mounting bracket, receiver, earphones and fastening strap

1 33337-11 with 1 sensor

2 33337-12 with 2 sensors, additional vibration alarm, 1 LED shows the triggering sensor



Deer Whistle for Cars

Ultrasonic high-frequency signals
 (16,000 – 20,000 Hz),
 45 x 22 x 40 mm, self-adhesive

33328-12

Wildlife Observer 3

- Easy-to-use system
- Adjustable image quality: 5.0 MP, 3.1 MP or 1.3 MP
- Wide angle lens 55°
- 52 infrared LEDs for night shots
- Flash range over 15 m – excellent night shots
- Day shooting in color, night shots in black and white
- Temperature, date, time, moon phase and individual additional text stamped on image
- Multiple shots and video recording possible
- High-definition videos: 640x480 pixels at 30 frames per second, adjust video length from 5-90 seconds
- Image taking triggered via infrared motion sensor, 55° detection angle, adjustable range
- Release speed 1 second
- Release interval adjustable from 5 sec – 60 min
- Operating time can be set precisely to the minute
- Automatic white balance
- Storage via SD cards up to 32 GB (comes with 4 GB SD card)
- Password protection
- Ultra-small housing: 133 x 86 x 51 mm
- Low energy consumption: One set of batteries (8 AA) lasts for approx. 180 days or approx. 5,000 shots (not included)
- Jack for external battery
- Complete with assembly kit, USB and TV cable

33338-05



Game Camera

One of the smallest game cameras on the market

- Non-visible LEDs
- 2 illumination levels
- Flash range up to 20 m
- Adjustable image quality: 12 MP, 8 MP und 5 MP
- Day shooting in color, night shots in black and white
- Temperature, date, time, moonphase and individual additional text stamped on image
- Multiple shots and video recording possible
- High-definition videos adjustable:
1440x1080, 1280x720, 640x480 Pixel
- Video length adjustable of 10, 20 or 60 seconds
- Sound recording
- Image taking triggered via infrared motion sensor, sensitivity adjustable, 45° detection angle
- Release speed less than 0,6 second
- Release interval adjustable individually
- Operating time can be set precisely to the minute
- Storage via micro SD card up to 32 GB, (not included)
- Password protection



- Ultra-small housing: 68 x 37 x 99 mm
 - Weight: 162 g
 - Low energy consumption
 - Batteries: 4 AA (not included)
 - Jack for external battery
 - Complete with assembly kit, USB cable
- 33338-07**





Infrared additional Flash

fits for all cameras with infrared flash, for improving the illumination and reach of nocturnal shots.
 90 high performance LED's can be switched in 3 groups:

- 36 LED's to brighten the picture
- 36 LED's to illuminate the wide angle
- 18 LED's to improve the reach
- Reach adjustable from 13 m to more than 35 m
- 1 m IR sensor cable fitting for all IR cameras
- Works in photo and video mode
- Batteries: 4 monocells (not included)
- Connection for external 6 volt battery
- Innovative curved mounting rail on the rear side for easy alignment of the device

33338-50



Game Clock, with 24-hour clock face, the clock housing is all-weather, shock and bite resistant
33335-01



Memory Wild Boar Timer
 Resets itself automatically after 1 hour, stores up to 64 game movements
33335-04



Decoy
40200-01 Eagle-owl 40 cm



Decoy
40200-03 Eagle-owl 63 cm

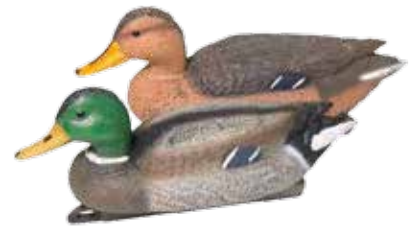

Decoy
40201-01 Drake 40 cm
40201-02 Duck 40 cm



Decoy
40201-03 Drake 40 cm
40201-04 Duck 40 cm



Decoy
40203-01 Crow flocked 38 cm
40203-02 Crow painted 38 cm



Decoy
40204-01 Dove with moving wings 63 cm



Decoy
40204-02 Pigeon flocked 38 cm



Decoy
40205-01 Magpie 38 cm



Decoy
40204-03 Pigeon 37 cm



Decoy
40204-04 Dove with foot 38 cm

Duck Decoy Set
consisting of
4 drakes, 4 ducks,
1 drake and
1 duck sleeping,
1 drake and
1 duck diving,
12 anchors and
approx. 30 m line,
in transport net
40201-07



Pigeon Decoy Set
consisting of
12 pigeons,
12 pigeon shells,
12 anchors,
in transport net
40204-07



07 | GAME RECOVERY AND GAME DRESSING

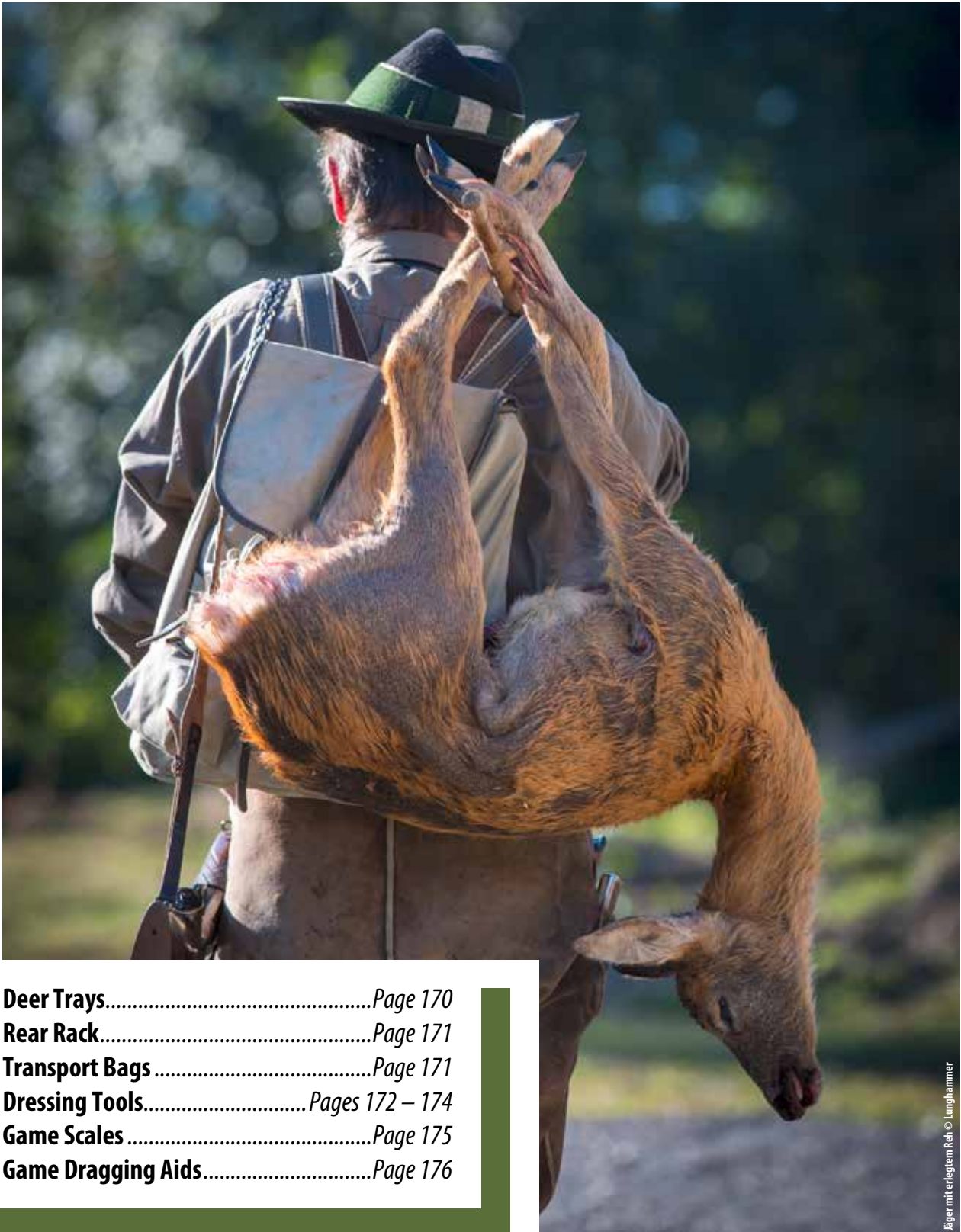

Deer Trays.....	Page 170
Rear Rack.....	Page 171
Transport Bags.....	Page 171
Dressing Tools.....	Pages 172 – 174
Game Scales.....	Page 175
Game Dragging Aids.....	Page 176

Jäger mit erlegtem Reh © Lunghammer



Deer and All-purpose Tray

made of food-safe, impact-resistant plastic, dimensions 80 x 48 x 30 cm, 80 liter volume
33324-11



Deer and All-purpose Tray

made of LLD-PE plastic, unbreakable and food safe, very light and practical thanks to 2 carrying handles. Runners on bottom for winter use, green, dimensions 90 x 60 x 20 cm
33324-12



Sled and Trunk Tray

This sled and trunk tray is ideal for transporting feed and bagged deer/game thanks to its bow-shaped front. The runners on the bottom make it slide well on snow. 100 x 70 x 30 cm
33324-13



Deer Tray, fits in all cars, foldable, tear-resistant and washable, dimensions 125 x 64 x 30 cm
33324-10



Cover for sled tray

100 x 70 cm
33324-14



Deer Tray

made of impact-resistant plastic, white, dimensions 60 x 40 x 12 cm
33324-25



Deer Tray

made of impact-resistant plastic, dimensions 70 x 45 x 20 cm, 40 liter volume
33324-24





10 Game Transport Bags

Poly flat bags, green, 105 x 70 cm, PU 5
33324-06



Game Transport Bag, made of double-sided coated canvas, with 2 belt loops, absolutely tear-resistant and waterproof, green, 100 x 65 cm
33324-07



Game Transport Bag

made of double-sided coated canvas, with 2 belt loops, absolutely tear-resistant and waterproof, green, 100 x 65 cm, with 2 carrying straps
33324-08



Game transport bag

made of nylon and double-sided coated canvas, with 2 belt loops and 2 wrap-around carrying straps, absolutely tear-resistant and waterproof, green, 100 x 65 cm
33324-09



Disposable Protective Gloves

Lightly powdered, 100 pcs.
33324-01 Size L
33324-02 Size XL

Fly Nets

made of durable gauze fabric

33331-01 For roe deer or chamois, 170 x 110 cm

33331-02 For deer, 220 x 160 cm



Rear Rack with Quick-release

Zinc-plated, 12 kg, outside dimensions: 90 x 58 x 17,5 cm, inside dimensions: 83,5 x 52 x 16,5 cm
33324-16



Gutting and Dressing Pliers

High-quality design, premium product made in Germany, pliers completely xylan coated, stainless steel, 19 cm
33328-04



Bone Forceps
33328-07



Butt Out Dressing Tool
33328-47



Dressing Saw

For trouble-free cutting of aitchbone and sternum
33328-13 Saw blade 8 cm



Dressing Saw

For trouble-free cutting of aitchbone and sternum
33328-11 Saw blade 6 cm



Gambrel with hoist

approx. 200 kg total weight
33328-31



Game Gambrel

up to 250 kg load, spreads open from 30 – 63 cm
33328-26



Game Gambrel, made of stainless steel

33328-33 up to approx. 150 kg load, 46 x 16 cm
33328-52 up to approx. 250 kg load, 58 x 27 cm



Game Gambrel

made of stainless steel, up to approx. 150 kg load, 48 x 16 cm
33328-51





Ribcage Spreader

For cooling game, approx. 30 cm when spread out
33328-30



Meat Hooks

Stainless steel for cooling game, approx. 30 cm when spread out
33328-34 16 cm long, 8 mm thick
33328-36 26 cm long, 8 mm thick, rotating

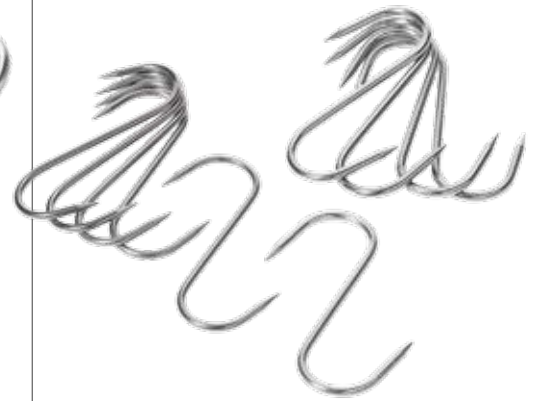

Meat Hooks

Stainless steel for cooling game, approx. 30 cm when spread out
33328-45 5 meat hooks 12 cm long, Ø 5 mm
33328-46 5 meat hooks 16 cm long, Ø 6 mm



Hunting Set

consisting of 1 hatchet 25 cm long and 1 knife, 11 cm blade with gut hook, stainless steel with rubber handles, with case
23121-08



Bone Saw

23121-09 30 cm
23121-10 40 cm
23121-11 Saw blade 30 cm
23121-12 Saw blade 40 cm



Machete

39 cm steel blade 420, total length 53 cm, with bright orange rubber handle, with nylon sheath
23122-07



Machete

Blade length 35 cm, coated blade with facet profile, with nylon sheath
23122-06



Dressing Set

- 9 pcs., in case
- 3 knives in different sizes
- Honing steel
- Bone saw
- Cleaver
- Gambrel
- Hoist

23121-06



Wild-Pak™ 8-pc Knife Set

- 2 knives: blade length 12,7 and 6,4 cm,
- 1 gutting knife: blade length 10,2 cm,
- 1 saw: blade length 15,2 cm,
- 1 ribcage spreader, knife sharpener, gloves and case

23331-01



Butcher-Lite™ 8-pc Knife Set

- 2 knives: blade length 15 and 10,8 cm,
- 1 gutting knife: blade length 11,5 cm,
- 1 saw: blade length 15,2 cm, 1 ribcage spreader,
- knife sharpener and gloves, in belt scabbard

23332-01



Game Processor™ 12-pc Knife Set

- 3 knives: blade length 21, 15 and 10,8 cm,
- 1 gutting knife: blade length 11,5 cm,
- 1 saw: blade length 25,8 cm,
- 1 carving fork, 1 game shears, 1 ribcage spreader,
- 1 knife sharpener, 1 cutting board, gloves and 1 case

23333-01





Game Scale
33330-02 25 kg
33330-03 50 kg
33330-04 125 kg



Large Game Dial Scale
 with sturdy housing and protective glass
1 33330-07 up to 200 kg, quality product made in Germany
2 33330-08 up to 100 kg, 500 g increments



Electronic Game Scale
33330-10 up to 40 kg,
 10 g increments



Electronic Game Scale
 with snap hook
33330-11 up to 200 kg,
 100 g increments



Electronic Game Scale
 with snap hook, weight 700 g
33330-12 up to 300 kg,
 100 g increments



Game Dragging Aid
33328-17 Deer drag – 2-pc with swivel



Game Dragging Aid
33328-18 Deer drag – 3-pc with swivel



Game Dragging Aid
33328-19 Deer drag – 1-pc



Game Dragging Aid
33328-48 1-pc, with swivel,
leather with covered steel cable



Game Dragging Aid
Pull Strap with
harness rope
length 230 cm,
7,5 cm wide,
up to 500 kg load
33328-24



1-Part Game Dragging Aid
with hook
33328-28



1-Part Game Dragging Aid
with hook, for 3 persons, length 3 m
33328-29



08 | TROPHY PROCESSING



Bleaching / Cleaning / Care Products ..	Page 178
Cleaning Aids	Page 179
Skull Saw	Page 179
Trophy Shields	Pages 180 – 185
Trophy Mounting Clamps	Page 186
Wild Boar Tusk Cover Plates	Page 187
Artificial Skulls	Page 188

Kapitales Hirschgeweih auf der Alm © by-studio



2 + 4

Trophy Cleaner

Effective means to clean trophies. The ingredients help in the separation and decomposition of tissue and reduce the cleaning time. The trophy is degreased and slightly bleached.

33323-64 500 g



1 + 2 + 4 + 5

Trophy Cleaner 3 in 1

Effective means to clean trophies that combines the 3 steps before hanging up the trophy. The agent cleans, degreases and bleaches in a single step.

33323-66 250 g



1 + 2 + 4

Trophy Bleaching Agent

Powder, for all hunting trophies
33323-67 250 g



5

Trophy Care

Care product for conserving antlers, horns and skulls. The product preserves the natural appearance of antlers. Lasting protection against weathering for antlers, horns and skulls.

33323-65 200 ml



2 + 5

Filler for Wild Boar Tusks

Easy to use with natural white color for guaranteed perfect results. Comes with: two-component filler, beaker, rubber gloves and wooden stirring rod. Enough for 1 – 6 sets of wild boar tusks

33323-68 200 ml

Füll-Fix Casting Compound

Liquid casting compound for wild boar tusks, enough for 3 – 5 fillings

33323-01



“St. Hubertus” Antler Stain

Natural color concentrate, revitalizes deer antlers

33323-03

Attratec No 10 Trophy bleach

Bleaching agent for trophies based on stabilised hydrogen peroxide (11,94%) for improved durability

- Highly efficient
- Economic in use
- High safety lock (dangerous material bottle, child-proof lock)
- Reclosable aluminum bag for best possible protection from sunlight

33800-10 1 kilo



4

“St. Hubertus” Bleaching Paste

Special bleaching paste for all hunting trophies
33323-02



2

Ballistol Trophy Bleaching Agent

Powder, for all hunting trophies

33323-04 250 ml



2 + 4 + 5





Boiling Support

for roe deer and chamois trophies, rubber-coated brackets, screws with wing nuts make adjustment possible in 4 directions, fits easily on all cooking pots.

33328-05



Trophy Boiling Pot

for roe deer and chamois trophies, 230 V, 50 Hz, 2100 W, 36 x 20 x 23 cm

33328-06



Skull Saw

33328-00 Complete for roe deer and chamois

33328-01 Saw blade for skull saw

33328-02 Saw blade with wooden handle

33328-10 Skull saw for red deer trophies

The mentioned dimensions describe the mounting surface. The outer dimensions are accordingly bigger.



Carved Oak Shields for Roe Deer Trophies

16 x 9 cm, PU 5

00206-01 Dark

00206-02 Light

00206-11 Dark with jaw compartment

00206-21 Light with jaw compartment



Carved Oak Shields for Roe Deer Trophies

18 x 9 cm, PU 5

00225-01 Dark

00225-02 Light

00225-11 Dark with jaw compartment

00225-21 Light with jaw compartment



Hand-carved Shield for Roe Deer Trophies

Soft wood, dark

01208-17 18 x 9 cm

01208-22 22 x 10 cm



Hand-carved Shield for Roe Deer Trophies

Soft wood, dark

01207-17 17 x 9 cm



Carved Basswood Shield for Roe Deer Trophies

00217-01 21 x 12 cm



Shields for Roe Deer Trophies Made of Oak

19 x 11 cm, PU 5

00500-01 Dark

00500-02 Light

00500-11 Dark with jaw compartment

00500-21 Light with jaw compartment

The mentioned dimensions describe the mounting surface. The outer dimensions are accordingly bigger.

Shields for Roe Deer Trophies
Made of Oak, PU 5



- 19 x 12 cm
00505-01 Dark
00505-02 Light
00505-11 Dark, with 1 jaw compartment
00505-21 Light, with 1 jaw compartment

Shields for Roe Deer Trophies
Made of Oak, PU 5



- 18 x 11 cm
00511-01 Dark
00511-02 Light
00511-11 Dark, with 1 jaw compartment
00511-21 Light, with 1 jaw compartment
- 22 x 13 cm
Dark **Light**
01511-21 **02511-21**
01511-22 **02511-22** with 2 jaw compartments
01511-23 **02511-23** with 1 jaw compartment

Shields for Roe Deer Trophies
Made of Oak, PU 5



- 17 x 11 cm
00502-01 Dark
00502-02 Light
00502-11 Dark, with 1 jaw compartment
00502-21 Light, with 1 jaw compartment
- 22 x 13 cm
Dark **Light**
01502-21
01502-23 **02502-23** with 1 jaw compartment

Shields for Roe Deer Trophies
Double milled, PU 5



- 18 x 11 cm
00506-01 Dark
00506-02 Light
00506-11 Dark, with 1 jaw compartment
00506-21 Light, with 1 jaw compartment
- 22 x 13 cm
Dark **Light**
01506-21 **02506-21**
01506-22 **02506-22** with 2 jaw compartments
01506-23 **02506-23** with 1 jaw compartment



- Birch Shields for Roe Deer Trophies**
00533-01 Approx. 20 x 12 cm
00533-03 Approx. 22 x 12 cm
00533-11 Approx. 20 x 12 cm, with 1 jaw compartment
00533-13 Approx. 22 x 12 cm, with 1 jaw compartment
00533-04 Approx. 27 x 18 cm



- Acacia Shields for Roe Deer Trophies**
00535-01 Approx. 22 x 12 cm
00535-02 Approx. 27 x 18 cm
00535-11 Approx. 22 x 12 cm, with 1 jaw compartment
00535-03 Approx. 20 x 11 cm
00535-13 Approx. 20 x 11 cm, with 1 jaw compartment



- Larch Shield for Roe Deer Trophies**
00536-01 Approx. 22 x 12 cm

The mentioned dimensions describe the mounting surface. The outer dimensions are accordingly bigger.



Carved Trophy Boards for Chamois Trophies
17 x 11 cm, dark
00209-01



Carved Trophy Boards for Chamois Trophies
21 x 11 cm, dark
00210-01



Carved Trophy Boards for Chamois Trophies
18 x 10 cm mounting surface, dark
00211-01



Shield, Wedge-shaped for Chamois Trophies
Dark
00506-31 20 x 12 cm



Shield, Wedge-shaped for Chamois Trophies
Dark
00511-31 21 x 11 cm



Acacia Shield for Chamois Trophies
Wedge-shaped
00535-05 Approx. 22 x 12 cm



The mentioned dimensions describe the mounting surface. The outer dimensions are accordingly bigger.



Hand-carved Shields for Deer Trophies

Soft wood, dark

- 01207-25** for fallow deer, 27 x 13 cm
- 01207-45** for deer, 45 x 21 cm
- 01207-48** for deer, 48 x 22 cm



Hand-carved Shields for Deer Trophies

Soft wood, dark

- 01208-25** for fallow deer, 27 x 13 cm
- 01208-45** for deer, 45 x 20 cm
- 01208-48** for deer, 48 x 22 cm

Carved Oak Shields for Deer Trophies

Dark

- 01225-25** 25 x 15 cm
- 01225-30** 30 x 17 cm
- 01225-36** 36 x 18 cm
- 01225-40** 40 x 20 cm
- 01225-45** 45 x 22 cm
- 01225-50** 50 x 23 cm
- 01225-53** 53 x 23 cm
- 01225-55** 55 x 25 cm

Light

- 02225-30** 30 x 17 cm
- 02225-36** 36 x 18 cm
- 02225-40** 40 x 20 cm
- 02225-45** 45 x 22 cm
- 02225-50** 50 x 23 cm
- 02225-53** 53 x 23 cm
- 02225-55** 55 x 25 cm



Shields Made of Oak for Deer Trophies

Dark

- 01506-25** 25 x 15 cm
- 01506-33** 33 x 18 cm
- 01506-38** 38 x 20 cm
- 01506-43** 43 x 22 cm
- 01506-50** 50 x 24 cm
- 01506-52** 52 x 25 cm

Light

- 02506-25** 25 x 15 cm
- 02506-33** 33 x 18 cm
- 02506-38** 38 x 20 cm
- 02506-43** 43 x 22 cm
- 02506-50** 50 x 24 cm
- 02506-52** 52 x 25 cm



Shields Made of Oak for Deer Trophies

Dark

- 01512-25** 25 x 15 cm
- 01512-28** 28 x 17 cm
- 01512-33** 33 x 18 cm
- 01512-38** 38 x 20 cm
- 01512-43** 43 x 22 cm
- 01512-48** 48 x 25 cm
- 01512-50** 50 x 24 cm
- 01512-52** 52 x 25 cm

Light

- 02512-25** 25 x 15 cm
- 02512-28** 28 x 17 cm
- 02512-33** 33 x 18 cm
- 02512-38** 38 x 20 cm
- 02512-43** 43 x 22 cm
- 02512-48** 48 x 25 cm
- 02512-50** 50 x 24 cm



Birch Shields for Deer Trophies

- 01533-40** Approx. 40 x 18 cm
- 01533-45** Approx. 45 x 20 cm
- 01533-50** Approx. 50 x 24 cm

Acacia Shields for Deer Trophies

- 01535-30** Approx. 35 x 18 cm
- 01535-40** Approx. 40 x 18 cm
- 01535-45** Approx. 45 x 20 cm
- 01535-50** Approx. 50 x 25 cm

Larch Shield for Deer Trophies

- 01536-45** Approx. 45 x 19 cm

The mentioned dimensions describe the mounting surface. The outer dimensions are accordingly bigger.



Mouflon Shields

- 00990-02** 24 x 10.5 cm mounting surface,
29 x 17 x 28 cm total size
- 00990-03** 28 x 17 cm mounting surface,
34 x 18 x 28 cm total size



Hand-carved Mouflon Shield

- 00990-04** 25 x 14 cm mounting surface,
35 x 24 x 25 cm total size



Shields Made of Oak for Moose Trophies

- 44 x 26 cm
- 01506-44** Dark
- 02506-44** Light



- 44 x 25 cm
- 02504-44** Light
- 03504-44** Black



- 46 x 29 cm
- 01504-46** Dark
- 02504-46** Light
- 03504-46** Black

- 46 x 30 cm
- 01512-46** Dark
- 02512-46** Light



Shields Made of Oak for Roe Deer and Deer Trophies

- | | | |
|-----------------|-----------------|------------|
| Black | Light | |
| 00507-01 | 00507-02 | 18 x 11 cm |
| 01507-21 | 02507-21 | 22 x 13 cm |
| 01507-32 | 02507-32 | 32 x 18 cm |
| 01507-47 | 02507-47 | 47 x 24 cm |



Shields for Prepared Chamois, Roe Deer, Deer and Wild Boar Heads, dark

- 01515-20** for roe deer, 20 x 14 cm
- 01515-26** for chamois, 26 x 18 cm
- 01515-36** for deer, 36 x 26 cm
- 01515-40** for deer, 40 x 27 cm
- 01515-41** for deer, 40 x 30 cm
- 01515-53** for wild boar, 53 x 40 cm



Shields for Still Life and Mounted Fish, dark

- 01513-20** 20 x 15 cm
- 01513-25** 25 x 20 cm
- 01513-30** 30 x 25 cm
- 01513-35** 35 x 25 cm
- 01513-40** 40 x 22 cm
- 01513-45** 45 x 25 cm



The mentioned dimensions describe the mounting surface. The outer dimensions are accordingly bigger.



Round Oak Shields for Wild Boar Tusks

Dark	Light	Black
01001-11 Ø 11 cm	02001-11 Ø 11 cm	
01001-13 Ø 13 cm	02001-13 Ø 13 cm	03001-13 Ø 13 cm
01001-15 Ø 15 cm	02001-15 Ø 15 cm	03001-15 Ø 15 cm
01001-17 Ø 17 cm	02001-17 Ø 17 cm	03001-17 Ø 17 cm
01001-19 Ø 19 cm	02001-19 Ø 19 cm	03001-19 Ø 19 cm
01001-21 Ø 21 cm	02001-21 Ø 21 cm	



Carved Oak Shields for Wild Boar Tusks

Dark	Light
01201-10 Ø 10 cm	02201-10 Ø 10 cm
01201-12 Ø 12 cm	02201-12 Ø 12 cm
01201-14 Ø 14 cm	02201-14 Ø 14 cm
01201-16 Ø 16 cm	02201-16 Ø 16 cm
01201-17 Ø 17 cm	02201-17 Ø 17 cm
01201-19 Ø 19 cm	02201-19 Ø 19 cm
01201-21 Ø 21 cm	02201-21 Ø 21 cm



Shields for Wild Boar Tusks, Oak, dark

01216-13	16 x 15 cm
01216-15	18 x 17 cm
01216-17	20 x 19 cm
01216-25	25 x 22 cm



Hand-carved Shields for Wild Boar Tusks Made of Basswood

01215-15	Ø 15 cm
01215-17	Ø 17 cm
01215-19	Ø 19 cm



Birch Shield for Wild Boar Tusks

00533-06	Approx. Ø 15 cm
-----------------	-----------------



Acacia Shield for Wild Boar Tusks

00535-06	Approx. Ø 15 cm
00535-07	Approx. Ø 18 cm
00535-08	Approx. Ø 20 cm

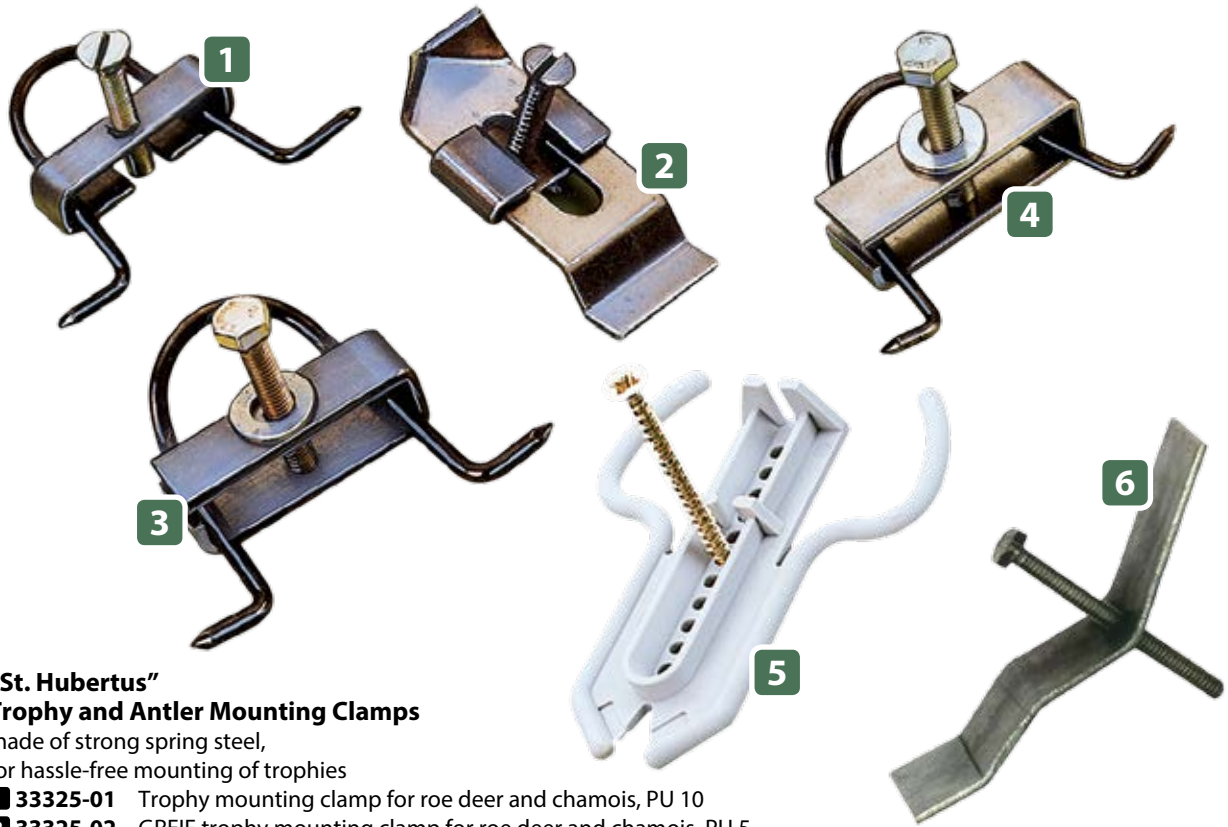

**“St. Hubertus”
Trophy and Antler Mounting Clamps**

made of strong spring steel,
for hassle-free mounting of trophies

- 1 33325-01** Trophy mounting clamp for roe deer and chamois, PU 10
- 2 33325-02** GREIF trophy mounting clamp for roe deer and chamois, PU 5
- 3 33325-03** Antler mounting clamp for red deer, PU 5
- 4 33325-04** Antler mounting clamp for fallow deer, PU 5
- 5 33325-05** Fischer trophy mounting clamp, resilient and gentle to the skull, for roe deer and chamois, PU 10
- 6 33325-06** Antler mounting clamp for red deer, PU 5



**“St. Hubertus”
Trophy Mounting Clamp**

Shop pack, 150 pcs.

- 33325-11** Trophy mounting clamp 33325-01
- 33325-12** Trophy mounting clamp 33325-02





**Heavy-duty Solid
Wild Boar Tusk Cover Plate**
Nickel silver-plated, 6 x 6 cm, PU 5
33326-01 3 oak leaves



**Heavy-duty Solid
Wild Boar Tusk Cover Plate**
Nickel silver-plated, 6 x 7 cm, PU 5
33326-02 4 oak leaves



**Heavy-duty Solid
Wild Boar Tusk Cover Plate**
Nickel silver-plated, for double
cover, 8 x 8 cm, PU 2
33326-03 7 oak leaves



**Heavy-duty Solid
Wild Boar Tusk Cover Plate**
Nickel silver-plated, for double
cover, 8 x 8 cm
33326-04 7 oak leaves
with wild boar head



**Heavy massive
wild boar tusk cover plate**
brass, 6 x 8 cm
33326-10 wild boar head



**Heavy-duty Solid
Wild Boar Tusk Cover Plate**
brass, 9 x 8 cm
33326-07 Oak leaves



**Heavy-duty Solid
Wild Boar Tusk Cover Plate**
Nickel silver-plated, 2,5 x 5 cm, PU 5
33326-06 Oak leaves



Wild Boar Tusk Cover Plate
Lightweight aluminum, 5 x 6 cm
33326-05 10 wild boar tusk
cover plates



Wild Boar Tusk Cover Plate
Nickel silver-plated, bendable design,
8 x 5 cm, PU 5
33326-08 Oak leaves



**Heavy-duty Solid
Wild Boar Tusk Cover Plate**
Nickel silver-plated, 6 x 7 cm, PU 5
33326-09 4 oak leaves

**Aluminum
Red Deer Skull**

- Pedicle Ø
- 33390-25** 25 mm
 - 33390-30** 30 mm
 - 33390-35** 35 mm
 - 33390-40** 40 mm
 - 33390-45** 45 mm
 - 33390-50** 50 mm
 - 33390-55** 55 mm
 - 33390-60** 60 mm
 - 33390-65** 65 mm
 - 33390-70** 70 mm



**Aluminum
Fallow Deer Skull**

- Pedicle Ø
- 33391-25** 25 mm
 - 33391-30** 30 mm
 - 33391-35** 35 mm
 - 33391-40** 40 mm
 - 33391-45** 45 mm
 - 33391-50** 50 mm



**Aluminum
Roe Deer Skull**

- Pedicle Ø
- 33392-12** 12 mm
 - 33392-15** 15 mm
 - 33392-18** 18 mm
 - 33392-21** 21 mm
 - 33392-24** 24 mm
 - 33392-27** 27 mm



**Aluminum
Moose Skull**

- Pedicle Ø
- 33394-45** 45 mm
 - 33394-55** 55 mm
 - 33394-60** 60 mm
 - 33394-65** 65 mm



**Aluminum
Deer Skull**

- Complete head
- Pedicle Ø
- 33397-50** 50 mm
 - 33397-55** 55 mm
 - 33397-60** 60 mm
 - 33397-65** 65 mm



09 | DOG ACCESSORIES

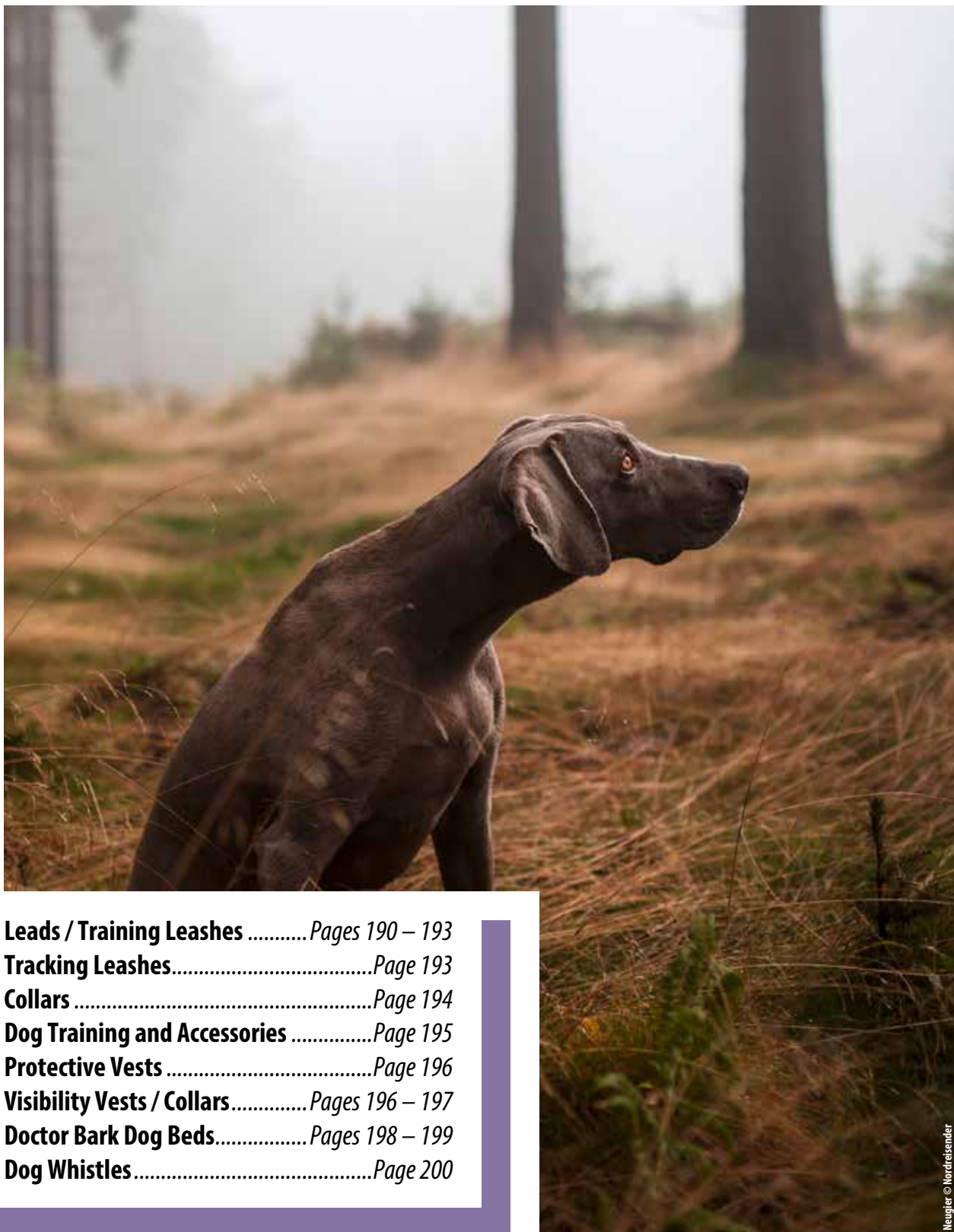

Neugler © Nordreisender

Leads / Training Leashes *Pages 190 – 193*
Tracking Leashes..... *Page 193*
Collars *Page 194*
Dog Training and Accessories *Page 195*
Protective Vests *Page 196*
Visibility Vests / Collars..... *Pages 196 – 197*
Doctor Bark Dog Beds..... *Pages 198 – 199*
Dog Whistles *Page 200*

Quick-release Leash

made of top-quality tanned leather, approx. 180 cm long, with collar and press-lock, quick-release buckle frees dog, the collar stays hanging on the leash



35401-16 16 mm wide, dark

Training Leash or Lead
made of top-quality tanned leather



35102-10 10 mm wide, approx. 180-240 cm long
35102-16 16 mm wide, approx. 180 long

Training Leash Lead

Brown, made of top-quality tanned leather, approx. 180 cm long



35402-10 10 mm wide
35402-16 16 mm wide

Training Leash with Press-lock

made of top-quality tanned leather, approx. 180 cm long, simply press on the lock and the dog is on the line



35105-16 16 mm wide, light
35405-16 16 mm wide, dark

Training Leash or Lead with Dog Whistle

made of top-quality tanned leather, approx. 180 cm long



35104-18 18 mm wide

Training Leash or Lead

made of top-quality tanned leather, long or short lead



13 mm wide, approx. 170/250 cm long
35106-13 Light
35406-13 Dark
18 mm wide, approx. 155/210 cm long
35406-18 Dark



Multipurpose/Police-style Leash

Brown, made of top-quality tanned leather, adjustable to 4 lengths



- with pincer clip:
- 35407-10** 10 mm wide, 140-270 cm
- 35407-16** 16 mm wide, 130-250 cm
- with snap hook:
- 35408-14** 14 mm wide, 140-270 cm
- 35408-18** 18 mm wide, 110-200 cm

Multipurpose/Police-style Leash

Natural light color, made of top-quality tanned leather, adjustable to 4 lengths



- with pincer clip:
- 35107-10** 10 mm wide, 140-270 cm
- 35107-16** 16 mm wide, 130-250 cm
- with snap hook:
- 35108-16** 16 mm wide, 110-220 cm

Lead

Silent, made of top-quality tanned leather, approx. 180 cm long



- 35111-01** Light
- 35411-01** Dark

Braided Leash

made of top-quality tanned leather, approx. 115 cm long



- 35115-14** 14 mm wide

Braided Leash

Brown, made of top-quality tanned leather, approx. 115 cm long



- 35415-14** 14 mm wide

Leash

made of top-quality tanned leather, approx. 105 cm long



- 35112-14** 14 mm wide, natural light color
- 35412-10** 10 mm wide, brown
- 35412-14** 14 mm wide, brown
- 35413-14** 14 mm wide, brown, with pincer clip

Leash

Brown, made of top-quality tanned leather, approx. 105 cm long



35414-07 7 mm wide
35414-10 10 mm wide

Lead/Leash

made of top-quality tanned leather, with hand strap that opens



35113-12 12 mm, 115 cm long, light

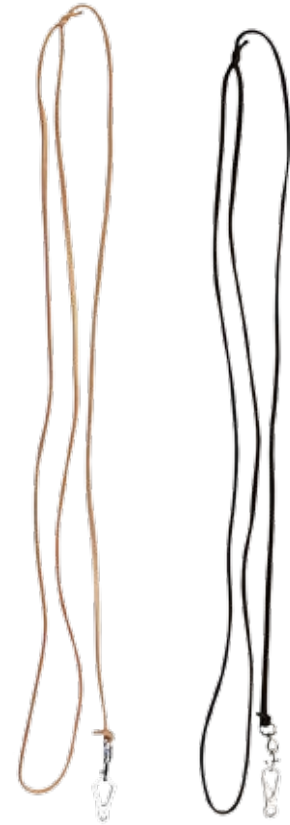

Lead

made of top-quality tanned leather, round, 180 cm, with pincer clip

35111-03 Natural color
35111-04 Brown

Nylon Leash

20 mm wide, with snap hook, green



35605-01 Multipurpose leash 200 cm
35605-03 Collar 35 – 60 cm

Nylon Leash

20 mm wide, with snap hook, red



35606-01 Multipurpose leash 200 cm
35607-03 Collar 35 – 60 cm with reflective stripe



Lead

made of rubber, rugged, green

35114-01 25 mm wide, 120 cm long





Choke Collar

Green, with limit, braided nylon
35651-35 Length: 35 cm
35651-40 Length: 40 cm
35651-45 Length: 45 cm
35651-50 Length: 50 cm
35651-55 Length: 55 cm



Tracking Leash

made of nylon webbing with snap hook, green
35109-09 10 m long

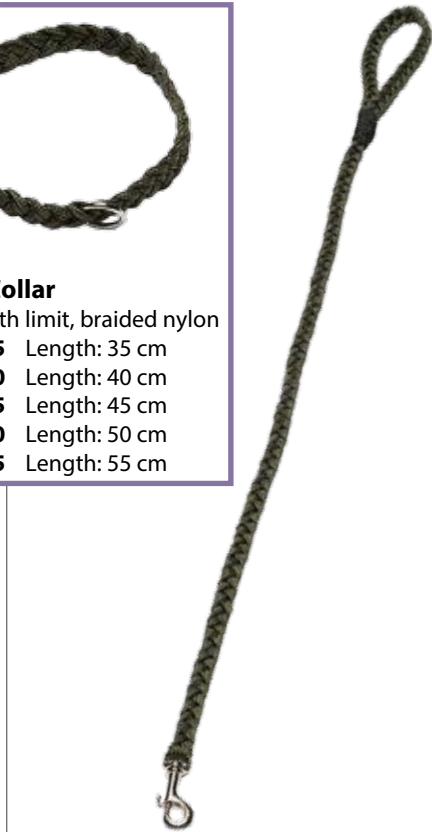

Lead

Green, made of nylon, braided, 110 cm long
35602-01 16 mm thick



Tracking Leash

made of nylon webbing with snap hook, red
35109-11 10 m long



Tracking Leash

Light, made of top-quality tanned leather, round, with pincer clip
35109-07 10 m long



Tracking Leash

Brown, made of top-quality tanned leather, round, with pincer clip
35409-07 10 m long



Field Leash made of Perlon

very strong, with hand strap and snap hook
35110-10 10 m long
35110-20 20 m long



Tracking Leash

made of top-quality tanned leather, round, silent, with staghorn toggle
35109-08 10 m long, light
35409-08 10 m long, dark



Tracking Leash

made of top-quality from a single piece of tanned leather, for buckling
35109-03 10 m long, 14 mm wide, light
35409-03 10 m long, 14 mm wide, dark

Choke Collar – Flat
20 mm wide



- 35150-35** Length: 35 cm
- 35150-40** Length: 40 cm
- 35150-45** Length: 45 cm
- 35150-50** Length: 50 cm
- 35150-55** Length: 55 cm
- 35150-60** Length: 60 cm

Choke Collar – Flat with Limit
20 mm wide



- 35153-35** Length: 35 cm
- 35153-40** Length: 40 cm
- 35153-45** Length: 45 cm
- 35153-50** Length: 50 cm
- 35153-55** Length: 55 cm
- 35153-60** Length: 60 cm

Choke Collar – Flat with Limit
20 mm wide



- 35453-35** Length: 35 cm
- 35453-40** Length: 40 cm
- 35453-45** Length: 45 cm
- 35453-50** Length: 50 cm
- 35453-55** Length: 55 cm
- 35453-60** Length: 60 cm

Choke Collar – Round
20 mm wide



- 35454-40** Length: 40 cm
- 35454-45** Length: 45 cm
- 35454-50** Length: 50 cm
- 35454-55** Length: 55 cm
- 35454-60** Length: 60 cm

Collar with Nameplate
14 – 20 mm wide



- 35157-35** Length: 35 cm
- 35157-40** Length: 40 cm
- 35157-45** Length: 45 cm
- 35157-50** Length: 50 cm
- 35157-55** Length: 55 cm
- 35157-60** Length: 60 cm

Collar with Nameplate
14 – 20 mm wide



- 35457-35** Length: 35 cm
- 35457-40** Length: 40 cm
- 35457-45** Length: 45 cm
- 35457-50** Length: 50 cm
- 35457-55** Length: 55 cm
- 35457-60** Length: 60 cm

Tracking Collar
with leather wrapped
around edges
35 – 45 mm wide



- 35155-35** Length: 35 cm
- 35155-40** Length: 40 cm
- 35155-45** Length: 45 cm
- 35155-50** Length: 50 cm
- 35155-55** Length: 55 cm
- 35155-60** Length: 60 cm

Tracking Collar
with leather wrapped
around edges
35 – 45 mm wide



- 35455-35** Length: 35 cm
- 35455-40** Length: 40 cm
- 35455-45** Length: 45 cm
- 35455-50** Length: 50 cm
- 35455-55** Length: 55 cm
- 35455-60** Length: 60 cm



Choke Chain

Chrome-plated steel

- 35200-53** 53 cm long, 3 mm thick
- 35200-65** 65 cm long, 3.8 mm thick





Training Buck made of Wood
with 8 interchangeable wooden disks
35060-01 Max. 1200 g

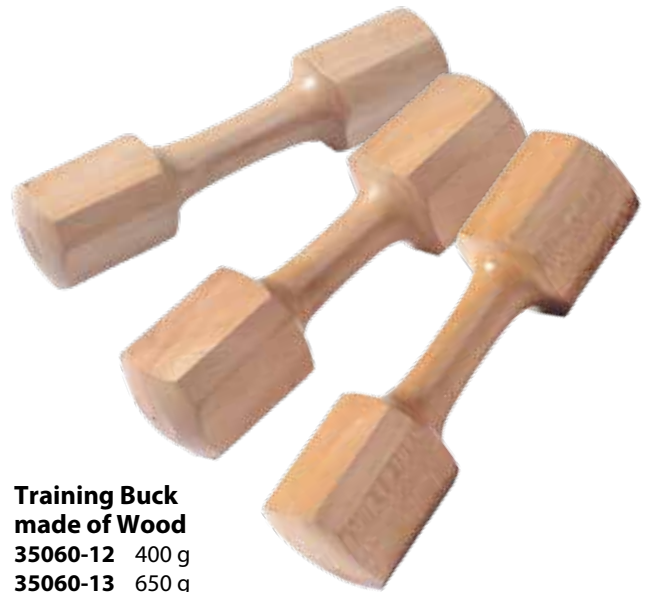

Training Buck made of Wood
35060-12 400 g
35060-13 650 g
35060-14 800 g



Dummies, Durable and Easy to Clean
made of tear-resistant, environmentally friendly canvas, green
35061-01 approx. 250 g, floatable
35061-02 approx. 500 g, floatable
35061-03 approx. 1000 g, floatable
35061-04 approx. 1500 g
35061-05 approx. 3000 g



Dog Tie Down
Metal spiral, 44 cm long, 8 mm thick
35062-01



PETBOX
Feeding box and water jug,
2-pc, brown, for 2 litres of water, dimensions: approx. 28x22x10 cm
35304-01



Water Canister
Collapsible, for 8 liters
35304-05



Safety Vest

Individually adjustable with velcro fasteners on back and neck. The dimensions correspond to the neck (N) or chest circumference (C) and are given in cm.

Yellow Orange

- 35163-05 35463-05** N approx. 40 to 50, C approx. 45 to 60
- 35163-06 35463-06** N approx. 50 to 70, C approx. 55 to 85
- 35163-07 35463-07** N approx. 55 to 70, C approx. 70 to 100
- 35163-08 35463-08** N approx. 30 to 40, C approx. 40 to 50



Safety Vest

with GPS pocket, individually adjustable with velcro fasteners on back and neck. The dimensions correspond to the neck (N) or chest circumference (C) and are given in cm.

- 35162-01** N approx. 30 to 40, C approx. 40 to 50
- 35162-02** N approx. 40 to 50, C approx. 45 to 60
- 35162-03** N approx. 50 to 70, C approx. 55 to 85
- 35162-04** N approx. 55 to 70, C approx. 70 to 100



Protective Vest 5-layer

Tested by the ITV Laboratory

Puncture resistance min. 710 N
 Shell: 100% polyester (500d)
 2nd layer: canvas
 3rd layer: Dupont Kevlar (filament 724)
 4th layer: Dupont Kevlar (200g/ m2)
 5th layer: 100% polyester mesh lining
 with outer pocket for GPS and 1 mesh mesh pocket,
 3 adjustable velcro straps to adjust the size

- 35169-11** Size S, chest circumference approx. 50 cm
- 35169-12** Size M, chest circumference approx. 55 cm
- 35169-13** Size L, chest circumference approx. 65 cm
- 35169-14** Size XL, chest circumference approx. 75 cm
- 35169-15** Size XXL, chest circumference approx. 85 cm



Safety Vest, Adjustable

	Size	Neck circumference	Chest circumference
35161-01	S	35 – 40 cm	40 – 60 cm
35161-02	M	35 – 40 cm	40–70 cm
35161-03	L	40 – 45 cm	50–70 cm
35161-04	XL	45 – 50 cm	60 – 80 cm

Trix® Tick Lasso

The Swedish market leader is taking Europe by storm. Quality product made in Sweden with 10-year warranty. Patented technique: This simple lasso technique removes the entire tick without crushing its body. Reduces the risk of disease transmission and infection. Optimized to remove ticks of all sizes on people and animals. Recommended by doctors, veterinarians and pharmacists.

35305-01





Visibility Collar

with 3 flags and rubber insert, 7 cm wide

	Neck circumference		Neck circumference
35167-32	32 cm	35167-48	48 cm
35167-36	36 cm	35167-52	52 cm
35167-40	40 cm	35167-56	56 cm
35167-44	44 cm		



Visibility Collar

Stretchable, neon red rubber band with reflective stripes, fits all sizes, 35 mm wide, PU 5

- 35163-03** with metal fastener, adjustable
- 35163-04** with velcro fastener



Visibility Collar

with reflective stripes, with 15 cm velcro fastener, PU 5

Yellow	Orange	
35163-40	35463-40	5 cm wide, 40 cm long
35163-50	35463-50	7 cm wide, 50 cm long
35163-60	35463-60	7 cm wide, 60 cm long



Visibility Collar

Yellow, with reflective stripes and rubber insert, PU 5

	5 cm wide, neck circumference		7 cm wide, neck circumference
35164-30	30 cm	35164-45	45 cm
35164-35	35 cm	35164-50	50 cm
35164-40	40 cm	35164-55	55 cm



Visibility Collar

with reflective stripes, 6 cm wide, with rubber insert and velcro fastener, adjustable, PU 5

Yellow	Orange	
35165-45	35465-45	30 – 45 cm neck circumference
35165-65	35465-65	40 – 65 cm neck circumference



Visibility Collar

with 3 flags, 6 cm wide, with rubber insert and velcro fastener, adjustable

Yellow	Orange	
35168-45	35468-45	30 – 45 cm neck circumference
35168-55	35468-55	40 – 55 cm neck circumference
35168-65	35468-65	50 – 65 cm neck circumference



15-year warranty!



Only the "best" for man's best friend, made in Germany, entire blanket washable at 95°C, free from germs, parasites and odors, scratch and bite resistant, dermatologically tested, developed by German veterinarians

Doctor Bark Padded Dog Blanket

Brown

- 35050-01** Approx. 65 x 50 cm
- 35050-02** Approx. 80 x 70 cm
- 35050-03** Approx. 100 x 80 cm
- 35050-04** Approx. 120 x 100 cm
- 35050-05** Approx. 140 x 110 cm



Doctor Bark Portable Blanket

Brown

- 35050-10** Approx. 70 x 100 cm

Doctor Bark Padded Dog Cushion

Brown

- 35051-01** Approx. 60 x 55 x 10 cm
- 35051-02** Approx. 75 x 65 x 10 cm
- 35051-03** Approx. 95 x 70 x 10 cm
- 35051-04** Approx. 100 x 85 x 10 cm
- 35051-05** Approx. 115 x 110 x 10 cm



Doctor Bark Padded Dog Bed

Brown

- 35052-01** Inside dimensions approx. 30 x 25 cm
- 35052-02** Inside dimensions approx. 40 x 30 cm
- 35052-03** Inside dimensions approx. 60 x 40 cm
- 35052-04** Inside dimensions approx. 70 x 50 cm
- 35052-05** Inside dimensions approx. 80 x 60 cm
- 35052-06** Inside dimensions approx. 90 x 70 cm





15-year warranty!



Only the "best" for man's best friend, made in Germany, entire blanket washable at 95°C, free from germs, parasites and odors, scratch and bite resistant, dermatologically tested, developed by German veterinarians

Doctor Bark Padded Inlay Blanket

Brown

- 35053-01** Approx. 40 x 35 cm
- 35053-02** Approx. 50 x 40 cm
- 35053-03** Approx. 65 x 45 cm
- 35053-04** Approx. 80 x 60 cm
- 35053-05** Approx. 90 x 65 cm



Doctor Bark Padded Outdoor/Inlay Cushion

Brown

- 35053-13** Approx. 60 x 40 x 7cm
- 35053-14** Approx. 70 x 50 x 8cm
- 35053-15** Approx. 80 x 60 x 9cm



Doctor Bark 1-seat Car Blanket

Brown

- 35056-01** Approx. 60 x 50 x 47 cm
- 35056-02** Approx. 60 x 50 x 60 cm
- 35056-03** Approx. 60 x 60 x 70 cm



Doctor Bark Trunk Blanket

Brown

- 35058-01** Approx. 60 x 90 x 45 cm
- 35058-02** Approx. 90 x 90 x 50 cm
- 35058-03** Approx. 100 x 100 x 50 cm



Down Double Dog Whistle

Artificial horn, PU 5
35310-01 70 mm
35310-02 85 mm



Down Double Dog Whistle

Genuine horn with leather strap, PU 5
35310-03 70 mm
35310-04 85 mm



Silent Dog Whistle

Nickel-plated brass, in case, PU 5
35310-05 60 mm



Silent Dog Whistle

Nickel-plated brass, in case, PU 5
35310-06 80 mm, with sleeve



Dog Bells made of Brass

35306-01 6 pcs., assorted:
 2 x Ø 25 mm, 2 x Ø 28 mm
 and 2 x Ø 34 mm
35306-02 6 pcs.: Ø 25 mm
35306-03 6 pcs.: Ø 28 mm
35306-04 6 pcs.: Ø 34 mm



Dog Bells, black, open

35307-01 6 pcs., assorted:
 2 x Ø 30 mm, 2 x Ø 40 mm
 and 2 x Ø 50 mm
35307-02 6 pcs.: Ø 30 mm
35307-03 6 pcs.: Ø 40 mm
35307-04 6 pcs.: Ø 50 mm



Dog Whistle

Genuine staghorn tip, PU 5
35310-07 70 mm



Dog Whistle

Genuine roe deer coronet, PU 5
35310-08 70 mm



Dog Whistle

Staghorn with shrill and regular
 whistle
35310-09 60 mm



10 | APPAREL



Boots	<i>Pages 202 – 204</i>
Accessories	<i>Pages 204 – 205</i>
Socks	<i>Page 205</i>
Slippers	<i>Page 206</i>
Visibility Clothing	<i>Pages 206 – 207</i>
Camouflage Clothing	<i>Page 207</i>
Suspenders	<i>Pages 208 – 209</i>
Hat Ornaments	<i>Pages 210 – 213</i>
Buttons	<i>Page 212</i>
Key Fobs	<i>Page 212</i>
Traditional Ties	<i>Pages 214 – 215</i>
Belts	<i>Page 215</i>





GRUB'S® Frostline 5.0

- Forest design
 - Trax sole
 - Rubber in the foot and ankle area for a more comfortable and hard-wearing boot
 - Easy to fold down
 - Oil resistant, resistant to fertilizer, slurry and detergents
 - Boot leg approx. 35 cm
 - Weight per pair approx. 1,8 kg
- 28217-37 – 48** Size 37 – 48



GRUB'S® Stalking 5.0

- Olive green
 - Vibram® multi sport outsole, shock absorbing sole
 - 6 mm thick footbed
 - Rubber in the foot and lower calf for a good foothold
 - Comfortable lining, maximum comfort
 - Resistant to oil and fertilizer
 - Hard toe
 - Can be worn with snowshoes
 - Boot leg approx. 35 cm, weight per pair approx. 1,9 kg
 - Down to -20°C
- 28219-37 – 48** Size 37 – 48



GRUB'S® Snowline 8.5

- Olive green
 - Vibram® multi sport outsole, shock absorbing sole
 - 6 mm thick footbed
 - Rubber in the foot and lower calf for flexibility
 - Additional ankle support and instep protection
 - Comfortable in temperatures down to -40°C
 - Resistant to oil and fertilizer
 - Hard toe
 - Can be worn with snowshoes
 - Boot leg approx. 35 cm, weight per pair approx. 2 kg
- 28218-37 – 47** Size 37 – 47



GRUB'S® Snowline Supersport 12.0

- Black
 - Vibram® multi sport outsole
 - 6 mm thick footbed
 - High rubber covering for a good foothold
 - Very warm and comfortable thanks to 12.0 TECHNOLOGY™
 - Comfortable in temperatures down to -50°C
 - Reinforced heel and toe
 - Can be worn with snowshoes
 - Boot leg approx. 35 cm, weight per pair approx. 2 kg
- 28220-37 – 48** Size 37 – 48





40%
2
3

Polyver® boot is 40 % lighter than a rubber boot

times more durable

times better insulation

Main pillars of success:

- Comfort
- Lightness
- Insulation
- Durability



Hunting boots Polyver® Winter

- Black, made of polyurethane
 - Excellent protection from the cold down to -40°C/-40°F
 - Exceptional comfort
 - Lightness, flexible
 - Antistatic treatment
 - 100% waterproof
 - Rigid outer sole for ideal support during longer walks
 - Sole profile ideal for ice and snow
 - Wide fit: better air circulation
 - Antibacterial treatment
 - Shock-absorbing heel
 - Especially durable and hard-wearing
- 28211-37 - 48** Size 37 - 48



- 1** EVACUATION CHANNELS easily eliminate all liquids and solid foreign bodies, facilitate decontamination
- 2** ANGLES OF SPIKES better grip in both directions (going up and down)
- 3** SPIKES provide excellent grip, especially on snow and ice

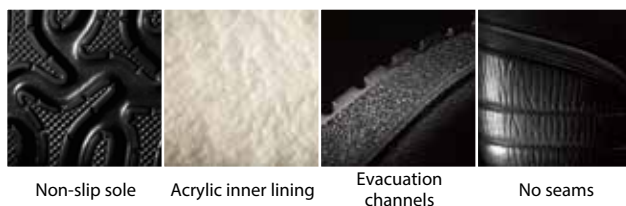

Hunting boots Polyver® Premium

- Green, made of polyurethane
 - Excellent protection from the cold down to -50°C/-58°F
 - Exceptional comfort
 - Lightness, flexible
 - Antistatic treatment
 - 100% waterproof
 - Rigid outer sole for ideal support during longer walks
 - Sole profile ideal for ice and snow
 - Wide fit: better air circulation
 - Defined heel: improved safety, particularly on ladders
 - Antibacterial treatment
 - Shock-absorbing heel
 - Easy to take off
 - Especially durable and hard-wearing
- 28209-37 - 47** Size 37 - 47



- 1** DEFINED HEEL: Improved safety on ladders
- 2** EVACUATION CHANNELS easily eliminate all liquids and solid foreign bodies, facilitate decontamination
- 3** GROOVES increase the slip resistance during contact with the ground
- 4** ANGLES OF SPIKES better grip in both directions (going up and down)
- 5** BARRETTES improve grip, particularly on ladders
- 6** SPIKES provide excellent grip, especially on snow and ice

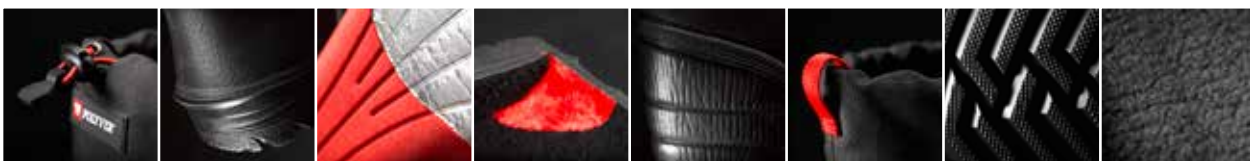

Adjustable collar Boot removal tab Removable premium insole Heel reinforcement No seams Boot strap Non-slip sole Inner lining wool/acrylic



Crosslander boot „Kodiak“

knee-high, material: natural rubber, interior 4 mm neoprene, boot leg adjustable in width, waterproof up to the boot rim, as the stretching area is underlain with rubber, with removable insole, protection from the cold up to -20°C, Color: olive

28204-37 - 46 Size 37 - 46

nora®



Champion Game and Leisure Boot

- High-quality natural rubber
- Flexible at low temperatures down to -30°C
- Calf Height 42 cm
- Individually adjustable calf strap
- Anatomically formed footbed
- Non-slip, abrasion-resistant profiled outer sole
- 4.5 mm thick neoprene lining
- Color: olive

28200-37 - 47 Size 37 - 47

nora®



John Wellington Boot

- Calf Height 35 cm
- Fixed warm lining
- Draw-string at top
- Completely watertight
- Non-slip outer sole
- Color: olive
- Awarded best value-for-money boot by "Pirsch" magazine

28203-37 - 48 Size 37 - 48



Gaitors

Polyester, zip under the hook-and-loop fastening strip, draw string at top, max. calf Ø 17 cm

28305-01 Color: green/orange
28305-02 Color: green



Gaitors of Nubuck Leather

zipper under velcro fastening, with drawstring at the top, max. calf circumference 48 cm

28305-03



Shoe Protector

Simply fix on the shoe with push-button, the muzzle can be put on it, the leather edge prevents gliding off

28305-04



Nylon Boot Bag

55 x 33 x 23 cm, ventilation opening with webbing, reinforced base

28239-02



Nylon Boot Bag

Specially adapted to POLYVER® boots, black, can be opened widely with zipper, reinforced base, waterproof, washable, 40 x 30 x 35 cm

28209-01





Boot Jack
34326-01

Crosslander Merino Socks

- high-quality hunting socks
- absorb up to 30 % of their own weight in moisture
- highly elastic cuffs for good hold in the boot
- antibacterial
- odour-inhibiting
- temperature-regulating

Material: **80% merino wool**, 15 % polyamide, 5 % elastane, Color: Khaki, PU 6

28231-01 Sizes 36 - 41
28231-02 Sizes 42 - 46



Boot Jack
with two brushes
34326-02

Crosslander „Anti Tick“ Socks

- high-quality hunting socks
- absorb up to 30 % of their own weight in moisture
- highly elastic cuffs for good hold in the boot
- antibacterial
- odour-inhibiting
- temperature-regulating
- **Tick defense** through highly effective anti tick agent
- keeps for approx. 40 laundries

Material: **65% merino wool**, 20 % polyamide, 10 % polypropylene, 5 % elastane, Color: Black, PU 6

28232-01 Sizes 36 - 41
28232-02 Sizes 42 - 46



Sokket Boot Liners

Guaranteed warm and dry feet in rubber boots thanks to 2-layer thermal system

28230-38 Size 38 – 39 **28230-44** Size 44 – 45
28230-40 Size 40 – 41 **28230-46** Size 46 – 47
28230-42 Size 42 – 43



Comfort shoe insoles

- Breathable micro-perforations for air and moisture
- Skin compatible microfibre velours surface material
- Memory foam for optimal comfort
- Core foam for fitting and support
- Extra bottom layer for additional stability and shock absorption

28233-39 – 46 Size 39 - 46



Shoe Spikes

28240-02 Size M
28240-03 Size L
28240-04 Size XL

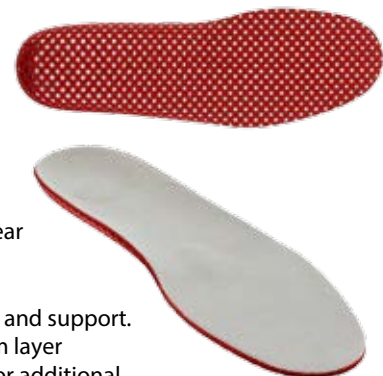

Thermal shoe insoles

- Anti-slip layer
- Perfect for winter wear
- Memory foam for optimal comfort
- Core foam for fitting and support.
- Insulating aluminium layer
- Extra bottom layer for additional stability and shock absorption

28234-39 – 46 Size 39 - 46



Driven-hunt Vest, orange

2 large zipped pockets and 2 accessory pockets on the front, Material: 65% cotton, 35% polyester

28307-11 size M

28307-13 size XL

28307-12 size L

28307-14 size XXL



Visibility Vest, with reflective stripes, comes in a bag
28307-03



Mule

with exchangeable leather footbed, PU outsole, handsewn, German quality workmanship, size 39 – 47
28252-39 – 47 light brown, with deer theme



Men's Leather Slipper

with leather footbed, PU outsole, handsewn, German quality workmanship, size 39 – 47
28250-39 – 47 Green, with deer theme



Men's Leather Slipper

with leather footbed, PU outsole, handsewn, German quality workmanship, size 39 – 47
28251-39 – 47 Green, with wild boar theme



Men's Leather Slipper

with leather footbed, PU outsole, handsewn, German quality workmanship, size 39 – 47
28256-39 – 47 Brown, with deer theme



Men's Leather Slipper

with leather footbed, PU outsole, handsewn, German quality workmanship, size 39 – 47
28259-39 – 47 Brown, with wild boar theme





Camouflage Head Net, with Eye Slit, one size
32120-08



Trapper Hat

with faux fur, green, size S – XXXL, outer: 100% polyester, inner: 50% polyester, 50% faux fur

- | | |
|------------------------|---------------------------|
| 32121-01 Size S | 32121-04 Size XL |
| 32121-02 Size M | 32121-05 Size XXL |
| 32121-03 Size L | 32121-06 Size XXXL |



Mosquito Head Net, Strong nylon net with elastic band
32120-02



Hat Band

with all-round reflective stripes, yellow, PU 5

universal size: 70 cm long

28308-03 adjustable with 15 cm velcro fastener, 5 cm wide



Hat Band

with all-round reflective stripes, red, PU 5

universal size: 70 cm long

28308-04 adjustable with 10 cm velcro fastener, 3,6 cm wide



Softshell Hunting Vest

camouflage, 2 side pockets and 1 breast pocket, 100% polyester

- | | |
|------------------------|--------------------------|
| 28372-01 size M | 28372-03 size XL |
| 28372-02 size L | 28372-04 size XXL |



Visibility Vest - Trapezoid

Side buckles with elastic bands ensure a perfect fit.

- | |
|-------------------------------|
| 28307-01 Length 105 cm |
| 28307-02 Length 120 cm |



Suspenders
Elastic band with strong clips, length 120 cm, solid green, PU 3
28100-01 30 mm wide
28100-02 35 mm wide



Suspenders
Elastic band with leather button-on attachments, length 120 cm, solid green, PU 3
28100-03 35 mm wide



Suspenders
Elastic band with leather button-on attachments length 120 cm, green with roe deer head, PU 3
28100-05 35 mm wide



Suspenders
Elastic band with strong clips, length 120 cm, green with roe deer head, PU 3
28100-06 35 mm wide



Suspenders
Elastic band with strong clips, length 120 cm, green with colorful roe deer head, PU 3
28100-07 35 mm wide



Suspenders
Elastic band with strong clips, length 120 cm, green with hunting themes, PU 3
28100-08 35 mm wide



Suspenders
Elastic band with strong clips, length 120 cm, beige with green hunting themes, PU 3
28100-19 35 mm wide



Suspenders
Elastic band with strong clips, length 120 cm, green with ducks, PU 3
28100-11 35 mm wide



Suspenders
Elastic band with strong clips, length 120 cm, green with trout, PU 3
28100-13 35 mm wide



Suspenders
Elastic band with strong clips, length 120 cm, green with hunting themes, PU 3
28100-16 35 mm wide



Suspenders
Elastic band with strong clips, length 120 cm, green with edelweiss, PU 3
28100-10 35 mm wide



Suspenders
Elastic band with strong clips, length 120 cm, green patterned, PU 3
28100-21 35 mm wide





BICLIP® Suspenders

Chest strap shape, only 2 clips needed to attach on side of pants

28103-01 Solid olive

28103-02 Green with hunting themes



Suspenders with Clips

Elastic band, length 120 cm, 40 mm wide, PU 3

28102-01 Green

28102-02 Camouflage

Suspenders with Hooks, for hanging in belt,

Y-shape, elastic band, length 120 cm, 40 mm wide, PU 3

28101-01 Green

28101-02 Camouflage



Suspenders Y-shape

Elastic band with strong clips, length 120 cm, green with hunting themes, PU 3
28100-15 35 mm wide

Suspenders Y-shape

Elastic band with leather loops, length 120 cm, unicolor green, PU 3
28100-23 35 mm wide

Suspenders Y-shape

Elastic band with leather loops, length 120 cm, green with hunting motives, PU 3
28100-24 35 mm wide

Suspenders Y-shape

Elastic band with leather loops with clips, length 120 cm, unicolor green, PU 3
28100-25 35 mm wide



Nickel Silver Hat Pin
Silver plated, PU 3
30410-01 Antler,
4 cm



Nickel Silver Hat Pin
Silver plated, PU 3
30410-04 Wild boar,
3 cm Ø



Nickel Silver Hat Pin
Silver plated, PU 3
30410-06 Roe deer,
3 cm Ø



Nickel Silver Hat Pin
Silver plated, PU 3
30410-07 Deer,
3 cm Ø



Nickel Silver Hat Pin
Silver plated, PU 3
30410-09 Hunting horn
with Hubertus deer,
2,5 x 4 cm



Nickel Silver Hat Pin
Silver plated, PU 3
30410-10 Deer with
enamel wreath,
3,5 cm Ø



Nickel Silver Hat Pin
Silver plated, PU 3
30410-11 Chamois in
enamel wreath,
3,5 cm Ø



Nickel Silver Hat Pin
Silver plated, PU 3
30410-12
Wood grouse with ruffles,
3,5 cm Ø



Nickel Silver Hat Pin
Silver plated, PU 3
30410-13 Wild boar with
ruffles, 4,5 cm Ø



Nickel Silver Hat Pin
Silver plated, PU 3
30410-15 Hubertus deer,
4 cm



Nickel Silver Hat Pin
Silver plated, PU 3
30410-17 Hunting horn,
3,5 x 7 cm



Nickel Silver Hat Pin
Silver plated, PU 3
30410-22 Hubertus deer,
3,5 cm Ø



Nickel Silver Hat Pin
Silver plated, PU 3
30410-24 Deer with ruffles,
4 cm Ø



Nickel Silver Hat Pin
Silver plated, PU 3
30410-25 Roebuck,
3,5 cm



Nickel Silver Hat Pin
Silver plated, PU 3
30410-28 Chamois with
ruffles, 4,5 cm Ø





Hat Feather, Imitation eagle fluff with sleeve
30412-57 approx. 25 cm high
30412-59 approx. 35 cm high



Hat Feathers, 12 pcs. assorted
30412-60



Snipe Feather Holder
 Ø 2,5 cm, PU 3
30418-07



Fox Fang Holder
 Approx. 3,5 cm
30418-08



Hat Feathers, 6 pcs. assorted
30412-72



Antelope Tuft
 (Imitation chamois), with simple sleeve
30417-02 11 cm
30417-03 13 cm
30417-01 15 cm



Deer Tuft, with sleeve
30417-11 12 cm
30417-12 16 cm



Wild Boar Tuft
 15 cm
30417-04 with sleeve
30417-14 without sleeve



Genuine Staghorn Button, PU 24
30500-11 16"/11 mm **30500-20** 32"/20 mm
30500-15 26"/15 mm **30500-22** 36"/22 mm
30500-17 28"/17 mm **30500-25** 40"/25 mm



Nickel Silver Hat Pin Set, Silver plated, 12 hat pins with hunting themes, assorted, approx. 2,5 cm high
30410-41



Key Fobs
30402-03 Antler tip



Key Fobs
30402-06 Wild boar



Key Fobs
30402-07 Wild boar tusk



Key Fobs
30402-10 Deer teeth





Feather Sleeve
Decorated, PU 3
30418-09 Height 2,5 cm



Feather Sleeve
Smooth, PU 3
30418-10 Height 3 cm



Tuft Sleeve
with oak leaves, PU 2
30419-01 Height 4,5 cm,
Ø 13 mm



Tuft Sleeve
Smooth with oak border,
PU 2, Height 4,5 cm
30419-02 Ø 13 mm
30419-18 Ø 17 mm



Tuft Sleeve
with chamois, PU 2
30419-03 Height 4,5 cm,
Ø 12 mm



Tuft Sleeve
Oak leaf, PU 2
30419-04 Height 4,8 cm,
Ø 14 mm



Tuft Sleeve
Imitation deer teeth, PU 2
30419-05 Height 4,5 cm,
Ø 13 mm



Tuft Sleeve
For wild boar tuft, PU 2
30419-06 Height 4 cm,
35 mm wide



Tuft Sleeve
For wild boar tuft, PU 2
30419-08 Height 3 cm,
26 mm wide



Tuft Sleeve
with blackcock, PU 2
30419-09 Height 3,5 cm,
27 mm wide



Tuft Sleeve, PU 2
with blackcock, Height 4,5 cm
30419-10 45 mm wide
30419-17 55 mm wide



Tuft Sleeve
with chamois, PU 2
30419-11 Height 4,5 cm,
Ø 13 mm



Tuft Sleeve
with chamois, PU 2
30419-12 Height 4,5 cm,
Ø 17 mm



Tuft Sleeve
with chamois
30419-13 Height 4,5 cm,
Ø 13 mm



Tuft Sleeve
with deer head, PU 2
30419-14 Height 4,5 cm,
Ø 13 mm



Tuft Sleeve, PU 2
Chamois with support,
Height 4.5 cm
30419-16 Ø 12 mm
30419-15 Ø 20 mm



Braided Bolo Ties

Green, with nickel silver-plated slides, Alcantara bands

27921-06 Roebuck

27928-06 Deer

27937-06 Staghorn button

27939-06 Hunting horn



Leather Bolo Ties

olive, braided, with hand-carved staghorn rose

27933-01 Deer

27933-02 Wild boar

27933-03 Roe deer

27933-04 Chamois





Bolo Ties, with silver-plated slide
27911-01 Deer



27911-02 Roe deer



27911-03 Chamois



Leather Belt
 Brown, buckle with decorative wild boar theme, 30 mm wide

- | | |
|-----------------------------|-----------------------------|
| 30703-11 Size 110 cm | 30703-13 Size 130 cm |
| 30703-12 Size 120 cm | 30703-14 Size 140 cm |



Leather Belt
 Brown, buckle with decorative wild boar theme, 40 mm wide

- | | |
|-----------------------------|-----------------------------|
| 30704-11 Size 110 cm | 30704-13 Size 130 cm |
| 30704-12 Size 120 cm | 30704-14 Size 140 cm |



Leather Belt
 Brown, buckle with decorative deer theme, 38 mm wide

- | | |
|-----------------------------|-----------------------------|
| 30708-11 Size 110 cm | 30708-13 Size 130 cm |
| 30708-12 Size 120 cm | 30708-14 Size 140 cm |



Leather Belt
 Brown, buckle with decorative wild boar theme, 38 mm wide

- | | |
|-----------------------------|-----------------------------|
| 30707-11 Size 110 cm | 30707-13 Size 130 cm |
| 30707-12 Size 120 cm | 30707-14 Size 140 cm |

Lined area for notes, consisting of 20 horizontal grey bars.



11 | GIFT ARTICLES / HOME ACCESSORIES



Handkerchiefs	<i>Page 218</i>
Document pouches	<i>Page 218</i>
Hip Flasks	<i>Page 219</i>
Vacuum Flasks	<i>Pages 220 – 221</i>
Bottle Openers, Decorative Corks	<i>Page 222</i>
Glassware	<i>Pages 222, 224 – 227</i>
Coffee mugs	<i>Page 223</i>
Napkins	<i>Page 223</i>
Beer Steins and Glasses	<i>Pages 224, 228</i>
Schnapps Sets	<i>Pages 224 – 225</i>
Pewter	<i>Page 229</i>
Antler Chandeliers	<i>Page 230</i>
German Hunting/Cooking Books	<i>Page 231</i>
German Greeting Cards	<i>Pages 232 – 233</i>
Wrapping Paper, Miscellaneous	<i>Page 233</i>
Figurines	<i>Page 234</i>

ceef © shoddy



3 Handkerchiefs

in gift box, 100% cotton, embroidered

- 27030-01** Deer, wood grouse, roe deer, green
- 27030-05** Pheasant, roe deer, hunting horn, green
- 27030-06** Roe deer, deer, pheasant, white

- 27030-07** Solid green
- 27030-09** Roe deer, hare, pheasant, green
- 27030-11** Pheasant, duck, snipe, green
- 27030-12** Roe deer, deer, chamois, green



2 Handkerchiefs

in gift box, 100% cotton

- 27031-01** Deer/chamois, green embroidered
- 27031-02** Deer/roe deer, green embroidered
- 27031-03** Roe deer/pheasant, green embroidered



Hunting License Case

Brown, leather with embossed deer head
32450-02 170 x 110 mm



Wallet

Green, made of durable leather, with inner pockets and embossed deer head, 2 bill pockets, 1 coin pocket, 3 credit card slots
32450-01 110 x 90 mm



Document pouch

Leather, green, 6 compartments
32450-03 165 x 115 mm



Hunting License Case

made of felt, green
32450-04 170 x 120 mm



Hunting License Case

of leather, with embossed deer head, for Austria
32450-05 9 x 13,5 cm



Hunting License Case

of felt, green, with embroidered deer head, for Austria,
32450-06 9 x 13,5 cm





Stainless Steel Cup
in leather case, 4 pcs.
32401-11 Schnapps cup

32401-12 Wine cup



Stainless Steel Telescopic Cup
in metal case
32401-08 Schnapps cup



Hip Flask

- 32409-11** 180 ml, with deer head badge
- 32409-12** 180 ml, with wild boar head badge
- 32409-13** 180 ml, with snipe head badge



Stainless Steel Telescopic Cup
in metal case
32401-09 Wine cup



Stainless Steel Hip Flask

- Smooth, streamlined shape
- 32409-27** 120 ml
- 32409-28** 240 ml



Stainless Steel Hip Flask

- in gift box, with 4 cups and funnel
- 32411-03** Flask 180 ml



Vacuum Flask

of high-quality double wall stainless steel, with loop locking and antislip protective pad, 100 % leak-proof, free from BPA and phthalates, 700 ml

- 32415-01** Stainless steel
- 32415-02** Black



Vacuum Flask

of high-quality double wall stainless steel with 2 cups and additional screw cap, BPA-free, green, 1000 ml

- 32415-03**



Vacuum Flask

of high-quality double wall stainless steel, with 2 cups and additional screw cap, BPA-free, black

- 32415-08** 500 ml
- 32415-04** 750 ml
- 32415-05** 1000 ml



Vacuum Flask

of high quality double wall stainless steel, with 2 cups, shoulder belt and useful handle, BPA-free, black

- 32415-06** 1200 ml
- 32415-07** 1500 ml





Vacuum Container

of high-quality double wall stainless steel, locking with pressure-relief button, BPA-free

- 32416-04** Black 500 ml
- 32416-01** Black 750 ml
- 32416-02** Black 1000 ml
- 32416-03** Olive 750 ml



Water Bottle

of stainless steel, with loop locking, 100 % leak-proof, very light, free from BPA and phtalates

- 32417-04** Grey 680 ml
- 32417-05** Grey 1000 ml



Vacuum Cup

of high-quality stainless steel, with click-lock and antislip protective pad, 100 % leak-proof, free from BPA and phtalates

- 32418-01** Stainless steel 450 ml
- 32418-02** Black 450 ml



Bottle Openers
 19107-01 with roe deer antler
 19107-05 Horn



Bar Accessories
 2 pcs., 1 corkscrew and
 1 bottle opener in a gift box
 19108-01

Wine Bottle Corkscrews

Silver-plated, 6 cm in height

- 19151-01 Boar
- 19151-02 Pheasant
- 19151-03 Duck
- 19151-04 Wood grouse
- 19151-05 Hunting horn



Wine Bottle Corkscrews

with tin figurines

- 19151-11 Stag, 8 cm in height
- 19151-12 Boar, 7 cm in height



Vinegar and Oil Bottle Gift Set
 with hunting decor
 21123-01



Salt and pepper shaker
 with hunting decor, height
 salt/pepper 10 cm, in gift box
 21123-03



Salt and pepper shaker
 On oak board with roe deer antler,
 height salt/pepper 10 cm
 21123-02





4-pc Coffee Mug Set
0,25 l, with hunting themes
25202-05

4-pc Coffee Mug Set
0,25 l, with hunting themes
25202-08



Paper Napkins
20 pcs. in cellophane, PU 5



19200-02
Deer head



19200-03
Deer



19200-06
Colorful duck theme



19200-17
Hunting



19200-13
Deer



19200-14
Deer



19200-15
Wild boar



19200-07
Deer head



19200-04
Green/beige



19200-05
Waidmannsheil



4 Pilsner Glasses, 380 ml, with hand cut hunting themes, in gift box
21104-20



Crystal Weissbier Glass,
0,5 l, hand cut
22725-01 Hunting theme,
assorted



4 Pilsner Glasses, 380 ml, with hunting decor, in gift box
21104-21



Crystal Weissbier Glass, 0,5 l,
detailed hand engraving
22725-02 Red deer



Schnapps Serving Set
with 6 handled shot glasses 6 cm in
height on an oak board with roe deer
antler, themes: stag, roebuck, boar,
pheasant, duck, hare
20152-28



Schnapps Serving Set
with 6 shot glasses 7 cm in height
on an oak board, themes: stag, roebuck,
boar, pheasant, duck, hare
20152-25



Schnapps Serving Set
with 6 shot glasses 7 cm in height
on acacia board approx. 19 cm Ø,
themes: stag, roebuck, boar,
pheasant, wood grouse, hare
20152-27





Schnapps Set
7 pcs., with hunting decor, in gift box
21175-17



Schnapps Set
7 pcs., with hunting decor colored, in gift box
21175-18



Crystal Glasses in a Gift Box
200 ml, 6 fruit brandy glasses with hunting decor
21121-07



Schnapps Glasses in a Gift Box
6 shot glasses, with hunting decor
21104-02



Schnapps Glasses in a Gift Box
6 shot glasses with handles, with hunting decor
21104-06



Schnapps Glasses in a Gift Box
6 shot glasses with colored hunting decoration
21104-09



Crystal Glasses in a Gift Box
240 ml, 6 wine glasses with hunting decor
21121-06



6 Rummors
with hunting decor
21121-04 0,2 l



Wine Set
5 pcs., with hand-cut hunting themes, in gift box,
comes with: 1 decanter 1200 ml, 4 glasses 300 ml
21175-12



Wine Set
5 pcs., with hunting decor, in gift box,
comes with: 1 decanter 1200 ml, 4 glasses 300 ml
21175-14



Juice Set, 7 pcs., in gift box, comes with: 1 pitcher 1500 ml, 6 glasses 350 ml
21175-13 with hunting decor
21175-11 with hand-cut hunting themes





21108-01

-02

-08

-10

-05

-03

-09

-11

-12

“Claudia” High-quality Crystal Glass Series

with hunting decor. Themes: deer, roe deer, wild boar, wood grouse, pheasant, duck. 6 pieces each in a box

21108-01 6 white wine glasses, 190 ml

21108-02 6 Burgundy wine glasses, 340 ml

21108-03 6 liqueur goblets, 50 ml

21108-05 6 champagne wine glasses, 180 ml

21108-08 6 cognac glasses, 250 ml

21108-09 6 shot glasses, 60 ml

21108-10 6 tulip beer glasses, 280 ml

21108-11 6 long drink glasses, 380 ml

21108-12 6 whiskey glasses, 290 ml



21107-03

-01

-09

-05

-11

-10

-12

-02

-08

“Claudia” High-quality Crystal Glass Series

with hand-cut hunting themes. Themes: deer, roe deer, wild boar, wood grouse, pheasant, duck. 6 pieces each in a box

21107-01 6 white wine glasses, 190 ml

21107-02 6 Burgundy wine glasses, 340 ml

21107-03 6 liqueur goblets, 50 ml

21107-05 6 champagne wine glasses, 180 ml

21107-08 6 cognac glasses, 250 ml

21107-09 6 shot glasses, 60 ml

21107-10 6 tulip beer glasses, 280 ml

21107-11 6 long drink glasses, 380 ml

21107-12 6 whiskey glasses, 290 ml



Beer Stein, 1/2 liter, with hinged pewter lid

22313-21 Hunting in spring **22313-22** Hunting in summer **22313-23** Hunting in autumn **22313-24** Hunting in winter



Beer Stein, 1/2 liter
Porcelain with hinged pewter lid, domed
22295-07 Shooting theme



Beer Stein, 1/2 liter
Glass mug with hinged pewter lid, flat
22503-41 Shooting theme



Beer Stein, 1/2 liter
Crystal glass with hinged pewter lid, hand cut
22512-01 Hunting theme



Beer Stein, 1/2 liter
Crystal glass with hinged pewter lid, hand cut
22512-06 Red deer



Beer Stein, 1/2 liter
Crystal glass with hinged pewter lid
22503-01 with pewter appliqué, deer



Beer Stein, 1/2 liter
Crystal glass with hinged pewter lid
22503-02 with pewter appliqué, wild boar



Beer Stein, 1/2 liter
Crystal glass with hinged pewter lid
22503-16 White decor, PU 6



Beer Stein, 1/2 liter
Crystal glass with hinged pewter lid
22515-06 Wild boar head lid





Pewter Plate
with hunting theme, 26 cm Ø
36027-02



Pewter Plate
with shooting theme, 26 cm Ø
36055-13



Pewter Plate
with hunting theme, 23 cm Ø
36023-02 Ducks



Pewter Plate
with shooting theme, 26 cm Ø
36055-12 "Schützen-Toni"



Pewter Beer Mugs
1/2 l, 18 cm high
36401-02 Shooting theme



Pewter Cups
with hunting themes
36208-01 4,8 cm high
36208-02 8,5 cm high

36208-03 11 cm high



Pewter Cup
with shooting themes, 11,5 cm high
36213-04



Pewter Goblets
Smooth
36714-01 13 cm

36714-02 15 cm

36714-03 17 cm



Pewter Cup
with wild boar head
36210-01 Shot glass, 9 cm high
36210-02 Cup, 14 cm high



Chandelier
made of 3 fallow deer antlers, 3-lamps,
with simple glass shades, Ø approx. 65 cm
11127-01



Chandelier
made of medium-sized deer antlers, 3 lamps,
glass shades pointing down, Ø approx. 65 cm
11120-01 with simple glass shades
11120-02 with hand-cut glass shades with hunting themes
11120-03 with glass shades with hunting decor



Chandelier
made of medium-sized deer antlers, approx. 60 x 60 cm,
height approx. 65 cm
11128-01 with 4 simple glass shades
11128-02 with 4 hand-cut glass shades with hunting themes
11128-04 with 4 glass shades with hunting decor



Chandelier
made of large red deer antlers, 3 lamps with chain
suspension, approx. 75 cm Ø, height approx. 65 cm
11132-01 with 3 simple glass shades
11132-02 with 3 hand-cut glass shades with hunting themes



Glass Shade
Gold amber
11990-52 15 cm Ø,
14 cm high
11990-56 13 cm Ø,
12 cm high



**Glass Shade, gold
amber with hunting decor**
11990-55 13 cm Ø,
12 cm high



**Glass Shade, gold
amber with hunting cut**
11990-53 15 cm Ø,
14 cm high



**Glass Shade, gold
amber with hunting cut**
11990-57 13 cm Ø,
12 cm high





Blase, Joachim Reddemann
Die Jägerprüfung
32. Auflage
49100-20 928 Seiten



Krebs
Vor und nach der Jägerprüfung
Der gesamten 19. Auflage
49300-21 896 Seiten



Rolf Hennig
Die Waffen-Sachkunde-Prüfung
in Frage und Antwort
49300-01 288 Seiten



Handbuch Jägersprache
49300-03



Nachsuchen wie die Profis
49301-36



Schuss- und Jagdtagebuch
49120-79 128 Seiten



Alice Groß
Schussbuch Jagdaufzeichnungen
49500-27 128 Seiten



Schussbuch
49501-35 120 Seiten



Tabel
Der Jagdgebrauchshund
Erziehen, Abrichten und Führen
49300-18 312 Seiten



Jürgen Schulte
Na dann prüft mal schön
49100-14 96 Seiten



Kuch, Erich/Meinhard, Fritz
Jägerlatinum - Den Jägern auf's Maul geschaut, 60 Cartoons
49501-23 64 Seiten



Gert G. von Harling
Einfach zum Schießen
49501-26 64 Seiten



Gert G. von Harling
Einfach zum Schießen Band 2
49501-33 64 Seiten



Neumann-Neudamm
Wildwurst & Wildschinken
49501-29 96 Seiten



Pottkämpfer/Stettler
Das Wildschweinkochbuch
49100-98 96 Seiten



Christa Muhle-Witt
Wild in der Küche, das umfassende Wildkochbuch
49300-28 240 Seiten



32501-04 PU 10



32501-05 PU 10

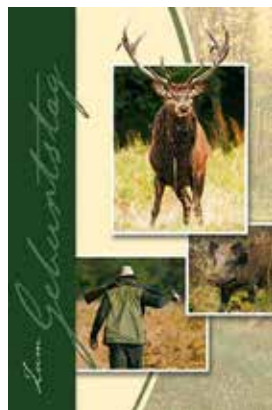

32501-06 PU 10



32501-07 PU 10



32501-14 PU 10



32501-15 PU 10



32501-17 PU 10



32501-20 PU 10



32501-22 PU 10

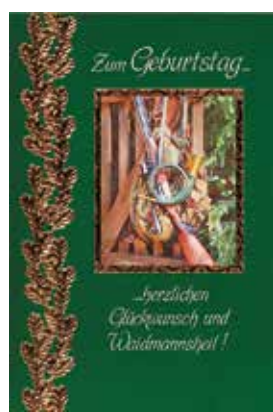

32501-29 PU 10



32501-30 PU 10

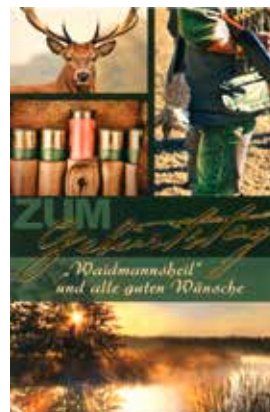

32501-03 PU 10



32501-34 PU 10



32501-11 PU 10



32501-12 PU 10



32501-13 PU 10





Christmas Card
32501-42 with envelope, PU 10



32501-31 PU 10



32502-02 PU 10



Wrapping Paper

Green, with hunting themes

- 19202-02 Roll 70 cm wide, 200 cm long, PU 20
- 19202-04 Sheet, 70 x 50 cm, PU 25
- 19202-05 Sheet, 70 x 100 cm, PU 25
- 19202-98 Roll, 250m long, 50 cm wide
- 19202-99 Roll, 250m long, 70 cm wide



Gift Voucher

with hunting theme,
with envelope
32503-02 PU 10

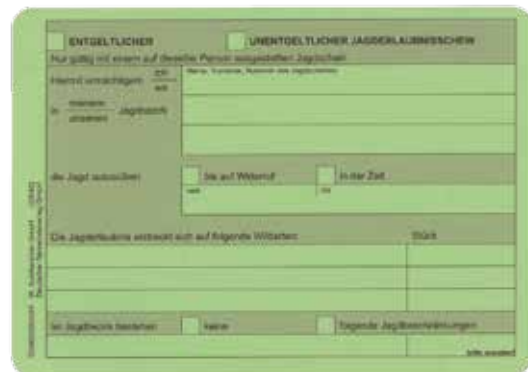

Jagderlaubnisscheine

32501-02 20 pcs. 32501-01 100 pcs.



Ballistol Universalschnaps

as a spitting image of the original Ballistol Oil, this fire-apple liquor (25% vol.) is a funny promotional item.

33500-50



Armani Animal Figurine

Porcelain-like figurine made of kaolin, on burl wood base, hand painted

70550-S 2 setters, 41 cm high



Armani Animal Figurine

Porcelain-like figurine made of kaolin, on burl wood base, hand painted

70281-S Owl, 60 cm high



Armani Animal Figurine

Porcelain-like figurine made of kaolin, on burl wood base, hand painted

70582-S Pheasant, 37 cm high



A	
Adapters	62
Addinol	51
Aiming accessories	49
Airgun ammunition	96-99
Alu skulls	188
Ammunition boxes	93
Antler chandeliers	230
Apparel	201-215
Armani figurines	234
Artificial skulls	188
Attractants	160-163
AttraTec	161-162
B	
Backpack with stool	123
Ballistol	52-57
Beater sticks	153-154
Beech tar	160
Beer steins and glasses	228
Belts	215
Berloque pistol	107
Binocular case	32
Binoculars	31
Bipods	48
Birthday greeting cards	232
Bleaching products	178
Bone forceps	172
Bone saw	173
Boot bags	204
Boot jacks	205
Boots	202-204
Bottle openers	222
Bow case	92
Brünnner mounts	24
Brunox	51
Bullet traps	102
Butt out dressing tool	172
Buttolo	157
Buttons	212
C	
Camouflage clothing	207
Camouflage gloves	146
Camouflage gunsocks	146
Camouflage netting	146
Can safe	52
Carbon stocks	46
Cartridge bags	135-137
Cartridge belts	134-135
Cartridge cases	93
Cartridge pouches	135-137
Cases	82-92
Christmas greeting cards	233
Cleaning aids	178
Cleaning products	58-65
Coffee mugs	223
Collars	194
Collimator	13
Combination padlock	67
Combination slide-lock	83
Cushions	126
D	
Dazer dog deterrent	139
Decorative corks	222
Decoys	168
Deer trays	170
Deer whistle for cars	165
Defense spray	139
Dehumidifiers	45
Diabolo	96-99
Docter sight	16, 19
Doctor Bark	198-199
Document case	218
Dog accessories	189-200
Dog beds	198-199
Dog bells	200
Dog collars	194
Dog deterrent	139
Dog feeding box/water jug	195
Dog leashes	190-193
Dog protective vests	196
Dog training accessories	195
Dog whistles	200
Dot sights	10-18
Dressing saws	172
Dressing sets	174
Dressing tools	172
Dummies	195
E	
Esbit	220-221
Eyeshades	105
F	
Feed drum	156
Feed spreader	155
Figurines	234
Finger protection for trigger guard	45
Flitz	57
Fly nets	171
Füll-Fix	178
Fürst Pless	125
G	
Gaitors	204
Gambrel	172
Game bird carriers	137
Game calls	156-160
Game cameras	166-167
Game clocks	167
Game dragging aids	176
Game feeding / baiting	155-156
Game repellent	163
Game scales	175
Gas cartridges for portable heater	140
German greeting cards	232-233
German hunting/cooking books	231
Gift articles / home accessories	217-234
Glassware	224-228
Glock special tool	59
Gloves vinyl	171
Greiner game docks	167
Grubs	202
Gun accessories	36-93
Gun bags	66-80
Gun blueing	53
Gun cases	82-92
Gun cleaning	51-65
Gun cleaning rack	59
Gun oil	51-55
Gun plugs	50
Gun socks	79
Gun stock cartridge pouches	137
GunCer, Gunex	55
H	
H&N	96-99
Hand warmers	140
Handkerchiefs	218
Harris Bipods	48
Hat	207
Hat bands	207
Hat ornaments	210-213
Head nets	146
Headlamps	138-139
Hearing protection	100-101
Heat packs	140
Heating	140-141
High seats	144-145
Hip flasks	219
Holster	83
Hunting horns	125
Hunting knives	110-115
Hunting license case	218
Hunting pouches	123-124
Hunting signals (CD)	125
Hunting stools	145, 147-149
Hunting tents	146
J	
Jagdnickel knives	110
K	
Kamofix	57
Key fobs	212
Knife care/accessories	116-117
Knife sharpeners	116-117
Knife pouches	118
Knives	109-118
L	
Lamps and accessories	138-139
Lansky	116
Laser boresight shot checker	13
Leads / training leashes	190-193
Lens cleaner	32
LimbSaver	43
Lurixol	163
M	
m4 oil	55
Machetes	173
Maintenance products	51-57
Meat hooks	173
Mosquito head net	142

Mosquito repellent	142
Motion detectors	165
Motorex	55
Mouflon shields	184
Mounting clamps	186
Mugs	223
Multitools	111
Muzzle guards	50

N

Napkins	223
Negele	20-21, 47
Negele mounts	20-21
Neo-Ballistol	56
Night-Vision	29-30

O

Olivon	6-9, 26-27
Optical accessories	32
Optics	5-37
Outdoor Edge	111-115

P

Pepper spray	139
Petbox	195
Pewter	229
Pistol bags	81
Pistol cases	82-84
Pistol grip caps	45
Pistol rests	105
Pluvonin	57
Pocket cutlery sets	111
Pocket heaters	140
Pocketknives	110-115
Polyver	203
Porcelain	223
Portemonnaie	218
Pruning saw	145

Q

Quick-Loc	42
Quivers	27

R

Range finders	26
Range-bags	81
Rear rack	171
Receivers for R93	47
Recoil pads and equipment	40-43
Ribcage spreader	173
Rifle scopes	6-12
Rifle slings	127-133
Robla	53
Rubber ball for bolt	45
Rubber boots	202-204
Rubber buffer	154
Rucksacks	120-123

S

Salt and pepper shaker	222
Salt paste	163
Scales	175
Schaftol	56
Schnapps sets	224-225
Scope mounts	18-25

Seat cushions	126
Seat sticks	147, 149
Self-protection	139
Sharpening kits	116
Shield Sights	18
Shields	180-185
Shoes	206
Shooting apparel	103-104
Shooting pad	103
Shooting sticks	150-151
Shooting vests	103
Sightmark	10-17
Signs	145
Skull saws	179
Skulls	188
Slingshots	104
Slippers	206
Smartphone adapter for scope eyepieces	26
Snap caps	63
Socks	205
Spikes	205
Sport shooting supplies	95-107
Spotlights	138
Spotting scopes	27
Stichfrei spray	142
Stock risers	44
Sucolin	53
Suhleingold	161
Suspenders	208-209

T

Tealight heating	141
Thermal imaging device	28-29
Thermoses	220-221
Tick lasso	196
Torches	138
Tracking leashes	193
Traditional ties	214-215
Training bucks	195
Training leashes	190-193
Transport bags	171
Traps	164
Trigger locks	105
Tripods	26
Trophy care products	178
Trophy mounting clamps	186
Trophy processing	177-188
Trophy shields	180-185
Truglo fiber-optics	33-36
Truglo laser	37
Truglo targets	102
Tuft sleeves	213

U

Urine	160
-------	-----

V

VFG	64-65
Vigilant Hunter	167
Vinegar and oil bottle set	222
Visibility clothing	206-207
Visibility vests	196
Visibility collars	197

W

Walking sticks	152-154
Walkstool	147
Wallet	218
Warning systems	165
Water container	195
Wild boar tuft	212
Wild boar tusk cover plates	187
Wildlife Observer	166
Wind direction indicator	164
Wolfhound	10
Wooden plaques	106-107
Wrapping paper	233
WYSS mounts	19



A	
Abbigliamento	201-215
Abbigliamento alta visibilità	206-207
Abbigliamento mimetico	207
Abbigliamento per tiro	103-104
Accessori per armi	36-93
Accessori per educazione di cani	195
Accessori per ottiche	32
Accessori per stivali	204-205
Accessori tiro	95-107
Adattatori	62
Addinol	51
Affilatori	116-117
Alpenstock	150
Altane	144-145
Antiaggressione	139
Apribottiglie	222
Armani figurine	234
Articoli di regalo / di abitazione	217-234
Articoli per cani	189-200
Attacchi	18-25
Attacchi Brüner	24
Attacchi Negele	20-21
Attacchi WYSS	19
AttraTec	161-162
Attrativi	160-163
Avvisatore	165
Avvisatore di macchina per selvaggina	165
B	
Babbusce	206
Ballistol	52-57
Barra di serratura	83
Bart di cinghiale	212
Basi per mufloni	184
Bastoni	152-153
Bastoni per battitori	153-154
Bastoni per tiro	150-151
Berretto	207
Bersagli in legno	106-107
Bersagli Truglo	102
Bicchieri	224-228
Bidone da acqua	195
Biglietti di auguri in tedesco	232-233
Bilancie	175
Binocoli	31
Bipede	48
Blende	105
Blocchi di esercizio per cani	195
Boccali	228
Bordoni	152-154
Borsa	218
Borse da caccia	123-124
Borse da campo tiro	81
Bottoni	212
Bretelle dei pantaloni	208-209
Bronzatura	53
Brunox	51
Busta per documenti	218
Busta per licenza di caccia	218
Buttolo	157

C	
Calcio di carbonio	46
Calcioli e accessori	40-43
Calza per armi mimetica	146
Calzature	206
Calze	205
Calze per armi	79
Campanelle da cano	200
Candeggine	178
Cannocchiali	6-12
Cappi da zecche	196
Carta da regalo	233
Cartolina di auguri natalizi	233
Cartucce a gas per riscaldamento	140
Cartucce collimatore a laser	13
Cartucciere	134-135
Catene per scarpe	205
Catrame di faggio	160
Cinghie d'armi	127-133
Cinture	215
Cocce	45
Collari	194
Collari alta visibilità per cani	197
Collari per cani	194
Collimatore	13
Coltelli	109-118
Coltelli da caccia	110-115
Coltellini	110-115
Copri volata	50
Corpetti alta visibilità per cani	196
Corpetti protettivi per cani	196
Crani	188
Crani artificiali	188
Crani in alluminio	188
Cravattini	214-215
Cuffie	100-101
Cuscini	126
Custodie per coltelli	118
Custodie per pistole	81
D	
Dazer difesa contro cani	139
Depuratore di lente	32
Deumidificatori	45
Diabolo	96-99
Difesa contro cani	139
Docter sight	16, 19
Doctor Bark	198-199
E	
Educazione di cani	195
Elevazione di fusto	44
Esbit	220-221
F	
Fari	138-139
Fari da testa	138
Fazzoletti	218
Fiaschette	219
Figurine	234
Fionde	104
Fischietti da cane	200
Flitz	57

Foderi per armi	66-80
Foglie per trofei di cinghiale	187
Foraggiamento	155-156
Fototrappole	166-167
Fuerst Pless	125
Füll-Fix	178
Funi da traino	176
G	
Ganci	172
Ghette	204
Giberne	135-137
Giberne calcio	137
Giubbotti per tiro	103
Glock attrezzo speciale	59
Greiner segnalatori di passaggio	167
Grubs	202
Guanti mimetichi	146
Guanti vinile	171
Guinzagli	190-193
Gun plugs	50
GunCer, Gunex	55
H	
H&N	96-99
Harris	48
Holster	83
I	
Imitazione di selvaggina	195
Indicatore di direzione del vento	164
K	
Kamofix	57
L	
Lampadari	230
Lampade e accessori	138-139
Lansky	116
Laser Truglo	37
Letti per cani	198-199
Levastivali	205
Libri in tedesco	231
LimbSaver	43
Lucchetti	67
Lurixol	163
M	
m4 olio	55
Macheti	173
Manutenzione di armi	51-57
Manutenzione di coltelli	116-117
Mire	27
Mirini Truglo	33-36
Motorex	55
N	
Nastri da cappello	207
Negele	20-21, 47
Neo-Ballistol	56
Nicker coltelli da caccia	110

O	
Olio per armi	51-55
Olivon	6-9, 26-27
Ottiche	5-37
Ottiche di puntamento	10-18
Outdoor Edge	111-115
P	
Palla di gomma	45
Pallini aria compressa	96-99
Pasta di sale	163
Peltro	229
Petbox	195
Pinza da osso	172
Pistole Berloque	107
Pluvonin	57
Polyver	203
Porcellana	223
Porta bart	213
Porta munizioni	93
Porta selvaggina	170
Portabinocoli	32
Portacannocchiali	27
Portachiavi	212
Portafoglio	218
Posateria	111
Preparazione di trofei	177-188
Prodotti di bollitura	178
Prodotti di manutenzione per trofei	178
Prodotti di pulitura	58-65
Protezione anti-moschini	142
Pulizia armi	51-65
Q	
Quick-Loc	42
R	
Raccoglitori per pallini aria compressa	102
Rete da testa anti-moschini	142
Rete da testa mimetiche	146
Reti	146
Reti antimosquiti	171
Richiami	156-160
Rilevatore di movimento	165
Riscaldamenti	140-141
Riscaldamenti mani	140
Riscaldamento di candeline	141
Riscaldamento per appostamento	140
Robla	53
S	
Sacchi di trasporto	171
Sacchi per stivali	204
Sacchi termici	140
Saliera e spargipepe	222
Salvadito per fucili	45
Salvapercussori	63
Salviettine	223
Schaftol	56
Scudetti per trofei	180-185
Sega da osso	173

Sega di branche	145
Seggiolini	147, 149
Seghe	172
Seghe per crani	179
Segnali di caccia (CD)	125
Segnali di indicazione	145
Serrature	105
Set aceto e olio	222
Set acquavite	224-225
Set affilatori	116
Set da scomporre	174
Sgabelli	
	145, 147-149
Shield Sights	18
Sightmark	10-17
Sisteme per R93	47
Spallina	103
Spargifodera	155
Spille	210-213
Spray al pepe	139
Spray anti-moschini	142
Spray di difesa	139
Stivali di gomma	202-204
Strumenti di bollitura	178
Sucolin	53
Suhlgold	161
Supporti per trofei	186
Supporto di fucili di pulitura	59
Supporto per fucili	49
Supporto per pistole	105
Supporto per smartphone	26
Supporto posteriore	171
T	
Tamburo spargifodera	156
Tamponi di gomma	154
Tappi decorativi	222
Tazze	223
Telemetro	26
Tende mimetiche	146
Termocamera	28-29
Tesoro in scatola	52
Thermos	220-221
Torce	138
Trappole	164
Treppiedi	26
Trombe	125
U	
Urina	160
Utensile da allargare	173
Utensile da estrarre	172
Utensile multiuso	111
Utensili scuoio	172
V	
Valigetta per archi	92
Valigette per armi	82-92
Valigette per cartucce	93
Valigette per fucili	82-92
Valigette per pistole	82-84
VFG	64-65
Vigilant Hunter	167
Visori notturni	29-30

W	
Walkstool	147
Wildlife Observer	166
Wildschreck	163
Wolfhound	10
Z	
Zaini	120-123
Zaino sgabello	123
Zimbelli	168



Service numbers and office hours



Photo credits

Pages 1 and 240:

#254160320 - Roe deer, capreolus capreolus, buck walking on blooming meadow in summer at sunset. Wildlife scenery with vivid colors from nature. Roebuck in the wild with copy space © WildMedia

Pages 2 - 3:

#108699920 - Panorama von Wald mit Sonne im Frühling © Smileus

Page 5:

#120569232 - Man hunter with shotgun looking through binoculars in forest © zorandim75

Page 39:

#73915541 - hunter with dog at sunset © adrenalinapura

Page 95:

#60169079 - Zielscheibe © thombach

Page 109:

#52354934 - Hunting knife stuck into stump © natusenchik

Page 119:

#29323298 - Jäger mit Jagdhund © Wissmann Design

Page 143:

#231628602 - jägerstand herbst © Christine

Page 169:

#125904292 - Jäger mit erlegtem Reh © Lunghammer

Page 177:

#73100915 - Kapitales Hirschgeweih auf der Alm © by-studio

Page 189:

#87308351 - Neugier © Nordreisender

Page 201:

#126832380 - Male hunter forest © scharfsinn86

Page 217:

#75546519 - cerf © shocky



Sales contact

Stefanie Janson, Silvia Ohse,

Sales manager: Markus Brandmeier

Phone: +49 (0) 95 71 - 60 81

E-mail: info@fritzmänn.org



Accounting

Andrea Janson

Phone: +49 (0) 95 71 - 75 53 38 - 23



Office hours

Mon – Thu 7:30 am - noon and 1 pm - 5 pm

Fri 7:30 am - 12:15 pm

www.fritzmänn.org



Your wholesaler for hunting and shooting equipment and outdoor supplies



Bamberger Straße 80 • 96215 Lichtenfels, Germany
PO Box 1209 • 96202 Lichtenfels, Germany

Phone: +49 (0) 95 71 - 60 81 • Fax: +49 (0) 95 71 - 7 11 31
E-Mail: info@fritzmann.org • www.fritzmann.org