

NST489AMT1G, NSVT489AMT1G

High Current Surface Mount NPN Silicon Low $V_{CE(sat)}$ Switching Transistor for Load Management in Portable Applications

Features

- NSV Prefix for Automotive and Other Applications Requiring Unique Site and Control Change Requirements; AEC-Q101 Qualified and PPAP Capable
- These Devices are Pb-Free, Halogen Free/BFR Free and are RoHS Compliant

MAXIMUM RATINGS ($T_A = 25^\circ\text{C}$)

Rating	Symbol	Max	Unit
Collector-Emitter Voltage	V_{CEO}	30	V
Collector-Base Voltage	V_{CBO}	50	V
Emitter-Base Voltage	V_{EBO}	5.0	V
Collector Current – Continuous	I_C	2.0	A
Collector Current – Peak	I_{CM}	3.0	A

THERMAL CHARACTERISTICS

Characteristic	Symbol	Max	Unit
Total Device Dissipation $T_A = 25^\circ\text{C}$ Derate above 25°C	P_D (Note 1)	535 4.3	mW mW/ $^\circ\text{C}$
Thermal Resistance, Junction-to-Ambient	$R_{\theta JA}$ (Note 1)	234	$^\circ\text{C}/\text{W}$
Total Device Dissipation $T_A = 25^\circ\text{C}$ Derate above 25°C	P_D (Note 2)	1.180 9.4	W mW/ $^\circ\text{C}$
Thermal Resistance, Junction-to-Ambient	$R_{\theta JA}$ (Note 2)	106	$^\circ\text{C}/\text{W}$
Thermal Resistance, Junction-to-Lead #1	$R_{\theta JL}$ (Note 1) $R_{\theta JL}$ (Note 2)	110 50	$^\circ\text{C}/\text{W}$ $^\circ\text{C}/\text{W}$
Total Device Dissipation (Single Pulse < 10 s)	$P_{D\text{single}}$ (Notes 2 and 3)	1.75	W
Junction and Storage Temperature Range	T_J, T_{stg}	-55 to +150	$^\circ\text{C}$

Stresses exceeding those listed in the Maximum Ratings table may damage the device. If any of these limits are exceeded, device functionality should not be assumed, damage may occur and reliability may be affected.

1. FR-4 with 1 oz and 3.9 mm^2 of copper area.
2. FR-4 with 1 oz and 645 mm^2 of copper area.
3. Refer to Figure 8.



ON Semiconductor®

www.onsemi.com

30 VOLTS, 3.0 AMPS
NPN TRANSISTOR



TSOP-6
CASE 318G
STYLE 6

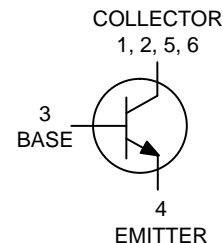

DEVICE MARKING

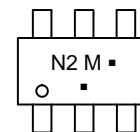

N2 = Specific Device Code
M = Date Code*
▪ = Pb-Free Package

(Note: Microdot may be in either location)

*Date Code orientation may vary depending upon manufacturing location.

ORDERING INFORMATION

Device	Package	Shipping†
NST489AMT1G	TSOP-6 (Pb-Free)	3,000 / Tape & Reel
NSVT489AMT1G	TSOP-6 (Pb-Free)	3,000 / Tape & Reel

†For information on tape and reel specifications, including part orientation and tape sizes, please refer to our Tape and Reel Packaging Specifications Brochure, BRD8011/D.

NST489AMT1G, NSVT489AMT1G

ELECTRICAL CHARACTERISTICS (T_A = 25°C unless otherwise noted)

Characteristic	Symbol	Min	Typ	Max	Unit	
OFF CHARACTERISTICS						
Collector–Emitter Breakdown Voltage (I _C = 10 mA, I _B = 0)	V _{(BR)CEO}	30	–	–	V	
Collector–Base Breakdown Voltage (I _C = 0.1 mA, I _E = 0)	V _{(BR)CBO}	50	–	–	V	
Emitter–Base Breakdown Voltage (I _E = 0.1 mA, I _C = 0)	V _{(BR)EBO}	5.0	–	–	V	
Collector Cutoff Current (V _{CB} = 30 V, I _E = 0)	I _{CBO}	–	–	0.1	μA	
Collector–Emitter Cutoff Current (V _{CE} = 30 V)	I _{CES}	–	–	0.1	μA	
Emitter Cutoff Current (V _{EB} = 4.0 V)	I _{EBO}	–	–	0.1	μA	
ON CHARACTERISTICS						
DC Current Gain (Note 4)	(I _C = 1.0 mA, V _{CE} = 5.0 V) (I _C = 0.5 A, V _{CE} = 5.0 V) (I _C = 1.0 A, V _{CE} = 5.0 V)	h _{FE}	300 300 200	– 500 –	– 900 –	
Collector–Emitter Saturation Voltage (Note 4)	(I _C = 1.0 A, I _B = 100 mA) (I _C = 0.5 A, I _B = 50 mA) (I _C = 0.1 A, I _B = 1.0 mA)	V _{CE(sat)}	– – –	0.10 0.06 0.05	0.200 0.125 0.075	V
Base–Emitter Saturation Voltage (Note 4) (I _C = 1.0 A, I _B = 0.1 A)		V _{BE(sat)}	–	–	1.1	V
Base–Emitter Turn-on Voltage (Note 4) (I _C = 1.0 A, V _{CE} = 2.0 V)		V _{BE(on)}	–	–	1.1	V
Cutoff Frequency (I _C = 100 mA, V _{CE} = 5.0 V, f = 100 MHz)		f _T	200	300	–	MHz
Output Capacitance (f = 1.0 MHz)		C _{obo}	–	–	15	pF

4. Pulsed Condition: Pulse Width ≤ 300 μsec, Duty Cycle ≤ 2%.

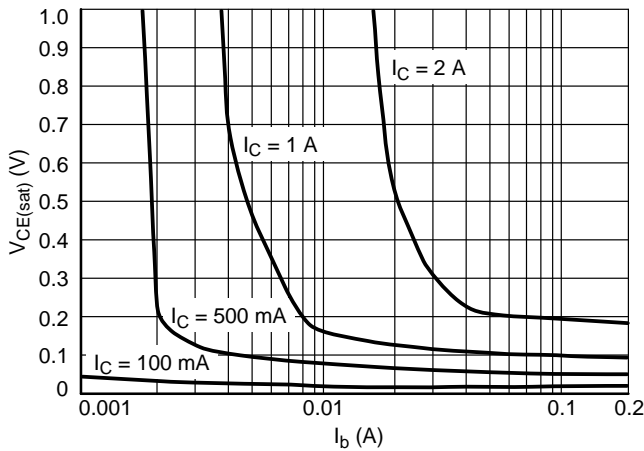

Figure 1. V_{CE(sat)} versus I_b

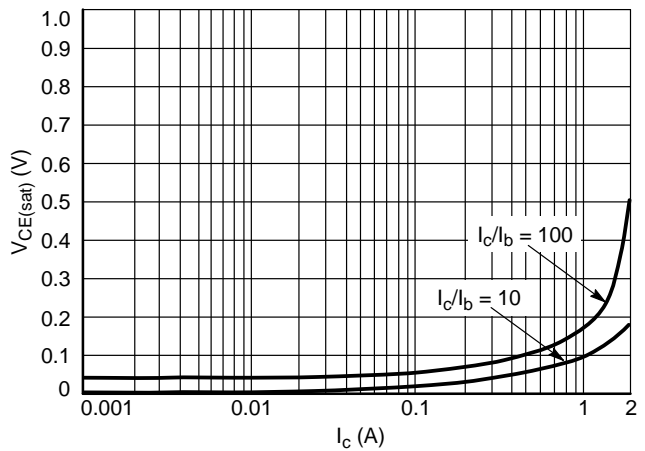

Figure 2. V_{CE(sat)} versus I_c

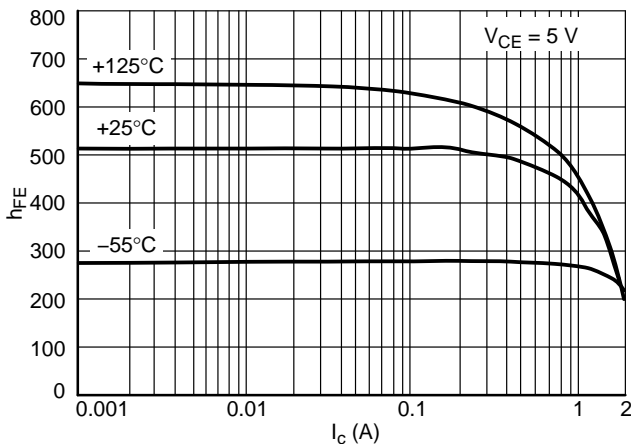

Figure 3. h_{FE} versus I_c

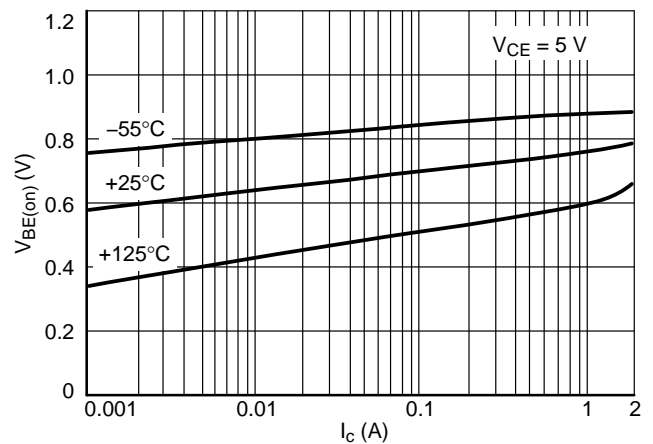

Figure 4. V_{BE(on)} versus I_c

NST489AMT1G, NSVT489AMT1G

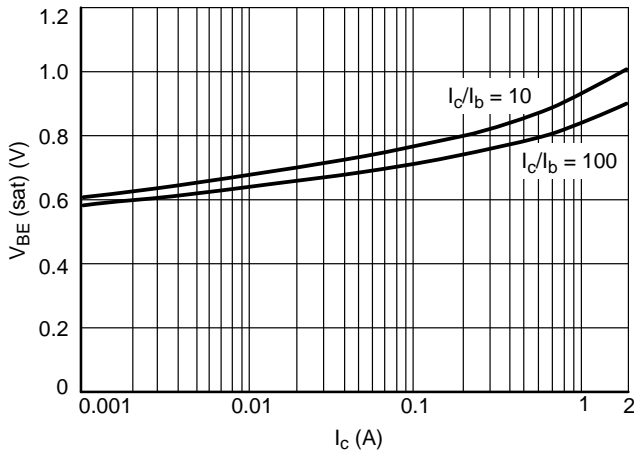

Figure 5. $V_{BE(sat)}$ versus I_C

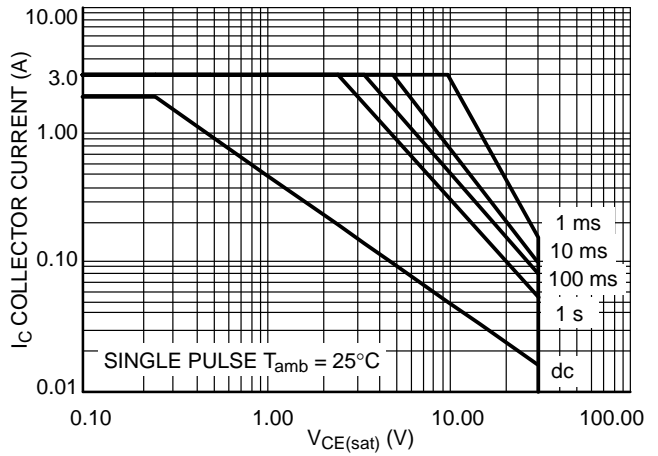

Figure 6. Safe Operating Area

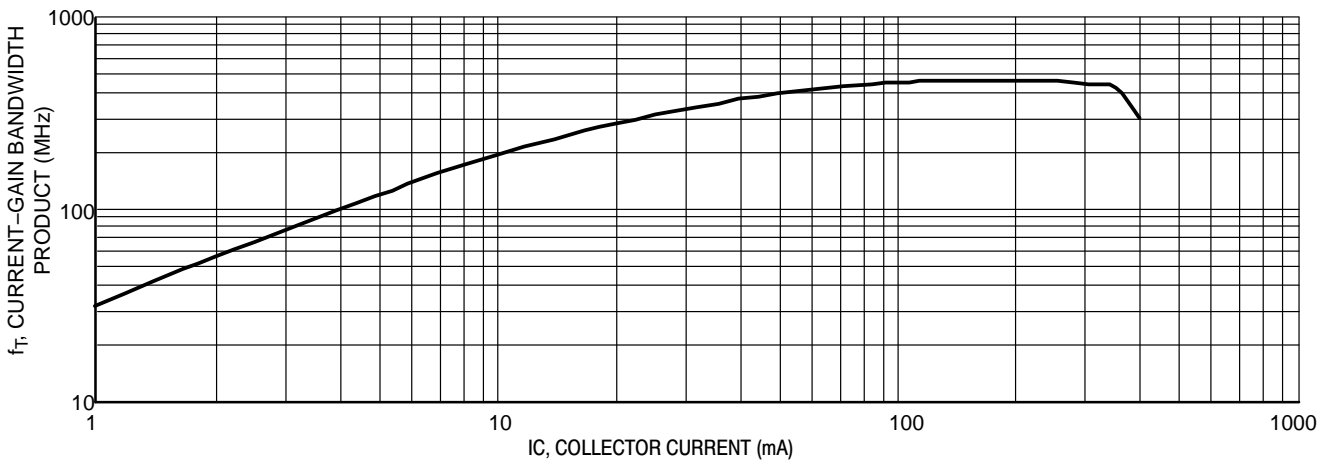

Figure 7. f_T (MHz) versus I_C (mA) $V_{CE} = 5.0$ V

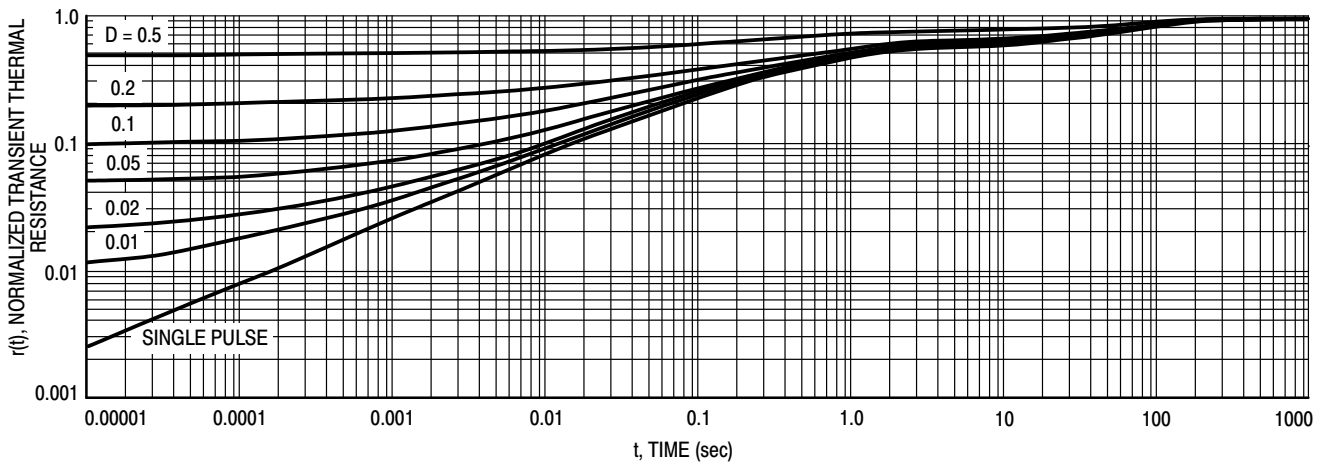
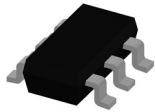

Figure 8. Normalized Thermal Response

MECHANICAL CASE OUTLINE

PACKAGE DIMENSIONS



TSOP-6 3.00x1.50x0.90, 0.95P
CASE 318G
ISSUE W

DATE 26 FEB 2024

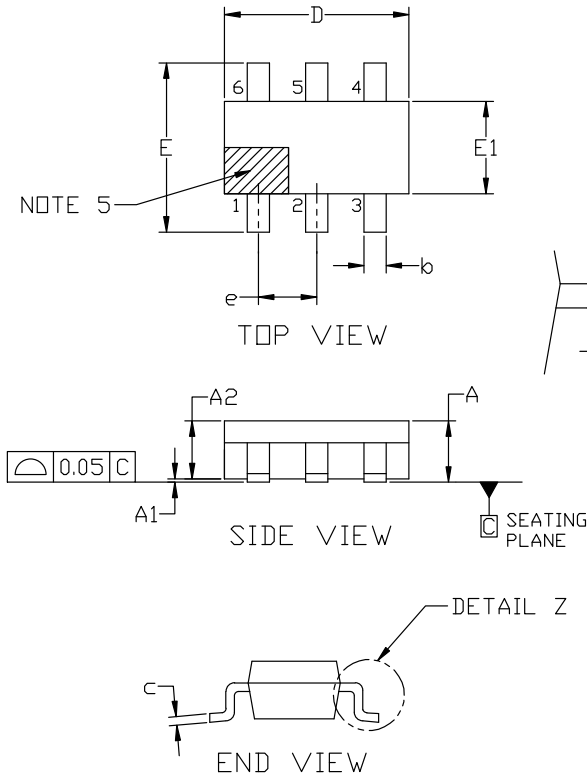

NOTES:

1. DIMENSIONING AND TOLERANCING PER ASME Y14.5M, 2018.
2. CONTROLLING DIMENSION: MILLIMETERS.
3. MAXIMUM LEAD THICKNESS INCLUDES LEAD FINISH. MINIMUM LEAD THICKNESS IS THE MINIMUM THICKNESS OF BASE MATERIAL.
4. DIMENSIONS D AND E1 DO NOT INCLUDE MOLD FLASH, PROTRUSIONS, OR GATE BURRS. MOLD FLASH, PROTRUSIONS, OR GATE BURRS SHALL NOT EXCEED 0.15 PER SIDE. DIMENSIONS D AND E1 ARE DETERMINED AT DATUM H.
5. PIN 1 INDICATOR MUST BE LOCATED IN THE INDICATED ZONE

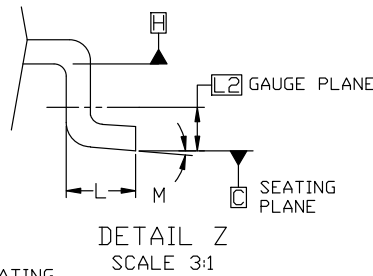

MILLIMETERS			
DIM	MIN	NOM	MAX
A	0.90	1.00	1.10
A1	0.01	0.06	0.10
A2	0.80	0.90	1.00
b	0.25	0.38	0.50
c	0.10	0.18	0.26
D	2.90	3.00	3.10
E	2.50	2.75	3.00
E1	1.30	1.50	1.70
e	0.85	0.95	1.05
L	0.20	0.40	0.60
L2	0.25 BSC		
M	0°	---	10°

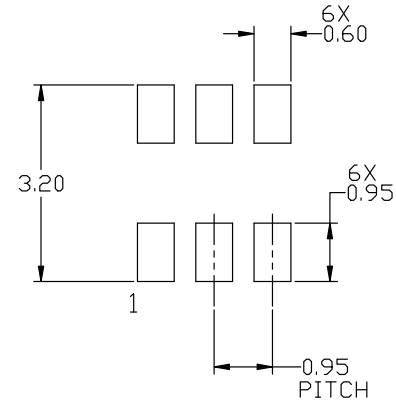

RECOMMENDED MOUNTING FOOTPRINT

*For additional information on our Pb-Free strategy and soldering details, please download the ON Semiconductor Soldering and Mounting Techniques Reference manual, SOLDERRM/D.

DOCUMENT NUMBER:	98ASB14888C	Electronic versions are uncontrolled except when accessed directly from the Document Repository. Printed versions are uncontrolled except when stamped "CONTROLLED COPY" in red.
DESCRIPTION:	TSOP-6 3.00x1.50x0.90, 0.95P	PAGE 1 OF 2

onsemi and ONSEMI are trademarks of Semiconductor Components Industries, LLC dba onsemi or its subsidiaries in the United States and/or other countries. onsemi reserves the right to make changes without further notice to any products herein. onsemi makes no warranty, representation or guarantee regarding the suitability of its products for any particular purpose, nor does onsemi assume any liability arising out of the application or use of any product or circuit, and specifically disclaims any and all liability, including without limitation special, consequential or incidental damages. onsemi does not convey any license under its patent rights nor the rights of others.

MECHANICAL CASE OUTLINE

PACKAGE DIMENSIONS



TSOP-6 3.00x1.50x0.90, 0.95P
CASE 318G
ISSUE W

DATE 26 FEB 2024

GENERIC MARKING DIAGRAM*

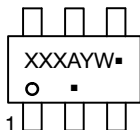

IC

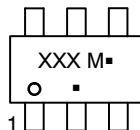

STANDARD

XXX = Specific Device Code
A = Assembly Location
Y = Year
W = Work Week
▪ = Pb-Free Package

XXX = Specific Device Code
M = Date Code
▪ = Pb-Free Package

*This information is generic. Please refer to device data sheet for actual part marking. Pb-Free indicator, "G" or microdot "▪", may or may not be present. Some products may not follow the Generic Marking.

STYLE 1:

- PIN 1. DRAIN
- 2. DRAIN
- 3. GATE
- 4. SOURCE
- 5. DRAIN
- 6. DRAIN

STYLE 2:

- PIN 1. EMITTER 2
- 2. BASE 1
- 3. COLLECTOR 1
- 4. EMITTER 1
- 5. BASE 2
- 6. COLLECTOR 2

STYLE 3:

- PIN 1. ENABLE
- 2. N/C
- 3. R BOOST
- 4. Vz
- 5. V in
- 6. V out

STYLE 4:

- PIN 1. N/C
- 2. V in
- 3. NOT USED
- 4. GROUND
- 5. ENABLE
- 6. LOAD

STYLE 5:

- PIN 1. EMITTER 2
- 2. BASE 2
- 3. COLLECTOR 1
- 4. EMITTER 1
- 5. BASE 1
- 6. COLLECTOR 2

STYLE 6:

- PIN 1. COLLECTOR
- 2. COLLECTOR
- 3. BASE
- 4. EMITTER
- 5. COLLECTOR
- 6. COLLECTOR

STYLE 7:

- PIN 1. COLLECTOR
- 2. COLLECTOR
- 3. BASE
- 4. N/C
- 5. COLLECTOR
- 6. EMITTER

STYLE 8:

- PIN 1. Vbus
- 2. D(in)
- 3. D(in)+
- 4. D(out)+
- 5. D(out)
- 6. GND

STYLE 9:

- PIN 1. LOW VOLTAGE GATE
- 2. DRAIN
- 3. SOURCE
- 4. DRAIN
- 5. DRAIN
- 6. HIGH VOLTAGE GATE

STYLE 10:

- PIN 1. D(OUT)+
- 2. GND
- 3. D(OUT)-
- 4. D(IN)-
- 5. VBUS
- 6. D(IN)+

STYLE 11:

- PIN 1. SOURCE 1
- 2. DRAIN 2
- 3. DRAIN 2
- 4. SOURCE 2
- 5. GATE 1
- 6. DRAIN 1/GATE 2

STYLE 12:

- PIN 1. I/O
- 2. GROUND
- 3. I/O
- 4. I/O
- 5. VCC
- 6. I/O

STYLE 13:

- PIN 1. GATE 1
- 2. SOURCE 2
- 3. GATE 2
- 4. DRAIN 2
- 5. SOURCE 1
- 6. DRAIN 1

STYLE 14:

- PIN 1. ANODE
- 2. SOURCE
- 3. GATE
- 4. CATHODE/DRAIN
- 5. CATHODE/DRAIN
- 6. CATHODE/DRAIN

STYLE 15:

- PIN 1. ANODE
- 2. SOURCE
- 3. GATE
- 4. DRAIN
- 5. N/C
- 6. CATHODE

STYLE 16:

- PIN 1. ANODE/CATHODE
- 2. BASE
- 3. EMITTER
- 4. COLLECTOR
- 5. ANODE
- 6. CATHODE

STYLE 17:

- PIN 1. EMITTER
- 2. BASE
- 3. ANODE/CATHODE
- 4. ANODE
- 5. CATHODE
- 6. COLLECTOR

DOCUMENT NUMBER:	98ASB14888C	Electronic versions are uncontrolled except when accessed directly from the Document Repository. Printed versions are uncontrolled except when stamped "CONTROLLED COPY" in red.
DESCRIPTION:	TSOP-6 3.00x1.50x0.90, 0.95P	PAGE 2 OF 2

onsemi and onsemi are trademarks of Semiconductor Components Industries, LLC dba onsemi or its subsidiaries in the United States and/or other countries. onsemi reserves the right to make changes without further notice to any products herein. onsemi makes no warranty, representation or guarantee regarding the suitability of its products for any particular purpose, nor does onsemi assume any liability arising out of the application or use of any product or circuit, and specifically disclaims any and all liability, including without limitation special, consequential or incidental damages. onsemi does not convey any license under its patent rights nor the rights of others.

onsemi, **Onsemi**, and other names, marks, and brands are registered and/or common law trademarks of Semiconductor Components Industries, LLC dba "**onsemi**" or its affiliates and/or subsidiaries in the United States and/or other countries. **onsemi** owns the rights to a number of patents, trademarks, copyrights, trade secrets, and other intellectual property. A listing of **onsemi**'s product/patent coverage may be accessed at www.onsemi.com/site/pdf/Patent-Marking.pdf. **onsemi** reserves the right to make changes at any time to any products or information herein, without notice. The information herein is provided "as-is" and **onsemi** makes no warranty, representation or guarantee regarding the accuracy of the information, product features, availability, functionality, or suitability of its products for any particular purpose, nor does **onsemi** assume any liability arising out of the application or use of any product or circuit, and specifically disclaims any and all liability, including without limitation special, consequential or incidental damages. Buyer is responsible for its products and applications using **onsemi** products, including compliance with all laws, regulations and safety requirements or standards, regardless of any support or applications information provided by **onsemi**. "Typical" parameters which may be provided in **onsemi** data sheets and/or specifications can and do vary in different applications and actual performance may vary over time. All operating parameters, including "Typicals" must be validated for each customer application by customer's technical experts. **onsemi** does not convey any license under any of its intellectual property rights nor the rights of others. **onsemi** products are not designed, intended, or authorized for use as a critical component in life support systems or any FDA Class 3 medical devices or medical devices with a same or similar classification in a foreign jurisdiction or any devices intended for implantation in the human body. Should Buyer purchase or use **onsemi** products for any such unintended or unauthorized application, Buyer shall indemnify and hold **onsemi** and its officers, employees, subsidiaries, affiliates, and distributors harmless against all claims, costs, damages, and expenses, and reasonable attorney fees arising out of, directly or indirectly, any claim of personal injury or death associated with such unintended or unauthorized use, even if such claim alleges that **onsemi** was negligent regarding the design or manufacture of the part. **onsemi** is an Equal Opportunity/Affirmative Action Employer. This literature is subject to all applicable copyright laws and is not for resale in any manner.

ADDITIONAL INFORMATION

TECHNICAL PUBLICATIONS:

Technical Library: www.onsemi.com/design/resources/technical-documentation
onsemi Website: www.onsemi.com

ONLINE SUPPORT: www.onsemi.com/support

For additional information, please contact your local Sales Representative at www.onsemi.com/support/sales

