

EDDYSTONE

V.H.F. COMMUNICATIONS RECEIVER

MODEL 770R MARK II



Tuning range 19 to 165 Megacycles

The Eddystone "770R" Mark II receiver accepts various modes of signal and is designed to meet specialised requirements in the VHF spectrum. It has many applications in the communications and allied fields, and is invaluable as an instrument for research and development work, interference investigations, and experimental projects.

The tuner unit incorporates a substantial diecast rotating coil-turret and a split-stator gang capacitor, both of original design, which enables an excellent performance to be obtained on all ranges. In all, twenty valves are used, and a number of semi-conductors. The styling is modern, with a two-tone grey finish.

The receiver lends itself to the panoramic display of received signals by the addition of the "EP17R" Panoramic Display Unit, which matches the "770R" physically and electrically.

Rack mounting and table versions are available.

Eddystone 770R Mark II Receiver

SPECIFICATION

Frequency Coverage

The individual ranges excluding overlaps are as follows:

Range 1	114 Mc/s. to 165 Mc/s.
Range 2	78 Mc/s. to 114 Mc/s.
Range 3	54 Mc/s. to 78 Mc/s.
Range 4	39 Mc/s. to 54 Mc/s.
Range 5	27 Mc/s. to 39 Mc/s.
Range 6	19 Mc/s. to 27 Mc/s.

Valve Sequence

The twenty valves are of the following types and perform the functions indicated:

V1	EF95	(CV850)	Pentode RF Amplifier.
V2	EF95	(CV850)	Mixer.
V3	EF95	(CV850)	Oscillator.
V4	6BA6	(CV454)	IF Amplifier AM/FM.
V5	6BA6	(CV454)	IF Amplifier AM/FM.
V6	6BA6	(CV454)	IF Amplifier AM/FM.
V7	6BA6	(CV454)	IF Amplifier AM/FM.
V8	6AU6	(CV2524)	Limiter FM only.
V9	6AL5	(CV140)	FM Discriminator.
V10	6AL5	(CV140)	Noise Limiter & AGC.
V11	6AU6	(CV2524)	"S" Meter on AM. Tuning Indicator on FM.
V12	6BA6	(CV454)	Beat Freq. Oscillator.
V13	6AU6	(CV2524)	Noise Amplifier (Muting).
V14	12AU7	(CV491)	Muting Control.
V15	12AU7	(CV491)	Audio Amplifier.
V16	6AM5	(CV136)	Push-pull Output.
& 17			
V18	VR150/30	(CV216)	Voltage Stabiliser.
V19	5Z4G	(CV1863)	Full Wave Rectifier.
V20	EF91	(CV138)	Crystal Calibrator.

The demodulator for AM signals is a germanium diode. Another diode is used as a noise rectifier in the muting circuit.

Tuning Mechanism and Scales

The tuning mechanism is gear-driven and made to precision limits, to ensure high re-setting accuracy and absence of backlash. The reduction ratio is approximately 140 to 1. The long straight scales are easily read and are directly calibrated in frequency. The cursor is adjustable, to enable correction to be made against the internal crystal calibrator, so providing a high degree of tuning accuracy. In the top centre of the dial is the

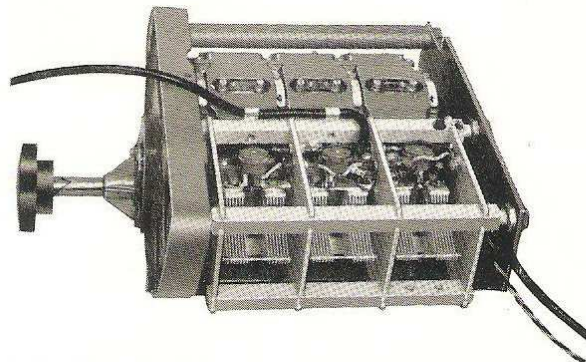

Tuning "heart" of the 770R receiver showing ganged capacitors, valve holders and, at the rear, part of the coil turret.

vernier bandsread device, which gives a further reduction and, in effect, opens out the length of each scale to the equivalent of 34 feet.

Signal and Oscillator Sections

The tuning inductances are housed in a specially designed turret, built up with substantial castings, and provided with contacts of a reliable type. The tuning capacitor is a three-section split-stator type, again of special design. It is sturdily constructed and the sections are closely matched to ensure accurate alignment.

The nominal input impedance is 75 ohms (unbalanced), a coaxial socket being provided for the connection of the feeder cable. A trimmer control on the front panel permits correction being made for variations in aerial and feeder reactance.

Intermediate Frequency Stages

Four stages are used plus a limiter on frequency modulated signals. The transformers are permeability tuned to 5.2 Mc/s., are well screened and designed for high stability. The BFO unit is pre-set to give a beat of 1,000 cycles.

Audio Stages

The push-pull output stage delivers a maximum of three watts to the 2.5 ohm speaker terminals. A 600 ohm balanced output is available for feeding the signal to line. The amplification of the audio stages is linear over a wide frequency range, as necessary for high quality reproduction. The jack on the front panel takes high resistance telephone headset. Audio input terminals are fitted.

Eddystone 770R Mark II Receiver

Deviation

The discriminator is designed for a deviation of 15 kc/s. in the narrow position, and 75 kc/s. in the wide position.

Muting

The muting circuit is controlled by a switch on the front panel. It is arranged to operate on signals of a strength exceeding 5 microvolts. A level control is fitted at the rear.

Crystal Calibrator

A crystal calibrator is fitted internally and gives marker points at intervals of 5 Mc/s.

IF Output

A coaxial socket at the rear provides a low impedance output at the IF of 5.2 Mc/s., to enable direct use to be made of the "EP17R" Panoramic Display Unit.

Other Features

At the top of the dial is the "S" meter, which indicates carrier level on amplitude modulation and which is used as a tuning indicator on frequency modulation. The noise limiter is effective (on AM) against ignition and similar interference. Fuses are fitted in the power supply circuits. The standby switch can be used also for controlling an external circuit.

Electrical Performance

Sensitivity for 50 milliwatts output and 15 db signal-to-noise ratio is better than 5 microvolts, on all ranges.

Selectivity

AM and CW 40 db down, 50 kc/s. off resonance.
Narrow band
FM ... 40 db down, 80 kc/s. off resonance.
Wide band
FM ... 40 db down, 175 kc/s. off resonance.

Noise Factor (in decibels)

Range 1 not greater than 14; Range 2 not greater than 10; Range 3 not greater than 8.

Ranges 4, 5 and 6 not greater than 6.

Image Ratio

Better than 20 db at 165 Mc/s. and correspondingly greater at lower frequencies.

Frequency Stability

Drift is less than .003% per degree Centigrade at all frequencies, and less than .003% for a 5% change in mains voltage.

A.G.C.

The audio level does not change by more than 12 db when input is varied 70 db above 5 microvolts.

Power Supplies

The mains transformer has a selection panel permitting operation from 110 volt or 200/230, 40/60 cycle supplies. Total consumption is 90 volt-amperes. The smoothing filter reduces hum to a negligible level. The RF oscillator, mixer and BFO stages are supplied with stabilised high tension voltage.

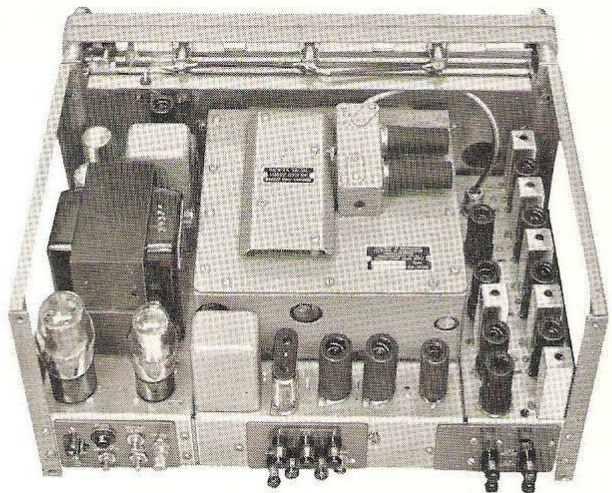

Rear view of the 770R receiver, illustrating the clean engineering lines and robust construction.

Construction

The front panel and coil turret are diecastings, whilst the other units are built on stout sub-chassis, the whole receiver being strongly constructed. All components are of high quality tropical types and workmanship throughout is of the finest. All steel parts, including the cabinet, are fully rust-proofed. The cover can be drawn away from the chassis by the removal of four screws, to permit easy access to the interior. Chromium plated handles are fitted to the front panel and steel side plates inside. Adequate ventilation is provided.

Physical Details

Weight 60½ lbs. (27.4 kg). Width 16¾ inches (42.5 cm) : depth 15 inches (36 cm) : height 8¾ inches (22.2 cm). Available as table model (illustrated) or for standard 19 inch rack mounting.

Eddystone 770R Mark II Receiver

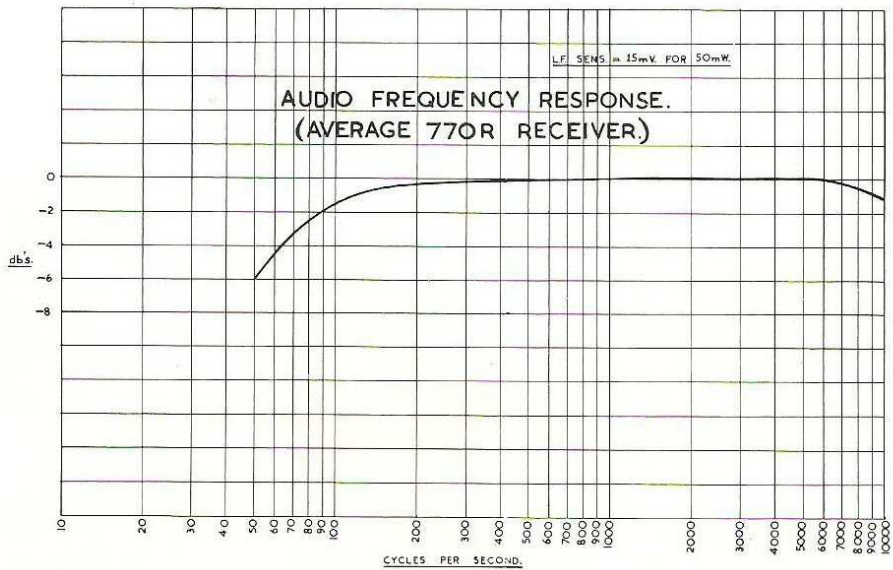
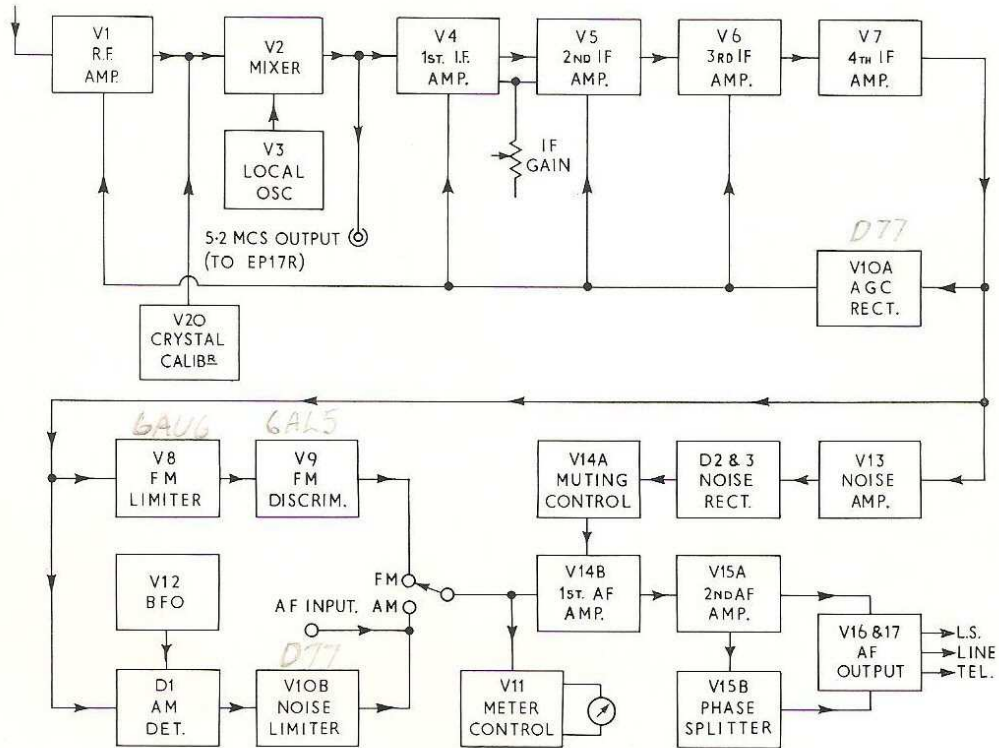

S77OR SELECTIVITY I.F. AND DISCRIMINATOR.

(TYPICAL CURVES)

- C.W. & AM.
- - - 15Kc/s. N.F.M.
- 75Kc/s. F.M.
- - - DISCRIMINATOR

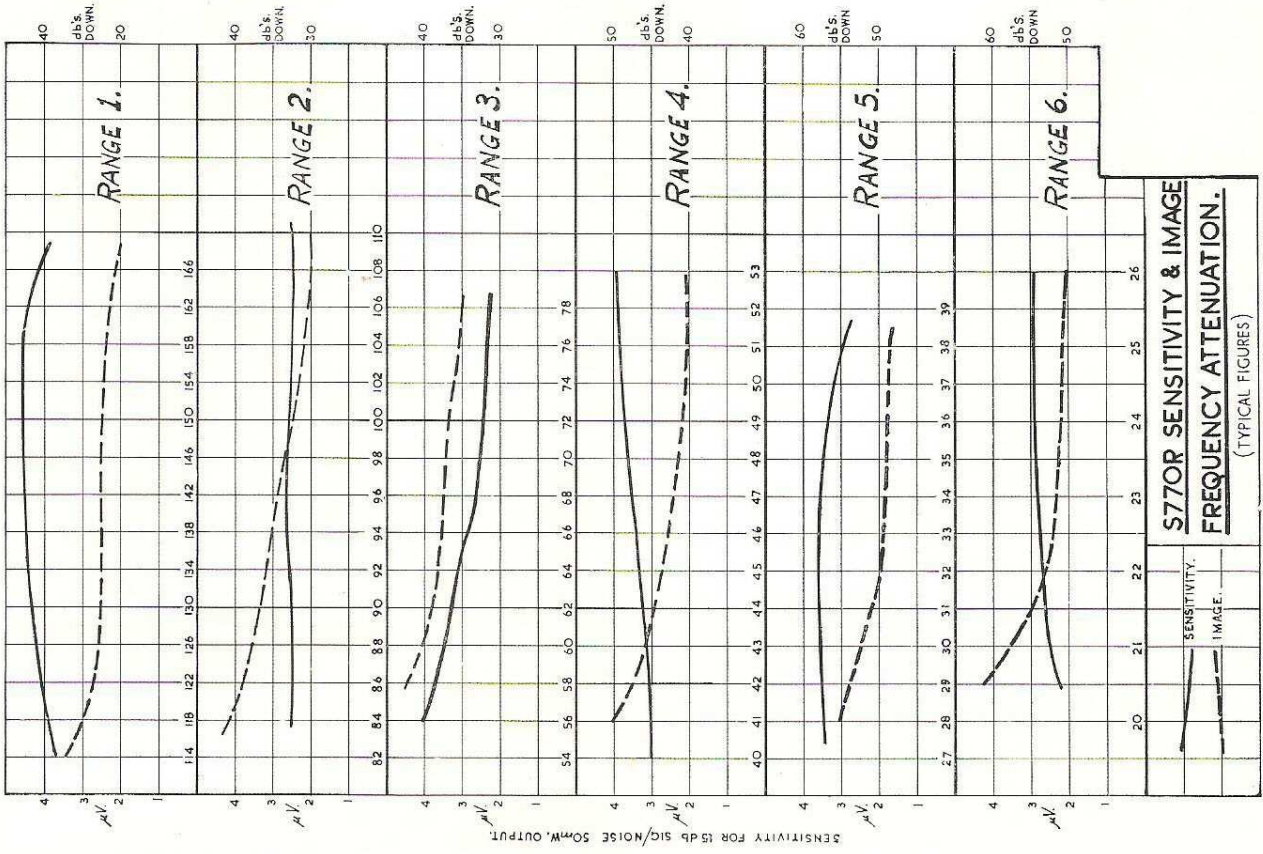
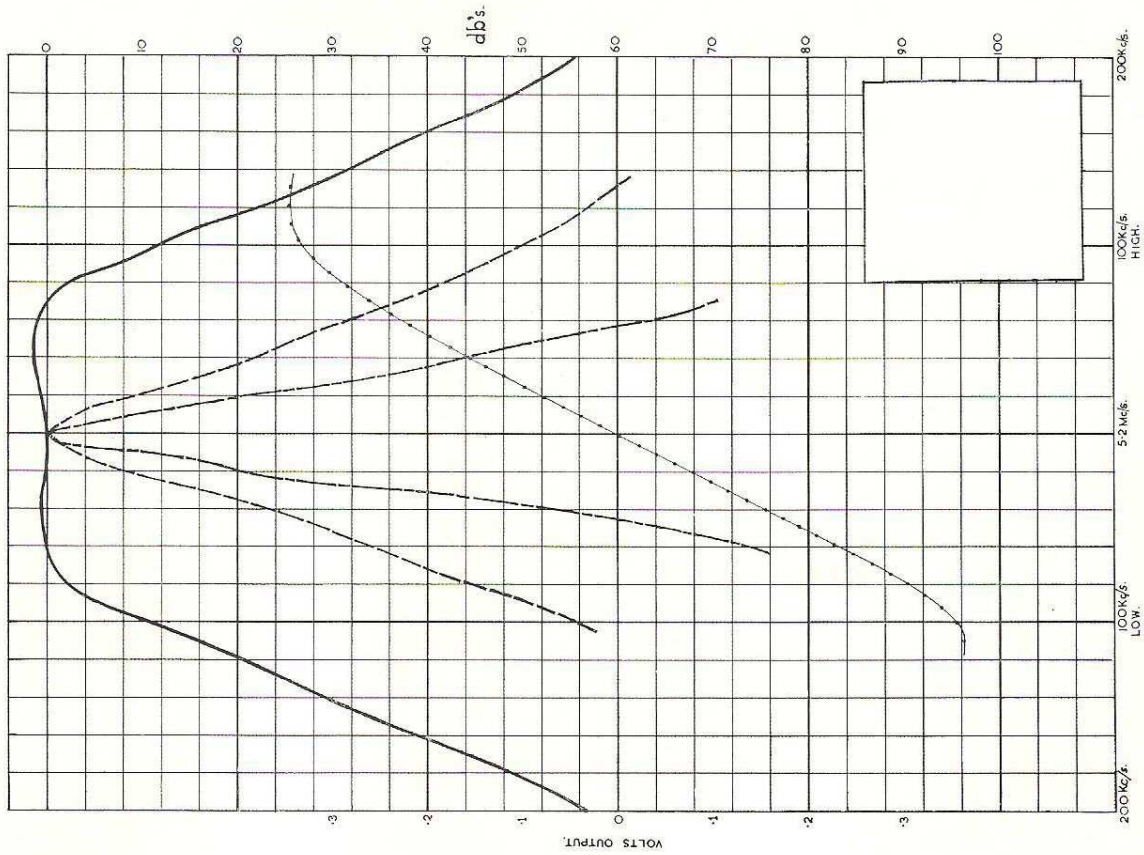

S77OR SENSITIVITY & IMAGE FREQUENCY ATTENUATION.
(TYPICAL FIGURES)

Typical selectivity and discriminator curves for average 770R receiver.

Manufacturers :

STRATTON & CO. LTD.
BIRMINGHAM 31 :: ENGLAND

Telephone : PRIORY 2231/4

Cables : STRATNOID, BIRMINGHAM

Telex : 33708

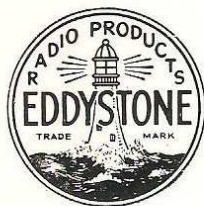

Printed in England

Issued March 1964



DEPARTMENT OF COMMUNICATIONS

RADIO FREQUENCY MANAGEMENT DIVISION
REGULATORY AND LICENSING SECTION

1st Floor, 256 Adelaide Terrace, Perth 6000
P.O. Box 6189, Perth, Hay Street East, 6000
Telephone 325 5877 Telex 93772

With the Compliments of
The State Manager