



Multi Series

Inverter Multi-Split System Air Conditioners

Multi Series

Inverter Multi-Split System Air Conditioners.



The ideal solution for air conditioning multiple rooms



A home typically has many areas such as bedrooms, living spaces and study rooms. Therefore, to provide total comfort for your home, a multi-split system is recommended so each room can have its own air conditioner.

This can be achieved through a Mitsubishi Heavy Industries inverter multi-split system which delivers optimum heating or cooling for everyone, no matter where they are in the home and no matter what size the room may be. Silent, powerful, energy efficient and utilising advanced technologies, a Mitsubishi Heavy Industries inverter multi-split system is the solution for homes with many rooms and occupants.



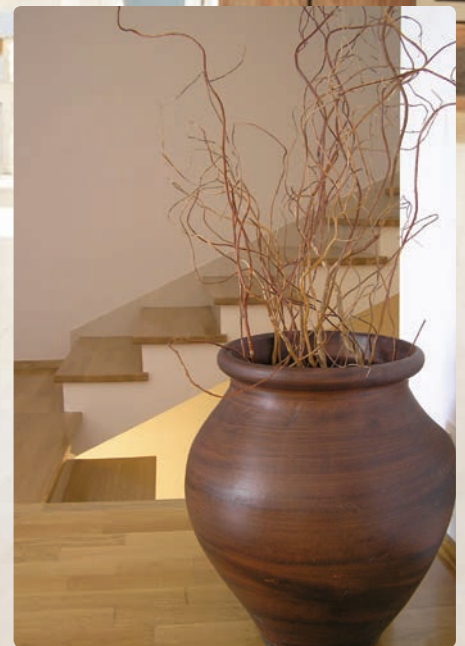

Compact

A Mitsubishi Heavy Industries inverter multi-split system allows 2 to 6 indoor units to be connected to a single outdoor unit. This allows multiple rooms to be conditioned without adding clutter to the exterior of your home. One compact multi-split outdoor unit instead of many outdoor units not only adds to the aesthetic appeal of your home but can be imperative when there is not much space available, for example, when installing outdoor units on balconies or verandahs.

Installation Flexibility

With a generous maximum piping length of 70m*, you are given greater freedom to decide where the indoor units will be installed to optimise interior space and convenience. In addition, a maximum height difference of 25m* for the indoor units means the Mitsubishi Heavy Industries inverter multi-split system can easily service the rooms for multi storey homes.

*Please check model specifications as these pipe lengths and height differences do not apply to all models.

Variety of Indoor Units

The indoor unit range includes wall mounted, floor standing, low static bulkhead or compact cassette types in a wide range of capacities. This makes hundreds of combinations possible for your home. You can choose the right type of indoor unit to complement the interior décor and match the size of each room.



Independent Control and Comfort

Each indoor unit comes with its own remote allowing the unit to be independently switched on/off and have the temperature adjusted as needed. The conditions of rooms can vary greatly depending on many variables such as the number of occupants or the way the room is used. With a range of comfort, air flow and convenience functions on each indoor unit, you can adjust the settings to match the requirements of a room without affecting other ones. When a room is unoccupied you can switch off the unit to reduce inefficient energy use.

5 Year Warranty

When you buy a Mitsubishi Heavy Industries inverter multi-split system, you are getting an air conditioning solution from a company that manufacture the highest quality products in the industry. Mitsubishi Heavy Industries enjoys a reputation for outstanding quality and is highly respected both in the Australian and overseas markets. With our 5 Year Warranty covering the parts, labour and compressor, you can have peace of mind that your new Mitsubishi Heavy Industries inverter multi-split system will continue to deliver air-conditioning comfort to your home.



eco touch REMOTE CONTROL

Easy operation

All settings done by **tapping touch screen panel**

Operation mode setting screen

The operation mode can be selected by simply tapping this button.

Setting temperature screen

You can select the desired temperature by tapping the ▲▼ button.

Operation mode



Main functions

Energy management

- Peak cut timer • Automatic temperature set back
- Weekly timer • Set ON/OFF timer by hour
- Set ON/OFF timer by clock • Fan only operation
- Sleep timer

Comfort

- Individual flap control • High power operation
- External ventilation ON/OFF • Warm up operation
- Automatic fan speed • Temperature increment setting by 0.5°C

Convenience

- LCD contrast setting • Back light setting • Filter clean sign • Control sound • Outdoor silent mode • Summer time setting
- Home leave mode • Indoor & outdoor temperature display
- Heating standby display • Defrosting operation display • Auto cooling/heating display • °C/°F display • Administrator settings • Room name setting

Service

- Error code display • Operation data display • Next service data display • Contact company display • USB connection (mini-B)

IntesisHome[®]
Your home in the cloud

NEW



RAC Model:
IS-IR-WIFI-1



PAC Model:
MH-RC-WIFI-1

Intesis Wifi Adaptors

Filter



Allergen Clear Filter

The filter breaks down the pollen, lice, and all allergens that live on cat skins, etc. and deactivates them.



Photocatalytic Washable Deodorizing Filter

It keeps air fresh by deodorizing the molecules causing odour. The deodorizing ability can be easily restored simply by cleaning and exposing the filter to the sunlight.



Natural Enzyme Filter

Enzymes used in the filter are naturally occurring lytic enzymes which attack cell walls of microorganisms trapped on the filter and destroy them.



Allergen System

Suppresses the influence of the allergen caught by the filter.



Self Clean

The indoor fan continues to operate on ultra low speed to dry the unit.

Comfortable Functions



Fuzzy Auto Mode

Automatically the unit determines its operating mode and temperature setting based on a fuzzy calculation and adjusts the inverter frequency.



Automatic Operation

The air conditioner automatically selects from heating, cooling or dry operation.



"HI POWER" Operation

The unit can operate continuously in HI POWER mode for 15 minutes. This mode is used to reach the desired temperature quickly.



Three "Hot" System

'Hot start' enables the unit to begin heating operation quickly. 'Hot spurt' is a fast heating system that works to increase the temperature setting by two degrees. 'Hot keep' is used during the automatic defrost cycle to prevent cool air being circulated. These three operational control systems help ensure comfortable and efficient heating.

Comfortable Air Flow Functions



3D Auto

You can choose the best heating or cooling pattern with the touch of a button.



Auto Flap Mode

The unit automatically selects the optimal angle whatever the operation mode.



Air Scroll

The swing of the flap causes the air flow to spiral and the breeze to reach all corners of the room.

COOLING & DRY

Horizontal blowing

HEATING

Slant forward blowing

COOLING & DRY

Thick line — : moves quickly

Thin line — : moves slowly

HEATING

Thick line — : moves quickly

Thin line — : moves slowly



Memory Flap

While the flap is swinging it can be stopped at any angle. The flap returns to this position next time the unit starts.



Up/Down Flap Swing

The Up/Down flap can be adjusted to the preferred angle anywhere between horizontal and perpendicular.

SWING FLAP

Flap moves up and down continuously.



Lateral Swing

The louvre swings from right to left automatically. Louvre angle can be fixed in any desired position.



Air Outlet Selection

Both lower and upper air outlets and upper air outlet can be selected. (SRF models only)



Positioning of Installation

You can set the left-right air flow directions when you install the air conditioner near the side wall by remote controller operation.

Convenience & Economy Functions



On Timer

This enables the operation to start a little earlier so that the room is near to the set temperature at ON time.



24-hour On/Off Programmable Timer

By combining a start timer with a stop timer you can register two timer operations a day. Once set timers will start or stop the system at the specified time of the day repeatedly.



Economy Mode

The unit achieves effective energy saving operation while still keeping a comfortable cooling or heating operation.



Off Timer

The unit stops at the specified time.



Dry Operation

The unit dehumidifies the room by intermittent cooling operation.



Sleep Mode

The room temperature is automatically controlled during the set sleep mode period ensuring that the room temperature will not get too hot or cold.

Maintenance & Prevention Functions



Microcomputer-Operated Defrosting

This function automatically eliminates frost and helps minimize excessive operation in other modes.



Self-Diagnostic Function

If the air conditioner malfunctions an internal microcomputer runs a self diagnosis. Inspection and repair should be performed by authorized dealers.



Detachable Indoor Air Inlet Panel

The air inlet panel on the indoor unit opens and closes easily making filter cleaning simple. The suction panel can be easily removed.

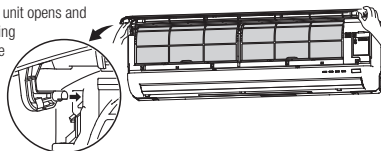

Detachable Indoor Air Inlet Panel

The air inlet panel on the indoor unit opens and closes easily making filter cleaning simple. The suction panel can be easily removed.

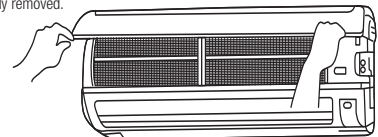

When removing the air inlet panel for internal cleaning or other reasons, open the grill by 65 degrees and then pull it to the side.

Others



Back-up Switch

On the indoor unit there is a back up on/off switch. The system will operate in the previous mode.



24-hour ION

The air conditioner body has a tourmaline coated sheet. Negative ions (2,500 -3,000/cc) are generated when the air conditioner is not running, allowing you to experience them without incurring any electrical cost.



Auto Restart Function

Power blackout auto restart function records the operational status of the air conditioner immediately prior to being switched off by a power supply interruption. The unit automatically resumes operations in the mode and temperature set point after the power has been restored.



Luminous Button

With wireless "Luminous" remote controls that even "glow in the dark", it is possible to operate all desired functions of the unit with the click of a button.

High Efficiency.

DC PAM inverter

An inverter system has a number of advantages over a constant speed system. Its variable speed compressor outputs can ensure quick cooling or heating after start up and attains a set temperature more quickly. The air conditioner can slow down the compressor speed to save energy whilst keeping comfortable conditions. The compressor is DC motor driven so it provides superior performance.

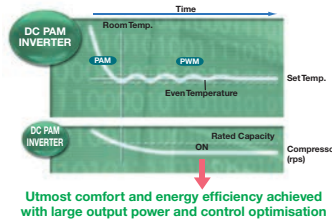
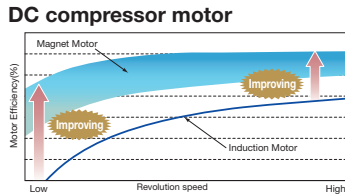

Utmost comfort and energy efficiency achieved with large output power and control optimisation

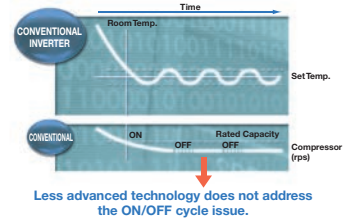

Less advanced technology does not address the ON/OFF cycle issue.

Advanced Technology.

Silicon-coated PCB

The printed circuit board of the outdoor unit is coated by silicon. The coating ensures longevity of the board in humid conditions.

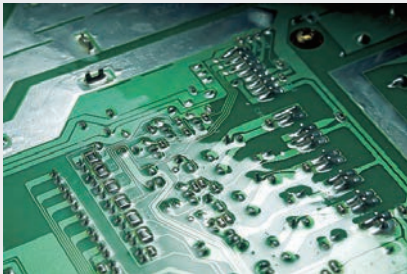

Propeller fan

The new propeller fan was carefully matched with a fan motor in order to keep the same capacity as that of previous models with less electrical consumption.

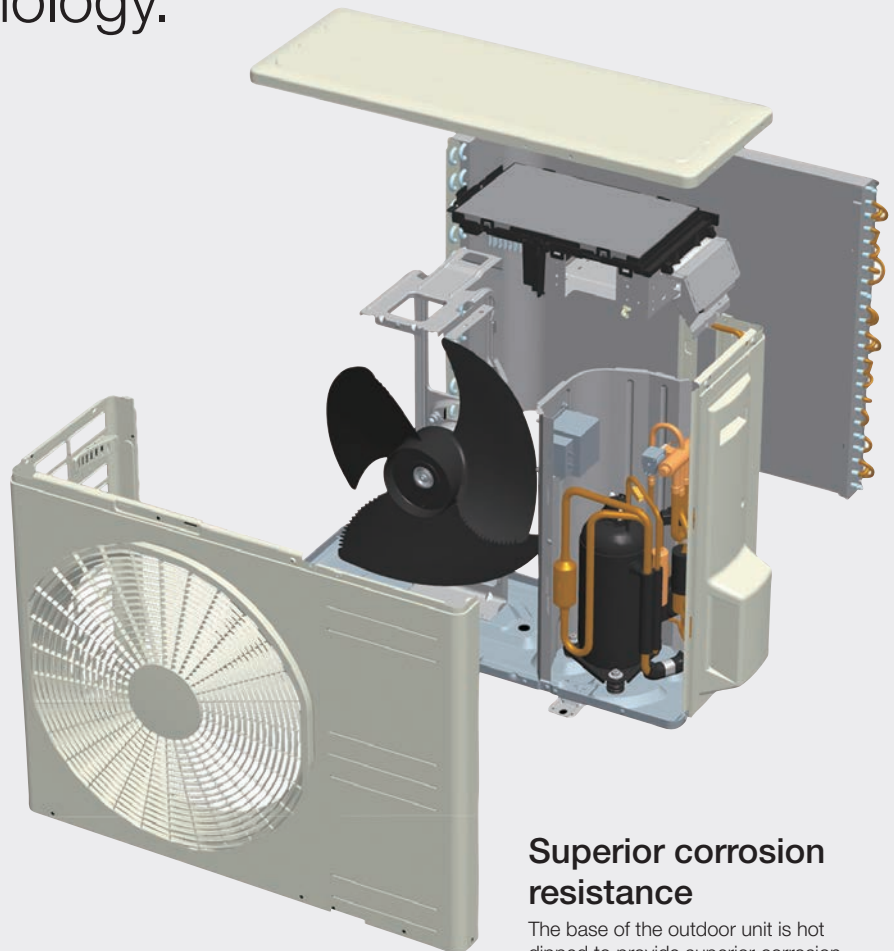

Superior corrosion resistance

The base of the outdoor unit is hot dipped to provide superior corrosion and scratch resistance.

Outdoor unit

Redesigned by changing the fin configuration from flat sheet to new M shape fin, efficiency has been improved. An optimum balance of heat transfer and air flow has been achieved.

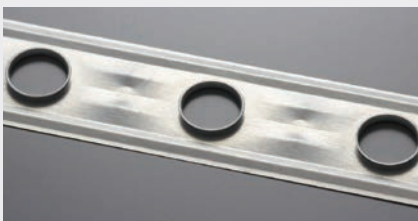

Advanced Technology.

Anti-microbial indoor fan

Anti-microbial specifications and design will deliver cleanliness and safety

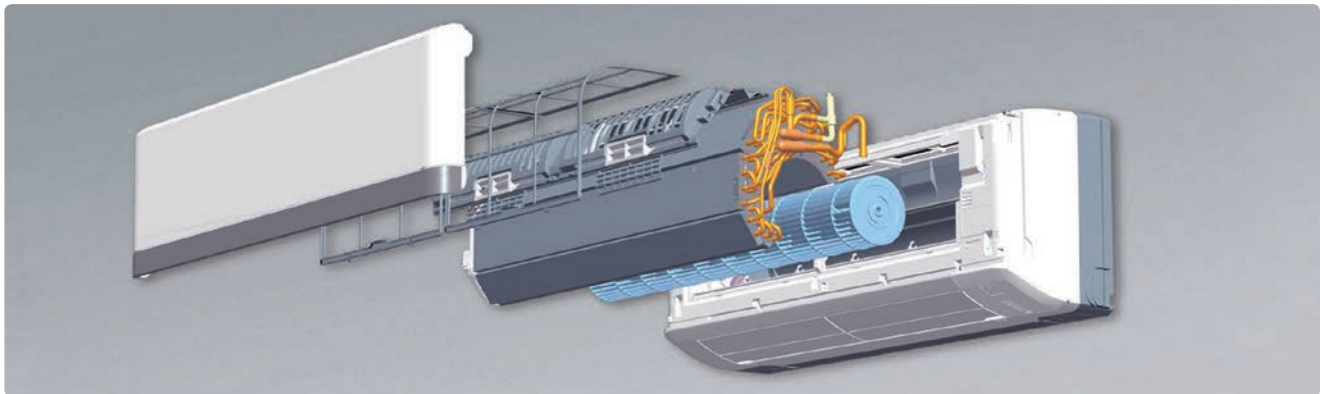

Anti-microbial treatment

The indoor fan has undergone anti-microbial treatment to resist growth of mould and germs. Mould creating odours which can occur when an air conditioner is not in operation are prevented.

Washable filter and easy cleaning of the air inlet panel

Removing the air filter is quite easy. Keeping the air filter clean is an effective way to save energy and keep the original powerful performance of your unit. The air inlet panel is also removable and can be cleaned easily.

Three sensors

Control of room temperature and humidity is very important for people to live a comfortable life. Use of three sensors to control indoor temperature, indoor humidity and outdoor temperature enable the unit to obtain optimum air-conditioning.

Wide operation range

Heating and cooling operations are possible at an outdoor temperature as low as -15°C

Our advanced technology has improved the heating and cooling operation range. Units can be installed when heating or cooling operation is required at low ambient conditions down to -15°C.

Quiet operation

Silent airflow and long reach

The secret of quiet operation

The combination of the jet airflow system and serration stabilizer configuration ensures uniform breeze to every corner of the room. It also makes it possible to lower the operation noise further by minimizing the interaction between airflow and the fan.



Comparison of growth of bacteria and mold on fan surfaces (microscopic image)

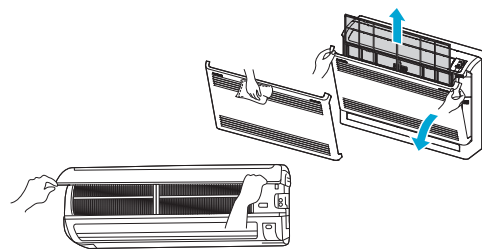

All SRK, SRF, SRR, FDTC
All SCM-appearance may vary
SRK50/60ZMX, SRK35/50/71ZM, SRF-ZMX

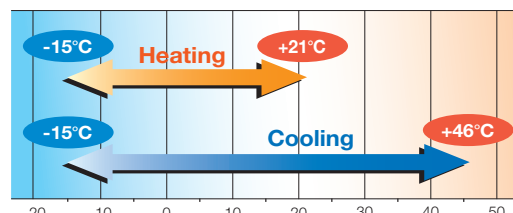

* For the capacities under low temperature conditions, refer to technical manual.

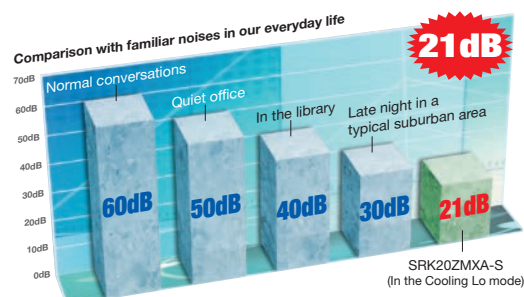

3D AUTO Vertical + Horizontal AIR SCROLL.

3 motors make 3 independent controls

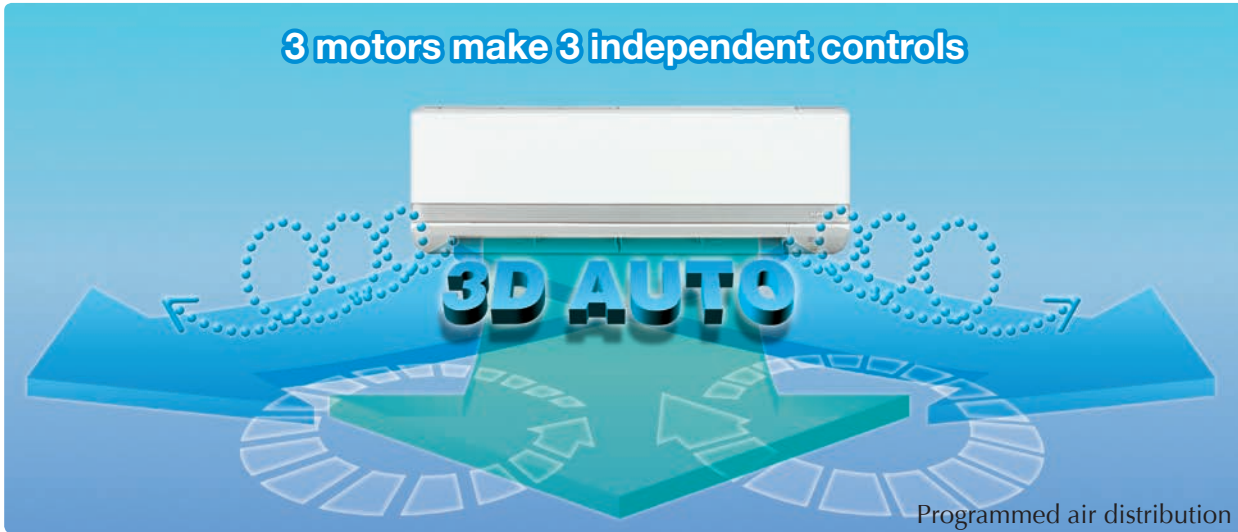

Programmed air distribution

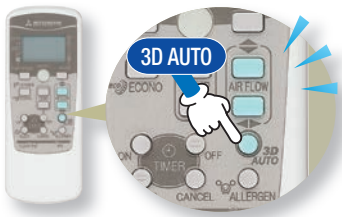

3D AUTO is a one touch programme. Three motors (one vertical working motor + two horizontal working motors) make three independent air flow controls. The airflow is uniform, quiet and reaches at long distance from the indoor unit.

Programmed 3D AUTO

Automatic control of air flow volume and air flow direction enables comfortable air conditioning of the entire room. In cooling operation, cooled air flows directly to the ceiling not directly onto the occupants of the room. The comfort cooled air flow comes down from the ceiling like a soft shower. In heating operation, warm air flows to the floor directly and spreads along the floor. The concentration of the warm air at floor level increases comfort.

Manual Setting

Individual control of right and left louvre enables air flow direction from the right and the left side of the unit, setting the most preferable air flow direction and determining whether direct air flow is required or not.

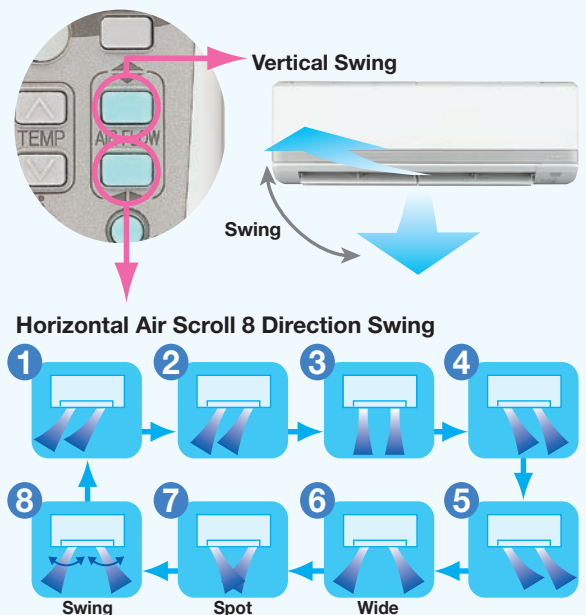
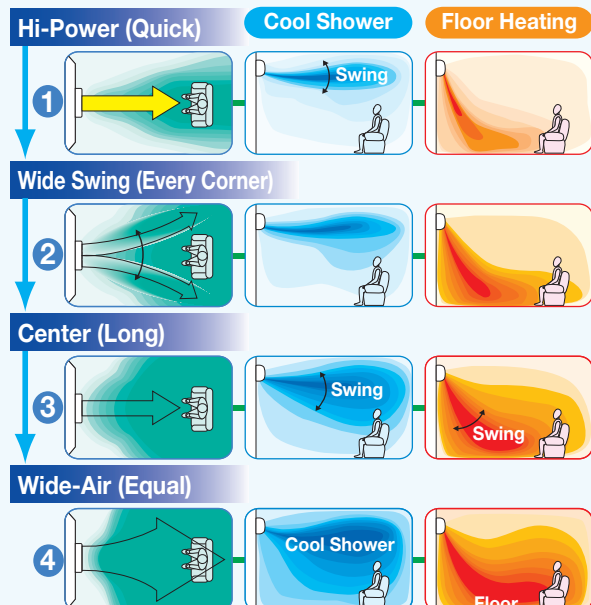

Jet Air Scroll Long Reach & Silent Air Flow.

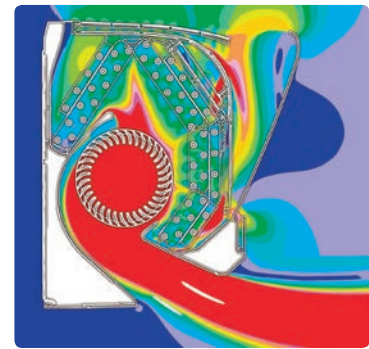

Fast ← → Slow
Colours in the figure show the air speed.

We used the same aerodynamic analysis technology as used in developing jet engines.

CFD (computational fluid dynamics) is used for blade shape design and air channels for jet engines. The same technology has been used in our air conditioners. The airflow of the jets created in this system enables a large volume of air to be blown with a minimum amount of power consumption. The airflow is uniform, quiet and reaches a long distance from the indoor unit.

Long Reach Air Flow

The jet technology enables powerful airflow ideal for large living areas and commercial premises, increasing your comfort.

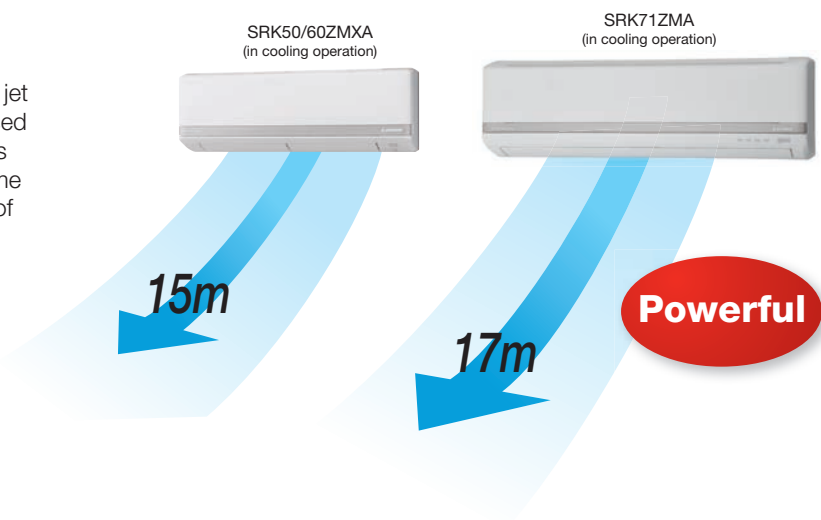

Positioning of Installation

You can set the left-right air flow directions when you install the air conditioner near the side wall by remote controller operation.

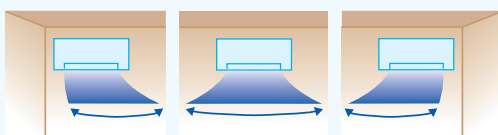

New louvre

The new louvre has a new design and shape. It has increased in surface area by 80%. In addition to improved control of the increased air flow volume, it has improved controllability of the right to left swing function.

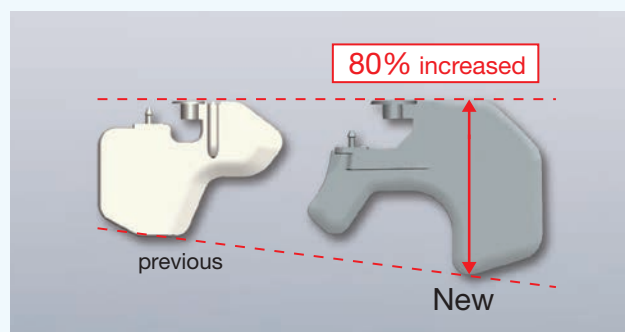

Clean Air.

Allergen Clear System

The 'Allergen Clear system' suppresses the influence of the allergen caught by the filter by controlling the temperature and humidity.

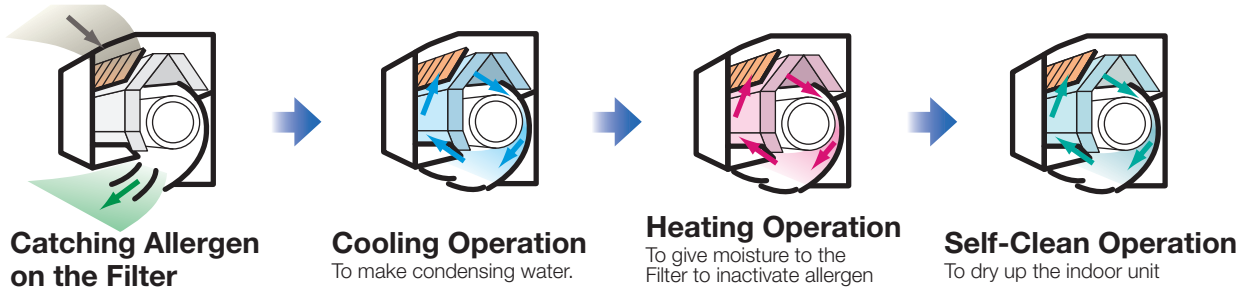
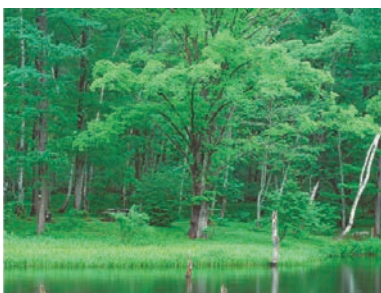
Generates the same amount of negative ions as a forest environment

24-hour ION

The air conditioner body has a tourmaline coated sheet. Negative ions (2,500 -3,000/cc) are generated even when the air conditioner is not running, allowing you to experience them without incurring any electrical cost.



Push ALLERGEN Mode

First in the world
20 of Patent Pending

The air in your room is kept fresh

Allergen clear system

The 'Allergen Clear system' suppresses the influence of the allergen caught by the filter by controlling the temperature and humidity.

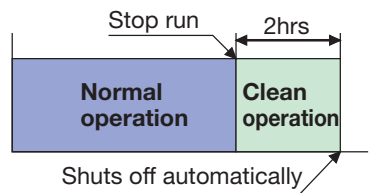

Shuts off automatically

After one week without self clean operation

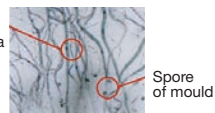

After one week with self clean operation

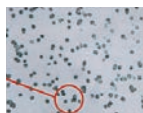
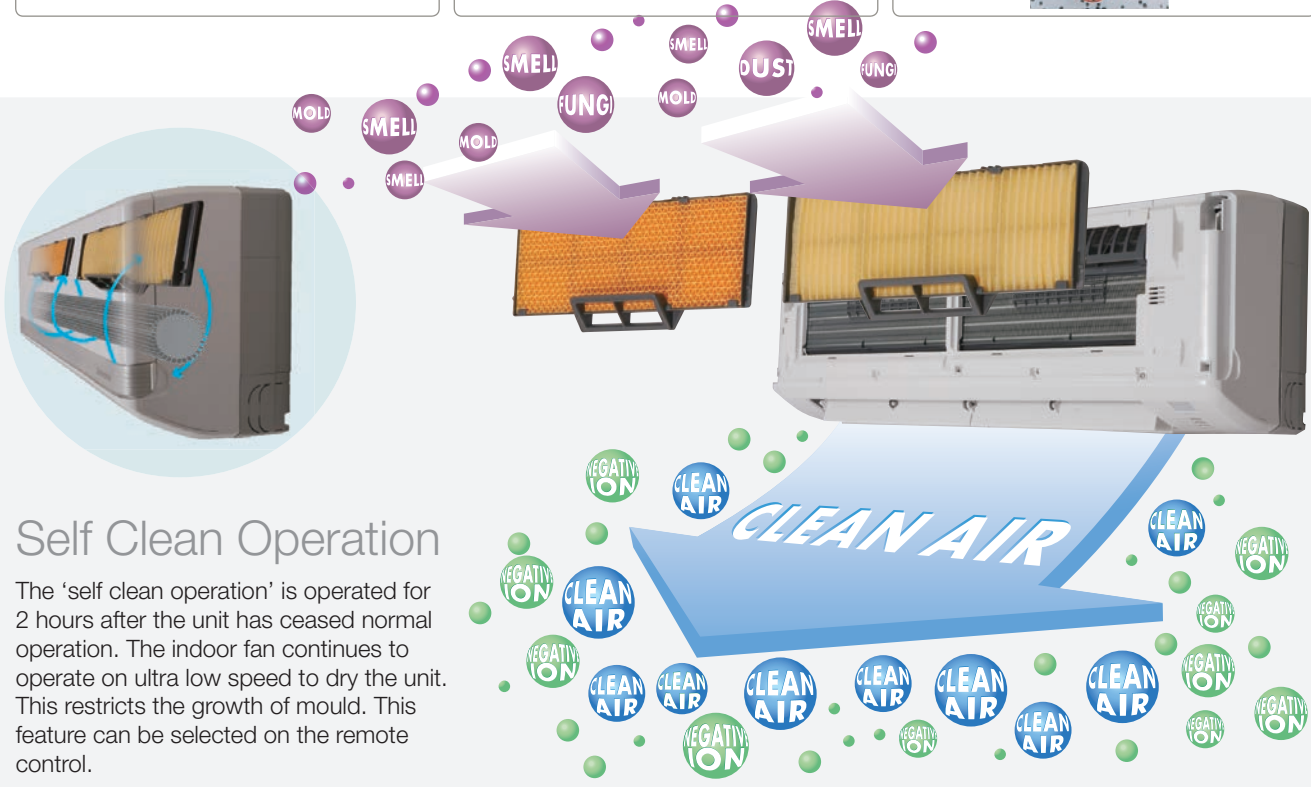
Self Clean Operation

The 'self clean operation' is operated for 2 hours after the unit has ceased normal operation. The indoor fan continues to operate on ultra low speed to dry the unit. This restricts the growth of mould. This feature can be selected on the remote control.

Natural enzyme filter

Helps to destroy fungi and bacteria, also effective on viruses and allergenic compounds (Cat hair, dust mite, pollen etc.)

Enzyme filter

The enzymes used in these filters are naturally occurring lytic enzymes. Lytic enzymes attack cell walls of microorganisms trapped on the filter and destroy them. The Natural Enzyme Filter will clean and sanitize air passing through it.

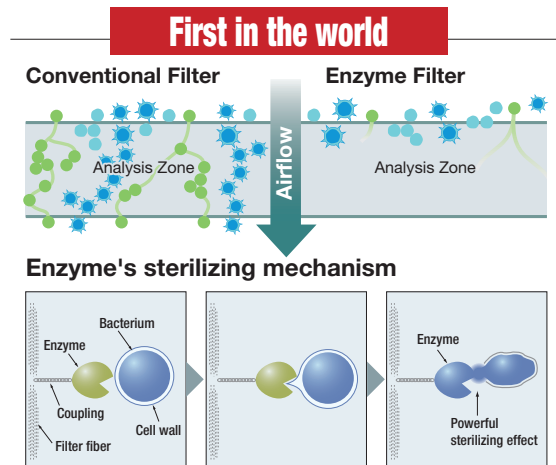

Allergen clear filter

This is the original and only technology to control the temperature and humidity for inactivating allergens

Enzyme + Urea deactivates allergens and kills bacteria

The allergen clear filter deactivates pollen lice and allergens that live on cat skin etc. The deactivation secret is the Enzyme-urea compound. It deactivates not only allergens but some bacteria, moulds and viruses. Even if allergen, mould, virus or bacteria fly off the filter they are deactivated so the air in your room is kept fresh.

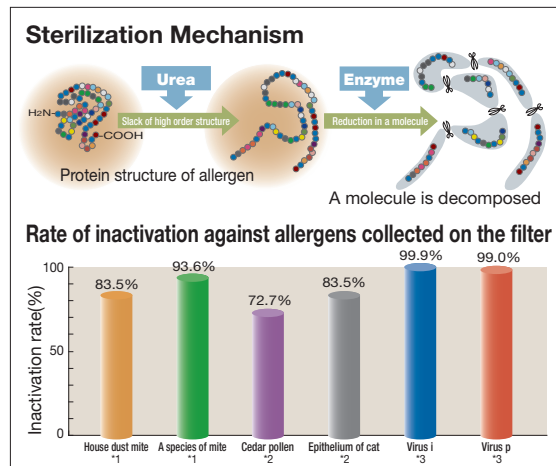

Photocatalytic washable deodorizing filter

The deodorizing ability of this filter can be easily restored simply by cleaning and exposing to sunlight

This filter will keep the air fresh by deodorizing the molecules that cause odours. The deodorizing effect can be restored by washing with water and then drying under the sun. This filter maintains its deodorizing effect even after many repeat uses.

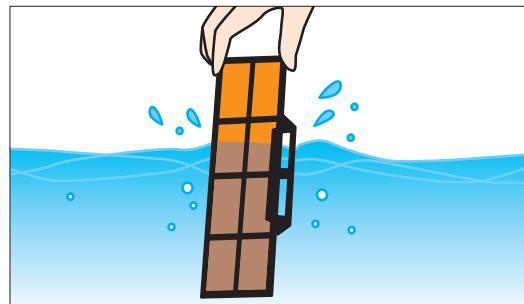

Used in models

Filter	Indoor Unit	SRK-ZMXA	SRK-ZMA	SRF-ZMXA
Allergen Clear Filter		1pc	1pc	-
Photocatalytic Washable Deodorizing Filter		1pc	1pc	1pc

Ceiling Concealed Type.

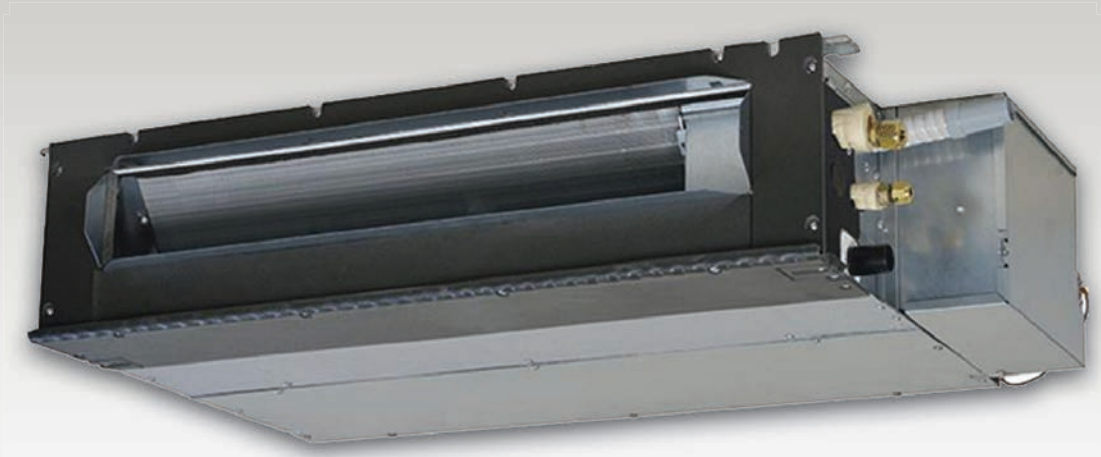

SRR25-60ZM



Standard Equipment

Wired Remote Control



RC-EX1A



RC-E5



RCH-E3



Wi-Fi Control

Wi-Fi control capacity on the SRRZM-S Series, allowing you to control the indoor environment from anywhere.



Concealed System

The SRRZM-S Series is perfect as a concealed system for a bedroom or small lounge or living room area.

Slim design

200

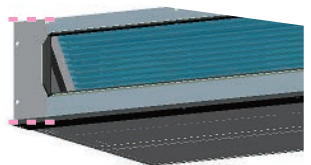

Built in Drain Pump

Utilising MHI's long established experience in drain pump technology, the SRRZM-S Series come with built in condensate drain pumps for your convenience.

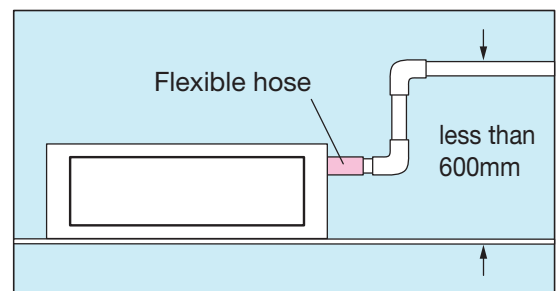

Dimensions.

Ceiling concealed type (SRR) Models SRR25ZM-S, 35ZM-S

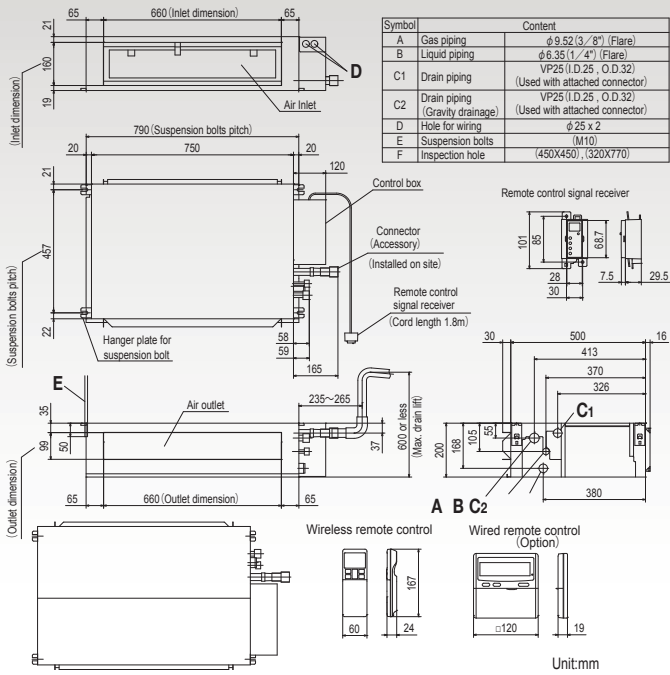

Space for installation and service

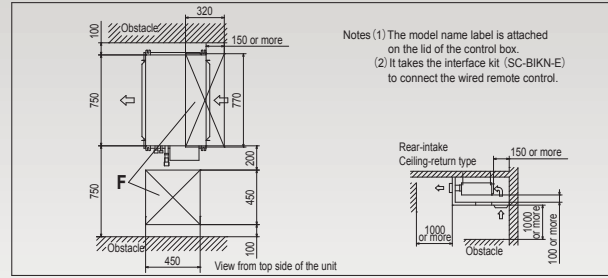

Model SRR25ZM-S

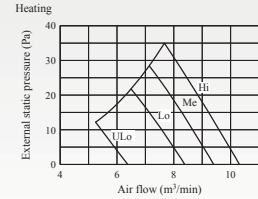
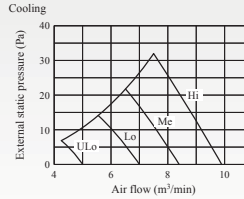

Model SRR35ZM-S

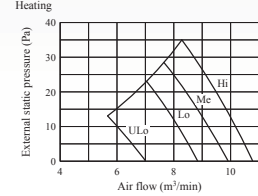
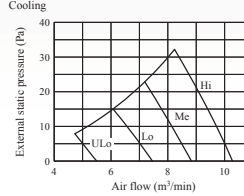

Ceiling concealed type (SRR) Models SRR50ZM-S, 60ZM-S

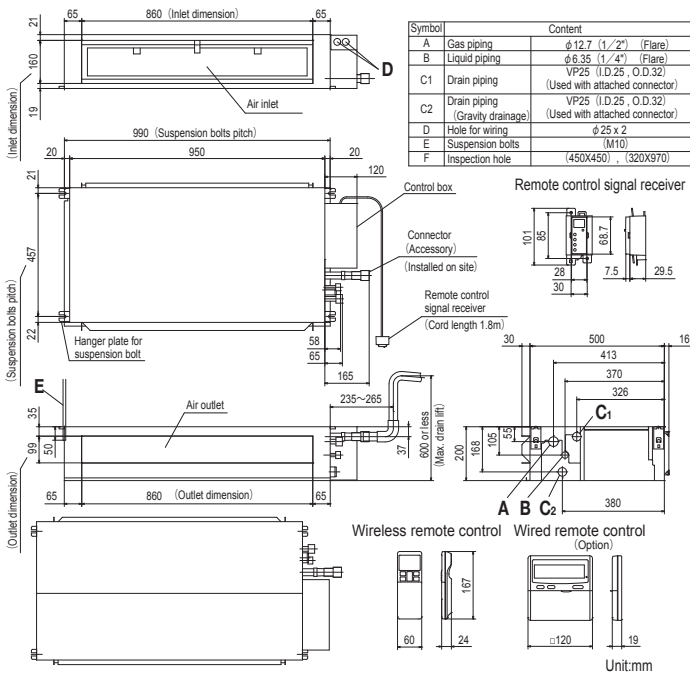

Space for installation and service

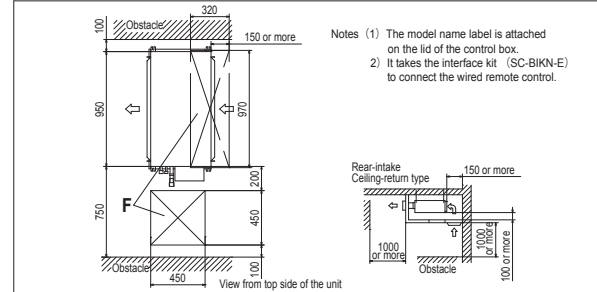

Model SRR50ZM-S

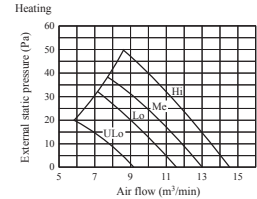
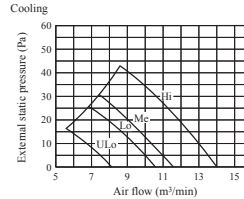

Model SRR60ZM-S

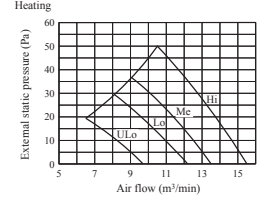
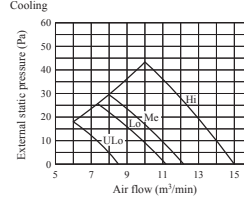

Compact Ceiling Cassette.

Fits into standard 600 x 600 ceiling



FDTC25~60VF

Wired Remote Control

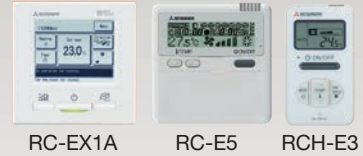

Wireless Remote Control



Taking outside air inside

OA Spacer TC-OAS-E (option)
Joint Duct TC-OAD-E (option)

Utilizing OA spacer which comes as optional equipment, outside air can be taken inside.

Using 1 joint duct:

OA comes up to 1.3m³/min.

Using 2 joint ducts:

OA comes from 1.3 to 2.6m³/min.

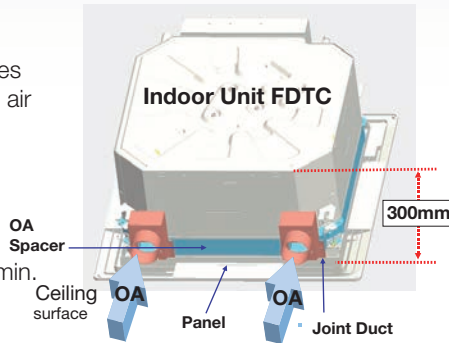

Quiet operation

(Sound Pressure level in the Lo mode)

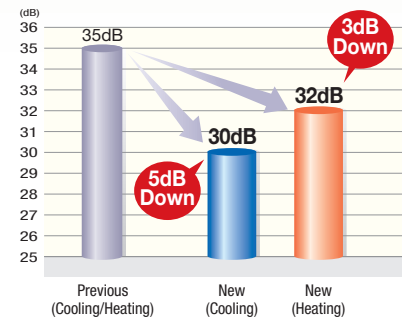

“CLEARER” air flow

New shape & angled louvre redirects the air current away from the ceiling, to reduce ceiling stains

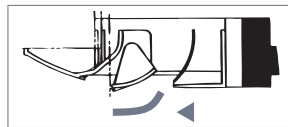
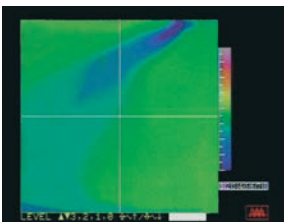

Compact and convenient

600mm drain pump

Drain can be discharged upward by 600 mm from the ceiling surface close to the indoor unit. It allows a piping layout with a high degree of freedom depending on the installation location.

600 x 600 ceiling

Indoor unit size (W:570 x D:570) brings easy installation for 600 x 600 ceiling and Panel size (700 x 700) is suitable for 600 x 600 ceiling. Height is one of the industry's lowest level at 248mm and weight is 16.5kg only.

Easy installation

For wireless control simply insert the infrared receiver kit on a corner of the panel



wireless remote control RCN-TC-24W-ER

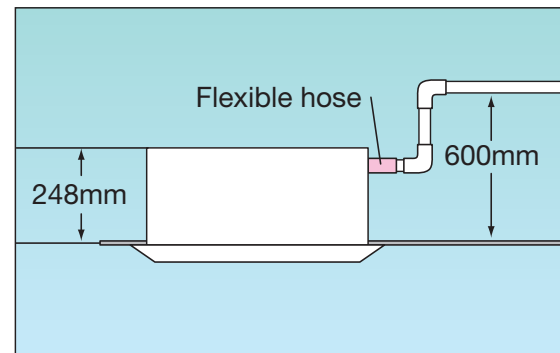

Dimensions.

4way ceiling cassette type (FDTC) Models FDTC25VF, 35VF, 50VF, 60VF

Symbol	Content	
A	Gas piping	Model 25.35 : $\phi 9.52$ (3/8") (Flare) 50.60 : $\phi 12.7$ (1/2") (Flare)
B	Liquid piping	$\phi 6.35$ (1/4") (Flare)
C	Drain piping	VP20 (I.D.20,O.D.26) Note (2)
D	Hole for wiring	$\phi 25$
F	Suspension bolts	(M10 or M8)
G	Ducting for air outlet	(Knock out)

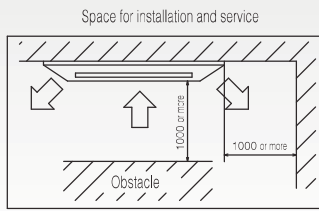

Make a space of 4000 or more between the units when installing more than one.

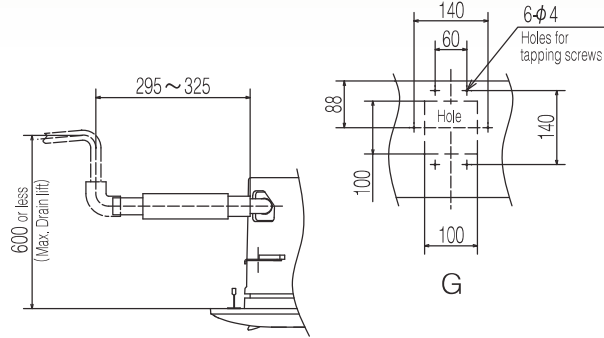
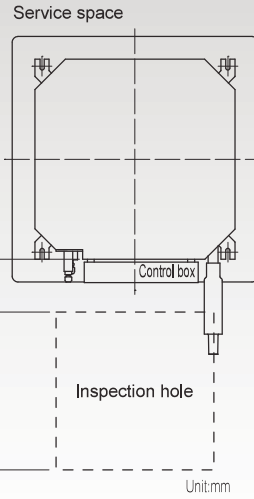
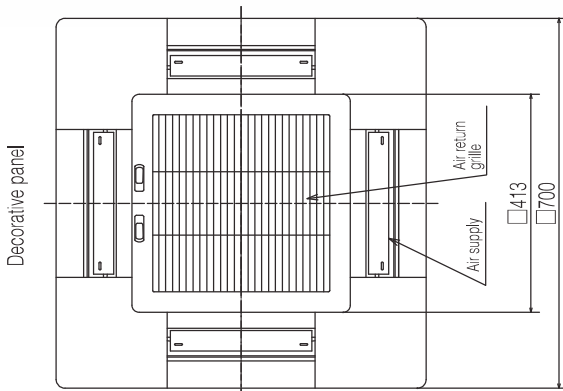

- Notes (1) The model name label is attached on the control box lid.
(2) Prepare the connecting socket (VP20) on site.
(3) This unit is designed for 2x2 grid ceiling.
If it is installed on a ceiling other than 2x2 grid ceiling, provide an inspection port on the control box side.

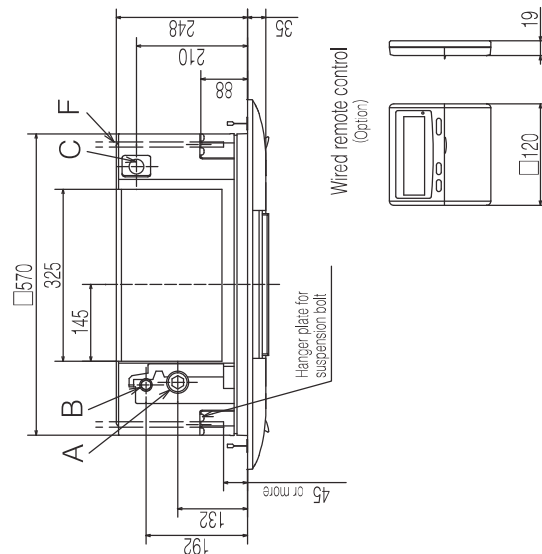
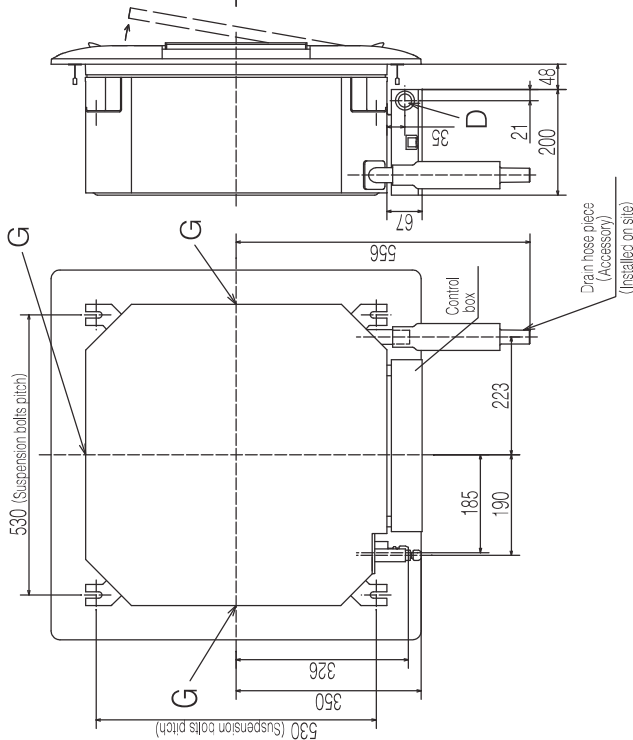

PJA003Z338

Ceiling Concealed Type Medium Static.



FDUM50VF

Wired Remote Control

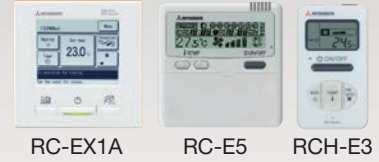

Wireless Remote Control



Low profile

The height of FDUM50 model is only 280mm.

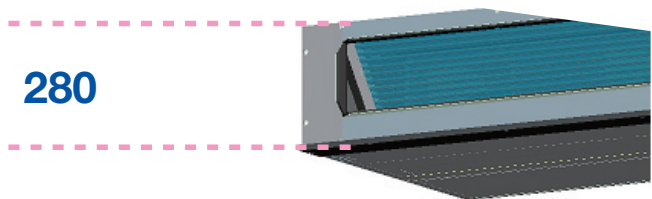

Improved servicing

Fan unit (impeller and motor) can be pulled out from the right side of the unit. Maintenance is available from the right side or from beneath.

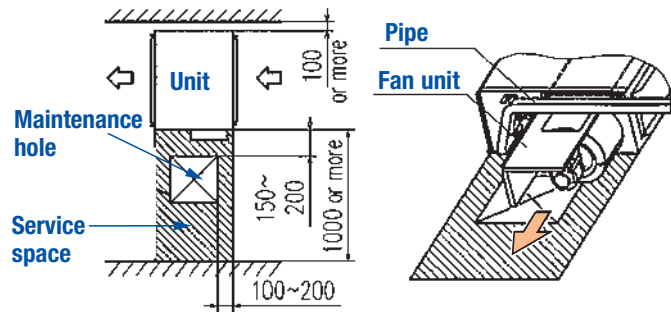

600mm drain pump

Drain can be discharged upwards by 600mm from the ceiling surface. It allows a piping layout with a high degree of freedom depending on the installation location.

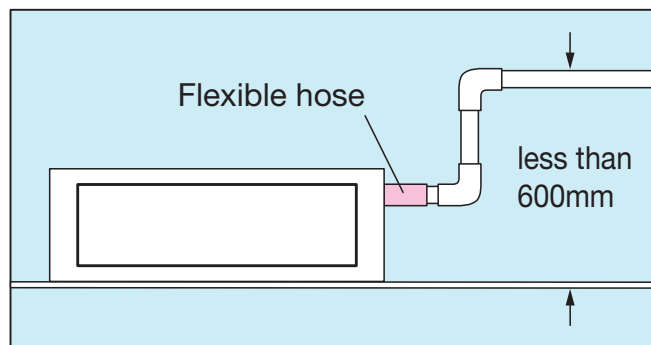

Dimensions.

Duct connected Low/Middle static pressure type (FDUM) Model FDUM50VF

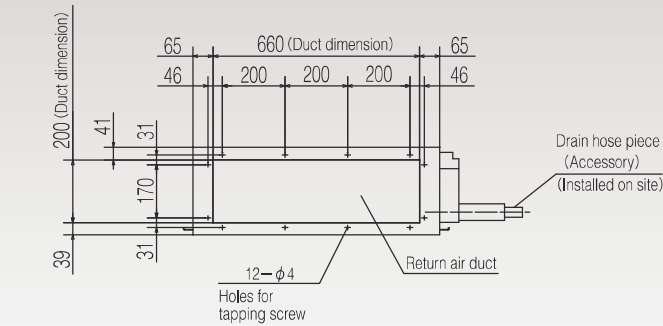

Symbol	Content	
A	Gas piping	φ 12.7 (1/2") (Flare)
B	Liquid piping	φ 6.35 (1/4") (Flare)
C1	Drain piping	VP25(I.D.25,O.D.32)
C2	Drain piping (Gravity drainage)	VP20(I.D.20,O.D.26)
D	Hole for wiring	
E	Suspension bolts	(M10)
F	Outside air opening for ducting	(φ 150) (Knock out)
G	Air outlet opening for ducting	(φ 125) (Knock out)
H	Inspection hole	(450X450)

Note (1) The model name label is attached on the lid of the control box.

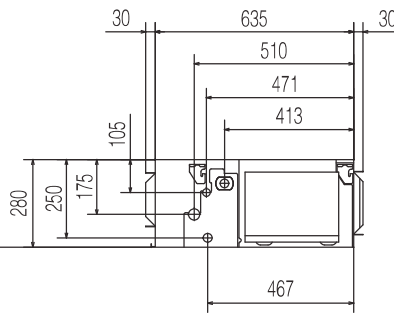
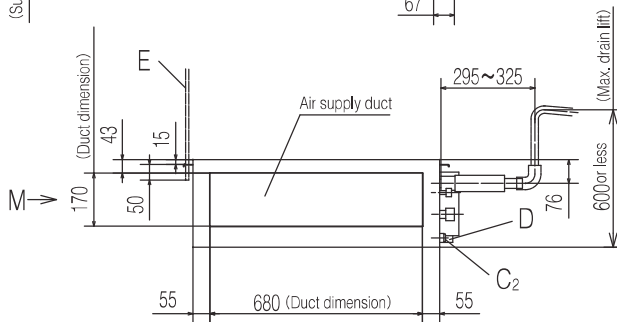
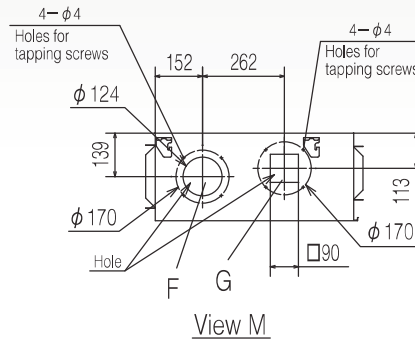
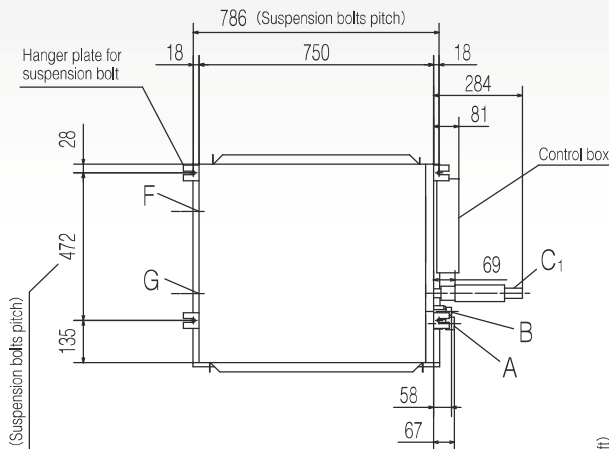

Unit:mm

Space for installation and service

Select either of two cases to keep space for installation and services.

(Case 1) From side of unit

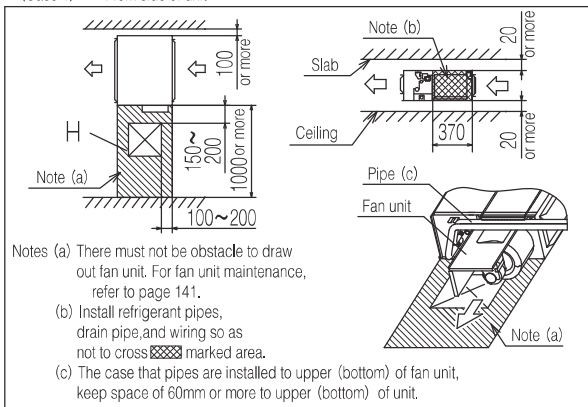

- Notes (a) There must not be obstacle to draw out fan unit. For fan unit maintenance, refer to page 141.
 (b) Install refrigerant pipes, drain pipe, and wiring so as not to cross marked area.
 (c) The case that pipes are installed to upper (bottom) of fan unit, keep space of 60mm or more to upper (bottom) of unit.

(Case 2) From bottom of unit

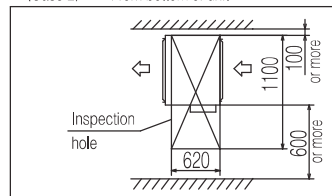

Wired remote control (Option)

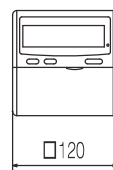

PJG000Z002A



SRF25~50ZMXA



Wired Remote Control



RC-EX1A



RC-E5



RCH-E3

Sophisticated design

With a classy semi flat front panel in chic white, this series fits in all kinds of rooms and creates a relaxing atmosphere. Choice of wall hanging and floor standing installation is available.

Auto air outlet selection

Heating operation:

When both lower and upper outlets operation and the Auto fan speed mode is selected, the lower outlet will be kept closed for twenty minutes after the start or until room temperature is close to reaching the set point. Then the air outlet will change to both outlets. That state will be maintained until the switch is turned off.

Automatic adjustment of lower air outlet direction prevents stirring up of warm air and keeps optimum comfort at floor level.

Cooling operation:

When both lower and upper outlets operation is selected in Cooling or Dry operation, both outlets are kept open for sixty minutes after the start or until room temperature is below set point. Then the air outlet will change to the upper outlet. That state will be maintained until unit is switched off.

In case both outlets operation with Auto fan speed mode is selected, the upper outlet will be kept closed for ten minutes after the start or until room temperature is close to reaching the set point. Then the air outlet will change to both outlets in order to spread comfort air to every corner.

Easy installation

Piping and drain hose connection can be selected out of 6-directions.

Convenient to use operation

Besides on/off operation, simultaneous lower and upper air outlets or upper outlet can be selected by the air flow direction button. Further control can be selected on the remote control.

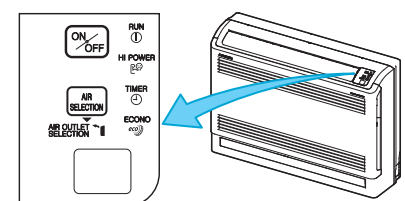
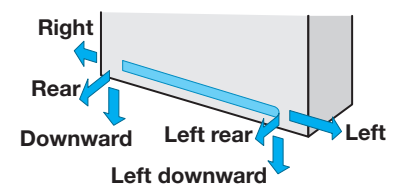

Ceiling Suspended.

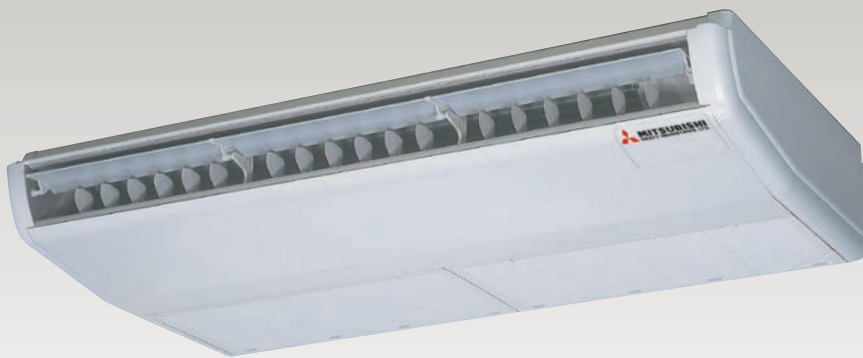

FDEN50VF

Wired remote control



RC-E5 RCH-E3

Wireless remote control

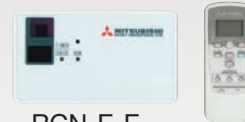

RCN-E-E

Easy installation

Increased freedom of a piping layout

The refrigerant pipe from the unit can be arranged in three directions, rear, right and up. The drain pipe can be arranged in two directions, left and right. This will allow a free layout of piping for various installation conditions. The unit can only be serviced from below.



Compact and modern design

All models fit compactly on the ceiling. Height is 210mm. Elegant, modern design featuring rounded edges gives the room a comfortable atmosphere.



Control Options.

CnT Remote Input

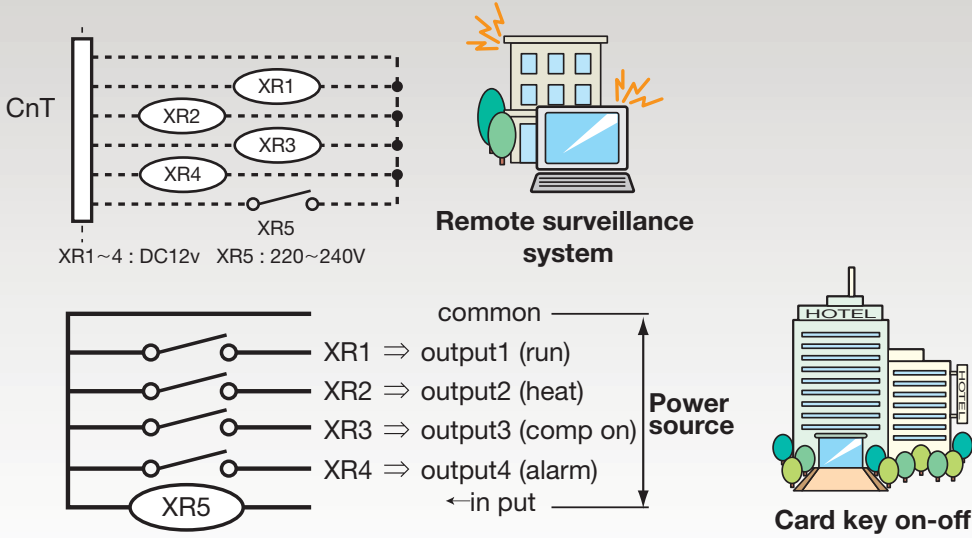

Model	Wired Remote Control		Wireless Remote Option	Super Link Network	
	Interface	Wired Remote Control	Infrared Kit	Interface	Wired Remote Control
SRK**ZMA-S	SC-BIKN-E	Options: RC-EX1A RC-E5 RCH-E3	Not required	SC-BIKN-E SC-ADNA-E	Options: RC-EX1A RC-E5 RCH-E3
SRK**ZMXA-S					
SRF**ZMXA-S					
SRR**ZM-S					
FDUM50VF	Not required		RCN-KIT3-E	SC-ADNA-E	
FDTC**VF			RCN-TC-24W-ER		
FDEN50VF			RCN-E1R		

Refrigerant Pipe Length

Limit - The maximum piping length of the refrigerant pipes for the outdoor units, and the maximum height difference for the outdoor units are as shown below.

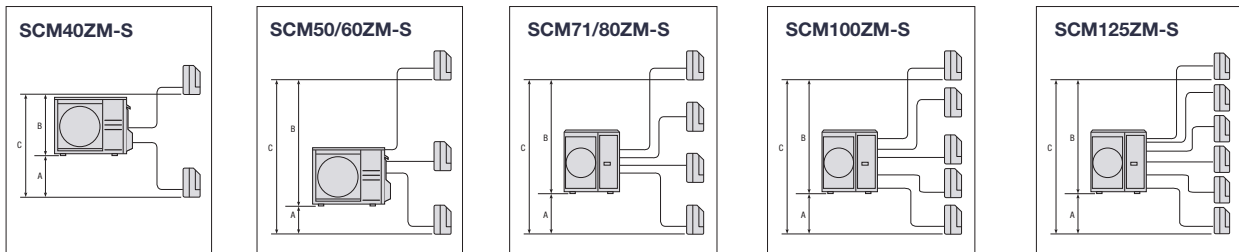

Maximum refrigeration pipe run metres		SCM40ZM	SCM50/60ZM	SCM71/80ZM	SCM100/125ZM-S
length for one indoor unit		25			
total length for all rooms		30	40	70	90
height difference	lower installation spot of the indoor unit (A)	15		20	
	upper installation spot of the indoor unit (B)				
	maximum height difference of the indoor units (C)	25			
Precharged to referigerant pipe length (m)		30	40	50	

Inverter Multi-Split System.

SCM-ZM-S

The multi system allows a single outdoor unit to service up to six indoor units.

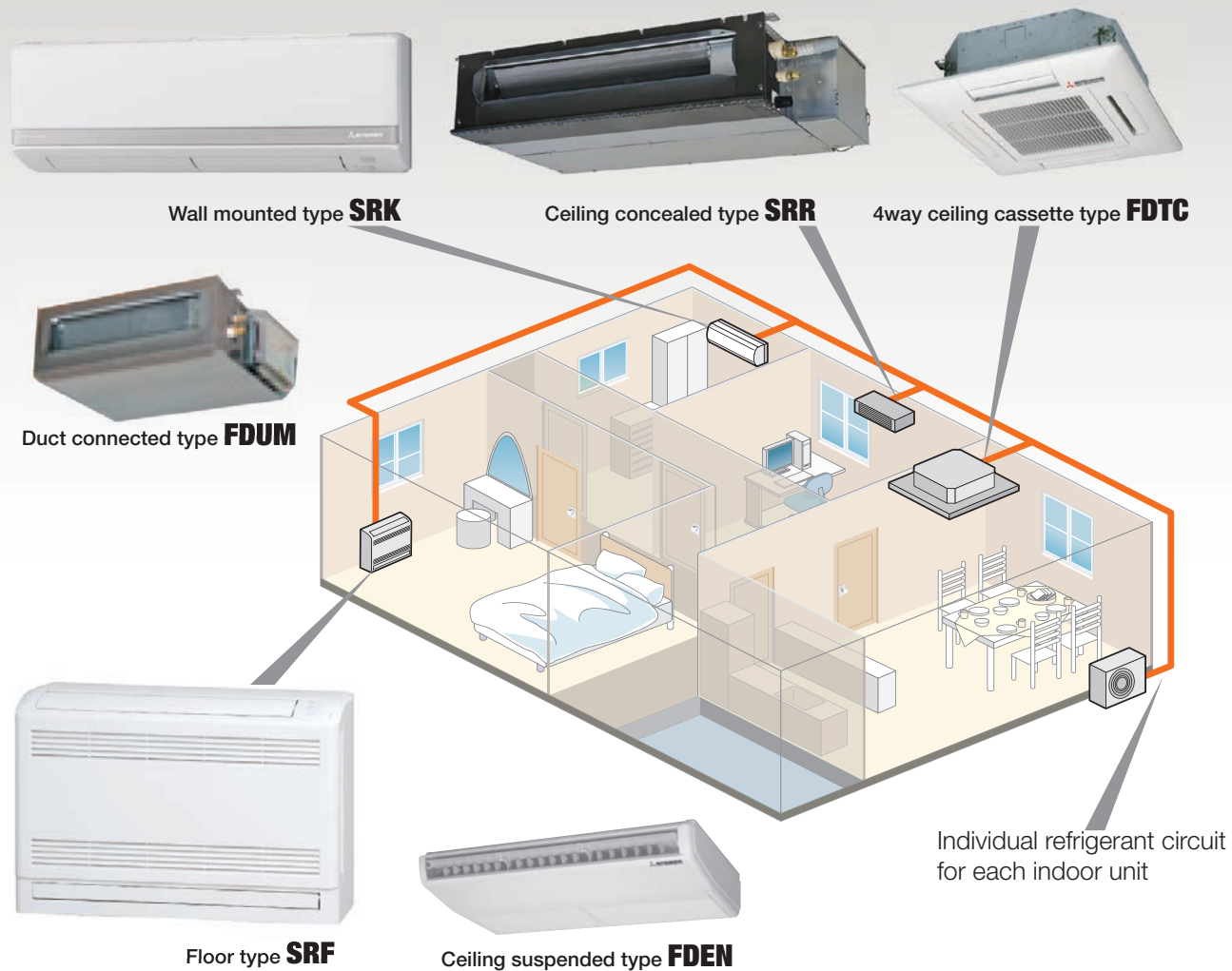

Outdoor Unit



SCM40ZM-S1 / SCM50ZM-S1
SCM60ZM-S1



SCM71ZM-S1 / SCM80ZM-S1



SCM100ZM-S1 / SCM125ZM-S1

Inverter Multi-Split System.

Outdoor Unit Models		SCM40ZM-S	SCM50ZM-S1	SCM60ZM-S1	SCM71ZM-S1	SCM80ZM-S1	SCM100ZM-S1	SCM125ZM-S1	
Min~Max Indoor Units (ports)		2 Rooms	2~3 Rooms		2~4 Rooms		4~5 Rooms	4~6 Rooms	
Power Supply	Outdoor	1 Phase 230V 50Hz							
Capacity	Cooling T1	4.0 (1.8~5.9)	5.0 (1.8~7.1)	6.0(1.8~7.5)	7.1 (1.8~8.8)	8.0 (1.8~9.2)	10 (1.8~12.0)	12.5 (1.8~14.0)	
	Heating H1	4.5 (1.4~6.9)	6.0 (1.4~7.5)	6.8 (1.5~7.8)	8.6 (1.5~9.4)	9.3 (1.5~9.8)	12 (1.5~13.5)	13.5 (1.5~14.0)	
Input	Cooling T1	0.84	1.08	1.43	1.74	2.16	2.86	3.9	
	Heating H1	0.90	1.31	1.51	2.00	2.26	2.93	3.25	
EER	Cooling T1	4.76	4.63	4.20	4.08	3.70	3.5	3.21	
COP	Heating H1	5.00	4.58	4.50	4.30	4.12	4.1	4.15	
Current	Cooling T1	3.7	4.7	6.5	7.6	9.4	12.4	17	
	Heating H1	4	5.8	6.8	8.8	10	12.8	14.1	
Rec Circuit Breaker		25A					32A		
Sound Power Level (JIS C9612)	Cooling(Outdoor)	60	62	63	65	66	68	69	
	Heating(Outdoor)	62	65		66		71	72	
External Dimensions	(HXWXD)	mm	640x850x290			750x880x340		945x970x370	
Net weight	Outdoor	kg	47	48	49	62		92	
Refrigerant Piping	Liquid line	mm	Ø6.35 X 2	Ø6.35 X 3		Ø6.35 X 4		Ø6.35 X 5	Ø6.35 X 6
	Gas line		Ø9.52 X 2	Ø9.52 X 3		Ø9.52 X 4		Ø9.52 X 5	Ø9.52 X 6
	Union			(Ø9.52⇒Ø12.7) X 1	(Ø9.52⇒Ø12.7) X 2			(Ø9.52⇒Ø12.7, Ø15.8) X 2	
	Connection method		Flare connection						
Refrigerant R410A	Volume	kg	2.0	2.5		3.15		6	
	Pre-Charged		30 mtrs	40 mtrs			50 mtrs		
Indoor Unit Combination	SRK*ZMA	kW	2.0, 2.5, 3.5	2.0, 2.5, 3.5, 5.0			2.0, 2.5, 3.5, 5.0, *7.1		
	SRK*ZMXA		2.0, 2.5, 3.5, 5.0	2.0, 2.5, 3.5, 5.0, 6.0					
	SRF*ZMXA		2.5, 3.5, 5.0						
	SRR*ZM		2.5, 3.5, 5.0	2.5, 3.5, 5.0, 6.0					
	FDTC*VF		2.5, 3.5, 5.0	2.5, 3.5, 5.0, 6.0					
	FDUM*VF		5.0						
	FDEN*VF		5.0						
Indoor Unit Connection			2 Units	2 to 3 Units		2 to 4 Units		4 to 5 Units	4 to 6 Units
Indoor Connection Capacity		kW	4.0kW to 6.0kW	4.0kW to 8.5kW	4.0kW to 11.0kW	4.0kW to 12.5kW	4.0kW to 13.5kW	8.0 kW to 16.0kW	8.0kW to 19.5kW

Notes

Note 1 Rated data is measured using SRK*ZJX indoor unit at an equivalent indoor/ outdoor capacity

Note 2 Currently there is no energy labelling standard for this type of product

SCM Series Operating Ranges

Outdoor Unit Model Number	Minimum Number of Indoor Units to be Connected	Maximum Capacity of Indoor Units Allowable	Maximum One Way Piping Length	Maximum Piping Length for all Indoor Units Connectable	Difference in Height Allowable Between Indoor and Outdoor Units		Maximum Height Difference Allowable from Lowest Indoor Unit to Highest Indoor Unit {C}
					When Indoor Unit Is Above Outdoor Unit {A}	When Outdoor Unit Is Above Indoor Unit {B}	
SCM40ZM-S	2	6.0 Kw	25 M	30 M	15 M	15 M	25 M
SCM50ZM-S	2 to 3	8.5 Kw	25 M	40 M	15 M	15 M	25 M
SCM60ZM-S	2 to 3	11.0 Kw	25 M	40 M	15 M	15 M	25 M
SCM71ZM-S	2 to 4	12.5 Kw	25 M	70 M	20 M	20 M	25 M
SCM80ZM-S	2 to 4	13.5 Kw	25 M	70 M	20 M	20 M	25 M
*SCM100ZM-S	*4 to 5 Units	16.0 Kw	25 M	90 M	20 M	20 M	25 M
*SCM125ZM-S	*4 to 6 Units	19.5 Kw	25 M	90 M	20 M	20 M	25 M

* Refer to page 27 for additional information regarding SCM series specifications.

* In case of combination with SRK--ZMXA-S, SRK71ZMA-S, FDEN50VF, 3 indoor units can be connected.

Example; Can be 3 x SRK--ZMXA-S or 3 x FDEN50VF or a combination of any of these three noted.

* In case of SRK71ZMA-S + SRK71ZMA-S, 2 indoor units can be connected as a two port legal connection.

* SRK63ZMA-S, SRK80ZMA-S, SRK92ZMA-S, and other FDUM & FDEN models or FDT, FDU models are not possible to connect with SCM series.

* DXK/DXU indoor units are not possible to connect with SCM series.

SRK-ZMXA-S

Hi-COP Wall Mount Type



Model		SRK20ZMXA-S	SRK25ZMXA-S	SRK35ZMXA-S	SRK50ZMXA-S	SRK60ZMXA-S	
Cooling capacity	kW	2.0	2.5	3.5	5.0	6.0	
Heating capacity		3.0	3.4	4.5	5.8	6.8	
Sound power level*	Cooling	dB(A)	53	55	58	60	62
	Heating		54	58	59	64	64
Sound pressure level*	Cooling	dB(A)	Hi: 39 Me: 30 Lo: 24 UL0: 21	Hi: 41 Me: 31 Lo: 25 UL0: 22	Hi: 43 Me: 33 Lo: 25 UL0: 22	Hi: 47 Me: 40 Lo: 27 UL0: 25	Hi: 51 Me: 41 Lo: 29 UL0: 25
	Heating		Hi: 38 Me: 33 Lo: 25 UL0: 21	Hi: 41 Me: 34 Lo: 27 UL0: 22	Hi: 42 Me: 35 Lo: 27 UL0: 22	Hi: 48 Me: 40 Lo: 33 UL0: 26	Hi: 48 Me: 41 Lo: 34 UL0: 27
Airflow	Indoor	Cooling	Hi: 208 Me: 133 Lo: 105 UL0: 83	Hi: 208 Me: 150 Lo: 105 UL0: 83	Hi: 225 Me: 158 Lo: 108 UL0: 83	Hi: 225 Me: 183 Lo: 133 UL0: 117	Hi: 242 Me: 208 Lo: 142 UL0: 117
		Heating	Hi: 200 Me: 158 Lo: 117 UL0: 105	Hi: 217 Me: 167 Lo: 125 UL0: 105	Hi: 233 Me: 183 Lo: 133 UL0: 108	Hi: 283 Me: 242 Lo: 175 UL0: 133	Hi: 292 Me: 250 Lo: 183 UL0: 142
Exterior dimensions (HxWxD)		mm	309x890x220				
Net weight		kg	13.5				
Clean filter			Allergen Clear Filter x 1, Photocatalytic Washable Deodorizing Filter x 1				
Piping	Liquid line	mm	Ø6.35				
	Gas line		Ø9.52	Ø12.7			
OUTDOOR UNITS TO BE COMBINED			SCM40~125ZM-S		SCM50~125ZM-S	SCM60~125ZM-S	

SRK-ZMA-S

Wall Mount Type

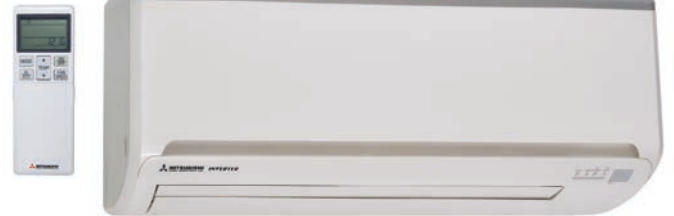

Model		SRK20ZMA-S	SRK25ZMA-S	SRK35ZMA-S	SRK50ZMA-S	
Cooling capacity	kW	2.0	2.5	3.5	5.0	
Heating capacity		3.0	3.4	4.5	5.8	
Sound power level*	Cooling	dB(A)	49	50	58	60
	Heating		52	55	59	61
Sound pressure level*	Cooling	dB(A)	Hi: 33 Me: 27 Lo: 24 UL0: 21	Hi: 34 Me: 28 Lo: 24 UL0: 21	Hi: 42 Me: 32 Lo: 26 UL0: 22	Hi: 46 Me: 37 Lo: 28 UL0: 25
	Heating		Hi: 38 Me: 31 Lo: 24 UL0: 21	Hi: 39 Me: 31 Lo: 24 UL0: 21	Hi: 43 Me: 37 Lo: 25 UL0: 22	Hi: 45 Me: 37 Lo: 31 UL0: 27
Airflow	Indoor	Cooling	Hi: 130 Me:93 Lo:88 UL0: 80	Hi: 132 Me:100 Lo:88 UL0: 83	Hi: 168 Me:107 Lo:90 UL0: 83	Hi: 188 Me:130 Lo:100 UL0: 88
		Heating	Hi: 163 Me:105 Lo:83 UL0: 75	Hi: 177 Me:108 Lo:85 UL0: 77	Hi: 213 Me: 157 Lo:102 UL0: 80	Hi: 225 Me:170 Lo:125 UL0: 103
Exterior dimensions (HxWxD)		mm	294x798x229			
Net weight		kg	9.5			
Clean filter			Allergen Clear Filter x 1, Photocatalytic Washable Deodorizing Filter x 1			
Piping	Liquid line	mm	Ø6.35			
	Gas line		Ø9.52	Ø12.7		
OUTDOOR UNITS TO BE COMBINED			SCM40~125ZM-S		SCM50~125ZM-S	

SRK-ZMA-S

Wall Mount Type



Model		SRK71ZMA-S	
Cooling capacity		kW	7.1
Heating capacity			8.0
Sound power level*	Cooling	dB(A)	60
	Heating		61
Sound pressure level*	Cooling	dB(A)	Hi: 49 Me: 45 Lo: 39 UL0: 26
	Heating		Hi: 46 Me: 43 Lo: 38 UL0: 35
Airflow	Indoor	Cooling	Hi: 325 Me: 292 Lo: 233 UL0: 133
		Heating	Hi: 358 Me: 325 Lo: 258 UL0: 233
Exterior dimensions (HxWxD)		mm	318x1098x248
Net weight		kg	15
Clean filter		Allergen Clear Filter x 1, Photocatalytic Washable Deodorizing Filter x 1	
Piping	Liquid line	mm	Ø6.35
	Gas line		Ø12.7
OUTDOOR UNITS TO BE COMBINED			SCM100~125ZM-S

SRF-ZMXA-S

Floor Type

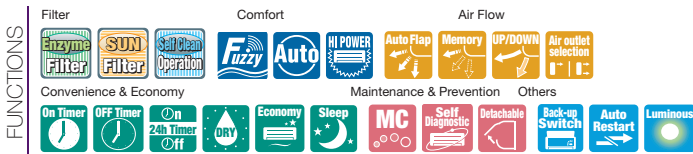

Model		SRF25ZMXA-S		SRF35ZMXA-S		SRF50ZMXA-S	
Cooling capacity		kW		2.5	3.5	5.0	
Heating capacity				3.4	4.5	5.8	
Sound power level*	Cooling	dB(A)	51		52	58	
	Heating		51		52	58	
Sound pressure level*	Cooling	dB(A)	Hi: 40 Me: 32 Lo: 29 UL0: 26		Hi: 41 Me: 34 Lo: 32 UL0: 28	Hi: 46 Me: 42 Lo: 35 UL0: 32	
	Heating		Hi: 40 Me: 35 Lo: 33 UL0: 28		Hi: 41 Me: 36 Lo: 35 UL0: 31	Hi: 47 Me: 41 Lo: 39 UL0: 33	
Airflow	Indoor	Cooling	Hi: 150 Me: 127 Lo: 112 UL0: 97		Hi: 153 Me: 130 Lo: 122 UL0: 107	Hi: 192 Me: 160 Lo: 123 UL0: 110	
		Heating	Hi: 175 Me: 137 Lo: 128 UL0: 110		Hi: 178 Me: 138 Lo: 135 UL0: 123	Hi: 200 Me: 167 Lo: 157 UL0: 127	
Exterior dimensions (HxWxD)		mm		600X860X238			
Net weight		kg		18	19	19	
Clean filter		Allergen Clear Filter x 1, Photocatalytic Washable Deodorizing Filter x 1					
Piping	Liquid line	mm	Ø6.35				
	Gas line		Ø9.52		Ø12.7		
OUTDOOR UNITS TO BE COMBINED			SCM40~125ZM-S		SCM50~125ZM-S		

FDTC-VF

4Way Compact Ceiling Cassette Type



FUNCTIONS

- Comfortable:** Fuzzy, Auto
- Comfortable Air Flow:** HI POWER, Auto Flap, Memory, UP/DOWN
- Maintenance & Prevention:** MC, Self Diagnostic
- Convenience & Economy:** On Timer, OFF Timer, On 24h Timer Off, DRY, Sleep
- Others:** Back-up Switch, Auto Restart, 24-HOUR, Luminous

Remote control (Options)

Wired



RC-EX1A



RC-E5



RCH-E3

Wireless



RCN-TC-24W-ER

Model			FDTC25VF	FDTC35VF	FDTC50VF	FDTC60VF	
Cooling capacity		kW	2.5	3.5	5.0	6.0	
Heating capacity			3.4	4.5	5.8	6.8	
Sound power level*		dB(A)	Cooling	56	58	60	60
			Heating	56	58	60	60
Sound pressure level*		dB(A)	Cooling	P-Hi: 38 Hi: 36 Me: 32 Lo: 29	P-Hi: 41 Hi: 40 Me: 36 Lo: 30	P-Hi: 47 Hi: 42 Me: 36 Lo: 30	P-Hi: 47 Hi: 46 Me: 39 Lo: 30
			Heating	P-Hi: 39 Hi: 38 Me: 33 Lo: 29.5	P-Hi: 43 Hi: 42 Me: 35 Lo: 32	P-Hi: 47 Hi: 42 Me: 36 Lo: 32	P-Hi: 47 Hi: 46 Me: 39 Lo: 32
Airflow	Indoor	l/s	Cooling	P-Hi: 167 Hi: 150 Me: 133 Lo: 108	P-Hi: 183 Hi: 158 Me: 150 Lo: 117	P-Hi: 225 Hi: 192 Me: 150 Lo: 117	P-Hi: 225 Hi: 225 Me: 167 Lo: 117
			Heating	P-Hi: 175 Hi: 158 Me: 142 Lo: 117	P-Hi: 192 Hi: 167 Me: 150 Lo: 133	P-Hi: 225 Hi: 192 Me: 150 Lo: 133	P-Hi: 225 Hi: 225 Me: 167 Lo: 133
Exterior dimensions (HxWxD)		Unit	248x570x570				
		Panel	35x700x700				
Net weight		Unit	15				
		Panel	3.5				
Piping		Liquid line	Ø6.35				
		Gas line	Ø9.52		Ø12.7		
OUTDOOR UNITS TO BE COMBINED			SCM40~125ZM-S		SCM50~125ZM-S	SCM60~125ZM-S	

FDEN-VF

Ceiling Suspended



FUNCTIONS

- Comfortable:** Fuzzy, Auto
- Comfortable Air Flow:** Auto Flap, Memory, UP/DOWN
- Maintenance & Prevention:** MC, Self Diagnostic
- Convenience & Economy:** On Timer, OFF Timer, On 24h Timer Off, DRY, Sleep
- Others:** Back-up Switch, Auto Restart

Remote control (Options)

Wired



RC-EX1A



RC-E5



RCH-E3

Wireless



RCN-E1R

Model			FDEN50VF
Cooling capacity		kW	5.0
Heating capacity			5.8
Sound power level*		dB(A)	60
Sound pressure level*		dB(A)	P-Hi: 46 Hi: 39 Me: 38 Lo: 37
Airflow	Indoor	l/s	P-Hi: 183 Hi: 167 Me: 150 Lo: 117
Exterior dimensions (HxWxD)		mm	210x1070x690
Net weight		kg	28
Air filter			Pocket Plastic net x 2 (Washable)
Piping		mm	Ø6.35
			Ø12.7
OUTDOOR UNITS TO BE COMBINED			SCM50~125ZM-S

FDUM-VF

Duct Connected-Low or Middle Static Pressure



FUNCTIONS

Comfortable: Fuzzy, Auto

Convenience & Economy: On Timer, OFF Timer, On 24h Timer Off, DRY, Sleep

Maintenance & Prevention: MC, Self Diagnostic

Others: Back-up Switch, Auto Restart



Remote control (Options)

Wired: RC-EX1A, RC-E5, RCH-E3

Wireless: RCN-KIT3-E

Model			FDUM50VF	
Cooling capacity		kW	5.0	
Heating capacity		kW	5.8	
Sound power level*		dB(A)	60	
Sound pressure level*		dB(A)	P-Hi: 37 Hi: 32 Me: 29 Lo: 26	
Airflow	Indoor	Cooling	I/s	
		Heating		
			P-Hi: 217 Hi: 167 Me: 150 Lo: 133	
Exterior dimensions (HxWxD)		mm	280x750x635	
Net weight		kg	29	
Drain pump			Built-in	
Piping	Liquid line	mm	Ø6.35	
	Gas line		Ø12.7	
OUTDOOR UNITS TO BE COMBINED			SCM50~125ZM-S	

SRR-ZM-S

Ceiling Concealed Type

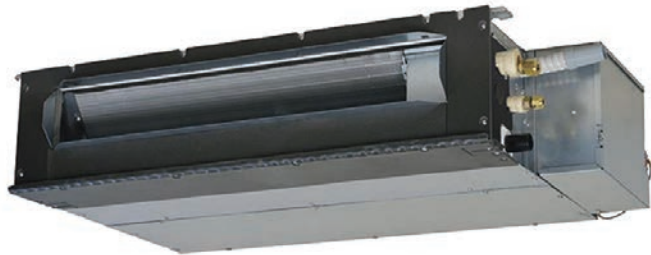

FUNCTIONS

Comfortable: Self Clean Operation, Fuzzy, Auto, HI POWER

Convenience & Economy: On Timer, OFF Timer, On 24h Timer Off, DRY, Economy, Sleep, Silent, Night setback 10°C

Maintenance & Prevention: MC, Self Diagnostic

Others: Back-up Switch, Auto Restart, Luminous

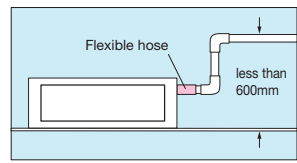

Remote control Wireless



Model			SRR25ZM-S	SRR35ZM-S	SRR50ZM-S	SRR60ZM-S
Cooling capacity		kW	2.5	3.5	5.0	6.0
Heating capacity		kW	3.4	4.5	5.8	6.8
Sound power level*	Cooling	dB(A)	56	57	59	60
	Heating		59	60	61	63
Sound pressure level*	Cooling	dB(A)	Hi: 37 Me: 33 Lo: 30 ULo: 24	Hi: 38 Me: 34 Lo: 31 ULo: 25	Hi: 41 Me: 37 Lo: 34 ULo: 29	Hi: 44 Me: 38 Lo: 35 ULo: 30
	Heating		Hi: 40 Me: 37 Lo: 34 ULo: 28	Hi: 41 Me: 38 Lo: 35 ULo: 29	Hi: 43 Me: 39 Lo: 37 ULo: 32	Hi: 45 Me: 41 Lo: 38 ULo: 33
Airflow	Indoor	Cooling	Hi: 158 Me: 142 Lo: 108 ULo: 75	Hi: 167 Me: 142 Lo: 117 ULo: 83	Hi: 225 Me: 183 Lo: 167 ULo: 125	Hi: 242 Me: 192 Lo: 175 ULo: 133
		Heating	Hi: 167 Me: 150 Lo: 133 ULo: 100	Hi: 175 Me: 158 Lo: 142 ULo: 108	Hi: 242 Me: 208 Lo: 183 ULo: 142	Hi: 250 Me: 217 Lo: 192 ULo: 150
Exterior dimensions (HxWxD)		mm	200x750x500		200x950x500	
Net weight		kg	20.5		24	
Drain pump			Built-in			
Piping	Liquid line	mm	Ø6.35			
	Gas line		Ø9.52		Ø12.7	
OUTDOOR UNITS TO BE COMBINED			SCM40~125ZM-S		SCM50~125ZM-S	SCM60~125ZM-S

Outdoor Unit Dimensions.

Models SCM40ZM-S

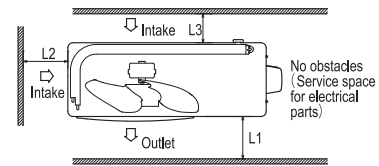
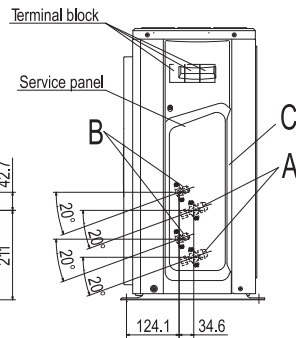
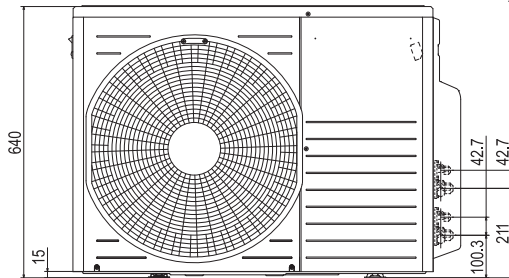
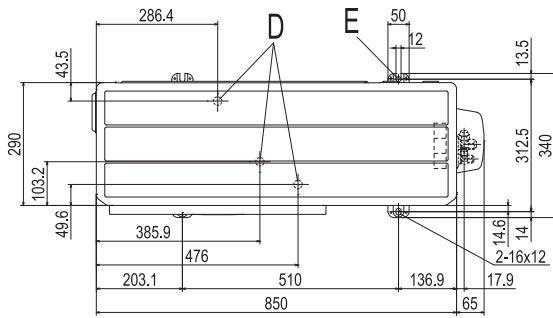

Minimum installation space

Dimensions	Examples of Installation	∅
L1		600
L2		100
L3		100

Unit:mm

Symbol	Content	
A	Service valve connection (gas side)	φ 9.52 (3/8") Flare
B	Service valve connection (liquid side)	φ 6.35 (1/4") Flare
C	Pipe / cable draw-out hole	
D	Drain discharge hole	φ 20 x 3 places
E	Anchor bolt hole	M10 x 4 places

Note

- (1) It must not be surrounded by walls on four sides.
- (2) The unit must be fixed with anchor bolts. An anchor bolt must not protrude more than 15mm.
- (3) Where the unit is subjected to strong winds, lay it in such a direction that the blower outlet faces perpendicularly to the dominant wind direction.
- (4) Leave 1.2m or more space above the unit.
- (5) A wall in front of the blower outlet must not exceed the unit's height.
- (6) The model name label is attached on the service panel.

Models SCM50ZM-S1, 60ZM-S1

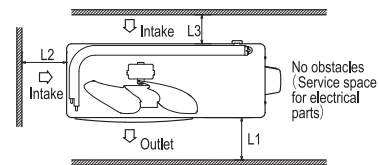
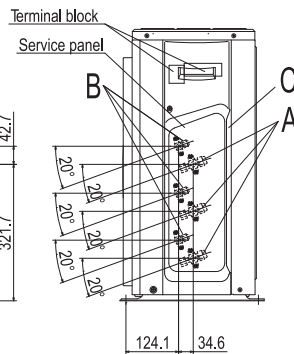
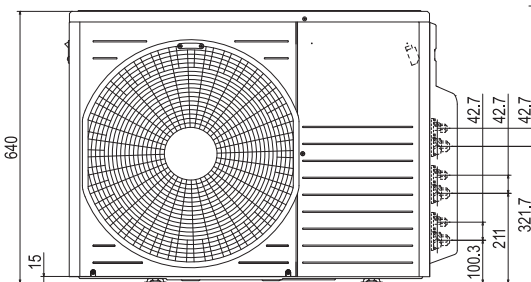
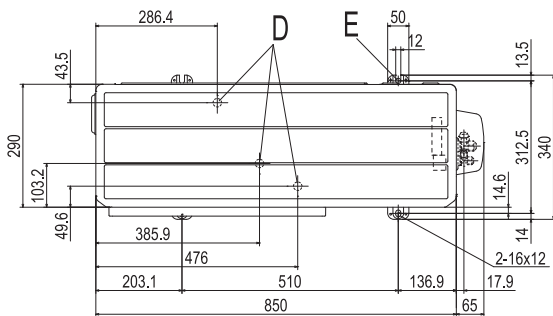

Minimum installation space

Dimensions	Examples of Installation	∅
L1		600
L2		100
L3		100

Unit:mm

Symbol	Content	
A	Service valve connection (gas side)	φ 9.52 (3/8") Flare
B	Service valve connection (liquid side)	φ 6.35 (1/4") Flare
C	Pipe / cable draw-out hole	
D	Drain discharge hole	φ 20 x 3 places
E	Anchor bolt hole	M10 x 4 places

Note

- (1) It must not be surrounded by walls on four sides.
- (2) The unit must be fixed with anchor bolts. An anchor bolt must not protrude more than 15mm.
- (3) Where the unit is subjected to strong winds, lay it in such a direction that the blower outlet faces perpendicularly to the dominant wind direction.
- (4) Leave 1.2m or more space above the unit.
- (5) A wall in front of the blower outlet must not exceed the unit's height.
- (6) The model name label is attached on the service panel.

Before starting use

Heating performance

The heating performance values (kW) described in catalog are the values obtained by operating at an outdoor temperature of 7C and indoor temperature of 20C as set forth in the ISO Standards. As the heating performance decreases as the outdoor temperature drops, if the outdoor temperature is too low and the heating performance is insufficient, use other heating appliances as well.

Indication of sound values

The sound values are the values (A scale) measured in a chamber such as an anechoic chamber following the ISO Standards. In the actual installation state, the value is normally larger than the values given in the catalog due to the effect of surrounding noise and echo. Take this into consideration when installing.

Use in oil atmosphere

Avoid installing this unit in an atmosphere where oil scatters or builds up, such as in a kitchen or machine factory.

If the oil adheres to the heat exchanger, the heat exchanging performance will drop, mist may be generated, and the synthetic resin parts may deform and break.

Use in acidic or alkaline atmosphere

If this unit is used in acidic atmosphere such as hot spring areas having high level of sulfuric gases or in alkaline atmosphere including ammonia or calcium chloride, places where the exhaust of the heat exchanger is sucked in, or at coastal areas where the unit is subject to salt breezes, the outer plate or heat exchanger, etc., will corrode. Please ask a dealer or specialist when you use an air conditioner in places differing from a general atmosphere.

Use in places with high ceilings

If the ceiling is high, install a circulator to improve the heat and air flow distribution when heating.

Refrigerant leakage

The refrigerant (R410A) used for Air conditioner is non-toxic and nonflammable in its original state.

However, in consideration of a state where the refrigerant leaks into the room, measures against refrigerant leaks must be taken in small rooms where the tolerable level could be exceeded. Take measures by installing ventilation devices, etc.

Use in snowy areas

Take the following measures when installing the outdoor unit in snowy areas.

Snow prevention

Install a snow-prevention hood so that the snow does not obstruct the air intake port or enter and freeze in the outdoor unit.

Snow piling

In areas with heavy snow fall, the piled snow could block the air intake port. In this case, a frame that is 50cm or higher than the estimated snow fall must be installed underneath the outdoor unit.

Automatic defrosting device

If the temperature is low, and the humidity is high, frost will stick to the heat exchanger of the outdoor unit. If use is continued, the heating performance will drop.

The "Automatic defrosting device" will function to remove this frost. After heating for approx, three to ten minutes, it will stop, and the frost will be removed. After defrosting, hot air will be blown again.

Servicing the air-conditioner

After the air-conditioner is used for several seasons, dirt will build up in the air-conditioner causing the performance to drop. In addition to regular servicing, we recommend the maintenance contract (charged for) by a specialist.

⚠ Safety Precautions

Air-conditioner usage target

The air-conditioner described in this catalog is a dedicated cooling/heating device for human use.

Do not use it for special applications such as the storage of foodstuffs, animals or plants, computer server rooms, precision devices or valuable art, etc.

This could cause the quality of the items to drop, etc.

Do not use this for cooling vehicles or ships. Water leakage or current leaks could occur.

Before use

Always read the "User's Manual" thoroughly before starting use.

Installation

Always commission the installation to a dealer or specialist. Improper installation will lead to water leakage, electric shocks and fires.

Make sure that the outdoor unit is stable in installation. Fix the unit to stable base.

Usage place

Do not install in places where combustible gas could leak or where there are sparks.

Installation in a place where combustible gas could be generated, flow or accumulate, or places containing carbon fibers could lead to fires.

Only persons that are qualified and licensed are permitted to install and service products that contain refrigerants in Australia, go to www.arctick.org. Suitable access for service must be provided in compliance with industry standards and local regulations.



Australia: ABN 92 133 980 275

Phone: 1300 138 007 Fax: 1800 644 329

NSW & Head Office

9C Commercial Road
Kingsgrove NSW 2208
PO Box 318 Kingsgrove
NSW 1480

Victoria

2/15 Howleys Road
Notting Hill
VIC 3168

Brisbane

5/26 Flinders Parade
North Lakes
QLD 4509

Townsville

12/31 Fleming Street
Aitkenvale
QLD 4812
PO Box 1386 Aitkenvale
QLD 4814

Western Australia

Unit 3A 2 Mulgool Rd
Malaga WA 6090
PO Box 2089 Malaga
WA 6944

www.mhiala.com.au

New Zealand: G.S.T. 105-673-620

Phone: 0800 138 007 Fax: 09 5799 665

Auckland

698A Great South Road,
Penrose, 1061
PO Box 112310,
Penrose 1642

www.mhiala.co.nz

MRE SPARE PARTS

www.mrespareparts.com.au

Tel: +61 (0) 2 9600 7444

Fax: +61 (0) 2 9600 8044

Our factories are ISO9001 and ISO14001 certified.

Certified ISO 9001



BIWAJIMA PLANT
Mitsubishi Heavy Industries, Ltd.
Air-conditioning & Refrigeration Systems Headquarters
Certificate number: JQA 0709



MITSUBISHI HEAVY INDUSTRIES-
MAHAJAK AIR CONDITIONERS CO., LTD.
Certificate Number: 04110 1988 0813



Mitsubishi Heavy
Industries-Haier (Guangdong)
Air-conditioners Co., Ltd.
Certificate Number: 5170-1996-40-RCC-RuA

Certified ISO 14001



BIWAJIMA PLANT
Mitsubishi Heavy Industries, Ltd.
Air-conditioning & Refrigeration Systems Headquarters



MITSUBISHI HEAVY INDUSTRIES-
MAHAJAK AIR CONDITIONERS CO., LTD.
Certificate Number: 04104 1988 0813 ES



Mitsubishi Heavy
Industries-Haier (Guangdong)
Air-conditioners Co., Ltd.
Certificate number: 01-1998-083



(COMPANY) participates in the ECC
programme for (PROGRAMME).
Check ongoing validity of certificate:
www.eurovent-certification.com or
www.certiflash.com @certiflash



Because of our policy of continuous improvement, we reserve the right to make changes in all specifications without notice. E&OE.