

**SENSI WI-FI THERMOSTAT – REMOTE ACCESS  
FROM SMARTPHONE, TABLET OR PC**

Sensi App Connects Thermostat to Home Wi-Fi Router – No Additional Accessories/Gateway Required

**1F86U-42WF****FEATURES**

- Easy to install. Simple to connect.
- No “C wire” required for most HVAC applications – for faster and easier installs.
- Keeps your contact information in your customer’s smartphone or tablet – so you are just a tap away when service is needed.
- Sensi Thermostat operates like a standard thermostat when not connected to Wi-Fi.
- 5-Year Limited Warranty.

**SPECIFICATIONS**

Electrical Rating:

Battery Power..... 0 to 30 VAC, 50/60 Hz or DC  
Terminal Load..... 0.05 to 1.5 Amps (load per terminal)  
1.5 Amps maximum load  
(all terminals combined)

Setpoint Range..... 45 to 99°F (7 to 37°C)

Rated Differentials:

|  | Fast  | Med.  | Slow  |
|--|-------|-------|-------|
| Heat (Single Stage/ Multi-Stage) ..... | 0.4°F | 0.6°F | 1.7°F |
| Cool (Single Stage/Multi-Stage) .....  | 0.9°F | 1.2°F | 1.7°F |
| Heat Pump.....                         | 0.9°F | 1.2°F | 1.7°F |
| Aux. Heat.....                         | 0.6°F |       | 1.7°F |

Operating Humidity..... 90% non-condensing max.  
Standard Systems..... Single Stage gas, oil, electric  
Single Stage heat pump  
Multi-Stage gas, oil, electric  
Multi-Stage heat pump

Dimension..... 3<sup>3</sup>/<sub>4</sub>" H x 5<sup>14</sup>/<sub>16</sub>" W x 1<sup>2</sup>/<sub>16</sub>" D

**PARTS AND ACCESSORIES** See end of thermostats section for additional parts and accessories

- F29-0198 — Thermostat Guards – Clear
- F61-2663 — Wallplate 6<sup>3</sup>/<sub>4</sub>" W x 4<sup>1</sup>/<sub>2</sub>" H

**TECHNICAL HELP**

Connection and Configuration..... See pages 128–129

**UNIVERSAL – 4 HEAT / 2 COOL SENSI WI-FI THERMOSTAT**

| Single Stage | Multi-Stage | Heat Pump | Programs | Model      | Applications         |                   |                      | Thermostat Power Source* | Selectable Performance Features |                  |              |                      |                              |                |                      | Comfort and Convenience Features |                  |                       |                            | Terminals |   |
|--------------|-------------|-----------|----------|------------|----------------------|-------------------|----------------------|--------------------------|---------------------------------|------------------|--------------|----------------------|------------------------------|----------------|----------------------|----------------------------------|------------------|-----------------------|----------------------------|-----------|---|
|              |             |           |          |            | Gas / Oil / Electric | 3 Wire Zone Valve | Millivolt Compatible |                          | Auto Changeover                 | Programmable Fan | Energy Aware | Early Start Recovery | Dual Fuel Heat Stages HP/Gas | Keypad Lockout | Indoor Remote Sensor | Outdoor Remote Sensor            | Selectable °F/°C | Room Humidity Display | Setpoint Temperature Limit |           | Lighted Display†                        |
| 1/1          | 2/2         | 4/2       | 7-day, Ø | 1F86U-42WF | ✓                    |                   |                      | B, H<br>PA               | ✓                               |                  | ✓            | ✓                    | 2/2                          |                |                      |                                  | ✓                | ✓                     | ✓                          | ✓         | RC, RH, C, W/E, W2,<br>Y, Y2, O/B, G, L |

\* B = Battery Powered  
H = Hardwired (Requires Common)  
PA = Power Stealing Battery Assist

† = Optional Continuous Display Light with "C Wire" Connection

# TOP TEN

Ways to catch the Wi-Fi wave with the Sensi™ thermostat & mobile app

**10** **INSTALLS LIKE A STANDARD THERMOSTAT**  
Connect it to the internet or simply install Sensi and let the homeowner connect it at their convenience.

**9** **CONNECTS WITH A SMARTPHONE**  
Step-by-step instructions make it easy to install and pair Sensi to the home router.

**8** **NO C WIRE NEEDED ON MOST SYSTEMS**  
Walk in the door knowing Sensi will work – even in most of the 60% of homes that don't have a common wire.

**7** **COMPLETE COMFORT CONTROL FOR ANY CUSTOMER**  
Sensi is priced to make Wi-Fi thermostats a reality for all customers not just the high-end homeowner.

**6** **NO FOLLOW UP CALL**  
Not only is Sensi easy to use, it meets Energy Aware™ standards for precision, reliability and accurate control.

**5** **MORE REPEAT BUSINESS**  
Be one touch away when your customer needs service with your company information stored in the Sensi mobile app.



**4** **PROMOTE YOUR BUSINESS**  
Get customer referrals when you register for the Sensi Branding Program. Visit [SensiRegistration.com](http://SensiRegistration.com) to sign up today.

**3** **ENHANCE YOUR REPUTATION**  
Consumers are looking for Wi-Fi thermostats. Offer them Sensi so they don't have to look any further.

**2** **GROW YOUR THERMOSTAT SALES**  
Three out of four homes have Wi-Fi. Now there's a thermostat simple enough for all of them.

**1** **EMPOWER YOUR CUSTOMER TO TAKE CONTROL OF THEIR HOME COMFORT. THEY WILL THANK YOU FOR IT!**

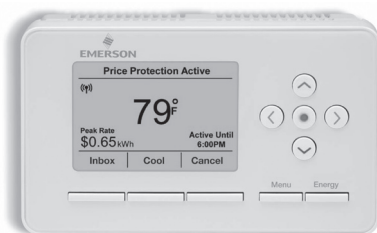

## EE542-1Z

### DISPLAY MENU

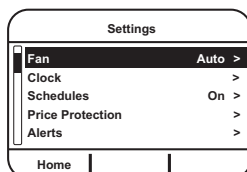

Intuitive menu design and familiar 5-way navigation pad make this one of the easiest to use energy management products on the market.

### ENERGY MONITOR

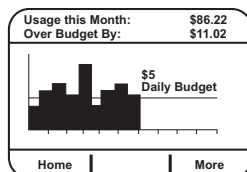

Large, crisp, dot matrix display makes it easy for customers to track their energy use against a monthly budget.

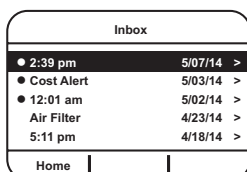

Message inbox with unread mail notification provides an easy way for utilities to stay in touch with customers.

## PROGRAMMABLE THERMOSTAT AND WHOLE HOME ENERGY MONITOR

The Smart Energy Thermostat is Much More than a Thermostat. It Wirelessly Pairs with Your Customer's Smart Meter to Provide Unprecedented Insight into Whole Home Electricity Usage – which Enables Your Customers to Reduce Their Utility Bills by Making Better Decisions About how and when to Use Electricity

### FEATURES

- Title 24 compliant per new residential building code in CA.
- Universal HVAC system compatibility (4 heat / 2 cool).
- 7 day programming flexibility.
- Patented sensor-less dual fuel capability.
- Large backlit dot-matrix display (5 sq." ) for optimal readability.
- +/- 1° temperature control accuracy ensures consistent comfort.
- One touch AWAY key instantly engages away mode to help save money.
- Energy monitor allows customer to set a monthly budget for whole home electricity use and then track daily usage costs against it to help reduce energy costs\*.
- Current price of electricity presented on the home screen and tri-color LED lets customer know when the price of electricity is higher than normal\*.
- Price Protection™ can be configured to automatically adjust the temperature in home when the price of electricity is high\*.
- Month to date heating and cooling cost estimates\*.
- Message Inbox enables customer to receive important information from utility provider (i.e. notification of potential disruption to power supply).
- Requires C-wire for power (no batteries required).

\* Feature requires utility to push electricity pricing data through the smart meter (via ZigBee SE Price Cluster).

### SPECIFICATIONS

Electrical Rating:

Hardwire ..... 20 to 30 VAC

Terminal Load ..... 1.5A per terminal, 2.0A maximum all terminals combined

Setpoint Range ..... 45 to 99°F (7 to 37°C)

Rated Differentials: ..... Heat 0.6°F; Cool 1.2°F

Operating Humidity ..... 90% non-condensing maximum

### PARTS AND ACCESSORIES

 See end of thermostats section for additional parts and accessories

### TECHNICAL HELP

Connections ..... See page 130



Smart Energy 1.1



ZigBee  
Certified product

| Single Stage | Multi-Stage | Heat Pump | Programs | Model    | Applications         |                   |                      | Interface Power Source* | Selectable Performance Features |                  |                      |                   |                | Comfort and Convenience Features |                 |                  |                       | Terminals |                                      |
|--------------|-------------|-----------|----------|----------|----------------------|-------------------|----------------------|-------------------------|---------------------------------|------------------|----------------------|-------------------|----------------|----------------------------------|-----------------|------------------|-----------------------|-----------|--------------------------------------|
|              |             |           |          |          | Gas / Oil / Electric | 3 Wire Zone Valve | Millivolt Compatible |                         | Auto Changeover                 | Programmable Fan | Energy Mgt. Recovery | Dual Fuel Control | Keypad Lockout | Display Size (Square inches)     | Lighted Display | Audible Feedback | Ignition Module Reset |           | Permanent Memory                     |
| 1/1          | 2/2         | 4/2       | 7, 0     | EE542-1Z | ✓                    |                   |                      | H                       | ✓                               |                  | ✓                    | ✓                 | ✓              | 6.0                              | ✓               | ✓                | ✓                     | ✓         | RC, RH, C, W/E, W2, Y, Y2, O/B, G, L |

\* H = Hardwired (Requires Common)



**1HDEZ-1521**  
Includes User Interface and  
Equipment Control

**INSPIRE™ UNIVERSAL 4-WIRE COLOR  
THERMOSTAT SYSTEM**

Upgrade Single Stage Applications to Premium High-Efficiency Systems (Staging, Heat Pump or Heat Pump with Dual Fuel) – Using Existing 4 Wires

**FEATURES**

- Reusable plug-in configuration tool – eliminates multiple trips up and down stairs during set up and system testing.
- USB port to quickly upload your favorite Installation Settings, Programs and personalized Company Contact Information.
- 5/8" thin profile with vibrant color display.
- Color coded LEDs provide positive feedback for easy setup.
- Dehumidification, humidification.

**DIMENSION**

Interface ..... 3 1/4" H x 6 1/8" W x 5/8" D  
Control ..... 5 1/2" H x 5 3/4" W x 1 1/2" D

**SPECIFICATIONS**

Electrical Rating:  
Hardwire ..... 20-30 VAC, NEC Class II 50/60Hz or DC  
Terminal Load ..... 1.5 A per terminal,  
2.5 A maximum load (all terminals combined)  
Setpoint Range ..... 45 to 99°F (7 to 37°C)  
Rated Differential ..... Heat 0.6°F; Cool 1.2°F  
Operating Ambient ..... 32 to +105°F (0 to +41°C) – Interface  
-30 to +150°F (-34 to 66°C) – Control  
Operating Humidity Range ..... 90% non-condensing maximum

**PARTS AND ACCESSORIES**

See end of thermostats section for additional parts and accessories

- F4-1400 — Thermostat Plug-in Configuration Tool
- F145-1378 — Outdoor Remote Sensor
- F29-0198 — Locking Thermostat Guard - Clear Plastic
- F29-0220 — Locking Thermostat Guard - Metal, Solid Base
- F29-0222 — Locking Thermostat Guard - Metal, Ring Base



**TECHNICAL HELP**

Connections..... See page 127

**INSPIRE™ UNIVERSAL 4-WIRE COLOR THERMOSTAT SYSTEM**

| Single Stage | Multi-Stage | Heat Pump | Programs        |                         | Model      | Applications |                      |                   |                      | Selectable Performance Features                |                          |                 |                  |              |  |  |                              |  |                                      | Terminals |  |  |
|--------------|-------------|-----------|-----------------|-------------------------|------------|--------------|----------------------|-------------------|----------------------|--|--------------------------|-----------------|------------------|--------------|--|--|------------------------------|--|--------------------------------------|-----------|--|--|
|              |             |           | Program Options | Periods per day Options |            | Model Number | Gas / Oil / Electric | 3 Wire Zone Valve | Millivolt Compatible | Humidity Control (H)-Humidity / (D)-Dehumidity | Thermostat Power Source* | Auto Changeover | Programmable Fan | Energy Aware | Comfort Alert® A.C. System Protection (P)-Passive/(A)-Active\$ | Dual Fuel Heat Pump Control (L)-Logic/(O)-Outdoor Sensor | Dual Fuel Heat Stages HP/Gas | Aux. Heat Lockout with Outdoor Sensor♦ | Keypad Lockout (T)-Total/(P)-Partial |           | Setpoint Temperature Limits Adjustable Max./Min. | Indoor Remote Sensors Max. Number + Thermostat Average and/or Weighted                               |
| 1/1          | 2/2         | 4/2       | 7, 0            | 4, 0                    | 1HDEZ-1521 | ✓            |                      |                   | H, D                 | H  | ✓                        | ✓               | A                | 0†           | 2/2  | ✓  |                              | ✓                                      |                                      | 1         | 5.5  | RC, RH, C, W/E, W2, Y, Y2, O/B, G, L, +, S, -, DHM, DHM2, HM, HM2, R, 1, 2, C- Thermostat 1, 2, C, R |

\*H = Hardwired (Requires Common)

♦ When used with an outdoor sensor provides options to lock out auxiliary heat above selected outdoor temperature.

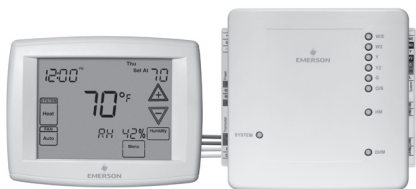
**1F98EZ-1421**

Includes User Interface and Equipment Control

**1F98EZ-1441**

Includes User Interface, Equipment Control and Outdoor Remote Sensor (F145-1378)

## 12" TOUCHSCREEN UNIVERSAL 4-WIRE THERMOSTAT SOLUTION

Upgrade Single Stage Applications to Premium High-Efficiency Systems (Staging, Heat Pump or Heat Pump with Dual Fuel) – Using Existing 4 Wires Dual Fuel Heat Pump Control (Requires Outdoor Remote Sensor)

### FEATURES

- Reusable plug-in configuration tool – eliminates multiple trips up and down stairs during set up and system testing. (F4-1400 available separately)
- Color coded LEDs provide positive feedback for easy setup.
- Programmable fan.
- Dual fuel heat pump.
- Outdoor sensor included (1F98EZ-1441 only).

### DIMENSION

|                     |                                |
|---------------------|--------------------------------|
| Interface . . . . . | 4 1/2" H x 3" W x 1 1/4" D     |
| Control . . . . .   | 5 1/2" H x 5 3/4" W x 1 1/2" D |

### SPECIFICATIONS

|                                    |  |
|------------------------------------|--|
| Electrical Rating:                 |  |
| Hardwire . . . . .                 | 20-30 VAC, NEC Class II 50/60Hz or DC  |
| Terminal Load . . . . .            | 1.5 A per terminal,<br>2.5 A maximum load (all terminals combined)             |
| Setpoint Range . . . . .           | 45 to 99°F (7 to 37°C)   |
| Rated Differential . . . . .       | Heat 0.6°F; Cool 1.2°F   |
| Operating Ambient . . . . .        | 32 to +105°F (0 to +41°C) – Interface<br>-30 to +150°F (-34 to 66°C) – Control |
| Operating Humidity Range . . . . . | 90% non-condensing maximum   |

### PARTS AND ACCESSORIES

 See end of thermostats section for additional parts and accessories

- F4-1400 — Thermostat Plug-in Configuration Tool
- F145-1378 — Outdoor Remote Sensor
- F61-2600 — Wallplate 8 1/8" W X 5 3/8" H
- F61-2634 — Wallplate 6 1/2" W x 5" H
- F29-0198 — Locking Thermostat Guard - Clear Plastic
- F29-0220 — Locking Thermostat Guard - Metal, Solid Base
- F29-0222 — Locking Thermostat Guard - Metal, Ring Base

## 12" TOUCHSCREEN UNIVERSAL 4-WIRE THERMOSTAT SOLUTION

| Single Stage | Multi-Stage | Heat Pump | Programs                   |                 | Model                                 | Applications            |              |                      |                   |                      |                        | Selectable Performance Features                |                          |                 |                  |              |   |  |                              |                                       |                                      | Terminals |  |  |
|--------------|-------------|-----------|----------------------------|-----------------|---------------------------------------|-------------------------|--------------|----------------------|-------------------|----------------------|------------------------|--|--------------------------|-----------------|------------------|--------------|---|--|------------------------------|---------------------------------------|--------------------------------------|-----------|--|--|
|              |             |           | Stages Heat/Cool by System | Program Options |                                       | Periods per day Options | Model Number | Gas / Oil / Electric | 3 Wire Zone Valve | Millivolt Compatible | Outdoor Remote Sensing | Humidity Control (H)-Humidity / (D)-Dihumidity | Thermostat Power Source* | Auto Changeover | Programmable Fan | Energy Aware | Comfort Alert®<br>A.C. System Protection (P)-Passive/(A)-Active | Dual Fuel Heat Pump Control (L)-Logic/(O)-Outdoor Sensor | Dual Fuel Heat Stages HP/Gas | Aux. Heat Lockout with Outdoor Sensor | Keypad Lockout (T)-Total/(P)-Partial |           | Setpoint Temperature Limits Adjustable Max./Min. | Indoor Remote Sensors Max. Number + Thermostat Average and/or Weighted |
| 1/1          | 2/2         | 4/2       | 7, 0                       | 4, 0            | 1HDEZ-1421<br>Easy Install™<br>4-Wire | ✓                       |              |                      | ✓                 | H,D                  | H                      | ✓  | ✓                        | ✓               | P                | 0‡           | 2/2   | ✓  |                              | ✓                                     |                                      | 1         | 12   | RC, RH, C, W/E, W2, Y, Y2, O/B, G, L, 6, +, S, -, DHM, DHM2, HM, HM2   |
| 1/1          | 2/2         | 4/2       | 7, 0                       | 4, 0            | 1HDEZ-1441<br>Easy Install™<br>4-Wire | ✓                       |              |                      | ✓                 | H,D                  | H                      | ✓  | ✓                        | ✓               | P                | 0‡           | 2/2   | ✓  |                              | ✓                                     |                                      | 1■        | 12   |  |

\*H = Hardwired (Requires Common)

■ One outdoor remote sensor can be used – F145-1378 included in kit

‡ With an outdoor sensor installed you can select an outdoor temperature to turn the heat pump off and switch to the gas furnace when it's too cold outside for the pump to be efficient.

**1F98EZ-1621**



Comfort Interface



Equipment Control Module



Return Air Sensor (RAS)

**F145RF-1600 Wireless Remote Sensor**



Sold Separately See page 32

**6 SQ. IN. DISPLAY WIRELESS UNIVERSAL WIRELESS THERMOSTAT SYSTEM**

Universal – Compatible with Single and Multi-Stage, Heat Pump and Heat Pump with Dual Fuel Applications. Locate Comfort Interface and Remote Sensors for Optimum Temperature Sensing

**FEATURES**

- Choice of dual fuel control with wireless temperature sensor or by Dual Fuel Logic program in Comfort Interface.
- Color-coded LEDs on Equipment Control validates system wiring.
- Reduces hot and cold spots – add up to 4 wireless sensors (3 indoor and 1 outdoor).
- Meets California Building Code, Title 24.

**DIMENSION**

Comfort Interface . . . . . 4 1/2" H x 6 1/2" W x 1 1/4" D  
 Equipment Control . . . . . 6 1/2" H x 6 1/2" W x 1 1/2" D

**SPECIFICATIONS**

Electrical Rating:

Hardwire . . . . . 20-30 VAC, NEC Class II 50/60Hz or DC  
 Terminal Load . . . . . 1.5 A per terminal,  
 2.5 A maximum load (all terminals combined)

Setpoint Range . . . . . 45 to 99°F (7 to 37°C)  
 Rated Differential: . . . . . Heat 0.6°F; Cool 1.2°F  
 Operating Ambient . . . . . 32 to +105°F (0 to +41°C) – Interface  
 -30 to +150°F (-34 to 66°C) – Control  
 Operating Humidity Range . . . . . 90% non-condensing maximum

**PARTS AND ACCESSORIES**

See end of thermostats section for additional parts and accessories

- F145RF-1600 — Wireless Remote Sensor. See page 32
- F61-2600 — Wallplate 8 1/8" W X 5 3/8" H
- F61-2634 — Wallplate 6 1/2" W x 5" H
- F29-0198 — Locking Thermostat Guard - Clear Plastic
- F29-0220 — Locking Thermostat Guard - Metal, Solid Base
- F29-0222 — Locking Thermostat Guard - Metal, Ring Base



**UNIVERSAL WIRELESS STAGING/HEAT PUMP THERMOSTAT SYSTEM**

| Single Stage | Multi-Stage | Heat Pump | Programs        |                         | Model                              | Applications |                      |                   |                      | Selectable Performance Features                |                          |                 |                  |              |                |   |  |                              |   | Terminals |                                      |  |  |
|--------------|-------------|-----------|-----------------|-------------------------|------------------------------------|--------------|----------------------|-------------------|----------------------|--|--------------------------|-----------------|------------------|--------------|----------------|---|--|------------------------------|---|-----------|--------------------------------------|--|--|
|              |             |           | Program Options | Periods per day Options |                                    | Model Number | Gas / Oil / Electric | 3 Wire Zone Valve | Millivolt Compatible | Humidity Control (H)-Humidity / (D)-Dihumidity | Thermostat Power Source* | Auto Changeover | Programmable Fan | Energy Aware | Comfort Alert® | A.C. System Protection (P)-Passive/(A)-Active | Dual Fuel Heat Pump Control (L)-Logic/(O)-Outdoor Sensor | Dual Fuel Heat Stages HP/Gas | Aux. Heat Lockout with Outdoor Sensor † |           | Keypad Lockout (T)-Total/(P)-Partial | Setpoint Temperature Limits Adjustable Max./Min. | Indoor Remote Sensors Max. Number + Thermostat Average and/or Weighted |
| 1/1          | 2/2         | 4/2       | 7, 0            | 4, 2, 0                 | 1F98EZ-1621 Wireless Easy Install™ | ✓            |                      |                   | H,D                  | B  | ✓                        | ★               | ✓                | P            | L, O ‡         | 2/2   | ✓  | TP                           | ✓                                       | 3+1       | 1 •                                  | 6.0  | R, RC, RH, C, W/E, W2, Y, Y2, O/B, G, L, DHM, DHM2, HM, HM2            |

\* H = Hardwired (Requires Common)  
 B, H = Battery Powered or Hardwired  
 B = Battery Powered  
 PA = Power Saving Battery Assist

♦ When used with an outdoor sensor provides option to lock out auxiliary heat above selected outdoor temperature.  
 ★ Occupancy fan option with selectable pre-purge (1-3 hours)  
 • Up to three indoor and one outdoor wireless sensors can be used – order F145-1600 (sold separately)

‡ With an outdoor sensor installed you can select an outdoor temperature to turn the heat pump off and switch to the gas furnace when it's too cold outside for the pump to be efficient.

# BLUE 12" TOUCHSCREEN THERMOSTATS

White-Rodgers™

24 VOLT

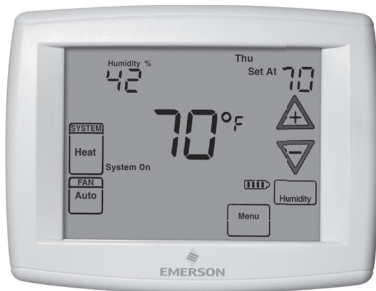
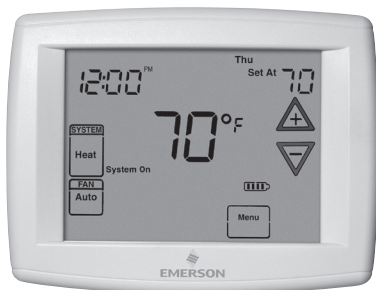
**1F95-1291****1F95-1277****F145-1328  
Indoor Remote Sensor****F145-1378  
Outdoor Remote Sensor**

## BLUE 12" TOUCHSCREEN - UNIVERSAL AND SINGLE STAGE THERMOSTATS - 12 SQ. IN. DISPLAY

Blue Models Offer the Ultimate in Comfort, Features, Performance and Visibility

### FEATURES

- Universal models quickly configure for single stage, multi-stage or heat pump and heat pump dual fuel systems - programmable or non-programmable.
- **Humidity control** offers humidification/dehumidification.
- **Commercial** offers occupied damper or economizer control.
- **Staging** control for nearly all conventional and heat pump systems.
- **Single stage** model compatible with all single stage systems low voltage, 750 mV and 3-wire zone systems.
- Heat Pump dual fuel option eliminates the need for a fossil fuel kit.
- Automatic changeover option.
- Program fan options.
- Keypad lockout and setpoint temperature limit options.
- Indoor remote sensor for averaging option.
- Outdoor remote sensor option. Add to Universal models for outdoor temp reading or, on select models, dual fuel balance point and outdoor thermostat functions.
- Dual power – hardwire and/or battery or Tripower – hardwire and/or battery with system assist.

### SPECIFICATIONS

Electrical Rating:

|                         |  |
|-------------------------|--|
| Hardwire . . . . .      | 20-30 VAC, NEC Class II 50/60Hz            |
| Battery Power . . . . . | mV to 30 VAC, NEC Class II, 50/60 Hz or DC |
| Terminal Load . . . . . | 1.5 A per terminal,                        |
|                         | 2.5 A maximum all terminals combined       |

Setpoint Range . . . . . 45 to 99°F (7 to 37°C)

| Rated Differentials:                      | Fast  | Med.  | Slow  |
|---|-------|-------|-------|
| Heat (Single Stage/Multi-Stage) . . . . . | 0.4°F | 0.6°F | 1.7°F |
| Cool (Single Stage/Multi-Stage) . . . . . | 0.9°F | 1.2°F | 1.7°F |
| Heat Pump . . . . .                       | 0.9°F | 1.2°F | 1.7°F |
| Emer. Heat . . . . .                      | 0.6°F |       | 1.7°F |

Operating Ambient . . . . . 32 to +105°F (0 to +41°C)

Operating Humidity . . . . . 90% non-condensing max.

Shipping Temperature Range . . . . . -4 to +150°F (-20 to 65°C)

Dimension . . . . . 4<sup>9</sup>/<sub>16</sub>" H x 5<sup>13</sup>/<sub>16</sub>" W x 1<sup>13</sup>/<sub>16</sub>" D

### PARTS AND ACCESSORIES See end of thermostats section for additional parts and accessories

- F145-1328 — Indoor remote sensor. See page 33
- F145-1378 — Outdoor remote sensor. See page 33
- F61-2600 — Wallplate 8<sup>1</sup>/<sub>8</sub>" W x 5<sup>3</sup>/<sub>8</sub>" H
- F61-2634 — Wallplate 6<sup>1</sup>/<sub>2</sub>" W x 5" H (or order F61-2648 – 6 pack of F61-2634)
- F29-0198 — Locking Thermostat Guard - Clear Plastic
- F29-0220 — Locking Thermostat Guard - Metal, Solid Base
- Additional Thermostat Guards — see pages 34–35 for quick selection options



UNIVERSAL STAGING/HEAT PUMP THERMOSTATS – BLUE 12" THERMOSTATS

| Single Stage | Multi-Stage | Heat Pump | Programs                   |                 | Model                      | Applications            |              |                      |                   | Thermostat Power Source* | Selectable Performance Features |            |  |                 |                  |                      |  |  | Comfort and Convenience Features                |  |                       | Terminals |                              |   |
|--------------|-------------|-----------|----------------------------|-----------------|----------------------------|-------------------------|--------------|----------------------|-------------------|--------------------------|---------------------------------|------------|--|-----------------|------------------|----------------------|--|--|---|--|-----------------------|-----------|------------------------------|---|
|              |             |           | Stages Heat/Cool by System | Program Options |                            | Periods Per Day Options | Model Number | Gas / Oil / Electric | 3 Wire Zone Valve |                          | Millivolt Compatible            | Economizer | Humidity Control (H)-Humidity / (D)-Dehumidify | Auto Changeover | Programmable Fan | Energy Mgt. Recovery | Dual Fuel Heat Pump Control (L)-Logic / (O)-Outdoor Sensor | Keypad Lockout (T)-Total / (P)-Partial | Set-Point Temperature Limits Adjustable Max/Min | Indoor Remote Sensors Max. Number + Thermostat Average and/or Weighted | Outdoor Remote Sensor |           | Display Size (Square inches) | Lighted Display   |
| 1/1          | 2/2         | 4/2       | 7, 5+1+1, Ø                | 4, 2, Ø         | 1F95-1291 Humidity Control | ✓                       | ✓            | ✓                    |                   | H, D                     | B, H, PA                        | ✓          | ✓  | ✓               | L, O†            | T, P                 | ✓  | 1+1                                    | 1▼  | 12.0   | ✓***                  | ✓         | P                            | RC, RH, C, W/E, W2, Y, Y2, O/B, G, L, 6, +, S, -, DHM, HM |
| 1/1          | 2/2         | 4/2       | 7, 5+1+1, Ø                | 2, Ø            | 1F95-1280 Commercial       | ✓                       | ✓            | ✓                    | ✓                 |                          | B, H, PA                        | ✓          | ✓  | ✓               | L, O†            | T, P                 | ✓  | 1+1                                    | 1▼  | 12.0   | ✓***                  | ✓         | P                            | RC, RH, C, W/E, W2, Y, Y2, O/B, G, L, 6, +, S, -, A1      |
| 1/1          | 2/2         | 3/2■      | 7, 5+1+1, Ø                | 4, 2, Ø         | 1F95-1277 Universal        | ✓                       | ✓            | ✓                    |                   |                          | B, H                            | ✓          | ✓  | ✓               | L, O†            | T, P                 | ✓  | 1+1                                    | 1▼  | 12.0   | ✓***                  | ✓         | P                            | RC, RH, C, W/E, W2, Y, Y2, O/B, G, L, 6, +, S, -          |

SINGLE STAGE THERMOSTAT – BLUE 12" THERMOSTATS

| Single Stage | Multi-Stage | Heat Pump | Programs                   |                 | Model     | Applications            |              |                      |                   | Thermostat Power Source* | Selectable Performance Features |            |  |                 |                  |                      |  |  | Comfort and Convenience Features                |  |                       | Terminals |                              |  |
|--------------|-------------|-----------|----------------------------|-----------------|-----------|-------------------------|--------------|----------------------|-------------------|--------------------------|---------------------------------|------------|--|-----------------|------------------|----------------------|--|--|---|--|-----------------------|-----------|------------------------------|--|
|              |             |           | Stages Heat/Cool by System | Program Options |           | Periods Per Day Options | Model Number | Gas / Oil / Electric | 3 Wire Zone Valve |                          | Millivolt Compatible            | Economizer | Humidity Control (H)-Humidity / (D)-Dehumidify | Auto Changeover | Programmable Fan | Energy Mgt. Recovery | Dual Fuel Heat Pump Control (L)-Logic / (O)-Outdoor Sensor | Keypad Lockout (T)-Total / (P)-Partial | Set-Point Temperature Limits Adjustable Max/Min | Indoor Remote Sensors Max. Number + Thermostat Average and/or Weighted | Outdoor Remote Sensor |           | Display Size (Square inches) | Lighted Display                          |
| 1/1          |             | 2/1       | 7, 5+1+1, Ø                | 4, 2, Ø         | 1F97-1277 | ✓                       | ✓            | ✓                    |                   |                          | B, H                            | ✓          | ✓  | ✓               | L, O†            | T, P                 | ✓  | 1+1                                    | 1▼  | 12.0   | ✓***                  | ✓         | P                            | RC, RH, C, W/E, Y, O/B, G, L, 6, +, S, - |

\* H = Hardwired (Requires Common)  
 B, H = Battery Powered or Hardwired  
 B = Battery Powered  
 PA = Power Saving Battery Assist

† If F145-1378 outdoor remote sensor is not used, install manufacturers fossil fuel kit for Dual Fuel applications  
 \*\*\* Optional Continuous Display Light w/ Hardwire connection  
 ▼ Only one (1) remote sensor may be used – either Indoor or Outdoor  
 ■ 4/2 on Dual Fuel using Outdoor Remote Sensor



TECHNICAL HELP

|                             |                                     |                   |
|-----------------------------|-------------------------------------|-------------------|
| 1F97-1277 .....             | Wiring Diagrams/Configuration ..... | See pages 131–132 |
| 1F95-1280 / 1F95-1291 ..... | Wiring Diagrams/Configuration ..... | See pages 133–136 |
| 1F95-1277 .....             | Wiring Diagrams/Configuration ..... | See pages 137–138 |



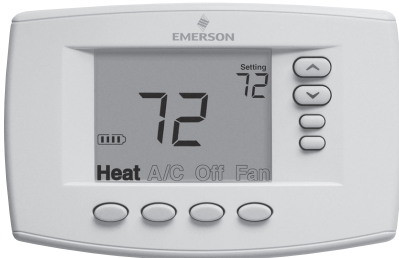

**1F95EZ-0671**



**1F95-0671**



**1F95-0680**



**F145-1328**  
Indoor Remote Sensor



**F145-1378**  
Outdoor Remote Sensor



## BLUE 6" - UNIVERSAL COMMERCIAL AND EASY READER THERMOSTATS - 6 SQ. IN. DISPLAY

Blue 6" Models Offer More Premium Features than Higher Priced Competitive Touchscreen Models

### FEATURES

- Universal models quickly configure for single stage, multi-stage or heat pump and heat pump dual fuel systems - programmable or non-programmable
- **Easy Reader model is easy to read and easy to use.**
- **Commercial** offers occupied damper or economizer control and locking cover and subbase
- **Staging** control for nearly all conventional and heat pump systems
- **Single stage** model compatible with all single stage systems low voltage, 750 mV and 3-wire zone systems. 1F97-0671 not pictured.
- Heat Pump dual fuel option eliminates the need for a fossil fuel kit.
- Automatic changeover option.
- Program fan options.
- Keypad lockout and setpoint temperature limit options.
- Indoor remote sensor for averaging option.
- Outdoor remote sensor option on select Universal models for outdoor temperature reading and dual fuel balance point or outdoor thermostat function (select models)
- Dual power - hardwire and/or battery or Tripower - hardwire and/or battery with system assist.

### SPECIFICATIONS

#### Electrical Rating:

|                         |   |
|-------------------------|---|
| Hardwire . . . . .      | 20-30 VAC, NEC Class II 50/60Hz                             |
| Battery Power . . . . . | mV to 30 VAC, NEC Class II, 50/60 Hz or DC                  |
| Terminal Load . . . . . | 1.5 A per terminal,<br>2.5 A maximum all terminals combined |

Setpoint Range . . . . . 45 to 99°F (7 to 37°C)

| Rated Differentials, Universal Models:    | Fast  | Slow  |
|---|-------|-------|
| Heat (Single Stage/Multi-Stage) . . . . . | 0.6°F | 1.2°F |
| Cool (Single Stage/Multi-Stage) . . . . . | 1.2°F | 1.7°F |
| Pump . . . . .                            | 1.2°F | 1.7°F |
| Emer. Heat . . . . .                      | 1.2°F | 1.7°F |

| Rated Differentials - Single Stage Models: | Fast  | Slow  |
|--|-------|-------|
| Heat . . . . .                             | 0.6°F | 1.2°F |
| Cool . . . . .                             | 1.2°F | 1.7°F |

Operating Ambient . . . . . 32 to +105°F (0 to +41°C)

Operating Humidity . . . . . 90% non-condensing max.

Shipping Temperature Range . . . . . -4 to +150°F (-20 to 65°C)

Dimension . . . . . 4<sup>3</sup>/<sub>16</sub>" H x 6<sup>1</sup>/<sub>2</sub>" W x 1<sup>5</sup>/<sub>8</sub>" D  
(1<sup>7</sup>/<sub>8</sub>" D – Commercial model)

### PARTS AND ACCESSORIES See end of thermostats section for additional parts and accessories

- F145-1328 — Indoor Remote Sensor
- F145-1378 — Outdoor Remote Sensor
- F61-2600 — Wallplate 8<sup>1</sup>/<sub>8</sub>" W X 5<sup>3</sup>/<sub>8</sub>" H
- F61-2634 — Wallplate 6<sup>1</sup>/<sub>2</sub>" W x 5" H (or order F61-2648 – 6 pack of F61-2634)
- F29-0198 — Locking Thermostat Guard - Clear Plastic
- F29-0220 — Locking Thermostat Guard - Metal, Solid Base
- Additional Thermostat Guards — see pages 34–35 for quick selection options

UNIVERSAL STAGING/HEAT PUMP THERMOSTATS – BLUE 6" THERMOSTATS

| Single Stage | Multi-Stage | Heat Pump | Programs                   |                 | Model                             | Applications            |              |                      |                   | Thermostat Power Source* | Selectable Performance Features |  |                 |                  |                      |  |  | Comfort and Convenience Features                |  | Terminals |                       |                              |  |
|--------------|-------------|-----------|----------------------------|-----------------|-----------------------------------|-------------------------|--------------|----------------------|-------------------|--------------------------|---------------------------------|--|-----------------|------------------|----------------------|--|--|---|--|-----------|-----------------------|------------------------------|--|
|              |             |           | Stages Heat/Cool by System | Program Options |                                   | Periods Per Day Options | Model Number | Gas / Oil / Electric | 3 Wire Zone Valve |                          | Millivolt Compatible            | Humidity Control (H)-Humidity / (D)-Dehumidify | Auto Changeover | Programmable Fan | Energy Mgt. Recovery | Dual Fuel Heat Pump Control (L)-Logic / (O)-Outdoor Sensor | Keypad Lockout (T)-Total / (P)-Partial | Set-Point Temperature Limits Adjustable Max/Min | Indoor Remote Sensors Max. Number + Thermostat Average and/or Weighted |           | Outdoor Remote Sensor | Display Size (Square inches) | Lighted Display                                      |
| 1/1          | 2/2         | 4/2       | 7, 5+1+1, Ø                | 4, 2, Ø         | 1F95-0680<br>Universal Commercial | ✓                       | ✓            | ✓                    |                   | B, H, PA                 | ✓                               | ✓  | ✓               | O <sup>‡</sup>   | T, P                 | ✓  | 1 + 1                                  | 1▼  | 6.0  | ✓***      | ✓                     | P                            | RC, RH, C, W/E, W2, Y, Y2, O/B, G, L, 6, +, S, -, A1 |
| 1/1          | 2/2         | 4/2       | 7, 5+1+1, Ø                | 4, 2, Ø         | 1F95-0671<br>Universal            | ✓                       | ✓            | ✓                    |                   | B, H, PA                 | ✓                               | ✓  | ✓               | O <sup>‡</sup>   | T, P                 | ✓  | 1 + 1                                  | 1▼  | 6.0  | ✓***      | ✓                     | P                            | RC, RH, C, G, Y, Y2, W/E, W2, O/B, L, 6, +, S, -     |
| 1/1          | 2/2         | 4/2       | Ø, 7                       | 2, 4            | 1F95EZ-0671<br>Easy Reader        | ✓                       | ✓            | ✓                    |                   | B, H, PA                 | ✓                               | ✓  | ✓               | L                |                      | ✓  |  |   | 6.0  | ✓***      | ✓                     | P                            | RC, RH, C, W/E, W2, Y, Y2, O/B, G, L, 6,             |

\* H = Hardwired (Requires Common)  
 B, H = Battery Powered or Hardwired  
 B = Battery Powered  
 PA = Power Saving Battery Assist

‡ If F145-1378 outdoor remote sensor is not used, install manufacturers fossil fuel kit for Dual Fuel applications  
 \*\*\* Optional Continuous Display Light w/ Hardwire connection  
 ▼ Only one (1) remote sensor may be used – either Indoor or Outdoor



TECHNICAL HELP

1F95EZ-0671..... Wiring Diagrams/Configuration..... See pages 139–140  
 1F95-0671 ..... Wiring Diagrams/Configuration..... See pages 141–143  
 1F95-0680 ..... Wiring Diagrams/Configuration..... See pages 144–146

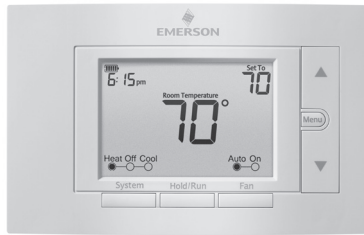

**1F85U-42PR**

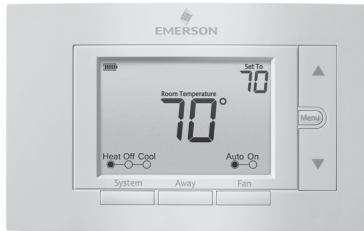

**1F85U-42NP**

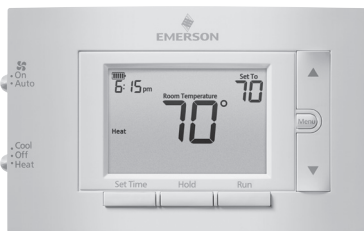

**1F83C-11PR**

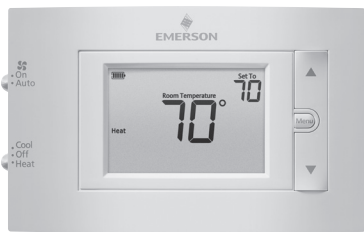

**1F83C-11NP**

## 80 SERIES CONVENTIONAL, HEAT PUMP AND UNIVERSAL THERMOSTATS

New Products, New Styling With Our "Customer Most Requested" Thermostat Features

### FEATURES

- Attractive Sensi thermostat styling for non-wi-fi applications.
- Universal (single stage, multi-stage, heat pump), conventional and heat pump models.
- Bright, high contrast backlight.
- Automatic heat/cool changeover option.
- Keypad lockout and adjustable heat/cool temperature limits.
- Built in dual fuel logic program eliminates the need for an outdoor sensor.

### SPECIFICATIONS

#### Electrical Rating:

|   |  |
|---|--|
| Hardwire . . . . .                          | 20-30 VAC, NEC Class II 50/60Hz                            |
| Battery Power . . . . .                     | mV to 30 VAC, NEC Class II, 50/60 Hz or DC                 |
| Terminal Load Staging Models . . . . .      | 1.5 A per terminal<br>2.5 A maximum all terminals combined |
| Terminal Load Single Stage Models . . . . . | 1.0 A per terminal<br>1.5 A maximum all terminals combined |

Setpoint Range . . . . . 45 to 99°F (7 to 37°C)

|   |       |        |       |
|---|-------|--------|-------|
| Rated Differentials (@ 6°F/Hr)              | Fast  | Med.   | Slow  |
| Heat (Conventional Gas/Oil/Elect) . . . . . | 0.5°F | 0.75°F | 1.9°F |
| Cool (Central Air) . . . . .                | 0.9°F | 1.2°F  | 1.7°F |
| Heat Pump (Heat and Cool) . . . . .         | 0.9°F | 1.2°F  | 1.7°F |
| Heat Pump (Aux) . . . . .                   | 0.5°F | 0.75°F | 1.9°F |

#### Display Size:

|   |                     |
|---|---------------------|
| 1F85U-42PR, 1F85U-42NP,<br>1F85U-22PR, 1F85U-22NP . . . . . | 5 sq. in. display   |
| 1F83H-21PR, 1F83H-21NP,<br>1F83C-11PR, 1F83C-11NP . . . . . | 4.5 sq. in. display |

Operating Ambient . . . . . 32 to +105°F (0 to +41°C)

Display Temperature Range . . . . . 32 to +99°F (0 to +37°C)

Operating Humidity . . . . . 90% non-condensing max.

Shipping Temperature Range . . . . . -20 to +150°F (-29 to +65°C)

Dimension . . . . . 3<sup>3</sup>/<sub>4</sub>" H x 6" W x 1<sup>1</sup>/<sub>8</sub>" D

### PARTS AND ACCESSORIES

See end of thermostats section for additional parts and accessories

- F61-2663 — Wallplate 4<sup>1</sup>/<sub>2</sub>"H x 6<sup>3</sup>/<sub>4</sub>"W for use with or without horizontal junction box
- F29-0198 — Universal Locking Thermostat Guard – Clear Plastic
- F29-0220 — Universal Locking Thermostat Guard – Metal, Solid Base



### TECHNICAL HELP

#### 80 Series Thermostat Nomenclature

Example: 1F85U-42PR

| 1F85                     | U  | -                   | 42                      | PR                                     |
|--------------------------|--|---------------------|-------------------------|--|
| Series                   | System Type  | Dash                | Max. Stages Heat / Cool | Programmable / Special Features        |
| 1F8X - Thermostat Series | U = Universal Thermostat for Single Stage, Multi-Stage or Heat Pump Systems            | Character Separator | 42 = 4 Heat / 2 Cool    | PR = Programmable and Non-Programmable |
|                          | H = Heat Pump Thermostat for Systems with or Without Aux. Heat                         |                     | 22 = 2 Heat / 2 Cool    | NP = Dedicated Non-Programmable        |
|                          | C = Conventional Thermostat (Gas / Oil / Electric) or Single Stage Heat Pump (No Aux.) |                     | 21 = 2 Heat / 1 Cool    |  |
|                          |  |                     | 11 = 1 Heat / 1 Cool    | WF = Wi-Fi Thermostat                  |

## UNIVERSAL STAGING/HEAT PUMP THERMOSTATS – 80 SERIES THERMOSTATS

| Conventional | Heat Pump | Programs                   |                 | Model      | Applications            |              |                      |                   | Thermostat Power Source* | Selectable Performance Features |  |                 |                  |                            |                | Comfort and Convenience Features  |                              |                              | Terminals |  |
|--------------|-----------|----------------------------|-----------------|------------|-------------------------|--------------|----------------------|-------------------|--------------------------|---------------------------------|--|-----------------|------------------|----------------------------|----------------|---|------------------------------|------------------------------|-----------|--|
|              |           | Stages Heat/Cool by System | Program Options |            | Periods Per Day Options | Model Number | Gas / Oil / Electric | 3 Wire Zone Valve |                          | Millivolt Compatible            | Humidity Control (H)-Humidity / (D)-Dehumidify | Auto Changeover | Programmable Fan | EMR / Early Start Recovery | Keypad Lockout | Temperature Setpoint Limits Adjustable Max./Min. Indoor / Outdoor Remote Sensor | Dual Fuel Control (L)- Logic | Dual Fuel Heat Stages HP/Gas |           | Lighted Display                        |
| 2/2          | 4/2       | 7, 5+1+1, 0                | 4, 2, 0         | 1F85U-42PR | ✓                       | ✓            | ✓                    |                   | B, H                     | ✓                               | ✓  | ✓               | ✓                |                            | L              | 2/2   | ✓**                          | ✓                            | ✓         | RC, RH, C, W/E, W2, Y, Y2, O/B/6, G, L |
| 2/2          | 2/1       | 7, 5+1+1, 0                | 4, 2, 0         | 1F85U-22PR | ✓                       | ✓            | ✓                    |                   | B, H                     | ✓                               | ✓  | ✓               | ✓                |                            | L              | 1/1   | ✓**                          | ✓                            | ✓         | RC, RH, C, W/E, W2, Y, Y2, O/B/6, G, L |
| -            | 2/1       | 7, 5+1+1, 0                | 4, 0            | 1F83H-21PR | ✓                       |              |                      |                   | B, H                     |                                 | ✓  | ✓               | ✓                |                            | L              | 1/1   | ✓**                          | ✓                            | ✓         | R, C, W2, E, Y, O/B, G, L              |
| 2/2          | 4/2       | 0                          | 0               | 1F85U-42NP | ✓                       | ✓            | ✓                    |                   | B, H                     | ✓                               |  | ✓               | ✓                |                            | L              | 2/2   | ✓**                          |                              | ✓         | RC, RH, C, W/E, W2, Y, Y2, O/B/6, G, L |
| 2/2          | 2/1       | 0                          | 0               | 1F85U-22NP | ✓                       | ✓            | ✓                    |                   | B, H                     | ✓                               |  | ✓               | ✓                |                            | L              | 1/1   | ✓**                          |                              | ✓         | RC, RH, C, W/E, W2, Y, Y2, O/B/6, G, L |
| -            | 2/1       | 0                          | 0               | 1F83H-21NP | ✓                       |              |                      |                   | B, H                     |                                 |  | ✓               | ✓                |                            | L              | 1/1   | ✓**                          |                              | ✓         | R, C, W2, E, Y, O/B, G, L              |

## SINGLE STAGE THERMOSTATS – 80 SERIES THERMOSTATS

| Conventional | Heat Pump | Programs                   |                 | Model      | Applications            |              |                      |                   | Thermostat Power Source* | Selectable Performance Features |  |                 |                  |                            |                | Comfort and Convenience Features  |                              |                              | Terminals |                         |
|--------------|-----------|----------------------------|-----------------|------------|-------------------------|--------------|----------------------|-------------------|--------------------------|---------------------------------|--|-----------------|------------------|----------------------------|----------------|---|------------------------------|------------------------------|-----------|-------------------------|
|              |           | Stages Heat/Cool by System | Program Options |            | Periods Per Day Options | Model Number | Gas / Oil / Electric | 3 Wire Zone Valve |                          | Millivolt Compatible            | Humidity Control (H)-Humidity / (D)-Dehumidify | Auto Changeover | Programmable Fan | EMR / Early Start Recovery | Keypad Lockout | Temperature Setpoint Limits Adjustable Max./Min. Indoor / Outdoor Remote Sensor | Dual Fuel Control (L)- Logic | Dual Fuel Heat Stages HP/Gas |           | Lighted Display         |
| 1/1          | 1/1       | 7, 5+1+1, 0                | 4, 0            | 1F83C-11PR | ✓                       |              | ✓                    |                   | B, H                     |                                 | ✓  | ✓               | ✓                |                            |                |   | ✓**                          | ✓                            | ✓         | RC, RH, C, W, Y, O/B, G |
| 1/1          | 1/1       | 0                          | 0               | 1F83C-11NP | ✓                       |              | ✓                    |                   | B, H                     |                                 |  | ✓               | ✓                |                            |                |   | ✓**                          |                              | ✓         | RC, RH, C, W, Y, O/B, G |

\* B = Battery Powered or Hardwired

\*\* Requires a common wire for Continuous Backlight



1F85-0422

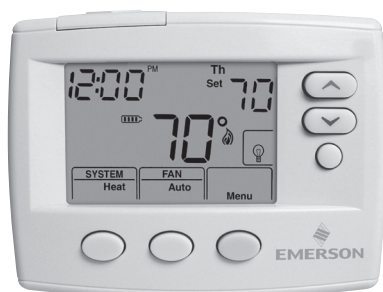

1F80-0471



## BLUE 4" UNIVERSAL AND SINGLE STAGE THERMOSTATS – 4 SQ. IN. DISPLAY

Premium Features for Staging or Single Choices – for Optimum System Control

### FEATURES

- Available in Universal (Single Stage, Multi-Stage, Heat pump) or Single Stage Models.
- Programmable 7-Day, 5/1/1 Day, 5/2 Day, 0-Day or Non-Programmable.
- Gas, Oil, Electric, mV and 2 or 3-Wire Zone compatible.
- Automatic Heat/Cool changeover option.
- Keypad lockout and temperature limit options.
- Dual power – hardwired and/or battery powered.
- Fits vertical or horizontal junction box.
- Air filter change indicator option.
- Spanish language display models available.

### SPECIFICATIONS

Electrical Rating:

Hardwire . . . . . 20-30 VAC, NEC Class II 50/60Hz  
 Battery Power . . . . . mV to 30 VAC, NEC Class II, 50/60 Hz or DC  
 Terminal Load Staging Models . . . . . 1.5 A per terminal,

2.5 A maximum all terminals combined

Terminal Load Single Stage Models . . . . . 1.0 A per terminal,  
 1.5 A maximum all terminals combined

Setpoint Range . . . . . 45 to 99°F (7 to 37°C)

| Rated Differentials, Universal Models:    | Fast  | Med.  | Slow  |
|---|-------|-------|-------|
| Heat (Single Stage/Multi-Stage) . . . . . | 0.4°F | 0.6°F | 1.7°F |
| Cool (Single Stage/Multi-Stage) . . . . . | 0.9°F | 1.2°F | 1.7°F |
| Heat Pump . . . . .                       | 0.9°F | 1.2°F | 1.7°F |
| Emer. Heat . . . . .                      | 0.6°F |       | 1.7°F |

| Rated Differentials - Single Stage Models: | Fast  | Med.  | Slow  |
|--|-------|-------|-------|
| Heat (Single Stage/Multi-Stage) . . . . .  | 0.4°F | 0.6°F | 1.7°F |
| Cool (Single Stage/Multi-Stage) . . . . .  | 1.2°F |       | 1.7°F |
| Heat Pump . . . . .                        | 1.2°F |       | 1.7°F |

Operating Ambient . . . . . 32 to +105°F (0 to +41°C)

Operating Humidity . . . . . 90% non-condensing max.

Shipping Temperature Range . . . . . -4 to +150°F (-20 to 65°C)

Dimension . . . . . 3<sup>7</sup>/<sub>16</sub>" H x 4<sup>7</sup>/<sub>16</sub>" W x 1<sup>1</sup>/<sub>4</sub>" D  
 3<sup>7</sup>/<sub>8</sub>" H x 5<sup>1</sup>/<sub>8</sub>" W x 1<sup>1</sup>/<sub>4</sub>" D – (Universal models)

### PARTS AND ACCESSORIES See end of thermostats section for additional parts and accessories

- F61-2634 — Wallplate 6<sup>1</sup>/<sub>2</sub>" W X 5" H, for use with or without horizontal junction box (included with thermostat)
- F61-2648 — Wallplate (6 pack of F61-2634 above)
- Thermostat Guards — see pages 34–35 for quick selection

UNIVERSAL STAGING/HEAT PUMP THERMOSTATS – BLUE 4" THERMOSTATS

| Single Stage | Multi-Stage | Heat Pump | Programs                   |                 | Model                   | Applications            |              |                      |                   | Thermostat Power Source* | Selectable Performance Features |  |                 |                  |                   |                                      | Comfort and Convenience Features                 |  |                       | Terminals                              |
|--------------|-------------|-----------|----------------------------|-----------------|-------------------------|-------------------------|--------------|----------------------|-------------------|--------------------------|---------------------------------|--|-----------------|------------------|-------------------|--------------------------------------|--|--|-----------------------|--|
|              |             |           | Stages Heat/Cool by System | Program Options |                         | Periods per day Options | Model Number | Gas / Oil / Electric | 3 Wire Zone Valve |                          | Millivolt Compatible            | Humidity Control (H)-Humidity / (D)-Dehumidity | Auto Changeover | Programmable Fan | Energy Mgt. Aware | Keypad Lockout (T)-Total/(P)-Partial | Set-Point Temperature Limits Adjustable Max/Min. | Indoor Remote Sensors Max. Number + Thermostat Average and/or Weighted | Outdoor Remote Sensor |  |
| 1/1          | 2/2         | 3/2       | 7, 5+1+1, 5+2, 0           | 4, 0            | 1F85-0477 Universal     | ✓                       | ✓            | ✓                    |                   | B, H                     | ✓                               | ✓  | T               | ✓                |                   | 4.0                                  | ✓***   | ✓  | P                     | RC, RH, C, W/E, W2,Y, Y2, O/B, G, L, 6 |
| 1/1          | 2/2         | 2/1       | 5+1+1, 5+2, 0              | 4, 0            | 1F85-0422 Universal     | ✓                       | ✓            | ✓                    |                   | B, H                     | ✓                               | ✓  | T               | ✓                |                   | 4.0                                  | ✓***   | ✓  | P                     | RC, RH, C, W/E, W2,Y, Y2, O/B, G, L, 6 |
| 1/1          | 2/2         | 2/1       | 5+1+1, 5+2, 0              | 4, 0            | 1F85ST-0422 Universal** | ✓                       | ✓            | ✓                    |                   | B, H                     | ✓                               | ✓  |                 | ✓                |                   | 4.0                                  | ✓***   | ✓  | P                     | RC, RH, C, W/E, W2,Y, Y2, O/B, G, L, 6 |
| 1/1          | 2/2         | 3/2       | 0                          | 0               | 1F83-0471 Universal     | ✓                       | ✓            | ✓                    |                   | B, H                     | ✓                               |  | T               | ✓                |                   | 4.0                                  | ✓***   | ✓  | P                     | RC, RH, C, W/E, W2,Y, Y2, O/B, G, L, 6 |
| 1/1          | 2/2         | 2/1       | 0                          | 0               | 1F83-0422 Universal     | ✓                       | ✓            | ✓                    |                   | B, H                     | ✓                               |  | T               | ✓                |                   | 4.0                                  | ✓***   | ✓  | P                     | RC, RH, C, W/E, W2,Y, Y2, O/B, G, L, 6 |

\*\* ST model is Spanish language display

SINGLE STAGE THERMOSTATS – BLUE 4" THERMOSTATS

| Single Stage | Multi-Stage | Heat Pump | Programs                   |                 | Model         | Applications            |              |                      |                   | Thermostat Power Source* | Selectable Performance Features |  |                 |                  |                   |                                      | Comfort and Convenience Features                 |  |                       | Terminals               |
|--------------|-------------|-----------|----------------------------|-----------------|---------------|-------------------------|--------------|----------------------|-------------------|--------------------------|---------------------------------|--|-----------------|------------------|-------------------|--------------------------------------|--|--|-----------------------|-------------------------|
|              |             |           | Stages Heat/Cool by System | Program Options |               | Periods per day Options | Model Number | Gas / Oil / Electric | 3 Wire Zone Valve |                          | Millivolt Compatible            | Humidity Control (H)-Humidity / (D)-Denumidity | Auto Changeover | Programmable Fan | Energy Mgt. Aware | Keypad Lockout (T)-Total/(P)-Partial | Set-Point Temperature Limits Adjustable Max/Min. | Indoor Remote Sensors Max. Number + Thermostat Average and/or Weighted | Outdoor Remote Sensor |                         |
| 1/1          |             | 1/1       | 5+1+1, 5+2, 0              | 4, 0            | 1F80-0471     | ✓                       | ✓            | ✓                    |                   | B, H                     | ✓                               | ✓  |                 | ✓                |                   | 4.0                                  | ✓***   | ✓  | P                     | RC, RH, C, W, Y, O/B, G |
| 1/1          |             | 1/1       | 5+1+1, 5+2, 0              | 4, 0            | 1F80ST-0471** | ✓                       | ✓            | ✓                    |                   | B, H                     | ✓                               | ✓  |                 |                  |                   | 4.0                                  | ✓***   | ✓  | P                     | RC, RH, C, W, Y, O/B, G |
| 1/1          |             | 1/1       | 0                          | 0               | 1F86-0471     | ✓                       | ✓            | ✓                    |                   | B, H                     | ✓                               | ✓  |                 | ✓                |                   | 4.0                                  | ✓***   | ✓  | P                     | RC, RH, C, W, Y, O/B, G |
| 1/1          |             | 1/1       | 0                          | 0               | 1F86ST-0471** | ✓                       | ✓            | ✓                    |                   | B, H                     | ✓                               |  |                 |                  |                   | 4.0                                  | ✓***   | ✓  | P                     | RC, RH, C, W, Y, O/B, G |

\* H = Hardwired (Requires Common)  
 B, H = Battery Powered or Hardwired  
 B = Battery Assist Powered

\*\* ST models are Spanish language display  
 \*\*\* Optional Continuous Display Light w/ Hardwire connection



TECHNICAL HELP

- 1F80-0471 / 1F86-0471.....Wiring Diagrams/Configuration..... See page 147
- 1F83-0471 / 1F85-0471.....Wiring Diagrams ..... See pages 148–149
- 1F83-0422 / 1F85-0422.....Wiring Diagrams/Configuration..... See pages 149–151
- 1F85-0477 .....Wiring Diagrams/Configuration..... See pages 152–154

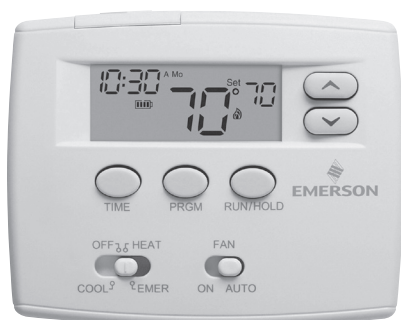
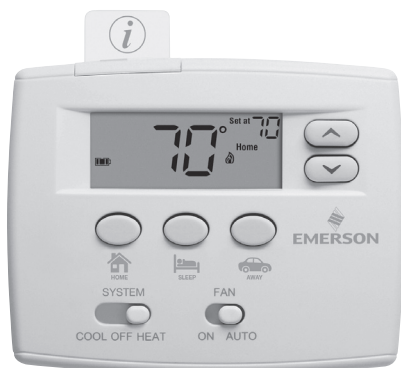
**1F82-0261****1F86-0244****1F86EZ-0251**

Easy Set Single Stage

## BLUE 2" HEAT PUMP AND SINGLE STAGE THERMOSTATS – 2 SQ. IN. DISPLAY

Heat Pump or Single Stage Models, Easy to See Display Characters Offering a Step Up from 70 Series

### FEATURES

- Heat Pump or Single Stage models.
- Easy set models feature simple **Home-Sleep-Away** preset buttons.
- Programmable, 5/1/1 Day, 24 Hour, 0-Day or Non-Programmable.
- Gas, Oil, Electric, mV.
- Cool Savings™ saves energy during peak A/C demand periods.
- Lighted display for easier low light viewing.
- Dual power – hardwired and/or battery powered.
- Fits horizontal junction box.
- Air filter change indicator option.

### SPECIFICATIONS

Electrical Rating:

|                                   |   |
|-----------------------------------|---|
| Hardwire                          | 20-30 VAC, NEC Class II 50/60Hz                             |
| Battery Power                     | mV to 30 VAC, NEC Class II, 50/60 Hz or DC                  |
| Terminal Load Staging Models      | 1.5 A per terminal,<br>2.5 A maximum all terminals combined |
| Terminal Load Single Stage Models | 1.0A per terminal<br>1.5A maximum all terminals combined    |

Setpoint Range . . . . . 45 to 90°F (7 to 32°C)

|  |       |      |       |
|--|-------|------|-------|
| Rated Differentials, Universal Models: | Fast  | Med. | Slow  |
| Heat (Single Stage)                    | 0.8°F |      | 1.2°F |
| Cool (Single Stage)                    | 1.2°F |      | 1.7°F |
| Heat Pump                              | 1.2°F |      | 1.7°F |
| Aux./Emer Heat                         | 0.8°F |      | 1.2°F |

|   |       |       |       |
|---|-------|-------|-------|
| Rated Differentials, Single Stage Models: | Fast  | Med.  | Slow  |
| Heat                                      | 0.6°F | 0.8°F | 1.2°F |
| Cool                                      | 1.2°F |       | 1.7°F |
| Heat Pump                                 | 0.8°F |       | 1.2°F |

Operating Ambient . . . . . 32 to +105°F (0 to +41°C)

Operating Humidity . . . . . 90% non-condensing max.

Shipping Temperature Range . . . . . -4 to +150°F (-20 to +65°C)

Dimension . . . . . 3<sup>3</sup>/<sub>4</sub>"H x 4<sup>3</sup>/<sub>4</sub>"W x 1<sup>1</sup>/<sub>2</sub>"D

### PARTS AND ACCESSORIES

 See end of thermostats section for additional parts and accessories

- F61-2634 — Wallplate 6<sup>1</sup>/<sub>2</sub>"W X 5"H, for use with or without horizontal junction box
- F61-2648 — Wallplate (6 pack of F61-2634 above)
- Thermostat Guards — see pages 34–35 for quick selection



HEAT PUMP THERMOSTATS – BLUE 2" THERMOSTATS

| Single Stage | Multi-Stage | Heat Pump | Programs                                    |                 | Model       | Applications            |              |                      |                   | Thermostat Power Source* | Selectable Performance Features |  |                 |                  |                      |  | Comfort and Convenience Features                |  |                        | Terminals |
|--------------|-------------|-----------|---|-----------------|-------------|-------------------------|--------------|----------------------|-------------------|--------------------------|---------------------------------|--|-----------------|------------------|----------------------|--|---|--|------------------------|-----------|
|              |             |           | Stages Heat/Cool by System                  | Program Options |             | Periods Per Day Options | Model Number | Gas / Oil / Electric | 3 Wire Zone Valve |                          | Millivolt Compatible            | Humidity Control (H)-Humidity / (D)-Dehumidify | Auto Changeover | Programmable Fan | Energy Mgt. Recovery | Keypad Lockout (T)-Total / (P)-Partial | Set-Point Temperature Limits Adjustable Max/Min | Indoor Remote Sensors Max. Number + Thermostat Average and/or Weighted | Outdoor Remote Sensor  |           |
|              |             | 2/1       | 5+1+1                                       | 4               | 1F82-0261   | ✓                       | ✓            |                      | B, H              |                          |                                 | ✓  |                 |                  |                      | 2.0                                    | ✓***  | P  | R, C, W2, Y, O/B, G, L |           |
|              |             | 2/1       | Easy Set Non-Programmable – Home-Sleep-Away |                 | 1F89EZ-0251 | ✓                       | ✓            |                      | B, H              |                          |                                 |  |                 |                  |                      | 2.0                                    | ✓***  | P  | R, C, W2, Y, O/B, G, L |           |
|              |             | 2/1       | ∅   | ∅               | 1F89-0211   | ✓                       | ✓            |                      | B, H              |                          |                                 |  |                 |                  |                      | 2.0                                    | ✓***  | P  | R, C, W2, Y, O/B, G, L |           |

SINGLE STAGE THERMOSTATS – BLUE 2" THERMOSTATS

| Single Stage | Multi-Stage | Heat Pump | Programs                                    |                 | Model       | Applications            |              |                      |                   | Thermostat Power Source* | Selectable Performance Features |  |                 |                  |                      |  | Comfort and Convenience Features                |  |                       | Terminals |
|--------------|-------------|-----------|---|-----------------|-------------|-------------------------|--------------|----------------------|-------------------|--------------------------|---------------------------------|--|-----------------|------------------|----------------------|--|---|--|-----------------------|-----------|
|              |             |           | Stages Heat/Cool by System                  | Program Options |             | Periods Per Day Options | Model Number | Gas / Oil / Electric | 3 Wire Zone Valve |                          | Millivolt Compatible            | Humidity Control (H)-Humidity / (D)-Dehumidify | Auto Changeover | Programmable Fan | Energy Mgt. Recovery | Keypad Lockout (T)-Total / (P)-Partial | Set-Point Temperature Limits Adjustable Max/Min | Indoor Remote Sensors Max. Number + Thermostat Average and/or Weighted | Outdoor Remote Sensor |           |
| 1/1          |             | 1/1       | 5+1+1                                       | 4               | 1F80-0261   | ✓                       | ✓            |                      | B, H              |                          |                                 | ✓  |                 |                  |                      | 2.0                                    | ✓***  | P  | R, C, W, Y, O/B, G    |           |
| 1/1          |             | 1/1       | 24 Hours                                    | 4               | 1F80-0224   | ✓                       | ✓            |                      | B, H              |                          |                                 | ✓  |                 |                  |                      | 2.0                                    | ✓***  | P  | R, C, W, Y, O/B, G    |           |
| 1/1          |             | 1/1       | Easy Set Non-Programmable – Home-Sleep-Away |                 | 1F86EZ-0251 | ✓                       | ✓            |                      | B, H              |                          |                                 |  |                 |                  |                      | 2.0                                    | ✓***  | P  | R, C, W, Y, O/B, G    |           |
| 1/1          |             | 1/1       | ∅   | ∅               | 1F86-0244   | ✓                       | ✓            |                      | B, H              |                          |                                 |  |                 |                  |                      | 2.0                                    | ✓***  | P  | R, C, W, Y, O/B, G    |           |

\* H = Hardwired (Requires Common)  
B, H = Battery Powered or Hardwired

B = Battery Powered  
\*\*\* Optional Continuous Display Light w/ Hardwire connection



TECHNICAL HELP

1F80-0224 / 1F80-0261 /  
1F86-0244 / 1F87-0261..... Wiring Diagrams/Configuration ..... See pages 155–156  
1F82-0261 / 1F89-0211 ..... Wiring Diagrams/Configuration ..... See pages 157–158



**1F85-277****1F80-361****1F86-344**

## CLASSIC 80 SERIES UNIVERSAL / HEAT PUMP AND SINGLE STAGE THERMOSTATS

Residential and Light Commercial – Single Stage, Multi-Stage and Heat Pump Applications. Classic 80 Series Thermostats are Packed with Premium Features

### FEATURES

- Choice of battery powered, dual power or hardwired models.
- Fossil fuel or electric heat compatible.
- Large LCD with backlight.
- Permanent program retention during power loss.
- Configuration menu allows keypad selection of options.
- Selectable Celsius or Fahrenheit temperature display.
- Selectable Energy Management Recovery (1F85-277 / 1F80-361 / 1F87-361 / 1F82-261).

### SPECIFICATIONS

Electrical Rating Single Stage:

Dual Power or Battery Power Model . . . mV to 30 VAC, NEC Class II, 50/60 Hz or DC

Input-Hardwire Model . . . . . 20 to 30 VAC

Electrical Rating Staging . . . . . 20 to 30 VAC, NEC Class II

Terminal Load . . . . . 1.0 A per terminal,  
1.5 A maximum all terminals combined

Setpoint Range . . . . . 45 to 90°F (7 to 32°C)

Rated Differential (Single Stage) . . . . . Heat 0.6° or 1.5°F

Cool 1.2°F

Rated Differential (Multi-Stage) . . . . . Heat 0.6° or 1.5°F

Cool 1.2°F

Rated Differential (Heat Pump) . . . . . Heat & Cool 0.75° or 1.2°F

Operating Ambient . . . . . 32 to +105°F (0 to +41°C)

Operating Humidity . . . . . 90% non-condensing max.

Shipping Temperature Range . . . . . -4 to +150°F (-20 to +65°C)

Dimensions Thermostat . . . . . 3<sup>7</sup>/<sub>8</sub>"H x 6"W x 1<sup>3</sup>/<sub>16</sub>"D

### PARTS AND ACCESSORIES See end of thermostats section for additional parts and accessories

- F61-2500 — Wallplate 4<sup>5</sup>/<sub>8</sub>"H x 7<sup>5</sup>/<sub>8</sub>"W for all 1F80's (except Blue)  
Includes adapter plate for mounting to horizontal or vertical junction box
- Thermostat Guards — see pages 34–35

UNIVERSAL STAGING/HEAT PUMP THERMOSTATS – CLASSIC 80 SERIES THERMOSTATS

| Single Stage | Multi-Stage | Heat Pump | Programs                   |                 | Model                  | Applications            |                      |                   |                      | Thermostat Power Source* | Selectable Performance Features                |                 |                  |                      |  |   |  | Comfort and Convenience Features |                              |                 | Terminals                         |
|--------------|-------------|-----------|----------------------------|-----------------|------------------------|-------------------------|----------------------|-------------------|----------------------|--------------------------|--|-----------------|------------------|----------------------|--|---|--|----------------------------------|------------------------------|-----------------|-----------------------------------|
|              |             |           | Stages Heat/Cool by System | Program Options |                        | Periods Per Day Options | Gas / Oil / Electric | 3 Wire Zone Valve | Millivolt Compatible |                          | Humidity Control (H)-Humidity / (D)-Dehumidify | Auto Changeover | Programmable Fan | Energy Mgt. Recovery | Keypad Lockout (T)-Total / (P)-Partial | Set-Point Temperature Limits Adjustable Max/Min | Indoor Remote Sensors Max. Number + Thermostat Average and/or Weighted | Outdoor Remote Sensor            | Display Size (Square inches) | Lighted Display |                                   |
| 1/1          | 2/2         | 3/2       | 7, 5+1+1<br>∅              | 4, 2, ∅         | 1F85-277<br>Universal  | ✓                       |                      | ✓                 |                      | B, H                     | ✓  |                 | ✓                | T                    | ✓                                      |   |  | 2.2                              | ✓***                         | P               | R, C, E/W1, W2, Y1, Y2, O/B, G, L |
|              |             | 2/1       | 5+1+1                      | 4               | 1F82-261<br>Heat Pump  | +                       |                      |                   |                      | H                        |  |                 | ✓                |                      |  |   |  | 1.8                              | ✓***                         | P               | R, C, W2, E, Y, O/B, G, L         |
|              |             | 2/1       | ∅                          | ∅               | 1F89-0211<br>Heat Pump | +                       |                      |                   |                      | H                        |  |                 |                  |                      |  |   |  | 1.8                              | ✓***                         | P               | R, C, W2, E, Y, O/B, G, L         |

SINGLE STAGE THERMOSTATS – CLASSIC 80 SERIES THERMOSTATS

| Single Stage | Multi-Stage | Heat Pump | Programs                   |                 | Model    | Applications            |                      |                   |                      | Thermostat Power Source* | Selectable Performance Features                |                 |                  |                      |  |   |  | Comfort and Convenience Features |                              |                 | Terminals              |
|--------------|-------------|-----------|----------------------------|-----------------|----------|-------------------------|----------------------|-------------------|----------------------|--------------------------|--|-----------------|------------------|----------------------|--|---|--|----------------------------------|------------------------------|-----------------|------------------------|
|              |             |           | Stages Heat/Cool by System | Program Options |          | Periods Per Day Options | Gas / Oil / Electric | 3 Wire Zone Valve | Millivolt Compatible |                          | Humidity Control (H)-Humidity / (D)-Dehumidify | Auto Changeover | Programmable Fan | Energy Mgt. Recovery | Keypad Lockout (T)-Total / (P)-Partial | Set-Point Temperature Limits Adjustable Max/Min | Indoor Remote Sensors Max. Number + Thermostat Average and/or Weighted | Outdoor Remote Sensor            | Display Size (Square inches) | Lighted Display |                        |
| 1/1          |             | 1/1       | 7-day                      | 4               | 1F87-361 | ✓                       |                      | ✓                 |                      | B, H                     |  |                 | ✓                |                      |  |   |  | 2.2                              | ✓                            | P               | RC,RH, C, W, Y,O, B, G |
| 1/1          |             | 1/1       | 5+1+1                      | 4               | 1F80-361 | ✓                       |                      | ✓                 |                      | B, H                     |  |                 | ✓                |                      |  |   |  | 2.2                              | ✓                            | P               | RC,RH, C, W, Y,O, B, G |
| 1/1          |             | 1/1       | ∅                          | ∅               | 1F86-344 | ✓                       |                      | ✓                 |                      | B, H                     |  |                 |                  |                      |  |   |  | 2.2                              | ✓                            | P               | RC,RH, C, W, Y,O, B, G |

\* H = Hardwired (Requires Common)  
B, H = Battery Powered or Hardwired  
B = Battery Powered

+ Heat Pump for Stage 1, and Gas / Oil / Electric for 2nd stage / Emergency  
\*\*\* Optional Continuous Display Light w/ Hardwire connection



TECHNICAL HELP

- 1F80-224 -240, -241, -361 / 1F86-241, -344 / 1F87-361...Wiring Diagrams/Configuration..... See page 159
- 1F82-261 / 1F89-211 .....Wiring Diagrams/Configuration..... See page 160
- 1F85-277 .....Wiring Diagrams/Configuration..... See page 161

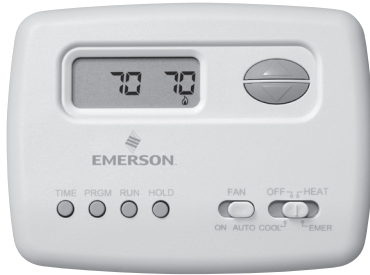
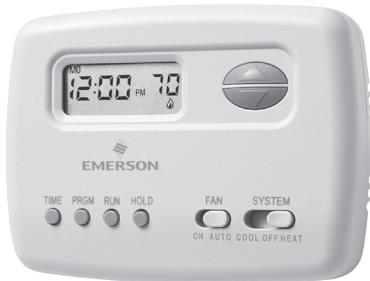
**1F72-151****1F78-151****1E78-151****1E78-144**

## 70 SERIES HEAT PUMP – SINGLE STAGE THERMOSTATS

Residential Single Stage and Heat Pump Applications.

70 Series are the Perfect Upgrade from Mechanical Thermostats.

Covers Wall Marks Left by Most Mechanical Thermostats the

Need for an Extra Wall Plate

### FEATURES

- Fossil fuel or electric compatible.
- Large LCD with backlight.
- Selectable Celsius or Fahrenheit temperature display.
- Includes B/O terminals.
- Electronic accuracy.

### SPECIFICATIONS

Electrical Rating:

|                         |   |
|-------------------------|---|
| Hardwire . . . . .      | 20 to 30 VAC, NEC Class II, 50/60 Hz                        |
| Battery Power . . . . . | 20 to 30 VAC, NEC Class II                                  |
| Terminal Load . . . . . | 1.0 A per terminal,<br>1.5 A maximum all terminals combined |

Setpoint Range . . . . . 45 to 90°F (7 to 32°C)

Rated Differentials - Single Stage Models: Fast      Slow

Heat (Single Stage) . . . . . 0.8°F      1.5°F

Cool (Single Stage) Fixed . . . . . 1.2°F

Heat Pump . . . . . 1.2°F      1.5°F

Aux./Emer. Heat . . . . . 0.8°F      1.2°F

Operating Ambient . . . . . 32 to +105°F (0 to +41°C)

Operating Humidity . . . . . 90% non-condensing max.

Shipping Temperature Range . . . . . -4 to +150°F (-20 to 65°C)

Dimensions . . . . . 3<sup>13</sup>/<sub>16</sub>" H x 5<sup>1</sup>/<sub>8</sub>" W x 1<sup>1</sup>/<sub>8</sub>" D – (1F78)

5<sup>5</sup>/<sub>16</sub>" H x 3<sup>3</sup>/<sub>16</sub>" W x 1<sup>1</sup>/<sub>8</sub>" D – (1E78)

### PARTS AND ACCESSORIES See end of thermostats section for additional parts and accessories

- F61-2510 — Wallplate for 1F models with adaptor for horizontal or vertical junction box 6<sup>1</sup>/<sub>2</sub>" W x 4<sup>1</sup>/<sub>2</sub>" H
- F61-2593 — Wallplate for 1D70, 1E70 models with adaptor for horizontal or vertical junction box 4<sup>1</sup>/<sub>2</sub>" W x 6<sup>19</sup>/<sub>32</sub>" H
- Thermostat Guards — see pages 34–35



HEAT PUMP THERMOSTATS – 70 SERIES THERMOSTATS

| Single Stage | Multi-Stage | Heat Pump | Programs                   |                 | Model    | Applications            |              |                      |                   | Thermostat Power Source* | Selectable Performance Features |  |                 |                  |                      |  | Comfort and Convenience Features                |  |                       | Terminals               |
|--------------|-------------|-----------|----------------------------|-----------------|----------|-------------------------|--------------|----------------------|-------------------|--------------------------|---------------------------------|--|-----------------|------------------|----------------------|--|---|--|-----------------------|-------------------------|
|              |             |           | Stages Heat/Cool by System | Program Options |          | Periods Per Day Options | Model Number | Gas / Oil / Electric | 3 Wire Zone Valve |                          | Millivolt Compatible            | Humidity Control (H)-Humidity / (D)-Dehumidify | Auto Changeover | Programmable Fan | Energy Mgt. Recovery | Keypad Lockout (T)-Total / (P)-Partial | Set-Point Temperature Limits Adjustable Max/Min | Indoor Remote Sensors Max. Number + Thermostat Average and/or Weighted | Outdoor Remote Sensor |                         |
|              |             | 2/1       | 5+2                        | 4               | 1F72-151 | +                       |              |                      |                   | H                        |                                 |  | ✓               |                  |                      |  | 1.2   | ✓***   | P                     | R, C, W2, EY, O/B, G, L |
|              |             | 2/1       | ∅                          | ∅               | 1F79-111 | +                       |              |                      |                   | H                        |                                 |  |                 |                  |                      |  | 1.2   | ✓***   | P                     | R, C, W2, EY, O/B, G, L |

SINGLE STAGE THERMOSTATS – 70 SERIES THERMOSTATS

| Single Stage | Multi-Stage | Heat Pump | Programs                   |                 | Model                 | Applications            |              |                      |                   | Thermostat Power Source* | Selectable Performance Features |  |                 |                  |                      |  | Comfort and Convenience Features                |  |                       | Terminals           |
|--------------|-------------|-----------|----------------------------|-----------------|-----------------------|-------------------------|--------------|----------------------|-------------------|--------------------------|---------------------------------|--|-----------------|------------------|----------------------|--|---|--|-----------------------|---------------------|
|              |             |           | Stages Heat/Cool by System | Program Options |                       | Periods Per Day Options | Model Number | Gas / Oil / Electric | 3 Wire Zone Valve |                          | Millivolt Compatible            | Humidity Control (H)-Humidity / (D)-Dehumidify | Auto Changeover | Programmable Fan | Energy Mgt. Recovery | Keypad Lockout (T)-Total / (P)-Partial | Set-Point Temperature Limits Adjustable Max/Min | Indoor Remote Sensors Max. Number + Thermostat Average and/or Weighted | Outdoor Remote Sensor |                     |
| 1/1          |             | 1/1       | 5+2                        | 4               | 1F78-151 <sup>x</sup> | ✓                       | ✓            |                      |                   | B                        |                                 |  | ✓               |                  |                      |  | 1.2   | ✓***   | P                     | RC,RH, W, Y,O, B, G |
| 1/1          |             | 1/1       | ∅                          | ∅               | 1F78-144 <sup>x</sup> | ✓                       | ✓            |                      |                   | B                        |                                 |  |                 |                  |                      |  | 1.2   | ✓***   | P                     | RC,RH, W, Y,O, B, G |
| 1/1          |             |           | ∅                          | ∅               | 1E78-140              | ✓                       | ✓            |                      |                   | B                        |                                 |  |                 |                  |                      |  | 1.2   | ✓***   | P                     | RH, W               |

\* H = Hardwired (Requires Common)  
B = Battery Powered

† Heat Pump for Stage 1, and Gas / Oil / Electric for 2nd stage / Emergency  
<sup>x</sup> Available in vertical style order 1E78-144/151  
 \*\*\* Optional Continuous Display Light w/ Hardwire connection



TECHNICAL HELP

- 1E78-151 .....Wiring Diagrams/Configuration..... See page 162
- 1F72-151 / 1F79-111 .....Wiring Diagrams/Configuration..... See page 163
- 1F78-144 / 1F78-151 .....Wiring Diagrams/Configuration..... See page 164

**1E30N-910****1F56N-444**\* **1F56N-361**

## MECHANICAL THERMOSTATS – MERCURY FREE

Replaces Hundreds of White-Rodgers and Competitive Models.  
Enclosed Snap Action Contacts for Reliable, Economical and Environmentally Friendly Control

### FEATURES

- Mercury free snap-action contacts with dust cover.
- Resistant to vibration.
- Mounts to wall or junction box.
- Built in bimetal thermometer.
- Classic White color.
- Horizontal and Vertical models.
- 24 Volt, 750 mV and 3 - wire zone options. See table below.

### SPECIFICATIONS

|                          |  |
|--------------------------|--|
| Electrical Rating        | 20-30 VAC, NEC Class II 50/60Hz  |
| Heating                  | 0.15 to 1.2 Amps   |
| Cooling                  | 0.15 to 1.2 Amps   |
| Heat Anticipator         | Adjustable from 0.15 to 1.2 Amps   |
| Cool Anticipator         | Fixed  |
| Differential Heat        | 1°F  |
| Differential Cool        | 1.5°F  |
| Setpoint Range           | 50°F to 90°F (10°C to 32°C)  |
| Operating Humidity Range | 0-90% non-condensing   |
| Dimensions               | 4 1/2" H x 2 3/4" W x 1 1/2" D – 1E (Vertical)<br>4 1/2" H x 3 1/4" W x 1 5/8" D – 1E with Heat / Cool Subbase<br>2 3/4" H x 4 1/2" W x 1 1/2" D – 1F (Horizontal)<br>3 1/4" H x 4 1/2" W x 1 5/8" D – 1F with Heat / Cool Subbase |

### PARTS AND ACCESSORIES

 See end of thermostats section for additional parts and accessories

- F61-2301 — Wallplate 5 5/8" W x 5 3/4" H with adapter plate to horizontal or vertical junction box
- Thermostat Guards — see pages 34–35

### TECHNICAL HELP

Configuration/Wiring . . . . . See page 165

| Model Number | Orientation<br>Vertical, Horizontal | Applications |           |           |                                   |                     |                     |                   |                      | Options  |   |                                    |  |   | Control Range           | Terminals                |
|--------------|-------------------------------------|--------------|-----------|-----------|-----------------------------------|---------------------|---------------------|-------------------|----------------------|--|---|------------------------------------|--|---|-------------------------|--------------------------|
|              |                                     | Heat Only    | Cool Only | Heat-Cool | Conventional Gas / Oil / Electric | Electric Strip Heat | Heat Pump (No Aux.) | 3-Wire Zone Valve | Millivolt Compatible | Includes Optional F92-0563 Kit for Temperature Locking or Limiting | Includes Switched Subbase Heat-Off-Cool & Fan Auto-On | Includes Switched Subbase Heat-Off | Includes Wallplate Heat Only (No System or Off Switch) | Includes Wallplate Cool Only or 3-Wire Zone (No System or Off Switch) |                         |                          |
| 1E30N-910    | V                                   | ✓            |           |           | ✓                                 |                     |                     |                   | ✓                    |  |   |                                    | ✓  |   | 50 to 90°F              | R, W                     |
| 1E50N-301    | V                                   | ✓            | ✓         | ✓         | ✓                                 | ✓                   | ✓                   | ✓                 | ✓                    | ✓  |   |                                    | ✓  |   | 50 to 90°F              | R, W                     |
| 1E56N-444    | V                                   | ✓            | ✓         | ✓         | ✓                                 | ✓                   | ✓                   | ✓                 | ✓                    |  | ✓   |                                    | ✓  |   | 50 to 90°F              | RC, RH, W, Y, O, B, G, A |
| 1F56N-444    | H                                   | ✓            |           |           | ✓                                 |                     |                     |                   | ✓                    |  |   |                                    | ✓  |   | 50 to 90°F              | RC, RH, W, Y, O, B, G, A |
| * 1E30N-311  | V                                   | ✓            |           |           | ✓                                 |                     |                     |                   | ✓                    |  |   |                                    | ✓  |   | 50 to 90°F / 10 to 32°C | R, W                     |
| * 1E50N-303  | V                                   | ✓            |           |           | ✓                                 |                     |                     |                   | ✓                    | ✓  |   |                                    | ✓  |   | 50 to 90°F / 10 to 32°C | R, W                     |
| * 1E56N-361  | V                                   | ✓            | ✓         | ✓         | ✓                                 | ✓                   | ✓                   | ✓                 | ✓                    |  | ✓   |                                    | ✓  |   | 50 to 90°F / 10 to 32°C | RC, RH, W, Y, O, B, G, A |
| * 1F56N-361  | V                                   | ✓            | ✓         | ✓         | ✓                                 | ✓                   | ✓                   | ✓                 | ✓                    |  | ✓   |                                    | ✓  |   | 50 to 90°F / 10 to 32°C | RC, RH, W, Y, O, B, G, A |

\* Indicates Canadian Model Number: call 1-800-305-6953 to order



**1C20-101**



**1C26-101**

**ECONOMY MECHANICAL THERMOSTATS –  
MERCURY-FREE**

Reliable Performance in an Attractive Design

**FEATURES**

- Rugged snap-action contacts.
- Adjustable heat anticipator.
- Bi-Metal thermometer.
- Heat / Cool model includes switching subbase.
- Heat / Cool model compatible with Electric Heat systems.

**SPECIFICATIONS**

Anticipation Rating, Heating . . . . . Adjustable from 0.15 to 1.2 Amps  
 Anticipation Rating, Cooling . . . . . Fixed  
 Differential, Heating . . . . . 2°F (1.1°C)  
 Differential, Cooling . . . . . 4°F (2.2°C)  
 Dimensions . . . . . 3<sup>3</sup>/<sub>4</sub>" H x 2<sup>7</sup>/<sub>8</sub>" W x 1<sup>1</sup>/<sub>2</sub>" D  
 Dimensions, Switching Models . . . . . 3<sup>3</sup>/<sub>4</sub>" H x 3<sup>1</sup>/<sub>8</sub>" W x 1<sup>5</sup>/<sub>8</sub>" D  
 Electrical Rating . . . . . mV to 30V, 50/60 Hz or DC

**PARTS AND ACCESSORIES** See end of thermostats section for additional parts and accessories

- Wallplate F61-2499 — 5<sup>1</sup>/<sub>8</sub>" H x 5" W
- Thermostat Guards — see pages 34–35

**TECHNICAL HELP**

Configuration/Wiring . . . . . See page 165



| Model Number | Typical Application | Stages Heat / Cool | System Switch | Fan Switch | Contacts    | Anticipation Heat / Cool | Range             | Shape    | Terminals                   |
|--------------|---------------------|--------------------|---------------|------------|-------------|--------------------------|-------------------|----------|-----------------------------|
| 1C20-101     | Heat Only ③         | 1                  | None ①        | None       | Snap-Action | Adjustable               | 50-90°F (10-32°C) | Vertical | R, W                        |
| 1C20-102     | Heat Only           | 1                  | None          | None       | Snap-Action | Adjustable               | 50-90°F (10-32°C) | Vertical | R, W                        |
| 1C21-101     | Cool Only           | 1                  | None          | None       | Snap-Action | Fixed                    | 50-90°F (10-32°C) | Vertical | R, Y                        |
| 1C26-101     | Heat / Cool ②<br>③  | 1 / 1              | Heat-Off-Cool | Auto-On    | Snap-Action | Adjustable / Fixed       | 50-90°F (10-32°C) | Vertical | RC, RH, W,<br>Y, O, B, G, A |

① Lowest temperature setting is "OFF" position  
 ② Includes optional "A" terminal connection for Electric Heat systems that require the thermostat to energize the Blower (G terminal) on a call for heat  
 ③ Includes F61-2499 wall mounting plate to cover marks left by previous thermostat

# LINE VOLTAGE THERMOSTATS QUICK SELECTION GUIDE

White-Rodgers™

# INSTANT EXPERT

|                        | Range Max. | Range Min. | Differential Max. | Differential Min. | Model            | Element                | Capillary Length | Switch Action | Page Number |
|------------------------|------------|------------|-------------------|-------------------|------------------|------------------------|------------------|---------------|-------------|
| <b>HEATING</b>         | 80°F       | 40°F       | 2°F               | 2°F               | <b>1G65-641</b>  | Thermostat Snap Action |                  | Open on Rise  | 28          |
|                        | 80°F       | 40°F       | 2°F               | 2°F               | <b>1G66-641</b>  | Thermostat Snap Action |                  | Open on Rise  | 28          |
|                        | 85°F       | 40°F       | 1°F               | 1°F               | <b>1A65-641</b>  | Hydraulic Knob         |                  | Open on Rise  | 28          |
|                        | 85°F       | 40°F       | 1°F               | 1°F               | <b>1A65W-641</b> | Hydraulic Knob         |                  | Open on Rise  | 28          |
|                        | 85°F       | 40°F       | 1°F               | 1°F               | <b>1A66-641</b>  | Hydraulic Knob         |                  | Open on Rise  | 28          |
|                        | 85°F       | 40°F       | 1°F               | 1°F               | <b>1A66W-641</b> | Hydraulic Knob         |                  | Open on Rise  | 28          |
|                        | 85°F       | 55°F       | 2°F               | 2°F               | <b>152-9</b>     | Thermostat             |                  | Open on Rise  | 32          |
|                        | 95°F       | 55°F       | 2°F               | 2°F               | <b>152-10</b>    | Thermostat             |                  | Open on Rise  | 32          |
| <b>COOLING</b>         | 90°F       | 20°F       | 20°F              | 3°F               | <b>201-8</b>     | Self Contained         |                  | Close on Rise | 31          |
| <b>HEAT &amp; COOL</b> | 90°F       | 36°F       | 1.5°F             | 1.5°F             | <b>1A10-651</b>  | Hydraulic Knob         |                  | SPDT          | 29          |
|                        | 90°F       | 36°F       | 1.5°F             | 1.5°F             | <b>1A11-2</b>    | Hydraulic Knob         |                  | SPDT          | 30          |
|                        | 90°F       | 36°F       | 1.5°F             | 1.5°F             | <b>1A16-51</b>   | Hydraulic Knob         |                  | SPDT          | 29          |
|                        | 95°F       | 55°F       | 3°F               | 3°F               | <b>179-1</b>     | Thermostat             |                  | SPDT          | 31          |

U.S. Models only



**1E65-144**

**LINE VOLTAGE DIGITAL THERMOSTAT**

Line Voltage Digital Thermostats for Applications Covering 150W Up to 4000W. Choice of Programmable or Non-programmable Models. For Electric Baseboard, Convector and Fan-Forced Heater Applications. 1E65-144 will Also Cover Radiant Floor and Ceiling

**FEATURES**

- Large LCD with great contrast for greater viewing.
- 100% silent operation with optional proportional control feature.
- Selectable anticipation for ultimate performance.
- Celsius of Fahrenheit compatible.
- White color.
- Does not contain mercury.

**SPECIFICATIONS**

Display Resolution ..... 1°F (0.1°C)  
Approval ..... C.S.A. approved





**PARTS AND ACCESSORIES** See end of thermostats section for additional parts and accessories

- F61-2642 – Adapter plate for universal mounting.

**TECHNICAL HELP**

Configuration/Wiring Diagram ..... See page 166



| Model Number  | Programmable | Range                        | Differential                           | Switch Action | Display Back Light | Load   |
|---|--------------|------------------------------|--|---------------|--------------------|--|
|  <b>1E65-144</b>   |              | 45° to 90°F<br>(7°C to 32°C) | 0.5°C                                  | Open on Rise  | ✓                  | 2.0A, 120VAC, 250W<br>2.0A, 240VAC, 500W<br>16.7A, 120VAC, 2000W<br>16.7A, 240VAC, 4000W   |
|  <b>1E65-151BL</b> | ✓            | 3° to 30°C                   | Normal Mode: 0.05°C<br>Fan Mode: 0.5°C | Open on Rise  | ✓                  | 1.25A, 120VAC, 150W<br>1.25A, 240VAC, 300W<br>12.5A, 120VAC, 1500W<br>12.5A, 240VAC, 3000W |
|  <b>1E65-151</b>   | ✓            | 3° to 30°C                   | Normal Mode: 0.05°C<br>Fan Mode: 0.5°C | Open on Rise  |                    | 1.25A, 120VAC, 150W<br>1.25A, 240VAC, 300W<br>12.5A, 120VAC, 1500W<br>12.5A, 240VAC, 3000W |
|  <b>1E65-140BL</b> |              | 3° to 30°C                   | Normal Mode: 0.05°C<br>Fan Mode: 0.5°C | Open on Rise  | ✓                  | 1.25A, 120VAC, 150W<br>1.25A, 240VAC, 300W<br>12.5A, 120VAC, 1500W<br>12.5A, 240VAC, 3000W |
|  <b>1E65-140</b>   |              | 3° to 30°C                   | Normal Mode: 0.05°C<br>Fan Mode: 0.5°C | Open on Rise  |                    | 1.25A, 120VAC, 150W<br>1.25A, 240VAC, 300W<br>12.5A, 120VAC, 1500W<br>12.5A, 240VAC, 3000W |

| Features and Benefits          | Honeywell RLV310 | Aube TH109 | CMAC IT3000 | WR 1E65 |
|--------------------------------|------------------|------------|-------------|---------|
| Backlight                      |                  |            |             | ✓       |
| Menu-Driven Options            |                  |            | ✓           | ✓       |
| Large Display                  |                  |            |             | ✓       |
| Large Characters               |                  |            |             | ✓       |
| Power @ 240 VAC                | 3 KW             | 3 KW       | 3 KW        | 4 KW    |
| Consumption Indicator          | 20%              | 20%        | 10%         | 10%     |
| Selectable Anticipation        |                  |            |             | ✓       |
| Adjustable Temperature Display |                  |            |             | ±3°C    |
| Temperature Resolution         | 0.5°C            | 0.5°C      | 1°C         | 0.1°C   |
| Warranty (yrs)                 | 3                | 3          | 1           | 5       |

✻ Indicates Canadian Model Number: call 1-800-305-6953 to order



# LINE VOLTAGE THERMOSTATS

White-Rodgers™



**1A65-641**

## LINE VOLTAGE BASEBOARD THERMOSTATS

Electric Heat Thermostats Used for Controlling Baseboards, Cable Heat, Glass Panels, etc.

### FEATURES

- 1A66 types are a double-pole disconnect model with “OFF” position which mechanically breaks both sides of line.
- Classic White or Beige color.

### SPECIFICATIONS

Dimensions . . . . . 4<sup>1</sup>/<sub>2</sub>” H x 2<sup>3</sup>/<sub>4</sub>” W x 1<sup>1</sup>/<sub>4</sub>” D  
Agency . . . . . U.L. listed and C.S.A. certified

### PARTS AND ACCESSORIES

See end of thermostats section for additional parts and accessories

- F75-0176 – for locking or limiting temperatures at 66°, 69°, 72° or 75°F  
Temperatures limit can also be set at 60° or 63°
- Thermostat Guards — see pages 34–35

| Model Number | Range                  | Switch Action | Load         | Resistive (Non-Inductive)  |
|--------------|------------------------|---------------|--------------|--|
| 1A65-641     | 40 to 85°F (4 to 29°C) | 1.0°F         | Open on Rise | 22.0A, 120 VAC (2500W)<br>22.0A, 240 VAC (5000W)<br>18.0A, 277 VAC (5000W) |
| 1A65W-641 ①  |                        |               |              |  |
| 1A66-641     | 40 to 85°F (4 to 29°C) | 1.0°F         | Open on Rise | 22.0A, 240 VAC (5000W)<br>18.0A, 277 VAC (5000W)                           |
| 1A66W-641 ①  |                        |               |              |  |

① W in model number denotes Classic White Color  
REPLACES HONEYWELL T498A / B SERIES



**1G65-641**

## LINE VOLTAGE BIMETAL WALL THERMOSTATS

Electric Heat Thermostats Used for Controlling Baseboards, Cable Heat, Glass Panels, etc.

### FEATURES

- 1G66 types are a double-pole disconnect model with “OFF” position which mechanically breaks both sides of line.
- Classic white.

### SPECIFICATIONS

Dimensions . . . . . 4<sup>13</sup>/<sub>16</sub>” H x 3<sup>5</sup>/<sub>16</sub>” W x 1<sup>7</sup>/<sub>16</sub>” D  
Agency . . . . . U.L. listed and C.S.A. certified

### PARTS AND ACCESSORIES

See end of thermostats section for additional parts and accessories

- Thermostat Guards — see pages 34–35



**1G66-633**

| Model Number | Range                  | Switch Action | Load         | Resistive (Non-Inductive)  |
|--------------|------------------------|---------------|--------------|--|
| 1G65-633     | 4 to 26°C (40 to 80°F) | 0.5°C         | Open on Rise | 22.0A, 120 VAC (2500W)<br>22.0A, 240 VAC (5000W)<br>18.0A, 277 VAC (5000W) |
| 1G65-641     | 40 to 80°F (4 to 26°C) | 2.0°F         | Open on Rise | 22.0A, 120 VAC (2500W)<br>22.0A, 240 VAC (5000W)<br>18.0A, 277 VAC (5000W) |
| 1G66-633     | 4 to 26°C (40 to 80°F) | 0.5°C         | Open on Rise | 22.0A, 240 VAC (5000W)<br>18.0A, 277 VAC (5000W)                           |
| 1G66-641     | 40 to 80°F (4 to 26°C) | 2.0°F         | Open on Rise | 22.0A, 240 VAC (5000W)<br>18.0A, 277 VAC (5000W)                           |



**1A10-651  
with S29-21 subbase**

**1A10-651 LIGHT DUTY AND 1A16-51 HEAVY DUTY  
LINE VOLTAGE THERMOSTATS**

For Direct Control of Fan Coils, Fans, Motor Starters, Circulator Motors, Contactors, Valves for Heating, Cooling and SPDT Applications

**FEATURES**

- Two dial stops for setting a maximum or minimum temperature. Minimum between 66 to 87°F. Maximum between 60 to 81°F.
- Thermostat mounts on 2" x 4" electrical box.
- Includes set point locking feature at 66°, 69°, 72°, 75°, 78° or 81°F
- Optional heating and cooling subbase S29-21 available.
- Beige color.
- Does not contain mercury.

**SPECIFICATIONS**

Dimensions without subbase, knob & case . . . . 4<sup>1</sup>/<sub>2</sub>"H x 3<sup>7</sup>/<sub>8</sub>"W x 1<sup>3</sup>/<sub>4</sub>"D (Vertical)  
 Dimensions with subbase, knob & case . . . . . 5<sup>1</sup>/<sub>8</sub>"H x 2<sup>7</sup>/<sub>8</sub>"W x 2<sup>3</sup>/<sub>4</sub>"D (Vertical)  
 Agency . . . . . U.L. listed and C.S.A. certified

**PARTS AND ACCESSORIES**

See end of thermostats section for additional parts and accessories

- Thermostats guards – see pages 34–35

| Model Number | Range                     | Differential | Switch Action | A.C. Electrical Ratings |           |              |                           |           |              | Pilot Duty |
|--------------|---------------------------|--------------|---------------|-------------------------|-----------|--------------|---------------------------|-----------|--------------|------------|
|              |                           |              |               | Heat                    |           |              |                           | Cool      |              |            |
|              |                           |              |               | Voltage                 | Full Load | Locked Rotor | Resistive (Non-Inductive) | Full Load | Locked Rotor |            |
| 1A10-651     | 36 to 90°F<br>(2 to 32°C) | 1.5°F        | SPDT          | 120                     | 8.0A      | 48.0A        | 8.0A                      | 8.0A      | 48.0A        | 125 VA     |
|              |                           |              |               | 240 / 277               | 4.0A      | 24.0A        | 8.0A                      | 4.0A      | 24.0A        | 125 VA     |
| 1A16-51      | 36 to 90°F<br>(2 to 32°C) | 1.5°F        | SPDT          | 120                     | 16.0A     | 96.0A        | 16.0A                     | 8.0A      | 48.0A        | 125 VA     |
|              |                           |              |               | 240 / 277               | 8.0A      | 48.0A        | 16.0A                     | 4.0A      | 24.0A        | 125 VA     |

| Model Number | System Switching  | Thermostat Used   | Thermostat Style |
|--------------|-------------------|-------------------|------------------|
| S29-21       | Cool – OFF – Heat | 1A10-651, 1A16-51 | Vertical         |

# LINE VOLTAGE THERMOSTATS

White-Rodgers™



**1A11-2**

## 1A11-2 LIGHT DUTY FAN COIL THERMOSTAT

For Direct Control of Line Voltage Valves and/or Blower Motors on Fan Coil Units Featuring Manual Changeover from Heat to Cool and a 3-Speed Fan Switch, Subbase Included

### FEATURES

- Mounts to a standard vertical outlet box or on a two-gang outlet box. May also be mounted on a 4" x 4" junction box with an adapter (not provided).
- Wiring color coded for ease of installation.
- 3-speed manual fan switch: High – Medium – Low.
- System Switch: Heat – OFF – Cool. "OFF" breaks both valve and fan circuits.
- Beige color.

### SPECIFICATIONS

Dimensions . . . . . 4<sup>1</sup>/<sub>2</sub>" H x 4<sup>1</sup>/<sub>2</sub>" W x 2<sup>1</sup>/<sub>4</sub>" D

Agency . . . . . U.L. listed and C.S.A. approved

### PARTS AND ACCESSORIES

See end of thermostats section for additional parts and accessories

- Thermostat Guards — see pages 34–35

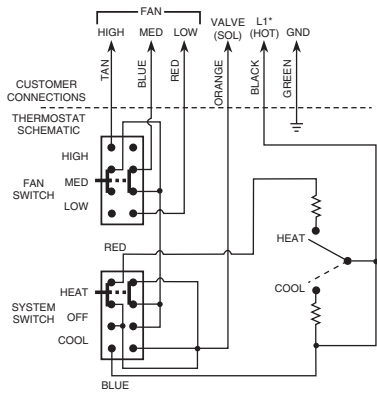

\*L1 is Power In  
Note: Above FAN and SYSTEM switches shown in MED and HEAT positions respectively.

**1A11-2**  
5-wire with ground, for single valve,  
manual heat/cool changeover

- Thermostat cycles both fan and valve
- Thermostat cycles fan only (if valve is not used tape orange lead)
- System "OFF" breaks both valve and fan circuits
- Thermostat cycles valve only with continuous fan (interchange valve and L1 leads)

| Model Number | Range                     | Differential | Switch Action | Contact Ratings                     |         |         |  |         |         |            |
|--------------|---------------------------|--------------|---------------|-------------------------------------|---------|---------|--|---------|---------|------------|
|              |                           |              |               | Motor Ratings (inductive) Full Load |         |         | Motor Ratings (inductive) Locked Rotor |         |         | Pilot Duty |
| 1A11-2       | 36 to 90°F<br>(2 to 32°C) | 1.5°F        | SPDT          | 120 VAC                             | 240 VAC | 277 VAC | 120 VAC                                | 240 VAC | 277 VAC | 277 VAC    |
|              |                           |              |               | 5.5A                                | 2.75A   | 2.3A    | 33.0A                                  | 16.5A   | 13.8A   | 120A       |



**201-8**

**HEAVY DUTY SPACE THERMOSTATS FOR COOLING**

Designed for Use in Garages, Factories, Warehouses and Similar Commercial and Industrial Installations

**FEATURES**

- Dust, moisture and vermin resistant heavy metal case.
- No leveling required – Mounts in any position.
- Quick response to temperature changes.
- Nickel plated element.
- Extra rugged switch mechanism.

**SPECIFICATIONS**

Dimensions . . . . . 5<sup>3</sup>/<sub>8</sub>" H x 2<sup>1</sup>/<sub>2</sub>" W x 2<sup>5</sup>/<sub>16</sub>" D (Vertical)  
 Finish . . . . . Grey Color  
 Agency . . . . . U.L. listed and C.S.A. approved

| Model Number | Range                   | Differential               | System Action | Full Electrical Rating | Bulb Size | Capillary Length | Motor Rating (Full Load) |         | Resistive (Non-Inductive) |         |
|--------------|-------------------------|----------------------------|---------------|------------------------|-----------|------------------|--------------------------|---------|---------------------------|---------|
|              |                         |                            |               |                        |           |                  | 120 VAC                  | 240 VAC | 120 VAC                   | 240 VAC |
| 201-8        | 20 to 90°F (-7 to 32°C) | Adj. 3 to 20°F (2 to 11°C) | Close on Rise | FGH<br>See page 222    | 16.0A     | 8.0A             | 5.6A                     | 2.8A    | 25.0A                     | 22.0A   |



**179-1**

**LINE VOLTAGE THERMOSTAT FOR HEATING / COOLING**

Control Suitable for Fans or Water Solenoids on Heating / Cooling Convector or Any Similar Application that Requires a Heavy Duty Room Thermostat with Single Pole, Double Throw (SPDT) Switch Action

**FEATURES**

- Can handle many cooling installations without use of relay or motor starter.
- Heavy gauge steel case – Mounts on vertical 2" x 4" box or flus to wall.
- Hydraulic action element – Unaffected by motion – No leveling required.
- Dustproof case.

**SPECIFICATIONS**

Dimensions . . . . . 6" H x 2<sup>3</sup>/<sub>4</sub>" W x 2<sup>1</sup>/<sub>2</sub>" D  
 Finish . . . . . Grey Color  
 Agency . . . . . U.L. listed and C.S.A. approved

**PARTS AND ACCESSORIES** See end of thermostats section for additional parts and accessories

- Thermostat Guards — see pages 34–35

| Model Number | Range                   | Differential        | Action             | Full Electrical Rating | Motor Rating (Full Load) |         |
|--------------|-------------------------|---------------------|--------------------|------------------------|--------------------------|---------|
|              |                         |                     |                    |                        | 120 VAC                  | 240 VAC |
| 179-1        | 55 to 95°F (13 to 35°C) | Fixed 3.0°F (1.6°C) | SPDT (Heat / Cool) | SPDT<br>See page 222   | 7.4A                     | 3.7     |

## LINE VOLTAGE THERMOSTATS / WIRELESS REMOTE SENSOR White-Rodgers™



**152-9**

### LINE VOLTAGE THERMOSTATS FOR HEATING

For Control of Most Line Voltage Heating Applications without Use of Relays or Motor Starters

#### FEATURES

- “Summer” dial position (152-9 model)
- Heavy gauge steel case – Mounts on vertical 2" x 4" box or flush to wall.
- Hydraulic action element – Unaffected by motion – No leveling required.
- Dustproof case.

#### SPECIFICATIONS

Dimensions . . . . . 4½" H x 4½" W x 2¼" D  
Agency . . . . . U.L. listed and C.S.A. approved

#### PARTS AND ACCESSORIES See end of thermostats section for additional parts and accessories

- Thermostat Guards — see pages 34–35

| Model Number | Range                      | Differential         | Action       | Full Electrical Rating | Motor Rating (Full Load) |         | Motor Rating (Non-Inductive) |         |         |
|--------------|----------------------------|----------------------|--------------|------------------------|--------------------------|---------|------------------------------|---------|---------|
|              |                            |                      |              |                        | 120 VAC                  | 240 VAC | 120 VAC                      | 240 VAC | 277 VAC |
| 159-9*       | 55 to 85°F<br>(13 to 29°C) | Fixed 2°F<br>(1.0°C) | Open on Rise | FG<br>See page 222     | 14.0A                    | 7.0A    | 25.0A                        | 22.0A   | 18.0A   |
| 152-10**     | 40 to 90°F<br>(4 to 32°C)  | Fixed 3°F<br>(1.6°C) | Open on Rise | FG<br>See page 222     | 14.0A                    | 7.0A    | 25.0A                        | 20.0A   | –       |

\* Summer fan position control only has two terminals. It thermostatically cycles (based on temperature) unless set to the summer fan position in which case the contacts are closed.

\*\*Locked case, concealed dial.



**F145RF-1600**  
**Wireless Remote Sensor**

### WIRELESS REMOTE SENSORS FOR 1F98EZ-1621 WIRELESS THERMOSTAT SYSTEM

Wireless Indoor and Outdoor Sensors for use with 1F98EZ-1621 Emerson Blue Wireless Easy Install Thermostat System

#### FEATURES

- Up to 3 indoor and 1 outdoor wireless remote sensors can be used on one 1F98EZ-1621 wireless thermostat system.
- Battery powered with 2 "AA" alkaline batteries

#### SPECIFICATIONS

Operating Temperature Range . . . . . 0° to 120°F (-18° to 49°C)  
Battery . . . . . 2 "AA" Alkaline Batteries  
Operating Humidity Range . . . . . 0 to 85% RH (non-condensing)  
Color . . . . . Classic White  
Weight . . . . . Weighs less than 0.25 lb  
Dimension . . . . . 4½" H x 3¼" W x 1½" D  
Maximum Distance from Interface . . . . . 300'

#### PARTS AND ACCESSORIES See end of thermostats section for additional parts and accessories

- Thermostat Guards — see pages 34–35

#### WIRELESS REMOTE SENSOR (INDOOR OR OUTDOOR)

| Model Number | Color         | Dimensions      | Application  |
|--------------|---------------|-----------------|--|
| F145RF-1600  | Classic White | 4½" x 3¼" x 1½" | Compatible with Emerson Blue Wireless Easy Install Thermostat System |



**F145-1328**  
**Indoor Remote Sensor**



**F145-1378**  
**Outdoor Remote Sensor**

**WIRED REMOTE SENSORS FOR 24V THERMOSTATS**  
Indoor and Outdoor Sensors for Emerson Blue Digital Thermostats

**FEATURES**

- Digital signal output provides superior temperature control, even over long wire runs.
- No temperature variance caused by wire resistance.
- Perfect for securing the thermostat in one area or room while sensing temperature in the conditioned space.

**SPECIFICATIONS**

Operating Range (based on thermostat range)  
 Indoor Models . . . . . 40 to 99°F  
 Outdoor Models . . . . . -40 to 140°F  
 Operating Humidity Range . . . . . 0 to 90% RH (non-condensing)  
 Maximum Distance from Thermostat . . . 300'  
 Recommended Wire . . . . . 20 gauge, 3-conductor cable

**TECHNICAL HELP** See end of thermostats section for additional parts and accessories

Remote Sensor Wiring / Troubleshooting . . . . . See page 167–170



**INDOOR SENSOR**

| Model Number | Color         | Dimensions             | Application   |
|--------------|---------------|------------------------|---|
| F145-1328    | Classic White | 2 1/8" x 3 1/2" x 3/4" | Compatible with all Emerson Emerson / White-Rodgers Thermostats with Indoor Remote Sensor |

**OUTDOOR SENSOR**

| Model Number | Color         | Dimensions             | Application   |
|--------------|---------------|------------------------|---|
| F145-1378    | Classic White | 2 1/8" x 3 1/2" x 3/4" | Compatible with all Emerson Emerson / White-Rodgers Thermostats with Outdoor Remote Sensing. 12 ft. sensor lead |

**CONNECTION CROSS REFERENCE - THERMOSTATS & SENSORS**

| Old Terminal (Thermostat or Remote) | New Terminal (Thermostat or Remote) |
|-------------------------------------|-------------------------------------|
| S1                                  | +                                   |
| S2                                  | S                                   |
| S3                                  | -                                   |

**CONTRACTOR TIP:** REMOTE SENSOR TROUBLESHOOTING, WIRING AND AVERAGING INFORMATION IS ON PAGES 167–170.

**REMOTE TERMINAL DESIGNATIONS**

| Model Number          | Terminal Designation Cross Reference |                      |                 |
|-----------------------|--------------------------------------|----------------------|-----------------|
| F145-1328 , F145-1378 | +                                    | S                    | -               |
|                       | Sensor Positive                      | Sensor Return Signal | Sensor Negative |

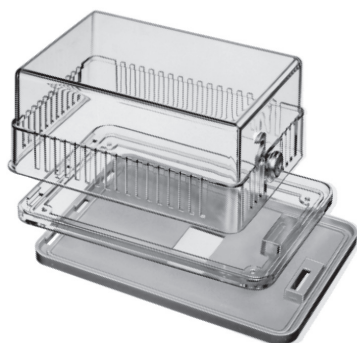

F29-0198

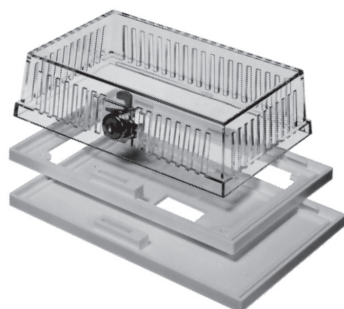

F29-0231

## THERMOSTAT GUARDS – PLASTIC

These Durable Thermostat Guards are Designed for Use in Offices, Churches, Restaurants and Other Public Areas to Prevent Adjustment of the Temperature by Unauthorized Personnel

### FEATURES

- F29-0198 fits ALL Emerson / White-Rodgers thermostats.
- Each model furnished with one key and can be mounted vertically or horizontally.
- Clear plastic models for applications that need the thermostat visible.
- Opaque plastic models for applications that require the thermostat be kept hidden from view.
- Each model furnished with a ring and/or solid wall mounting plate.

### PARTS AND ACCESSORIES

- F145-0999 – Replacement key (1)

| Model Number | Description   | Horizontal (Ring) Inside Dimensions |                                 |                                 | Horizontal (Solid) Inside Dimensions |                                 |                                 | BEKO Number |
|--------------|---------------|-------------------------------------|---------------------------------|---------------------------------|--------------------------------------|---------------------------------|---------------------------------|-------------|
|              |               | Length                              | Height                          | Depth                           | Length                               | Height                          | Depth                           |             |
| F29-0143     | Clear Plastic | 6 <sup>1</sup> / <sub>4</sub> "     | 3 <sup>3</sup> / <sub>8</sub> " | 3 <sup>1</sup> / <sub>4</sub> " | 6 <sup>3</sup> / <sub>8</sub> "      | 3 <sup>1</sup> / <sub>2</sub> " | 3"                              | BTG-RK      |
| F29-0198     | Clear Plastic | 8 <sup>1</sup> / <sub>8</sub> "     | 4 <sup>5</sup> / <sub>8</sub> " | 3 <sup>5</sup> / <sub>8</sub> " | 8 <sup>1</sup> / <sub>4</sub> "      | 5 <sup>3</sup> / <sub>8</sub> " | 3 <sup>1</sup> / <sub>2</sub> " | BTG-UK2     |
| F29-0225     | Clear Plastic | Mounting Plate, No Ring             |                                 |                                 | 3 <sup>7</sup> / <sub>8</sub> "      | 3 <sup>1</sup> / <sub>2</sub> " | 2 <sup>1</sup> / <sub>2</sub> " | BTG-EK      |
| F29-0227     | Clear Plastic | 5 <sup>1</sup> / <sub>4</sub> "     | 4 <sup>5</sup> / <sub>8</sub> " | 3 <sup>1</sup> / <sub>4</sub> " | 5 <sup>1</sup> / <sub>4</sub> "      | 4 <sup>5</sup> / <sub>8</sub> " | 3"                              | BTG-K       |
| F29-0231     | Clear Plastic | 7 <sup>1</sup> / <sub>16</sub> "    | 4 <sup>1</sup> / <sub>8</sub> " | 2 <sup>1</sup> / <sub>4</sub> " | 7 <sup>5</sup> / <sub>8</sub> "      | 4 <sup>1</sup> / <sub>4</sub> " | 2 <sup>1</sup> / <sub>8</sub> " | TG-DK       |



### TECHNICAL HELP

For a list of thermostat guard choices by thermostat model number . . See chart below

| Thermostat Guard Selection    | Plastic                    |       |               |       |               |               |       |               |       |  |
|-------------------------------|----------------------------|-------|---------------|-------|---------------|---------------|-------|---------------|-------|--|
|                               | Clear Plastic              |       | Clear Plastic |       | Clear Plastic | Clear Plastic |       | Clear Plastic |       |  |
| Thermostat Guard Model Number | F29-0143                   |       | F29-0198      |       | F29-0225      | F29-0227      |       | F29-0231      |       |  |
| Base Style                    | Ring                       | Solid | Ring          | Solid | Solid         | Ring          | Solid | Ring          | Solid |  |
| MECHANICAL                    | 1C20 Series                | √     | √             | √     | √             | √             | √     | √             | √     |  |
|                               | 1C30 Series                | √     | √             | √     | √             | NO            | √     | √             | √     |  |
|                               | 1D30 / 36 / 56 Series      | √     | √             | √     | √             | NO            | √     | √             | √     |  |
|                               | 1E30 / 31 / 35 / 56 Series | √     | √             | √     | √             | NO            | √     | √             | √     |  |
|                               | 1F30 Series                | √     | √             | √     | √             | NO            | √     | √             | √     |  |
|                               | 1F51 / 56 / 57 Series      | √     | √             | √     | √             | NO            | √     | √             | √     |  |
|                               | 1F58-58 / 1F58-72          | √     | √             | √     | √             | NO            | NO    | NO            | √     |  |
| 1F58-77                       | √                          | √     | √             | √     | NO            | √             | √     | √             |       |  |
| DIGITAL                       | 1E78 Series                | NO    | NO            | √     | √             | NO            | √     | √             | √     |  |
|                               | 1F70 Series                | NO    | NO            | √     | √             | NO            | √     | √             | √     |  |
|                               | 1F80 BLUE                  | √     | √             | √     | √             | NO            | √     | √             | √     |  |
|                               | 1F80 Classic Series        | NO    | NO            | √     | √             | NO            | NO    | NO            | √     |  |
|                               | 1F90 BLUE Series           | NO    | NO            | √     | √             | NO            | NO    | NO            | NO    |  |
|                               | 1F90 Series (Obsolete)     | NO    | NO            | √     | √             | NO            | NO    | NO            | √     |  |

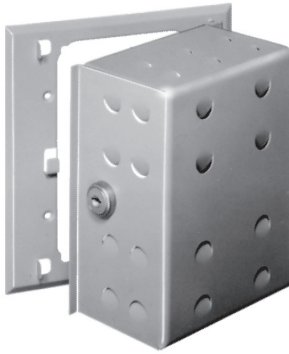

**F29-0193**

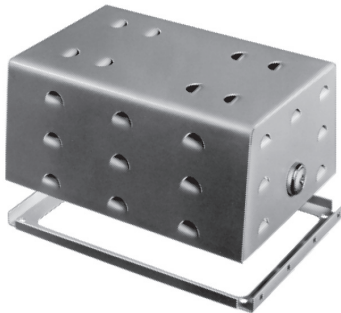

**F29-0222**

**THERMOSTAT GUARDS – METAL**

These Durable Metal Guards are Designed for Government, Military, Industrial and Educational Applications to Prevent Adjustment of the Temperature by Unauthorized Personnel

**FEATURES**

- Model F29-0220 fits ALL Emerson / White-Rodgers Thermostats.
- Each model furnished with one key and can be mounted vertically or horizontally.
- Tamper-resistant design. 18 gauge cover, 22 gauge frame.
- Beige enamel finish over heavy-duty steel enclosure.
- Models available in a ring or solid base.

**PARTS AND ACCESSORIES**

- F145-0999 – Replacement key (1)

| Model Number | Description | Horizontal (Ring) Inside Dimensions |          |        | Comments     | BEKO Number |
|--------------|-------------|-------------------------------------|----------|--------|--------------|-------------|
|              |             | Length                              | Height   | Depth  |              |             |
| F29-0192     | Solid base  | 6 1/4"                              | 4 3/4"   | 3"     | Hinged cover | BTG-54VL    |
| F29-0193     | Ring base   | 6"                                  | 3 13/16" | 3 1/8" | Hinged cover | BTG-54VLW   |
| F29-0220     | Solid base  | 7 1/8"                              | 4 5/8"   | 3 1/4" | –            | BTG-UM      |
| F29-0222     | Ring base   | 6 5/8"                              | 4 1/2"   | 3 3/8" | –            | BTG-UWM     |









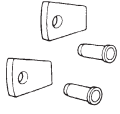
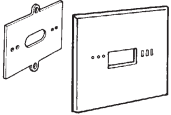
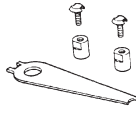
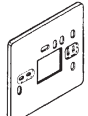
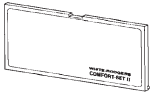
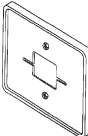
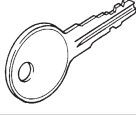
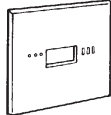

**TECHNICAL HELP**

For a list of thermostat guard choices by thermostat model number . . See chart below

| Thermostat Guard Selection    | Metal                      |          |          |          |   |
|-------------------------------|----------------------------|----------|----------|----------|---|
|                               | Hinged Cover               |          | No Hinge |          |   |
| Thermostat Guard Model Number | F29-0192                   | F29-0193 | F29-0220 | F29-0222 |   |
| Base Style                    | Solid                      | Ring     | Solid    | Ring     |   |
| MECHANICAL                    | 1C20 Series                | √        | √        | √        | √ |
|                               | 1C30 Series                | √        | √        | √        | √ |
|                               | 1D30 / 36 / 56 Series      | √        | √        | √        | √ |
|                               | 1E30 / 31 / 35 / 56 Series | √        | √        | √        | √ |
|                               | 1F30 Series                | √        | √        | √        | √ |
|                               | 1F51 / 56 / 57 Series      | √        | √        | √        | √ |
|                               | 1F58-58 / 1F58-72          | √        | √        | √        | √ |
|                               | 1F58-77                    | √        | √        | √        | √ |
| DIGITAL                       | 1E78 Series                | √        | √        | √        | √ |
|                               | 1F70 Series                | √        | √        | √        | √ |
|                               | 1F80 BLUE                  | √        | √        | √        | √ |
|                               | 1F80 Classic Series        | NO       | √        | √        | √ |
|                               | 1F90 BLUE Series           | NO       | NO       | √        | √ |
|                               | 1F90 Series (Obsolete)     | NO       | √        | √        | √ |

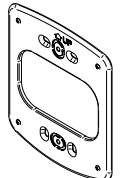
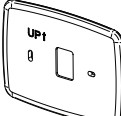

## THERMOSTAT ACCESSORIES

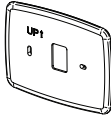
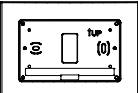
| Item Number   | Model Number    | Description   | Item Number   | Model Number       | Description  |
|---|-----------------|---|---|--------------------|--|
|    | <b>F16-8101</b> | Cover assembly for 1F78-151 programmable.   |    | <b>F75-0176</b>    | Temperature knob locking or limiting kit for 1A65-641, 1A65W-641, 1A66-641 and 1A66W-641.                            |
|    | <b>F61-2301</b> | Wallplate for low voltage standard thermostats (5 <sup>5</sup> / <sub>8</sub> " H x 5 <sup>3</sup> / <sub>4</sub> " W). Beige. Includes adapter for mounting to vertical junction box. Same as F61-2068 except white.                     |    | <b>F92-0563</b>    | Temperature lever locking or temperature limiting kit for low voltage thermostats except 1C70, 1C20 and 1E26 series. |
|    | <b>F61-2300</b> | Wallplate for all 1F90 series thermostats (except Blue models), (7 <sup>1</sup> / <sub>4</sub> " W x 5 <sup>1</sup> / <sub>2</sub> " H), Classic White color, includes adapter plate for mounting to horizontal or vertical junction box. |    | <b>F145-1082</b>   | Replacement door 1F90/1F97 (-51, -60, -71) 1F91-71, 1F92-71, 1F94-71, 1F95-71.                                       |
|    | <b>F61-2499</b> | Wallplate for 1C20-xxx/1C26-xxx (5 <sup>5</sup> / <sub>8</sub> " H x 5" W)  |    | <b>F145-0999</b>   | Replacement key for all thermostat guards, F29 series.   |
|   | <b>F61-2500</b> | Wallplate for all 1F80 series thermostats (except Blue models), (7 <sup>5</sup> / <sub>8</sub> " W x 4 <sup>3</sup> / <sub>4</sub> " H), Classic White color, includes adapter plate for mounting to horizontal or vertical junction box. |    | <b>F145-1328</b>   | 90 Series Wired Indoor Remote Sensor. Replaces all previous Indoor Remote Sensors.                                   |
|  | <b>F61-2510</b> | Wallplate for all 1F70 series thermostats, 6 <sup>1</sup> / <sub>2</sub> " W x 4 <sup>1</sup> / <sub>2</sub> " H, Classic White color, Includes adapter plate for mounting to horizontal or vertical junction box.                        |  | <b>F145-1378</b>   | 90 Series Wired Outdoor Temperature Sensor, For Models with Outdoor Sensor Option.                                   |
|  | <b>F61-2550</b> | Wallplate for all 1F70 series thermostats, 6 <sup>1</sup> / <sub>2</sub> " W x 4 <sup>1</sup> / <sub>2</sub> " H, Classic White color, does not include adapter plate for mounting to horizontal or vertical junction box.                |  | <b>F61-2648</b>    | Same as F61-2634 except 6 pack.  |
|  | <b>F61-2593</b> | Wallplate for 1D70 or 1E70 series thermostats, 4 <sup>1</sup> / <sub>2</sub> " W x 6 <sup>19</sup> / <sub>32</sub> " H, Classic White color.  |  | <b>F61-2642</b>    | Universal adapter plate for 1E65-144   |
|  | <b>F61-2600</b> | Wallplate for 90 series Blue Touchscreen thermostats, 8 <sup>1</sup> / <sub>8</sub> " W x 5 <sup>3</sup> / <sub>8</sub> " H, Classic White color, for use with or without horizontal junction box.  |  | <b>F145RF-1600</b> | Wireless remote sensor for 1F98EZ-1621   |
|  | <b>F61-2634</b> | Wallplate for 90 and 80 series Blue thermostats, 6 <sup>1</sup> / <sub>2</sub> " W x 5" H, Classic White color, for use with or without horizontal junction box.  |   |                    |  |
|  | <b>F61-2663</b> | Wallplate for Sensi Wi-Fi Thermostat, white, 6 <sup>3</sup> / <sub>4</sub> " W x 4 <sup>1</sup> / <sub>2</sub> " H for use with or without horizontal junction box  |   |                    |  |