

Thyristor High Voltage, Phase Control SCR, 40 A

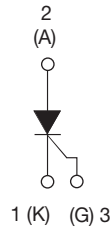

TO-247AC 3L



FEATURES

- Designed and qualified according to JEDEC®-JESD 47
- Low I_{GT} parts available
- 125 °C max. operating junction temperature
- Material categorization: for definitions of compliance please see www.vishay.com/doc?99912



RoHS
COMPLIANT
HALOGEN
FREE
Available

APPLICATIONS

- Typical usage is in input rectification crowbar (soft start) and AC switch motor control, UPS, welding and battery charge

DESCRIPTION

The VS-40TPS... high voltage series of silicon controlled rectifiers are specifically designed for medium power switching and phase control applications. The glass passivation technology used has reliable operation up to 125 °C junction temperature.

PRIMARY CHARACTERISTICS	
$I_{T(AV)}$	35 A
V_{DRM}/V_{RRM}	800 V, 1200 V
V_{TM}	1.45 V
I_{GT}	150 mA
T_J	-40 °C to +125 °C
Package	TO-247AC 3L
Circuit configuration	Single SCR

MAJOR RATINGS AND CHARACTERISTICS			
PARAMETER	TEST CONDITIONS	VALUES	UNITS
$I_{T(AV)}$	Sinusoidal waveform	35	A
I_{RMS}		55	
V_{RRM}/V_{DRM}		800 to 1200	V
I_{TSM}		600	A
V_T	40 A, $T_J = 25$ °C	1.45	V
dV/dt		1000	V/ μ s
dI/dt		100	A/ μ s
T_J		-40 to +125	°C

VOLTAGE RATINGS			
PART NUMBER	V_{RRM}/V_{DRM} , MAXIMUM REPETITIVE PEAK AND OFF-STATE VOLTAGE V	V_{RSM} , MAXIMUM NON-REPETITIVE PEAK REVERSE VOLTAGE V	I_{RRM}/I_{DRM} AT 125 °C mA
VS-40TPS08A-M3	800	900	10
VS-40TPS08-M3	800	900	
VS-40TPS12A-M3	1200	1300	
VS-40TPS12-M3	1200	1300	



ABSOLUTE MAXIMUM RATINGS					
PARAMETER	SYMBOL	TEST CONDITIONS		VALUES	UNITS
Maximum average on-state current	$I_{T(AV)}$	$T_C = 79\text{ }^\circ\text{C}$, 180° conduction half sine wave		35	A
Maximum continuous RMS on-state current as AC switch	$I_{T(RMS)}$			55	
Maximum peak, one-cycle non-repetitive surge current	I_{TSM}	10 ms sine pulse, rated V_{RRM} applied		500	A ² s
		10 ms sine pulse, no voltage reapplied		600	
Maximum I^2t for fusing	I^2t	10 ms sine pulse, rated V_{RRM} applied		1250	
		10 ms sine pulse, no voltage reapplied		1760	
Maximum $I^2\sqrt{t}$ for fusing	$I^2\sqrt{t}$	$t = 0.1\text{ ms to }10\text{ ms}$, no voltage reapplied		17 600	A ² √s
Low level value of threshold voltage	$V_{T(TO)1}$	$T_J = 125\text{ }^\circ\text{C}$		1.02	V
High level value of threshold voltage	$V_{T(TO)2}$			1.23	
Low level value of on-state slope resistance	r_{t1}			9.74	mΩ
High level value of on-state slope resistance	r_{t2}			7.50	
Maximum peak on-state voltage	V_{TM}	110 A, $T_J = 25\text{ }^\circ\text{C}$		1.85	V
Maximum rate of rise of turned-on current	di/dt	$T_J = 25\text{ }^\circ\text{C}$		100	A/μs
Maximum holding current	I_H	Anode supply = 6 V, resistive load, initial $T_J = 1\text{ A}$, $I_T = 25\text{ }^\circ\text{C}$		200	mA
Maximum latching current	I_L	Anode supply = 6 V, resistive load, $T_J = 25\text{ }^\circ\text{C}$		300	
Maximum reverse and direct leakage current	I_{RRM}/I_{DRM}	$T_J = 25\text{ }^\circ\text{C}$	$V_R = \text{Rated } V_{RRM}/V_{DRM}$	0.5	mA
		$T_J = 125\text{ }^\circ\text{C}$		10	
Maximum rate of rise of off-state voltage 40TPS12A	dV/dt	$T_J = T_J\text{ maximum}$, linear to 80 % V_{DRM} , $R_g - k = 100\text{ }^\circ\Omega$		500	V/μs
Maximum rate of rise of off-state voltage 40TPS12				1000	

TRIGGERING					
PARAMETER	SYMBOL	TEST CONDITIONS		VALUES	UNITS
Maximum peak gate power	P_{GM}			10	W
Maximum average gate power	$P_{G(AV)}$			2.5	
Maximum peak gate current	I_{GM}			2.5	A
Maximum peak negative gate voltage	$-V_{GM}$			10	V
Maximum required DC gate voltage to trigger	V_{GT}	$T_J = -40\text{ }^\circ\text{C}$	Anode supply = 6 V resistive load	4.0	V
		$T_J = 25\text{ }^\circ\text{C}$		2.5	
		$T_J = 125\text{ }^\circ\text{C}$		1.7	
Maximum required DC gate current to trigger	I_{GT}	$T_J = -40\text{ }^\circ\text{C}$	Anode supply = 6 V resistive load	270	mA
		$T_J = 25\text{ }^\circ\text{C}$		150	
		$T_J = 125\text{ }^\circ\text{C}$		80	
		$T_J = 25\text{ }^\circ\text{C}$, for 40TPS..APbF and 40TPS..A-M3		40	
Maximum DC gate voltage not to trigger for 40TPS12	V_{GD}	$T_J = 125\text{ }^\circ\text{C}$, $V_{DRM} = \text{rated value}$		0.25	V
Maximum DC gate current not to trigger for 40TPS12	I_{GD}			6	mA
Maximum DC gate voltage not to trigger for 40TPS12A	V_{GD}	$T_J = 125\text{ }^\circ\text{C}$, $V_{DRM} = \text{rated value}$		0.15	V
Maximum DC gate current not to trigger for 40TPS12A	I_{GD}			1	mA



THERMAL AND MECHANICAL SPECIFICATIONS				
PARAMETER	SYMBOL	TEST CONDITIONS	VALUES	UNITS
Maximum junction and storage temperature range	T_J, T_{Stg}		-40 to +125	°C
Maximum thermal resistance, junction to case	R_{thJC}	DC operation	0.6	°C/W
Maximum thermal resistance, junction to ambient	R_{thJA}		40	
Maximum thermal resistance, case to heatsink	R_{thCS}	Mounting surface, smooth and greased	0.2	
Approximate weight			6	g
			0.21	oz.
Mounting torque	minimum		6 (5)	kgf · cm (lbf · in)
	maximum		12 (10)	
Marking device		Case style TO-247AC 3L	40TPS08A	
			40TPS12A	
			40TPS08	
			40TPS12	

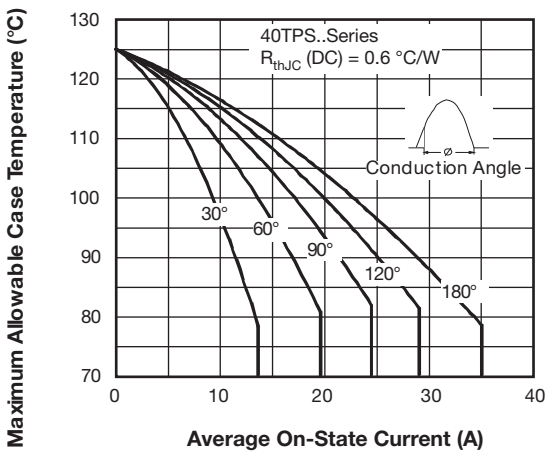

Fig. 1 - Current Rating Characteristics

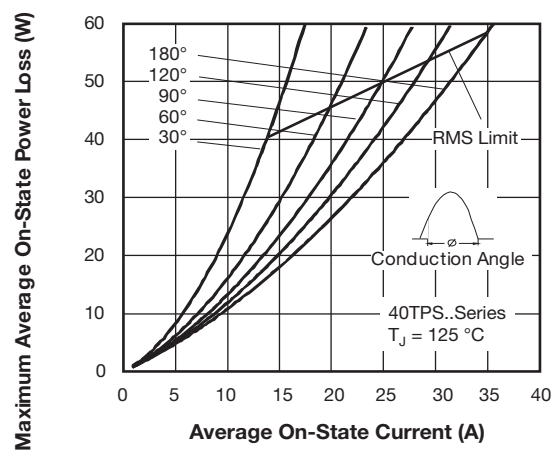

Fig. 3 - On-State Power Loss Characteristics

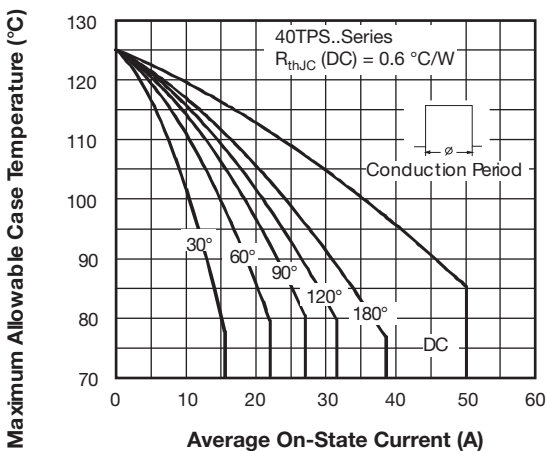

Fig. 2 - Current Rating Characteristics

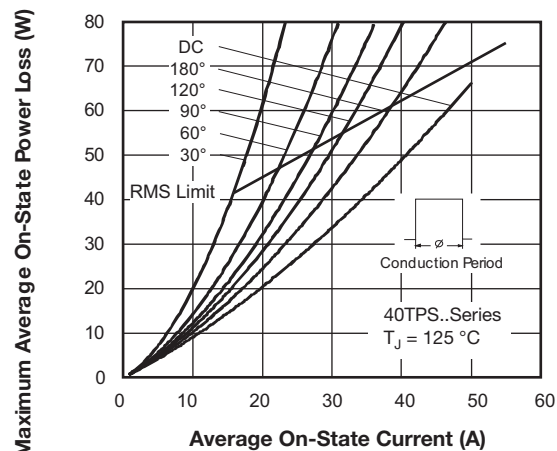

Fig. 4 - On-State Power Loss Characteristics

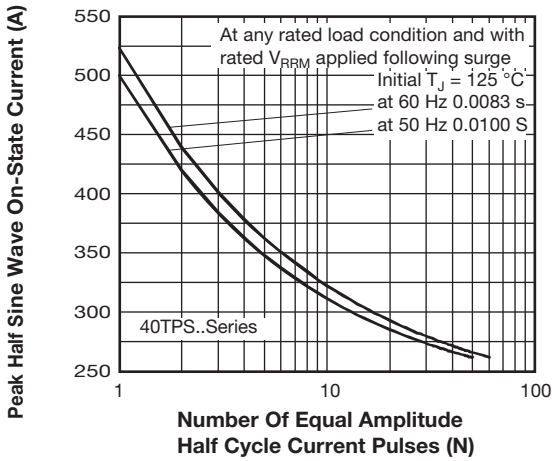

Fig. 5 - Maximum Non-Repetitive Surge Current

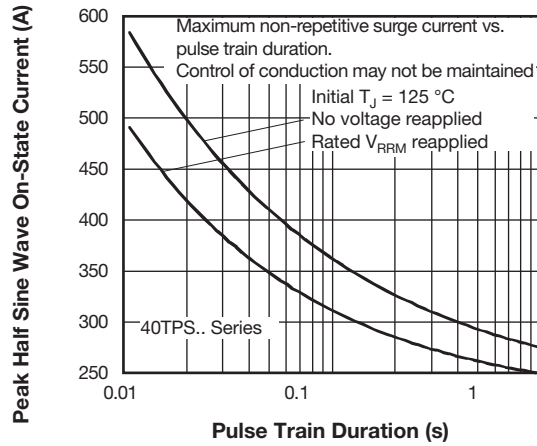

Fig. 6 - Maximum Non-Repetitive Surge Current

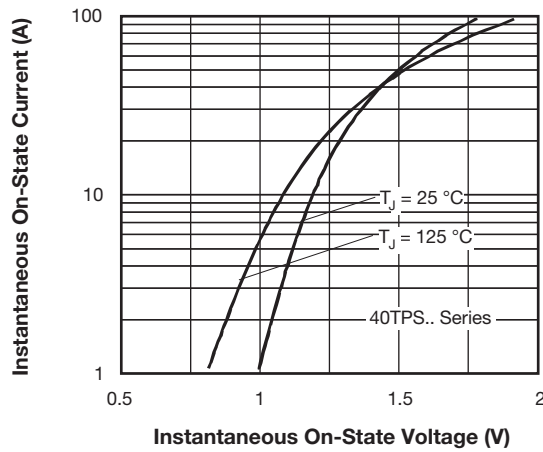

Fig. 7 - On-State Voltage Drop Characteristics

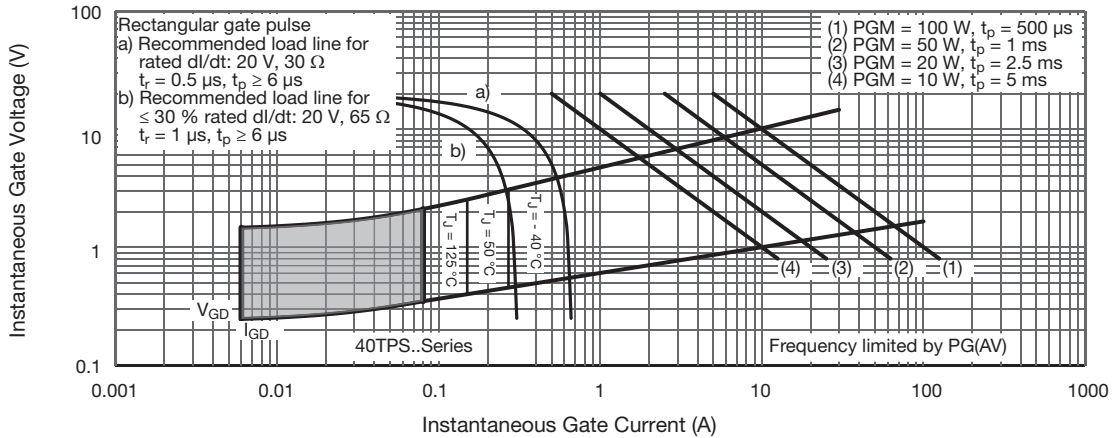

Fig. 8 - Gate Characteristics

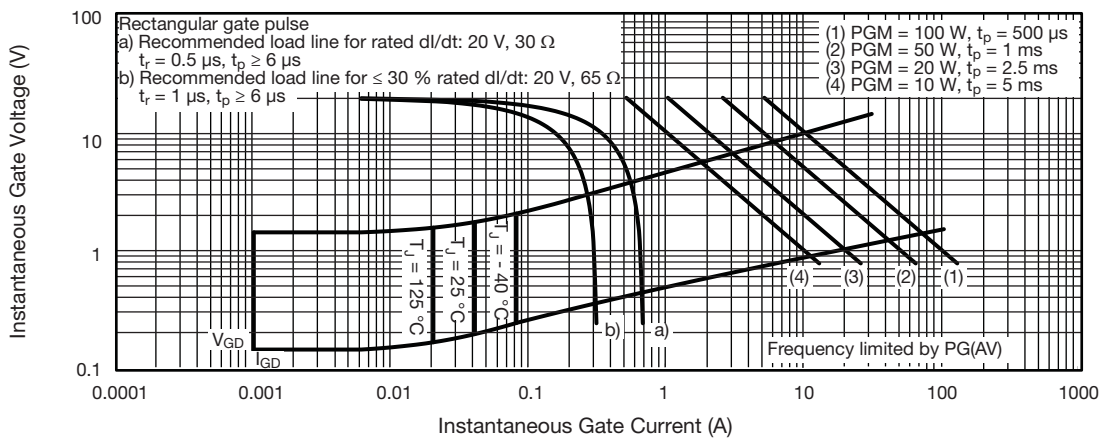

Fig. 9 - Gate Characteristics, 40TPS..A Series

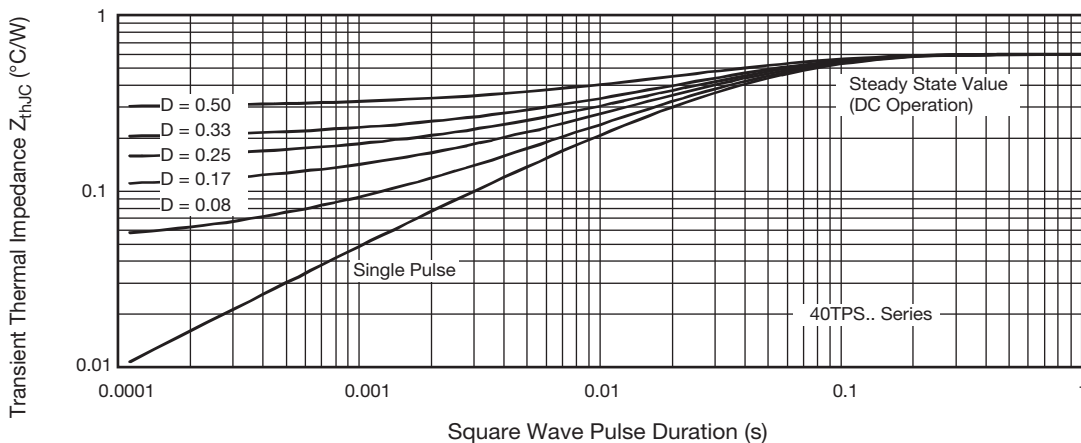
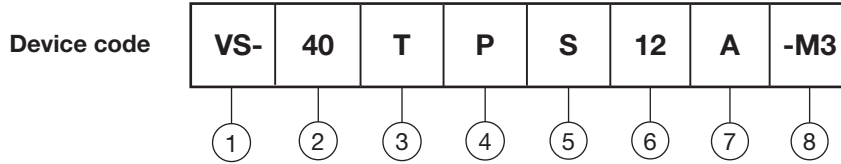

Fig. 10 - Thermal Impedance Z_{thJC} Characteristics



ORDERING INFORMATION TABLE



- 1** - Vishay Semiconductors product
- 2** - Current rating (40 = 40 A)
- 3** - Circuit configuration:
T = thyristor
- 4** - Package:
P = TO-247AC 3L
- 5** - Type of silicon:
S = standard recovery rectifier
- 6** - Voltage ratings

08 = 800 V
12 = 1200 V
- 7** -
 - A = low I_{GT} selection 40 mA maximum
 - None = standard I_{gt} selection
- 8** - Environmental digit:
-M3 = halogen-free, RoHS-compliant, and terminations lead (Pb)-free

ORDERING INFORMATION (Example)			
PREFERRED P/N	QUANTITY PER T/R	MINIMUM ORDER QUANTITY	PACKAGING DESCRIPTION
VS-40TPS08A-M3	25	500	Antistatic plastic tubes
VS-40TPS08-M3	25	500	Antistatic plastic tubes
VS-40TPS12A-M3	25	500	Antistatic plastic tubes
VS-40TPS12-M3	25	500	Antistatic plastic tubes

LINKS TO RELATED DOCUMENTS	
Dimensions	www.vishay.com/doc?96138
Part marking information	www.vishay.com/doc?95007

TO-247AC 3L

DIMENSIONS in millimeters and inches

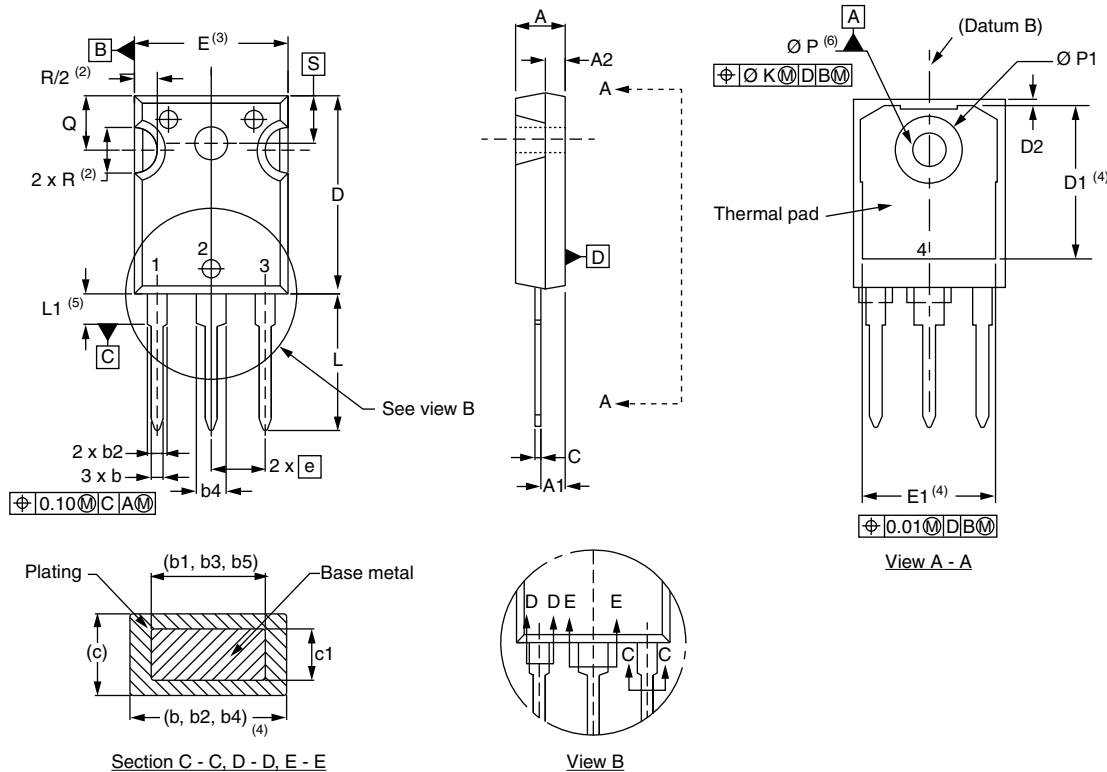

SYMBOL	MILLIMETERS		INCHES		NOTES	SYMBOL	MILLIMETERS		INCHES		NOTES
	MIN.	MAX.	MIN.	MAX.			MIN.	MAX.	MIN.	MAX.	
A	4.65	5.31	0.183	0.209		D2	0.51	1.35	0.020	0.053	
A1	2.21	2.59	0.087	0.102		E	15.29	15.87	0.602	0.625	3
A2	1.17	1.37	0.046	0.054		E1	13.46	-	0.53	-	
b	0.99	1.40	0.039	0.055		e	5.46 BSC		0.215 BSC		
b1	0.99	1.35	0.039	0.053		$\varnothing K$	0.254		0.010		
b2	1.65	2.39	0.065	0.094		L	14.20	16.10	0.559	0.634	
b3	1.65	2.34	0.065	0.092		L1	3.71	4.29	0.146	0.169	
b4	2.59	3.43	0.102	0.135		$\varnothing P$	3.56	3.66	0.14	0.144	
b5	2.59	3.38	0.102	0.133		$\varnothing P1$	-	7.39	-	0.291	
c	0.38	0.89	0.015	0.035		Q	5.31	5.69	0.209	0.224	
c1	0.38	0.84	0.015	0.033		R	4.52	5.49	0.178	0.216	
D	19.71	20.70	0.776	0.815	3	S	5.51 BSC		0.217 BSC		
D1	13.08	-	0.515	-	4						

Notes

- (1) Dimensioning and tolerancing per ASME Y14.5M-1994
- (2) Contour of slot optional
- (3) Dimension D and E do not include mold flash. Mold flash shall not exceed 0.127 mm (0.005") per side. These dimensions are measured at the outermost extremes of the plastic body
- (4) Thermal pad contour optional with dimensions D1 and E1
- (5) Lead finish uncontrolled in L1
- (6) $\varnothing P$ to have a maximum draft angle of 1.5 to the top of the part with a maximum hole diameter of 3.91 mm (0.154")
- (7) Outline conforms to JEDEC® outline TO-247 with exception of dimension Q



Disclaimer

ALL PRODUCT, PRODUCT SPECIFICATIONS AND DATA ARE SUBJECT TO CHANGE WITHOUT NOTICE TO IMPROVE RELIABILITY, FUNCTION OR DESIGN OR OTHERWISE.

Vishay Intertechnology, Inc., its affiliates, agents, and employees, and all persons acting on its or their behalf (collectively, "Vishay"), disclaim any and all liability for any errors, inaccuracies or incompleteness contained in any datasheet or in any other disclosure relating to any product.

Vishay makes no warranty, representation or guarantee regarding the suitability of the products for any particular purpose or the continuing production of any product. To the maximum extent permitted by applicable law, Vishay disclaims (i) any and all liability arising out of the application or use of any product, (ii) any and all liability, including without limitation special, consequential or incidental damages, and (iii) any and all implied warranties, including warranties of fitness for particular purpose, non-infringement and merchantability.

Statements regarding the suitability of products for certain types of applications are based on Vishay's knowledge of typical requirements that are often placed on Vishay products in generic applications. Such statements are not binding statements about the suitability of products for a particular application. It is the customer's responsibility to validate that a particular product with the properties described in the product specification is suitable for use in a particular application. Parameters provided in datasheets and / or specifications may vary in different applications and performance may vary over time. All operating parameters, including typical parameters, must be validated for each customer application by the customer's technical experts. Product specifications do not expand or otherwise modify Vishay's terms and conditions of purchase, including but not limited to the warranty expressed therein.

Hyperlinks included in this datasheet may direct users to third-party websites. These links are provided as a convenience and for informational purposes only. Inclusion of these hyperlinks does not constitute an endorsement or an approval by Vishay of any of the products, services or opinions of the corporation, organization or individual associated with the third-party website. Vishay disclaims any and all liability and bears no responsibility for the accuracy, legality or content of the third-party website or for that of subsequent links.

Except as expressly indicated in writing, Vishay products are not designed for use in medical, life-saving, or life-sustaining applications or for any other application in which the failure of the Vishay product could result in personal injury or death. Customers using or selling Vishay products not expressly indicated for use in such applications do so at their own risk. Please contact authorized Vishay personnel to obtain written terms and conditions regarding products designed for such applications.

No license, express or implied, by estoppel or otherwise, to any intellectual property rights is granted by this document or by any conduct of Vishay. Product names and markings noted herein may be trademarks of their respective owners.