

FCC Promises Stereo Decision

by Kathleen Imbema

Washington DC... FCC Chairman Charles Ferris appears to have committed the Commission to a definite decision on AM stereo "within the first quarter of 1980." Both broadcasters and broadcast equipment manufacturers have responded enthusiastically to the FCC announcement, voiced during the recent House FCC oversight hearings, and anticipate that the Commission's decision will favor AM stereo in general and one of the five contending systems in particular.

Although Harris, Belar, Magnavox, Motorola, and Kahn-Hazeltine have each been tested in over-the-air experiments, and the results of these tests submitted to the FCC August 3, 1979, the first of the five AM systems to be developed, Kahn-Hazeltine,

claims to be the most thoroughly tested. The Kahn System has been evaluated for 30,000 on-air-hours by 11 radio stations, and has been soundly endorsed by stations affiliated with Meredith, Lin, Westinghouse and RKO. Meredith Broadcasting has been especially specific in its support of the Kahn-Hazeltine ISB system, asserting that, "It is apparent that the only AM stereo system capable of long-distance skywave reception, good fringe area stereo image, insensitivity to co-channel and adjacent channel interference and perfect compatibility with present AM mono receivers is the Kahn-Hazeltine system."

Frequency vs. Phase Separation

Leonard Kahn, developer of the

Kahn-Hazeltine ISB system believes that one reason his system is best is because it is also the simplest. Kahn is quick to point out that what is most distinctive about his system is its utilization of frequency instead of phase separation, a method that Kahn patented quite early in his work with AM stereo systems. Because the Kahn-Hazeltine system is a frequency separation system, it is indeed tolerant of narrowband directional antenna arrays, a compability factor verified by a number of actual installations at stations with sharp arrays. All the other systems which have been presented to the FCC for consideration, because they are phase separation systems, might well create great difficulties when required to operate with sharp arrays, many of which are used in this country,

Canada and Mexico. Certainly the problem of directional antennas would be a serious impediment to the acceptance of any of the phase separation systems in Canada.

Phase Sensitivity in AM Systems

Kahn claims that the Kahn-Hazeltine system, with its frequency separation system, is immune to the phase sensitivity of the Magnavox and the other three phase separation systems; this sensitivity is the primary cause of stereo platform motion (swaying) during skywave/groundwave interference periods. This swaying was such a problem for the phase separation systems that both Magnavox and Motorola specifically called attention to it during the NRBA Conventions of 1977 and 1978. While Magnavox reported that the swaying was experienced by all the systems tested by NAMSCR -Magnavox, Belar and Motorola- additional tests done in 1978 indicated that, again, Motorola and Harris also were affected by platform motion during interference periods. On-the-air tests have proven that only the Kahn-Hazeltine system, with its frequency separation system, is considerably less affected by skywave/groundwave interference; the Kahn-Hazeltine system is completely free of motion caused by common phase perturbations and is only sensitive to sharp selective fades.

Sensitivity to Antenna Characteristics

Another distinctive feature of the phase separation system is their

(Continued on page 8)

Technics SP-15

Quartz Synthesizer Direct Drive Turntable

Quartz control provides virtually perfect speed accuracy, within $\pm 0.002\%$ of perfect speed. Quartz synthesizer pitch adjustment permits up to $\pm 9.9\%$ deviation from standard 33 1/3, 45 and 78.26 rpm speeds, completely under quartz control. Speeds indicated by digital read-out, in 0.1% increments. High torque provides fast start-up—0.4 second from stand-still to 33 1/3 rpm. 5.9 lb. platter sustains high 130 lb-per sq. in. moment of inertia for superb immunity to transient load changes. Will withstand up to 2.2 lb-in load drag without slow-down. Electromechanical braking system stops platter in 0.4 second. Die-cast aluminum base with "TNRC" (Technics Non-Resonant Compound) on underside to resist vibration. Platter is rubber-damped on top, underside, and under rim for insulation against vibrations. Pulsed power supply avoids hum induction. Pitch-lock mechanism. Wow and flutter 0.025% WRMS. Rumble -78 dB DIN B.

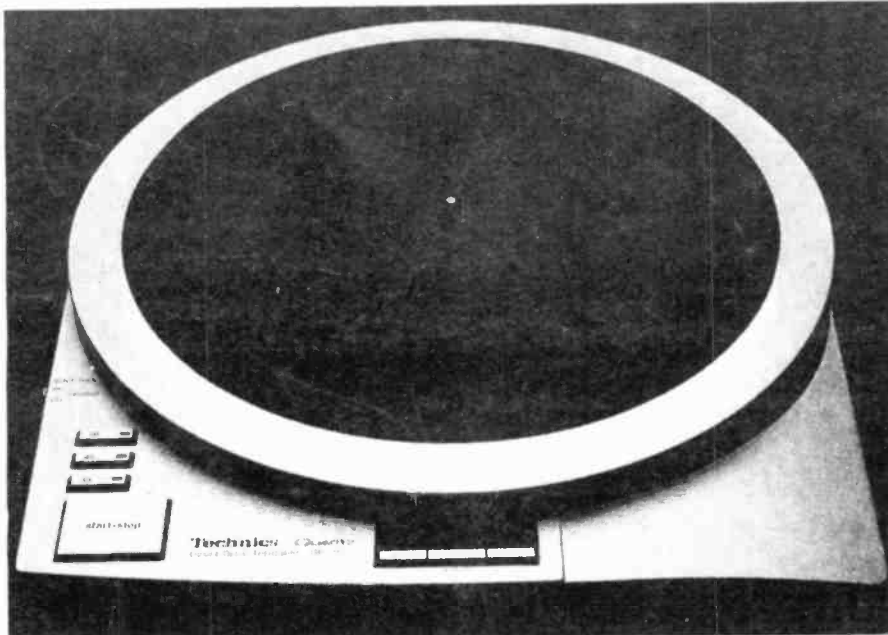

**Allied
Broadcast
Equipment**

635 SOUTH E STREET - P. O. BOX 786
RICHMOND, INDIANA 47374

Ordering Call 1-800-428-6954 In Indiana Call 1-800-382-6907
INFORMATION CALL 317-962-8596 CHICAGO SALES 312-784-2257

INSIDE BEE

- On Studios 2
- Reverberation 3
- Reader's Forum 4
- Surge Protection 6
- Free on VTR's 8
- Audio Process 9
- "The Exchange"
14, 16-22
- Action-gram 15

How to Start Right

Ossining NY ... As a rule the recording industry has, throughout periodic fluctuations of the national economy, been a reasonably stable and viable economic concern. The quality and quantity of facilities and personnel has notably increased, to the point that a once fly-by-night business has transformed itself into a respected and organized multi-million dollar industry. All too often, however, when one mentions the recording industry, an image of flashing lights, twirling dials and loud music from rock'n'roll stars appears in one's mind. While it is true that a recent proliferation of high technology studios has erupted around the country, these studios represent only one portion of the industry whose ultimate goal is to communicate with the public as a whole. The 46-Track interlocked-automated-overdubbed-re-re-mixed-post-edited-delated-flanged-phased-EQ'd-auto-mastered records that are produced today are of the highest quality in the history of the music industry. However, without the ancillary industry support required to bring the product to the public, supermixers and their artists would be twirling only their thumbs instead

of the dials.

What's Production

This support industry, generally unseen and certainly unglamorous, is more multifold than the studio recording process; it can assume a number of guises depending upon the final outcome of the product. In general, the word which best describes the fundamentals of full entertainment synergy is PRODUCTION. This term may upset some persons who feel it much too general. But let's see what exactly is included in my amorphous definition of PRODUCTION.

1. Commercial Production: TV, Radio, Film, Video Tape, Sync
2. Audio Visual: Advertising, Sales Presentations, Film Strips, Cassettes, Museum Guide Tapes
3. TV: Recording, Remix, Syncing, Recording, Documentary
4. Duplication: Audio Cassette, 8-Track, Reel to Reel, Video Cassette, Quad, 1" Audio Dubbing
5. Transformers: Film to Tape, Disc to Tape, Tape to Mag, Live Mag (full coat to stripe), Optical Sound
6. Live Sound: Sound Effects (SFX),

Remote Voice Overs, Remote Audio/Visual for Film or TV

While this list represents only a cursory look at the possibilities contained within the term PRODUCTION, one becomes aware of the scope of knowledge and experience necessary to elicit a finished product from the heaps of ideas that any one project may generate.

Here's How

Let's take an example, albeit simple. The super 46-Track studio has just finished the final stereo mixes on its album of SUPERSTAR. The tape goes to the mastering house for disc mastering, then off to be pressed in multiples of Gold or Platinum. However, since the record company's aim is sales, they want to advertise the album on the radio. Well, they can't very well play the whole album on the air everytime they want to advertise it, so they decide to make a few 30 to 60 second commercials (spots) to sell the album. Where do they get the commercials? They have to make them. One way to do this is to segment the album into several small sections with some of the songs on the album, add an announcer who talks about the album and artist and jam as much as possible into a 60 second slot.

Although it sounds simple this form of production uses many studio hours.

The particular segments of music must be chosen, edited down to 10 or 15 seconds and mixed into another song musically; voice overs must be inserted but not over the actual singing voices, and the whole commercial must be no longer than 60 seconds for radio or 58 seconds for TV.

One thing you may notice here is that no part of the final commercial produced has any element with more than two tracks, (stereo) of information and that's only original

music mix. The announcer feed is mono and anything else that might go into the commercial would certainly have no more than two tracks. The type of facility required for a production of this sort is definitely not an automated, full blown, bells and whistle recording studio, especially since the studio proper would only be used for sound effects or by the announcer. There are other types of rooms which are well suited to a production mix of this nature and require a drastically reduced capital expenditure to build and operate.

Commercials for any product, even other than records, generally have no original sound element greater than stereo. We must remember that the majority of air advertising and broadcast is still done in mono and that stereo information, by and large, is lost unless transmitted by a high quality FM station.

No one facility is ideally suited for all types of recording work, and similarly, all production studios are not the best for all types of production. Some are geared specifically to the commercial market; these are perhaps the simplest for a modest 8 or 16 track studio to consider building.

Another Way

We should all admit that we are taken in by the excitement of live studio sessions, whether it's the Bee Gees doing 46-Track, or the local rock band doing 8-Track demos in a small town recording facility. But let's look at an example of a studio with which I am personally acquainted. Mike started his room in a small suburb of NYC, not known at all as a recording locale. He built an 8-Track studio but, anticipating expansion in the future, he made sure that his studio was capable of handling a fairly large band. The key

(Continued on page 5)

CALIDAD + ECONOMIA = EFICIENCIA

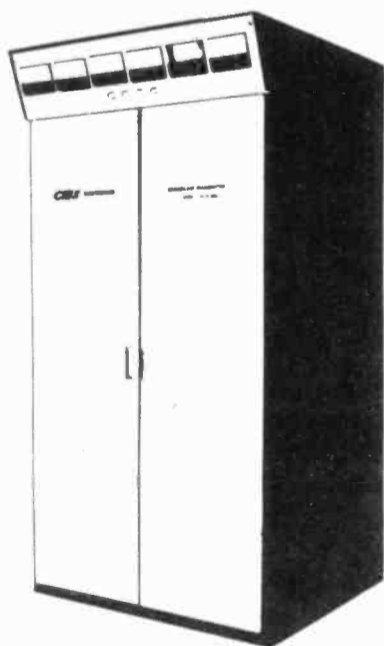

La formula de eficiencia de CSI es muy simple...

CSI le ofrece un transmisor con las mismas cualidades técnicas y el mismo rendimiento que otras marcas conocidas—a un costo mas bajo. Y nuestra fórmula ya ha sido comprobada en mas de 400 instalaciones. Compruebe por si mismo.

EN MEXICO

Representantes
Exclusivos:

Guarantee Radio Supply Corp
1314 Iturbide Street
Laredo TX 78040

512-723-6913

Circle 103 on Action-gram.

When You're Turntable System Deserves The Finest: EP2-C

The EP2-C, designed for the broadcast industry, is a two channel RIAA equalized phono preamp with active balanced outputs. Circuitry is based on the Signetics NE5534 op amp and constructed of top quality American made components.



Phase Audio

For Information Call:

151 N. Angelus
Memphis, TN. 38104
(901) 726-1900

Circle 127 on Action-gram.

But What About Reverberation?

by Bill Allen/
MICMIX Audio Products, Inc.

Dallas TX ... Most broadcasters would give their right monitor for an extra point in the ratings. Points mean listeners, listeners mean advertisers, advertisers mean income, and income means a happy station owner. The key ingredient in this recipe for success is the listener. Stations must provide their audience with an attractive format, entertaining on-the-air personalities, and a clean, healthy, wholesome signal. Most attention is focused on the format and the personalities, but broadcast signal quality is of great importance as well. Signal processing and enhancement plays a major role in the ratings game.

The Beginning

During the broadcast boom of the 40's and 50's, signal processing was relatively simple and uncomplicated. Reverberation was basically the only processing utilized. The live acoustic chamber became popular during this era, and broadcasters were so conscious of its importance that stations which could not afford to build one made do with whatever was available. In some instances, a stairwell or restroom was used as a live chamber. As one can imagine, many stories have been told about these "live" chambers. Still, the point is that reverb was so important that "Yankee ingenuity" was used by many broadcasters to create this

important audio effect. As signal processing began to mature, reverberation and its use in-line has often been lost in the shuffle of equalization, compression, limiting, and the other "tricks of the trade." Recently, however, more and more stations are returning to the use of reverb in the signal chain to increase station loudness or to enhance the signal quality.

Simply speaking, good reverberation not only adds warmth and character to the audio signal, it also increases the *average* loudness and makes the signal seem stronger. At an AES symposium on broadcasting, an ABC representative attributed a major part of one of their station's market dominance to its loudness which was greatly due to the "use of reverb *after* limiting." He also stated,

"Reverb before limiting will change with level which is annoying to the listener. With reverb after limiting, it tends to keep the level even, filling in the holes so that the apparent loudness stays up." At the same symposium, a CBS representative stated, "A fact of life we have to recognize is that, given two stations with the same format, maybe even

(Continued on page 8)

FULL COMPASS SYSTEMS

Year-End Clearance Sale

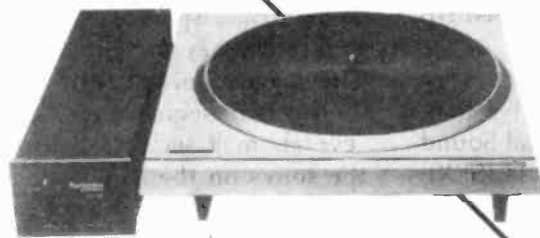

SP-10 Mk II
\$675

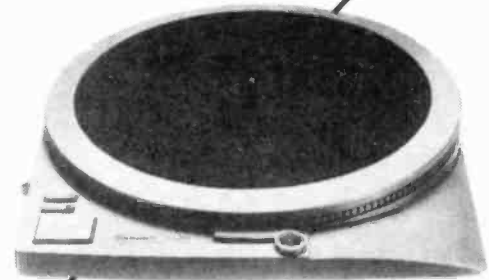

SP-25
\$299

Technics
by Panasonic



SL-1200 Mk II
\$270

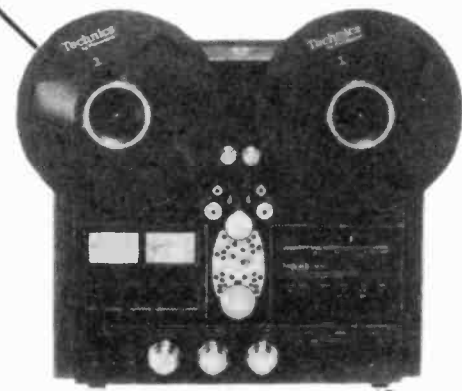

RS-1500US
\$1170

Many Other Items Available

CALL OR WRITE:
608-271-1100

Full Compass Systems

6729 Seybold Road, Madison, WI 53719 — TWX: 910-286-2745

Broadcast Equipment Exchange

Vol. 4, No. 1 January 1980

Broadcast Equipment Exchange (ISSN: 0194-2190) is published monthly by Industrial Marketing Advisory Services, Inc., 2425 Wilson Blvd., Arlington, VA 22201. Phone (703) 525-0400. It is edited for professional broadcast and audio-visual equipment users. Subscription rate is \$25 per year for first class delivery. Copyright 1980 by Industrial Marketing Advisory Services, Inc. All rights reserved. Controlled circulation postage paid at Riverdale, MD (USPS: 440-570) and Arlington, VA. (USPS: 493-370). POSTMASTER: Address correction requested. Send form 3579 to Broadcast Equipment Exchange, P.O. Box 1238, Arlington, VA 22210.

Publisher:
Stevan B. Dana

Editor:
Kathleen Imbema

Contributing Editors:
Bill Sacks, A.E.S./Audio
Clint Free/TV
Winn Schwartau/Recording

Circulation Manager:
Simone Lesser

Computer Consultant:
Larry D. Hughes

PRE AMPLIFICADOR DE TORNAMESA LOGITEK BPA-100

Anunciado el fin de los problemas de sencibilidad y Hum en las tornamesas con este pre amplificador.

Mono Modelo BPA-100.....\$175.00
Estereo BPA-100.....\$240.00

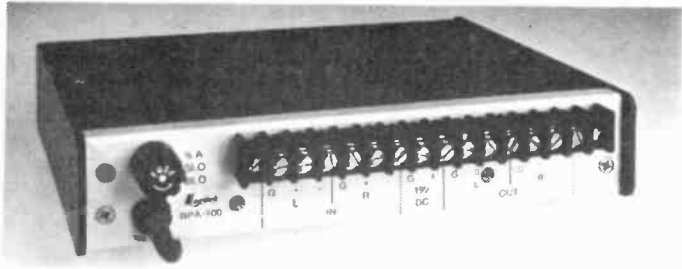

Distributor Exclusivo Para Mexico Y Sur America

Para mayor informacion favor de comunicarse a:

Guarantee Radio Supply Corp

1314 Iturbide Street
Laredo TX 78040

Telefonos: 512-723-9422 y 723-6913



Circle 111 on Action-gram.

FULL COMPASS SYSTEMS

Year End Clearance Sale

Technics:

SP-10 Mk II turntable	\$675
SP-25 turntable	\$299
SL-1200 Mk II turntable	\$270
RS-1500US recorder	\$1170
ST-9030 tuner	\$345
SB-6060 linear phase speaker	\$240
SB-7070 linear phase speaker	\$310
SE-CO1 micro amp, 40 w/chan	\$259
SU-8011 stereo amp, 25 w/chan	\$139
RS-M68 cass deck w/auto reverse	\$400

JVC:

KD-2 portable cass deck	\$249
K2-8 cass deck w/comp bias & eq set.....	\$595

Otari MX-5050B recorder	\$1745
dbx 500 Boom Box	\$189

Call or Write

608-271-1100

Full Compass Systems

6729 Seybold Road
Madison WI 53719
TWX: 910-286-2745

Circle 116 on Action-gram.

Reader's Forum

Got something to say about BEE? Any comments on articles? Send them in to the Reader's Forum (BEE, Box 1238, Arlington VA 22210) for a reply.

More on the Golden Ear

Gentlemen:

Thank you for the opportunity to respond to John Price's reply (*Forum*, 12/79 *BEE*) to my questions regarding his recommendation for the use of a full track alignment tape for setting cartridge machine head alignment.

Mr. Price is correct. A full track alignment tape insures accurate phase integrity across the entire width of the test tape. However, the NAB Cartridge Tape Standards Committee recognized a potential problem area in the use of full track cartridge test tapes. The fringing errors generated when full track tapes are used in stereo machines may lead the user into believing that the low frequency output of the machine is greater than it actually is due to recorded flux entering the head gap from outside the gap area.

The Standards Committee states that when full track tapes are used, fringing compensation must be provided by the test tape manufacturer. FIDELIPAC has determined fringing errors vary from machine to machine and this data cannot be reliably provided for all circumstances. Therefore, we have evolved a unique method of producing a test tape which has phase integrity and yet meets the precise requirement of the standard by being discrete mono or discrete stereo. All test tapes are recorded full track using an oversize single gap head which records material off the top and bottom edge of the test tape. Then, the necessary guard bands are erased, using a full track erase head whose program tracks have been milled

out.

Test tapes manufactured in this fashion provide the user with an accurate track location with which to adjust the height of the head, thus eliminating the possibility of cue tone cross talk due to incorrect head height adjustment.

Arthur Constantine
Sales Manager
Fidelpac Inc
Mt Laurel NJ 08057

Free on VTRs

Gentlemen:

Clint Free's article in the December 1979 issue of *BEE*, "TR60 Horizontal Phase Control", is interesting but not necessary. We've been editing with RCA TR-4, TR-50, and TR-60 VTR's for ten years. We make edits without horizontal lurches and without adjusting the horizontal phase prior to each.

I might add that edits are made manually as well as under the control of an RCA TEP and a CMX 340.

The VTR must be in SL servo and "fixed" TW mode. Prior to recording, set the "TW Position" on the Headwheel Modulator for correct TW position. (Refer to RCA IB's). The first edit should be from black to color bars, etc., without making any adjustments. A horizontal shift may be noticed. All of the following edits will follow the horizontal phase of the first edit. If any drift should be noticed during the course of a very long editing session it can be compensated for by adjusting the

(Continued on page 10)

Announcing ... New From Kahn The NON-SYMMETRA-MOD Modulation Enhancement System

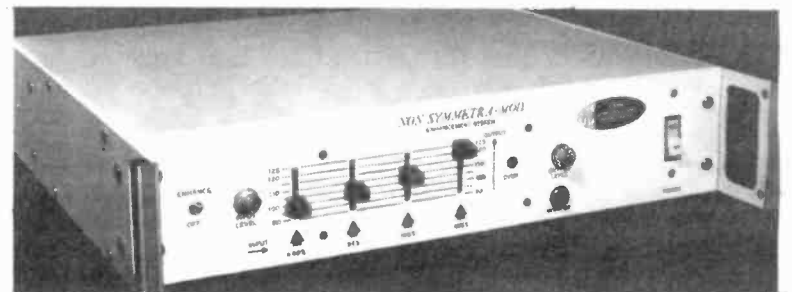

This new technique allows you to convert symmetrical audio waves to asymmetrical waves providing full +125% positive peak modulation with excellent quality. Avoids the annoying distortion of conventional devices. And, of course, it is suitable for AM stereo.

Call or write for more information

KAHN COMMUNICATIONS, INC.

839 Stewart Avenue
Garden City, NY 11530
516-222-2221

Circle 105 on Action-gram.

Start Right ~~~~~

~~~~~ from page 2

to his immediate success was that the local advertising agencies and radio stations were not only able to do their music sessions and mixdowns in Mike's control room, but they were also able to come to him for the production work. He would offer the back up facilities necessary to create and distribute a completed commercial. Mike had the basic production equipment to build a completed commercial from scratch if necessary. He could also take the local amateur church recordings and create a professional sounding presentation of their choir and build a background music tape for the local clubs and supermarkets.

What this meant to Mike was that once he had a client in his door, that customer didn't have to leave until he had exactly what he needed to air on the radio or TV or whatever. Mike got new, unexpected clients daily because of his professional attitude toward production work; in fact, the local radio station often comes to him for sophisticated production work that their facilities are incapable of handling. Well, within 14 months, Mike was buying a new 24 track machine and planning the expansion of his facility entirely.

Because he was able to offer the back up production services, including running tape copies for national distribution, Mike rarely had any unbooked time. He realized early that by making a little less and keeping his studio booked continuously, he would be able to expand sooner. The mistake I see so often made, is that a studio is built and designed with only the recording and mixdown functions in mind. This is especially true with the smaller 8

and 16 track studios which are cropping up all over the country in non-metropolitan centers. It is difficult to expect to be booked solid by all rock'n'roll bands in a new studio without the population to support it. Offering the comparatively mundane, yet badly needed services of quality audio production to a town or city which will be able to take advantage of those services is as much as an advantage to the studio owner/operator as it is to the industry as a whole.

Initially, the investment required is far below that of a music studio. One

needs only the few 1/4" or 1/2" machines deemed necessary, a small console of some sort, minimal peripheral gear and a studio which can accommodate perhaps four or five persons comfortably, either seated or standing. Any existing 8 or 16 track rural or demo studio should be able to tool up for production work with a minimum of trouble: it already owns most of the needed equipment. The first obvious benefit of a facility like this is the reduced amount of real estate needed to set up a room. When there are no announcers working in the room, one is not losing

substantial income by having dead space: one can be in a larger multitrack room when the musicians go home and all that is left is to mix. Secondly, because the equipment is far less sophisticated, there is a marked savings in the amount of maintenance required on a daily basis. Someone should always be on call to fix those panics, but redundant equipment in a stocked production room guarantees that a down machine does not mean studio downtime.

One day, someone figured out the  
*(Continued on page 12)*

# VIDEO PROBLEM SOLVERS

## SUPER TEST EQUIPMENT AT UNHEARD OF PRICES

### LEADER LBO-515A 25 MHz DUAL TRACE/DUAL TIME BASE SCOPE WITH VARIABLE DELAY

- High Brightness CRT
- Internal Calibration Voltage
- External/Internal Trigger
- Comprehensive Trigger Controls
- Calibrated Delayed Sweep
- Dual Probes Included



**\$1,530.00**

### IMMEDIATE DELIVERY

**TWO YEAR WARRANTY • MONEY-BACK GUARANTEE IF YOU ARE NOT COMPLETELY SATISFIED**

### LEADER LCG-396



**\$995.00**

### NTSC COLOR BAR PATTERN GENERATOR

- Video and RF Output
- Scope Trigger Output
- Completely Portable

### LEADER LBO-308



**\$950.00**

### 20 MHz DUAL TRACE PORTABLE OSCILLOSCOPE

- AC or 12 VDC Operation
- Normal, Auto, External Trigger
- Excellent Sensitivity

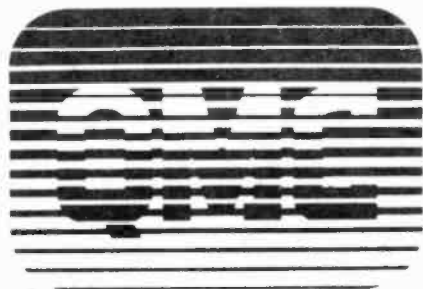

**CALL TOLL FREE 1-800-241-7878**  
IN GEORGIA CALL COLLECT 404/324-1271

## Quality Media Corporation

P.O. BOX 7008 • COLUMBUS, GA. 31908

*Bouquet*

IS  
MANTOVANI  
PERCY FAITH  
RAY CONNIFF

Bouquet is beautiful music for  
the small market broadcaster.

**UTA** UNITED TAPES  
of AMERICA

Box 1193, Grand Junction, CO.

Call Collect: **303-242-0405**

# Transient Surge Protection

by David C. Burns  
Allied Broadcast Equipment

**Richmond IN ...** Transients and surges induced by lighting, heavy electrical equipment, generator switching, power line faults, etc., can damage electrical and electronic circuits in broadcast equipment, computers, monitors, and any facility using circuitry sensitive to power-line disturbances. Even fluorescent lighting tubes can be damaged by high-voltage surges encountered in many power systems.

Volt-Guard is a voltage-sensitive device that protects against such transients. Installed in parallel with the line, it is inactive until it senses an over-voltage at which time it provides a low-resistance shunt across the line (crowbar action). It reacts in fifty nano seconds (fifty billionth's of a second).. Volt-Guard's parallel installation requires it to bear no load.

## Some Examples

On a 120 volt AC line, Volt-Guard begins to function at  $\pm 170$  V, begins its clipping action at  $\pm 200$  V, and crowbars at  $\pm 225$  V, establishing a protective envelope of 450 V peak-to-peak.

Figures 1, 2, and 3 show the action of the Volt-Guard for various transients and surges.

Figure 1 shows a repetitive voltage

wave form of approximately 3400 volts peak-to-peak. The voltage wave form is produced by a step-up transformer, simulating in amplitude possible transients that can occur on AC lines. Actual transients are much faster and usually damped; but the first few cycles of a transient can be very high in amplitude.

With the application of Volt-Guard (figure 1B), the 3400 volt peak-to-peak wave form has been contained at  $\pm 225$  V or  $\pm 450$  V peak-to-peak, as displayed on the scope face.

Figure 2 shows a simulated repetitive wave form of approximately 390 V peak-to-peak with superimposed noise. With the application of Volt-Guard (figure 2B), the wave form has been smoothed and filtered. Volt-Guard filters noise and attenuates higher order harmonics.

Figure 3 shows a positive DC voltage of approximately 3200 volts with positive and negative-going spikes of 1300 volts peak, respectively (simulating in amplitude possible transients that can occur on AC lines as large DC surges with repetitive spikes). With the application of Volt-Guard (figure 3B), the positive DC voltage has been contained at a positive 225 volts, with no large repetitive spikes. The protective envelope will handle DC surges as well as AC transients or combination thereof.

Another feature of Volt-Guard is its zero cross-over switching capabilities. This allows a circuit to be completed only at the instant when the voltage crosses the base-line.

Volt-Guard is available for protection of 120 V, 208 V, 240 V, 480 V, and 550 V AC lines. Configurations include single or three-phase, Delta or Wye.

## LINE CONDITIONS ... BEFORE AND AFTER VOLT-GUARD

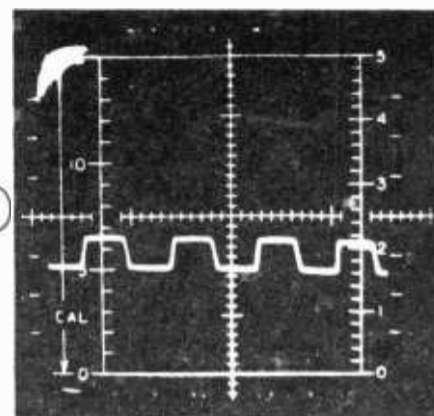
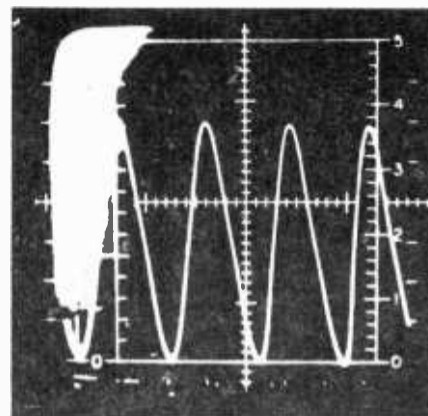

SURGE PRESENT (1 Div. = 300 V) VOLT-GUARD CLIPS

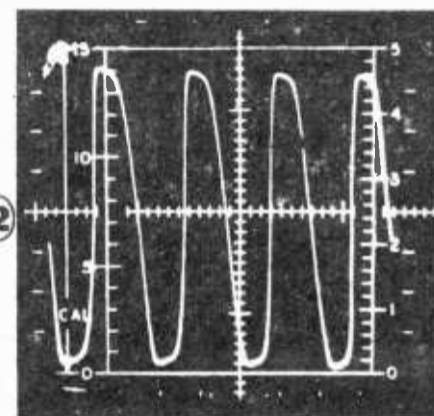
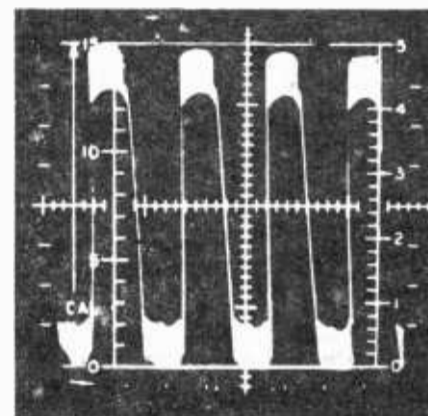

NOISE ON AC SIGNAL (1 Div. = 30 V) VOLT-GUARD FILTERS

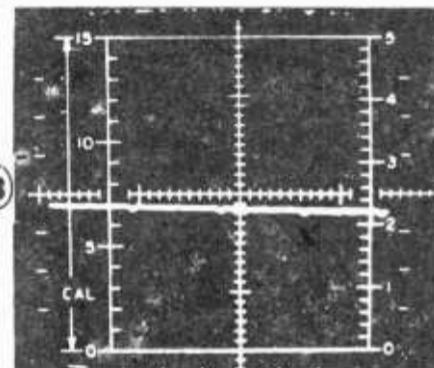
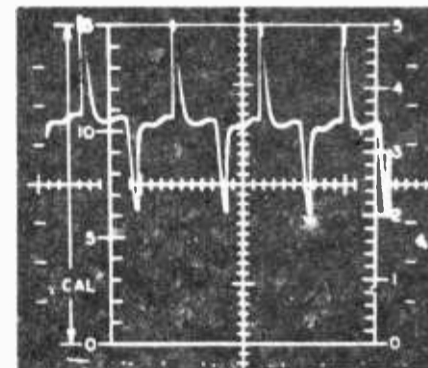

DC SURGE WITH RING (1 Div. = 30 V) VOLT-GUARD SUPPRESSES

FULL COMPASS SYSTEMS

## Broadcast Elliptical Cartridge



SC-39EJ

**SHURE**

List Price — \$70 ON SALE — \$45

Call or Write:

**Full Compass Systems**

6729 Seybold Road, Madison WI 53719

TWX: 910-286-2745

608-271-1100

Circle 108 on Action gram

## New...Harris' AM-FM TV

Broadcast Equipment Accessories

Catalog 79-V

Do you have your copy?

If not, contact Harris Corporation, Broadcast Products Division, P.O. Box 4290, Quincy, IL 62301, 217/222-8200.

**HARRIS**  
COMMUNICATION AND  
INFORMATION PROCESSING

Circle 109 on Action-gram

# NEW TURNTABLE PREAMP

*"Equipment that's Alliedependable"*



## SUPERB

A device of this caliber doesn't come about by luck or chance. The Audio-Metrics turntable preamplifier is a product of intense research and thoughtful, careful design. And these are not empty phrases — we set out to make the best.

A true commitment to superior performance demanded a survey of existing equipment coupled with a re-evaluation of the preconceptions concerning phono preamplifier design. Our research told us both what a preamp should and should not do.

### WHAT IT DOES

**NOISE** — A combination of discrete and integrated circuit components in the input gain stage and low noise resistors, hold noise to near theoretical limits.

**TRANSIENT RESPONSE** — The realization of the importance of dynamic distortion figures is so recent that a rating standard is yet to be agreed upon. Yet, audiophiles attest to the significance of these factors for accurate reproduction. Uniformly high speed circuit design with response up to the MHz range, insures this unit's capability to reproduce even the fastest music peaks. Therefore, slew induced distortion and transient intermodulation are virtually non-existent.

**INPUT OVERLOAD** — With second stage equalization, the first stage gain block effectively buffers the cartridge from loading changes and provides broadband high input overload protection.

**AUDIO TRANSFORMERS** — The challenge was to eliminate the transformers and their inherent audio distortion, and still maintain RF protection and balanced outputs. The technical answer to the problem involves the use of state of the art integrated circuits, ground plane circuit boards and input and output RF suppression. The practical side of the story is simpler and more important. Tests in ultra high RF environments have proven the unit to be RF interference proof.

### WHAT IT DOESN'T DO

**EQUALIZATION** — The Audio-Metrics preamp rigidly adheres to the RIAA curve. It does not allow for the user adjustment of high and low frequency response. Broadcasters uniformly told us that the preamp was not the place for tone compensation.

**SWITCHES AND RELAYS** — No special auxiliary turntable start/stop switching or other accessories are included in the Audio-Metrics preamp. It seems obviously inappropriate to expect every user to pay for special features applicable to only a few special situations.

### SPECIFICATIONS:

- INPUT — 47k Ohms Parallel 180 pf.
- MAXIMUM INPUT — 350mv Any Frequency
- MAXIMUM GAIN — 5mv at 1kHz = + 5dBm Single Ended Out  
= + 10dBm Balanced Out
- MAXIMUM OUTPUT — +22 dBm Single Ended Into 600 Ohms  
— +27 dBm Balanced Into 600 Ohms
- OUTPUT IMPEDANCE — 100 Ohms Single Ended  
— 200 Ohms Balanced
- FREQUENCY RESPONSE —  $\pm .25$ dB RIAA (using new curve, specifying low end roll off)
- THD — .03% + 18dBm Into 600 Ohms
- IM DISTORTION — .04% + 18dBm Into 600 Ohms SMPTE
- SIGNAL TO NOISE — 80dB Relative 5mv at 1kHz  
Input Terminated 620 Ohms  
Measured: Unweighted - Broadband  
— 96dB Relative 12mv at 1kHz  
Input Shorted  
Measured: A Weighted
- CHANNEL SEPARATION — 90dB
- CONNECTORS — Input - Phono Jacks  
— Output - Barrier Strip

The pre-amp input loading is 180 P.F. Because correct cartridge loading is important, you should check your individual cartridge specifications for recommended loading. Conventional shielded tone arm cables present a load of about 27 PF/FT. If you must reduce your cartridge load, consider shorter cable runs or low capacity cable. No attempt should be made to adjust loading by removing the pre-amp input capacitor, as this would defeat RF rejection.

**Allied  
Broadcast  
Equipment**

635 SOUTH E STREET - P. O. BOX 786  
RICHMOND, INDIANA 47374

Ordering Call 1-800-428-6954 In Indiana Call 1-800-382-6907  
INFORMATION CALL 317-962-8596 CHICAGO SALES 312-784-2257

Clint Free on VTRs:

# Notes on Chroma Noise

Knoxville TN ... Chroma noise is probably the most prevalent unrepaired problem I have found, with the older machines exhibiting more symptoms than new ones. The symptoms can easily be observed on a vectorscope. If the color bar dot spread is in excess of ten degrees, a

velocity error correction but with velocity error, the yellow bar is more accurate. A five degree dot spread of the yellow bar is good and achievable with most RCA and Ampex machines.

Time base correctors compare off tape horizontal sync and color burst

corrector to remove jitter can be caused by most phases of the correction process. Horizontal sync and burst separating circuits are a common source of fault as well as electronic voltage variable delay line imbalances. Slight shifts in DC power can render both of these functions marginal, although not inoperative.

4. Improperly terminated (input and output) EVVDLs produce ringing and reflections.
5. Opening the burst sep gates too soon, too late, or both will cause high gain ringing stages to operate a few degrees out of phase (inaccurate timing).
6. Precautions are taken to assure that any pulses which will be out of phase with the reference signal do not pass through to the error detector. Failure here produces very noisy video.
7. THAF & THA voltages should be well filtered DC. These circuits are difficult to analyze and can cause problems of an intermittent nature.

There are several adjustments which should be checked at regular intervals, or when the need arises (high chroma jitter), in these systems.

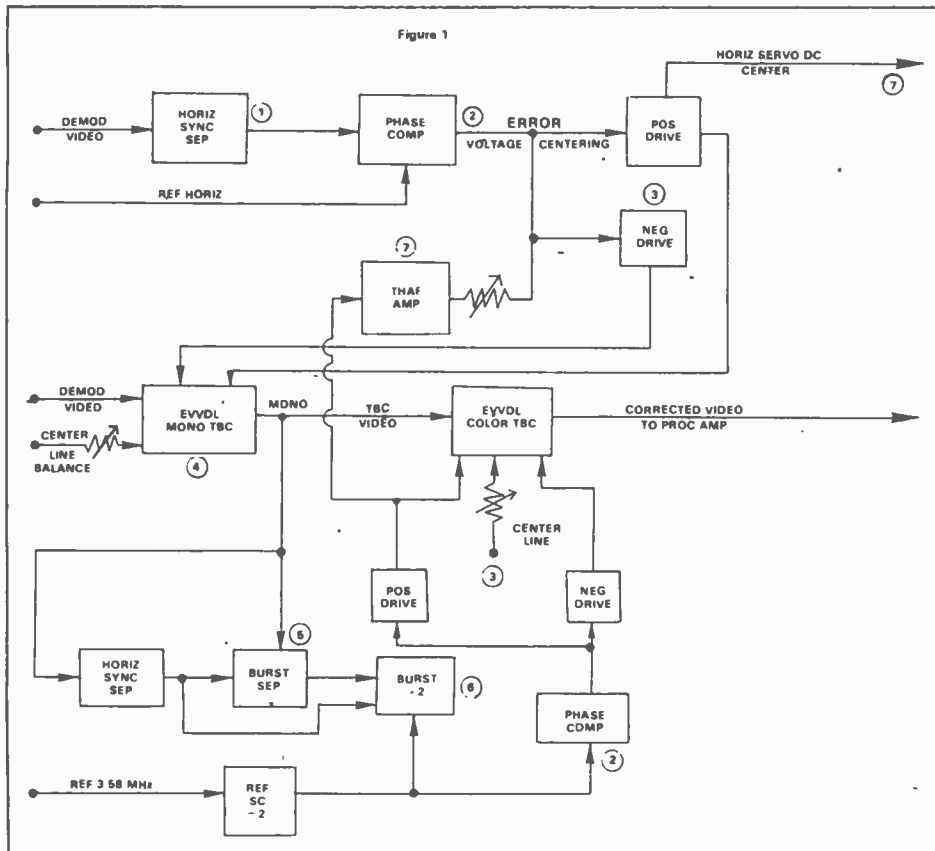

## Notes

1. Sync separators can produce pulses which do not accurately reflect demod timing.
2. Phase comparators can produce high amplitude transients and leakage of the DC hold circuits can produce apparent velocity errors.
3. Pos & neg drives which are not balanced with respect to the EVVDL center line will cause transients to be imposed upon the video, the voltages have rise time and DC balance.

## Stereo Decision

from page 1

appreciably poorer performance with actual antennas rather than with "dummy loads." Although the Harris system claims that "... the V/CPM signal can be transmitted by limited bandwidth antenna systems with no degradation of channel separation ...", the Harris system offers a 15dB separation figure limited to 400 to 5,000Hz in their new specifications. Belar reported that separation measured as low as 14 or 15dB at 150Hz and 19dB at 1,500Hz under actual tests at WJR, even though dummy load measurements during NAMSRC achieved over 25dB through the range of 100 to 5,000Hz.

On the other hand, most stations using the Kahn-Hazeltine system were able to obtain *on-the-air* separation figures closely approximating laboratory figures in excess of 20dB from 100 to 5,000Hz.

### Receiver Tracking and Phase Ripple

Kahn also claims that his system is immune to separation loss due to phase tracking errors and phase ripples, while all phase separation systems inevitably lose stereo separation because of the phase errors caused by poor receiver tracking. The tracking of the RF tuner of a receiver with its local oscillator has always been a problem; however, the problem would be severely aggravated if it became necessary to track the circuits in phase as well as the amplitude. Although errors in phase tracking would not destroy all separation, separation would be seriously limited for listeners who wished to hear a stereo station falling at a poor phase

tracking frequency. Phase ripples in the receiver's selective circuits can also degrade separation figures for phase separation systems substantially.

In its report to the FCC, Meredith Broadcasting echoed Kahn's concern over the inferiority of the phase separation systems: "When evaluating the five different AM stereo generating systems that have been proposed to the Commission, the most serious flaw of all of the systems, except the Kahn-Hazeltine system, is their sensitivity of phase shift of the carrier with respect to the sidebands. The stereo separation of these other systems can be completely destroyed by a shift of only 45 degrees of the carrier in relation to the sidebands. And a shift of just 15 degrees in the Harris system is sufficient to cause stereo separation to disappear. From the various tests, measurements, and audio recordings of WOW and KCMO, the Kahn-Hazeltine system was insensitive to phase shift of the carrier with respect to the sidebands."

### Mono and Stereo Compatibility

Both RKO Radio and Westinghouse Broadcasting agreed, after testing the Kahn-Hazeltine system, that there was no loss of mono coverage while broadcasting in stereo using that system. Leonard Kahn points out that, unless this were true, none of the stations involved with his system would have willingly operated over extensive periods of

correctable deficiency most likely exists. The yellow bar, which with standard bars is on the left side of the screen, should be used for the measurement. Any velocity errors will cause blue and red to be exaggerated; in machines without

with a stable reference from a sync generator to produce error voltages which reduce the jitter prevalent in uncorrected off tape video. When the residual jitter is in excess of five degrees, a noticeable degradation occurs. The failure of a time base

## Reverberation

from page 3

playing the same records and with equal strength, the (loudest) station ... is going to come out with the highest rating." While compression and limiting are used to increase the effective modulation level by reducing the dynamic range, reverb extends the "length" of a signal, thus increasing average modulation level. Reverb creates an aural illusion: the signal sounds louder because it is fuller, warmer, and the small amounts of dead air between words and songs are occupied by some sound. Too much reverb would be annoying to the listener, so discretion must be used to mix in just enough to fill in the holes.

### The Ear Hears

A key point to remember is that the ear is a very sophisticated listening device. One's mind does not immediately perceive all of what the ear hears; a great many things remain

sub-conscious. Many of the characteristics of a sound have a subliminal effect on the audience. The average listener, without knowing it, is actually very particular about the audio quality of a broadcast signal. The signal with a lot of background pumping, distortion, and other unwanted characteristics will eventually turn a listener off, and the listener will then turn the station off. This average listener may not know technically what is annoying, but his ears are sending a subliminal message to the brain saying, "Turn that garbage off!" Many stations suffer from this "subliminal signal annoyance syndrome," and their ratings reflect it. Good reverb properly used has a positive, enhancing effect on the signal, which tends to attract rather than dissuade the listener.

The ear actually longs for reverberation; it is a very pleasing

(Continued on page 10)

(Continued on page 12)



Bill Sacks on "The Audio Process"

# Audio Grounding Systems

Springfield VA ... This month I'm going to talk about one of the most neglected areas of broadcast and recording studios: the grounding system. I've had to fix more than one station where virtually every input brought up on the console has hum and RF, audible above the residual noise. In these situations it seems like there is a persistent ground loop. No matter how the audio shields are lifted or connected, the hum and/or RF doesn't go away. The way to approach this kind of problem is by looking at *the ground* as a system.

First look at the building electrical ground. Initially this ground is installed by the electrician. The AC electrical neutral, or return path, is insulated from ground everywhere in the system, except at the main building ground where they are bonded together. This main ground is usually a water pipe or outside ground rod. Remember that a small difference of potential exists between the AC ground and neutral at virtually all points except the bonded ground. The third wire, or Uground, of the AC plugs, metal conduits, switch enclosures, and armored cable shields are considered an electrical ground and are connected to the outside (main) ground point. A chassis which is bonded or connected to the third wire is a real life-saving feature since it causes the fuse to blow if a voltage source shorts to the chassis.

In a broadcast or recording situation, standard third wire electrical grounds can raise havoc. Electricians are concerned with ground voltages of hazardous nature, but this safety grounding does not always provide an adequate grounding system for interfacing devices with low level audio, so I always

establish my own independently controlled grounding system.

## How To Start

I begin by finding the main electrical ground for the building. Each control room must have an independent insulated wire or strap to the main building ground. In low level RF environments a #6 A.W.G. (for less than 100 feet) of insulated copper cable should be connected from each console chassis to the main building ground. RF environments require a .25 to 4 inch wide solid copper strap from the main building ground to the transmitter, but one must make sure the bare strap is insulated from any contact with structural metals or AC conduits. If it is impractical to run an independent ground from each control room (eg: high rise buildings), a large ground buss (#2 or #4 A.W.G.) should be run to the main building ground and then terminated at a convenient location in the facility. Each audio console should be independently grounded only to this point: this chassis ground point at the console becomes the main ground for that room.

In each control room the #6 ground cable should be firmly bonded to the console. The metal rack frames should have a #12 wire or a 1/4" wide copper strap which is run along the entire length of the rack frames and then bonded at several points to the racks. Leaving the rack, this strap or wire is fully insulated and runs directly to the main studio ground.

For grounding devices such as cart machines and other peripheral equipment which is not enclosed in a bonded rack, a piece of #16-18 A.W.G. two conductor cord is soldered to the main ground cable from each floating device in the

studio.

The third wire AC grounds for each chassis may then be lifted at the AC plug with a commercial ground lift adapter. But remember *a sage and reliable main earth ground is a pre-requisite to tampering with the third wire grounds.*

## In High RF

Up to this point I've addressed the grounding problems in low to medium RF environments, and I'd like to take some time to discuss the special problems caused in saturated RF environments. The ground lead itself can act as an antenna, causing a RF difference of potential between a chassis and the main ground. This is especially true of units that are not enclosed in a bonded rack. In this case, the ground lead should be a cable using a #20 twisted pair with a foil shield and a static drain wire. Use both conductors for a ground lead and connect the static drain at the main ground point only. This provides a shielded ground wire which is very useful in thick RF fields. If RF still persists, a .1M.F.D. disc capacitor should be placed between the audio drain wire (which would normally float) and the audio ground of the offending piece of equipment. At the transmitter site, the main building ground is the strap which grounds the transmitter to the earth ground.

I always use foil shielded twisted pairs and balanced lines for audio routing. The foil is an excellent electrostatic and RF shield. The drain wire should only be connected at one

point: the point of lowest audio signal. For example, on a tape deck, the chassis is grounded either through the rack or as an independent connection to the main studio ground. The shields of the tape output line float at the deck and are connected only at the console input termination. The record input lines have their shield drains connected at the deck only and the drain is floated at the distribution amp or at the console output.

## What's Best

In the above paragraph I mentioned the importance of balanced lines in audio routing. This leaves two options: a transformer or an active balanced circuit. Some people believe that transformers will solve all of their grounding problems. But transformers have problems of their own, problems which Bill Ashley discussed last month in B.E.E. I also mentioned some of these problems in November's column (Dealing with Square Wave Response) and the people at Jensen Transformers responded with information on some of their state of the art products. They are producing some transformers with good square wave response, and common mode rejection ratios of 85-90db at 1kHz and 55-60dB at 10kHz. Remember, these common mode figures are also achievable with well designed active balanced inputs if the components are precisely matched for good common mode. The common mode

(Continued on page 10)

**NEW**

## UNIVERSAL BALANCED AUDIO AMPLIFIER MODULE

with high slew rate, no transformer and ultra low transient distortion

The UA-1 balanced building block allows one card to be used throughout the audio chain. Not only does it cut your card inventory, but it speeds revamping and upgrading audio facilities. Here is a combination line amp, distribution amp, phono preamp, mic preamp, tape head preamp, film sound preamp, and independently usable input/output stage for radio and TV stations, recording studios and professional sound systems. Optional RIAA network available on board. The UA-1 also gives both an on and off board gain control, and an unbalanced break point with a current pump output between the input and output

stages. The plated-through double sided pc card with RF ground plane construction and heavy gold plating on the edge connector fits most standard audio card cages. Up to 16 cards in a 19 inch rack. Fully balanced input and eight isolated 600 ohm balanced distribution amp output, and a balanced current pump output. All on a single card.

Distributor Inquiries Invited.

Unit price \$175.00  
(cash with order—15 day money back guarantee)

**STRAIGHT WIRE AUDIO COMPANY**  
215 South Courthouse Road, Arlington, Virginia 22204 (703) 920-2239

Circle 110 on Action-gram.

## Get the most from your AM signal...



**of less**

The MAP II Multiband Audio Processor gives you optimum modulation of your AM/AM-Stereo program. Yet it costs much less than similar systems.

**Discriminate Compression**  
Only MAP II offers you independent compression and equalization for each of eight bands. Input level is held constant by a slow, gain-riding A.G.C.

**Inaudible Phase Optimization**  
Program phase is silently "rotated" for maximum positive modulation.

**Absolute Peak Control**  
A unique integrated peak controller combines a hard clipper with a low-distortion peak limiter.

**Convenient Operation**  
Features include selectable low- and high-pass filters, "proof" mode, and built-in pink-noise generator.

Call or write today for more information. Map II—\$1670.

**Inovonics from**  
**NORTHEAST BROADCAST LAB, INC.**  
15 Charles Street, P.O. Box 1176, South Glens Falls, N.Y. 12801  
(518) 793-2181

Circle 112 on Action-gram.

## Reader's Forum

from page 4

TW PHASE on the Headwheel Modulator.

Excessive horizontal drift is caused by extreme temperature variations. This condition should be avoided at all costs. The ideal environment should be temperature and humidity controlled.

The only time "Variable" TW should be used is when there is insufficient range of the "Fixed" TW circuits. This condition is normally caused by editing on tapes made on another VTR or on the same VTR but with a different headwheel. However, the same rule applies—do not change the "Variable TW Position" control after the first edit is made with the correct phase. It may take several edits to find the "correct" phase.

The procedures described above make the assumption that the VTR is correctly set-up as detailed in the RCA IB's. Any problems should be corrected prior to editing.

Finally older RCA VTR's can be updated to the TR-60 version of the Headwheel Modulator module and the Linelock module.

I enjoy your publication, keep up the good work.

Eric R. Address  
Director of Engineering  
E.J. Stewart Inc  
Broomall PA 19008

### Errata

The last sentence in the second paragraph in the article, "Do We Still Need Transformers?" appearing last month on page 2 should have read "under 0.05%" instead of "under 0.5%" as shown. On page 6, Figure 1, there should of be an arrow going from the "Resistor Matrix" box to the "MSMV #3" box.

### On BEE

Editor:

While reading the November 1979 issue of the Exchange, I was struck by the lack of prices associated with equipment for sale. Not one ad in twenty-five gave any hint of the asking price. Looking back at some past issues, it seems that there has been a progressive deterioration in that area. The present state of affairs makes the publication virtually useless for its original intended purpose.

I believe that your publication will only be useful in the broadcast industry if it is a ready reference for availability in prices on used equipment. While I can see that persons listing expensive equipment might wish to withhold the price for negotiating purposes, I can see no reason at all for those advertising items under, say, \$500 not to publish the price. In fact, I believe it would be much to your advantage to make that a requirement of any listing. Believe me, if I were in the market for a \$400 "volumax" I would not be inclined to call each of the listings in your Exchange to find out who had the best deal. I would certainly not want to phone someone to find out that their microphone offering was \$30. On the other hand, I might immediately buy either one of these items from a listing if the price and condition were immediately at hand.

You started out with a fine service to the industry. Please do not let it get off the track.

Lawrence Behr  
President  
Behr Associates  
Greenville NC 27834

### BEE Replies

Thanks for the comment Larry. As usual we often get our best ideas from our Readers.

Effective with this issue, client's asking prices (when given) will be included on the Key Code list along with the names and addresses. So, if you haven't already, subscribe now to BEE with the Key Code list included. (By the way, we removed the asking prices from the listings a few months ago because it was creating trouble with our foreign readers, as prices often might be higher for them.)

## Reverberation

from page 8

phenomenon. A dry performance in a studio is not nearly as exciting as one in a large concert hall with good, natural reverberation. Reverb adds color, dimension, and therefore excitement to the listening experience. Along with being beneficial in regard to loudness, reverb is also a signal enhancer.

### In Cars

Morning and evening drive times are the "hot" times for a radio station. The listener usually devotes his undivided attention to that radio. Since the automobile is such a small enclosure, it is not the best listening environment. A touch of reverb will seemingly expand the listening space in a car, thus making it a more desirable atmosphere for listening. Remember the old car reverberators? They were used to create the illusion that the car was a large concert hall. Too much reverb will again be distracting, but just a touch will increase listening pleasure. The vast majority of audience, no matter what format, do not listen to the radio on top-of-the-line audio equipment. Neither car speakers nor the small table model or portable radio, no matter how expensive, can take the place of a nice home stereo system. There is so much at stake that signal enhancement is necessary. The listener may not know why he prefers a certain station among several with similar formats, but his radio is tuned there. If a listener is pleased with the signal quality, he will stay tuned to that station not only in his car, but in his living room as well. A little reverb added to the signal can make the difference.

The right amount also gives a station a certain "sound." A chief engineer at a top MOR station in Dallas recently stated, "I suppose one of the main reasons we use reverb on-line is to give our station a little more warmth, and a little bit different sound than any others in our market." "When a listener finds us," he continued, "he knows he's found us because we sound different. He might not realize why we sound different, but he knows what we sound like. He might not realize why we sound different, but he knows what we sound like. Our use of reverb is subtle but effective."

Editor:

By the way ... I think your publication is the nicest thing since "sliced bread!" I especially enjoy the technical articles and the "how to" stories ... May you prosper!

Charles E. Bell  
Owner/CE  
WSIB/WDOH  
Beaufort SC 29902

### Other Advantages

Reverb added on-line is not limited to the "loudness" applications; stations emphasizing wide dynamic range in their audio signal can find it especially attractive. Additional reverberation fills in the holes during the quieter passages, thus improving the signal-to-noise ratios, and thereby attracting the "fringe" area listeners. High quality reverb is also very important in the production room. Much care is taken in writing, producing, and mixing a jingle to obtain every last ounce of loudness. A jingle can appear louder than program material through the use of compression, equalization, proper instrumentation, voicing, and many other tricks. Reverb is also a vital tool used to increase loudness in a commercial. The advertising client is pleased that his commercial appears louder, and a happy client is one that will be back.

A reverberation unit intended for broadcast usage absolutely must be of highest quality. It must have a smooth and flat response over the reverberant field passband, and must

(Continued on page 23)

## Grounding

from page 9

rejection ratio of a single op amp differential input stage is sensitive to the termination of its input resistors. The input noise rises with low source impedances. The 3 op amp type instrumentation amplifier is the best amp suited for this purpose since the differential input is impedance buffered (see Walt Jung's *Op Amp Cookbook*, pp 242-43). The gain of the cross coupled differential input stage is always unity for common mode signals. More on common mode trimming techniques in a later column.

I'd like to close asking for comments. Let me know what problems you're having in the field and how you're dealing with them. Send in topics you want to see discussed and include some information about what you're doing for audio in the 80's (Bill Sacks, c/o BEE, PO Box 1238, Arlington VA 22210).

Available now from . . .

## CLINT FREE BROKERAGE

Several RCA high band TR-22's, ranging from \$10-15,000

RCA electronic editor for TR-22, 60 or 70 at \$3500

LLO modules for TR-3, 4 & 22 at \$750

Also MATC and CATC modules

Call THE Expert ... 615-693-4043

The Clint Free Company

509 Bardon Road  
Knoxville TN 37919

Circle 151 on Action-gram

# audiotechniques mixdown

BROCAST EQUIPMENT EXCHANGE 11

652 Glenbrook Road, Stamford, CT 06906 Tel: (203) 359-2312 1619 Broadway, Suite 905, New York, NY 10019 Tel: (212) 586-5989

## SHORT TAKES

### Lollipop King

A/T Rental's Sid Zimet reports that his rental crew gave away over 1,400 lollipops at recent AES! (How sweet it is!) A/T Rentals latest acquisitions now include EMT 250 Digital Reverb and Syntox Vocoders.

### Saves for new Schwartz Studio

The superlatives were flowing as more than 250 invited guests visited new Howard Schwartz Studios during AES session to congratulate the proud parents!

### Going good, Jay!

Congrats to Jay Messina, now Chief Engineer at Record Plant in NYC. After all these years, the RP continues to draw the biggest acts. (It's so hard to beat real talent!)

### Musical Executive Chairs

Vell... Bruce Staple, former General Manager, Soundmixers, kicked upstairs to same spot at Sound One... to make room for Soundmixers new GM, Paul Sloman... recently departed from Record Plant, JYC... to make room for RP's new GM Lila Wassanaar. Meanwhile, over on 44th Street, Ed Germano's Hit Factory also has a new GM, Bob Lanier, well-known in NY recording circles, just returned after a few years in the sunny Southwest. (Kinda leaves you breathless, doesn't it?)

## Rumor Mill

### Boston notes

A faithful reader takes us to ask for calling that new video proprietor (Mixdown, Oct. '79) Owner of Boston's most solid successful studio". Seems he thinks he should either wear or bare the crown, so we will modify it to "... one of Boston's most... etc." OK?

Latest on the R&T (see Sound alace, see Bell Sound) caper into! All gear, furnishings, etc., moved out just before hangsgiving.

## New Crossover is hit at New York AES preview

# Red Series TIME/SYNC™ for super 604's

## Used Equipment For Sale . . .

- **MCI JH 528-28 Console.** 28 ins/outs, traded by famous studio for new MCI JH 556, top maintenance, all latest modifications, producer desk, an excellent value . . . \$48,250
- **MCI JH 416-24 Console.** 24 ins/outs, traded for MCI JH 538C, light use home studio, perfect condition . . . \$21,300
- **MCI JH 416-16.** Maintained in top condition, 16 ins/outs (expandable to 24), trade on new MCI JH 600 Console, a real bargain . . . \$16,250
- **MCI JH 100-16.** 2", 16 track recorder with Auto Locator, good condition . . . \$13,300
- **Scully 100-16 Recorder.** 2", 16 track with all the extras, spare cards, motors, heads, 8 track heads, regular daily operation in a New York City studio . . . \$8,275
- **Scully 282-4.** 1/2", 4 track in good condition, ever popular Scully 4 track is always a good value . . . \$2,450



Time synchronization is key to remarkable 604 Stereo Crossover System!

## MCI 600 Console deliveries roll!

Long-awaited MCI 600 consoles arrived in early fall in the NY area as the first pair were delivered to East Side Sound, 99 Orchard Street, and Celestial Sound, 919 2nd Avenue, both in NYC. Celestial owner, Tony Pinelli, reports flawless performance from his new 600, while East Side's Lou Holtzman is planning for an early '80 opening.

Arrest Records in Washington, D.C., Storyk-designed rocker, and Boston's Audio Workshop both received 600's in early November and plan December openings. Audio Workshop, with new MCI 24 and 2 track recorders, plus the 600, is Boston's sixth all-MCI studio.

Scheduled for early December installation is Ace Frehley's suburban Connecticut 24 track MCI studio, complete with 600 console. Two other MCI 600's scheduled for early January '80 installation are part of 24 track MCI studios supplied by Audiotechniques to Mark Hood's Dr. Sound (NYC) and Golden Baobab (Dakar, Senegal, West Africa!). We'll fill you in on all details of the African studio in our very next issue.

The major recent developments in monitor speaker design have been systems to correct driver positional error and phase. The popular UREI 813 is an example of this type of recording studio monitor. Newest addition to this technology is our Time/Sync crossover, developed by Audiomarketing's General Manager, Rick Anderson, and introduced to recording studios at the recent New York AES meeting.

Acoustic alignment in the Time/Sync method is achieved with electronic delay circuitry. Extensive research and development utilizing wave reassembly analysis and a unique filter design procedure has resulted in a crossover which is both time and phase coherent when used with Altec 604 monitors.

Owners of Big Red monitors can convert these popular speakers to the Time/Sync format by adding the new crossover available for delivery this January. Time/Sync crossovers have an extended equalizer range, permitting studio engineers to tune the system to fit varying acoustic environments. Improved "tighter" bass response and reduced high end distortion were the most frequent comments during the extensive field testing program of the Time/Sync crossovers in major east coast studios.

## APPLICATION NOTES . . .

The Time/Sync crossovers are a direct retrofit to the Big Red Monitors. For new installations, Red Series Time/Sync monitors are supplied with the new crossovers. Time/Sync crossovers, which require bi-amplification, can be used with any Altec 604 speaker. Time/Sync's plug-in filter section and adjustable time correction permit use of the crossover with a variety of two and three way systems. Each pair of Big Reds requires one Time/Sync crossover.

## PRICE SCHEDULE

Time/Sync Stereo Crossover one . . . . . \$645.00  
Time/Sync Big Red Monitors pair . . . . . \$1,995.00

## The A/T Family . . .



## Greg Hanks, Technical Services Manager

A California native with a wealth of technical experience in top Hollywood studios (Wally Heider, Sound Labs, ABC), Greg heads up our technical crew in both NYC and Stamford from A/T's New York office.

## TECHNICAL HELP WANTED

Audiotechniques has continuing requirements for experienced technical engineers with solid electronics background. Excellent benefits. Send resume to: Greg Hanks, Technical Manager, Audiotechniques, Inc., 1619 Broadway, New York, NY 10019.

FOR THE SOUND OF THE 80'S

RED SERIES

# time/sync™

Experience remarkable improvement in monitoring by adding Time/Sync Crossovers to your present Big Red or other Altec 604 systems. For new installations, try our new Red Series Time/Sync monitors. Go into the 80's with a great new sound!

Red Series Monitor System  
2 speakers plus Time/Sync crossover . \$1,995.00

Time/Sync Stereo Crossover . . . . . \$645.00

## audiomarketing Ltd.

652 Glenbrook Road, Stamford, CT 06906 TEL: 203 359 2315 TELEX 99 6619

Bulletin from A/T Rentals

AVAILABLE FOR RENT  
EMT 250 - LEXICON 224 DIGITAL REVERBS  
SYNTAX VOCODERS - BADAP II ANALYZERS  
MCI RECORDERS FROM MONO TO 24 TRACK  
CALL 212-586-5989

## Stereo Decision

from page 8

time with the system since loss of coverage automatically means loss of listeners, ratings and income. Kahn adds that the extensive period of testing has proven that his system does not increase interference; otherwise, the test station's co- and adjacent channel neighbors would not have stood by idly while being subjected to increased interference.

## The Sibilance Question

Kahn has also suggested that the phase systems would be susceptible to a "sibilant ghost" problem, and in comments submitted to the FCC feels he has proved his case. The supporting evidence involves a submission tape by Harris of tests performed at WGN-AM Chicago. On the tape, which was recorded through a modified Sansui TU-X1 tuner 35 miles from the WGN transmitter site, the "sibilant ghost" effect can be heard. In fact, Kahn made a similar recording by playing the same record over XETRA-AM, San Diego, which has been testing the Kahn system for some time. In his submission to the FCC, Kahn included a copy of all the recorded material as well as the Lissajous patterns as shown in Figure 1. As can be seen, the original recording shows good separation, as does the Kahn test, but separation is gone in the Harris V/CPM system.

Steve Dana (of BEE), Bill Sacks (of Carl T. Jones Associates), and Brett Cosor (of Evolution Marketing) listened to the tape submitted by Kahn using an AIWA ADK40-U cassette deck, an Audio Pro TA-150 high slew rate amp, and a pair of KEF 303 minimum diffraction speakers. The results were as reported by Kahn, namely a "sibilant ghost" effect on the Harris recording, and

none on the Kahn recording. While the effect was there to hear, it should be pointed out that this test is not a true A-B test, and other factors (such as other processing equipment in use at either station) may have made a difference in the performance of the AM stereo systems. Unfortunately, no station has run true A-B tests with all the AM stereo systems under evaluation (but that's another story).

## AM Stereo and Normal Modulation

Another issue that the Kahn-Hazeltine system has realistically confronted is the demand for extraordinary levels of modulation in the AM broadcast band. Obviously, the economics of AM radio would not permit any sacrifice in the "loudest sound in town;" hence, any AM stereo system that intends to look twice at the AM band must be ready to hold up under the strain of the big AM sound. Again, the Kahn-Hazeltine system is the only system that, when exposed to overmodulation, does not cause severe operating problems: noise breakup, pops (Magnavox, Belar and Motorola), and/or foldover envelope distortion (Harris). This insensitivity has allowed all stations using the Kahn-Hazeltine system to modulate in a normal fashion and still maintain their monophonic coverage.

## Two Receiver Method for AM Stereo

Kahn believes that another advantage, unique to the Kahn-Hazeltine ISB system, is its two receiver stereo method. This two receiver method allows stereo reception without the listener buying new equipment; thus AM stereo would be available to even the most economically pressed listener. Kahn

submitted two receiver reception tapes to the Commission and although he admits that, as an engineer, he can understand the incredulity of those who find it difficult to believe that two matched or unmatched receiver can do a job that they were not designed to do, he goes on not only to provide specific examples of this phenomenon, but also to assert that "two receiver reception, under actual receiving conditions, sounds superior to some of the other systems using special receivers." The Kahn-Hazeltine two receiver method is important for the broadcast and for the manufacturer as well. It permits a stereo sound without rendering one equipment line obsolete or creating a need for a new consumer product that might limit the availability of AM stereo reception for those unable to afford additional equipment, and consequently, the viability of AM stereo itself.

## AM Stereo and 9 KHz

Although many broadcasters and even some members of the FCC have felt that the AM stereo issue was in danger of being studied to death, the AM stereo decision has been pushed aside for some time now while the Commission deliberated on a move to reduce the AM bandwidth from 10 to 9KHz. Although the FCC has now approved this decision, it still has to be presented to a Western Hemisphere Conference early in 1980 for a final appraisal. While some FCC officials may have, in the past, suggested that there might be some relationship between the move to a narrower bandwidth and a subsequent decision to scrap AM stereo because of the amount of space it would require on that band, and because of a question of "possible

interference," the FCC's Office of Policy and Rules has assured BEE that there is no linkage between the two issues. An FCC spokesman reported to BEE that, in fact, the special task force created by the FCC to investigate the consequences of 9KHz issued a definite statement to the Commission indicating absolutely no linkage between 9KHz and AM stereo. One may assume, on the basis of that special task force's report to the Commission, that the FCC was fully aware, while approving the move from the 10 to 9KHz bandwidth, that the possibility of an AM stereo approval would not be in any way affected by the move to a narrower bandwidth. Although some engineers in both the public and private sectors may register criticism against the idea of AM stereo, the official stance of the FCC recognizes no incompatibility between the move toward a 9KHz bandwidth and the move toward AM stereo.

For some time now, AM broadcasters have been struggling under a competitive disadvantage with FM stereo. The Kahn-Hazeltine system, the original AM stereo and the most generally supported by the broadcasters themselves, may well, as Lin Broadcasting so aptly states, "... add another channel, so to speak, to AM broadcasting. We believe that AM stereo will offer the public a choice between two stereo alternatives in programming, so that this ability for choice will not only serve the public interest, but enable AM radio to compete and remain a viable medium in the future." It's time now for the FCC to act.

See Action-gram  
on page 15 ...  
subscribe to BEE

## Start Right

from page 5

average squarefoot per dollar hour differences between a multitrack music studio and a production studio. Using New York rates for a moment, a large music studio that commands \$200 an hour and up has to dedicate roughly 2000-2500 square feet per recording room to achieve a viable working studio situation. This does not include the space necessary for maintenance rooms, or the halls and corridors to handle large numbers of people. For the production studio, a studio control room combination can be built comfortably in 400-600 square feet and without the need for large traffic area. Top NY production studios command \$60-\$75 an hour, whether or not an announcer is being recorded. So, if a full-fledged production facility has a number of rooms, there may be 2 announce-over rooms and a selection of mix-

only rooms, which would only require 200-300 square feet each.

Just to play the numbers for a moment, if we had 3000 sq. ft. of real estate, we could build either one full-fledged recording room and back office facilities, or 2 announce-over mix rooms, 4 dedicated mix rooms, back up facilities and room to spare. With 6 rooms each going at \$75 an hour, there is something to be said for the financial attractiveness of the option, or at least a fraction thereof.

In the next few months, we are going to consider additional topics pertaining to production work: Sync generation and Resolving, Pulse techniques for A/V systems: design and layouts for different production studios, production consoles, standards and any other questions or topics our readers would like to cover.

## EMPLOYMENT CLASSIFIED

## POSITIONS WANTED

I am seeking a radio position in Spanish radio stations in Chicago, Los Angeles, San Francisco, New York, Texas, Delaware or any place with Spanish population in United States. Have 15 years of Radio experience. Resume and tape later. Send replies to Frankie Rodriguez, Box 1361, Yavco, P.R. 00768.

AM, FM or combination owners. Thinking of selling? Upgrading? Experienced broadcast executive seeking first owner/operator venture in medium or small market. Let's talk. No brokers, please. J.U. Steele/Editor, NAB Code Authority, 477 Madison Avenue (#1405), New York, New York 10022. (202) 759-7020.

Current Chief Engineer wants to work with Christian radio. Must be ministry oriented. Degree. Also several years on-air. John Hutcheson, Rt. 1, Box 238Y, Homesassa, FL 32646, 904-628-6766.

## POSITIONS WANTED

Versatile AM/FM Engineer. 5-1/2 yrs radio engineering, 5 yrs Chief Engineer, 14 yrs total electronics industry experience. Well versed in audio, AM/FM transmitters, automation. Much experience also in public affairs, news. Greater San Francisco Bay Area preferred. I'm a reliable, hard-worker. Available now. Michael Brown, 615 Greenwood Ave., Coos Bay, Oregon 97420. 503-269-1089.

3 yrs Radio experience, D.J., Studio Control, News, Sales, Sportscaster. Looking for full time employment, currently working part-time at New Jersey based M.O.R. stations. Looking for employment in New Jersey, New York, Penn., or Cleveland, Ohio area. Tape available. Send replies to: Box 91, Stirling, New Jersey 07980.

## HELP WANTED

Chief Engineer for KCIA/KYKK, Humble City, Hobbs, New Mexico, phone Jerome Orr, 505-392-6546. KYKK is 100,000 watt stereo, KCIA is 1000 watts on 1110 AM.

For listings with Box numbers, reply to  
Box \_\_\_\_\_, c/o BEE, PO Box 1238, Arlington VA 22210

# Aviso Importante

## Para Radiodifusores de México!

Usted ahora tiene acceso a la lista de equipo de radiodifusión mas extensa en el mundo.

**Ofrecemos mas de 1,000 referencias en cada publicación.**

Debido a un acuerdo exclusivo con esta publicación. Broadcast Equipment Exchange (BEE). Guarantee Radio se complace en ofrecerle a usted y a los demas radiodifusores de México esta gran oportunidad.

En las siguientes paginas usted encontrará, convenientemente catalogadas, mas de mil referencias de equipo usado de radiodifusión.

Con esta extensa selección. Guarantee Radio le permite comprar equipo de uso con la misma facilidad como si lo comprara nuevo.

Examine nuestra lista y convéncese de que este servicio que le ofrece Guarantee Radio le ahorrara largas horas y dinero en su búsqueda de equipo usado.

Para mas información, incluyendo precios llamenos al telefono:

**512-723-6913**

ABC AUTOMATION  
AKG MICROPHONES  
CSI TRANSMITTERS  
RCA TRANSISTORS, MODULES, IC'S  
RCA TRANSMITTING TUBES  
RCA TRANSMITTING PARTS  
RCA INDUSTRIAL TUBES  
AKAI  
ALTEC  
AMPEREX  
AMPEX  
AMPHENOL  
AMPRO  
ANDREW  
ATLAS SOUND  
AUDIO DISK  
BELDEN  
CANNON  
CHICAGO MINIATURE  
EIMAC TUBES  
ELECTRO VOICE  
FIDELIPAC  
INOVONICS

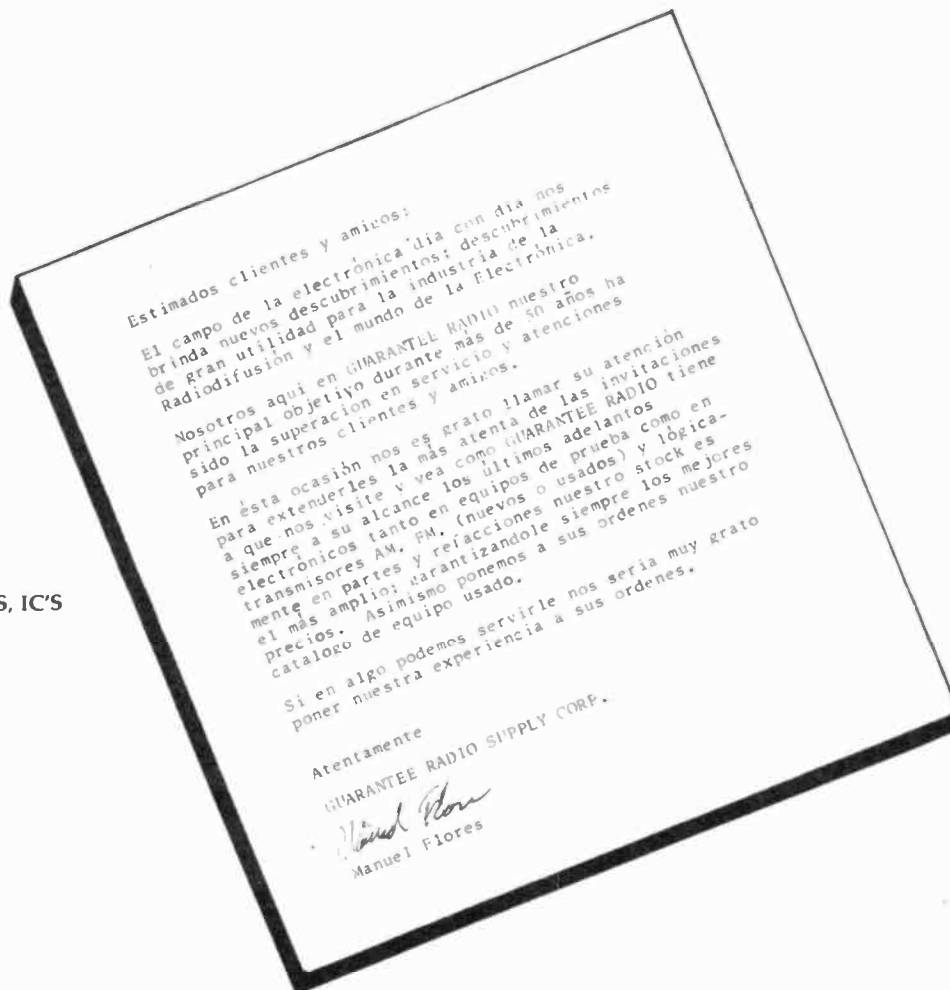

LITTLEFUSE  
LOGITEK  
MARTI  
MC MARTIN  
METROTECH  
MICRO TRAK  
OHMITE  
ORANGE COUNTY ELECTRONICS  
Q.R.K.  
REK-O-KUT  
REVOX  
ROHN TOWERS  
SCULLY  
SEQUERRA  
SHURE MICROPHONES  
SIMPSON  
SONO-MAG CORP.  
SYLVANIA, TUBES, TRANSISTORS, IC'S  
TACO  
TECHNICS  
TIME FREQUENCY TECHNOLOGY (TFT)  
TRIPLITT  
UNIVERSITY SOUND  
U.R.E.I.

## Guarantee Radio Supply Corp.

**Wholesale Distributors**

1314 ITURBIDE ST.  
LAREDO, TEXAS 78040

Circle 114 on Action-gram

# The Exchange The Exchange The Exchange

## AMPLIFIERS

### Want To Sell

*Marantz Model 7T preamp (pre Japan), excel. cond. Key Code 1-14E.*

*Peavey CS-800 stereo amp, 400 watts per ch., 800 watts mono, like new with book. Key Code 1-55.*

*McIntosh MC40 (2), excel. Key Code 1-9A.*

*Technics SU-8011, 25-watt per ch stereo amplifier, new in original carton, w/warranty. Key Code 1-80.*

*Marantz Model 5. Key Code 1-9.*

*McMartin LT10B amplifiers like new, MSA-1 pre-amps like new. Key Code 1-11.*

*Spotmaster solid state pre-amp's (3). Key Code 12-66.*

*Knight Stereo Pre-Amp, tube model. Key Code 12-40.*

*Toshiba 70W per ch headphone amp (Micro series). Key Code 12-58.*

*Eico mono preamps & power amps, good cond, not used commercially. Key Code 12-65.*

*BGW 100 power amplifier. Key Code 12-58.*

*Gates M5215 pre-amps, (3) need tubes. Make offer. Key Code 11-14.*

*Southwest Technical Products 215/A power amplifier, solid state, 15w. per ch., works well. Key Code 11-23.*

*Quad 303 Power amp (English) 45 watts/channel, Quad 33 preamp, Quad FM-3 tuner. Key Code 11-25.*

*Crown DC 300 power amp. Key Code 11-25.*

*McIntosh MC-60 mono tube amp (2), excel. cond., recently factory overhauled. Key Code 11-43.*

*Marantz 250 stereo power amp, 250 watts, rack mount, w/manual. Key Code 11-72.*

*BGW 750B, 800 watt power amp w/bal inputs (brand new). Key Code 11-25.*

*Hafner DT-101 peamp assembled with all acc. never used. Key Code 11-25.*

*Dyna ST-416 with C-100 capacitance bank add-on. Mint cond. Key Code 11-43.*

*Marantz 3300 stereo preamp. Rack mount, w/manual. Key Code 11-72.*

*SAE 2200 power amp (200 watts/channel). Key Code 11-25.*

*CM Preamp CC1, an early solid state classic, plus many assorted vintage tube amps in varying cond. including Heath W-4AM's, Eico HF 20's, HF 87, Bogen D13-20, etc. Key Code 11-25.*

*Heathkit 40 w/ch, stereo tube amp., works well, good cond. Key Code 11-43.*

*Dynaco 70 tube-type power amplifier. 35 w. per ch. Good condition. Key Code 11-23.*

*SAE Model 9 preamp with graphic EQ. Key Code 11-25.*

*Collins 212Y single ch remote amp. Collins 212Y w/2 ch 60H mixer. Gates 4 ch Dynamote remote amp. Key Code 11-39.*

*Yamaha P-2200 amplifier, new, 230 watts into 8 ohms. Key Code 11-55.*

*McIntosh C-8 pre-amps (2) with power supplies. Key Code 11-17.*

*Shure M-64 phono preamp, like new. Key Code 11-23.*

*Collins 12Z remote amplifier, fair condition. Key Code 11-49.*

*AB-Systems model 205-200 watt amp. new (2). Key Code 11-61.*

### Want To Buy

*RCA BA-71C pre amp (4), BA-74B monitor amps (2), BA-73B program amps (2), for parts, mainly for input-output transformers. Key Code 12-27.*

## ANTENNAS & TOWERS

### Want To Sell

*Cable clamps and misc. tower hardware. Key Code 1-76.*

*Andrew 1-5/8" gas barrier (1261B), 90 degree miter elbow (1061) and 58" rigid transmission line (2761-1). Key Code 1-74.*

*Horizontal Jampro antennas (6) w/heaters tuned to 93.1 MHz. Key Code 1-76.*

*Iso-Coupler, Electronics Research type 402, adjusted for 94.5 MHz. Key Code 1-74.*

*Ten 20' sections, 6-1/8 flanged both ends, one 7' section with 45 degree elbow 50 ohms, gd. cond. Key Code 1-70.*

*Andrew 50 ohm rigid transmission line, 1 1/2", 250' in 20' lengths. Key Code 12-44.*

*Gates tuning box, used to tune 1340 KHz to 150' tower, extra caps included, only one year old, used indoors, like new. Key Code 12-61.*

*Phelps-Dodge 3 bay CFM-LP-3, w/radoms, 1.5db gain, tuned 92.7 MHz, 1 yr old. Key Code 12-49.*

*Sample loops (3), legal in Canada and Mexico, make offer. Key Code 12-20.*

*RCA BFC-12 FM antenna tuned to 90.1. Needs a little work. Key Code 11-10.*

*Heliac FHJ2-50A sampling or low power transmission line. 3/8", three 900' sections. Key Code 11-28.*

*Rohn self supporting 100 foot SSVW-100 complete with 4' short base. Key Code 11-30.*

*Beacon tower lighting system, complete. Fair condition. Key Code 11-32.*

*Air Heliac line 1 1/2", type H57-50A, 500' in 2 pieces, 300' & 200' approx. Key Code 11-16.*

*Steel guy wire 3/8", various lengths, good condition. Make offer and state length. Key Code 11-8.*

*Gates FM-10 KW isocoupler, 1 1/2" tunable/pressurized, good cond. Key Code 11-32.*

*Wilkinson SIA-3 line surge protector. Key Code 11-45.*

*4-Bay FM antenna. Horz. & Vert. Key Code 11-16.*

### Want To Buy

*45' pole for top of FM tower to hold FM antenna, 3 bay, new preferred. Key Code 1-70.*

*Tower, 150' or 200', any cond for low budget FM operation. Key Code 12-56.*

*C.P. antenna, 1 Bay, tunable to 94.3 MHz, must handle 3500 watts input power. Key Code 12-65.*

*Tower approx 100'. Key Code 12-44.*

*Superturndale (used) 6 bays, channel 9. Key Code 11-68.*

*Self-support pole, 100'. Key Code 11-15.*

*Tower, 300', self supporting preferred for FM antenna, may be new or used, ready to ship. Key Code 11-52.*

*Circular polarized antenna, 2 or 3 bay, 93.7 MHz to handle 1 KW or more input power. Key Code 11-73.*

*FM Antenna up to 10 bay-vertical only, returnable complete. Call BEE, 800-336-3045.*

## AUDIO PRODUCTION (OTHER)

### Want To Sell

*Urei Digital Metronome, Model 963. Key Code 1-32.*

*Urie 567 P.A. processor. Key Code 1-82.*

*Jackfield, Switchcraft 1400 w/26 MT-334B jacks, 22 individual MT-334B jacks (loose), 2 ea. Cannon XLR-3-35 wall microphone receptacle, all new. Key Code 1-54.*

*Advent Model 100 noise reduction units (2), excel cond. Key Code 1-36.*

*Cinema 4031-B equalizers (3), Hycor 4201 equalizer (1). Key Code 1-28A.*

*JBL Mark XII Studio monitors (pair), excel. cond. Key Code 1-35.*

*ARP Odyssey II Electronic music synthesizer model 2813. Key Code 1-34.*

*B&K precision level meter, type 2203, w/Octave filter set, type 1613, also many attachments and extras. Key Code 1-32.*

*DBX 155 units, 4 available, 4 ch switchable, or 2 ch simul, record and play, new. Key Code 12-45.*

**TASCAM!**  
FROM DETROIT'S PRO-AUDIO  
WAREHOUSE

**Sound Solutions**

**(313) 739-7020**

*Gorman-Redlich Model CEB, EBS encoder/decoder, new. Key Code 12-61.*

*Altec 605A spkr., no cabinet, excel. cond. Key Code 11-17.*

*API Model 440, conductive plastic linear motion faders, (7). Key Code 11-17.*

*Dorrough 310 discriminate audio processors (2). New cond., latest circuit updates. Will ship. Key Code 11-19.*

*Fairchild 664 passive equalizers, no cases or hardware, need knobs, diagrams are available, good condition. Key Code 11-23.*

*Hycor, model 421. UTC, model 4C. Gray 810 stereo TT EQ. (2). Gray 808 mono TT EQ. (3). Gray 602C TT EQ. Key Code 11-39.*

*Garner 105 (bulk tape eraser), new. Key Code 11-55.*

*DBX 187 like new cond. 4 ch. switchable record or play. Key Code 11-55.*

## International Contact Section

For more information on any product listed in BEE contact the following companies:

**In Canada:** United Video Ltd

1485 Triole Street

Ottawa, Ontario K1B 3S4 or  
Canada

613-741-5554

Norbec Video Ltee

4315 Girouard

Montreal, Quebec H4A 3E5  
Canada

514-481-3483

**En Mexico:** Exclusivo, para mas informacion, llamen:

Guarantee Radio Supply Corp

1314 Iturbide Street

Laredo TX 78040 E.U.A.

512-723-6913

**In Other Countries:**

Broadcast Equipment Exchange

PO Box 1238

Arlington, VA 22210 USA

Tel: 703-525-0400

TELEX: IMASINC 64593

Cable: IMASINC ARLINGTON VA

*Southwest Technical Products 216/A graphic equalizer, built from a kit, 9 frequency stereo, very good condition. Key Code 11-23.*

*General Radio modulation monitor (AM), works, clean. Two Schaffer 25Hz generators. Limpander compression amp. Eico model 666 tube tester. Key Code 11-53.*

*Eddor, Inovonics, Orban, Urei, Delta Labs, Technics, dbx, Lexicon, Eventide, Strand Sound, and Tapco. All available from Full Compass Systems, 6729 Seybold Rd, Madison WI 53719. Tel: 608-271-1100 or TWX: 910-268-2745.*

*Kenwood audioscope model KD 3500. Key Code 11-72.*

*Grado signature model 1B cartridge, hand made, never used. Key Code 11-72.*

*Gates 48 point jack bay, two rows of mono closed-circuit jacks (1/4"). Good condition. Key Code 11-23.*

*Dyna SE-10 stereo 10 band equalizer. Quiet flexible unit, like new, factory assembled. Key Code 11-43.*

*DBX 122 and DBX 124, excel. cond. Key Code 11-51.*

*Fairchild 664 equalizer, excellent condition, like new, (4). Key Code 11-66.*

*Heathkit audio scope model AD 1013. Key Code 11-72.*

*Soundcraftsman 20-12 EQ. Key Code 11-47.*

*Ivie Audio Analyzer, IE-30s and ID-10s in stock. Triad Productions Inc, 1910 Ingersoll, Des Moines IA 50309. 515-243-2125.*

### Want To Buy

*Haeco CSG Stereo to mono compatilizer. Key Code 12-8.*

*Patch panel, 24 pair, double row. Must be in good condition. Key Code 11-12.*

*Dorrough DAP audio processor. Key Code 11-67.*

*EMT 140 reverb plates, mono or stereo, EMT 240 gold foil reverb. Pultec EQP-1, MEQ-5 tube type. Key Code 11-76.*

*Patch cords, single or double plug reinforced cables. Need at least six pair. Key Code 11-12.*

*Maze R-1 or similar reverb for production use. Key Code 11-28.*

*Multimax by Pacific Recorders. Key Code 11-15.*

## AUTOMATION EQUIP.

### Want To Sell

*Schafer 800 automation brain, tube type working when removed. Key Code 1-74.*

*Schafer 800T stereo brain, slow speed logger, network joiner, SMC 250 random select carousel, plus 5 racks. Key Code 1-33.*

*ITC 750 series reel play back only, gd. cond. Key Code 1-23.*

*Schafer system, complete, 3 Ampex reel-to-reel decks, 3 carousels, and time announce, lots of spare parts. Key Code 1-48A.*

*Gates DCU-3 25Hz sensor, gd. cond. Key Code 1-23.*

*Tone Sensors, 25 Hz for automation, in gd. cond. Key Code 1-74.*

*Gates DC-10 clock with model TA time announce unit, gd. cond. Key Code 1-23.*

*Remote Control for live assist for SMC DP-2. Key Code 12-64.*

*IGM RAM automation used 16 months, all updated modifications made. Includes 4 ITC reel decks, time announce, 3 carousels, 4 racks. Original cost \$24,000. Replacement cost \$27,000. Will take best offer. K. Confer, KSSN, Box 96, Little Rock AR 72203. 501-378-0200.*

*Continental "Probe" Automation Systems, 2 Scully 270 decks with individual 25Hz sensors, 2 carousels, 1 single play (stereo). Key Code 12-64.*

*Automation system including SCM DP-2 with 10 carousels, time announce, logging, etc. Never used. Key Code 11-22.*

In the U.S. call 800-336-3045  
For any Key Code Names and Addresses.

**800-336-3045**

New Listings are in *Italics*.

# ACTION-GRAM

JANUARY 1980  
USE BEFORE  
APRIL 1980

**Instructions:** Use this form to take advantage of any of the services provided by *Broadcast Equipment Exchange*. Always fill in the Contact Section below first, then fill in the appropriate service section(s). Remember, BEE provides a FREE listing service for end-users. Listings are printed *without* the listee's name and address... A Key Code is used instead. Paid subscribers receive their issues of BEE with the matching Key Code list. Non-paid subscribers do not; they pay for the Key Code only when they order it (see the Subscription Section below).

|                                                                                                                                                                                                                                                                    |                                                                                                                                                                                                                                                                                                                                                                                                                                                                                                                                        |                                                                                                                                                                                                                                                                                                                                                                                                                                                                                                                                                                                                                                                                                                                                                                                                                                                                                                                                                                                                                                                                                                                                                      |     |     |     |     |     |     |     |     |     |     |     |     |     |     |     |     |     |     |     |     |     |     |     |     |     |     |     |     |     |     |     |     |     |     |     |     |     |     |     |     |     |     |     |     |     |     |     |     |     |     |     |     |     |     |
|--------------------------------------------------------------------------------------------------------------------------------------------------------------------------------------------------------------------------------------------------------------------|----------------------------------------------------------------------------------------------------------------------------------------------------------------------------------------------------------------------------------------------------------------------------------------------------------------------------------------------------------------------------------------------------------------------------------------------------------------------------------------------------------------------------------------|------------------------------------------------------------------------------------------------------------------------------------------------------------------------------------------------------------------------------------------------------------------------------------------------------------------------------------------------------------------------------------------------------------------------------------------------------------------------------------------------------------------------------------------------------------------------------------------------------------------------------------------------------------------------------------------------------------------------------------------------------------------------------------------------------------------------------------------------------------------------------------------------------------------------------------------------------------------------------------------------------------------------------------------------------------------------------------------------------------------------------------------------------|-----|-----|-----|-----|-----|-----|-----|-----|-----|-----|-----|-----|-----|-----|-----|-----|-----|-----|-----|-----|-----|-----|-----|-----|-----|-----|-----|-----|-----|-----|-----|-----|-----|-----|-----|-----|-----|-----|-----|-----|-----|-----|-----|-----|-----|-----|-----|-----|-----|-----|-----|-----|-----|-----|
| <p><b>CONTACT SECTION:</b></p> <p>Name _____</p> <p>Title _____</p> <p>Company/Station _____</p> <p>Address _____</p> <p>City _____</p> <p>State _____ Zip _____</p> <p>Telephone _____<br/><i>(Verifiable number must be provided)</i></p> <p>Signature _____</p> | <p><b>KEY CODE ORDER SECTION:</b></p> <p style="text-align: center;"><b>TOLL FREE KEY CODE HOTLINE</b></p> <p style="text-align: center;"><b>800-336-3045</b></p> <p style="text-align: center;"><small>In Virginia call 703-525-0400 collect.</small></p> <p>...our Hot Line telephone number. When you call, we will give you any Key Code names and addresses and send you the full list with an invoice for \$5.</p> <p style="text-align: center;">International Readers<br/>See International Contact Section<br/>on page 14</p> | <p><b>READER INQUIRY SECTION:</b> <span style="float: right;">1/80</span></p> <p>If you are interested in receiving literature from any of the advertisers, in this issue of the <i>Broadcast Equipment Exchange</i>, then circle the numbers as shown at the bottom of the ads, and we will be happy to forward your request to the appropriate company.</p> <table style="width:100%; border: none;"> <tr><td>101</td><td>107</td><td>113</td><td>119</td><td>125</td><td>131</td><td>137</td><td>143</td><td>149</td></tr> <tr><td>102</td><td>108</td><td>114</td><td>120</td><td>126</td><td>132</td><td>138</td><td>144</td><td>150</td></tr> <tr><td>103</td><td>109</td><td>115</td><td>121</td><td>127</td><td>133</td><td>139</td><td>145</td><td>151</td></tr> <tr><td>104</td><td>110</td><td>116</td><td>122</td><td>128</td><td>134</td><td>140</td><td>146</td><td>152</td></tr> <tr><td>105</td><td>111</td><td>117</td><td>123</td><td>129</td><td>135</td><td>141</td><td>147</td><td>153</td></tr> <tr><td>106</td><td>112</td><td>118</td><td>124</td><td>130</td><td>136</td><td>142</td><td>148</td><td>154</td></tr> </table> | 101 | 107 | 113 | 119 | 125 | 131 | 137 | 143 | 149 | 102 | 108 | 114 | 120 | 126 | 132 | 138 | 144 | 150 | 103 | 109 | 115 | 121 | 127 | 133 | 139 | 145 | 151 | 104 | 110 | 116 | 122 | 128 | 134 | 140 | 146 | 152 | 105 | 111 | 117 | 123 | 129 | 135 | 141 | 147 | 153 | 106 | 112 | 118 | 124 | 130 | 136 | 142 | 148 | 154 |
| 101                                                                                                                                                                                                                                                                | 107                                                                                                                                                                                                                                                                                                                                                                                                                                                                                                                                    | 113                                                                                                                                                                                                                                                                                                                                                                                                                                                                                                                                                                                                                                                                                                                                                                                                                                                                                                                                                                                                                                                                                                                                                  | 119 | 125 | 131 | 137 | 143 | 149 |     |     |     |     |     |     |     |     |     |     |     |     |     |     |     |     |     |     |     |     |     |     |     |     |     |     |     |     |     |     |     |     |     |     |     |     |     |     |     |     |     |     |     |     |     |     |     |     |
| 102                                                                                                                                                                                                                                                                | 108                                                                                                                                                                                                                                                                                                                                                                                                                                                                                                                                    | 114                                                                                                                                                                                                                                                                                                                                                                                                                                                                                                                                                                                                                                                                                                                                                                                                                                                                                                                                                                                                                                                                                                                                                  | 120 | 126 | 132 | 138 | 144 | 150 |     |     |     |     |     |     |     |     |     |     |     |     |     |     |     |     |     |     |     |     |     |     |     |     |     |     |     |     |     |     |     |     |     |     |     |     |     |     |     |     |     |     |     |     |     |     |     |     |
| 103                                                                                                                                                                                                                                                                | 109                                                                                                                                                                                                                                                                                                                                                                                                                                                                                                                                    | 115                                                                                                                                                                                                                                                                                                                                                                                                                                                                                                                                                                                                                                                                                                                                                                                                                                                                                                                                                                                                                                                                                                                                                  | 121 | 127 | 133 | 139 | 145 | 151 |     |     |     |     |     |     |     |     |     |     |     |     |     |     |     |     |     |     |     |     |     |     |     |     |     |     |     |     |     |     |     |     |     |     |     |     |     |     |     |     |     |     |     |     |     |     |     |     |
| 104                                                                                                                                                                                                                                                                | 110                                                                                                                                                                                                                                                                                                                                                                                                                                                                                                                                    | 116                                                                                                                                                                                                                                                                                                                                                                                                                                                                                                                                                                                                                                                                                                                                                                                                                                                                                                                                                                                                                                                                                                                                                  | 122 | 128 | 134 | 140 | 146 | 152 |     |     |     |     |     |     |     |     |     |     |     |     |     |     |     |     |     |     |     |     |     |     |     |     |     |     |     |     |     |     |     |     |     |     |     |     |     |     |     |     |     |     |     |     |     |     |     |     |
| 105                                                                                                                                                                                                                                                                | 111                                                                                                                                                                                                                                                                                                                                                                                                                                                                                                                                    | 117                                                                                                                                                                                                                                                                                                                                                                                                                                                                                                                                                                                                                                                                                                                                                                                                                                                                                                                                                                                                                                                                                                                                                  | 123 | 129 | 135 | 141 | 147 | 153 |     |     |     |     |     |     |     |     |     |     |     |     |     |     |     |     |     |     |     |     |     |     |     |     |     |     |     |     |     |     |     |     |     |     |     |     |     |     |     |     |     |     |     |     |     |     |     |     |
| 106                                                                                                                                                                                                                                                                | 112                                                                                                                                                                                                                                                                                                                                                                                                                                                                                                                                    | 118                                                                                                                                                                                                                                                                                                                                                                                                                                                                                                                                                                                                                                                                                                                                                                                                                                                                                                                                                                                                                                                                                                                                                  | 124 | 130 | 136 | 142 | 148 | 154 |     |     |     |     |     |     |     |     |     |     |     |     |     |     |     |     |     |     |     |     |     |     |     |     |     |     |     |     |     |     |     |     |     |     |     |     |     |     |     |     |     |     |     |     |     |     |     |     |

**SUBSCRIPTION SECTION:**

There are three ways of receiving BEE, so choose the way that suits you best:

|                                                                                                                                                                                                                                                                                                                                                                                                                                                 |                                                                                                                                                                                                                                                                                                                                                                                                                                                        |                                                                                                                                                                                                                                                                                                                                                                |
|-------------------------------------------------------------------------------------------------------------------------------------------------------------------------------------------------------------------------------------------------------------------------------------------------------------------------------------------------------------------------------------------------------------------------------------------------|--------------------------------------------------------------------------------------------------------------------------------------------------------------------------------------------------------------------------------------------------------------------------------------------------------------------------------------------------------------------------------------------------------------------------------------------------------|----------------------------------------------------------------------------------------------------------------------------------------------------------------------------------------------------------------------------------------------------------------------------------------------------------------------------------------------------------------|
| <p><b>1. FIRST CLASS MAIL WITH KEY CODE LIST.</b> Avoid delay ... get in on the action faster! For \$25 per year, you get BEE 1st class WITH the matching Key Code number list. (Enclose your check with your order and get 3 BONUS issues!).</p> <p><input type="checkbox"/> Bill me \$25 for a 1 year, 1st class mail subscription to BEE including the Key Code list.</p> <p><input type="checkbox"/> Check enclosed for 3 BONUS issues!</p> | <p><b>2. THIRD CLASS MAIL WITH KEY CODE LIST.</b> Save better than 50% by reducing our handling costs! For \$12 per year receive BEE via 3rd class mail WITH the KEY CODE list included. (Enclose your check with your order and get 3 BONUS issues!).</p> <p><input type="checkbox"/> Bill me \$12 for 1 year, 3rd class mail subscription to BEE including the Key Code List.</p> <p><input type="checkbox"/> Check enclosed for 3 BONUS issues!</p> | <p><b>3. You receive BEE monthly WITHOUT THE KEY CODE LIST</b> free via 3rd class mail if you send in this form at least once a year. You buy the Key Code lists for \$5 by using the Key Code order section above; only when you need it.</p> <p><input type="checkbox"/> Free without the Key Code list (I'll buy the list for \$5 only when I need it).</p> |
|-------------------------------------------------------------------------------------------------------------------------------------------------------------------------------------------------------------------------------------------------------------------------------------------------------------------------------------------------------------------------------------------------------------------------------------------------|--------------------------------------------------------------------------------------------------------------------------------------------------------------------------------------------------------------------------------------------------------------------------------------------------------------------------------------------------------------------------------------------------------------------------------------------------------|----------------------------------------------------------------------------------------------------------------------------------------------------------------------------------------------------------------------------------------------------------------------------------------------------------------------------------------------------------------|

**LISTING SECTION:**

*Broadcast Equipment Exchange* provides FREE listings for all broadcast or pro-sound end users. Send in your "Want to Sell" or "Want to Buy" requirements, and we will list them in BEE for three full months. Hundreds of stations and companies have used us successfully. Why don't you? The

|                                                                                                                                                                                                                                                             |                                                                                                                                                                                                                                                                                                                                                                                                                                                                                                                                                                                                                                         |
|-------------------------------------------------------------------------------------------------------------------------------------------------------------------------------------------------------------------------------------------------------------|-----------------------------------------------------------------------------------------------------------------------------------------------------------------------------------------------------------------------------------------------------------------------------------------------------------------------------------------------------------------------------------------------------------------------------------------------------------------------------------------------------------------------------------------------------------------------------------------------------------------------------------------|
| <p>1. WTS or WTB, Category: _____</p> <p>Text: _____</p> <hr/> <p>2. WTS or WTB, Category: _____</p> <p>Text: _____</p> <hr/> <p>3. WTS or WTB, Category: _____</p> <p>Text: _____</p> <hr/> <p>4. WTS or WTB, Category: _____</p> <p>Text: _____</p> <hr/> | <p>system is simple, just fill in your listing below, and send this form in by the 15th of the month preceding issue. Don't forget to fill in the contact section above before you mail the form. On each listing please circle either "Want to Sell" (WTS) or "Want to Buy" (WTB), and if possible please note in which category you would like the listing to be run.</p> <p>5. WTS or WTB, Category: _____</p> <p>Text: _____</p> <hr/> <p>6. WTS or WTB, Category: _____</p> <p>Text: _____</p> <hr/> <p>7. WTS or WTB, Category: _____</p> <p>Text: _____</p> <hr/> <p>8. WTS or WTB, Category: _____</p> <p>Text: _____</p> <hr/> |
|-------------------------------------------------------------------------------------------------------------------------------------------------------------------------------------------------------------------------------------------------------------|-----------------------------------------------------------------------------------------------------------------------------------------------------------------------------------------------------------------------------------------------------------------------------------------------------------------------------------------------------------------------------------------------------------------------------------------------------------------------------------------------------------------------------------------------------------------------------------------------------------------------------------------|

**IMAS BROADCAST EQUIPMENT EXCHANGE** accepts no responsibility for the condition of the equipment listed. Classified listings with contact information are available to manufacturers, dealers, brokers, distributors, etc. on a \$12 per listing basis. Call or write for complete details. We make no attempt to evaluate equipment, but rather publish exactly what is sent to us by the listers.

**FILL IN, REMOVE, AND MAIL THIS FORM TO...**

**BROADCAST EQUIPMENT EXCHANGE**  
P.O. BOX 1238  
ARLINGTON, VA. 22210 U.S.A.

# The Exchange The Exchange The Exchange

## AUTOMATION...WTS...CONTD.

**IGM 500** stereo automation system, including 2 Metrotech 500A reel-to-reel, 2 SMC carousels, Model 500 control module & monitor panel & timer, in 2 racks. Key Code 11-18.

**Random select 252** stereo carousels, in use now, excellent condition, new heads. Key Code 11-6

**Autogram automation**, includes 2 random-select cart. 1 Scully tape, 1 sequential. Collins 26U-3 limiting amps (2). Key Code 11-16.

**Random select 250** series carousels in good condition, can be easily converted to stereo. Key Code 11-6.

**Schafer 800** mono, 10 source, 24 event, w/silence sense, 25Hz detector, 2 Scully 270 playback decks in two racks: Schafer Brain alone, in rack, Schafer TM-8 controller for time announce machines. Key Code 11-53.

**Scully 270-2** stereo 14" playback decks (2), w/2 DCU-3 25Hz. Tone detectors, in grey Schafer rack. Key Code 11-53.

**IGM stereo automation system** including IGM 600 brain, IGM carousels, IGM single play cart system, Scully 270 reel-to-reel (2), Network switch on, IBM printers, IBM type punch card readers, IBM 26 printing card punch, card file, spare cards, parts, drawings. Key Code 11-56.

### Want To Buy

**Tone generator for Automation system**, must be in excel cond. Key Code 1-59.

**Go-Cart or carousels for Automation system** in excel cond. Key Code 1-59.

**Time carts for Automation system plus logger** in working order. Key Code 1-59.

**Playback machines w/large reel capacity**, operating or repairable, also sensors. Buy outright or swap old mikes. Key Code 1-19.

**Autogram, Sparta or similar stereo sequential cartridge type automation**. Key Code 1-60.

**IGM MOS-200 or MOS-400 set up for carousel control**. Key Code 1-53.

**Stereo sequential automation with logging**, small. Key Code 1-60.

**IGM Model 500 music modules**. Key Code 1-53.

**Carousel or similar**, like Instacart, etc units, any cond. Key Code 12-56.

**Time Announcer for automation system**, must be in good condition. Key Code 12-5.

**Cart Machines**, rack mounted for automation, in good working condition. Key Code 12-5.

**Tone Generator for automation**, must be in excellent condition, 25 Hz. Key Code 12-5.

**Carousels for automation**, must be in good working condition. Key Code 12-5.

**SMC SSP-30-60 automation PGM's**, SMC AS-10 switcher (audio), SMC P.S.A. power supply for above. Key Code 12-32.

## CAMERAS (VIDEO)

### Want To Sell

**Hitachi FP20 Saticon**, new, factory warranty, latest model, \$8400, complete but w/o lens, incl. 3 Saticons, carrycase. SounDesign, Box 921, Beverly Hills CA 90213. 213-276-2726.

**Ikegami 240 with Saticon tubes**, less than 1 yr old, many accessories including batteries, shoulder pad, phase shifter module, headsets. Paid \$23,400 less than 1 yr ago, make offer. Terry Hamad or Patricia Chamberlin, Instant Replay Video Productions, 2303 Kemper La, Cincinnati OH 45206. 513-861-7065.

**Sony 1610 Color video camera and 3800 VCR**. Key Code 1-10.

**Sony 1610, (2) Sony 3450, Sony 2850A's w/TRI Edit controller**, V03800, V01600, Panasonic 19" monitor, plus misc. Key Code 1-6A.

**RCA PK-330 B&W studio cameras**, 3 heads w/15-150 Angenieux lenses (motor-driven iris & zoom), 2-CCUs, 600 ft of cabling, manuals. Key Code 1-79A.

**Sony 5000BP (Plumbicon) Color Cameras (3)**, Color Control Units and Sync Generator for \$15,000. Special Effects Generator and Phase Shifter also available. Call Dave in PA, 215-337-3836.

**IVC/B & H 90 self contained vidicon color cameras**, 3 pcs some with lens. Key Code 1-44.

**Norelco PC-70 camera**, with tubes & complete w/pneumatic pedestal & cradle head, gd cond, used in studio only. Key Code 12-43.

**Panasonic WV-2200 camera w/NV-3085 VTR**, NAV-610 color adapter w/power supplies & all hookup cables. Key Code 12-1.

**Panasonic WV-3700**, portable demo, 1 yr warranty. Key Code 12-34.

**Phillips LDH20**, 2 avail, 3 Tube Plumbicon, w/CCU, 500' cable ea, 1:10 zoom lens, 2X teletender, Video Control Unit, ITE cam head, tripod & dolly. Excellent condition. Key Code 12-6.

**Hitachi FP-1212**, 3-Tube Plumbicon, w/CCU, 50' cable, 1:10 zoom lens, tripod, dolly, excellent condition. Key Code 12-6.

**Hitachi 1000P**, 3 Tube Plumbicon, w/CCU, 50' cable, 1:15 zoom lens, tripod, dolly, excellent condition. Key Code 12-6.

**Panasonic WV-2150 KT**, demo, full warranty. Key Code 12-34.

**Hitachi FP20**, 3-saticon tube camera, new with factory warranty. Key Code 11-63.

**JVC GC-4800U color camera w/CCU**, GA-20U adapter, 33' camera extension cable, and 4X zoom. Operates good. \$1,795. Inderwiesen Assoc., Box 7791, Orlando FL 32804. 305-295-3034.

**IVC-100 with internal encoder**, fair cond. Plumbicons, good cond. with manual. Key Code 11-3.

**Norelco LDH-1 color camera**, plumbicon, 10-1 zoom, I.T.C. dolly pod, with oscilloscope. Key Code 11-71.

**RCA TK 41 color camera**, 2 ea w/lenses, pan head, extra tubes, yokes, etc. Make offer. Key Code 11-75.

**RCA TK 30 B & W**, I.O. cameras, 2 ea, w/lenses, cable, sync gen. Make offer. Key Code 11-75.

**GE 4PE250 w/Angenieux 18-180 f2.2 CCU**, processing equip., pedestal, pawheads, good condition, minus 1 camera cable, manuals included, best offer or will trade for Sony DXC 1210 outfit plus. Key Code 11-35.

**JVC CY8800U Saticon color cameras**, set for broadcast, 10-6 blanking & 10-1 zooms Fujinon, gen lock, cables, cases, etc. (2). Key Code 11-71.

**Shibaden FPC-1000H color camera & Telemation TMC-2100 B & W camera**. Key Code 11-74.

**Sanyo portable prof. B&W slo motion high resolution camera and VCR**, very low hours, 1 hr. rechargeable battery. Trade for Ampex 5800C or 3/4 U-matic VCR. Key Code 10-1.

**Akai CV-150 with ccu AC oper.** Solid state two-tube auto white bal., or will trade for 3/4 U-matic VCR or Ampex 5800C or VHS. Key Code 10-1.

**Sony DXC 1610 w/6x1 lens**. Key Code 10-25.

**RCA TK 60 studio B/W cameras (2)**, w/zoom lenses, fixed lenses, manuals, power supplies contol units etc., perfect condition, never used. Call BEE, 800-336-3045.

**Norelco PC-70 cameras** in good condition. Complete except for lenses. Available from R&B Industries, 629 Grove St., Jersey City NJ 07302. 212-924-7910.

**Ikegami HL-33 ENG cameras** in good condition. Available from R&B Industries, 629 Grove St., Jersey City NJ 07302. 212-924-7910.

### Want To Buy

**Vidicon camera w/electronic viewfinder**. Key Code 1-5A.

**PC-72 with lens** in good working condition. Call BEE at 800-336-3045.

**RCA WP-16B power supply**, TK-60-B remote control, TK-60 zoom lenses, spare 4 1/2" I.O.'s, field tripods, pedestals, cradle heads and wedge plates, crab dolly or mini-crane. Key Code 1-7.

## CART MACHINES

### Want To Sell

**ITC RP series delay cartridge recorder**, excel cond. Key Code 1-75E.

**Spotmaster 3100 playback**, w/full cuing, in service till 11/79, gd cond. Key Code 1-43A.

**Collins 642A-2 cart machine w/216C-2 record amp**. Key Code 1-74.

**Spotmaster 3300 record-playback**, w/full cuing in service til 11/79, gd cond. Key Code 1-43B.

**Gates Criterion compact cart machines (3)**, gd cond. Key Code 1-68A.

**Tapemaster Cart recorder w/150 Hz cue**, gd cond. Key Code 1-35.

**Tapemaster 700 R.P.**, gd cond. Key Code 12-54.

**Ampro CT459B stereo record/play**, 3 cues, fast forward, splice finder, excel cond. Key Code 12-24.

**Spotmaster cart machines**, new and used. Send for literature. Best package prices on trade-in of surplus equipment. Autodyne. Box 13036, Orlando FL 32859. 305-855-6868.

**Spotmaster 5 spot** reconditioned by B.E. Key Code 12-54.

**Macarta 592 stereo record/play**, gd cond. Key Code 12-24.

**ITC RP-Delay (1)** very gd cond. Key Code 12-38.

**Macarta 512 stereo playback**, gd cond. Key Code 12-24.

**Broadcast Electronics 3000 series stereo playback** with all 3 trip tones (2), excellent condition. Key Code 11-6.

**Tapemaster A-700-RP stereo record/play**. In use. Key Code 11-18.

**Spotmaster 500D desktops**, rec/play (2), play only (2), good condition. Spotmaster cart winder. Key Code 11-53.

**Broadcast Electronics 3000 series stereo record/playback** with all 3 tones & fast forward, excellent condition. Key Code 11-6.

**RCA RT-27AS stereo rack-mount record deck**, record amp. and playback deck—in wood table-rack. In use. Key Code 11-18.

**Tapemaster A-700-P stereo playback deck**. In use. Key Code 11-18.

### Want To Buy

**Record/Play cart machine**, any model. Key Code 1-17.

**ITC Cart Machines**. Need immediately, new or slightly used, other models considered. Key Code 12-10.

**Cart machines**, any make, any condition. Key Code 12-10.

**Gates Criterion 80 mono play units (3)**, two record amps. Key Code 12-35.

**ITC triple-deck stereo cartridge playbacks (3)**. Key Code 11-6.

**Gates criterion record amp**, working. Key Code 11-46.

**Cart tape winder**, not working o.k., if repairable. Key Code 11-14.

## CASSETTE & REEL-TO-REEL RECORDERS

### Want To Sell

**Ampex 354-2 transport rebuilt to like-new w/new capstan and new 2 trk stereo head stack assembly**, w/manual. Key Code 1-73E.

**Scully 280-SP14 holds 14" reels**, record/playback. Key Code 1-53.

**Scully 270 stereo 14" playback deck (Grey)** w/25Hz tone sensor, gd cond. Key Code 1-35.

**Sony TC-250 1/4 trk stereo tape deck**, gd working cond. Key Code 1-30J.

**Ampex 351 mono (full or half trk)**, completely rehabilitated, cosmetically excel. Transport has AG 350 escutcheon, will install and align new heads and calibrate to your tape. Has interface for Inovonics Tentrol. Key Code 1-50A.

**Telex II copier**. Key Code 1-30E.

**Ampex 354-2**, 7.5-15 ips, gd. cond, stereo and mono headstacks, hard shell Ampex cases. Key Code 1-27.

**Ampex AG440-4B in console w/2-trk & 4-trk heads**, remote control, superb cond, \$3500. SoundDesign, Box 921, Beverly Hills CA 90213. 213-276-2726.

**Ampex 8 trk master recorder**, Magnacord 728, and Magnacord 1028. A. Papa, 213-768-4604 or 213-399-9069 or J. D'Anastasio, 609-424-2352 or 215-546-1808.

**Otari MX-5050B stereo tape recorders**, new, available immediately. Key Code 1-80.

**Martin Audio Varispeed III power oscillator**, electrically and cosmetically superb, has 10 turn pot for precise settings, gives variable speed capabilities to Ampex 300s, 350s, 440, w/H/S motors. Key Code 1-50.

**Scully 250**, used 1 month, excel cond. original cartons. Key Code 1-46.

**Ampex MM1100**, 16 track with fresh head stacks, remote sync, excel. Key Code 1-41B.

**Ampex 3200 duplicator**, master and 3 slaves, totally remanufactured to new cond. w/many improvements. Key Code 1-39.

**Revox A-77 (3)** one in portable frame, gd. cond. Key Code 1-35.

**Technics RS-1500, RS-1520, RS-M85, and others**. All available from Full Compass Systems, 6729 Seybold Rd, Madison WI 53719. Tel: 608-271-1100 or TWX: 910-268-2745.

**Telex II copier**. Key Code 1-30F.

**Ampex PR-10 F.T. recorder** in case, just overhauled in top order. Key Code 1-30A.

**Uher 9500 slow-speed logger**, 1/4 trk, 7 1/2-15/32 ips stereo or 4 mono chs, \$300. C. Coleman, KGAB, Box 5053, Ventura CA 93003. 805-647-0634.

**Teac A-3340S reel to reel w/4 ch. simul-sync**. Key Code 1-82.

**Scully capstan motor**, 7 1/2 & 15 ips, factory recond, w/new bearings and new capstan shaft, for 284 series. Key Code 1-73G.

**Ampex 440B, 1", 8 trk, gd. cond**. Key Code 1-41C.

**Teac TCA-42**, 4 channel, 2 avail, one w/custom sync. Key Code 1-36.

**Ampex PD-10 2 trk duplicator**, 3 slaves in cabinet. Key Code 1-30G.

**Ampex 601 F.T. recorder** in case, just overhauled in gd cond. Key Code 1-30B.

**Scully capstan motor**, 3 3/4 & 7 1/2 ips factory recond, w/new bearings and new capstan shaft for 270 & 280 series. Key Code 1-73H.

**Ampex 960 stereo** in portable case. 2T erase/record, 2T or 1/4T play, w/documentation, excel. cond., trade for Maggie PT-63. Key Code 1-31.

**Ampex 602-2**, like new. Key Code 1-9.

**Ampex 602-2, Sony 850-2, Sony 650-2**, all good operating cond. Key Code 1-7.

**Sony 850 reel to reel**, w/2 head nests, remote control, table console, very low hrs, excel cond. Key Code 1-42.

**Ampex PR-10's**, 5 complete full-track decks w/electronics in fair working cond, also 3 incomplete decks. Key Code 1-26A, B.

**3M Selectake 1 (2)**, gd. cond. Key Code 1-20A.

**PT6 junk**, nothing complete but amplifiers. Key Code 12-51.

**Uher 4000 report**, leather case, best offer. Key Code 12-19.

**Wollensak cassette duplicator (1) 2770, (2) 2780**. Key Code 12-50.



# The Exchange The Exchange The Exchange

**ASSETTE...WTS...CONTD.**

**Magnecorder Mono 1/4" tape recorder, full trk, T6-AH tape deck, PT63-J amplifier, PT6-M 400 ft. tape deck. In cases, Pilotone and angertone sync heads and outputs, excel. Key Code 12-40.**

**Ampex 351-2 recorder, was stereo changed leads to full trk, wiring and stereo electronics intact, except one bad meter, mounted in surplus cabinet for standing height with tilt remote control and long cable, w/instr. book. Key Code 12-51.**

**Ampex 351 Mono, 3.75-7.5 or 7.5-15, reconditioned, \$1095. Autodyne, Box 13036, Orlando FL 32859. 305-855-6868.**

**Stellavox SP-7 stereo w/APS75, ABR, ASV, 1 SHD heads. Key Code 12-11.**

**Sony 777S, 4 trk record/4 trk and 2 trk playback, best offer. Key Code 12-19.**

**Tascam 70-4 transport, Tascam 70-4 1/2" head assembly, all equip is new, never used, till in original carton. Key Code 12-37.**

**Teac A-3340, 4 ch, simul/sync stereo, reel to reel w/6 alum 10" reels & ten 10" reels Ampex HF tape. Key Code 12-42.**

**Roberts model 90 recorder w/like new head, v/instr. book. Key Code 12-51.**

**Tascam 25-2 half trk recorder/reproducer, 7.5/15 in RusLang console, w/DBX options v/remote. Key Code 12-58.**

**Sony TC-550 stereo cassette deck/w Dolby. Key Code 12-58.**

**Ampex 402 tape recorder, very good cond, with or w/o console, \$395 or best offer. P. Willey, WMNB, 466 Curran Highway, N Adams MA 01247. 413-663-6567.**

**Magnacord 1048, 2 channel. Key Code 12-13.**

**Crown 10 1/2" reel playback modified for 2 trk stereo, can be wired for mono record, best offer. Key Code 12-19.**

**Magnecord 1021 recorder for rack mounting, solid state, new full trk heads, burned spot on one card but repaired, otherwise excel cond, v/instr. book. Key Code 12-51.**

**Scully 280 full trk recorder/reproducer w/new Saki head stacks in consoles 7.5/15. Key Code 12-58.**

**Ampex 300-2 with tube electronics in rolling console. Key Code 12-62.**

**Ampex 354 Stereo 2T with 351 transport. Reconditioned \$1295. Autodyne, Box 13036, Orlando FL 32859. 305-855-6868.**

**Ampex 351 Console Cabinets, (2), gd cond. Key Code 12-23.**

**Ampex AG440 full trk mono, less than 100 hrs, use w/remote control. Will sell or trade for a RCA BC7, 10 ch stereo console, working cond Key Code 12-39.**

**Revox A77 remote control. Key Code 11-25.**

**Ampex AG350 8 trk, 1" recorder, reproducer w/300 deck in formica console, good condition. Key Code 11-33.**

**Ampex 350 elect., PR-10-2D deck only, 600 (no case), Berlant-Concertone 20-20. Key Code 11-47.**

**Pentagon 1100 duplicating system, cassette to cassette, (Master-6 slaves) tape motion sense, half trk 2 ch., dust covers, alignment tape, (new). Key Code 11-55.**

**Crown SX 824, stereo recorder, 3 speed, 1/4 trk, like new. Key Code 11-55.**

**Ampex 300-8, 8 trk recorder, 1" tape custom electronics w/sel sync, in console. Will swap for two 440's. Key Code 11-59.**

**Otari reel to reel full track, 2, 4, 8, 16 and 24 track and highspeed duplicators. Available from Full Compass Systems, 6729 Seybold Rd, Madison WI 53719. Tel: 608-271-1100 or TWX: 910-268-2745.**

**Otari MX-5050-B, 2 trk stereo, new w/warranty. Key Code 11-61.**

**Teac AN-300 noise reduction, AN-80 noise reduction. Both in excel. condition. Key Code 11-61.**

**Sony 756-2 two trk recorder, 15 ips, 10" reels. Key Code 11-72.**

**Head assembly erase (4-trk), record, and playback for Scully 280. Completely rebuilt, used 20 hrs. Key Code 11-26.**

**Ampex, play only, auto reverse, background music transports (2). Key Code 11-31.**

**Ampex AG-600B 2-speed, full trk mono, Ampex 351-2 w/AG-350 solid state electronics, good heads, 7 1/2-15, stereo. Schafer electronics for SL-330 logger, slave (ch. 2) unit. Ampex 445 transports—playback decks for automation. Key Code 11-53.**

**Akai GX-630D-SS, 4ch/2ch stereo tape deck, new. Key Code 11-55.**

**Ampex 300 mono, old-style electronics, unmounted. Key Code 11-59.**

**Otari MX-5050-8D, 8 trk recorder, new w/warranty. Key Code 11-61.**

**Sony 788-4, 4 ch. recorder, 15 ips, 10" reels, w/sel sync. Key Code 11-72.**

**3M 56 16 trk, 15/30 ips w/16 ch. of relay operated dbx noise reduction. Key Code 11-76.**

**TEAC (Tascam) 70 8-trk reel-to-reel audio recorder (1/2" tape). Needs minor adjustment, excel. cond. Key Code 11-23.**

**Sony TC-280 Reel to Reel. Key Code 11-25.**

**Ampex 300-1, extra electronics & meter panel for stereo, incl. new stereo head. Capstan motor has bad winding. Key Code 11-51.**

**Telex high speed cassette rewinders, 3 cassettes at a time, like new cond. (2). Key Code 11-55.**

**Ampex head assy, 4 trk 1/2 in, no wear. Key Code 11-66.**

**Sony 850 two trk recorders, takes 10" reels, 15 ips. Key Code 11-72.**

**Sony 880-2, 2 trk recorder, 14 ips, 10" reels. Key Code 11-72.**

**Scully 280-B, 7 1/2/15 ips, synchronous motor. In console. Key Code 11-76.**

**Pioneer RT-1050-2 stereo audio recorder, 2-trk, 7 1/2/15 ips. Good cond. Specs out fine. As is. Key Code 11-23.**

**Viking 88 4 channel tape recorder with sync. Key Code 11-25.**

**Otari MX7000 half track stereo recorder w/quarter track plbk. Key Code 11-41.**

**Revox A77 MK-4, new 3 3/4 - 7 1/2 ips quarter track (2). Key Code 11-61.**

**Sony 85404S recorder, four ch, 15 ips, 10" reels, w/sel sync. Key Code 11-72.**

**Ampex AG 440 full trk, unmounted. Key Code 11-72.**

**Ampex 450 14" transports (2), for parts, as is, with motors. Make offer. Key Code 11-8.**

**Grundig TK-24B stereo audio recorder, portable, 1/2-trk, 3-3/4/7 1/2 ips. Needs new belts and adjusting. Good condition. Key Code 11-23.**

**Sony TC 152 SD Stereo cassette recorder portable or deck. Key Code 11-25.**

**Curtin Infonics reel-to-reel stereo duplicator, model 74-M2. Key Code 11-59.**

**Teac 7030SL used 7 1/2-15 ips 2 trk stereo (2), excel. condition. Key Code 11-61.**

**Sony 854 recorder, 4 ch. 15 ips, 10" reels. Key Code 11-72.**

**Ampex AG 440, 2 trk recorder unmounted. Key Code 11-72.**

**Crown SC 722 recorders, 15 ips, 10" reel, unmounted, w/ferrite heads (9). Key Code 11-72.**

**Want To Buy**

**Two track stereo Rec/PB deck capable of 10 1/2 reels. Key Code 1-21.**

**Ampex 440 series transport only in superb condition. Needed without capstan motor and heads (head assembly must otherwise be complete). Key Code 1-50.**

**Reel-to-reel recorder, any model. Key Code 1-17.**

**Otari 5050 or Revox A-77. Key Code 12-59.**

**Telex reel to reel/cassette duplicators, need immediately, must be new or slightly used. Key Code 12-10.**

**Scully 280, SP-10 or 14, gd cond, in console, 7 1/2-15 ips preferred. Key Code 12-32.**

**Sony TC-766-2 open reel. Key Code 12-36.**

**Manual & Schematic for Concertone 90 or 93-2. Key Code 11-66.**

**MCI 16 track or MCI 24 track, used, with auto-locator. Key Code 11-17.**

**CATV-MATV EQUIP.**

**Want To Sell**

**Blonder-Tongue #4923 or Dynair TX-3A, modulators for Channel 8, both audio and video. \$350 each. Inderwiesen Assoc, Box 7791, Orlando FL 32804. 305-295-3034.**

**D.B.C. TS-010D ch. progressors w/VPS-20 10 watt finals, Ch. 2-8, 4-10, 6-12. Also 1 VPS-10 Ch. 7. Key Code 1-61.**

**Jerrold 704B calibrated field strength meter, 54 to 220 MHz, gd cond. Key Code 12-23.**

**Finco G-144, UHF broadband amplifier, new, never used. 45db gain, 75 ohms input and output. Key Code 1-73A.**

**MDS downconverter commercial for receiving Home Box Office, w/ant & cable, new ready to view. Key Code 10-27.**

**Andrew Waveguide, type 54346 (WC-109) 10.7-13.2 GHz, rigid circular, 190' new, with hardware. Key Code 10-18.**

**Want To Buy**

**10 watt FM translator, any input or output freq., does not have to be operable. Key Code 1-61.**

**MDS antennas & down-converters. Key Code 12-44.**

**CONSOLES**

**Want To Sell**

**Shure M67 professional mixers (2) excel cond. Key Code 1-36.**

**Tapco Mod 6000CF mixer, excel. Key Code 1-30.**

**Ampro AC 8 SB stereo 8 mixer console, excel. cond. Key Code 1-75A.**

**Automated Processes 1604, perfect cond. Key Code 1-62.**

**RCA BC-2B console. Key Code 1-53.**

**Ampro AC 8 MB mono 8 mixer console, excel. cond. Key Code 1-75B.**

**Western Electric 25B mixing console, tube type w/power supply, 7in, 2 out. Key Code 1-28B.**

**Altec 9 in, Quad (4), stereo (2), mono (1), out. 4 echo sends, 2 cue, tone, etc. All Altec, RCA preamps, line amps, power supplies. API meters (7), Altec mic transformers (20), etc. Tube type. Will trade for any 1" VTR Editor, Camera, TBC, etc. (color). Key Code 1-3.**

**FROM EUROPE!**  
TWEED AUDIO PRODUCTS  
AUDIO DESIGN & RECORDING  
SCAMP SYSTEMS



DETROIT'S  
PRO-AUDIO WAREHOUSE  
**(313) 739-7020**

**Stevenson Interface Series 100 Board, 16 input frame, 9 in, 4 out w/compression mod. A. Papa, 213-768-4604 or 213-399-9069 or J. D'Anastasio, 609-424-2352 or 215-546-1808.**

**Bogen mixer-preamplifier, 2 each with 5 mic-inputs, high & low impedance output, both in fair cond. Key Code 1-66.**

**API 1604 console, 12x4, expandable to 16x4, 10/550A, Eq, 2 comp/limiters, 8 trk monitoring. Key Code 1-41D.**

**Langevin stereo pan pots (2) S.L.P.P. -701, excel. cond. Key Code 1-36.**

**Sparta A-15 audio console. Key Code 1-34.**

**Sony MX-16 mixer, excel. cond. Key Code 1-30C.**

**Tascam model 5 mixer console. Key Code 1-82.**

**Gates Producer four pot solid state audio console, like new cond. Key Code 1-55.**

**Collins 212-B console, poor cond, needs transformer, w/instruction book. Key Code 12-51.**

**Ampex AM-10 Mixer, excel cond, \$395. Autodyne, Box 13036, Orlando FL 32859. 305-855-6868.**

**Russco 505 Studio Master 5 chan. mono, excel. cond, \$495. Autodyne, Box 13036, Orlando FL 32859. 305-855-6868.**

**Stellavox AMI-48 w/limiter, w/line outputs (2 ch) and SLE-B 2-ch. Key Code 12-11.**

**LOW LOW PRICES & BIG SAVINGS!!!**

|                                    | LIST     | CASH     |
|------------------------------------|----------|----------|
| <b>MICRO-TRAK</b>                  |          |          |
| Model 303 Tone Arm                 | \$ 99.50 | \$ 82.00 |
| Model 6401 Stereo Preamplifier     | 174.50   | 148.25   |
| <b>Technics</b>                    |          |          |
| SP-15 Turntable                    | 600.00   | 464.00   |
| SP-25 Turntable                    | 400.00   | 310.00   |
| SL-1200MK2 Turntable & Tone Arm    | 350.00   | 275.00   |
| RS-M65 Cassette Recorder           | 550.00   | 439.00   |
| RS-M85 Cassette Recorder           | 700.00   | 541.00   |
| RS-1500US Reel Recorder - Stereo   | 1,500.00 | 1,160.00 |
| RS-1506US Reel Recorder - Stereo   | 1,500.00 | 1,160.00 |
| <b>OTARI</b>                       |          |          |
| MX-5050B Reel Recorder - Stereo    | 1,945.00 | 1,749.00 |
| MX-5050BF Reel Recorder - Mono FT  | 1,995.00 | 1,799.00 |
| ARS-1000-DC Reel Reproducer - Ster | 1,365.00 | 1,231.00 |
| Mark II-2 Reel Recorder - Stereo   | 2,445.00 | 2,205.00 |

Prices are for cash with order. Shipping charges are additional. Please provide complete street address. Maryland orders must include 5% sales tax. ALL PRODUCTS ARE NEW



**Gene Bidun & Associates**  
10729 Midsummer Lane  
Columbia, Maryland 21044  
301-992-4444

Circle 141 on Action-gram

In Mexico call **Guarantee Radio**  
512-723-3331

In the U.S. call **800-336-3045**  
For any Key Code Names and Addresses.

In Canada call **United Video**  
613-741-5554

# The Exchange The Exchange The Exchange

## CONSOLES...WTS...CONTD.

RCA BC-19A console (stereo), very gd shape. Key Code 12-36.

Grommes Mixer Pre-Amp 65M, 5 hgh gain chs, 1 low gain ch, master control, treble, bass control, VU meter, etc. Key Code 12-40.

Sony MX777, stereo, four mic in/two line in all Cannon con, best offer. Key Code 12-19.

Shure M67 mike mixer. Key Code 12-33.

Gates M5133 in gd cond, paint worn in spots, met specs when last used, w/inst. book. Key Code 12-51.

Tascam Model 5A console w/ESE 4 digit timer. Key Code 12-58.

Ampex MX-35 Mixer, excel cond, \$195. Autodyne. Box 13036, Orlando FL 32859. 305-855-6868.

Spotmaster Consoles, new. Send for literature. Best package prices on trade-in surplus equipment. Autodyne, Box 13036, Orlando FL 32859. 305-855-6868.

Collins 212G-1, 10 ch audio console, gd cond, with extra modules included. Key Code 12-61.

Gates SA-40, tube type, with book and some parts, now on air, FM main control room, available Jan 1980. Key Code 12-65.

Wilkinson 7 mixer stereo board. Key Code 11-15.

Ampex MX-10 tube-type microphone mixers (2). Each unit has 4 mic and 2 line inputs plus 2 outputs. Good cond. Key Code 11-23.

Altec 1220 AC P.A. mixing board, 10 channel. Key Code 11-25.

Bogen MXM, series E-80 mixer, fair condition (1), Bogen LOM, series F-127 mixer, fair condition (1). Key Code 11-49.

Spectrasonics 1020-8/16, 14 buss, 20 input, 16-trk monitor, quad, all factory wired, mint cond. Key Code 11-57.

Cetec Series Ten stereo console, very good condition. Key Code 11-72.

Gates Studioette, as is, best offer. Key Code 11-1.

Shure M67 professional mixers (2). Key Code 11-25.

Console w/Q.R.K. turntable, 8 in 2 out, E.Q.'s, J.B.L. amps and speakers, reverb, patchbays and more. Key Code 11-65.

Tascam 10 console w/sideman extender, 16 inputs, 4 outputs in custom cabinet and digital timer. Key Code 11-72.

Langevin mixer, 8 x 1. Key Code 11-10.

Soundworkshop 1280B console, new. Key Code 11-61.

CCA console, 10 ch. stereo with 26 inputs, good condition, all solid state. Key Code 11-6.

Russco Studio-Master 505S stereo 5 channel 9 stereo inputs, like new. Key Code 11-34.

Console w/26 input with EQ-solo, 16 trk mon mix w/solo and pan, 2 cue systems, 1 mon mix echo fondue, solo in input, pre amp cards 662, 2 echo sends. Key Code 11-38.

CCA console, 6 ch. with 18 inputs, all solid state, good condition. Key Code 11-6.

Collins dual ch. console. No electronics, all meter, switches, pots, etc. Key Code 11-39.

Mixing console, 3 mic 2 phono w/EQ, ideal remote broadcast or small studio console 110 VAC, (tube type). Key Code 11-66.

### Want To Buy

RCA 76-B2 console power supply. Key Code \$12-9.

RCA BC-7A console for parts need not be in working cond. but repairable. Key Code 12-27.

Mixer, stereo console (5 channels or more), any cond. Key Code 12-56.

Collins 212J-1 remote console, will pay premium price if in gd shape. Key Code 12-36.

G.E. BC-1-A parts including pre-amp chassis complete. V.U. meter, original. Key Code 12-9.

Collins 230B console, working RCA 77D mike, Marti remote pickup equipment. Key Code 11-1.

Harris stereo 80 console, Key Code 11-15.

Western Electric or RCA tube-type console. Key Code 11-2.

Electrodyne 709 or 710 input modules. Key Code 11-33.

## DISCO & SOUND EQUIP.

### Want To Sell

Big Brute mike cables, eleven 25', Switchcraft XLR's. Key Code 1-22E.

Hammond B-3, chopped for road use. Key Code 1-2A.

Cerwin-Vega GE-2 graphic equalizers (2). Key Code 1-22F.

Rack locker, 6'. Key Code 1-22A.

A/DA Flanger, new w/power supply. Key Code 1-14A.

Voice of the Theater copies with Altec drivers, horn and crossover (800 Hz). Sonically fine, cabinets rough. Key Code 1-62A.

Rack locker 6 1/2'. Key Code 1-22B.

Maestro Phase Shifter w/3 position foot pedal. Key Code 1-14B.

Acousti-Log Digital Reverberation Timer. Key Code 1-62B.

Anvil flight cases, 20 hole mike case. Key Code 1-22C.

Echo Plex w/foot switch. Key Code 1-14C.

Shure mixers, RTS patch panels, Auratone speakers, Dynaco preamp, Dynaco amplifier, Lafayette headphone, Lafayette generator, (2) Fisher reverb chambers, (3) metal 19" racks, Altec studio monitor loudspeaker in cabinets, (2) direct boxes, (4) headset boxes, microphone snake plus cables, Harmon cassette, Garrard turntable, (2) Magnecord PT-6 w/cases. A. Papa, 213-768-4604 or 213-399-9069 or J. D'Anastasio, 609-424-2352 or 215-546-1808.

Technics by Panasonic speaker stereo systems, woofer mid-range, tweeter, gd. cond. Key Code 1-66.

Yamaha PM-400B. Key Code 1-30.

Anvil utility case. Key Code 1-22D.

Mutron Octave Divider. Key Code 1-14D.

Sansui QSE-5B 4 ch. encoder. Key Code 1-1.

Orban 111-B stereo reverb. Key Code 12-58.

DBX 3BX noise reduction system. Key Code 12-58.

Dahlquist Bi-Amp crossover Model LP-1. Key Code 12-58.

MXR Mini Limiters (4), new, MXR Auto Flanger (1), new. Key Code 12-58.

Auratone C-5 mixdown monitors (pair). Key Code 12-58.

## BEE Announces ...

# The British Connection

January '80 Listings From London

### Consoles—

- Neve 24-16-16, 6 echos with eq, 6 lim/comp, digital clock, etc.
- Neve 30-16-24
- Ameck 2000 console 20-16
- Cadac 28-24-24 L console
- Sound Techniques 28-8-24

### Recorders—

- MCI JH428 w/20 modules fitted
- MCI JH428 w/28 modules fitted
- MCI JH100 24 tr w/autolocate
- MCI JH114 16 tr w/autolocate
- Studer A80 MK 1, 16 tr, 7000 hrs
- Studer A80 MK 2, 16 tr, 2000 hrs

### Broadcast Equipment

## Exchange

PO BOX 1238, ARLINGTON, VA 22210  
800-336-3045 (in Virginia, 703-525-0400)

Whirlwind snake 8 mics/3 sends, 100' length. Key Code 12-58.

Bose 901 speaker and equalizer (1). Wood cabinet, good condition. Key Code 12-4.

Pioneer PT-222F-5 Tweeter, new (1). Key Code 12-25.

Murasound by Whitley Elect. speakers, (2), each contains a 12" & 5" speaker. Attractive deep box. Key Code 12-40.

A/B Systems LED power level meter (stereo). Key Code 12-58.

Phase Linear 1000 noise reduction system. Key Code 12-58.

LP Jacket Fabricating Plant, sacrifice. Key Code 12-22.

Headphone box/w/individual 1 pads, custom made. Key Code 12-58.

Acoustic Research AR4X speakers (2), new with warranty cards and oiled walnut cabinets. Key Code 12-65.

Ampex, Scully, 16 in, 16 out board, complete 8 trk recording studio, excel sound, all related equip. Key Code 12-22.

JBL 4313 studio monitors (pair). Key Code 12-58.

Switchcraft 96 jack TT pay with 18 cords. Key Code 12-58.

Peavey SP-1 cabinets (2). Excell cond, \$600 for both. G. Hutchins, Hutchins Sound, 34 Indiana St, Bristol VA 24201. 703-669-1737.

Baffles (custom-built), wood, fiberglass, gypsum board and acoustical tile construction, good condition. Key Code 11-23.

Braun LD 300 Speaker systems (miniature), 1 pair. Key Code 11-25.

Marantz Imperial 7's, 3 way speaker system (cab dam.), 1 pair. Key Code 11-25.

DB systems triamp crossover. 120Hz & 3500Hz. Frequencies can be changed. Key Code 11-43.

Lansing 4310 control monitor speaker systems (2). Three-way, one unit needs a new mid-range control. Good condition. Will sell as a pair only. Key Code 11-23.

Duncan 201 SA2 slide faders, 25,000 ohms, mono, like new. Also, Duncan slide fader w/cue switch and Duncan slide faders, stereo, w/cue switches. Key Code 11-23.

Altec 604E Big Red Monitors with Mastering Lab X-over, 1 pair. Key Code 11-25.

Quad electrostatics, 1 pair. Key Code 11-25.

Voice of the Theater copies with Altec drivers (new) (2). Key Code 11-25.

Custom built horn loaded sound reinforcement speaker system, using JBL woofers and tweeters, and similar midranges, mint. Key Code 11-43.

Altec 604E duplex speaker in utility cabin (2). Key Code 11-33.

Magnavox SE-2515 speaker systems (2). woofer, 3 1/2" tweeter. Used very little, n cond. Will sell only as a pair. Key Code 11-

JBL 075 ring radiator (tweeter). Key Code 11-25.

EV Interface A's with passive EQ unit, 1 pair. Key Code 11-25.

Shure M63 Audio master EQ unit. Key Code 11-25.

Showco M2500 disco mixer. Inputs f turntables, 2 tapes, mic. Has 3 ch. of grap. EQ. Key Code 11-41.

Altec Lansing 417 12" musical inst. speak. Key Code 11-25.

JBL N1200S crossover network. Key Code 11-25.

Sony SQ 1000 Quad decoder. Key Code 11-25.

JBL 4341 monitor speaker systems, 4 w/ walnut cabinets, pair. Key Code 11-76.

Koss K/6 stereo headphones, like new. Key Code 11-23.

EV S-15-3 stage PA speakers (newest model) 1 pair. Key Code 11-25.

Phase Linear 700 in rack frame with fans. Key Code 11-25.

SAE Model 8 digital tuner. Key Code 11-25.

Eventide digital delay line; perfect condition. Key Code 11-25.

Tapco 6200B, 6 in Bal inputs, like new condition (2). Key Code 11-55.

### Want To Buy

Micro-Trak arms, 12" (2 or 3), gd cond., buy & swap old mikes. Key Code 1-19.

Dolby A, 8 trk of 22 & 44 to fill M16 rack. Key Code 1-41.

Pioneer Tweeter T-309 for Project 60, speakers. Key Code 12-25.

MicMix MR-III echo chamber, used, of Supp "C", used. Key Code 11-17.

## LIGHTING EQUIP.

### Want To Sell

Mole-Richardson, Bardwell-McAllister, 2000-watt fresnel spotlights (4), 5000 watt fresnel spotlights (2), 4.0 copper cables, 300' in sections w/pin plugs, 2 large stage plug transformers, converts 220V to 110V, used w/above cable. Key Code 12-40.

FEL and FAD lamps (4 new), and others, for sale less than 50% of retail. Key Code 11-20

Lowel portable lighting kit (3), 1000w light; and accessories. Key Code 10-53.

## LIMITERS

### Want To Sell

Urie LA-4 limiter/compressors (2). Key Code 1-82.

CBS 4110 Volumax, 4 yrs old, excel cond, stereo, recently inspected. Key Code 1-65A.

Gates 6631 limiters, stereo pair. Key Code 1-24.

Collins 26U-2 FM Limiter. Key Code 1-74.

CBS 4450A Audimax, 4 yrs old, excel cond, stereo, recently inspected. Key Code 1-65B.

Gates SA-39B limiter amplifier. Key Code 1-1.

Altec 438-A Limiter (working w/spare meter). Key Code 1-30D.

Dorrough Tri-Band Compressor/Limiter w/pink noise test generator and both standard & optional high freq. enhancing limiter cards, like new. Key Code 12-61.

Kahn Symetrapeak. Key Code 12-64.

CBS 400 Volumax. Key Code 12-44.

Urie LA-4A compressor/limiters (2). Key Code 12-58.

Harris AM peak limiter, solid state. Key Code 12-64.

Altec 9473A, solid state, gd cond. Key Code 12-23.

Circle 118 on Action-gram.

In the U.S. call 800-336-3045  
For any Key Code Names and Addresses.

# 800-336-3045

New Listings are in *Italics*.

# The Exchange The Exchange The Exchange

## ITERS...WTS...CONTD.

**444 Audimax.** Key Code 12-44.  
**erson solid state AGC and limiter,** 2 yrs Key Code 12-66.  
**Sta-level.** Key Code 12-51.  
**ander, make offer.** Key Code 12-51.  
**trodyne Compressor/Limiter, Model 30,** excellent condition. Key Code 12-4.  
**BL40 modulimiter.** CBS 4500 presence Key Code 11-39.  
**axs & Volumaxs, AM & FM (older), plus** Key Code 11-8.

**LA-3A peak limiters (2).** Key Code 11-15.  
**ti CLA-40H compressor/limiters (one** (shaded pair). In use. Key Code 11-18.

**FM Volumax 4110** excellent condition. Key Code 11-69.

**imax stereo model 4450A,** also Volumax el 4110, both excellent condition. Key Code 11-13.

**0 AM limiter, mfg. specs. w/service** manual. Key Code 11-32.

**is Solid Statesman FM limiters model** 31, matched pair for stereo, very good condition, 2 yrs old. Key Code 11-70.

**i-sound brightener compressor** er/expander, stereo, excellent condition. Key Code 11-6.

**4110 w/rack mount, excellent cond** (eo), w/service manual. Key Code 11-32.

**ctra Sonics Complimiter 610,** like new. Key Code 10-28.

**Autimax III S model 445.** Good condition. Key Code 10-12.

**gg Labs tri-band limiter and AM peak** er combo #2431/2612. Like new, used 1 r, w/manual. Key Code 10-52.

### Want To Buy

**Automax, stereo.** Key Code 1-53.  
**iter (AGC), stereo or stereo pair, for FM.** Key Code 12-56.

**ronix LA-2A; Universal Audio 175, 176,** Fairchild 660, 670; Urei 1176, 1176LN; BA-6A. Key Code 11-76.

**imax stereo model 4111.** Key Code 11-15.

## MICROPHONES

### Want To Sell

**ctro Voice RE 15, RE 11, 666 (4), 664 (2),** Shotgun, mike stands, and booms. A. Papa. 3-768-4604 or 213-399-9069 or J. Anastasio, 609-424-2352 or 215-546-0.

**10 mikes (2), one 635A, all new.** Key Code 1.

**ctro-Voice CS-15 professional electric** condenser microphones including power plies (2), new. Key Code 1-73C.

**A mike boom, Model M-2-MD-U, 33"** ch on 12" stand, new. Key Code 1-54.

**AKG, Audio Technica, Beyr, Calrec,** Clear-Com, Eddor, ElectroVoice, JVC Sennheiser, Shure, Sony and Vega. All available from Full Compass Systems, 6729 Seybold Rd, Madison WI 53719. Tel: 608-271-1100 or TWX: 910-268-2745.

**mann U64 ns 1183 2/power unit and** les. Key Code 1-12.

**large boom stands on wheels (4).** Key Code 12-58.

**G 451 EB microphone w/C-1, C-5** sales. Key Code 12-58.

**lly mike boom for studio work.** Key Code 12-

**as stands (2).** Key Code 12-58.

**A lavalier w/cable, Model BK6, American** 330, no cable. Key Code 12-40.

**ny ECM 33F condenser mics (2), like new.** Key Code 12-45.

**A 10001A's (KU3A), RCA 44B, PML** (arl), Key Code 12-4.

**AKG stand.** Key Code 12-58.

**Sennheiser MD-421 U microphones (3).** Key Code 12-58.

**649B's (2), in excel. cond.** Key Code 12-13.

**Electro Voice 655, new cond.** Key Code 12-19.

**Sony ECM-22 condenser microphone, works** well, good cond. Key Code 11-23.

**Atlas banquet stand with 13" gooseneck and** 721D base, new. Key Code 11-23.

**Shure 545 microphone, less holder, like new.** Key Code 11-23.

**Neumann U-47 FET microphone w/power** supply. Like new. Key Code 11-41.

**MIKES FROM STOCK!**  
 AKG/EV/SONY/SHURE/SENNHEISER

**Sound Solutions**

DETROIT'S  
**PRO-AUDIO WAREHOUSE**  
**(313) 739-7020**

**Electro Voice 666 dynamic microphone.** An oldie, but a goodie. Works fine. Key Code 11-23.

**EV RE-11 mikes (4), EV RE-16, Altec 650 (2),** and Shure 565 (3). Key Code 11-25.

**Neumann, AKG, Telefunken tube** microphones. Various others. Key Code 11-76.

**Atlas microphone stand with 721D base.** Includes an Atlas BB-1 baby boom. Good cond. Key Code 11-23.

**EV-RE-10 microphone, excel. cond., EV-RE-** 50 (Lavalier) excel. cond., Shure 548SD microphones (2), matched-pair, excel. cond. Key Code 11-55.

**Atlas microphone stand (large) w/669 base** and BB-1 baby boom. Key Code 11-23.

**Neumann power supply for Neumann U49** mike. Key Code 11-25.

**Mike boom assorted pieces.** Key Code 10-45.

**Nuvistor U-47, w/PS & cables, no box for** mix. Best offer. Key Code 10-34.

**EV RE-15, EV RE-11, EV-666(4), EV-664(2),** EV Shotgun, RCA DX77, plus Atlas large booms and stands. Key Code 10-39.

**RCA 77DX, excellent operating condition.** Key Code 10-10.

**Gates mike G3000.** Key Code 10-45.

**Altec 670-B ribbon mike, worked when** removed from service. Key Code 10-32.

**Neumann U-64 w/all components.** Key Code 10-34.

**EV Shotgun mike model #C42 with wind** screen. Key Code 10-56.

**Neumann U47 FET microphone.** Key Code 10-6.

**Shure Unidyne 556.** Good condition. Key Code 10-10.

**Electro-Voice 666 dynamic microphone, no** mounting clip or long cable. Or will swap for Shure M66 equalizer. Key Code 10-43.

**Sennheiser model #EM1008 wireless mikes** (2), sell as pair or separate. Key Code 10-56.

### Want To Buy

**Mounting yoke (fork) and stand cushion for** RCA BK-5B. Key Code 1-31.

**Broadcast quality microphones, any model,** Key Code 1-17.

**Wireless microphone at good price.** Key Code 1-35.

**RCA 77D and DX microphones, working or** not also want parts for same. Key Code 12-9.

**Neumann U-87 windscreens & shock mounts** (2). AKG C414EB windscreens (2). Key Code 11-17.

**Sony ECM-21, C-55, C-55P, ECM-56, ECM-** 33, C-22, ECM-22 microphones. Key Code 11-61

**Telefunken U47, U48, M251.** Key Code 11-76.

**RCA 44 series A thru BX and RCA 77.** Western Electric 639. Key Code 11-2.

**Early microphones & stands.** Key Code 11-67.

**Neumann M-49, U-47, U-67, SM-2, Sony C-** 37A, Telefunken ELAM-751, other tube condenser mics. Key Code 10-50.

## MISCELLANEOUS

### Want To Sell

**7' open racks.** Key Code 1-76.

**FCC Radio operator licensing curriculum** complete test questions and answers for FCC exams element #3, 2nd class license and element #4, 1st class license. Will sell to any school training facility. Key Code 1-47.

**Vacuum capacitors (variable) 7500** volts/8008 mercury vapor rectifiers. Key Code 1-76.

**Cooke Master clock system, including 2** impulse studio clocks, 2 each 8-event programmable timers and stand-by battery. Key Code 1-43D.

**Fairchild sold state power supplies (5),** 667T24-1 (3), dual output, plus or minus 15-24 V, 667AA(1) and 667II(1). Key Code 1-75D.

**Control Data Corp. Model LGP-30 stored** program computer, medium-scale capability, single address, 4096 word magnetic drum memory, w/punched paper tape permanent file, access less than 15 Ms, consists of memory unit, arithmetic unit and control unit. Sell or exchange for studio equipment. Key Code 1-63.

**Rack cabinets, 19", one 28" h, one 10 1/2" h,** one 66" h, and one 78" h, all in gd cond. Key Code 12-51.

**BSR Metrotech, cassette type tel answering** machine, bell jacks, includes specs & warranty, best offer. Key Code 12-19.

**Patch Bays (2), standard 19" width.** Key Code 12-33.

**Switchcraft phono patch bay, 48 jack.** Key Code 12-58.

**Equipment rack, 19 1/2" custom made,** wood/w/power, various assorted cables, various lengths. Key Code 12-58.

**Thordarson C.H.T and Tru-fidelity trans** T15S90, T15C54, 20A26, 20A27, T2A36, 3S21, 3S22, 22S95, etc. Key Code 11-47.

**Bud enclosed 36", 19" rack cabinet** w/wheels, black wrinkle finish. Fair condition. Key Code 11-23.

**Magniphase line protection system.** New in original carton. Key Code 11-28.

**UTC noise suppressor inductor CG & LS** series also CGE-1 and CGE-1A, LS-19. Key Code 11-47.

**Power supply-6VDC, -7VDC, 6VAC,** Amphenol connector, schematic. Key Code 11-17.

**Bud open 36", 19" rack w/heavy-duty** casters, gray finish, very good cond. Key Code 11-23.

**Toyo push button switch assemblies,** Japanese, well made w/total of 10 DPST contacts per assembly. Each has 10 square buttons, black (non-illuminated), numbered 0-9. New condition. Key Code 11-23.

**Shure M-67 Series 19" rack mounts.** Key Code 11-25.

**150 Amp 220/440V Asco transfer switch.** Key Code 11-48.

**Jack panels (24 prs) single row, double row,** Weston 506-2 1/2" VU meters, UTC A20 mix trans. Key Code 11-47.

### Want To Buy

**Rack mounted metal cartridge racks, hold 40** carts each. Key Code 1-69.

**Patch cords, double plug, not over 3 feet long.** Any condition as long as repairable. Key Code 12-9.

**API Model 561 'B' scale VU meter (2).** Key Code 12-27

**RCA and Western Electric catalogues of** tube-type equipment Key Code 11-2.

**Rotary Attenuators, stereo, 600 in/out, 20** step, 2DB/step w/cue, need 10. Key Code 12-27.

## MONITORS

### Want To Sell

**GE BM-1A mono FM frequency & modulation** monitor w/manual on 95.9 MHz, \$100. C. Coleman, KGAB, Box 5053, Ventura CA 93003, 805-647-0634.

**Nems Clarke Model 112 phase monitor, set** unit for three towers, gd. cond. Key Code 1-23.

**General Radio Model 1931A amplitude** modulation monitor. Key Code 1-1.

**McMartin TBM3000 and 3500 frequency &** modulation monitors in gd cond. Key Code 1-53.

**Metron Model 510 AM frequency monitor.** Key Code 1-1.

**Gates M-5693 AM modulation monitor.** Looks new but doesn't work. Key Code 1-75C.

**Gates model M-5693 modulation monitor at** gd price. Key Code 1-59.

**Hewlett-Packard 335B freq. mod. monitor on** 94.3 MHz, now in service, but needs work, with book. Key Code 12-65.

**McMartin TBM-3000 FM frequency monitor.** Key Code 12-66.

**Hewlett-Packard 335B FM monitor gd cond** w/book. Key Code 12-51.

**Rust 108 (2) complete w/book.** Key Code 12-51.

**Belar BW-75A FM modulation/frequency** monitor, new cond. Key Code 12-15.

**McMartin TBM-3500 FM modulation** monitor. Key Code 12-66.

**Gates M-5693 modulation monitor, needs** work, make offer. Key Code 12-44.

**General Radio Frequency Monitor on 1430** KHz, Model 1181-A. Key Code 12-46.

**McMartin TBM-3000 broadcast frequency** monitor. Key Code 11-31.

**Rust Corp. SFM-19 deviation monitor.** Key Code 11-31.

**General Radio 1931-A modulation monitors** (2), fair, RCA type BW-66E (1) modulation monitor, good condition. Key Code 11-49.

**Collins SCA monitor, solid state, needs work.** Make offer. Key Code 11-8.

**RCA/Belar BW-95A SCA monitor, good** condition. Key Code 11-27.

**McMartin TBM-4000 SCA, McMartin TBM-** 2000A SCA. Key Code 11-31.

**McMartin TBM3500 mono fm modulation** monitor-tuned 101.9MHz. Key Code 11-39.

**General Electric BM-3-A frequency &** modulation monitor for 1340 kc. Calibrated to 120% modulation. Excellent condition. Key Code 11-67.

### Want To Buy

**Type approved modulation monitor for 89.3** MHz. Key Code 1-58.

**FM modulation and frequency monitors,** prefer 98.3 MHz. Key Code 1-25.

**McMartin TBM2000A or B SCA monitors.** Key Code 1-11.

**GR Model 1931-A monitor in gd cond or** easily repairable. Key Code 12-30.

**Monitor (modulation), stereo FM, tuneable to** 106.3 MHz, any cond. Key Code 12-56.

**McMartin TBM-4500A stereo modulation** monitor. Key Code 12-16.

**Belar stereo monitor.** Key Code 11-15.

## MOVIE PRODUCTION EQUIP.

### Want To Sell

**Magnatech series 200 dubber equip., 4** Turner 4L406 interlock motors, 4 Bodine NCH34 sync motors-chassis mounted and wired, 4 35mm sprockets, misc. hardware, 4 complete control panels. Key Code 1-56.

**Magna Tech Model 31 compressors.** Key Code 12-4

# The Exchange The Exchange The Exchange

## MOVIE PROD...WTS...CONTD.

Moviola editing machine, blue mag and opt, excel cond, zoom door and Auricon finder. Key Code 12-41.

Bell & Howell Model 545, 16mm soundproj., like new w/cover & spare lamp. Key Code 12-21.

Auricon Pro 1200 camera, 2 mags wired for mag sound, cables, cases, all in mint cond, new mag head, M11 amp, also opt amp, hardly used. Key Code 12-41.

Bell & Howell 200EE 16mm movie camera w/case, inoperative electric eye, fair-to-poor cond, good for parts, sold as is, case is fairly good. Key Code 12-63.

Arri-M & Beaulieu 16mm cameras, zoom lenses, tripods, Spectra meter, sound readers, Nagra-3 playback, lights, other prod equip. Key Code 12-40.

Auricon Pro 600 movie camera, 2 mags, opt amp, 1 lens, cases, mikes, cables, like new cond. Key Code 12-41.

Dolly, Houston Fearless metal-portable. Key Code 12-41.

Nagra to Ariflex-S, 50 foot sync cable. Key Code 11-20.

### Want To Buy

Neumade, HFC, or Moviola 16mm film timer-footage counter combo w/large single hub, left-to-right, teeth in back, in gd cond. Key Code 12-63.

Neumade-Griswold model R-3, 16mm film splicer with 1/16" splice-bar, in gd cond, well-used OK, should be complete. Key Code 12-63.

## RECEIVERS & TRANSCEIVERS

### Want To Sell

Motorola Mocom 70 System, one 45 W. VHF base station w/PL, and four 30 W. VHF mobile units, w/PL. In use less than 2 yrs., absolutely mint operating condition. \$3750. T. Bleiman, Spectronics Inc, 1009 Garfield St, Oak Park IL 60304. 312-848-6777.

Johnson repeater w/four Comco bases on 461.975 rec and 466.975 xmt, gd. cond. Key Code 1-70.

Henry Radio "Tempo-5/FMH" 5 watt handheld transceivers, w/161.730 and 161.760 xtls (6 ch capacity w/drop in NiCad chargers). Key Code 1-43C.

McMartin TR66C SCA receivers. Key Code 1-11.

Motorola HT-220 Slimline-VHF, charger, case, perfect operating cond. Key Code 12-28.

Marti VHF remote pickup receiver tube type 160 MHz dual frequency. Key Code 12-66.

VHF-FM Radiotelephone's 161.07 MHz including Comco base station, Aeroton base mobile, and a variety of G.E. mobiles, all sold separately or as package. Key Code 12-66.

Motorola HT-220 Omni-Housing, 6-ch VHF, w/accessories, mint cond. Key Code 12-28.

Symmetrics RCC mobile telephone, full duplex, w/manuals, excel cond, interrupted tone signalling. Key Code 12-47.

Motorola PA8266 FM receiver chassis complete w/100V supply, mini box w/volume squelch plugged in on 39.1 MHz for police monitor. Key Code 12-51.

Motorola, 5 watt Mocom 10 D31AAN, 25-30 MHz transistorized, type approved FM transceiver. Key Code 12-57.

McMartin SCA receiver solid state. Key Code 12-66.

SCA crystals, (100), 100.7 MHz. Crystal frequency 45.0. Key Code 11-4.

McMartin Multiplex receivers TR66, (3). McMartin TR-66B mtlx. Key Code 11-31.

Johnson multiplex receiver. Key Code 11-31.

Motorola HT-220, 2-freq. VHF slimline w/TT pad mounted, w/case & charger. Key Code 11-37.

### Want To Buy

Motorola Hi-Band HT-200 portable, old 960 or higher equipment. Key Code 12-57.

## REMOTE & MICROWAVE EQUIP.

### Want To Sell

Continental Elects. transmitter (2) remote control unit, will operate two xmtr's each, gd cond. Key Code 1-8.

Moseley RRC-10, remote control units for use w/26KHz STL System, needs tubes, \$450. C. Coleman, KGAB, Box 5053, Ventura CA 93003. 805-647-0634.

Moseley PCL-303 STL transmitter/receiver with remote control tuned to 950 MHz. Key Code 1-76.

Rust Model 108-D remote control system, 24 ch, worked when removed. Key Code 1-54.

McMartin TBM-3000 FM frequency monitor. Key Code 1-74.

Gates Model RDC-10 w/manual. Key Code 1-29.

Schafer 400R transmitter remote control unit, gd cond, w/manuals. Key Code 1-8.

Narda N62055-6 GaAs FET amplifier, 8 to 12 GHz, gain: 25dB, NF: 7.5dB, power output: #10dBm, 15VDC. Key Code 12-14.

Moseley TRC15A (1), updated to IC sockets. Key Code 12-18.

RCA Microwave receivers (3), TVR-1A, RCA Microwave transmitters (3), TVT-1A, gd working order when removed, complete w/spare tubes and spare units, modifications to 1B and 1C series, one transmitter has a practically new head, best offer. Key Code 12-31.

Moseley SCG-8 & SCD-8 subcarrier generator & demodulator for STL use. New not used. Key Code 10-16.

### Want To Buy

Moseley STL PCL 505 or comparable unit. Key Code 1-72.

Remote transmitter 30 or 40 watts for 450 MHz frequency range. Key Code 1-77.

Marti remotes for 450 and 160 MHz bands. Key Code 1-70.

STL, 950 band tuned to 948 MHz, gd. working cond. Key Code 1-70.

STL 950MHz and remote control for FM station, complete w/antennas and SCA, mono or stereo. Key Code 12-65.

Remote Control, for FM, studio & transmitters units like "Rust" units. Key Code 12-56.

S.T.L. composite. Moseley PCL-505 preferred. Key Code 12-3.

2GHz microwave RCVR & TX (MA-2A series or other). Key Code 11-50.

## STEREO GENERATORS

### Want To Sell

Gates FM 250WC stereo generator and exciter all working fine. Key Code 1-45.

Gates Model 994-6533-001 Solid State mint cond., \$300. D. Castellano, Capitol Broadcast Exchange, 3469 W Benjamin Holt Dr, Stockton CA 95207. 209-957-1761.

RCA BTS-1A stereo generator w/manual, \$300. C. Coleman, KGAB, Box 5053, Ventura CA 93003, 805-647-0634.

Standard Electronics Model 935, tube type, \$200. D. Castellano, Capitol Broadcast Exchange, 3469 W Benjamin Holt Dr, Stockton CA 95207. 209-957-1761.

Pilot counter. Key Code 11-15.

RCA BTX-1B SCA generator for BTE-15A exciter. Key Code 11-27.

Wilkinson stereo generator. Key Code 11-15.

Gates M6533 stereo generator for TE-3 exciter. Key Code 10-17.

### Want To Buy

McMartin B103 SCA generator. Key Code 1-11.

Stereo Generator for Gates M-6095 exciter, any cond, or for REL 518A-DL transmitter. Key Code 12-56.

## SWITCHERS (VIDEO)

### Want To Sell

Shintron 367 Color edit code switcher w/NTSC color genlock, sync generator and effects, like new, low hrs. Key Code 1-44.

Telemet Model 7945 air/production switchers (2), vertical interval wipe effects, audio follow, no rack space needed, \$4600 each. D. Castellano, Capitol Broadcast Exchange, 3469 W Benjamin Holt Dr, Stockton CA 95207. 209-957-1761.

Dynair 5100 series 40X10 remote control, \$2400, Dynair model 15X10C(2), \$1350 each, all fully tested. D. Castellano, Capitol Broadcast Exchange, 3469 W Benjamin Holt Dr, Stockton CA 95207. 209-957-1761.

Dynair VS-153A prod. video switcher, color capable, remote controlled, 6 sync and 5 non-sync inputs, w/manual. Key Code 12-23.

Panasonic WJ-5500, internal color bars, sync gen, genlock, 1 yr warranty. Key Code 12-34.

Telemation, 5 units, TPS 8x2 video switcher, TPS 12x3 video switcher, TSE-100 screen splitter, pre select video switcher TVS 6x2 SE, Bdct CCU TMV-708. Key Code 12-21.

### Want To Buy

RGB Chroma Key or good in line, used. Key Code 10-1.

## TAPES CARTS & REELS

### Want To Sell

Tape, 3/4" name brands, 60's, 30's, vinyls. Key Code 1-67B, C, D.

Scotch Tape Stock 1" for IVC machines. Key Code 1-10.

Videocassettes, 3/4", 30 minute lengths, like new. Key Code 1-10B.

U-matic videocassettes, 3/4", 60 minutes used. Key Code 1-10C.

Audio Tape, remaining stock of 3M, type 150, individually boxed 565 foot reels, 12 per sealed case, \$3.00 per case. Digitrak Communications Inc, 409 Fourth St SW, Hickory NC 28601. 704-322-1367.

Scotch Tape Stock, 1" for Ampex machines. Key Code 1-10.

Fidelipac Model 300 loaded cartridges, used but in gd cond. 560 available. Key Code 1-80.

Blank Cassettes (new) Audio-Magnetics standard quality duplicating tape, white sonic shells, 40 min. length, in factory-sealed cartons. Key Code 1-37A.

Reels & boxes, 5 & 7", several hundred, new, white. Key Code 12-58.

U-matic 3/4" cassettes, all brands, used, 60's, 30's, low usage. Key Code 12-29.

3M videocassettes, 60 min, like new, in plastic shipping cases, some with movies (24). Key Code 12-45.

Scotch 250/206/176/177, 2500 HPB, several cases. Key Code 12-58.

Fidelipac Carts, new, send for literature. Autodyne, Box 13036, Orlando FL 32859. 305-855-6868.

Tape reels, many 5 & 7 inch, empty, without boxes, 10c each, you pay shipping. G. Hutchins, Hutchins Sound, 34 Indiana St, Bristol VA 24201. 703-669-1737.

Broadcast carts, several Audiopak & Fidelipac, recently removed from service, good cond, 50c each. G. Hutchins, Hutchins Sound, 34 Indiana St, Bristol VA 24201. 703-669-1737.

Music library, approx. 95 reels 10-1/2", 7-1/2ips, 1/2trk stereo with 25Hz tones w/music sheets. Key Code 11-51.

NAB 10-1/2" metal take-up reels, 1/2", rebuilt, good condition. (2). Key Code 11-23.

Maxell UD-50-10 1/2" recording tape on 10-1/2" NAB metal reels, (6). Used. Splice free. Key Code 11-23.

Fidelipac 5-min NAB Carts, approx. 50 available, new in box also some longer. Key Code 10-1.

Sony U-matic, 60 min., used few passes, 1 available. Key Code 10-1.

### Want To Buy

Cartridges in working order, any brand. Key Code 1-17.

Music tapes for Automation, must be in working cond. Key Code 1-59.

Fidelipac Carts, used, all sizes, loaded empty, don't have to be clean, just salvagab. Key Code 12-9.

Reels 14" (metal) new or used, full or empty for 1/4" tape. Key Code 11-40.

## TEST EQUIPMENT

### Want To Sell

HP654A Audio Generator, gd. cond. Key Code 1-18A.

HP400H AC meter, recent calibration. Key Code 1-9C.

Xedit 15P flutter meter, .05% range, excel cond., used about 6 hrs. Key Code 1-18B.

Tektronix scope type 531A w/CA plug in, ne CRT excel. cond. Key Code 1-15A.

Ballantine 302C portable AC meter. Key Code 1-9D.

Model 128 Exact analog linear sweep generator w/function generator. Key Code 1-2B.

Tektronix oscilloscope, type 524D, has built in time markers, includes 4 wheel Scope Mobile. Key Code 1-40A.

HP-608D sig. gen, Wayne Kerr VH admittance bridge type 801. Key Code 1-15

Delta OIB-3 Impedance Bridge & RG1 receiver generator. Key Code 1-11.

Wavetek Model 3001-03, 1-520MHz, fresh factory calibration w/spare output module. Key Code 1-61.

Tektronix oscilloscope, type 543, include plug-in Type CA dual trace, calibrated preamp, plug-in Type L fast-rise, high gain, calibrate pre-amp, w/Scope-Mobile. Key Code 1-4C

Heathkit TS-4A TV alignment gen, working. Key Code 1-30H.

Sorensen QSB-6-15 laboratory regulate power supply, 5 to 9 volts at 15 amps, like new. Key Code 1-73D.

Sencore FC 45, 230MHz freq. counter, like new, manual, etc. Key Code 1-61.

Heathkit O-10 Scope, working. Key Code 1-30I.

GR1602B admittance meter. Key Code 1-9E.

Hewlett-Packard 335B, modulation and frequency meter. Key Code 12-66.

Hewlett-Packard 608D signal gen., excel cond. Key Code 12-48.

Hickok CRO-5000, Solid State oscilloscope gd cond. Key Code 12-23.

Measurements 65B, URM-25, eldorad counter. Key Code 12-7.

Audio oscillator Wave Forms 401B. Key Code 12-66.

Singer FM-9 Hi-Band 450 service monitor needs new 1MHz standard. Key Code 12-57

Heathkit AG-9A audio generator. Key Code 12-66.

Tektronix type 531A scope w/CA dual trace plug-in, new CRT. Key Code 12-48

HP 330D distortion analyzer. Key Code 11-48

Hewlett Packard 3200B RF oscillator. Jerrold 727 FSM field strength meter, (3) Jerrold AY 75F attenuators. Key Code 11-58.

Boonton 91C voltmeter. Key Code 11-48.

Tektronix storage oscilloscope R7613 w/7L12 plug-in spectrum analyzer. Key Code 11-58.

Singer MD-105-T1 antenna. Key Code 11-58.

Tektronix 585A scope with 82 dual plug-in. Good condition. Key Code 11-62.

HP302A wave analyzer, HP200D audio osc., HP330B dist. analyzer, HP206A audio gen. Key Code 11-47.

# The Exchange The Exchange The Exchange

## ST EQUIP...WTS...CONTD.

200CD oscillator, excel. cond. Key Code -48.

tektronix 162 waveform generator, fair condition (1), Tektronix type '81' adapter unit, condition (1). Key Code 11-49.

tektronix 1430 random noise measure set, tektronix R529 waveform monitor, Tektronix 20A vector scope. Key Code 11-58.

tescan 9500R & 9500T, Dynair RX-4B-C na-tune demodulator, Dynair VT-4B-1 variable tuner. Key Code 11-58.

tektronix 546 scope with 1A1 plug-in. Good condition. Key Code 11-62.

even 6C measur. set. Key Code 11-47.

tektronix 105 square wave generator, 20Hz 1MHz, 14NS rise time. Key Code 11-48.

tektronix plug-in units, all good condition, ie "Q", "W", "82". Key Code 11-49.

tektronix R149 NTSC signal generator, tektronix C-5 oscilloscope camera, Tektronix 01 TDR recorder. Key Code 11-58.

.E. CTM1-2 modulator and all converter modules (plug-ins) channels 2 to 13. Key Code -58.

tektronix 535A scope with dual trace plug in. Key Code 11-62.

P. 400C audio volt meter, H.P. 206A signal generator. Key Code 11-39.

P. 330B distortion analyzer (recent calibration). Key Code 11-48.

awlett Packard 5300A freq. counter, inframe w/5303B freq. counter plug-in, option 1 crystal oscillator. Key Code 11-58.

### Want To Buy

old Intensity meter for AM band, 540 to 1000kHz, must be in gd cond. Key Code 1-52.

ath or other intermodulation analyzer. Key Code 12-57.

sta Measurements Corp manual, type 8155 meter (circa 1969), will pay for xerox of mailing. Key Code 12-48.

neral Radio or equivalent RF bridge for antenna measurements. Key Code 11-8.

## TRANSMITTERS

### Want To Sell

ites MM-5394 10 watt FM exciter, spare metal ovens, tuned to your frequency, \$550. Castellano, Capitol Broadcast Exchange, 69 W Benjamin Holt Dr, Stockton CA 207. 209-957-1761.

ate transformer for Gates BC-1H needs winding. Key Code 1-55.

TT42A3 TV transmitter, tubes, spares, at exchangers, water pumps, power supplies, excel cond, Ch. 5, Key Code 1-38.

renaire Solid State contactless Xtal oven for A TTU UHF tube type B and B1 exciters. Plug replacement, eliminates on-air flash. Key Code 1-13A.

illins Model 20V 1000 watt AM transmitter w/ tuned to 1460 KHz. Key Code 1-1.

T.C. UST-105 100W UHF translator, Ch. 13 out, Ch. 69 output. 1973 w/tube type multiplier, driver & final. Key Code 1-61.

aytheon RA-1000 AM 1 kw transmitter in excel cond. Key Code 1-59.

Asco 15A transfer switch. Key Code 1-9.

RCA TV Model TTU-10 w/filterplexer, Ch 14, H.P. Freq. Monitor, BW-4 demod, dummy load, fair to poor cond. Key Code 1-57.

RCA BTX-1A, 67KHz sub-carrier generator w/manual, \$300. C. Coleman, KGAB, Box 5053, Ventura CA 93003, 805-647-0634.

Collins 732-A 1kw FM (2), re-built, perfect for standby. D. Castellano, Capitol Broadcast Exchange, 3469 W Benjamin Holt Dr, Stockton CA 95207. 209-957-1761.

Collins 300G AM Transmitter. Presently tuned to 1450 KHz, good condition, ready to go on air. Key Code 12-2.

Power Transformer, high voltage, for Gates BC-1G has taps for 1000 or 250 watts. Key Code 12-46.

Raytheon RA-1000 AM transmitter 1KW w/complete manual, in excellent condition. Key Code 12-5.

RCA type BTA 1kw with 500 w cutback., can be put in working cond w/minimal effort, complete w/parts, up haul, make offer. Key Code 12-20.

Bauer 707, 1KW, on air, 1600KHz. Key Code 12-17.

Collins 310Z1 FM exciter in good condition w/spare modulator card. Stereo generator, needs work. Key Code 11-8.

ITA/Wilkinson exciter, 10 watt, less pwr supply, working when removed. Key Code 11-51.

Collins 20H 1 kw., AM transmitter. Excellent, rebuilt w/solid state power supplies, vacuum tank capacitor, new audio circuitry, new modulation transformer & reactor. Easily handles 125% pos. peak. Will tune to your frequency. Now on air. Key Code 11-67.

Gates BC-1E. 1KW AM transmitter, great standby, spare tubes included. Key Code 11-13.

Crystals for RCA BTA-1R series (2), 1300 kHz. Key Code 11-28.

100KW motor generator, ultimate in line isolation. Key Code 11-48.

Raytheon 250-A 250 watt AM transmitter. Top condition. Solid state power, redesigned audio. 125% positive peak modulation. Will tune to your frequency, now operating. Key Code 11-67.

LPB TX2-20 carrier current transmitter w/interface unit on 535 kHz, will accept any AM band crystal, 600 ohm input. Never used. Key Code 11-24.

Gates BC-1F, good condition, presently tuned to 1330kHz, incl. 500w cutback, extra clean. Key Code 11-51.

### Want To Buy

250W FM transmitter (1965 or later), mono or stereo, for remote control, prefer tube type PA, solid state exciter. Key Code 1-60.

Type approved power Amp for 10 watt exciter, 250, 500 watts. Key Code 1-58.

McMartin B103 SCA generator. Key Code 1-11.

Need 3KW in "on air" condition. Key Code 1-25.

5KW AM Transmitter, less than 10 yrs old. Key Code 1-51.

FM transmitter 1KW without exciter, have exciter & stereo generator already on hand, want gd cond and operating. Key Code 12-26.

FM Transmitter, 1 to 3 KW, junk, no exciter. Key Code 12-7.

FM Exciter, mono or stereo, must be direct FM. Key Code 12-65.

FM transmitter, 100, 250 watt. Key Code 12-50.

100 watt FM transmitter. Key Code 11-60.

AM, standard broadcast, carrier current transmitter for outdoor, amusement-park type, limited radiation purposes. Key Code 11-9.

2KW or less FM transmitter with or without exciter. Key Code 11-54.

Wanting 250, 500, 1,000 and 5,000 watt AM FM transmitters. Guarantee Radio Supply Corp., 1314 Iturbide Street, Laredo, TX 78040. Richard Reyes, 512-723-3331.

## TUBES

### Want To Sell

Eimac 4-400C, new (4). Key Code 1-78.

Tektronix #154-0562-00 replacement CRT for model 602 display scope. New, in factory carton. Key Code 1-73B.

Eimac 4CX3000A, new (2). Key Code 12-7.

Sony trinitron color picture tube 470DLB22. Never used \$90. Dan Mulally, KUMV-TV, Box 1287, Williston, ND 58801, 701-875-4311.

Tektronix scope tubes #154-0517-05 6x10 CM graticule, 51LEP1 5" round. Both new. Key Code 11-11.

25, 30 mil, and 2/3" plumbicon tubes, used in good condition, fair price. Call United Video at 613-741-5554.

### Want To Buy

892R vacuum tube in gd cond. Key Code 1-76.

G.E. or Sylvania 6P7. Key Code 1-35.

Telefunken VF-14 for U47-U48 microphones. Telefunken AC-701. Key Code 11-76.

Planar Triode (6299) W-J backward wave osc, 2-4GHz, #1951-0030. Key Code 11-11.

## TURNTABLES & LATHES

### Want To Sell

Micro-Trak Model 303 12" tone arms (8), brand new. Key Code 1-80.

Russco tables (2) with new idlers and felts plus (2) rebuilt Empire 980 arms. Key Code 1-71A.

Sparta 12" turntables (2) in gd. cond. Key Code 1-58A.

Shure SM-64 phono preamps (2). Key Code 12-58.

Collins turntables 12" (3), 2 w/Gray arms, 1 w/viscous arm. Key Code 12-51.

QRK Studio Pro turntable w/o arm. Key Code 12-58.

QRK solid state pre-amp's (2). Key Code 12-66.

Russco Studio Pro turntable w/o arm. Key Code 12-58.

Gates 12" T.T. with tone arm and built-in pre-amp's. Key Code 12-66.

Russco & QRK used turntables and accessories, reconditioned. Autodyne, Box 13036, Orlando FL 32859. 305-855-6868.

EMT-930ST turntables and arms (2 ea), with new Stanton 500AL carts, less preamps, excel. cond. \$790 pair. Cabinets & preamps avail. Autodyne, Box 13036, Orlando FL 32859. 305-855-6868.

Gates 12" TT/Gray Micro-Trak arm (1), Gates 16" TT/Gray Micro-Trak arm (1). Key Code 12-44.

Gates/Harris Transcription turntables, CB-77 (2), completely rebuilt, painted, new rollerwheels, excel cond Key Code 12-36.

Technics SL-20 turntable w/cartridge, used very little, w/dust cover, excel cond. Key Code 11-23.

Rek-O-Kut Rondine turntable w/Gray 216 arm. Key Code 12-40.

Technics Direct Drive SP-10, SP-15, SP-25 and SL-1200 Mk II. In stock and available from Full Compass Systems, 6729 Seybold Rd, Madison WI 53719. Tel: 608-271-1100 or TWX: 910-268-2745.

Fons Int'l Mk 1, Hadrock arm, Ortofon MC-70 cartridge w/pre-preamp (separate if desired), Stanton 8815 cartridge, 25 hrs. Key Code 11-43.

### Want To Buy

RCA MI-11883, 45RPM conversion kit for 70C/D turntable, complete, gd. cond. Key Code 1-31.

RCA MI-11874 pickup for MI-11885 light weight tone arm. Key Code 1-31.

Turntables, prefer two units, any model. Key Code 1-17.

Gates M-6442 phono-preamps (2) or more, in original shape, or close as original. Key Code 12-36.

Rek-O-Kut L-34, 2 speed turntables in gd cond (2). Key Code 12-46.

Turntables CB-77 that can be rebuilt to original factory specs, will make reasonable offer, w/o w/o tone arms. Key Code 12-36.

12" turntables, 2 or more, with or without arms, cartridges like QRK, Sparta, etc. Key Code 12-56.

QRK 16-inch, 3 speed TT w/sync motor, in gd cond, would prefer table w/flush top platter, not dish style, need one only. Key Code 12-63.

Gray viscous damped tone arms, 12" (2). Key Code 12-9.

## TV FILM EQUIPMENT

### Want To Sell

Athena 400 16mm telecine projector w/lens, factory refurbished, \$3500. SounDesign, Box 921, Beverly Hills CA 90213. 213-276-2726.

Kodak TVM100A Super-8mm projector w/lens, like new, 10 hrs used, remote controllable, \$1750. SounDesign, Box 921, Beverly Hills CA 90213. 213-276-2726.

Film Chains including B&H 614, Telemation TMM 203, 203B and RCM 22 and others. Shibaden FPC-1000, Gates TE-201 cameras. Viscount 1140 switcher plus Sparta A-20b & EP-20B. Call or write for more info. G. Busby, Oceanic Cablevision Inc, 2669 Kilihau St, Honolulu HI 96813, 808-836-2888.

WANTED: 16 & 35mm telecine projectors; Eastman, RCA, Brenkert, GPL, Norelco. FOR SALE: RCA TK-42 color cameras, two RCA TR-3, one RCA TR-4, one RCA switcher, two RCA effects generators, one Eidaphor TV projector. Priced to sell. International Cinema Equipment Co., 6750 N.E. 4th Court, Miami, FL 33138 - 305-765-0699

TP-11 Multiplexer, no cameras or projectors. Key Code 1-49A.

Selectroslide Mod 322 TV slide projector, excel. Key Code 12-53.

Athena 4000 16mm telecine projector, factory refurbished, with lens. Key Code 11-63.

Kodak VP-X Super 8 Film Videoplayer for use with external sync. New cond., excellent working order. Key Code 11-7.

Eatman TVM100A super-8mm projector, like new, less than 50 hrs use, with lens. Key Code 11-63.

B&H model CDVM 16mm proj. w/remote control stand. Key Code 11-3.

Houston Fearless Color Film Processor. Key Code 10-14.

Eastman 250 TV 16mm projector, optical and magnetic sound, excellent condition. Key Code 10-38.

## TRANSCOM CORP.

Fine Used AM & FM Transmitters and Also New Equipment  
Exclusively represented in the Philippines by:

Allied Broadcasting Center Inc,  
Ste 301, Legaspi Towers 200  
Paseo de Roxas, Metro Manila

Call or Write for ALL Your Needs!

PO Box 26744, Elkins Park PA 19117, 215-379-6585

Circle 153 on Action-gram

In Mexico call Guarantee Radio  
512-723-3331

In the U.S. call 800-336-3045  
For any Key Code Names and Addresses.

In Canada call United Video  
613-741-5554

# The Exchange The Exchange The Exchange

## TV FILM...WTS...CONTD.

Lenses (TV), 35, 50, 75, 80, 90, 135, 200, 215mm (20 total), also 2 Varotal V40-400mm zoom extenders, etc. Make offer. Will also swap for FM TX 1-3 KW range, stereo console, freq mon, (FM) old automation or other radio goodies. Key Code 11-29.

### Want To Buy

RCA TP7A 35mm slide projector lens, 9" fixed focal length. Key Code 11-3.

16mm film projectors (2) Bell & Howell 614 EMVS, and two RCA slide projectors. Key Code 11-36.

## VIDEO PRODUCTION EQUIP.

### Want To Sell

Vital #PA-1 Pulse Distribution Amplifier w/power supply & rack, \$220. R Smith, Ohio Univ, 1425 Newark Rd, Zanesville OH 43701. 614-453-0762.

RCA TA-9 stabilizing amplifier, tube type, color proc amp with 280V supply. Key Code 1-44.

Central Dynamics, video proc amp, model VA2083, very gd cond. Key Code 1-81.

Two Versatile fully tested EFP Vans. One contains VR2000. Other 3/4" cassette equipped. D. Castellano, Capitol Broadcast Exchange, 3469 W Benjamin Holt Dr, Stockton CA 95207. 209-957-1761.

TV Production Trucks (2), 40' truck, 3 Ampex BCC-1 Plumbicon cameras, RCA TR600 quad, American Data 558-3 switcher (quad split, rotary, soft wipes), 20 ch audio board, 24' truck, 2 Ikegami cameras, RCA TR61 quad, 12 ch audio, 3/4" 3800 Sony w/Microtime TBC, built-in generator. Key Code 12-52.

Telemation video test generators, group of 3 w/rack mount, TMT-101, 102, 103, Stairstep/Sin Squared/Window/Multiburst, gd cond. Key Code 12-23.

## WANT TO BUY

Sony 3/4" Recorders/Players,  
Film Chain Equipment  
and Color Monitors.

Ronald Phillips, P.O. Box 19149  
Kansas City, Mo. 64141 816-221-2720

## AVAILABLE FROM STOCK!

| Conrac |      | Tektronix |      |
|--------|------|-----------|------|
| Color  | B&W  |           |      |
| 6100   | SNA  | 520A      | 1480 |
| 5700   | ENA  | 602       | 1420 |
| 5300   | 2133 | 604       | 528  |
| 5200   |      |           |      |

Rack Hangers also in Stock  
Factory Cartons and Factory Warranty

Call for a quote on your systems needs.

## Broadcast Systems, Inc.

Cary Fitch Don Forbes  
8222 Jamestown Drive, A-103  
Austin, Texas 78758

800 531-5232

Texas 512 836-6014

Circle 110 on Action-gram

Telemation TSG-3000-GL color sync generator w/manual, built-in bar dot & blackburst generators & digital genlock. Key Code 12-23.

Automation Techniques, Inc. RAIM-1000 time base corrector, recently recalibrated by factory. Inderwiesen Assoc., Box 7791, Orlando FL 32804. 305-295-3034.

Advent Corp. 1000A, VideoBeam TV color projection unit with self-supporting 7' screen. Low hours and new screen. \$2395. Inderwiesen Assoc., Box 7791, Orlando FL 32804. 305-295-3034.

Vital PA-1 pulse distribution amplifier with power supply and rack, new. Key Code 11-21.

Complete color (3-V) studio package, including cameras, lights, switcher, audio, etc. Key Code 11-64.

Edutron CCD-1H NTSC time base corrector. Brand new, full warranty. Key Code 11-36.

Advent 7' projection; TV videobeam-1000. Now in use. Key Code 11-37.

RCA TO-4 TV waveform monitor, very clean. Key Code 11-47.

Sony remote RM410 never used. Sony tuner timer TT100 never used. Sony 4pc CCJ5 cable, 4pc CCJ10 32'. Key Code 11-44.

Microtime 1600 TBC w/Imag-Ex, new, warranty. Key Code 11-63.

Conrac CYB-17, 17" color monitors (2), make offer. Key Code 11-75.

Sony JB-2 never used. Character generator Video Data Systems T1000A used 20 hrs, mint. Key Code 11-44.

Video production equipment, complete color package w/Hitachi FP-1500 color camera, w/CCU, 50' cable, color bar generator, Panasonic 3/4" VCR model NV-2100, also Panasonic pb-only cassette, Davis & Sanford cradle head tripod w/dolly, RAIM-1000 time base corrector, 20 hrs Scotch 60 min cassettes w/shipping cases. Equip. two yrs. old. Key Code 11-53.

RCA TG 25-TA 25 special effects gen. Generates over 100 patterns. Make offer. Key Code 11-75.

Leitch VSS-160N/CSC-165N source synchronizer/color sync. comparator. Will synchronize remote source by dial-up phone line among other things. Key Code 11-10.

Panasonic chroma key generator AS-2000, used 5 hrs, mint. Key Code 11-44.

### Want To Buy

Video DA's (complete unit). Key Code 11-50.

## VIDEO TAPE RECORDERS

### Want To Sell

JVC CR6060U 3/4" videocassette recorder, \$700. Also Sony TT-300 video tuner-timer, \$200. Carleton Sarver, 256 West 88th St, New York NY 10024. 212-873-2953.

Sony 2600, mint cond. Key Code 1-67A.

Ampex VR-5000 1" Helical, new heads, low hrs, all Ampex mods incorporated, gd. cond. Key Code 1-64.

Sony 2860 VCR 3/4" U-matic (3) modified for Convergence editing system, like new cond, will sell individually or all three. Key Code 1-10F.

Eigen Video Disc, excel performance, Chroma III comp. color recorder/reproducer, 20-sec. capacity, forward or reverse, slow motion, freeze frame, CVS digital TBC, never used. Asking \$33,000 for immediate sale. K. Blair Benson, Video Corp of America, 231 E. 55th St, New York NY 10022. 212-355-1600, ext 292.

IVC series 800 one inch color video tape recorder w/slow-motion and stop-frame, pack mounting configuration. Key Code 1-73F.

JVC PV-4800U, 1/2" R to R color recorder, slo-mo, audio dub, 5" reel w/case battery, charger, PWR supply like new. Key Code 1-44.

Allen Mod/Demod chassis, hi band model 1124 SW like new. Key Code 1-44.

Allen 1240/1241 channel switcher/equalizer like new. Key Code 1-44.

IVC 800 (2) not working but repairable and in gd cond. Key Code 1-15.

Sony 1000 VCR 3/4" U-matic player. Key Code 1-10D.

Ampex 5100's (2), 1-6,000, 2-7,000's, 1" VTR's. Will trade for 3/4" or 1" color VTR Editor, TBC, etc. Key Code 1-3.

Panasonic U-matic complete editing outfit w/NV9200, NV9500, NVA950, used, gd cond., \$5000. SoundDesign, Box 921, Beverly Hills CA 90213. 213-276-2726.

JVC CR-6300U 3/4" recorder, low hrs. Key Code 1-16A.

Sony 1200 VCR 3/4" U-matic player. Key Code 1-10E.

Sony 2600 3/4" U-matic recorder players. Key Code 1-10A.

IVC-800 color VTR's (2) not working, both repairable, one like new, w/manual. Key Code 12-48.

Sanyo portable video cassette recorder w/camera, monitor/TV, cords and rechargeable Ni-Cad Battery, w/AC power supply/charger. High resolution electronic viewfinder on camera, play back on view finder, has built in mic with instructions, will swap for good color TV camera or Ampex 351 stereo 2 trk audio recorder. Key Code 12-9.

Panasonic NV3120 reel to reel video tape (color) in like new cond. Key Code 12-21.

NEC 8700, (2) 3/4" direct drive players, new, full warranty. Key Code 12-34.

Sony 1" EU320 (3), CLP-1B (2), CLP-1A (1), need alignment, \$1000 for the lot. Dan Mulally, KUMV-TV, Box 1287, Williston ND 58801, 701-875-4311.

Panasonic (3) NV-9100 player only, new, full warranty. Key Code 12-34.

Ampex VR1000 transport, ideal for parts or for multi-trk audio recorder. Key Code 12-55.

JVC 6300U demo, w/remote control, mint cond, w/warranty card. Key Code 12-28.

Panasonic (4) NV-9200A direct drive recorder, new, full warranty. Key Code 12-34.

Ampex Mark III video heads, 2 ten mil, 3 five mil. Key Code 12-55.

Sony VO-1600 3/4" U-matic, very gd cond, used as a home machine, complete w/excel tape library, make offer. Key Code 12-29.

Sony VP-1200, 3/4" U-matic cassette players w/automatic skew control (2). Good condition. Inderwiesen Assoc., Box 7791, Orlando FL 32804. 305-295-3034.

Jatex VSEC 42T editing control unit, brand new, full warranty. Key Code 11-36.

JVC 6300-U, as new w/warranty car remote control unit. Key Code 11-37.

JVC CR8300 3/4 U-matic VTR, 2 pc used, only 40 hrs, brand new in original boxes, sell individually or all two. Key Code 11-44.

Norgren compressed air line dryer, 5 CFM, good condition. Key Code 11-3.

Minicom dropout profile recorder. Key Code 11-10.

JVC RM83U 3/4 U-matic editing for use w/ JVC CR8300 3/4 U-matic VTR, brand new used 20 hrs. Key Code 11-44.

TRI EA-5 edit controller interfaced to 1/2" 8650 at present. Key Code 11-71.

Envirozone II air filtering systems (3), excel cond. with manuals. Key Code 11-3.

JVC CR6060U 3/4" VCR with frame advance, RF modulator, service manual. Key Code 11-5.

Panasonic NV-8160 1/2" players, brand new, full warranty. Key Code 11-36.

IVC 900 1" VTR with TBC. Key Code 11-75.

Tape cleaner (video), manufactured by Advanced Transducer Systems, Ltd., good condition. Key Code 11-3.

Weircliffe model 8 bulk eraser w/video loader. Cleans a 2"x14" roll of tape to -85dB in 15 seconds. Key Code 11-48.

Panasonic NV9500A editing U-matic, new with factory warranty. Key Code 11-63.

Sony V02860 editing system w/RM430. Key Code 10-53.

Ampex VPR 5800 high band 1" color video-tape recorder/editor. Currently in use and excellent condition, edits both insert and assemble modes. Key Code 10-60.

IVC 870, fair condition. Will trade for Ampex 5800C 1" VTR. IVC 800's also available, will trade for 3/4" U-matic Ampex 5100. Key Code 10-1.

### Want To Buy

RM300 random access for Sony SLP-300, also Sony SLO-340 portable Beta deck. Key Code 1-4.

Sony AV-8400 or Panasonic NV-8400 used/new portable recording outfit, B & W color, also Sony 8600 or 3600 and B & W color camera. Key Code 12-21.

RCA TR3 or TR4 for spare parts, also on headwheel panel cover & doors for TR3. Key Code 12-34.

JVC 6060, or 6300, used less than 2,000 hours. Key Code 11-20.

Systematic video cassette playback equipment (VJB series) any cond. Also, any 3/4" Sony player or player/recorder model 1000 or higher. Will receipt full value for tax write-off or will pay small amount. Christian TV us only. Key Code 11-42.

Norelco N1481 video cassette recorder. Need test cassettes and test tools and jigs for this machine. Key Code 10-40.

## AVR-2 VTR's

— 1 each AVR-2, NTSC, 3395 hours logged, bought 1975, console with basic monitoring bridge and editec. No velcomp, drop-out comp or auto tracking. Mechanical tape timer.

— 1 each AVR-2, NTSC, 2072 hours logged, bought 1976, console with basic monitoring bridge and mechanical tape timer. No other options.

— 8 each Mark 15 video heads

— 190,000 feet of new 2" Ampex 175 video tape.

Will accept best reasonable offer, principals only, call or write:

BEE, Box 1238

Arlington, VA 22210

703-525-0400

In the U.S. call 800-336-3045  
For any Key Code Names and Addresses.

800-336-3045

New Listings are in *Italics*.

**Reverberation**

..... from page 10

able to accept and process transient signals without ringing or delay for limiting so that the transmitted signals will not be distorted. In addition, the electronics should have an integral wide-band, frequency response mixing amplifier so that the desired amount of reverb can be achieved in the reverb's own electronics. Input and output connections should be transformer isolated, and the unit should be extensively shielded to protect it from radio frequency interference. Many reverbs intended for recording studio applications do not meet the stringent standards required for broadcast equipment. Some engineers, due to experience with poor quality units, may think it is risky to use reverb on-line, but with a high quality unit designed for broadcast use, no problems will be encountered.

**For Example**

TRICMIX Audio Products, Inc., to insure that its Master-Room reverberation equipment will meet performance requirements necessary for broadcast and recording studio applications, developed electronic pulse testing. This test utilizes an electronically produced single cycle sine wave, generally referred to as a pulse. Pulse testing, in a manner similar to time domain reflectometry used in tuning transmission lines, readily reveals the performance capabilities of a reverb. Most importantly, it reveals how well a reverb can handle a transient signal. As previously mentioned, this is of vital importance to the broadcaster. Secondly, after the pulse enters the chamber, all that remains is the tail of the reverb. Therefore, the decay characteristics of the actual sound of the reverb can be easily analyzed without any masking effects. Lastly, this type of testing, because of its stringent nature, will reveal any unwanted side-effects, such as the well-known ringing, twang, flutter, and ringing that are common to many reverbs. The over-all performance capabilities can be quickly and easily evaluated. The torsional spring is the most popular reverberation medium. Unfortunately, low quality units have given spring reverberators a generally bad reputation. Through new technology, however, the desirable characteristics have now been eliminated. For example, the new Master-Room (XL-305) maintains an unusual and highly superior spring reverberation system. This system includes an electro-mechanical spring matrix that is digitally tuned and balanced so that all unwanted side-effects are eliminated. This unique technology allows the Master-Room units to

actually synthesize the sound of a live chamber. Other similarly priced units utilize internal equalization, direct signal bleed-through, limiting, and other methods to merely reduce these side-effects. Master-Room eliminates the undesirables through unique technology that is incorporated into the spring matrix itself.



When considering the use of

reverb, high quality spring units such as Master-Room, are an excellent cost-effective purchase. The prohibitive cost of designing and building a live chamber put it well beyond the budget of a radio station. Plate reverberation is also costly and must be maintained to achieve reverberation efficiency. Digital reverbs are still in their infancy and, even without considering their high cost, do not perform comparably with a good spring unit. Thus, the high quality spring reverbs fit effectively into most broadcast applications and budgets.

Although no one can guarantee higher ratings through the use of any particular type of signal processing, high quality reverberation can be a very beneficial addition to the signal chain in terms of increased average level and general audio enhancement. The broadcast signal is the foundation on which a radio station operates. Even with the most attractive format and most entertaining on-the-air personalities, the average listener will not find a home with a station unless the signal is clear, strong and pleasant to listen to.

**DISTRIBUTOR DIRECTORY**

The following is a listing of distributors that serve the broadcast industry and who would be glad to help you with any of your equipment needs. Contact any of them directly, or circle the appropriate number(s) on the Reader Inquiry Card and send it to IMAS today. We will forward your request to the distributors, and they will send you their literature or line cards.

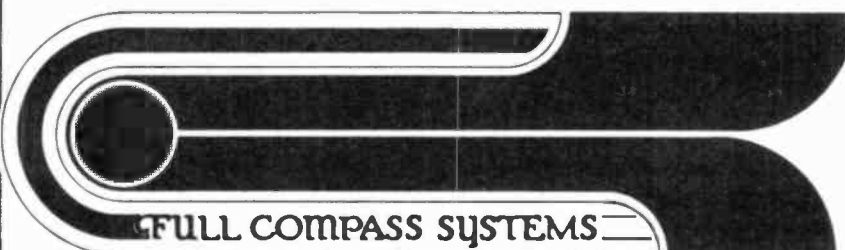
|                                                                                                                                                                                                                                                                                                                                                                                                                                                                        |                                                                                                                                                                                                                                                                                                                                                                                                                                             |                                                                                                                                                                                                                                                                                                                                                                                                                                                                                                                                                                                                                                                                           |                                                                                                                                                                                                                                                                                                                                               |
|------------------------------------------------------------------------------------------------------------------------------------------------------------------------------------------------------------------------------------------------------------------------------------------------------------------------------------------------------------------------------------------------------------------------------------------------------------------------|---------------------------------------------------------------------------------------------------------------------------------------------------------------------------------------------------------------------------------------------------------------------------------------------------------------------------------------------------------------------------------------------------------------------------------------------|---------------------------------------------------------------------------------------------------------------------------------------------------------------------------------------------------------------------------------------------------------------------------------------------------------------------------------------------------------------------------------------------------------------------------------------------------------------------------------------------------------------------------------------------------------------------------------------------------------------------------------------------------------------------------|-----------------------------------------------------------------------------------------------------------------------------------------------------------------------------------------------------------------------------------------------------------------------------------------------------------------------------------------------|
| <p><b>Audio Production Equipment Sales and Services</b></p> <ul style="list-style-type: none"> <li>• TASCAM</li> <li>• AKG</li> <li>• Tannoy</li> <li>• Ampex Tape</li> <li>• Omnicraft</li> <li>• Ivie</li> <li>• Revox</li> <li>• Technics</li> <li>• Atlas</li> <li>• DeltaLab</li> <li>• BSC</li> <li>• Beyer</li> </ul> <p>TRIAD PRODUCTIONS INC.<br/>1910 Ingersoll<br/>Des Moines, IA 50309<br/>515-243-2125</p> <p>Circle 134</p>                              | <p><b>audiotechniques...</b></p> <ul style="list-style-type: none"> <li>• MCI</li> <li>• Crown</li> <li>• Audio &amp; Design</li> <li>• dbx</li> <li>• Lexicon</li> <li>• AKG</li> <li>• Technics</li> <li>• Stanton</li> <li>• UREI</li> <li>• Dolby</li> <li>• Orban</li> <li>• Eventide</li> </ul> <p>Serving the professional audio industry.</p> <p>652 Glenbrook Road<br/>Stamford CT 06906</p> <p>800-243-2598</p> <p>Circle 135</p> | <p> <b>NORTHEAST BROADCAST LAB, INC.</b></p> <ul style="list-style-type: none"> <li>• Potomac</li> <li>• LPB</li> <li>• Inovonics</li> <li>• Tapco</li> <li>• Belar</li> <li>• Technics</li> <li>• Otari</li> <li>• ESE</li> <li>• Moseley</li> <li>• B.E.</li> <li>• Phelps Dodge</li> <li>• Cablewave</li> <li>• Q.E.I.</li> <li>• Ampro</li> <li>• QRK</li> <li>• Autogram</li> </ul> <p>Equipment Sales</p> <p>P.O. Box 1176<br/>S. Glens Falls NY 12801<br/>518-793-2181</p> <p>Circle 136</p>                                                                                  | <p><b>BROADCAST EQUIPMENT</b></p> <p><b>AUTOMATION SYSTEMS<br/>AM-FM TRANSMITTERS<br/>AUDIO EQUIPMENT<br/>ANTENNAS—TOWERS</b></p> <p> <b>Gene Bidun &amp; Associates</b><br/>BOX 861<br/>Columbia, Maryland 21044<br/>301-992-4444</p> <p>Circle 117</p> |
| <p> <b>UNITED TAPES of AMERICA</b></p> <p>Check our Prices on:</p> <ul style="list-style-type: none"> <li>• Agfa</li> <li>• AKG</li> <li>• Autogram</li> <li>• Inovonics</li> <li>• Otari</li> <li>• Revox</li> <li>• Shure</li> <li>• Telex</li> <li>• UREI</li> <li>• Ursa Major</li> </ul> <p>Box 1193, Grand Junction, CO.<br/>Call Collect: 303-242-0405</p> <p>Circle 122</p> | <p>Serving Over 2000 Stations in 19 States</p> <p><b>ELECTRONIC INDUSTRIES INC.</b></p> <p>distributors of electronic equipment and supplies</p> <p>"Call Spokeshaven Person to Person—Collect"</p> <p>19 East Irving Avenue<br/>Oshkosh, WI 54901<br/>(414) 235-8930</p> <p>Circle 120</p>                                                                                                                                                 | <p><b>T&amp;S Electronics</b></p> <p>Professional Equipment Sales</p> <ul style="list-style-type: none"> <li>• Alwa</li> <li>• AKG</li> <li>• Anvil</li> <li>• Eddor</li> <li>• ElectroVoice</li> <li>• Mike snakes</li> <li>• PML</li> <li>• Sony</li> <li>• Tapco</li> <li>• TDK</li> <li>• UREI</li> <li>• Vega</li> </ul> <p>PO Box 1846<br/>Grass Valley CA 95945<br/>916-272-3809</p> <p>Circle 139</p>                                                                                                                                                                                                                                                             | <p><b>SURCOM ASSOCIATES</b></p> <ul style="list-style-type: none"> <li>• CORNELL-DUBILIER MICA CAPACITORS</li> <li>• ITT JENNINGS VACUUM CAPACITORS</li> <li>• C.S.P. COILS &amp; ACCESSORIES</li> </ul> <p>- MANY VALUES IN STOCK -</p> <p>305 Wisconsin Ave.<br/>Oceanside, CA 92054<br/>714-722-6162</p> <p>Circle 144</p>                 |
| <p> <b>FULL COMPASS SYSTEMS</b></p> <p><b>PRO AUDIO</b></p> <p>6729 Seybold Rd.<br/>Madison WI 53719<br/>Phone: 608-271-1100<br/>TWX: 910-286-2745</p> <p>Call or write for our complete equipment list.</p> <p>Circle 101 on Action-gram</p>                                                                                                                                      |                                                                                                                                                                                                                                                                                                                                                                                                                                             | <ul style="list-style-type: none"> <li>• AKG</li> <li>• Allison Research</li> <li>• Ampex</li> <li>• Atlas</li> <li>• Audio Technica</li> <li>• Beckman</li> <li>• Beyer</li> <li>• Calrec</li> <li>• Clear-Com</li> <li>• Clone-Tone</li> <li>• dbx</li> <li>• Delta Labs</li> <li>• Eddor</li> <li>• ElectroVoice</li> <li>• Eventide</li> <li>• Inovonics</li> <li>• JVC</li> <li>• Lexicon</li> <li>• Neutrik</li> <li>• Orange County</li> <li>• Orban</li> <li>• Otari</li> <li>• Pro-Tec</li> <li>• Sennheiser</li> <li>• Shure</li> <li>• Sony</li> <li>• Strand</li> <li>• Tapco</li> <li>• Technics</li> <li>• Telex</li> <li>• UREI</li> <li>• Vega</li> </ul> |                                                                                                                                                                                                                                                                                                                                               |

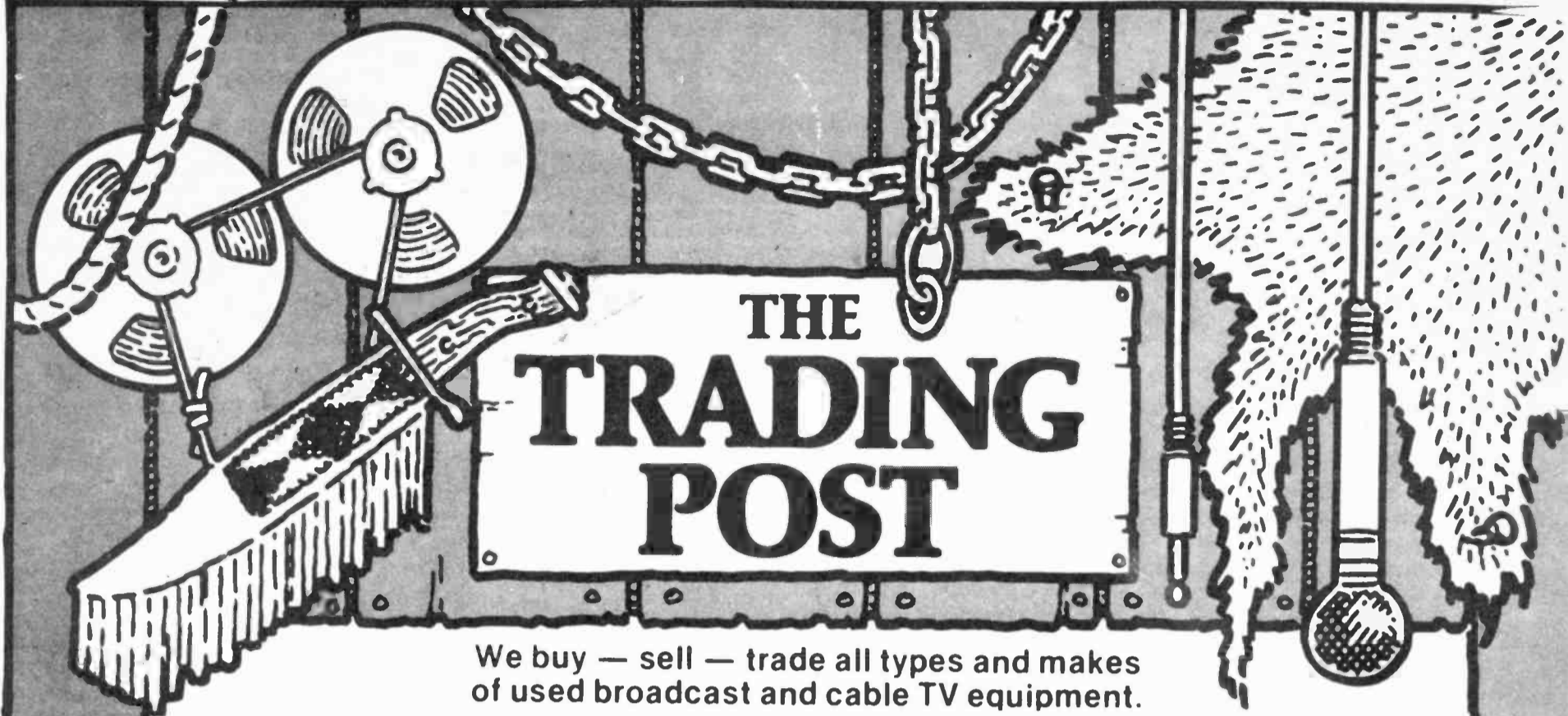

We buy — sell — trade all types and makes of used broadcast and cable TV equipment.

... WANT TO SELL ...

Danscoll TSP-101 processing amplifiers (excellent condition).

Quick set 5230 heads and 5450 pedestals (2). Excellent condition.

3/4" editing system consists of 2 Sony VO-2850's and one TRI EA-3 in excellent condition. Asking \$10,000.

3/4" editing systems consists of 1 Sony VO-2800, 1 Sony VO-2850 and TRI EA-3 Editor. Excellent condition, less than 100 hrs. of use. Asking \$11,000.

2 TRI PPC-1 portable production console c/w 3 colour monitors, 6 input video switcher, audio board and power supply to power portable camera. Excellent condition, asking \$7,000 ea.

G.E. TTC-95 Channel 5 XMitter 1961 Vintage retrofitted in 1967 and colorized.

Ampex 352-1's, 1/4" playback tape decks w/solid state electronics. Good condition.

Trenka Conversion 16mm sound camera. Excellent condition.

LDH-1 cameras (3), complete w/10:1 zoom lens, viewfinder & 100' cable.

Tektronix 149 test signal generator.

Matched sets of 2/3" Plumbicon tubes.

The above listed equipment is only an example of what we have available..Give us a call, we probably have what you're looking for.

... WANT TO BUY ...

Tektronix 528 waveform monitors, 520 Vectorscopes, 1420 Vectorscopes and Tektronix or Leitch Video test equipment.

This publication is distributed in Canada exclusively by United Video Ltd. All equipment listed herein is available through us.

Call For Details (613) 741-5554

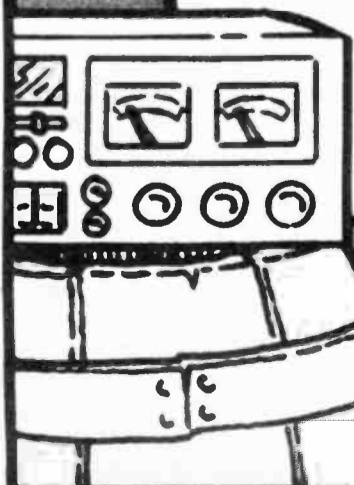

 **UNITED VIDEO LTD.**  
 1485 Triole Street  
 Ottawa K1B 3S4 Canada

