



Audi B5 A4/S4 C5 A6 - VW B5 Passat
Complete Front Control Arm Kit
Installation Instructions



Proper service and repair procedures are vital to the safe, reliable operation of all motor vehicles as well as the personal safety of those performing the repairs. Standard safety procedures and precautions (including use of safety goggles and proper tools and equipment) should be followed at all times to eliminate the possibility of personal injury or improper service which could damage the vehicle or compromise its safety.

INTRODUCTION

VW/Audi Front Control Arm Kits

The multi-link front suspension on an Audi B5/C5 or a VW B5 Passat is a fantastically engineered system that offers superior handling characteristics and provides an excellent ride. Unfortunately the components in these systems wear rapidly, causing squeaks, clunks, and rattles, and eventually cause loose and sloppy steering. The ball joints are the most common wear point, and they are built into the upper and lower links, more commonly known as the control arms, so in order to replace them you must replace the complete link. Due to the complexity of this suspension and the nature of all the components to wear out at the same time, the most efficient, and most common approach is to install a complete control arm kit, and in effect, refresh the entire front suspension. At ECS Tuning, we offer a number of complete kits that include not only all eight front suspension links (control arms), but also new sway bar links, outer tie rod ends, and a complete kit of replacement fasteners. It is critical to replace these fasteners since many of them are torque to yield bolts, and many of them can be damaged during removal.

ECS Difficulty Gauge

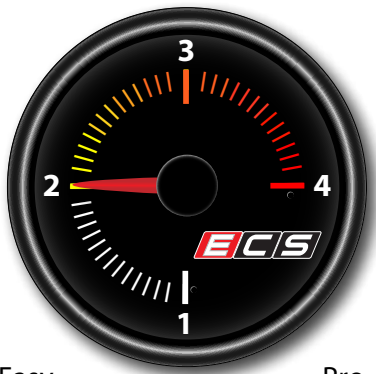

1 - Easy Pro - 4
2 - Moderate Advanced - 3

How long does it take? An experienced technician will have the better of a day into the job, so if you're doing it at home, plan it for a weekend project. It's best to review these instructions first so you are familiar with the difficult parts of the job and can make sure you have all of the proper equipment. Also, don't forget that you'll need an alignment immediately afterwards, so be sure and schedule one with your local shop.

As you'll see on the required tool list, you'll be going to the tool box a lot. Most likely, especially if the suspension has not been apart in a while, you'll encounter some rusty and stuck bolts, and you'll have to heat things up with a torch in order to remove them, so be prepared!

Thank you for looking to ECS Tuning for all your performance and repair needs. We appreciate your business!

TABLE OF CONTENTS

Kit Contents.....	pg.4
Required Tools and Equipment.....	pg.5
Shop Supplies and Materials.....	pg.6
Installation and Safety Information.....	pg.7
Component Location Overview.....	pg.8
Control Arm Kit Installation.....	pg.10
Torquing Tips.....	pg.39
Torque Specifications.....	pg.40
Schwaben Tools.....	pg.41

KIT CONTENTS**ES#2609119**

Some kits vary slightly in what they contain, primarily in the inclusion or exclusion of outer tie rod ends or sway bar links. The kit we've decided to install, pictured here, is complete with all eight front suspension links (control arms), two new outer tie rod ends, two sway bar links, and all replacement fasteners.

REQUIRED TOOLS

Note: The tools required for each step will be listed by the step number throughout these instructions.

Standard Automotive Tools

- **Protecta-Sockets (for lug nuts)** [ES#2221243](#)
- **3/8" Drive Ratchet** [ES#2765902](#)
- **3/8" Drive Torque Wrench** [ES#2221245](#)
- **3/8" Drive Deep and Shallow Sockets** [ES#2763772](#)
- **3/8" Drive Extensions** [ES#2804822](#)
- **Hydraulic Floor Jack** [ES#240941](#)
- Torx Drivers and Sockets [ES#11417/8](#)
- **1/2" Drive Deep and Shallow Sockets** [ES#2839106](#)
- **1/2" Drive Ratchet**
- **1/2" Drive Extensions**
- **1/2" Drive Torque Wrench** [ES#2221244](#)
- 1/2" Drive Breaker Bar [ES#2776653](#)
- File Set
- Air Nozzle/Blow Gun
- Bench Mounted Vise
- Crows Foot Wrenches
- Hook and Pick Tool Set [ES#2778980](#)

Required For This Install

- 1/4" Drive Ratchet [ES#2823235](#)
- 1/4" Drive Deep and Shallow Sockets [ES#2823235](#)
- 1/4" Drive Extensions [ES#2823235](#)
- 1/4" Drive Torque Wrench
- **Plier and Cutter Set** [ES#2804496](#)
- **Flat and Phillips Screwdrivers** [ES#2225921](#)
- Jack Stands [ES#2763355](#)
- **Ball Pein Hammers**
- **Pry Bar Set** [ES#1899378](#)
- Electric/Cordless Drill
- Wire Strippers/Crimpers
- Adjustable (Crescent) Type Wrenches
- Drill Bits
- **Punch and Chisel Set**
- Hex Bit (Allen) Wrenches and Sockets [ES#11420](#)
- Thread Repair Tools [ES#1306824](#)
- **Open/Boxed End Wrench Set** [ES#2765907](#)

Available On Our Website

Specialty Tools

- **Oxy/Acetylene Torch**
- **Digital Caliper**

- **Ball Joint Separator** [ES#2795140](#)
- **Separator Fork** [ES#2748927](#)

SHOP SUPPLIES AND MATERIALS

Standard Shop Supply Recommendations: We recommend that you have a standard inventory of automotive shop supplies before beginning this or any automotive repair procedure. The following list outlines the basic shop supplies that we like to keep on hand. Shop supplies with a hyperlink are available on our website.

- Hand Cleaner/Degreaser - [Click Here](#)
- Pig Mats - for protecting your garage floor and work area from spills and stains - [Click Here](#)
- Spray detailer - for rapid cleaning of anything that comes into contact with your paint such as brake fluid - [Click Here](#)
- Micro Fiber Towels - for cleaning the paint on your car - [Click Here](#)
- Latex Gloves - for the extra oily and dirty jobs - [Click Here](#)
- Medium and High Strength Loctite Thread lock compound - to prevent bolts from backing out - [Click Here](#)
- Anti-Seize Compound - to prevent seizing, galling, and corrosion of fasteners - [Click Here](#)
- Aerosol Brake/Parts Cleaner - for cleaning and degreasing parts
- Shop Rags - used for wiping hands, tools, and parts
- Penetrating oil - for helping to free rusted or stuck bolts and nuts
- Mechanics wire - for securing components out of the way
- Silicone spray lube - for rubber components such as exhaust hangers
- Paint Marker - for marking installation positions or bolts during a torquing sequence
- Plastic Wire Ties/Zip Ties - for routing and securing wiring harnesses or vacuum hoses
- Electrical tape - for wrapping wiring harnesses or temporary securing of small components

INSTALLATION NOTES

- **RH** refers to the *passenger side* of the vehicle.
- **LH** refers to the *driver side* of the vehicle.
- Always use the proper torque specifications.
- If applicable to this installation, torque specifications will be listed throughout the document and at the end as well.
- Please read all of these instructions and familiarize yourself with the complete process **BEFORE** you begin.

PREPARATION AND SAFETY INFORMATION

ECS Tuning cares about your health and safety. Please read the following safety information. This information pertains to automotive service in general, and while it may not pertain to every job you do, please remember and share these important safety tips.

- Park your car in a safe, well lit, level area.
- Shut the engine off and remove the key from the ignition switch.
- Make sure any remote start devices are properly disabled.
- **ALWAYS** wear safety glasses.
- Make sure the parking brake is applied until the vehicle is safely lifted and supported.
- If using an automotive lift, be sure and utilize the factory specified lift points. Lifting a vehicle in an incorrect location can cause damage to the suspension/running gear.
- When lifting a vehicle using a jack, always utilize the factory specified lift points. Lifting a vehicle in an incorrect location can cause damage to the suspension/running gear. **ALWAYS** support the vehicle with jack stands.
- **ALWAYS** read and follow all safety information and warnings for the equipment you are using.



Never get underneath a vehicle that is supported only by a jack. Always make sure that the vehicle is securely supported on jack stands.

COMPONENT LOCATION OVERVIEW

Upper Suspension

Passenger side shown

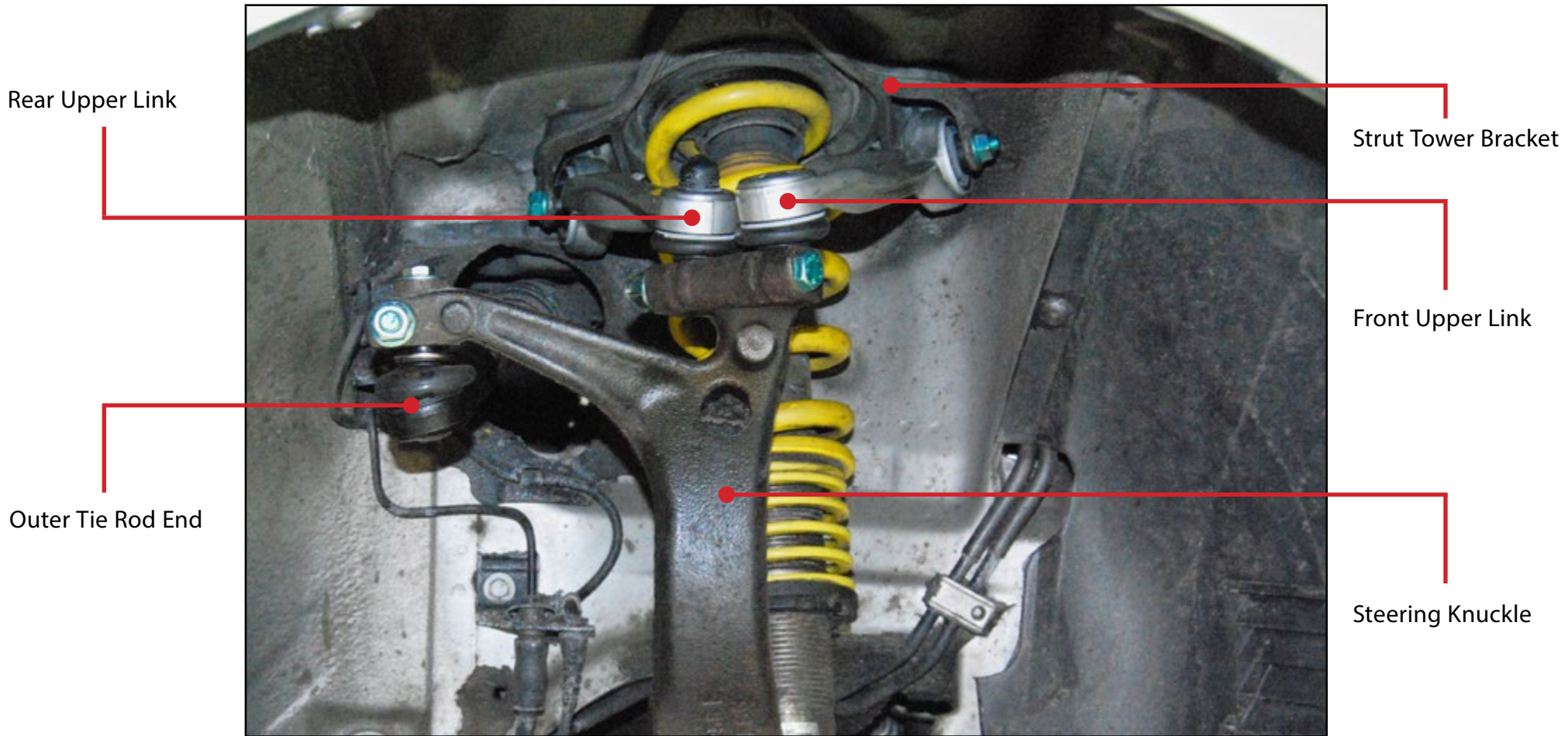

COMPONENT LOCATION OVERVIEW

Lower Suspension

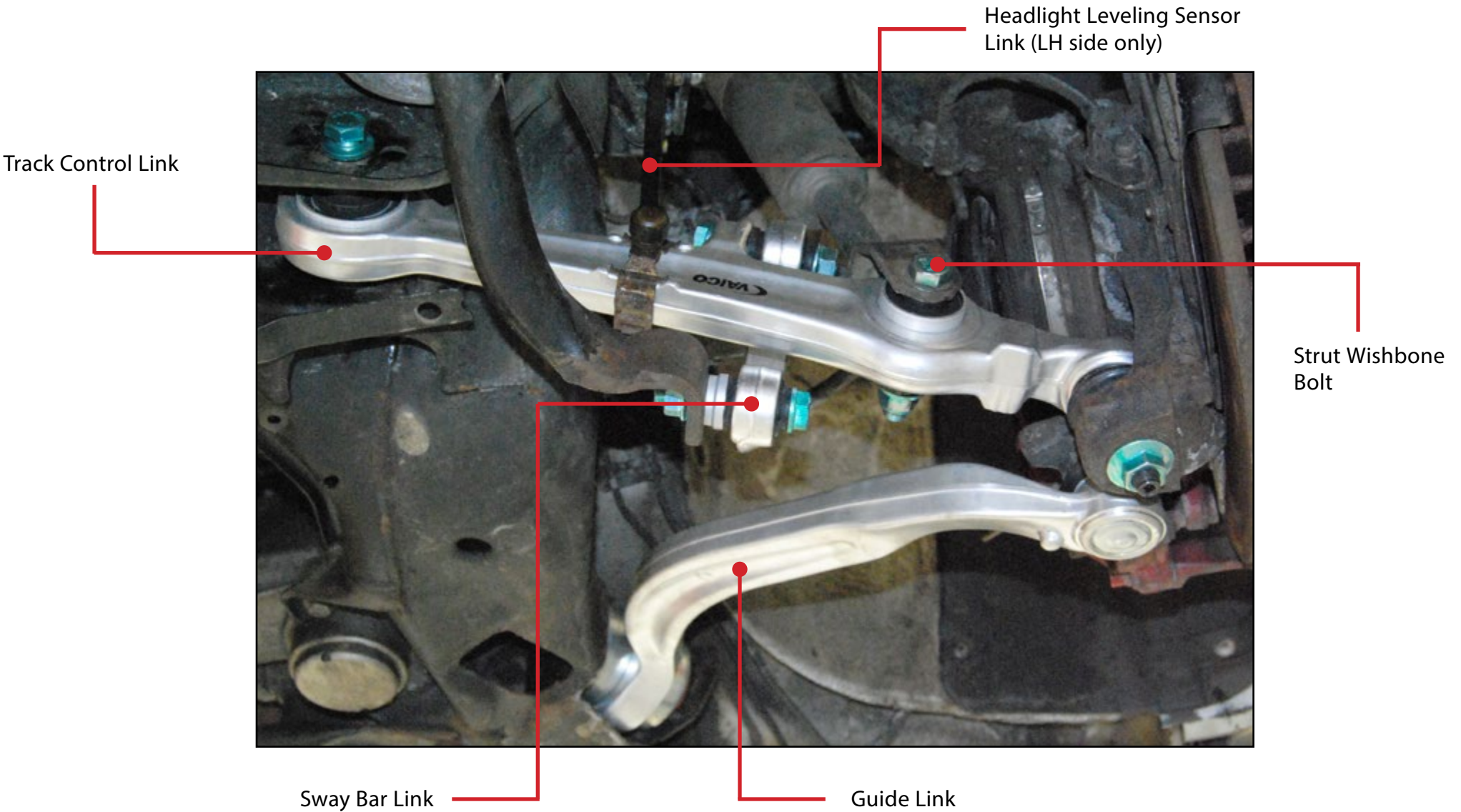

CONTROL ARM KIT INSTALLATION

Step 1: 17mm Protecta-Socket

Safely raise and support the vehicle and remove the front wheels.

Also remove the lower insulation panel or skid plate, whichever you have installed.



Step 2: 10mm Socket, Ratchet, 10mm Open End Wrench

On the LH (drivers) side only, disconnect the headlight leveling sensor link from the headlight leveling actuator arm. Hold the link stud with an open end wrench to keep it from turning while removing the nut.



For ease of writing, we generally describe the installation on one side only. You may choose to install one side at a time or you can perform each step on both sides as you go.



CONTROL ARM KIT INSTALLATION

Step 3: 13mm Wrench

Remove the outer tie rod end center bolt.



Even if your kit does not include outer tie rod ends, removing them from the steering knuckle allows free movement of the front suspension which provides a much easier installation of the upper and lower links (control arms).

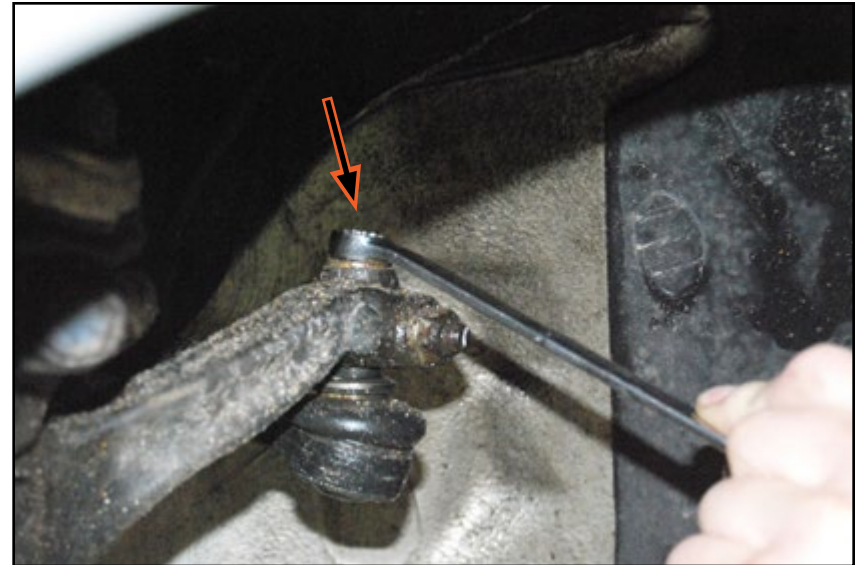

Step 4: 16mm Socket, Ratchet

Remove the nut from the outer tie rod end pinch bolt.



CONTROL ARM KIT INSTALLATION

Step 5: Punch, Hammer

Drive the tie rod end pinch bolt out of the steering knuckle.



It is very common for these to be rusted in place. You may have to heat the bolt and steering knuckle with a torch in order to remove it. **Be careful** not to mushroom the end of this bolt. These are not included with the kit and must be re-used.

Be aware that **too much heat** on the bolt and steering knuckle will transfer into the tie rod end and destroy it, so if you are not replacing it use caution to avoid this damage.



Step 6:

Once you have removed the pinch bolt, be sure and clean the bolt and threads using a wire brush or wire wheel, in order to remove all the rust and scale.



CONTROL ARM KIT INSTALLATION

Step 7: Punch, Hammer

Drive the tie rod end out of the steering knuckle using a short punch or a socket that is approximately the size of the tie rod end stud.

Thoroughly clean the bore in the steering knuckle using a wire brush or emery cloth.



Step 8: 16mm Wrench, Socket, Ratchet

Remove the sway bar end link bolts and remove the link.



Even if your kit does not include new sway bar end links, removing them allows for greater suspension movement and easier replacement of the upper and lower links.

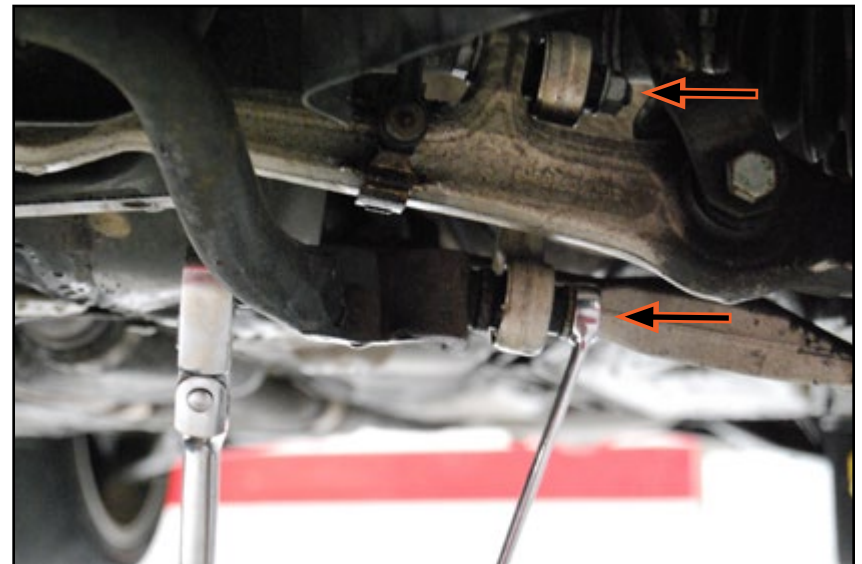

CONTROL ARM KIT INSTALLATION

Step 9: 18mm Socket, Ratchet, 18mm Wrench

Remove the bolt securing the strut wishbone to the track control link.



Step 10: 18mm Socket, Ratchet

Remove the track control link/ball joint nut at the steering knuckle.



CONTROL ARM KIT INSTALLATION

Step 11: Jack Post - or - Floor Jack

Support the weight of the front suspension/steering knuckle underneath the lower guide link on the side you are working on, using a floor jack or jack post. This will prevent the suspension from dropping suddenly when you remove the front track control link.



Step 12: 18mm Wrenches

Remove the track control link inner bolt.



CONTROL ARM KIT INSTALLATION

Step 13: Ball Joint Separator

Press the track control link ball joint out of the steering knuckle.



Due to limited space, a ball joint separator like the one shown works best for this application, however a traditional fork style of separator may be used as well.



Step 14:

With the track control link disconnected at both ends, carefully remove it from the car. Be careful not to damage the outer CV boot, and on the LH (drivers) side as shown here, be careful not to damage the headlight leveling sensor link.



CONTROL ARM KIT INSTALLATION

Step 15:

For the LH side only: Clamp the track control link in a vise, then liberally spray a penetrating lubricant onto the end of the headlight leveling sensor link and work the link back and forth until it moves freely and can be easily pulled off of the ball stud.



It is very common for these links to be seized onto the ball stud. To prevent damage to the link, be sure and work lubrication into them before attempting to pull them off.



Step 16: Flat Blade Screwdriver

For the LH side only: Release the clip holding the ball stud to the track control link, then remove the ball stud and reinstall it onto the new LH track control link. Push the headlight leveling sensor link back onto the ball stud.



CONTROL ARM KIT INSTALLATION

Step 17: 18mm Socket, Torque Wrench

Install the new track control link into the car, using a new ball joint nut and new inner bolt and nut, and following the guidelines below:

- Do not tighten the inner bolt and nut at this time.
- Torque the ball joint nut to 100 Nm (74 Ft-lbs).
- Do not install the strut wishbone bolt at this time.
- Do not reinstall the headlight leveling sensor link at this time.



To prevent abnormal and premature wear, all suspension bushing fasteners must be tightened with the vehicle at ride height. During this installation, all bushing fasteners will be left loose, then tightened all at the same time as a final step.

Step 18: 18mm Wrench

First, lower the jack post (or floor jack) and move it underneath the track control link on the side you are working on.

Next, remove the outer guide link/ball joint nut at the steering knuckle.



CONTROL ARM KIT INSTALLATION

Step 19: Ball Joint Fork - or - Ball Pein Hammer

Separate the guide link/ball joint from the steering knuckle. This joint is a little more difficult to access and may require one of the following methods for removal:

- A ball joint separator fork can be used
- Strike the steering knuckle sharply with a heavy ball pein hammer as shown in the picture. This method generally only requires a few good hits at the most and the tapered stud of the ball joint will release from the steering knuckle.

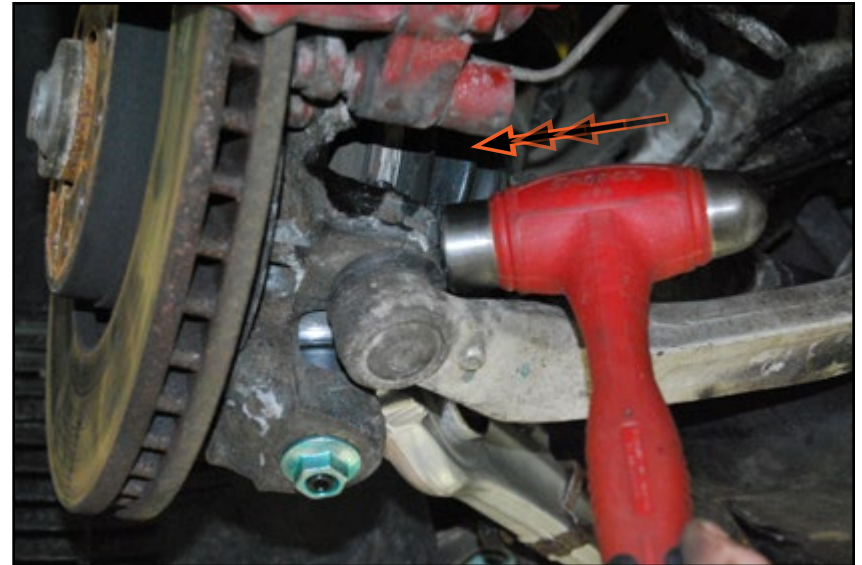

Step 20: 13mm Socket, Ratchet

Remove the two rear subframe support plate bolts.

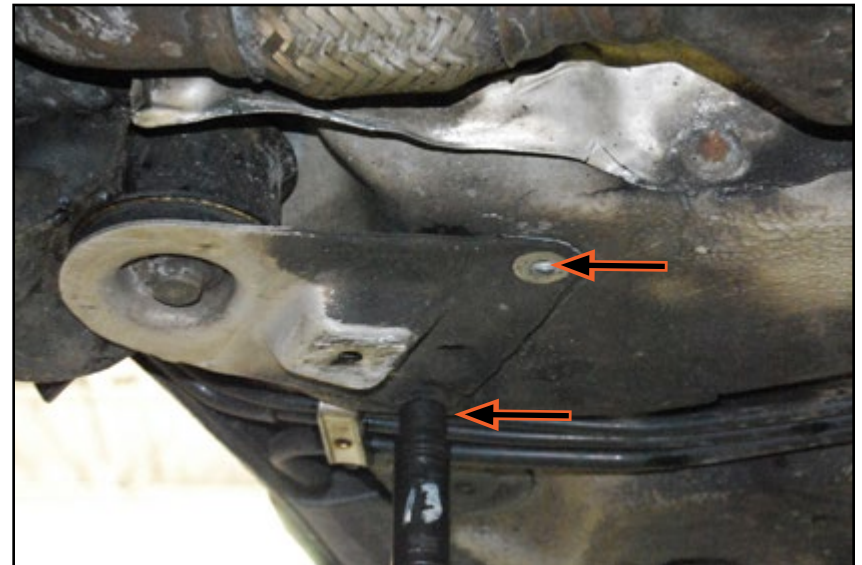

CONTROL ARM KIT INSTALLATION

Step 21: 18mm Socket, Ratchet

Remove the rear subframe bolt and the support plate at the same time.



Step 22: 18mm Wrenches

Loosen and remove the nut on the guide link inner bolt.



CONTROL ARM KIT INSTALLATION

Step 23:

When you attempt to slide the guide link bolt straight out as shown here, it will hit the underbody of the car.

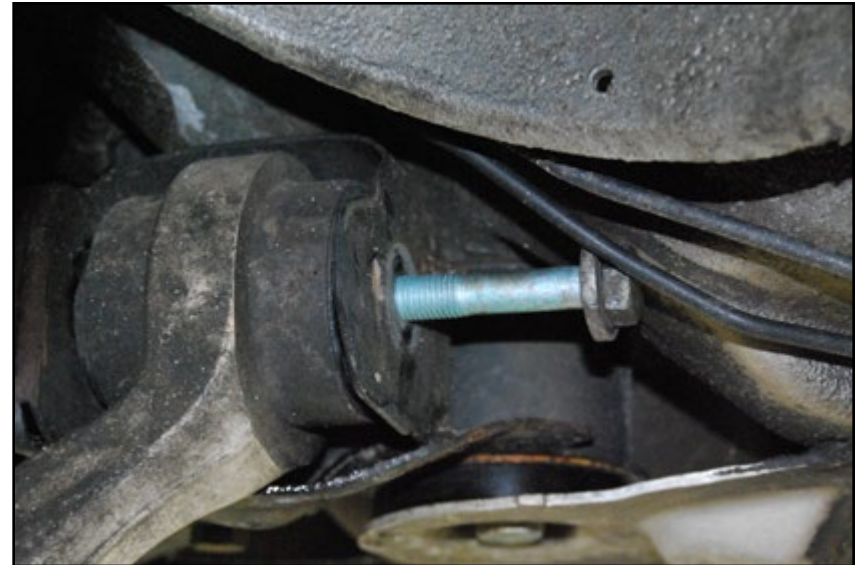

Step 24:

Pull down on the rear corner of the subframe to gain the necessary clearance, then remove the guide link bolt.

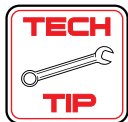

If you find that you do not have enough clearance, you may have to loosen the rear subframe bolt on the other side as well to gain additional clearance.



CONTROL ARM KIT INSTALLATION

Step 25:

Pull the guide link out of the subframe.



Step 26: 18mm Socket, Torque Wrench

Install the new guide link into place, sliding it into the subframe first, then into the steering knuckle. Use a new ball joint nut and a new inner bolt and nut, and follow the guidelines below:

- Torque the ball joint nut to 100 Nm (74 Ft-lbs).
- Do not tighten the inner bolt and nut at this time.



CONTROL ARM KIT INSTALLATION

Step 27: 18mm Socket, 13mm Socket, Torque Wrench

Install a new rear subframe bolt, the support plate, and the support plate bolts.

- Torque the rear subframe bolt to 110 Nm (81 Ft-lbs) + 90 degrees
- Torque the support plate bolts to 25 Nm (18 Ft-lbs)



Step 28: Floor Jack

Now it's time to replace the upper links (control arms). You will continue to support the suspension from underneath one of the lower links. Since we were working with the car up on a lift, we have removed the jack post, lowered the car and are now using a floor jack underneath for support.



The wishbone bolt(s), the sway bar link(s), and the tie rod end(s) will remain disconnected at this time to allow for additional suspension movement and easier installation of the upper links.



CONTROL ARM KIT INSTALLATION

Step 29: 16mm Socket, 16mm Wrench

Begin by removing the nut for the pinch bolt that secures the upper link ball joints to the steering knuckle.



This pinch bolt is normally one of the most difficult ones to remove, and will most likely require heat from an oxy-acetylene torch, as well as patience and penetrating lubricant to remove. Most kits will include replacement bolts, and these are almost always destroyed during removal.



Step 30: Punch, Ball Pein Hammer

Drive the pinch bolt out of the steering knuckle.



CONTROL ARM KIT INSTALLATION

Step 31: Punch, Ball Pein Hammer

With the pinch bolt removed, drive both ball joint studs up out of the steering knuckle.



Do not spread the slot in the steering knuckle. If necessary, lubricate the ball joint studs and work them up and down until you are able to remove them.

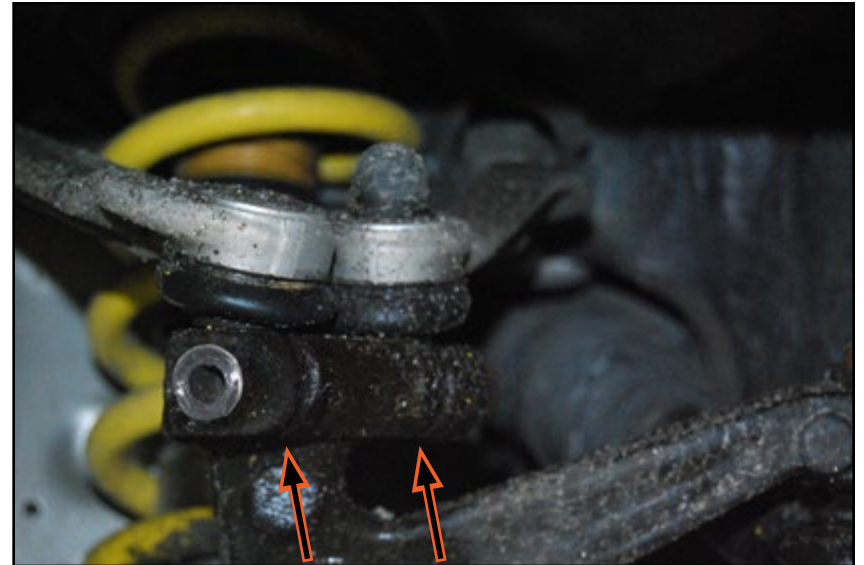

Step 32:

Using emery cloth or a wire brush, thoroughly clean all rust buildup from the ball joint stud holes in the steering knuckle. This will ensure that the new ball joint studs will slide easily into place.



CONTROL ARM KIT INSTALLATION

Step 33:

Open the hood and remove the battery cover by sliding it towards the RH (passenger) side of the car, then lifting it up off the rain tray. Note the markings on the battery cover in this picture. Normally just molded into the cover, we have highlighted them for reference. The green arrows indicate the direction in which to slide the cover for removal, the red and black indicate the positions of the positive and negative battery terminals underneath the cover.



Step 34:

Pull the cowl seal up off the lip of the cowl, then pull the rain tray forward out of the groove at the rear and remove it from the car.



CONTROL ARM KIT INSTALLATION

Step 35:

Locate the three strut tower bracket bolts on the LH (drivers) side. You will notice that the forward most bolt is slightly obstructed by the coolant reservoir.



Some vehicles may have plastic "caps" or "plugs", which you will have to remove, covering some of the bolts.



Step 36: Phillips Screwdriver

Remove the three mounting screws for the coolant reservoir and position it just off to the side to gain access to the forward bolt. There is no need to completely remove the reservoir.



CONTROL ARM KIT INSTALLATION

Step 37:

Locate the three strut tower bracket bolts on the RH (passenger) side. You will see that the forward most bolt is slightly obstructed by a wiring connector.



Some vehicles may have plastic "caps" or "plugs", which you will have to remove, covering some of the bolts.



Step 38:

Pull the wiring connector out of its mounting bracket in order to gain access to the forward bolt.



CONTROL ARM KIT INSTALLATION

Step 39: 16mm Socket, Ratchet, Extension

Make sure the suspension is properly supported from underneath, then remove the three strut tower bracket bolts on the side you are working on.

Once you have removed the bolts, lower the floor jack to allow the suspension to drop down, rotate the steering knuckle out of the way, then pull the strut/upper arm assembly down and out of the car.



Step 40: 16mm Socket, 16mm Wrench

Secure the spring/strut assembly in a vise, then remove both upper links from the upper strut tower bracket.



The upper links are different, there is a front and rear on each side. Keep them in position after removal so you can match them up correctly for installation.

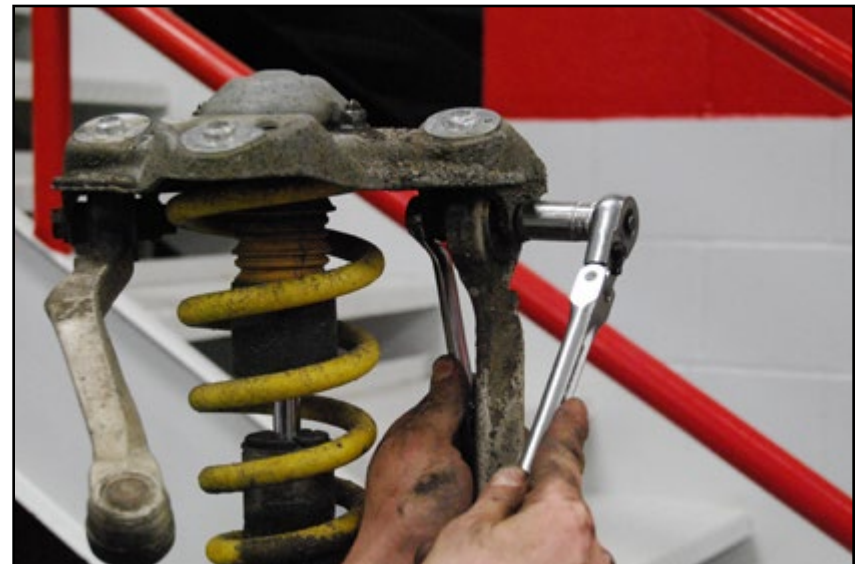

CONTROL ARM KIT INSTALLATION

Step 41: Digital Caliper or other Measuring Device

Loosely install both new links using the new bolts and nuts provided with the kit.

As shown in the picture, measure the distance between the strut tower bracket and the top edge of the upper links. The required measurement is 47mm +/- 2mm.

While holding the links in this position, snug the bolts so the links remain at this measurement.



Step 42: 16mm Socket, 16mm Wrench, Torque Wrench

Torque both upper link bolts to 50 Nm (37 Ft-lbs) + 90 degrees.



The upper link bolts are not accessible when the strut assembly is installed in the car. Installing them in this measured position simulates the ride height of the car, so in effect the bushings are tightened at ride height, eliminating premature bushing wear.



CONTROL ARM KIT INSTALLATION

Step 43:

Reinstall the strut/upper arm assembly into the car, placing the strut wishbone in place over the track control link. Raise the floor jack to support the suspension and hold the strut/upper arm assembly into place.



Step 44:

Reinstall the strut tower bracket bolts and torque them to 75 Nm (55 Ft-lbs.)

Reinstall the coolant reservoir (LH side).

Reinstall the wiring harness (RH side).

Reinstall the rain tray, cowl seal, and battery cover.



CONTROL ARM KIT INSTALLATION

Step 45:

Inspect the end of one of the ball joint studs. You will see that the center of the stud is radiused inward to a smaller diameter. This is designed to align with the hole in the steering knuckle, and when the bolt is installed it holds the ball joint stud in the correct position and prevents it from backing out.

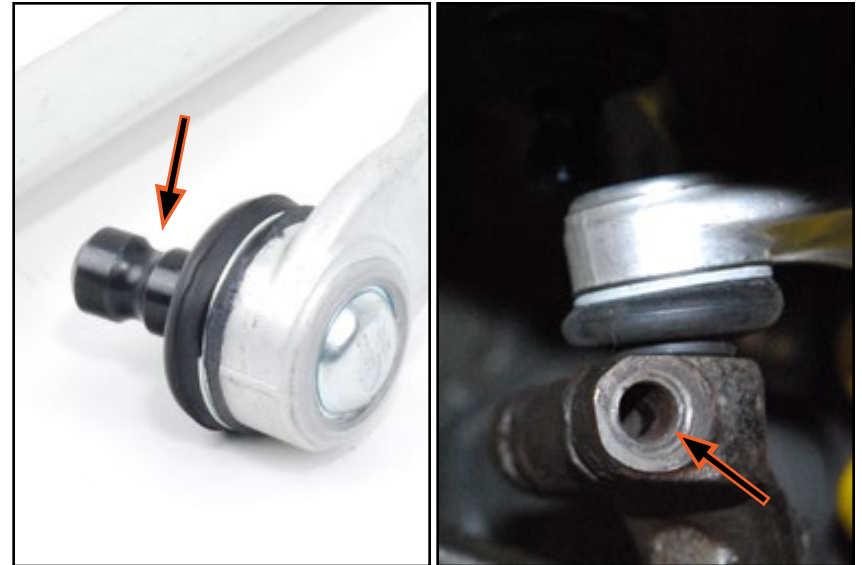

Step 46:

Pull down on the upper links and slide both ball joint studs into the steering knuckle. If the stud bores in the knuckle have been cleaned sufficiently, the studs should slide in easily.

The tension of the upper link bushings may cause the ball joint studs to slide back out, so it is easiest to install the forward joint first, slide the new pinch bolt part way into the knuckle to hold it in place, then install the rear joint and slide the bolt all the way in to hold them in place.



- Be sure to coat the shank of the bolt (not the threads) with anti-seize lubricant.
- Install these bolts with the nut located on the rear facing side of the steering knuckle.

CONTROL ARM KIT INSTALLATION

Step 47: 16mm Socket, 16mm Wrench, Torque Wrench

Hold downward pressure on the upper link ball joints so they are seated as far downward as possible, then torque the upper link pinch bolt to 40 Nm (30 Ft-lbs).



Step 48:

- Install the new lower wishbone bolt and nut, but do not tighten it at this time.
- Install the sway bar link using the new bolts and nuts that come with the kit, but do not tighten them at this time. Note that the sway bar links have a spacer built into them that is located between the link and the sway bar (arrow).
- The floor jack can be removed from supporting the suspension at this time.



CONTROL ARM KIT INSTALLATION

Step 49:

Now we're on to the tie rod ends, the final part of the job.



If you are not replacing the outer tie rod ends, skip to step 51.

You'll have to get an alignment when you're done anyhow, but it's best to take a rough measurement so you can install the new tie rod end as close as possible to the position of the old. As shown in the illustration, measure from where the outer tie rod end lock nut meets the inner tie rod to the centerline of the tie rod ball and socket. This only needs to be approximate, just to get you close, so even a tape measure will do.

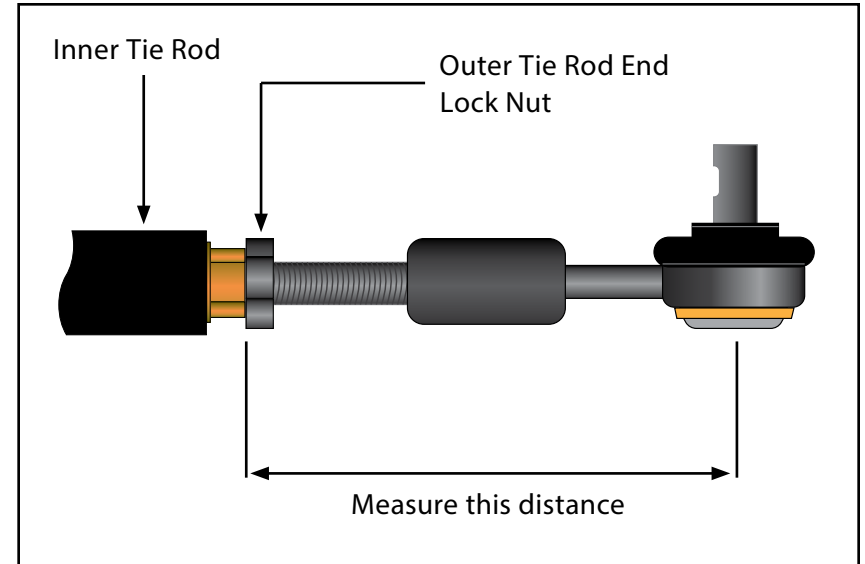

Step 50: 18mm Wrench, 22mm Wrench

Hold the inner tie rod end and loosen the lock nut on the outer tie rod end. Unthread the outer tie rod end and remove it.



This is another component that may require heat to loosen and remove.



CONTROL ARM KIT INSTALLATION

Step 51:

Thread the new outer tie rod end into the inner, using your measurement from step 49 to get it as close as possible to the original position.

Push the tie rod end stud into the steering knuckle.



Step 52: 13mm Socket, Torque Wrench

Coat the shank (not the threads) of the tie rod end pinch bolt with anti-seize lubricant, then loosely install it to hold the tie rod end in place. Do not tighten it yet, but torque the tie rod end center bolt to 7 Nm (5 Ft-lbs).



CONTROL ARM KIT INSTALLATION

Step 53: 16mm Socket, Torque Wrench

Torque the tie rod end pinch bolt to 45 Nm (33 Ft-lbs).

- Torque the outer tie rod lock nut to 100 Nm (74 Ft-lbs).



Step 54:

On the LH side only, reinstall the headlight leveling sensor link.



CONTROL ARM KIT INSTALLATION

Step 55: 19mm Protecta-Socket, Torque Wrench

You're almost finished, and it's time to wrap things up. Reinstall the front wheels and torque them to 120 Nm (88 Ft-lbs).



Step 56:

Prepare the vehicle so you can torque all of the remaining suspension bushings at ride height. There are a number of different ways to do this:

- 1)** If you have a drive on lift, this is the most convenient since you can raise the vehicle in the air and access all of the suspension components with it sitting on all four wheels.
- 2)** You can drive the vehicle up onto ramps, then access the suspension components.
- 3)** With the vehicle safely supported on a lift or jack stands, you can jack up the suspension until it reaches ride height, then torque the bolts. Ride height is easily determined when you jack up the suspension. As soon as the suspension begins to lift the body of the car, you are at ride height.



CONTROL ARM KIT INSTALLATION

Step 55:

With the vehicle at ride height, torque the remaining suspension bushings:

- Guide Link Inner Bolt..... 90 Nm (66 Ft-lbs) + 90 degrees
- Track Control Link Inner Bolt..... 90 Nm (66 Ft-lbs) + 90 degrees
- Sway Bar Link Bolts 90 Nm (66 Ft-lbs)
- Strut Wishbone Bolt 90 Nm (66 Ft-lbs)



Your Control Arm Kit Installation is Complete!

TORQUING TIPS

Torque to Yield or "Stretch" Bolts

Many bolts will have a torque specification listed in the format - xx Nm (xx Ft-lbs) + xx degrees. These bolts are torque to yield bolts, commonly referred to as "stretch" bolts. The correct procedure for torquing these bolts is:

Stage One - Torque the bolt(s) to the initial Nm or Ft-lb specification. If there is more than one, be sure to torque them in the correct sequence.

Stage Two - Tighten or "stretch" the bolt(s) the additional specified number of degrees. If there is more than one, be sure to follow the correct sequence.

Note - Some bolts may have two or more stages of torquing before the final stage of "stretching" the bolts.

When tightening more than one bolt in a specified sequence, be sure to mark each fastener with paint **immediately** after performing the final stage or "stretching" of the bolts. This will ensure that you keep track of which bolts have already been "stretched".

All Torque to Yield bolts should only be used once and should be replaced each time they are removed. If they are reused, they will not be able to achieve the proper clamping force with the specified torque.

Lubrication

Torque specifications are always listed for a dry fastener (**no** lubrication) unless specified otherwise.

Some fasteners require lubrication on the threads -or- on the contact surface while torquing. These fasteners will be listed with the specific location and type of lubrication required. Always follow manufacturers recommendations exactly.

Lubricating a fastener that is intended to be installed dry and then torquing it to factory specifications will increase the clamping force and stress on the fastener and components, which can result in damage or failure.

Do not lubricate the threads of any fastener unless it is specifically recommended by the manufacturer.

Ribbed vs. Non-Ribbed Bolts

Ribbed and Non-Ribbed bolts in the same location generally require a different torque specification.

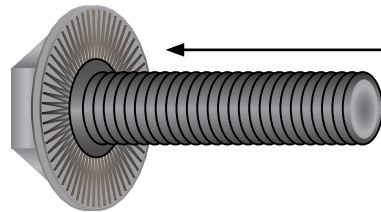

A ribbed bolt is identified by the ribs on the contact surface

A non-ribbed bolt is identified by the smooth contact surface

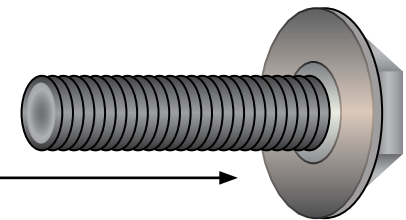

TORQUE SPECIFICATIONS

Guide Link Inner Bolt.....	90 Nm (66 Ft-lbs) + 90 degrees
Guide Link at Steering Knuckle	100 Nm (74 Ft-lbs)
Rear Subframe Bolt	110 Nm (81 Ft-lbs) + 90 degrees
Strut Wishbone Bolt	90 Nm (66 Ft-lbs)
Subframe Support Plate Bolts.....	25 Nm (18 Ft-lbs)
Sway Bar Link Bolts	90 Nm (66 Ft-lbs)
Tie Rod Center Bolt.....	7 Nm (5 Ft-lbs)
Tie Rod End Lock Nut.....	100 Nm (74 Ft-lbs)
Tie Rod End Pinch Bolt.....	45 Nm (33 Ft-lbs)
Track Control Link at Steering Knuckle.....	100 Nm (74 Ft-lbs)
Track Control Link Inner Bolt.....	90 Nm (66 Ft-lbs) + 90 degrees
Upper Link (Ball Joint) Pinch Bolt.....	40 Nm (30 Ft-lbs)
Upper Link Bolts at Strut Tower Bracket	50 Nm (37 Ft-lbs) + 90 degrees
Upper Strut Tower Bracket to Body.....	75 Nm (55 Ft-lbs)
Wheels.....	120 Nm (89 Ft-lbs)

SCHWABEN - BUILD THE ULTIMATE TOOL COLLECTION

At ECS Tuning, we carry a line of high quality Schwaben tools and equipment to help you build your ultimate tool collection. Never before has affordability and quality been so closely related. Our entire Schwaben line is subjected to strict in house testing for strength and durability. See what we have to offer and equip your garage without breaking the bank.



Your Control Arm Kit Installation is complete!



These instructions are provided as a courtesy by ECS Tuning

Proper service and repair procedures are vital to the safe, reliable operation of all motor vehicles as well as the personal safety of those performing the repairs. Standard safety procedures and precautions (including use of safety goggles and proper tools and equipment) should be followed at all times to eliminate the possibility of personal injury or improper service which could damage the vehicle or compromise its safety.

Although this material has been prepared with the intent to provide reliable information, no warranty (express or implied) is made as to its accuracy or completeness. Neither is any liability assumed for loss or damage resulting from reliance on this material. SPECIFICALLY, NO WARRANTY OF MERCHANTABILITY, FITNESS FOR A PARTICULAR PURPOSE OR ANY OTHER WARRANTY IS MADE OR TO BE IMPLIED WITH RESPECT TO THIS MATERIAL. In no event will ECS Tuning, Incorporated or its affiliates be liable for any damages, direct or indirect, consequential or compensatory, arising out of the use of this material.